

POSITION PAPER

CODEX 4255 SNA GATEWAY

Steven A. Booth
Bellevue, WA.
June 24, 1988

CONTENTS

- I. Background
 - A. Traditional Target Market - 4255
 - B. Multipoint/Multiprotocol Market Review

- II. Enter the 4255 - With A New Perspective
 - A. A Different Philosophy
 - B. IBM - The Ally Of The 4255 Solution

- III. Conclusion: Future Of The 4255 Idea
 - A. Software Modification
 - B. Training
 - C. Different Concept-Better Success

Attachment 1: Rainier Bank Applications With 4255 Concept Model

Attachment 2: IBM 3708 Application - Department of Licensing,
State of Washington

Position Paper: 4255 SNA Gateway

Introduction

This paper is being formulated because of recent awareness which we have discovered in the Seattle field sales office of a potential, exciting capability of the 4255 SNA Gateway. It appears to be a worthwhile exercise to document the market needs and history as well as the technology which has been developed to meet those needs.

I. Background

- A. Traditional Target Market - 4255: The 4255 has been marketed as a product which can integrate non-SNA devices into an SNA network. In other words, the 4255 will make non-SNA devices appear like SNA counterparts to the host. The 4255 will appear to the host as a complete implementation of a PU Type 2 cluster controller which will completely integrate into IBM's network management - i.e. Netview. The network port side of the box can operate on switched, point-to-point, or multipoint lines either half or full duplex at speeds up to 19.2 kbps.

In addition to the above hardware characteristics the 4255 is a software based product with the ability to downline load upgrades and also pass diagnostic information to IBM's Network Support Program for further analysis. The 4255 has the capability of converting either async or bisync device's datastreams to SNA with flexible IBM personalities assigned to these devices.

The 4255, as the Codex upgraded version of the 4250 NetLink product which was developed in Australia, is manufactured by Codex with development and support by Codex engineering. It is significant that in none of the literature published on the 4255 has the capability of end-to-end pass through of async or bisync protocols been mentioned or described. It is this additional, apparent capability which has renewed our excitement regarding the market potential for this product solution. To understand the impact of this capability to the market, it is valuable to briefly look at the multi-point, multi protocol market of the past 5 years.

B. Multipoint/Multi-Protocol Market Review The concept of the ability to support multiple protocols on a single multipoint circuit is not new. One of the pioneers in this field - DOELZ Networks - produced a product line capable of carrying diverse protocols on a single circuit through the use of a proprietary packet technology. While there were certain inherent overhead delay burdens associated with the DOELZ concept and despite the fact that DOELZ does not run true multipoint as we understand it to be, the technology has enjoyed limited market acceptance. DOELZ technology did reduce circuit costs and it did support multiple polled protocols.

Then in March 1987, Codex introduced the 2630 modem. The 2630 did run true multipoint and performed as specified - albeit conservatively. However, the 2630 has also been a market flop thus far largely because of the limitations placed on the number of full duplex protocols supported (2) and the line speeds supported (aggregate not to exceed 9600 bps). Paradyne has introduced the 3455 Multipoint Virtual Modem (MVM, 9/87) which is specified to outperform the 2630 (3 protocols, and 14.4 kbps aggregate). We have seen very limited market acceptability of the Paradyne MVM as well, because of questions regarding the product's ability to perform as specified over unfavorable line conditions. Also the 3 protocol/14.4 specs. still represents a technology limitation into which most major customers will not want to place major investment capital.

Codex engineering also doubts that there can be a dramatic break through in analog modem technology to significantly increase protocol/speed performance. Therefore the further development of the 2630 to meet and exceed the Paradyne challenge has been temporarily shelved. Clearly the need for a fresh perspective on multipoint/multiprotocol technology is in order.

II. Enter the 4255 - With A New Perspective

A. A Different Philosophy: While DOELZ, Codex and Paradyne technologies each possess different perspectives and strengths they have a common goal: that goal is to provide multiple, end-to-end, logical data streams for each protocol supported on a single circuit. It has been this perceived need for multi-path support which has limited the performance of each solution.

The 4255 represents a complete change from the end-to-end multipath support. Instead the diverse data is converted to IBM SNA at the remote site and transmitted through the circuit as a single SNA data stream. The limiting factor on this solution becomes the 4255 itself and also the inherent limitations of SNA - both of which exceed the 3 previous technologies.

In order to complete the end-to-end pass through of ASC and BSC protocols, a corresponding 4255 is located at the host site - one for each host supported. The decision maker for the routing of these diverse protocols is VTAM which accepts and passes through SDLC data to the IBM host and routes the BSC or ASC data to the appropriate centrally located 4255(See Attachment 1). VTAM utilizes a Network Routing Facility which gives the 37x5 FEP the capability to perform essentially as a matrix switch. In essence, one host 4255 links with one remote 4255 on a dynamic basis when needed for data pass through. As best we have been able to discern thus far from Codex engineering there is no reason why the Attachment 1 design cannot work. If so, the market impact of the 4255 will, in our opinion, be dramatic and immediate.

B. IBM - The Ally Of The 4255 Solution: It should come as no surprise that IBM has assumed leadership in presenting the SNA/SDLC protocol as the answer to the multiprotocol/multipoint market need. Thus far, we have become aware of two IBM SNA proposals for this type of concept. Both have apparent significant weaknesses.

1. The IBM 3708: The 3708 is an ASCII to SNA protocol converter which uses protocol "enveloping" where the ASCII character is "enveloped" with standard SNA/SDLC protocol headers/trailers on a character by character basis. The 3708 is 3270 compatible, appears to the host as a 3274 Mod. C, supports displays of 3278 Mod. 2 or 3279 Mod. 2A, has 3287 print support and can support 2 host connections using SNA/SDLC.

IBM has proposed the 3708 to the Department of Information Services - State of Washington (4/88) in a configuration to support end-to-end ASCII pass through. (See Attachment 2). To our knowledge this is a first time application for the 3708. Essentially the host 3708 acts as a multiplexer to deliver remote site ASCII data to an ASCII host.

The weaknesses of the 3708 are many. First, as of this writing, the IBM 3708 is not visible to IBM NetView while the Codex 4255 is completely NetView controllable. Next, it is strictly an ASCII to SNA protocol converter - no bisync support and it also has a maximum of only 10 ports. Finally, it has no onboard intelligence and is not software based for future enhancements and flexibility. In quantities, we understand the 3708 to be price competitive with the 4255, but the functionality does not even come close.

2. IBM "Arctic" Card: The "Arctic" card solution has been proposed to Rainier National Bank by IBM (Q1-'88) and has been recommended by Rainier's technical design group. We understand that the concept has yet to be bought off by upper management at the account and IBM has yet to produce a product which will work in Rainier's environment. However, a pilot is being planned within the next 90 days.

The Arctic card fits into a slot on an IBM PC or PS/2. It has multiple RS-232 ports which can convert bisync and async protocols to SNA. Technical details of Arctic are not easy to come by since it is an unannounced (to our knowledge) product.

The weaknesses of Arctic is that it consumes the entire PC just to do communications and protocol conversion. This is not only expensive but many network decisionmakers are reluctant to have an entire branch office run through a single PC. MTBF reliability of PC's does not favorably compare to other telecommunication product standards. To add redundancy a second PC is required which significantly increases costs.

We understand that Arctic was originally conceptualized for factory shop floor applications to convert ASCII terminals such as DEC VT100 to SNA. The ability of the card to support multiple polled protocols as in financial applications appears to be a recent enhancement to Arctic and not a part of the initial design. Installed reference accounts might be hard for IBM to produce.

Security Pacific Automation Corp. (SPAC) has initiated the Arctic concept to Rainier - probably as a pilot region to be converted to other SPAC regions if it performs well. As mentioned above, the Arctic concept has yet to be fully accepted by Rainier management as of this date. It remains to be seen how much autonomy Rainier has from SPAC. IBM has also hedged on their ability to deliver Arctic to meet Rainier's protocol and speed requirements at this time.

The 4255 concept outperforms Arctic on a cost and performance basis. It is priced less and can grow to more ports in a single unit (6 vs. 16). It has a higher MTBF than PC's and is fully integrated into NetView. As such it can provide response time monitoring to the host via NetView. Arctic's ability to perform in NetView, to what extent if at all, is unknown.

IBM's marketing of both the 3708 and Arctic supports our 4255 concept. With IBM's current, intense interest in selling their total network philosophy, it is important that we have a Codex solution which can compliment and add value (to use our own terms) as well as co-exist and be compatible with the IBM strategy.

We must accept the fact of IBM's incredible influence over large corporate MIS departments and produce strategies to give major accounts' management the functionality benefits which IBM is selling prospective clients. We can/must add value, compliment and reduce costs after the compatibility and functionality issues are met. The 4255 concept appears to be able to play an integral part in achieving this goal.

III. Conclusion: Future of the 4255 SNA Gateway Idea

Many questions remain to be answered regarding the 4255's ability to perform as we are suggesting. Suffice to say that at this time, we have received enough positive answers from Codex engineering to be very excited about its possibilities. It appears to be a unique, cost-effective, immediate solution which is fully owned and supported by Codex. We think the 4255 concept working in sync with a product like the NetQuest integrated NetView modem module would give Codex the edge we need to respond short term to the IBM challenge currently before us.

Some of the issues which need to be addressed are:

a. Software Modification: In order to achieve the switching through the IBM FEP to connect remote-local 4255's there may be software modification required of the Codex Network Support Program (NSP). We have been told by 4255 engineering that the modifications are minor and can be done in a reasonably short time frame - i.e. less than 30 days.

b. Training: This appears to be the larger issue. At this time we need to absolutely immerse ourselves in SNA concepts, terminology, technology, strengths and weaknesses etc.. The renewed training needs to occur at the sales rep. and A.E. level but it will eventually be required at all support levels of Codex.

The reason training is so critical is that IBM itself has embarked on a massive education program on networking for themselves and their customers. Their efforts are aimed at all levels of an organization from upper management to operations management to programmers to users. It is not uncommon for typical Codex contacts in accounts to be pulled from their normal responsibilities to participate in IBM training, task forces, joint development committees, etc. - sometimes for weeks at a time.

We must be able to understand, appreciate and improve upon the benefits which large accounts perceive to be receiving from IBM. We have succeeded in distinguishing ourselves from our traditional competitors and found ourselves face-to-face with a much more formidable foe. It is not that IBM is specifically interested in selling modems, multiplexers and management systems. Their strategy is much more global involving micro-mainframe application issues, data/voice, integration involving CPU's and PBX's, end-to-end network management etc.. It just so happens that modems, multiplexers and network management equipment are integral components of this overall picture.

C. Different Concept - Better Success: The one requirement for IBM's solution or the 4255 solution is of course a previous customer decision for SNA. Yet we know of only one 2630 type application where SNA/SDLC was not one of the protocols to be supported. We would estimate that the instances of multiprotocol/multipoint applications which have SNA/SDLC as one of the protocols to be greater than 90%.

Until a multipoint X.25 product is available, it appears that the SNA defacto standard will have the best immediate solution for the multipoint, multiprotocol market need. We perceive that the market window is there and the Codex 4255 is mature enough to meet the market immediately. The strengths which it has should be strong enough to win in the majority of head-to-head opportunities for qualified customers' budget dollars.

We strongly recommend that Codex make whatever decisions necessary to market this idea. These decisions will range from allocating home office engineering resources and demo equipment, to providing local applications engineers with strong VTAM experience and whatever else might be needed in selling this 4255 application. We see the potential as immense and the urgency as immediate. The concept, if accepted at Rainier Bank and DIS-State of Washington, would mean approximately 250 units per account. The retail/financial market alone in the Pacific Northwest represents a potential of an additional 2,000 units.

Attachment 1

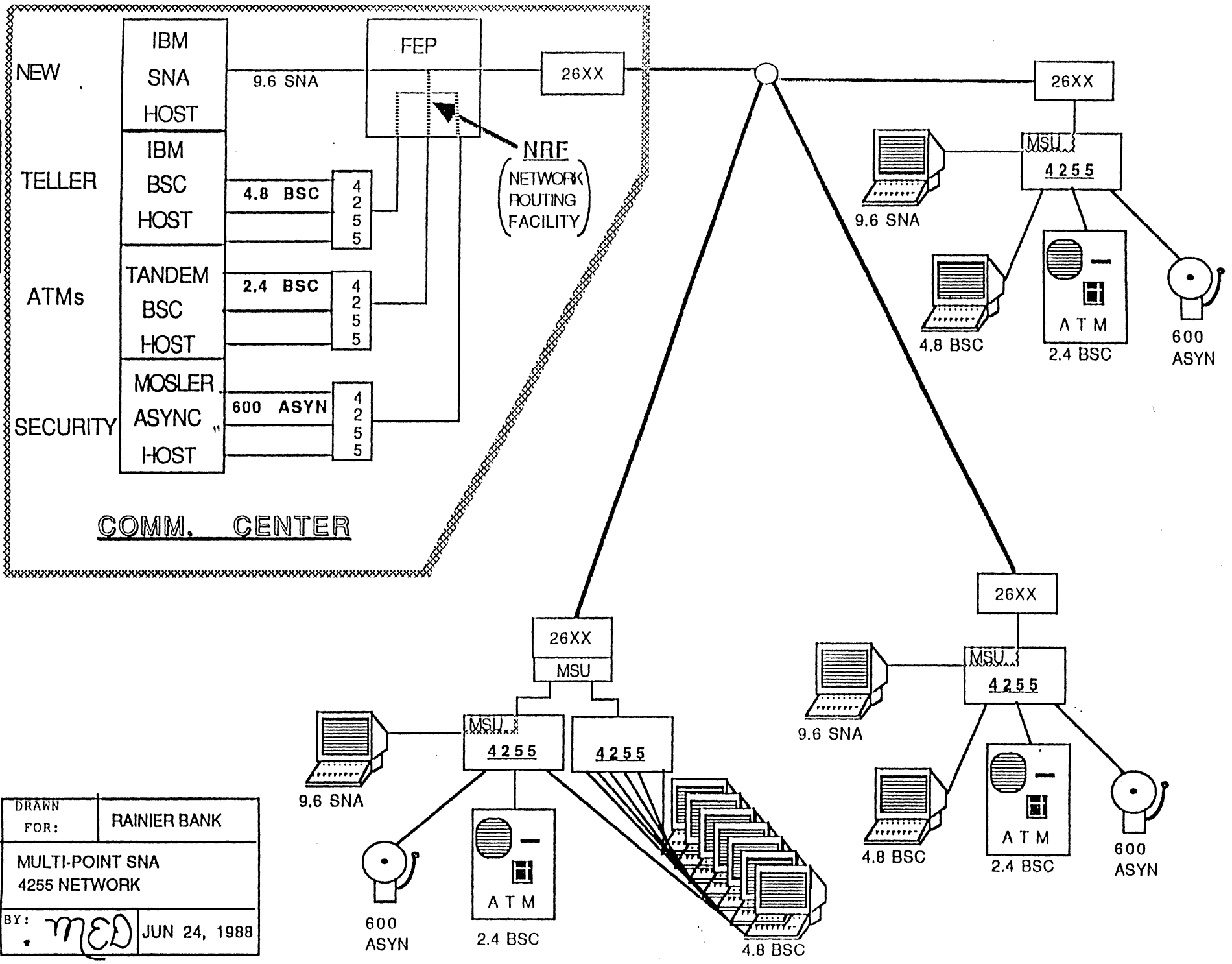

DRAWN FOR:	RAINIER BANK
MULTI-POINT SNA 4255 NETWORK	
BY: <i>med</i>	JUN 24, 1988

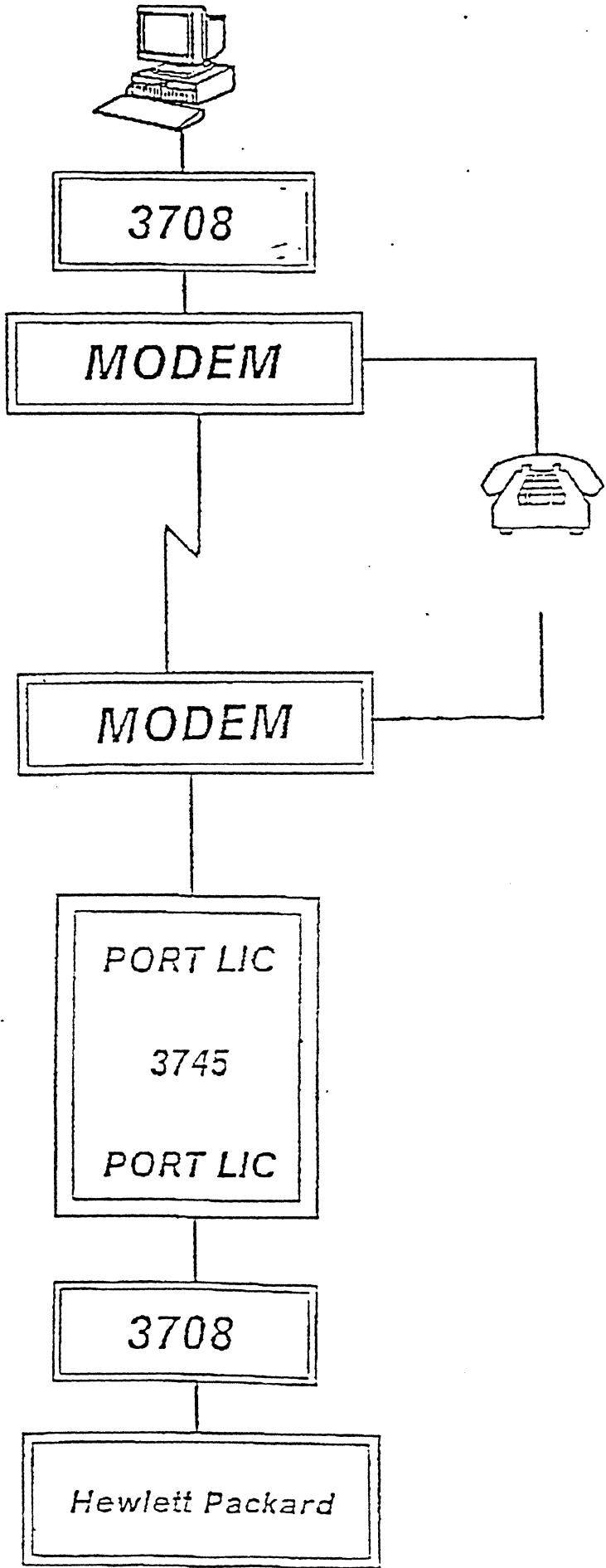

3708 IN SNA NETWORK

Attachment 2.1

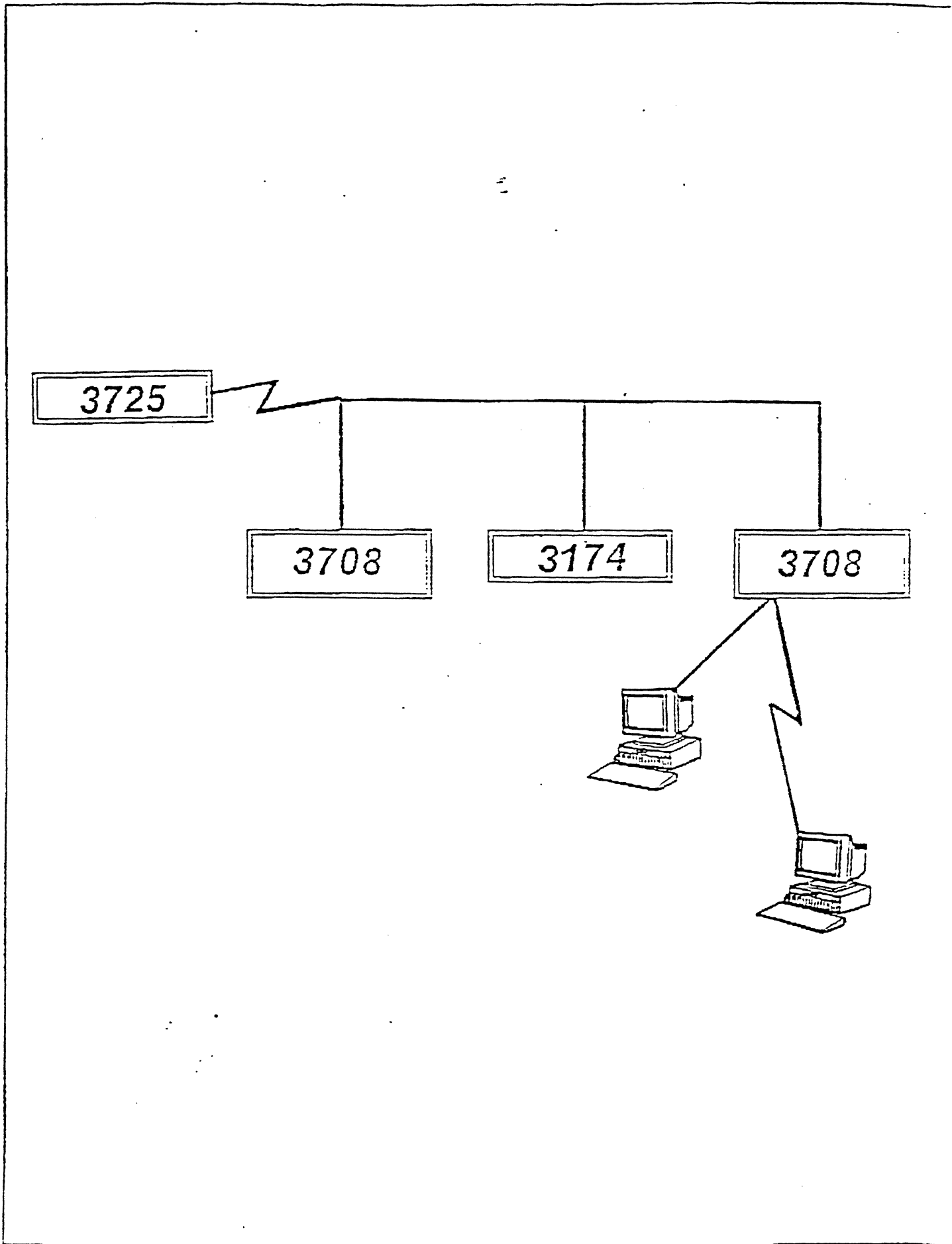

AGENDA

Introduction

SNA / 3708 Network Description

Installation Requirements

SNA / 3708 Costs

OBJECTIVES

SNA / 3708 WORKS!

SNA / 3708 WILL NOT IMPACT YOUR SCHEDULE!

SNA / 3708 IS A BETTER SOLUTION!

SNA / 3708 IS COST COMPETITIVE!

SCOPE / ASSUMPTIONS

SCOPE

- SNA / 3708 AS A REPLACEMENT FOR X.25

ASSUMPTIONS

- YOU HAVE A INSTALLATION PLAN TODAY
- YOU HAVE OR HAVE PLANS FOR:

MARKETING

FUNCTIONAL TESTS

USEABILITY TESTS

INSTALLABILITY TESTS

DOCUMENTATION

TRAINING

NETWORK MANAGEMENT

USER SUPPORT

- **DESCRIPTION...**

- *Protocol Enveloping*
- *Protocol Conversion*
- *SNA Networking for ASCII/Asynch Terminals*
- *Extends Network Management*
- *Central Site Configuration Management*

- **NEW ANNOUNCEMENT**

- *3270 Large Screen Emulation*

3708 IN SNA NETWORK

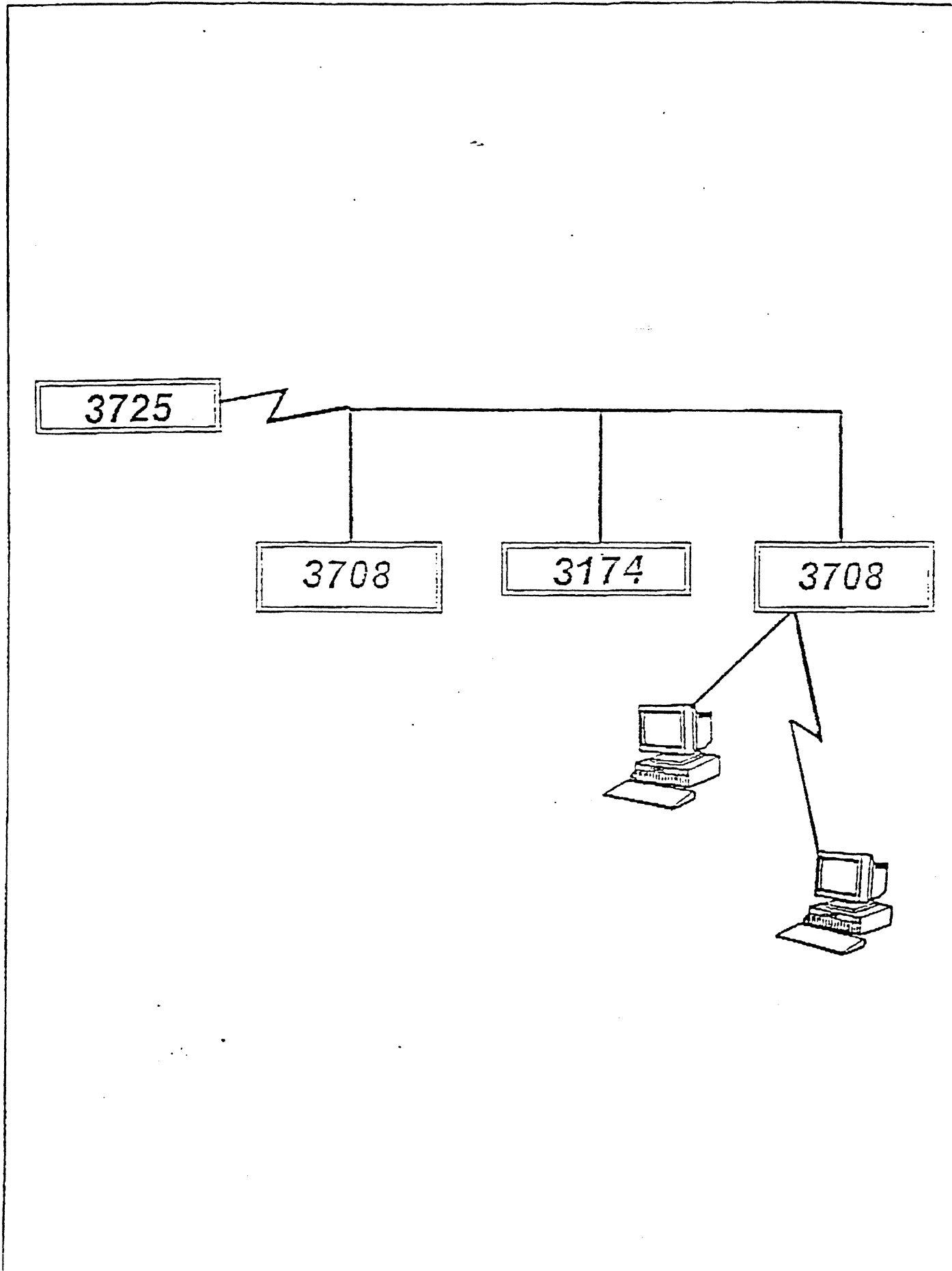



3708

MODEM



MODEM

PORT LIC
3745
PORT LIC

3708

Hewlett Packard

NETVIEW

- ***Network Operations Control***

Commands

Command lists

Automated Procedures

Span

Scope

- ***Network Awareness***

Alerts

Status Monitor

Error Message

NETVIEW

Network Operations Control

- *Span*
- *Scope*

Network Awareness

Network Problem Determination and Resolution

Network Performance / Utilization Monitoring

ADVANTAGES

PERFORMANCE MONITORING

NETWORK MANAGEMENT

FULL DUPLEX LINES

FEWER MODEMS

EXTENDED NETWORK ACCESS

ACCESS TO DIS HOST SERVICES

PROVEN NETWORK

- *Skills*
- *Operations*
- *Support*

INSTALLATION REQUIREMENTS

PILOT

3725 CONTROLLER

- *Utilize Four Line Interface Cards*
- *Assign Addresses (Elements)*

NRF

- *Order*
- *Install*
- *Tailor and Test*

3708's (15)

- *Order*
- *Customize*

LINES

- *Network Layout*
- *Order*

MODEMS

SUPPORT SERVICES

LOCAL IBM SUPPORT

- *Systems Engineering*
- *Telecommunications Unit*
- *Education*

MULTIPLES MARKETING PROGRAM

NETWORK DESIGN SERVICES

CONTRACT SERVICES

- *Project Management*
- *Network Installation*
- *Turnkey Software Installation*
- *Customized Training*

QUANTITY

409



218

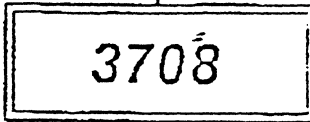

218

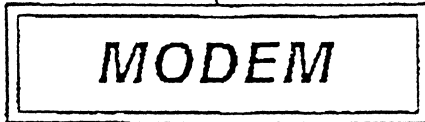

50

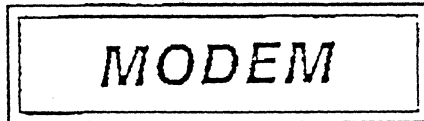

1

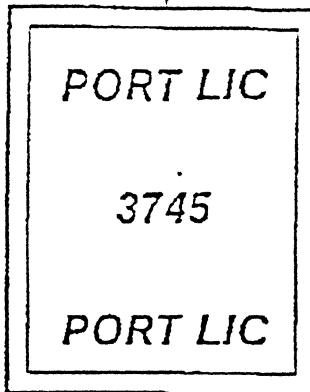

50

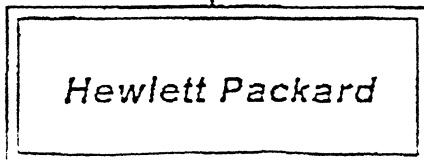
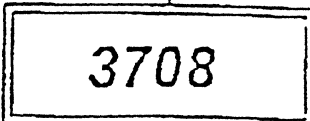

WHAT NEXT...

- *CONNECTIVITY TEST*
- *COMPLETE FUNCTIONAL TEST*
- *FINALIZE COST ESTIMATE*
- *SELECT SUPPORT SERVICES*
- *PRESENT TO ADVISORY BOARD*

NUMBER 185-107
DATE 850917
TYPE Product
TITLE IBM 3708 NETWORK CONVERSION UNIT
ABSTRACT

The IBM 3708 Network Conversion Unit is an advanced networking product which concurrently provides line concentration, protocol conversion, protocol enveloping, and ASCII passthrough for attached ASCII/asynchronous devices. An ASCII/asynchronous terminal attached to a 3708 can use host applications that support full screen 3270 displays and printers. Devices which otherwise would connect through the Network Terminal Option (NTO) licensed program running on an IBM 3705 or 3725 Communication Controller can communicate through the 3708 to IBM host applications. ASCII/asynchronous displays can also connect through the 3708 to an ASCII host application.

A total of ten ports is provided for host and terminal attachment. The 3708 can be multidropped on an SNA/SDLC line with other SNA controllers. It provides SNA networking facilities and CNM support when operating with SNA hosts and applications.

Attachment to one or two IBM host processors using the SNA/SDLC protocol is provided. The 3708 also provides the capability for an ASCII display to communicate point to point with an ASCII host processor in passthrough mode. ASCII/asynchronous devices may be attached to a 3708 directly at distances up to 4000 feet or remotely via switched or non-switched lines. ASCII hosts must be attached to the 3708 via an EIA RS-232C interface, either directly or via non-switched lines.

OVERVIEW

HIGHLIGHTS

- o Supports line concentration, protocol conversion, protocol enveloping, and ASCII host passthrough concurrently
- o Provides easy to use menus to allow a terminal user access to one of two possible IBM host processors or one of multiple possible ASCII host processors
- o Extends SNA networking capabilities to 3708-attached ASCII/asynchronous terminals
- o Extends Communication Network Management support by providing alerts and collecting performance statistics
- o Supports an easy to use control terminal for menu driven remote or local management of the 3708
- o Supports a wide variety of popular ASCII/asynchronous display terminals
- o Allows up to six "User Defined Terminals" to support keyboard mappings not supplied by IBM
- o Supports switched ASCII/asynchronous devices connected to a ROLM CBX II 8000 or 9000
- o Provides a user definable alternate translate table to be used in ASCII to EBCDIC and EBCDIC to ASCII character translation
- o Saves configuration information in non-volatile memory, where it does not need to be loaded from the host and will not be lost in the event of a power failure
- o Supports the 3270 status line, highlighting, and 4-color features
- o Provides type-ahead key queuing and enhanced null/blank processing

- o Supports ASCII printers in three modes: system print, local copy, and shared printing
- o Permits a display with an attached printer to share a single port in protocol conversion mode
- o Supports line speeds from 110 to 19.2K bps
- o Provides device attachment using the EIA RS-232C interface for direct or remote attachment or the EIA RS-422A interface for direct attachment of ASCII displays up to 1219 meters (4000 feet) away
- o Provides auto baud/auto parity recognition and auto answer/auto disconnect
- o Supports optional port passwords
- o Enhances customer problem determination capability by supporting remote diagnostic assistance by IBM support specialists

DESCRIPTION

The 3708 provides a total of ten ports for host and terminal attachment. For example, if one port is used for attachment to an SNA host, then nine ports are available for ASCII/asynchronous terminal or host attachment. If two ports are used for SNA host attachment and two ASCII hosts are attached, then six ports remain for ASCII/asynchronous terminal attachment.

The 3708 does not require any new or unique IBM host software. The 3708 will operate with IBM SNA based MVS, VM, and VSE host programs which support the IBM 3274 Control Unit model 51C or 61C with Configuration Support A. The 3708 can also perform the functions of NTO to IBM SNA applications which support the NTO licensed program. For terminals attached in this mode, it is not necessary to have NTO installed in the 3705 or 3725. The 3708 is also supported by the SNA communication network management products NPDA and NLDM.

When the 3708 is used to connect an ASCII device to an ASCII host via passthrough, the 3708 is transparent to both ends. Any menu selectable ASCII display terminal can attach through the 3708 to an ASCII host which supports that terminal.

The 3708 can attach upstream to the following IBM products. See "Hardware Requirements" below for required attachment products and special features.

- o System/370, 303X, 308X, 3090, and 43XX processors
- o 8100 Systems
- o System/38 System Units
- o 3710 Network Controllers
- o ROLM CBX II 8000 or 9000 Business Communication Systems (downstream)

The IBM 3708 provides for configuration, monitoring and problem determination through the attachment of a user provided control terminal. The control terminal may be any one of the menu selectable ASCII display terminals. The control terminal may either be directly attached to the IBM 3708 or remotely attached via a switched or non-switched line.

ATTACHMENT TO AN SNA HOST

Each ASCII/asynchronous device communicating with an IBM SNA host can operate in one of two modes:

PROTOCOL CONVERSION MODE: The 3708 is a protocol converter that

allows ASCII/asynchronous devices such as display terminals, printers, keyboard/printers and personal computers to appear to an IBM SNA host as 3270 displays and printers. The 3708 converts the 3270 data stream to and from ASCII to permit ASCII devices access to 3270 application programs on the host system. ASCII/asynchronous plotters can also be attached in this mode. The plotter appears the same to the host as an IBM 3287 Printer. The 3708 in protocol conversion mode allows a display with an attached printer to share a 3708 port and appear to the host as two logical units. A user can communicate with the host processor from the display and have output sent to the printer over a single connection, providing a significant line cost saving.

PROTOCOL ENVELOPING MODE: The 3708 provides a protocol enveloping function, allowing TWX 33/35 compatible displays and keyboard/printers to communicate over an SNA/SDLC line attached to an IBM SNA host system through an IBM 3705 or 3725 Communication Controller with NCP. The terminal's appearance to host applications is the same as a TWX 33/35 terminal connected through the Network Terminal Option (NTO) licensed program. For TWX compatible devices, the NTO function resides in the 3708 so that NTO does not need to be installed in the 37x5. Protocol enveloping mode can also be used to allow plotters and other ASCII/asynchronous devices to receive and transmit eight-bit transparent (256 character codes, or binary) data.

The 3708 can be attached to one or two IBM SNA host processors. Each connection is supported as a separate physical unit. Dual connection means a device can selectively attach to one of two different IBM SNA hosts or select one of two links to the same IBM SNA host. Selection is made from the user's terminal at log on time. Eight ports are available for ASCII/asynchronous devices and ASCII host attachment when the 3708 is configured for two SNA/SDLC lines to IBM hosts.

The 3708 is supported by the Network Problem Determination Application (NPDA) and uses NPDA's VSR1/VSR2 non-product specific alert support facility. Alerts from the 3708 appear in the standard Network Management Vector Transport (NMVT) format. When the 3708 is connected to two IBM SNA hosts, it sends alerts to the host which owns the resource for which the alert is being sent. Alerts concerning resources not owned by either host will go to both hosts.

When an ASCII device and ASCII host are connected through the 3708 (operating in passthrough mode), central site problem determination is enhanced because alerts for these resources are sent to NPDA (to one or both IBM SNA hosts), even though the resource does not belong to an SNA host. Alerts are also logged for display at the control terminal.

The 3708 performs a Response Time Monitor (RTM) function in conjunction with the Network Logical Data Management (NLDM) licensed program. This function is similar to that of the 3274 interacting with the current release of NLDM V1R2/V1R3. RTM calculates the response time for each transaction and summarizes the result for each ASCII device being monitored. The 3708 maintains five counters associated with each logical unit and tracks the number of transactions which fall in specified time ranges.

NUMBER 187-107
DATE 870505
CATEGORY CMOO
TYPE Product
TITLE PLUGGABLE CARTRIDGE WITH CENTRAL SITE CONFIGURATION FOR IBM 3708 NETWORK CONVERSION UNIT

ABSTRACT The Pluggable Cartridge with Central Site Configuration (#3525) is an enhanced cartridge that enables centralized control of the operational characteristics of the IBM 3708 Network Conversion Unit. It can be used instead of the current Pluggable Cartridge (#3524). A central site configuration aid that runs on an IBM Personal Computer is included with #3525.

Purchase Price: \$1,000

Planned General Availability: June 1987

PRODNO FOR 3708-001
#3525

OVERVIEW HIGHLIGHTS

- o Enables the use of a single data base of configuration information for all 3708s in a network.
- o Provides menu-driven, user-friendly facilities for the creation, replication, and modification of 3708 configuration information including:
 - Port definition for host links and downstream terminals
 - User-defined terminal definitions
 - User-defined translate table definition
- o Supports retrieval of existing configuration information from a 3708 via a downstream port
- o Supports loading of configuration information via a downstream port or the SNA host link via NetView or NCCF
- o Provides field-specific help facilities and an online Users Guide
- o Checks configuration information and warns the user of potential errors
- o Includes the capability to distribute microcode changes electronically to other 3708s in the network after one 3708 has been upgraded by IBM.

DESCRIPTION

The Pluggable Cartridge with Central Site Configuration (#3525) enables the centralized management of 3708 configuration information and microcode fixes. A data base for the storage of 3708 configurations, retrieval and loading of configuration information from/to 3708s, and replication and modification of 3708 configuration information is supported.

Retrieval of configuration information from a 3708 is through a downstream port. Loading of new configuration information to a 3708 can be done through a downstream port or through the SNA host link using NetView or NCCF. Attachment to the downstream port may be switched or non-switched (leased line or direct attach).

Configuration information includes port, host and device definition, user-defined terminal (UDT) definition, and user-defined Translate Table definition.

Menu-driven, user-friendly screens with field-specific help facilities reduce the likelihood of errors during the configuration

*** DATA BASE : ALET -

PAGE 0002

process. The 3708 central site configuration aid checks the configuration information as it is entered and warns the user of potential errors.

Microcode fixes that have been applied to a 3708 may be retrieved via a downstream port and saved by the central site configuration aid. The microcode changes may then be distributed to other 3708s in the network via a downstream port or sent to the SNA host system for downloading on the host link with NetView or NCCF.

The new Pluggable Cartridge with Central Site Configuration includes all of the function of the current Pluggable Cartridge.

*** DATA BASE : ALET -

PAGE 0001

NUMBER 188-058
 DATE 880419
 CATEGORY LSOO, CMOO, CN10
 TYPE Product
 TITLE FUNCTIONAL ENHANCEMENTS FOR THE IBM 3708 NETWORK CONVERSION UNIT
 ABSTRACT

This announcement highlights enhancements to the IBM 3708 Network Conversion Unit. The enhancements include large screen support, additional ASCII terminal support, configurable user-defined terminal names, field attribute support, and improved "type ahead" support. Customers who have a 3708 with the Standard Cartridge (#3524) or the Central Site Configuration Cartridge (#3525) will receive an availability notice.

This is a no-charge engineering change (EC) for customers who have 3708s installed or on order before April 19, 1988.

Planned Availability Date: April 29, 1988

PRODNO 3708-001 #3524, #3525

OVERVIEW HIGHLIGHTS

- o Large screen support to emulate 3278 Display Models 3, 4, and 5
 - o Support for additional ASCII terminals (IBM 3151, Wyse 50 (1), Falco 500 (2))
 - o Configurable user-defined terminal names
 - o Support for terminals with field attributes
 - o Improved "type ahead" support
 - o End-user notification of an inactive SNA host connection
 - o Configurable terminal initialization sequences
 - o Central Site Configuration for initial 3708 installation
 - o Additional printer and terminal support
- (1) Trademark of Wyse Technology
 (2) Trademark of Falco Data Products Incorporated

DESCRIPTION

LARGE SCREEN SUPPORT

The 3708 provides support for large screen sizes emulating the following displays on an IBM 3270 Information Display System. The screen sizes supported are:

Model 2	24x80	1920 characters
Model 3	32x80	2560 characters
Model 4	43x80	3440 characters
Model 5	27x132	3564 characters

The ASCII display stations supported with this function are:

- o IBM 3162 ASCII Display Station with feature #8232
- o IBM 3151 ASCII Display Station with feature #8535

These IBM ASCII display stations support both Model 2 and Model 5 modes of operation. A 3278 status line is also supported as the 25th line (Model 2) and the 28th line (Model 5) of the ASCII display.

INFORMED SOURCES

(Not So) Easy Money



Usually reliable sources aren't exactly sure when, but sometime in the next six weeks look for IBM to alter the commission structure for its direct sales force. The restructuring will be the biggest in the history of IBM. The impetus behind the shift is to get IBM's mainstream marketing representatives' minds—and wallets—away from focused 3090 mainframe sales, said Brian Jeffery, managing director of International Technology Group. The big winner in the compensation restructuring is expected to be IBM's communications organization. Direct salesmen have shied away from selling complex communications-based solutions, but now they will have to—if they want to meet quota, sources said.

Barbara DePompa