

IDEAssociates™
The Leader in PC Technology.

IDEAcomm 5251™

IDEAcomm 5251/Plus™

IDEAcomm 5251™
IDEAcomm 5251/Plus™

User's Guide

IDEAcomm 5251™
IDEAcomm 5251/Plus™
System 3X Communications
for the IBM PC and PS/2



User's Guide

IDEAssociates
29 Dunham Road
Billerica, MA 01821
Tel. (508) 663-6878
Telex 49-79780
FAX (508) 663-8851

IDEAssociates™
The Leader in PC Technology

Warning



The IDEComm 5251, 5251/Plus, 5251 MC, and 5251/Plus MC cards generate and use radio frequency energy and if not installed and used properly, that is, in strict accordance with the manufacturer's instructions, may cause interference to radio and television reception. They have been type tested and found to comply with the limits for a Class A computing device in accordance with the specifications in Subpart J of Part 15 of FCC Rules, which are designed to provide reasonable protection against such interference in a commercial environment. Operation of this equipment in a residential area is likely to cause interference, in which case the user at his own expense will be required to take whatever measures may be required to correct the interference.

NOTE

External cables not supplied by the manufacturer of this equipment must be shielded to maintain compliance with the FCC rules.

IDEAssociates, Inc. Limited Warranty



IDEAssociates, Inc., guarantees this IDEA Product to be in good working order for a period of 1 year from the date of purchase from IDEA or an authorized IDEA dealer. If this Product fails to be in good working order at any time during this one year warranty period, IDEA will, at its option, repair or replace this product at no additional charge except as set forth below. Repair parts and replacement products will be furnished on an exchange basis and will be either reconditioned or new. All replaced parts and products become the property of IDEAssociates. This limited warranty does not include service to repair damages to the product resulting from accident, disaster, misuse, abuse, or non-IDEA modification of the product.

Limited Warranty service can be obtained by delivering the product during the one year warranty period to an authorized IDEA dealer or by sending the product to IDEAssociates. IDEAssociates will not accept products without a Materials Return Authorization (MRA) number issued by its Customer Support Department, with a proof of purchase date. If this product is delivered to IDEA by mail, you agree to insure the product or assume risk of loss or damage in transit, to prepay shipping charges to the warranty service location and to use the original shipping container or equivalent.

ALL EXPRESS AND IMPLIED WARRANTIES FOR THIS PRODUCT INCLUDING THE WARRANTIES OF MERCHANTABILITY AND FITNESS FOR A PARTICULAR PURPOSE, ARE

Continued

LIMITED IN DURATION TO A PERIOD OF 1 YEAR FROM THE DATE OF PURCHASE, AND NO WARRANTIES, WHETHER EXPRESS OR IMPLIED, WILL APPLY AFTER THIS PERIOD. SOME STATES DO NOT ALLOW LIMITATIONS ON HOW LONG AN IMPLIED WARRANTY LASTS, SO THE ABOVE LIMITATIONS MAY NOT APPLY TO YOU.

IF THIS PRODUCT IS NOT IN GOOD WORKING ORDER AS WARRANTED ABOVE, YOUR SOLE REMEDY SHALL BE REPAIR OR REPLACEMENT AS PROVIDED ABOVE. IN NO EVENT WILL IDEA BE LIABLE TO YOU FOR ANY DAMAGES, INCLUDING ANY LOST PROFITS, LOST SAVINGS OR OTHER INCIDENTAL OR CONSEQUENTIAL DAMAGES ARISING OUT OF THE USE OF OR INABILITY TO USE SUCH PRODUCT, EVEN IF IDEA OR AN AUTHORIZED IDEA PERSONAL COMPUTER DEALER HAS BEEN ADVISED OF THE POSSIBILITY OF SUCH DAMAGES, OR FOR ANY CLAIM BY ANY OTHER PARTY.

SOME STATES DO NOT ALLOW THE EXCLUSION OR LIMITATION OF INCIDENTAL OR CONSEQUENTIAL DAMAGES FOR CONSUMER PRODUCTS, SO THE ABOVE LIMITATIONS OR EXCLUSIONS MAY NOT APPLY TO YOU.

THIS WARRANTY GIVES YOU SPECIFIC LEGAL RIGHTS, AND YOU MAY ALSO HAVE OTHER RIGHTS WHICH MAY VARY FROM STATE TO STATE.

To obtain Limited Warranty coverage, you must complete and return the enclosed Warranty Card.

Information on warranty service is in the appendix on Customer Support at the end of this manual.

Table of Contents

Warning	ii
IDEAssociates, Inc. Limited Warranty	iii
Customer Survey Form	ix
Notice	xi
Copyright	xi
Trademarks	xi
Service	xi
Section I: Introduction	1-1
Overview of IDEAcomm	1-1
Other Products in the IDEA Microcomputer to System 34/36/38 Series	1-4
Organization and Scope of the Manuals	1-5
Section II: Installation in the PC Family and PS/2 Model 30	2-1
SECTION III: Installing the Micro Channel Card	3-1
Section IV: Basic Configuration	4-1
Running INSTALL	4-2
Running IDEACFIG	4-5
Files Necessary to Run IDEACFIG	4-5
The Minimum That You Must Configure with IDEACFIG	4-6
Invoking IDEACFIG	4-7
Changing Configuration	4-7
Host Session Setup	4-8
Type of Device	4-8
Station Address	4-10
IBM Transfer Package (Display Sessions Only)	4-12
Keystroke Buffering (Display Sessions Only)	4-13
Select Attached Printer Model	4-14

Display Options	4-16
User Interface Options	4-16
Hardware I/O Address	4-16
Hardware Memory Address	4-16
Power On Reset	4-17
Virtual Floppy Options	4-18
Printer Options	4-18
Keyboard Options	4-19
Keyboard Layout	4-19
Keyclick	4-19
Saving the Configuration	4-20
Section V: Using Emulation	5-1
Overview: Activating Emulation Software	5-1
Files Necessary to Run IDEAcmm (TWINAX)	5-2
Loading the TWINAX Software	5-3
Options on the TWINAX Command Line .	5-4
Making TWINAX Resident or Non-Resident in Memory	5-5
Operating in Emulation	5-6
Using LUs	5-6
Using the Emulated Keyboard	5-7
Ending Emulation	5-7
The Sign-on Screen and Status Line	5-8
Status Line Indicators	5-8
Using the Hot Key (Shift-Shift)	5-10
Windows: Viewing More than One Session at Once	5-10
The Command Menu	5-11
Getting Help	5-12
EXTENDED	5-12
WINDOWS	5-12
FREE	5-13
PRINT	5-13
RESERVE	5-13
SAVE	5-13
VIEW SETUP	5-14
VIRTUAL	5-14
EXIT	5-15
Record/Playback	5-16
Batch Files	5-18
SEND Utility	5-18
AUTOTWIN Command	5-19
SECTION VI: Displays, Windows, and Graphics	6-1
Windows: General Information	6-1

The 3180 Display: Viewing 132 Columns	6-5
Condense Key (Ctrl-M) Used with 3180 Emulation	6-6
Viewing 3180 Emulation with an 80 Column Video Adapter	6-7
The 3180 Shadow Cursor	6-7
5292 Displays: Using Graphics Programs	6-8
Using GR5292	6-8
Configuring Display Options with IDEACFIG .	6-9
Remap Color Attributes	6-10
EBCDIC/ASCII Display Translation (and Printer Translation)	6-13
Set Column Separator Character	6-17
5251 Display Type	6-17
Cursor Type	6-17
Color Attribute Mapping	6-18
Additional Display Options	6-18
Window Mode on Load	6-18
Video Adapter (Display Adapter)	6-18
SECTION VII: Printing	7-1
Installation of Printer Software	7-1
The Printer Control Panel	7-2
Printer Error Messages	7-6
Printing Screens (Local Print and PrintScreen)	7-8
Section VIII: Configuring User Defined Printers	8-1
Defining Your Own Printer	8-2
Defining a 5256 Printer	8-5
Defining a 4214, 5224, or 5225 Printer	8-6
Defining a 5219 Printer	8-7
Setting up a Local PC or PS/2 Printer to Print 5292 Model 2 Graphics	8-8
User Defined Features	8-10
Section IX: File Transfer and Virtual Disk .	9-1
Prerequisites	9-1
System 36 Examples	9-2
System 38 Example	9-5
IBM File Transfers	9-8
The IDEA Virtual Disk Driver (ADDVDSK) .	9-8
Appendix A: Troubleshooting, Error Messages, and Charts	A-1
Overview	A-1
Troubleshooting Tips	A-1

Printer Diagnostics	A-7
TWINDIAG Diagnostic Program	A-13
TWINAX Program Messages	A-22
IDEACFIG Messages	A-24
Attaching the IDEAComm TWINAX Line to IBM Remote Controllers	A-25
ASCII Chart	A-27
Appendix B: Keyboard and Terminal	
Defaults	B-1
Overview	B-1
Emulated Keys on the IBM Keyboards	B-1
Attribute Appearance for 5250 Display Station and Monochrome Personal Computer ...	B-7
Attribute Appearance for 5292 Display Station and Color Monitor Personal Computer	B-11
Appendix C: Using REVUP.EXE to Update Older Software	C-1
Running REVUP	C-1
Example	C-2
Appendix D: Switch Settings	D-1
TWINAX Plus Rev. D and Higher Cards	D-1
TWINAX-PLUS Rev. C Settings	D-4
TWINAX Rev. A, B, and Older C Settings ..	D-7
Quick Reference Chart for TWINAX and TWINAX-PLUS Switches	D-8
Appendix E: The SEND File Editor	E-1
Overview	E-1
Running the Editor	E-2
Filling in the Screen	E-3
Example	E-6
Appendix F: Using the Keyboard File Editor	F-1
Overview	F-1
Files Required	F-1
Running the KYEDIT Program	F-2
Strategy for Changing Keys	F-2
Options with the KYEDIT Command	F-11
The .CAP File Structure	F-12
Appendix G: Glossary	G-1
Appendix H: IDEA Products	H-1
Appendix I: Customer Support Information	I-1
Index	Index-1

Customer Survey Form



Product: IDEAcomm 5251 and 5251/Plus Rev. 6

1. Were there any errors in the manual? If yes, list page numbers and kind of error:

2. Was information:
easy to understand _____
difficult _____
List information that was hard to find:

3. Was information:
complete _____
incomplete _____

4. What features of the product did you particularly like?

5. What features would you like to see added to the product in future revisions?

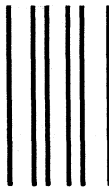

NO POSTAGE
NECESSARY IF
MAILED IN
THE UNITED
STATES

BUSINESS REPLY MAIL
FIRST CLASS PERMIT NO. 50 BILLERICA, MA

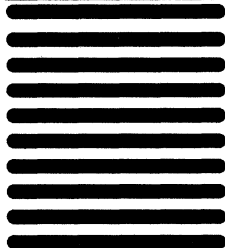

Postage will be paid by addressee

IDEAssociates, Inc.
29 Dunham Road
Billerica, MA 01821-9947

Attn: Documentation Dept.

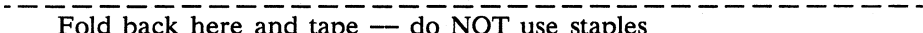

Fold back here and tape — do NOT use staples

- 6. Compared to similar manuals, how would you rate the documentation?
Better than most _____
Average _____
Worse than most _____
- 7. Please rate your knowledge of personal computers:
Experienced _____
Some previous use _____
First-time user _____
- 8. Please use the rest of this page for additional comments.

Optional: Name _____
Phone _____
Address _____

Notice



Copyright

Copyright ©1988 by IDEAssociates, Inc. All rights reserved.

Trademarks

IDEAcomm 5251, IDEAcomm 5251/Plus, and IDEAcomm 5251 MC are trademarks of IDEAssociates Incorporated.

IBM, PC Organizer, PC Support/36, PC Support/38, Personal System/2, and Micro Channel are trademarks of International Business Machines.

Service

IDEAssociates has an established network of computer dealers throughout the United States and worldwide. To place an order or to locate the nearest dealer, call nationwide at (800) 257-5027. In Massachusetts, call (508)-663-6878.

Section I:

Introduction



Overview of IDEAcomm

The IDEAcomm card works with TWINAX emulation software to link the IBM PC or PS/2 series to an IBM System 34/36/38 minicomputer or to the IBM 5294 or IBM 5251 Model 12 remote controllers via an IBM twinaxial cable. The package provides emulation of System 3X terminals and printers.

Features and Benefits

The IDEA communications system provides the following features:

- The ability to configure 4 LUs or host sessions with IDEAcomm 5251, or 7 LUs with IDEAcomm 5251/Plus
- Support of a maximum of 3 printer LUs
- Emulation of the following terminal types:
 - IBM 5251 display station, model 11
 - IBM 5291 display station
 - IBM 5292 display station, model 1
 - IBM 5292 display station, model 2
 - IBM 3180 display station, model 2
 - IBM 3196 display station
- Emulated printer types supported:
 - IBM 5224/25 printer, model 1
 - IBM 5256 printer, model 1
 - IBM 5219 printer
 - IBM 4214-2 printer

-
- The ability to print graphics from 5292 Model 2 emulation screens on your local printer
 - Windowing feature that allows you to:
 - view multiple sessions at one time
 - turn windows ON or OFF
 - change the size of the windows displayed
 - The SEND utility to send and receive commands between the PC and host automatically
 - Individual host session control: ability to free and reserve sessions without logging off the host, thus allowing multiple users per session
 - Compatibility with IBM's PC Support/36 (5727-WSI) and PC Support/38 (5714-PC1)
 - Support for both the IBM monochrome and color display adapters as well as the IDEAcmm 5251 D card
 - Compatibility with many third party file transfer packages
 - Low level program interface (API) documentation that allows you to tailor applications to IDEAcmm
 - Hot Key to toggle between DOS and host sessions without logging off the System 3X
 - Advanced error detection and recovery features
 - Special hardware design that allows IDEAcmm to work independently of DMA channel resources, thereby eliminating any conflict with hard disks or other hardware devices that use DMA channels
 - Upgrade path to IDEAcmm 5251/Share
 - Upgrade path to IDEAcmm 5251/Gateway
 - One year limited warranty

Making IDEAcomm Operational (a Summary)

1. On the PC family and PS/2 Model 30, set the I/O address and, if applicable, memory address switches on the PC card.
2. Install the card in the PC or PS/2. On the PS/2 Models 50, 60, and 80, boot from the Reference Diskette and run the IBM automatic configuration program.
3. Configure the sessions you want to emulate (display devices and printers), using IDEACFIG or INSTALL.
4. Run the emulation software TWINAX.

Components

Hardware:

- Emulation card
- Twinaxial cable and T connector

Software:

- INSTALL or IDEACFIG program for software configuration
- TWINAX emulation program
- TWINDIAG for diagnostics
- REVUP for automatic updates of previous versions
- SEND utility for automatic startup commands
- AUTOTWIN feature for automatic Hot Key from a batch file
- KYEDIT keyboard remapping program

Other Products in the IDEA Microcomputer to System 34/36/38 Series

IDEAcomm 5251/Share: IDEAcomm 5251/Share is a resource sharing software package that allows 4 PCs or PS/2s to emulate 5250 series terminals and printers using one IDEAcomm emulation card to access the System 3X.

IDEAcomm 5251/Gateway: IDEAcomm 5251/Gateway is a communications package to link PCs and PS/2s on a Netbios compatible local area network to an IBM System 3X.

IDEAcomm 5250/Remote: IDEAcomm 5250/Remote allows remote communications between an IBM PC or PS/2 series computer and an IBM System 3X. This means that a branch office microcomputer can access the corporate IBM System 3X by using a synchronous modem.

IDEAcomm 5250/Remote Gateway: IDEAcomm 5250/Remote Gateway allows four Servers and multiple users to access one or more System 3Xs over a network compatible with Netbios.

IDEAcomm 5250/Remote Share: IDEAcomm 5250/Remote Share allows four remote PCs or PS/2s to access a System 3X with only one emulation card.

IDEAcomm 5251 D Card: A 5251 D card is an optional card that can be used with the IDEAcomm 5251 or 5251/Plus emulator card. It replaces the IBM monochrome display adapter, and allows you to display all 32 attributes of a 5251 terminal. For the user accustomed to working with a 5251 terminal, this product allows closer emulation of an actual 5251 terminal.

Organization and Scope of the Manuals

This manual is the basic reference for the IDEAComm 5251 and 5251/Plus communications packages, including basic hardware installation, configuration of the software, and how to use emulation, including file transfer. The appendixes include troubleshooting hints.

The *IDEAComm 5251 and 5251/Plus Technical Reference* is available free to customers who return the card at the end of this section. It includes information on advanced topics, including the IDEA and IBM applications programming interfaces and IDEA support of IBM printer commands.

Related Publications

For technical users, the *IDEAComm 5251 and 5251/Plus Technical Reference Guide* is described in the preceding paragraph.

System/34

IBM System/34 Installation and Modification Reference Manual (SC21-7689)

5250 Information Display System to System/34 System Unit Product Attachment Information

System/36

IBM System/36 Systems Reference Manual (SC21-9020)

IBM System/36 Changing Your System Configuration (SC21-9052)

5250 Information Display System to System/38 System Unit Product Attachment Information

System/38

IBM System/38 Guide to Program Product Installation and Device Configuration (GC21-7775)

5250 Information Display System to System/38 System Unit Product Attachment Information

Notation Conventions

PC	Refers to an IBM PC, XT, AT, or PS/2 Model 30.
TWINAX	The name of the IDEAComm 5251 or 5251/Plus emulation program.
System 3X	The 3X stands for the IBM System/34, /36, and /38.
UPPERCASE	Information in upper case must be entered as shown. It can be entered in upper or lower case, but is displayed on the screen in upper case.
lowercase	Fields in lower case indicate variable information.
pathname	A field shown as pathname indicates a standard DOS file specification of the form: [drive:][directory\]filename[.ext].
<Enter>	Press the Enter key.
[]	Square brackets indicate optional fields. The square brackets should not be entered.
	Choose one of the items separated by the vertical bar(s). One of the items must be entered unless the items are also surrounded by square brackets.

Documentation Updates

Enhancements or corrections to the documentation are in the READ.ME file on your software diskette.

A list of the files included with each software release is in the file VERSION.DOC.

Please send me a copy of the *IDEAcomm 5251 and 5251/Plus Technical Reference Guide*.

My serial number is:

Company: _____

Name : _____

Address: _____

City/State/Zip: _____

Software version #: _____

Phone Number: _____

Affix
Stamp
Here

IDEAssociates, Inc.
29 Dunham Road
Billerica, MA 01821-9947
U.S.A.

Attn: Documentation Dept.

Fold back here and tape — do NOT use staples

Section II: Installation in the PC Family and PS/2 Model 30

Use this section if you have a PC series microcomputer or a PS/2 Model 30. For other models of the PS/2, see Section III.

Handling the IDEA Card

During unpacking and installation, please be careful with the IDEComm card. Keep all food and beverages away from the card. Do not bend or drop the card.

Serial Number and Version Number

Please turn your IDEComm card to the component side. The serial number is on a sticker on the card. (It is also on the box.) Record this number NOW on both your warranty card and on the following line in this manual.

Serial Number

Date of Purchase

Please write the version number of your software diskette here:

Version Number

Inventory Checklist

You should have received the following:

- IDEComm card
- Short twinaxial cable with 15 pin serial connector
- T-connector
- Support guide for PC
- Software diskettes, 3 1/2" and 5 1/4"
- User's Guide (this book)
- Quick reference card for INSTALL program
- IDEComm 5251 template
- Warranty card

What the User Must Supply

1. A medium size flat blade screwdriver for opening the PC
2. Pliers or a 1/4 inch socket wrench to remove the back cover of some models of the IBM PC
3. Small flat blade screwdriver for attaching the TWINAX cable connector
4. Twinaxial cable with connectors

Installation Overview

1. Open the IBM PC.
2. Check switches on the IDEComm card.
3. "Terminate" the card if it is the last device on the cable or run.

-
4. Insert the card in the PC.
 5. Replace the IBM PC cover.
 6. Connect the TWINAX cable.

Please read through this entire section before beginning installation.

Opening the IBM PC

Preliminary Steps

- Turn off the PC power switch.
- Turn off power to any peripheral devices (printer, monitor, hard disk, etc.).
- If you have an AT, unlock it.
- Unplug the computer and all peripherals from the wall outlet.
- Carefully note where each cable is attached so that you can reattach them later. Disconnect all cables from the back of the PC.

IBM Cover Removal

- Move your keyboard and all peripheral equipment away from the work area.
- Position the PC or PS/2 to allow rear access.
- With an AT, you must remove the back panel first. Pull firmly to detach the plastic fasteners.
- The cover is attached by two or five screws. With a flat blade screwdriver, remove the cover mounting screws by turning the screwdriver counter-clockwise. Certain models may require the use of pliers or a 1/4 inch socket wrench.
- Carefully slide the cover away from the rear of the unit. When the cover will go no further, tilt it up and remove it from the base. The AT requires no tilting.

Checking Switches on the Card

Refer to Appendix D for information on the proper switch settings for your card. To determine which card you have, check the end or bottom of the card for its revision number (refer to Figure 2-1).

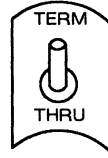

Termination Switch Enlarged

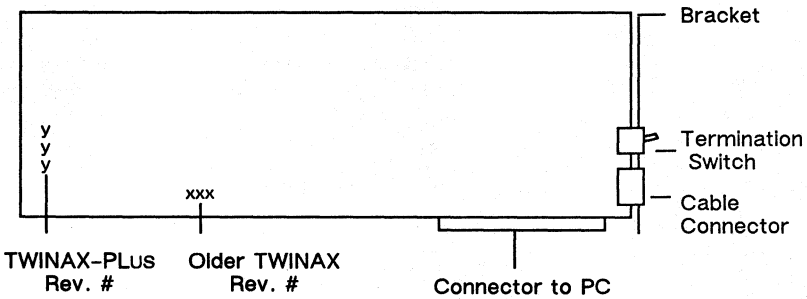

Figure 2-1: The IDEAcomm PC Card

Inserting the IDEComm Card

Once the switch settings are verified (refer to Appendix D), you can insert the IDEComm card into any empty full size expansion slot on your IBM PC. Use a flat blade screwdriver to remove the screw that holds the system expansion slot cover in place (turn the screw counterclockwise). Refer to Figure 2-2.

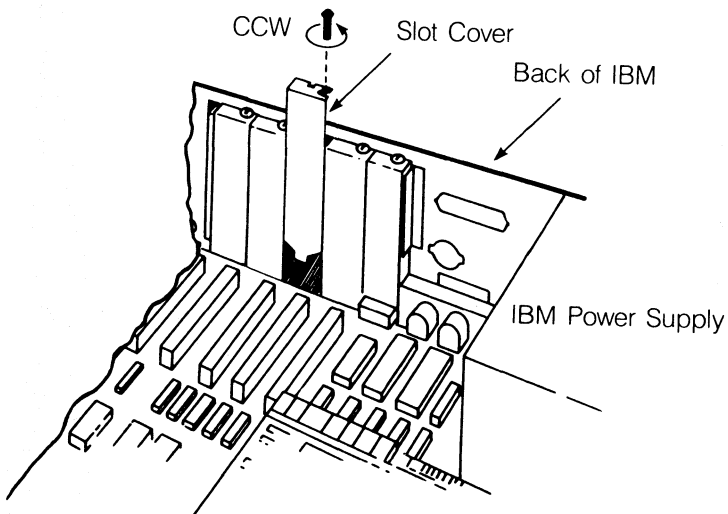

Figure 2-2: Removing the Slot Cover

Save the screw for aligning the card.

Support Track

A Support Guide is enclosed with your IDEComm card. Be sure before inserting the guide that the slot fingers are pointing down. Press the Support Guide into the holes in the front panel of the IBM. Note that if you have an IBM AT or PS/2 Model 30, the guides are already built into the system.

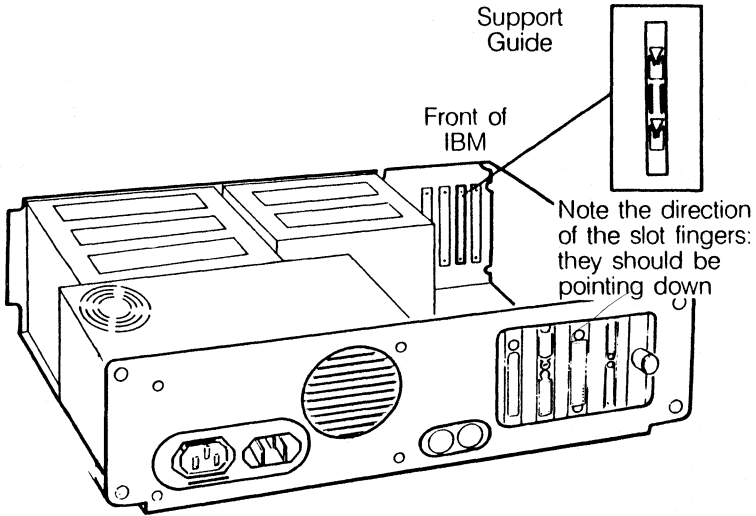

Figure 2-3: Pressing the Support Guide in Place

Inserting and Aligning the Card

Hold the card by both top corners and firmly press it into the expansion slot, being sure that the bracket slides into the PC board.

Align the hole in the IDEComm card retaining bracket with the hole in the rear panel of the IBM. Using a flat blade screwdriver, turn the screw clockwise.

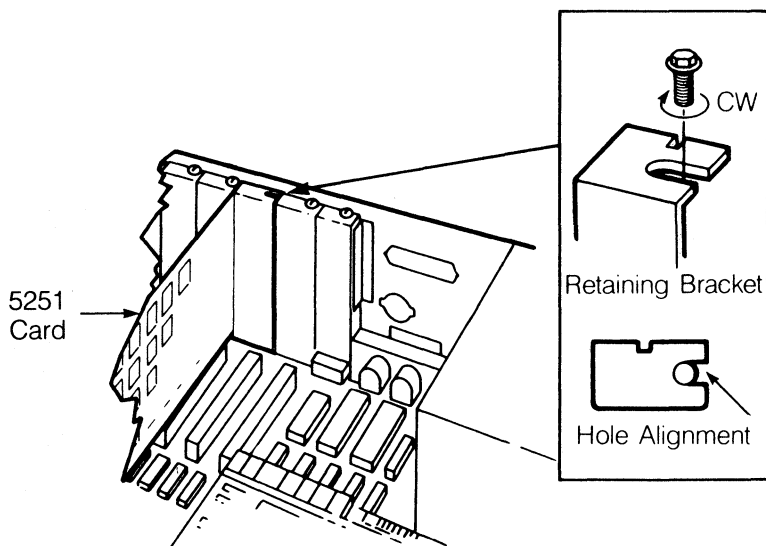

Figure 2-4: Inserting and Aligning the Card

Replacing the Cover

- If you have any other options to install, do so now.
- Replace the microcomputer cover and cover screws.
- If you have an AT, replace the back panel.
- Recable your system.
- Reattach any peripherals.

Termination of the Card

In order for the equipment to function correctly, the last device on the TWINAX run must be terminated. (TWINAX run refers to the cable that connects to a controller.) For flexibility, IDEA provides two methods of terminating. You can terminate the card using the termination switch on the back of the card or attach an external terminator to the end of the outbound TWINAX adapters.

To terminate a TWINAX-PLUS or TWINAX card with its switch, locate the termination switch that protrudes through the retaining bracket on the IDEAcmm card (Figure 2-1). Notice that the words TERM and THRU are etched in the metal bracket on the card. To terminate the card, flip the switch to TERM (toward the top of the card). To remove termination, flip the switch to THRU (toward the bottom of the card).

NOTE

If IDEAcmm is not the LAST terminal on the TWINAX run, you must set the termination switch to THRU, not TERM.

For information on attaching an external terminator, refer to Connecting the TWINAX Cable at the end of this section.

For information on creating a TWINAX run and installing it on the IBM controller, see Appendix A.

Connecting the TWINAX Cable

1. Locate the 15-pin male connector on the IDEA card. This connector protrudes from the rear panel of the IBM PC (Figures 2-1 and 2-5). Attach this connector to the 15-pin female TWINAX cable connector provided by IDEA. Tighten the two mounting screws using a flat blade screwdriver to turn the screws clockwise.
2. Attach the round end of the TWINAX cable connector to the T-connector. (Push the T-connector into the cable connector so that the button on the cable connector fits into the slot on the T-connector. Then twist the collar of the Twinax cable connector until it fits tightly onto the T-connector.)

Attach the TWINAX cable run (the cable that connects to the controller) to the T-connector.

3. You can terminate the unit with a terminator rather than with the switch described on page 2-8. To do this, place a terminator on the T-connector as shown in Figure 2-5.

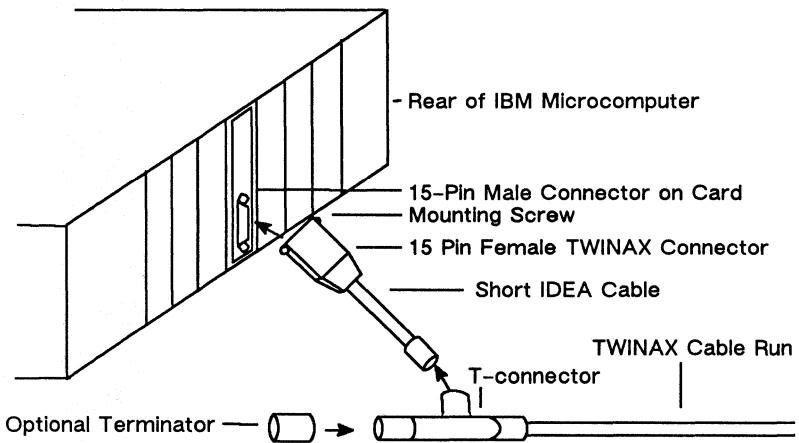

Figure 2-5: Connecting the Twinaxial Cable

SECTION III:

Installing the Micro Channel Card



Use this section if you have a PS/2 model 50, 60, or 80.

The IDEAcomm 5251 MC or 5251/Plus MC software is distributed on micro diskettes. The IDEAcomm 5251 micro channel card requires version 4.03 or higher of IDEAcomm software.

Handling the IDEA Card

During unpacking and installation, please be careful with the IDEAcomm card. Keep all food and beverages away from the card. Do not bend or drop the card.

Serial Number and Version Number

Please turn your IDEAcomm card to the component side. The serial number is on a sticker on the card. (It is also on the box.) Record this number NOW on both your warranty card and on the following line in this manual.

Serial Number

Date of Purchase

Please write the version number of your software diskette here:

Version Number

Inventory Checklist

The following is a list of the components you should have received:

- IDEComm 5251 MC or 5251/Plus MC card
- Short twinaxial cable with 15 pin serial connector
- T-connector
- Software diskettes, 3 1/2 inches
- User's Guide (this book)
- Quick reference card for INSTALL program
- IDEComm 5251 template
- Warranty card

What the User Must Supply

1. Medium size flat blade screwdriver for opening the PC
2. Pliers or a 1/4 inch socket wrench to remove the back cover of some models of the IBM PC
3. Small flat blade screwdriver for attaching the TWINAX cable connector
4. Twinaxial cable with connectors

Installation Overview

Hardware memory and I/O addresses used by the IDEAcmm card are configurable by software. A configuration utility on the Reference Diskette supplied with the PS/2 uses a configuration file supplied by IDEA to set up the computer. The setup procedure for hardware can be summarized in the following steps.

1. Copy IDEA's configuration file @6060.ADF to the Reference Diskette.
2. Turn off the PS/2 and insert the card.
3. Boot with the Reference Diskette.
4. Run "automatic configuration" from within IBM's configuration program.
5. If this card is last on the Twinax series, "terminate" it.
6. Connect the TWINAX cable.

Automatic configuration of the hardware works as follows: Each card installed in a PS/2 computer has a unique ID number and a corresponding configuration file (ADF file), which contains the configuration parameters for that card. The card's ID number is in the configuration file copied to the Reference Diskette, which is used to boot up the computer. During automatic configuration, the computer polls each expansion slot in the PS/2 for a card. It reads the ID number of each installed card and then checks for a corresponding number in the ADF filenames on the Reference Diskette. When a matching file is found, the computer reads down the list of configuration parameters in that file and assigns the first valid options available, avoiding address conflicts with any other cards installed. The configuration information is then saved in the computer's ROM.

Automatic Configuration

1. Copy your card's configuration file, @6060.ADF, from your IDEAcmm diskette to a backup copy of IBM's Reference Diskette.

CAUTION

Before copying the @6060.ADF file to the Reference Diskette, make a copy of the IDEAcmm diskettes and file the originals for safekeeping.

2. Power down and open the PS/2 (see instructions at the end of this section).
3. Plug the IDEAcmm card (shown opposite) into any free expansion slot in the PS/2. Refer to *Installing Options* in your IBM PS/2 manual.
4. Replace the PS/2 cover and recable your system.
5. Power up the PS/2 with the Reference Diskette (containing the IDEAcmm ADF file) inserted in your floppy drive.

NOTE

The first time you boot up after installing the card, Error 165 (adapter configuration error) will appear on the screen. This is normal, as later explained in the program.

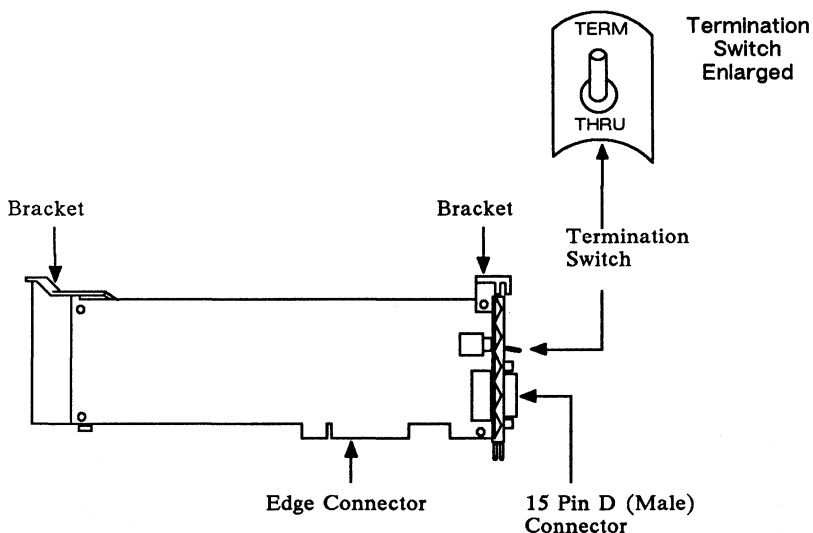

Figure 3-1: The IDEAcomm Micro Channel Card

6. Follow the program's instructions. Enter Y (Yes) to the question, "Automatically configure the system?"

When automatic configuration is completed, you are then instructed to reboot the system. First remove the Reference Diskette, and then press the Enter key to reboot.

Verifying Automatic Configuration

If you wish to verify the automatic configuration of the system, proceed as follows:

1. Reboot the computer from the IBM Reference Diskette.
2. Enter N (No) to the question, "Automatically configure the system?" The Main Menu appears.
3. From the Main Menu, enter Set Configuration (option 3).
4. From the Set Configuration Menu, press 1 to select View Configuration.

Each card installed is listed next to its respective slot number on the View Configuration Screen. If automatic configuration is successful, then the IDEA card will be listed on the View Configuration Screen as shown below:

Slot X - IDEAcmm 5251 [4 or 7] LU Card

Adapter Memory Location Segment xxxx
Adapter I/O Location [IO Base 0xxx]

NOTE

An asterisk beside either the I/O port or memory address indicates an address conflict between the IDEA card and another card installed in the PS/2. If this occurs, remove the conflicting hardware.

Manual Configuration

Manual configuration of the hardware gives you more control over the configuration process. Use manual configuration if you want a device to have a particular address, or if you want to verify the validity of each parameter as you enter it.

1. Complete steps 1–5 in the Automatic Configuration section.
2. Enter N (No) for “Automatically configure the system?” The Main Menu appears.
3. From the Main Menu, enter Set Configuration (option 3).
4. From the Set Configuration Menu, press 2 to select Change Configuration. Enter and save your configuration parameters as directed. The configuration options provided in IDEA’s ADF file are listed below:

<u>I/O Port Configuration</u>	<u>Memory Segment Address</u>
I/O port 308	C000 (default)
I/O port 328	C400 ¹
I/O port 348	C800
I/O port 368 (default)	CC00 ¹
	D000
	D400 ¹
	D800
	DC00 ¹

¹ four-LU system only

NOTE

An asterisk beside either the I/O port or memory address indicates an address conflict. In most cases, this conflict can be resolved by simply selecting a different configuration value.

Termination of the Card

In order for the equipment to function correctly, the last device on the TWINAX run must be terminated. (TWINAX run refers to the cable that connects to a controller.) For flexibility, IDEA provides two methods of terminating. You can terminate the card using the termination switch on the back of the card or attach an external terminator to the T connector for that card.

To terminate the card with its switch, locate the termination switch that protrudes through the retaining bracket on the IDEAComm card (Figure 3-1). Notice that the words TERM and THRU are etched in the metal bracket on the card. To terminate the card, flip the switch to TERM (toward the top of the card). To remove termination, flip the switch to THRU (toward the bottom of the card).

NOTE

If IDEAComm is not the LAST terminal on the TWINAX run, you must set the termination switch to THRU, not TERM.

For information on attaching an external terminator, refer to Step 3 of Connecting the TWINAX Cable on the next page.

For information on creating a TWINAX run and installing it on the IBM controller, see Appendix A.

Connecting the TWINAX Cable

1. Locate the 15-pin male connector on the IDEA card. This connector protrudes from the rear panel of the IBM PC (Figures 3-1 and 3-2). Attach this connector to the 15-pin female TWINAX cable connector provided by IDEA. Tighten the two mounting screws using a flat blade screwdriver to turn the screws clockwise.
2. Attach the round end of the TWINAX cable connector to the T-connector. (Push the T-connector into the cable connector so that the button on the cable connector fits into the slot on the T-connector. Then twist the collar of the Twinax cable until it fits tightly onto the T-connector.)

Attach the TWINAX cable run (the cable that connects to the controller) to the T-connector.

3. You can terminate the unit with a terminator rather than with the switch described above. To do this, place a terminator on the T-connector as shown in the figure below.

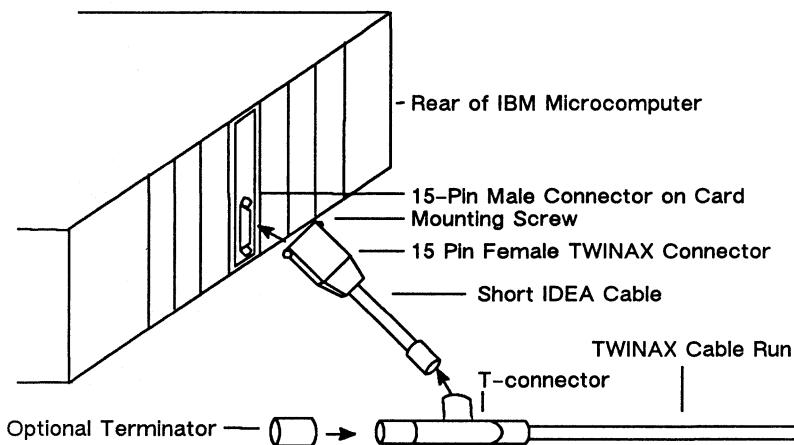

Figure 3-2: Connecting the Twinaxial Cable

Opening the PS/2

These instructions, which are also in the IBM manual for your PS/2, are provided as an aide to the Automatic Configuration steps on page 3-4.

Preliminary Steps

- Turn off the PS/2 power switch.
- Turn off power to any peripheral devices (printer, monitor, hard disk, etc.).
- Unplug the computer and all peripherals from the wall outlet.
- Carefully note where each cable is attached so that you can reattach them later. Disconnect all cables from the back of the PS/2.
- Unlock the PS/2 cover from the side of the unit.
- Loosen the two cover screws.
- Carefully slide the cover away from the unit.
- Insert the card in a free expansion slot.

Section IV:

Basic Configuration

This section tells you how to define your emulation so that you can run the TWINAX program described in Section V.

Before you use the TWINAX emulation program, you or the system administrator must run either the INSTALL or the IDEACFIG configuration program described in this section. These programs allow you to select the displays and printers you want to emulate. If your software has already been configured, go to Section V.

IMPORTANT

Before you use the software, make a backup copy of the IDEAComm diskettes if you have not already done so. Use the DOS COPY command. Put the original diskettes away for safekeeping and use the backup copy.

If you are making a backup copy that overwrites a previous version of IDEAComm, you must delete or rename TWINDIAG.COM from the old version.

The configuration programs work with both IDEAComm 5251 and IDEAComm 5251/Plus. The main differences are in the number of displays and printers you can define and whether IBM file transfer capability is available for all displays. IDEAComm 5251 uses the configuration file TWINAX4.UCM, while IDEAComm 5251/Plus uses TWINAX7.UCM. Only one of these files should be in your directory.

Running INSTALL

The INSTALL program provides a fast, easy method of configuring IDEAcmm for your microcomputer. If you have a standard IBM display adapter and a printer listed below, INSTALL is the only program you need to run before you use IDEAcmm.

In order to use the INSTALL program, you need information from your host configuration. Before you begin, make sure that you know the following for each host session you want to install:

- Model number: For the model of display or printer, TWINAX offers the following options:

Display	Printer
5251 model 11	5224 model 1
5291	5225 model 1
5292 model 1	5256 model 1
5292 model 2	5219
3180 model 2	4214 model 2
3196	

- Station address (0 to 6). Note that, if the IDEAcmm card is connected to the host, INSTALL checks the station addresses currently in use and will not use those.
- Whether it will use an IBM file transfer package (on the 4 LU IDEAcmm 5251).
- PC printer type (serial or parallel) if you are using one.
- PC printer port (LPTx for parallel, COMx for serial) if you are using one.
- The keyboard you will use.
- The directory from which you will run emulation.
- Model of your PC printer if you are using one.

Note

The term **PC printer** refers to your local printer attached either to your PC or your PS/2.

PC Printers supported in Release 5.0
(consult the READ.ME file or run
INSTALL for higher versions):

- ¹NEC 3550 Spinwriter
- ¹IBM 5216 Wheelprinter
- ¹HP LaserJet
- ¹Okidata Microline 84
- ¹IBM Color Printer
- ¹IBM Quietwriter
- ¹IBM Proprinter
- ²Epson FX-286e "IBM Emulation mode"
- ²Epson LQ-1000

- 1 Suitable for 5219 printer emulation.
- 2 Suitable for 4214, 5224, and 5225 emulation.

If your printer is not listed, use IDEACFIG to define it.

Install your hardware and software with the following steps:

1. Install the IDEAComm card in the PC or PS/2 (Section II or III).
2. Connect the TWINAX cable (Section II or III). See Appendix A for how to add a device to an IBM controller.
3. Insert the diskette containing INSTALL.EXE (or copy the IDEA software to your hard disk). At the DOS prompt type:

INSTALL <Enter>

4. The first screen of the INSTALL program is displayed. Read and follow the instructions on this and subsequent screens.

Error Messages

When you run the INSTALL program, the Diagnostics Failed screen may be displayed. The possible problems are displayed as follows:

Cannot copy file

The IDEAcmm file that INSTALL seeks does not exist on Drive A.

Cannot copy files to this directory

The pathname may not exist or the drive may not be accessible.

Could not determine memory and/or I/O addresses for the IDEAcmm 5251 Microchannel

Possible Actions:

- 1. Run diagnostics with the TWINDIAG program.**
- 2. Reconfigure the Personal System/2 with the Reference Disk.**

The configuration could not be determined from values read from the card. The ADF file may be corrupt, or the problem may be card related. Call IDEA Technical Support for assistance.

Emulation Card is Defective

Call your local dealer.

Emulation Card is Not Installed

Check to be sure that you have installed the IDEAcmm card and that it is properly seated.

Emulation Card not installed in Personal System/2

The IDEAcmm micro channel card is either not installed or could not be found.

IDEAcmm 5251/MC card failed diagnostics

Possible Action:

Run diagnostics with the TWINDIAG program.
See Appendix A for use of TWINDIAG.

I/O Address DIP Switches are Not Set Correctly

Check the switch settings on your IDEAcmm card (Appendix D).

Running IDEACFIG

If you have already run the `INSTALL` program, you do not need to run the `IDEACFIG` program unless you need to configure a user-defined printer not listed in the `INSTALL` program. Some users may want to further customize `IDEAcomm` by running the `IDEACFIG` program for features described in Sections VI, VII, and IX.

If you have not run the `INSTALL` program, consider using it. `INSTALL` is the only program most users need to run, and it is quick and easy to use. Refer to the `INSTALL` card or this manual for instructions on using the program.

Files Necessary to Run IDEACFIG

<code>IDEACFIG.EXE</code>	Configuration program
<code>TWINAXn.UCM</code>	Configuration data file, where <code>n</code> is either 7 or 4
<code>PRINTER.CMD</code>	Printer data file (whether you will configure a printer or not)
<code>xxx.VID</code>	If you use a third-party adapter
<code>xxx.KEY</code>	Applicable to your national language and keyboard layout

The Minimum That You Must Configure with IDEACFIG

The following information is required for each display or printer you want to emulate:

- **Model number:** For the model of display or printer, TWINAX offers the following options:

Display	Printer
5251 model 11	5224 model 1
5291	5225 model 1
5292 model 1	5256 model 1
5292 model 2	5219
3180 model 2	4214 model 2
3196	

- **Station address** (supplied by your System 3X administrator)
- **Alternate station address** (not required but strongly recommended)
- **Whether it will use an IBM file transfer package** (on the 4 LU IDEAComm 5251)
- **Your PC printer type** (serial or parallel) if you are using one
- **PC printer port** (LPT1, COM1, etc.) if you are using one
- **PC printer model** if you are using one
- **Hardware I/O Address** set on your card
- **Hardware Memory Address** set on your card
- **Keyboard layout** (PC, XT, AT, Enhanced, non-U. S. A.)
- **National language**

Invoking IDEACFIG

Insert the diskette containing IDEACFIG.EXE (or copy the IDEAComm software to your hard disk). Type the following at the DOS prompt:

>IDEACFIG <Enter>

You see the Main Configuration Screen:

IDEACFIG Version x.x Copyright (C) 198x IDEAssociates Inc.							
Host Session	Device Type	Assigned To	Station Address	IBM Xfer	Key Buf	PC Printer	PC Port
1	No Device						
2	No Device						
3	No Device						
4	No Device						
.							
.							
IDEACFIG Main Options							
1)	Host Session Setup						
2)	Display Options						
3)	User Interface Options						
4)	Printer Options						
5)	Keyboard Options						
Esc)	Save & Exit						
Choice :							

Figure 4-1: Main Configuration Screen for IDEACFIG

Changing Configuration

If you change configuration while emulation is running, the changes do not take effect until you sign off the host, exit from emulation, and restart emulation. (See Section V.)

Host Session Setup

From the main configuration screen, type 1 and press Enter to begin host session configuration.

The system prompts: **Which session number do you want to change?** Type the number of the host session you wish to configure (1-4 or 1-7). After that, you see an arrow next to the current session number in the top half of the screen. The program prompts you through the following series of options.

Type of Device

The bottom half of the screen changes. It allows you to select the model number of the device you wish to emulate. Locate the number (1-9) that corresponds to the model number you wish to use:

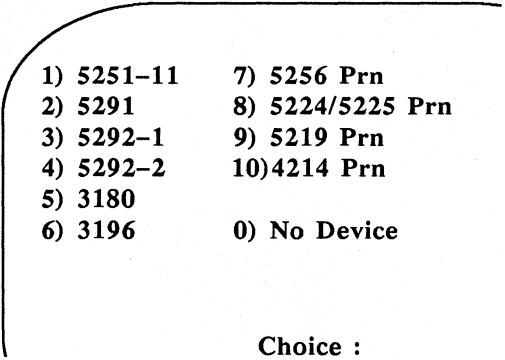
- 
- | | |
|------------|------------------|
| 1) 5251-11 | 7) 5256 Prn |
| 2) 5291 | 8) 5224/5225 Prn |
| 3) 5292-1 | 9) 5219 Prn |
| 4) 5292-2 | 10) 4214 Prn |
| 5) 3180 | |
| 6) 3196 | 0) No Device |

Choice :

Figure 4-2: Device Model Screen

NOTES

You can configure three printer sessions.

On IDEComm 5251, for each 3180 display configured, 2 LUs or host sessions are used. The screen changes to reflect this by offering you one host session fewer to configure. A maximum of two 3180 displays is possible.

On IDEComm 5251/Plus, you may configure any combination of display sessions, including several 3180 sessions, but on most systems, memory availability does not allow for more than five 3180 sessions. If you start to run out of memory, you see the message:

Insufficient memory to configure device.

There is no more memory for LUs. If you need to continue, delete one of the LUs you have already configured, or change a 3180 configuration to a different one.

Type your choice (0-9) at the prompt. Choosing 0 (No Device) removes an existing configuration.

Station Address

After you enter the device, the following prompt appears:



Change station address

Enter one decimal digit :

[Press Esc to cancel] (only when reconfiguring)

[Min 0 , Max 6]

Figure 4-3: Station Address Screen

If the station address is incorrect, the emulation will not work correctly. The System 3X uses the station address to send data to specific devices on a given piece of TWINAX cable. Each display or printer session must have its own address, so that the System 3X can identify the device.

A station address is required for every device you plan to emulate. Station addresses are always in the range of 0 to 6.

Your System 3X system supervisor or someone who has access to system configuration should tell you what model number and station address you can access.

Locate your choice and type the corresponding number (0-6) at the cursor. If you enter a station address that has already been chosen, a warning message is displayed on the screen.

Alternate Station Address

The system displays the Alternate Station Address screen. If N is entered, no alternate station address is configured. If Y is entered, the following prompt is displayed:



Alternate Station Address

Enter one decimal digit:

[Press Esc to cancel] (only when reconfiguring)

[Min 0 Max 6]

Figure 4-4: Alternate Station Address Screen

The configuration program allows you to specify a primary and an alternate address. The primary address is used unless that address is currently in use. If the primary address is not available, the alternate station address is checked.

NOTE

When you select an alternate station address, be sure that it is a compatible device type. If, for example, the addresses are for incompatible displays or if the primary address is for a display and the alternate is for a printer, then the emulation software will not operate correctly.

IBM Transfer Package (Display Sessions Only)

On IDEAComm 5251, if you chose a display session, the screen displays the IBM transfer package prompt. Only one host session can be configured for this capability. On IDEAComm 5251/Plus, all host sessions have it by default.

Your choice on this screen determines whether the host session you are currently configuring will be able to use an IBM transfer package such as IBM PC Support/36 and IBM PC Support/38. If you plan to set up a host session for IBM transfer capability, you must answer YES to the prompt that asks if you will use IBM transfer capability with the host session:

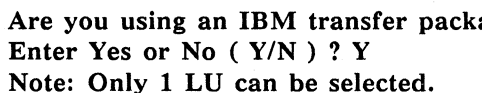

**Are you using an IBM transfer package?
Enter Yes or No (Y/N) ? Y**
Note: Only 1 LU can be selected.

Figure 4-5: File Transfer Capability Screen
(4 LU Version Only)

Note that the word “YES” appears on the screen next to the station address field if IBM transfer package capability is chosen. Also, if you have configured host session #1 for this capability and wish to change the IBM transfer capability to, for example, host session #4, simply enter Y when configuring host session #4 and notice that the word YES moves from host session #1 to host session #4.

Removing IBM Transfer Capability

On IDEAComm 5251, you can remove the IBM capability option from a host session by reconfiguring that host session. Simply enter NO in answer to the IBM file transfer prompt.

Keystroke Buffering (Display Sessions Only)

IDEA allows you to buffer or save 64 characters per session. When the host is temporarily not accepting input, you can keep typing into the buffer. Once the host starts to accept input, it takes the input from the buffer.

NOTE

When the Input Inhibited indicator is highlighted on the status line discussed in Section V, the buffer must be cleared by pressing the Reset Key (Alt). Consequently, all the text in the buffer is lost.

A program prompt asks:

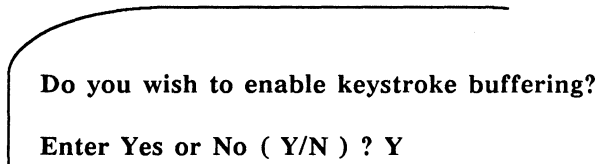

```
Do you wish to enable keystroke buffering?  
Enter Yes or No ( Y/N ) ? Y
```

Figure 4-6: Keystroke Buffering Screen

Answer Yes if you want keystroke buffering.

Select Attached Printer Model

If you selected a printer session (4214, 5224, 5225, 5256, or 5219), after the station address, you are prompted to name your PC printer:

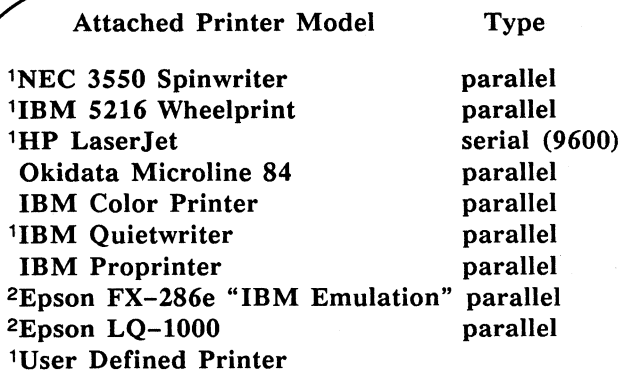

Attached Printer Model	Type
¹ NEC 3550 Spinwriter	parallel
¹ IBM 5216 Wheelprint	parallel
¹ HP LaserJet	serial (9600)
Okidata Microline 84	parallel
IBM Color Printer	parallel
¹ IBM Quietwriter	parallel
IBM Proprinter	parallel
² Epson FX-286e "IBM Emulation"	parallel
² Epson LQ-1000	parallel
¹ User Defined Printer	

Select the attached printer by moving the highlighted block cursor over the printer name and press <Enter>. Use up and down arrows.

- ¹ Suitable for 5219 printer emulation.
- ² Suitable for 4214, 5224, and 5225 emulation.

Figure 4-7: Select PC Printer Model Screen

This screen lists those printers that are already configured by IDEA. If your PC printer is among the choices, select it from the menu. You do not need to configure any parameters for the printer. If your printer is not among the choices offered, choose User Defined and continue setting up your host session. If you choose User Defined, you must enter the appropriate escape sequences further on in IDEACFIG. (See Section VIII.)

You are then asked:

Select LPT printer or COM port device

Enter one decimal digit :

[Press Esc to cancel] (Only when reconfiguring)
[1=LPT1, 2=LPT2, 3=LPT3, 4=COM1, 5=COM2]

If you do not know how your printer is connected, ask your system administrator or refer to your DOS manual.

Automatic Rearrangement of Configuration Selections

If you are not configuring all 4 or all 7 host sessions, the system automatically rennumbers host sessions consecutively starting from 1.

IDEACFIG Version x.x Copyright (C) 198x IDEAssociates Inc.							
Host Session	Device Type	Assigned To	Station Address	IBM Xfer	Key Buf	PC Printer	PC Port
1	5251	-11 DISPLAY	(0)	No	Yes		
2	5291	DISPLAY	(2)	No	Yes		
3	5224 Prn	PRINTER	(4)			IBM Proprinter	LPT1
4	No Device						

IDEACFIG Main Options	
1)	Host Session Setup
2)	Display Options
3)	User Interface Options
4)	Printer Options
5)	Keyboard Options
Esc)	Write & Exit

Choice :

Figure 4-8: Sample Completed Host Session Setup for IDEACFIG

Display Options

These configuration options are discussed in Section VI.

User Interface Options

When you select this option from the Main configuration screen, you see the following:

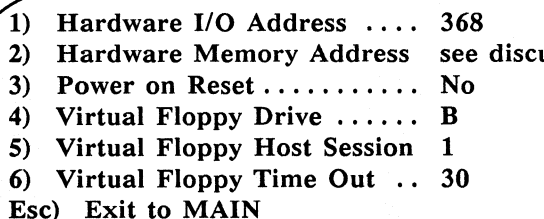
- 
- 1) **Hardware I/O Address** 368
 - 2) **Hardware Memory Address** see discussion
 - 3) **Power on Reset** No
 - 4) **Virtual Floppy Drive** B
 - 5) **Virtual Floppy Host Session** 1
 - 6) **Virtual Floppy Time Out** .. 30
 - Esc) **Exit to MAIN**

Choice:

Figure 4-9: User Interface Options Screen

Hardware I/O Address

This address must correspond to the setting of your IDEA card. If you have a PC or PS/2 Model 30 and the screen does not correspond to the switch settings on the card, select 1) and enter the I/O address set on your card. See Appendix D for switch settings.

If you have a PS/2 Model 50, 60, or 80, you cannot change the address here. You must rerun the configuration program on the IBM Reference Diskette. See Section III.

Hardware Memory Address

This address must correspond to the setting of your IDEA card. On Rev. D and higher, the address is set automatically. On the other cards, the memory address depends on switch settings. See Appendix D for address information.

If you have a PS/2 Model 50, 60, or 80, you cannot change the address here. You must rerun the configuration program on the IBM Reference Diskette. See Section III.

Power On Reset

If you specify YES to this feature, each time you warm boot with Ctrl-Alt-Del, the IDEAComm emulation card is reset and the microcode file is reloaded (sessions are restarted). While emulation is being loaded, the IDEAComm card stops responding to the System 3X. This causes the System 3X to respond as if the display were turned off. If you are in an application, often the display is frozen until the system operator releases it.

If you specify NO to Power on Reset on Load, exiting TWINAX does not cause you to lose your sessions. The program only resets the card if power is turned off to the microcomputer, if emulation is not running, or if the configuration file has been changed. When you re-enter the TWINAX command, you return to the same place in emulation where you were prior to exiting or warm booting. The NO option on Power on Reset on load is helpful if you have to reboot while in an application on the System 3X host.

IDEA recommends that once your configuration is set, you enter NO on the Power on Reset on Load option.

To change the Power on Reset on Load option, from IDEACFIG type 3 on the User Interface Options menu. To select YES or NO, use the space bar to display your choice and press Return.

This option may be overridden from the emulation program if you specify **Exit and Unload Microcode** when you leave emulation. See Section V.

Virtual Floppy Options

You need these options if you are using an IBM file transfer package that uses a virtual drive on the microcomputer. See Section IX for more information.

Printer Options

These options are discussed in Section VIII.

Keyboard Options

When you select this feature from the main configuration menu, you see the following screen:

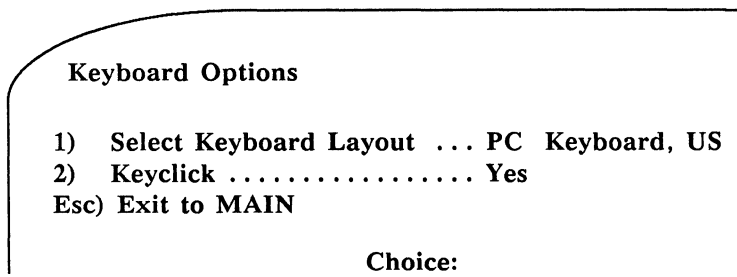

Figure 4-10: Keyboard Options Menu

Keyboard Layout

From the IDEACFIG Keyboard Options menu type 1 to choose this option. It allows you to select the type of keyboard you have (PC, AT, Enhanced). Each keyboard has a language attached to it. For example, the first three choices offered are:

- PC, U.S.**
- AT, U.S.**
- Enhanced, U.S.**
- Generic 3180, U.S.**

See Table B-1 of Appendix B or your template for these layouts.

The next three choices again list PC, AT, or Enhanced but the language offered is different. IDEA supports a number of national keyboards, which may vary with your system.

Keyclick

If you specify YES to this option, each time you press a key on the microcomputer an audible click occurs. If you specify NO, there is no sound.

Saving the Configuration

To save your configuration changes in the file TWINAXn.UCM, return to the main menu with Esc and then press Esc to exit the program. The program queries:

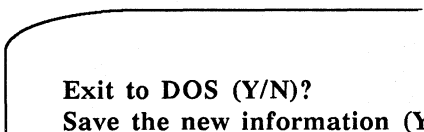
A screenshot of a terminal window showing a menu with two options. The first option is "Exit to DOS (Y/N)?" and the second option is "Save the new information (Y/N)?" The text is displayed in a monospaced font. The menu is enclosed in a simple rectangular border with rounded corners on the top-left side.

Exit to DOS (Y/N)?
Save the new information (Y/N)?

Answer Y to both questions.

Figure 4-11: Save/Exit Menu

Section V: Using Emulation



Overview: Activating Emulation Software

To start emulation, complete the following steps:

1. Install the hardware (Section II or III).
2. Run either the `INSTALL` or `IDEACFIG` program (Section IV) to check at least the following:
 - type and model number for each host session
 - station address for each host session
 - alternate station address (not required but recommended)
 - IBM file transfer capability if needed
 - memory and I/O address of the card
 - correct keyboard layout and nationality
 - printer characteristics
3. Check that you have the necessary files to run `TWINAX` (see the next page).
4. Load emulation with the command `TWINAX`.
5. If desirable, make emulation resident with the Hot Key (Shift-Shift).

Files Necessary to Run IDEAComm (TWINAX)

In order to load the TWINAX program, you must have the following files in the directory from which you invoke TWINAX:

TWINAX.EXE

TWINAX4.UCM or TWINAX7.UCM (not both)

TWINAX4.MI or TWINAX7.MI (not both)

In addition, you may need the following files for special applications:

GR5292.EXE for graphics processing

SEND.EXE for the SEND function

SNDEDIT.EXE for creating SEND record files

AUTOTWIN.EXE for the AUTOTWIN function

ADDVDSK virtual disk driver for some IBM file transfers

REMOVDSK removes virtual disk software from memory

Loading the TWINAX Software

To load the emulation software, type the following at the DOS prompt:

TWINAX <Enter>

The IDEComm software performs a station identification test to verify that the configured station address is not currently being used by another user on the TWINAX run. If the station address is already in use, the software checks the alternate station address (if configured) to determine whether it is available for use.

After this check is completed, the screen listing changes and displays the granted station addresses. If the configured primary address is not being used, the address is granted. If the primary address is being used by another device on the TWINAX run, then the alternate station address is granted if that address is not being used. If both the primary and alternate addresses are already in use, the host session becomes inactive and the Address column shows "ACCESS DENIED."

I D E A c o m m 5 2 5 1 [®]			
Version x.x.x			
Copyright (C) 198x IDEAssociates, Inc.			
System Configuration			
Session	Type	Address	Status
LU # 1	5251-11	3	GRANTED
LU # 2	3180	4	GRANTED
.			
.			

Figure 5-1: Initial TWINAX Screen with Granted Station Addresses

Options on the TWINAX Command Line

You can load the TWINAX emulation program automatically by using the R option with TWINAX:

TWINAX R <Enter>

TWINAX is invoked and the system automatically returns to DOS to execute other commands, leaving TWINAX resident.

You can also invoke TWINAX and then terminate it with the command:

TWINAX EXIT (abbreviation: **TWINAX E**)

This option causes emulation to terminate but does not unload the microcode. See EXIT under the Command Menu further on in this section for a discussion of exiting.

Making TWINAX Resident or Non-Resident in Memory

To make TWINAX resident, hot key back to DOS with Shift-Shift (pressing both Shift keys together). Once the Hot Key is used, TWINAX is resident.

Once TWINAX is resident, you can Hot Key between DOS and TWINAX emulation by pressing the two Shift keys together. More information on the Hot Key is given further on in this section.

Making TWINAX non-resident removes the emulation software program from your microcomputer's memory, freeing up DOS memory.

To make emulation non-resident, you must exit TWINAX:

1. Use Ctrl-Esc to see the Command Menu.
2. Use the arrow keys to move the lighted bar to Exit and press Enter.
3. At the prompt, choose **unload microcode** if you want to change configurations; otherwise choose **do not unload microcode**.
4. At the next prompt answer YES to the query, **uninstall?**

Operating in Emulation

Using LUs

The TWINAX software supports emulation of four or seven System 3X devices, depending on your product, including three printers. Thus several tasks, such as order entry, file transfer, and printing, can be done at one time. Each emulated display or printer is called a **Host Session** or **Logical Unit (LU)**. For example, a few possible configurations are:

IDEAcomm 5251 (4 LUs):

- 4 IBM displays
- 2 IBM 3180 displays
- 1 IBM display and 3 printers
- 2 IBM displays and 2 printers

Each 3180 emulation requires two sessions.

IDEAcomm 5251/Plus (7 LUs):

- seven IBM displays
- two IBM 3180 displays and three other displays
- one 3180 display, three other displays, and two printers
- five 3180 sessions and one printer

Each 3180 emulation requires one session.

The following commands are helpful in viewing and using LUs:

Ctrl-L: Cycle through LUs (if more than one window is displayed, Ctrl-L cycles only through displayed LUs).

Alt-Esc: Cycle through LUs and through DOS.

Ctrl-W: View more than one LU at once in windows. Windows are discussed below and in Section VI.

If an LU is reserved by another user, the message **ACCESS DENIED** appears on the screen when you use Ctrl-L to go to that LU.

Using the Emulated Keyboard

The IBM PC and PS/2 do not have all the keys on a System 3X keyboard. For example, there is no Reset key. Therefore, IDEA has provided keystroke combinations to emulate the System 3X keys. Use the template that accompanies this manual, or the charts in Appendix B, to find the keystroke combinations for emulated keys.

Ending Emulation

To exit emulation:

- If you have made emulation resident, you may go back and forth to DOS with the Hot Key while emulation remains resident.
- If you want to clear emulation from memory, press Ctrl-Esc for the Command Menu. Then choose Exit and press Enter. From the next menu, choose Exit again. In answer to the query, **uninstall?** answer Y.

The Sign-on Screen and Status Line

Once TWINAX has checked access, you see the screen for the first LU available. For a printer, you see the Printer Control Panel described in Section VII. For a display LU, you see the host sign-on screen, which varies with your host and your application.

The bottom line of the screen is the IDEA status line:

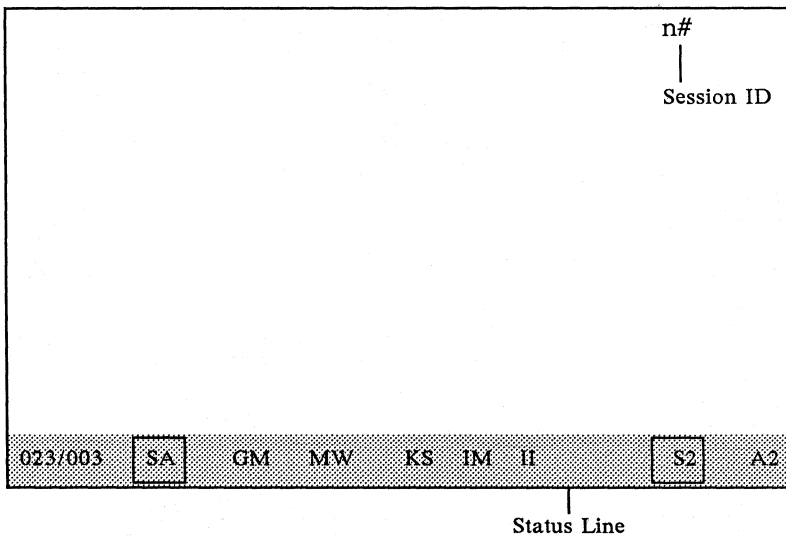

Figure 5-2: Status Line

Status Line Indicators

A System 3X display station has five status indicators along the bottom or right edge of the screen. In addition to the five IBM status indicators, IDEA adds GM for graphics (in emulation of 5292 model 2) and two status messages located in the lower right side of the screen. These messages indicate the Host Session

and Station Address of the screen that is currently being displayed.

Each of the indicators can be either active or inactive, and all indicators are displayed constantly. The status line items are active if the colors are reversed.

If you are using windows, note that if the window is not at least 25 characters wide, not all of the status indicators will be displayed.

The various indicators are described in Table 5-1.

3X Indicator	Abbreviation	Explanation of the Status
Row/column	xxx/yyy	Location of the cursor.
System Available	SA	The 5250 controller and the TWINAX program are operating and ready.
Graphics Mode	GM	The session is a 5292-2 display. If the indicator is active (reverse video), graphics are being processed or waiting.
Message Waiting	MW	Your terminal has messages to be displayed.
Keyboard Shift	KS	Your keyboard is in shifted mode.
Insert Mode	IM	Your keyboard is in insert mode.
Input Inhibited	II	Your keyboard is locked because your terminal is waiting for the controller to respond, the system is processing the previous function key, or there is some error condition.
Host Session	Sn	The n indicates the Host Session number that is currently displayed. If windows are active, then Sn is displayed in reverse video in the currently active window.
Station Address	An	The n indicates the TWINAX Station Address of the displayed Host Session.

Using the Hot Key (Shift-Shift)

Once the TWINAX program is resident in memory you can move back and forth between TWINAX emulation and DOS, or a DOS application program. For example, while you are running TWINAX and are connected to the System 3X, you may need to edit a file with a text editor.

You can hot key out of TWINAX at any time, whether the system is idle or whether any program or command is executing. You return to whatever DOS command or program was executing when you hot keyed into TWINAX, and continue from where that command or program left off. If the system was idle, you return to the DOS prompt.

When you return to emulation, you see the host session displayed when you hot keyed to DOS. If a program was running when you left emulation, the program continued to run even though the host session was not displayed. Therefore, the host session screen display may be different than the one displayed when you hot keyed to DOS.

Windows: Viewing More than One Session at Once

The window feature lets you see more than one LU at once. For example, you can monitor printer status in one session while typing data in another and, at the same time, checking when compilation finishes in a third session.

To create windows, see the Border option of WINDOWS in the Command Menu described below.

You cannot go into window mode from a session not selected in the WINDOWS option of the Command Menu discussed in this section.

The Command Menu

From emulation, enter Ctrl-Esc to see the following menu:

TWINAX Version x.x	
Microcode Version x.x	
EXTENDED	Display or hide attributes on the screen.
WINDOWS	Select window layout from a menu.
FREE	Free sessions.
PRINT	Change output of PrintScreen to a disk file or printer.
RESERVE	Reserve sessions without rerunning the configuration program.
SAVE	Save configurations, windows, or record keys.
VIEW SETUP	View configuration without rerunning the configuration program.
VIRTUAL	Change session number, drive, and timeout parameter for a virtual disk.
EXIT	Exit with microcode loaded, exit and unload, or do not exit but leave Command Menu.

Figure 5-3: The Command Menu

To select one of these options, either:

1. Use the cursor arrows to move the lighted bar to your choice, then press Enter.
2. Type the first letter of the option you want. For Extended, Exit, View Setup, and Virtual, you may have to type the letter twice.

The Hot Key is not processed while you are in the Command Menu.

To exit the Command Menu, press Esc.

Getting Help

Help is available for each command on the menu. Move the lighted bar to the command you want and press F1.

EXTENDED

This option allows you to choose whether or not to display field attributes (protected, intense, etc.) on your screen. For troubleshooting or other purposes, you may wish to inspect field attributes. The default is not to display them.

WINDOWS

This option has three sub-options:

Border lets you choose the layout of your windows: in which quadrant of the screen to display each session and how many sessions to display at once. When you choose this option, press F1 to see a series of possible diagrams of layout. Choose one and press Enter.

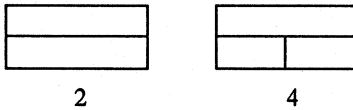

Figure 5-4: Sample Border Layouts

Sessions displayed lets you choose as many as four of the configured sessions for display. When you select this option, you see a list of sessions configured. Enter the session numbers you wish displayed in windows.

Reset Configuration resets the window layout to its original setting when you last started TWINAX, or to the state last saved within TWINAX.

FREE

This option lets you free a session so that another user may sign on with that station address. When you choose this option you see a sub-menu that lists each reserved session plus the option "All reserved sessions." Move the cursor to your choice and press Enter.

PRINT

This option lets you change the output assignment for printing screens with the PrintScreen key. You are prompted for the filename, which may be a disk filename or a printer such as LPT1. The default is LPT1.

This option does NOT print anything. (The PrintScreen key is Shift-PrtSc, or Shift-PgUp for the Enhanced Keyboard.)

RESERVE

This option lets you reserve a session that you have configured but freed, or to which access was denied when you started emulation. For example, if another user has finished with a session address, you can now start a session with the same address. When you select this option, you see a listing of all free sessions, plus the option "Reserve all primary sessions." Move the cursor to your choice and press Enter.

SAVE

Save Configuration: If you change the freed and reserved status of addresses and alternate addresses, you can save the new configuration of station addresses with this option. For example, you might want to switch a primary and an alternate station address.

This option also saves information on the virtual disk discussed on the next page.

Save Record Keys: The record feature is explained further on in this section. If you have used Alt-R from one or more sessions to record keystrokes, you can save them permanently in the TWINAXn.UCM file for another day. SAVE RECORD KEY saves the recorded sequences in all sessions. This means that you can use the same keystroke sequences the next time you load the TWINAX software and enter the host session associated with this record buffer.

Save Windows: The current window configuration may be saved in the TWINAXn.UCM file with this option, for use in the future.

VIEW SETUP

This option gives you a summary of the options configured with INSTALL or IDEACFIG, similar to the following:

The Current Configuration:		
LU #1	5251-11	Address 0
LU #2	5292-2	Address 2
LU #3	5219	Address 6
	--	
Memory: D000	I/O Port: 368	

Figure 5-5: Sample Setup

VIRTUAL

If you want to create or change a virtual disk, choose this option. You are prompted for session number, drive, and timeout interval. Virtual disks are used with some IBM file transfer packages. See Section IX for more information on virtual disks.

EXIT

You have three options:

Exit With Microcode Loaded means that when you use the command TWINAX again, you will have the same sessions running as now. (This is true as long as you do not reconfigure with INSTALL or IDEACFIG, do not turn power off to your microcomputer, and have Power On Reset in IDEACFIG set to No.) You get the further prompt: **Do you wish to uninstall?** if TWINAX is resident. If you answer No, you are returned to emulation.

Exit And Unload Microcode means that when you use the command TWINAX again, the sessions will be restarted. You get the further prompt: **Do you wish to uninstall?** if TWINAX is resident. If you answer No, you are returned to emulation.

Do Not Exit gets you out of the Command Menu but you remain in emulation.

If you want to return to DOS without stopping emulation, use the Hot Key (Shift-Shift).

Record/Playback

This feature allows you to store keystrokes in a buffer and play back the keystrokes later. A total of 900 bytes is available for recording from all LUs together. You can selectively delete a series of stored keystrokes or delete the entire contents of the record buffer for the host session you are currently using.

Keys Used

The following key combinations are used with the Record/Playback option:

- Alt-R begins or ends recording.
- Alt-P plays back the previously recorded keystrokes.
- Alt-C cancels a specific recorded sequence of keystrokes.
- Alt-E erases the contents of the record buffer thereby erasing all recorded sequences of keystrokes for the current host session.

Record

To begin a record sequence, from within TWINAX emulation press Alt-R. The letters RC appear on the host session status line, indicating that record mode is active.

Press any key. The keystrokes you enter are saved to the key you pressed. If you choose a key that has already been used to store keystrokes, the new keystrokes overwrite the old ones and you lose the original keystrokes.

A number is displayed next to the RC in the status line. This number indicates the number of

characters still available in the record buffer. Each time you type a keystroke, this number decreases by one and your keystroke is transmitted to the host.

When you have finished recording, press Alt-R to stop recording.

Playback

To play back a previously recorded sequence of keystrokes, press Alt-P. The letters PB are displayed on the host session status line.

Enter the key that is associated with the sequence of recorded keystrokes you wish to play back.

Cancel

To cancel (delete) stored keystrokes in a specific record sequence, enter Alt-C. The letters CR appear on the left of the host session status line.

Enter the key that is associated with the sequence of recorded keystrokes you wish to delete.

Erase

To erase all recorded keystrokes in the record buffer of the host session currently in use, press Alt-E.

Saving the Record Buffer

Use the Command Menu's SAVE option to save all recorded keystrokes in all sessions for future use.

Batch Files

A batch file consists of commands grouped together in a file. When the file is executed, each of the commands within it is automatically executed.

For example, use an ASCII editor to create a file and name it MINE.BAT. Type the following in the batch file:

```
TWINAX R <Enter>
```

Close the file and, at the DOS prompt, enter:

```
MINE <Enter>
```

TWINAX is invoked and the system automatically returns to DOS to execute other commands, leaving TWINAX resident.

You can also invoke TWINAX and then terminate it with the command:

```
TWINAX EXIT (abbreviation: TWINAX E)
```

See page 5-4 for a discussion of the EXIT option.

The AUTOTWIN command discussed on the next page is also helpful for batch files.

SEND Utility

You can create a batch file that sends keystrokes to the host automatically, similar to the Playback function but with the added ability to detect input from the host and respond. This is a SEND file.

See Appendix E for how to create a SEND file, which ends with the extension .SND.

Once TWINAX is loaded, hot key to DOS and enter:

```
SEND [filename] <Enter>
```

where **filename** ends with the extension **.SND**.
(You do not need to enter the extension.)

If you enter **SEND** with no filename, the utility looks for the default file **TWINAX.SND**.

The **SEND** utility may send all the keystrokes (for example, a login sequence) to the host and, when finished, return to DOS. If, however, the **SEND** file does not include an **AID** key, there will be a pause for operator entry of changeable information such as a password. Then the utility returns you to DOS. Use the Hot Key to return to the last screen.

When the **SEND** utility returns to DOS, it displays the message **SEND completed -- Use Hot Key to resume emulation**.

AUTOTWIN Command

The **AUTOTWIN** command is especially useful in batch files, where the Shift-Shift combination cannot be entered. When you type **AUTOTWIN** at the end of a batch file, the system automatically executes the Hot Key. **TWINAX** must already be resident. If **TWINAX** is not resident, a batch error code of 1 is returned in the batch file.

For example, when you are ready to work in emulation, you could execute a batch file containing the following:

```
CD \MEMOS  
DELETE OLDEST  
RENAME LATEST OLDER  
C:\TWINAX  
AUTOTWIN
```

You can also hot key automatically into **TWINAX** emulation by typing **AUTOTWIN** at the DOS prompt instead of entering Shift-Shift. If **TWINAX** is not resident, **AUTOTWIN** aborts and displays an error message.

DOS

Emulation



Exit (from Command Menu)

Program can be resident or non-resident.



Alt-Esc

Cycles among sessions and DOS.

Ctrl-L

Cycles among sessions.

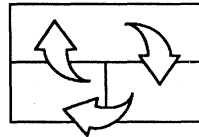

Ctrl-Esc

Cycles between emulation and the Command Menu

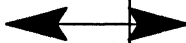
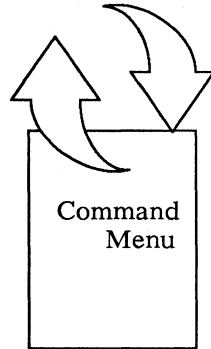

Hot Key (Shift-Shift)

Returns to DOS: Program is still resident.

Ctrl-W

Displays more than one host session at once.

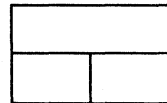

Figure 5-6: Summary of Emulation Keys

SECTION VI:

Displays, Windows, and Graphics

Windows: General Information

This feature allows you to view from 1 to 4 windows on the PC or PS/2 monitor at one time. Each window represents a host session. Control key sequences allow you to move between windows in order to access a host session. All windows are concurrently updated by the host regardless of the host session with which you are working.

Setting Up Windows from Emulation

From emulation, press Ctrl-Esc to see the Command Menu. Move the cursor to **WINDOWS** and press Enter. From the second option, **Sessions Displayed**, be sure that the sessions or LUs that you want to view are selected. Then from the first option, **Border Type**, press F1 for a help screen on layouts available:

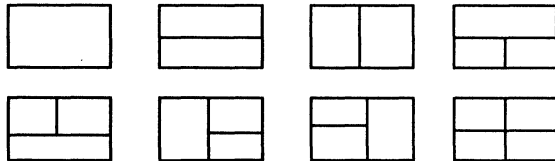

You may select a maximum of four windows to view at once.

Select the layout you want and press Enter or Esc. To save this layout for future use, from the main

Command Menu select SAVE and then WINDOWS.

Exit from the Command Menu with Esc. Then be sure that you are in one of the host sessions that is among the **Sessions Displayed** on the menu, and press Ctrl-W. You will see windows with all of the sessions you chose. To return to one full window, use Ctrl-W again.

You cannot go into windows from a session not selected in the WINDOWS option of the Command Menu.

Activating the Window Option from IDEACFIG

From IDEACFIG, windows are activated from option 3 on the Display Options menu. This option is effective if you have already configured windows from within the TWINAX program.

Option 3 leads to the Additional Display Options menu:

- 1) **Window Mode on Load No**
- 2) **Video Adapter Standard**
- Esc) **Exit to Previous Menu**

Choice :

Figure 6-1: Additional Display Options

Select option 1 and choose either NO or YES in response to the prompt. If you choose NO, then when you enter emulation mode, the window option will not be active but can be activated by typing CTRL-W. If you choose YES, then when you enter emulation mode, the window option will be active.

Altering Windows from the Emulation Program

The commands in Table 6-1 can be executed from TWINAX emulation.

Command	Description
Ctrl-W	Turns windows ON and OFF. When CTRL-W is toggled OFF, the current window is displayed full screen.
Ctrl-L	Moves the cursor to the next window and makes that session active.
Ctrl-right arrow	Scrolls the text to the right one character.
Ctrl-left arrow	Scrolls the text to the left one character.
Ctrl-up arrow	Scrolls the text up one line.
Ctrl-down arrow	Scrolls the text down one line.
Alt-right arrow	Moves the current active window's boundary to the right one position (changes window size).
Alt-left arrow	Moves the current active window's boundary to the left one position.
Alt-up arrow	Moves the current active window's top boundary up one line.
Alt-down arrow	Moves the current active window's bottom boundary down one line.

Saving Window Configurations

Save the current window configuration permanently in the TWINAXn.UCM file by using the Command Menu (Ctrl-Esc). From the Command Menu, select SAVE and then WINDOWS.

Tips on Using Windows

For each host session configured as a display, the status line is displayed along the bottom of the session. (Refer to Status Line Indicators in Section V.)

In order to fit all status indicators on the status line, a window must be at least 25 characters wide. As you shrink the window width, part of the status line will be lost.

The boundaries between sets of host sessions can be made irregular with Alt and the arrow keys:

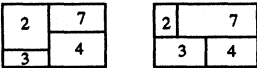

Windows can be reduced in the horizontal direction to zero, causing the host session in that sector to be displayed no longer.

You may use the **Sessions Displayed** sub-option to select any order for display of the windows.

A 3180 wide screen display, when used in a window, is not condensed.

The 3180 Display: Viewing 132 Columns

IDEA provides full 132 column, 3180 emulation for video adapters that support 132 columns.

This option is available only if you have configured a host session as a 3180 display and have a suitable adapter. If you do not, see the discussion on page 6-7.

If you choose 3180 emulation for your microcomputer, and you have a 132 column video adapter that you specify with IDEACFIG, you will normally see all 132 columns and 28 lines when the host session sends a large display.

Configure for 132 column support as follows:

1. At the DOS prompt, type IDEACFIG <Enter>. The Main Options Menu is displayed (Figure 4-1).
2. From the Main Options Menu, enter 2, Display Options.
3. From the Display Options Menu, enter 3, Additional Display Options.
4. From the Additional Display Options Menu, enter 2, Video Adapter.
5. Use the space bar to highlight the type of adapter you are using for your particular display (monochrome, color, EGA, or third-party .VID files located in the same directory). Then press the Enter key to enter your selection.

Note that the screen is not condensed if you use more than one window.

IMPORTANT

IBM's video adapter (designated as Standard) does not support full viewing of 132 column, 3180 emulation. If you wish to use this feature in Release 5.0, you must have one of the following video adapters:

- ATI Graphic Solution Color or Mono
- ATI EGA Wonder Color or Mono
- Tseng Labs EVA color
- STB Chauffeur HT CGA Color or Mono
- STB Multi Res II EGA Color or Mono

Contact IDEA Technical Support for additional video adapters supported by IDEA.

Condense Key (Ctrl-M) Used with 3180 Emulation

This key alternates between condensed (132 column) and regular (80 column) display. For the key to be effective, you must have specified, with IDEACFIG, 3180 emulation and a video adapter with 132 column support. Then when you start emulation, if the host sends a large screen, you will see the entire screen condensed onto the PC or PS/2 screen. To view only part of the screen at full size, press the CTRL-M key combination. To return to condensed viewing, press CTRL-M again.

If you move from condensed to regular display with Ctrl-M, you can view all the columns and lines by scrolling and by using the cursor keys as described on the next page.

Viewing 3180 Emulation with an 80 Column Video Adapter

If you choose 3180 emulation for your microcomputer, but you do not have a 132 column video adapter, you can still do 3180 emulation. To view all the columns and lines, use the scrolling commands to move different portions of the display into your microcomputer window:

Ctrl-up arrow to scroll up
Ctrl-right arrow to scroll right
Ctrl-left arrow to scroll left
Ctrl-down arrow to scroll down

The 3180 Shadow Cursor

When you use a 3180 host session with an application that takes advantage of this feature, you will notice a second cursor at the top of the screen. This cursor moves across the top of the screen as you enter data. It lets you know in which column you are typing.

5292 Displays: Using Graphics Programs

There are two models of 5292 display stations:

- model 1 – color display
- model 2 – color and graphics display

5292 model 2 terminal emulation requires an enhanced graphics video adapter (EGA) with 256K of memory and an enhanced color monitor.

Using GR5292

The TWINAX graphics program, GR5292, allows you to use a System 3X graphic program such as IBM's popular Business Graphics Utility (BGU).

GR5292 is loaded from DOS with the command:

GR5292 <Enter>

When you try to hot key from emulation to DOS after loading GR5292, the screen displays the following message and prompt:

**GR5251 Graphics Program is Running
Select an option: (1) Return to emulation or
(2) return to DOS and end the graphics
program.**

Note that returning to DOS prohibits graphics in the host session until GR5292 is reloaded.

If you attempt to display a graph from emulation without having loaded GR5292, a screen appears with the following graphics processing instructions:

To display graphics, the GR5292 graphics program needs to be loaded from DOS. Hot key to the DOS session and then at the DOS prompt, type GR5292 and press the RETURN key.

The keyboard is disabled while the graph is being processed. However, once the graph is completed, you can print it on a local printer by using the PRINT SCREEN (PrtSc) key.

For instructions on how to set up your local PC printer to print graphics, see Section VIII.

Configuring Display Options with IDEACFIG

When you choose this option from the main configuration screen, of IDEACFIG, you see the following choices.

IDEACFIG Version x.x Copyright (C) 198x IDEAssociates Inc.						
Host Session	Device Type	Assigned To	Station Address	IBM Xfer	Key Buf	PC Printer PC Port
1	5251 m11	DISPLAY	(0)	No	Yes	
2	5291	DISPLAY	(2)	No	Yes	
3	5292 m1	DISPLAY	(6)	Yes	Yes	
4	5219 Prn	PRINTER	(4)	User Defined	Printer	LPT1

Display Options	
1)	Remap Color Attributes
2)	EBCDIC / ASCII Display Translation
3)	Additional Display Options
4)	Set Column Separator Character 16 Hex []
5)	5251 Display Type No
6)	Cursor Type Block
7)	Color Attribute Mapping Color
Esc	Exit to MAIN

Choice :

Figure 6-2: Display Options

Remap Color Attributes

You can change the way fields are displayed with the attributes configuration screen. The attributes are used by programmers on the System 3X to highlight different functions for different areas of a display screen such as input, or hidden, or error fields. You can create different display combinations for the existing codes. For example, color attribute 39 normally displays as a red foreground on a black background. You may want to change it so that it always shows a black foreground on a blue background.

To remap color attributes, from IDEACFIG type 1 on the Display Options screen. The next screen you see depends on your choice of color attribute mapping (Option 7 on the Display Options screen). See the following pages for the different Color and Monochrome screens.

5292 Model 1 Emulation with IBM Color Display Adapter: Make sure that the Color Attribute Mapping option on the IDEACFIG Display Options menu is set to color. The following screen is displayed:

IDEACFIG Version x.x Copyright (C) 198x IDEAssociates Inc.							
Code	Foregrnd	Backgrnd	Blink	Code	Foregrnd	Backgrnd	Blink
20	Green	Black	No	21	Black	Green	No
22	White	Black	No	23	Black	White	No
24	L-Green	Black	No	25	Grey	Green	No
26	Br-White	Black	No	27	Red	Black	No
28	Red	Black	No	29	Black	Red	No
2A	Red	Black	Yes	2B	Black	Red	Yes
2C	L-Red	Black	No	2D	Grey	Red	No
2E	L-Red	Black	Yes	2F	Red	Black	No
30	Cyan	Black	No	31	Black	Cyan	No
32	Yellow	Black	No	33	Grey	Brown	No
34	L-Cyan	Black	No	35	Grey	Cyan	No
36	Yellow	Black	No	37	Red	Black	No
38	Magenta	Black	No	39	Black	Magenta	No
3A	Blue	Black	No	3B	Black	Blue	No
3C	L-Magenta	Black	No	3D	Grey	Magenta	No
3E	L-Blue	Black	No	3F	Red	Black	No
Status Line -> 99 White Blue No Enter Hex Code to Edit (ESC to quit) 00							

Figure 6-3: Color Attributes Screen

Note that Figure 6-3 shows 32 different codes with display attributes assigned to each code. In addition there is one special code used to format the status line.

Each value you see in the code column corresponds to an IBM 5292 type display attribute. These attributes are described in detail in Appendix B.

5251 (Monochrome) Emulation with IBM Color Display Adapter: Make sure that Color Attribute Mapping on the Display Options menu is set to Mono. The following screen is displayed:

IDEACFIG Version x.x Copyright (C) 198x IDEAssociates Inc.							
Code	Foregrnd	Backgrnd	Blink	Code	Foregrnd	Backgrnd	Blink
20	White	Black	No	21	Black	White	No
22	Br-White	Black	No	23	Black	White	No
24	White	Black	No	25	Black	White	No
26	Br-White	Black	No	27	White	Black	No
28	White	Black	Yes	29	Black	White	Yes
2A	White	Black	Yes	2B	Black	White	Yes
2C	White	Black	Yes	2D	Black	White	Yes
2E	Br-White	Black	Yes	2F	White	Black	Yes
30	White	Black	No	31	Black	White	No
32	Br-White	Black	No	33	Black	White	No
34	White	Black	No	35	Black	White	No
36	Br-White	Black	No	37	White	Black	No
38	White	Black	Yes	39	Black	White	Yes
3A	Br-White	Black	Yes	3B	Black	White	Yes
3C	White	Black	Yes	3D	Black	White	Yes
3E	Br-White	Black	Yes	3F	White	Black	No

Status Line -> 99 White Blue No
Enter Hex Code to Edit (ESC to quit) 00

Figure 6-4: Monochrome Attributes Screen

Changing the Attributes Assigned to an Existing Code (Color or Monochrome Option):

1. To make a change, type the code number you wish to edit, and press Enter.
2. The foreground column is highlighted. Use the cursor keys (up and down arrows) on the numeric keypad to cycle through the options until the desired value is displayed.
3. Use the right cursor key to highlight the background column.
4. Use the up and down cursor keys to cycle through the background options until the desired value is displayed.

-
5. Use the right cursor key to highlight the BLINK column. Use the up cursor key to change the blink field to the desired state.
 6. To change any selections, use the left cursor key to move back to previous fields.
 7. Once you are satisfied with the selections, press the Esc key to save the changes temporarily.
 8. Repeat this process for each code you wish to change.

EBCDIC/ASCII Display Translation (and Printer Translation)

The EBCDIC/ASCII translation tables are configured by IDEA. You should not change them unless your system administrator notifies you that the host is sending unusual codes (for example, non-English codes) to the screen or printer.

IDEAcomm uses two translation tables. One translates IBM EBCDIC codes displayed on the terminal screen into ASCII codes that the IBM PC or PS/2 displays. The other translates EBCDIC codes for the printer into ASCII codes the PC printer uses. Separate tables are provided because different printers attached to the same emulation program may have slightly different character sets.

The IDEACFIG configuration program allows you to alter the translation tables in the TWINAXn.UCM configuration file. Make sure TWINAXn.UCM resides on the same diskette as IDEACFIG.

NOTE

Before making any changes, make a backup copy of TWINAXn.UCM. If you should make an error, you will be able to restore the previous setup.

Changing the Printer or Display Translation

Table: To alter the Display translation table, from IDEACFIG type 2 on the Display Options Menu.

To alter the Printer translation table, from IDEACFIG's Printer Options menu select the printer you want to emulate, and from the subsequent menu type 3.

Along the top of the screen the first hex character (most significant 4 bits) of the EBCDIC code is shown. Along the left side the second hex character (least significant 4 bits) is shown. The value located in each cell is the ASCII value used to translate the EBCDIC value from the controller.

Select Option 1 (Edit Entry). You are prompted for the hexadecimal value of the EBCDIC code you want to change. Type this value and press Enter.

The cell you are about to change is highlighted and the program prompts you for the new ASCII value (in hexadecimal). Type this value and press Enter.

The new value is placed in the table and the original screen is displayed with the change.

Continue this procedure until all the changes are entered. When you are satisfied with the changes, select option 2 (Exit saving changes), to permanently update the TWINAXn.UCM file. If you do not wish to save the changes, press Esc. If you save the file, the new table becomes active the next time you invoke the TWINAX program.

For example, if you want code 7B from the controller, which normally is a curly brace, to be displayed or printed as é (e with an acute accent), change the value in C0 from 7B to 82.

ASCII charts are in Appendix A.

Notes on the Printer Table: The default USA version printer table is shown in Figure 6-5.

PRINTER		1 S T H E X C H A R															
	0	1	2	3	4	5	6	7	8	9	A	B	C	D	E	F	
0	FF	FF	FF	FF	FF	20	26	2D	FF	FF	FF	FF	FF	7B	7D	5C 30	
2	1	FF	FF	FF	FF	20	FF	2F	FF	61	6A	7E	FF	41	4A	20 31	
N	2	FF	FF	FF	FF	FF	FF	FF	FF	62	6B	73	FF	42	4B	53 32	
D	3	FF	FF	FF	FF	FF	FF	FF	FF	63	6C	74	FF	43	4C	54 33	
	4	FF	FF	FF	FF	FF	FF	FF	FF	64	6D	75	FF	44	4D	55 34	
	5	FF	FF	FF	FF	FF	FF	FF	FF	65	6E	76	FF	45	4E	56 35	
H	6	FF	FF	FF	FF	FF	FF	FF	FF	66	6F	77	FF	46	4F	57 36	
E	7	FF	FF	FF	FF	FF	FF	FF	FF	67	70	78	FF	47	50	58 37	
X	8	FF	FF	FF	FF	FF	FF	FF	FF	68	71	79	FF	48	51	59 38	
	9	FF	FF	FF	FF	FF	FF	FF	60	69	72	7A	2F	49	52	5A 39	
C	A	FF	FF	FF	FF	5B	21	7C	3A	FF	FF	FF	FF	2D	FF	FF	
H	B	FF	FF	FF	FF	2E	24	2C	23	FF	FF	FF	FF	FF	FF	FF	
A	C	FF	FF	FF	FF	3C	2A	25	40	FF	FF	FF	FF	FF	FF	FF	
R	D	FF	FF	FF	FF	28	29	5F	27	FF	FF	FF	FF	FF	FF	FF	
	E	FF	FF	FF	FF	2B	3B	3E	3D	FF	FF	FF	27	FF	FF	FF	
	F	FF	FF	FF	FF	7C	5E	3F	22	FF	23	FF	FF	FF	FF	20	

1) Edit Entry 2) Exit saving changes Esc) Exit without changes
Choice:

Figure 6-5: EBCDIC to ASCII Printer Translation Table

Typically, IBM System 3X computers work with printer codes greater than 40 Hex. Those below 40 Hex are reserved for commands. However, there is one command that allows the EBCDIC code to pass directly through to the printer, called **TRANSPARENT MODE**. It is defined in Section III of the *Technical Reference Guide*.

Values below 40 Hex are filled with FF Hex, which indicates that this character is not displayed. IDEA software substitutes an ASCII '—' (value 2D Hex). There is a mechanism for the host to change this value if you want another default character, or you can change the FF in the EBCDIC location to the ASCII code you prefer. If you write special print drivers on the IBM System 3X to take advantage of the special features of your PC printer, you can change these values to match control codes for your

printer. Because the IDEComm communications system does not use the table to find commands in the host print data, you can change any value you wish.

Notes on the Terminal Display Table: The default U.S.A. display table is shown in Figure 6-6.

DISPLAY		1 S T H E X C H A R															
		00	01	02	03	04	05	06	07	08	09	0A	0B	0C	0D	0E	0F
	0	20	10	FF	FF	20	26	2D	ED	ED	F8	E6	9B	7B	7D	5C	30
2	1	01	11	FF	FF	20	82	2F	90	61	6A	7E	9C	41	4A	20	31
N	2	02	12	FF	FF	83	88	83	88	62	6B	73	9D	42	4B	53	32
D	3	03	13	FF	FF	84	89	8E	89	63	6C	74	9E	43	4C	54	33
	4	04	14	FF	FF	85	8A	85	8A	64	6D	75	9F	44	4D	55	34
	5	05	05	FF	FF	A0	A1	A0	A1	65	6E	76	15	45	4E	56	35
H	6	06	16	FF	FF	A6	8C	A6	8C	66	6F	77	14	46	4F	57	36
E	7	07	17	FF	FF	86	8B	8F	8B	67	70	78	AC	47	50	58	37
X	8	08	18	FF	FF	87	8D	80	8D	68	71	79	AB	48	51	59	38
	9	09	19	FF	FF	A4	E1	A5	60	69	72	7A	DB	49	52	5A	39
A	0A	1A	FF	FF	9B	21	7C	3A	AE	A6	AD	AA	2D	F2	FD	DB	
C	B	0B	1B	FF	FF	2E	24	2C	23	AF	A7	A8	B3	93	96	93	96
H	C	0C	1C	FF	FF	3C	2A	25	40	EB	91	DB	DB	94	81	99	9A
A	D	0D	1D	FF	FF	28	29	5F	27	F3	DB	18	DB	95	97	95	97
R	E	0E	1E	FF	FF	2B	3B	3E	3D	DB	92	DB	27	A2	A3	A2	A3
F	F	0F	FE	FF	FF	B3	AA	3F	22	F1	0F	DB	CD	A7	98	A7	20

1) Edit Entry 2) Exit saving changes Esc) Exit without changes
Choice:

Figure 6-6: EBCDIC to ASCII Display Translation Table

Notice that EBCDIC values 20 Hex to 3F Hex are all FFs. These are special codes called attributes used by the IBM System 3X to format the screens. The IDEComm communications system uses these codes to control screen presentation. You cannot change these values from the FF value. In addition, you cannot place an FF anywhere else in the table. These are the only constraints placed on the entries you make.

Set Column Separator Character

Since column separators (an attribute specific to System 3X displays) cannot be displayed by your PC or PS/2 display adapter, you have the option of determining what substitution character will be used in their place. The default setting is 16 Hex, a vertical bar.

From IDEACFIG type 4 on the Display Options menu. A prompt requests that you enter a two character hexadecimal number to use as the substitute character for column separators. For example, enter FE hex if you wish to use a rectangular block, or 2E hex if you wish to use a period. For hex codes, see the table at the end of Appendix A.

5251 Display Type

A 5250 type terminal is capable of displaying many more display attributes than the IBM PC Monochrome display adapter. (For a description of these attributes, see Appendix B.) In order to provide experienced 5250 users with a familiar display, IDEA created the IDEAComm 5251 D card. This optional product provides a display much closer to the IBM 5250 type display while maintaining compatibility with DOS applications.

If you have purchased the IDEAComm 5251 D product to use with the IDEAComm card, from IDEACFIG type 5 on the Display Options menu and change this option to YES.

Cursor Type

This option allows you to configure the shape of the cursor to a block or underline. From IDEACFIG type 6 on the Display Options menu to use this feature. To change the option, use the space bar to select your choice, then press Enter.

Color Attribute Mapping

Options are Color (emulation of a 5292 model 1 display) or mono (emulation of a 5251 display). If you have an IBM Color Monitor and an IBM Color Display Adapter, you should set the Color Attribute Mapping option to Color. If you have a Monochrome Monitor and a monochrome adapter or an IBM Color Display Adapter, you should set the Color Attribute Mapping option to Mono.

To change this option, from the IDEACFIG Display Options menu, type 7.

Additional Display Options

Window Mode on Load

From the Additional Display Options menu of the Display menu, select option 1 to specify whether windows will appear when you start emulation. If you choose NO, then when you enter emulation, the window option will not be active but can be activated by typing CTRL-W. If you choose YES, then when you enter emulation, the window option will be active.

Video Adapter (Display Adapter)

Special Display Adapters: IDEA provides full 132 column, 3180 emulation for video adapters that support 132 columns.

This option is available only if you have configured a host session as a 3180 display. Otherwise, use the CTRL cursor keys to scroll across a 3180 host session and view one part at a time.

See page 6-6 for considerations on defining a special adapter.

SECTION VII:

Printing



NOTE

Before you load TWINAX, make sure the PC printer is selected and ready to print. If the host sends data while the PC printer is off, an error condition occurs.

The term **PC printer** refers to the local printer for either a PC or a PS/2 series microcomputer.

Installation of Printer Software

Run the INSTALL program to install the printer software. If you wish to customize IDEAComm to your printer, you can run the IDEACFIG program. (Customized configuration is discussed in Section VIII.) However, INSTALL is the only program you need to run in order to use the emulation program if your printer is one of those whose parameters were set by IDEA.

The Printer Control Panel

This screen appears when you view an LU defined as a printer. Using the Printer Control Panel screen, you can change the status of the printer and monitor parameter settings and printer activity.

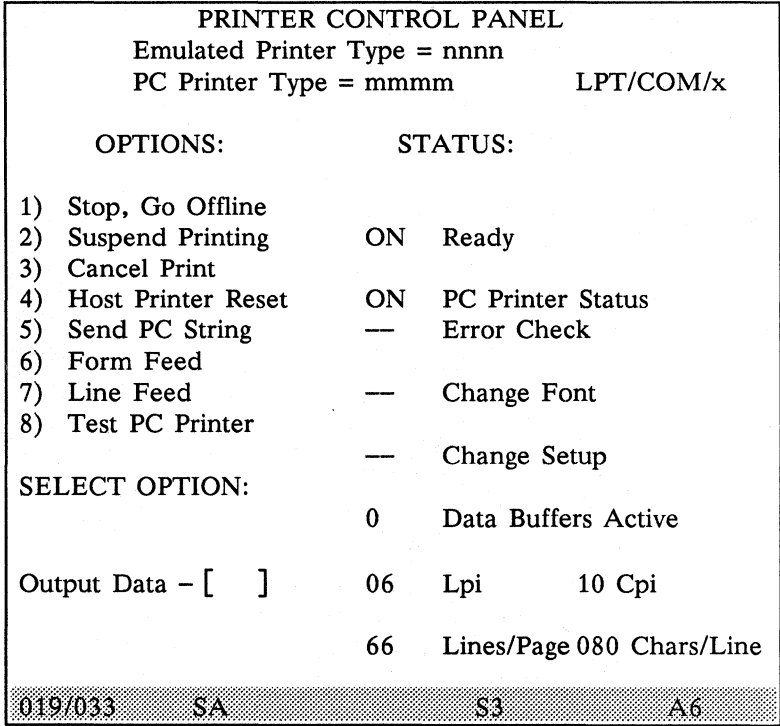

Figure 7-1: Printer Control Panel Screen

Options Available on the Printer Control Panel

Stop, Go Offline — Type 1 at the SELECT OPTION field, and press Enter to start or stop the emulated printer. While the PC printer is printing host data, the normal PC print requests are rejected to avoid mixed printing. Use this option before hot

keying to DOS to print from DOS. To go back online, select this option again.

Suspend Printing — Type 2 at the SELECT OPTION field, and press Enter to suspend printing temporarily. After this option is selected, the suspend printing message is replaced by a highlighted RESUME PRINTING.

Cancel Printing — Type 3 at the SELECT OPTION field, and press Enter to terminate the printout.

Host Printer Reset — Type 4 at the SELECT OPTION field and press Enter. This sends a reset command to the host that aborts the printing session, and puts the printer offline for the host. This option is also used to clear the Error Check indicator.

Send PC String — Type 5 and press Enter. You are prompted for a number, 1 through 4. Press the number that corresponds to the desired Printer Setup string configured with IDEACFIG. (See page 8-14.)

Form Feed — Type 6 at the SELECT OPTION field and press Enter. This issues a form feed to the printer and sends the paper to the top of the next page.

Line Feed — Type 7 at the SELECT OPTION field and press Enter. This issues a line feed to the printer that causes the paper to move down one line.

Test PC Printer — Type 8 on the Printer Control Panel screen and press ENTER to start this test. This test is used to verify that the local PC printer is cabled and configured correctly. It also uses the Advanced Printer Configuration commands from Section VIII if you choose to emulate a 5219 printer. You can use the test to verify that the printer command sequences have been configured correctly for your emulated printer type. See Appendix A for sample output from printer tests.

Indicators on the Printer Control Panel

Ready — When the printer is online to the host, ON appears in this box.

PC Printer Status — When the printer is online, ON appears in the box. When the printer is out of paper, PO appears in the box.

Error Check — If error check is active, ON appears in front of the words Error Check and the printer goes offline. The type of error is displayed below the Output Data field (see Table 7-1). The Output Data field also displays a number corresponding to a System 3X printer command (Table 7-2).

To clear the error condition select the Printer Reset option, then select the Online option to put the printer back online.

Change Font — If a new font cartridge must be inserted in the printer, then a font number may be configured as “Stop on font change.” (See Set Font Change in Section VIII.) In this case, the Change Font indicator becomes active. The Output Data field displays the decimal number of the font to insert in the printer. The user should insert the new font cartridge and selecting the Online option from the Printer Control Panel. The command sequence will then be sent to the printer.

Change Setup — This indicates a printer setup change. ON means change setup. ‘BL’ means the BELL command was received. The printer goes offline and the Output Data field displays one of the following numbers:

- 001 = manual feed
- 002 = tractor feed
- 003 = automatic cut sheet feed

The user must change the feed type (if manual feed, insert the sheet) and put the printer back Online from the Printer Control Panel.

Data Buffers Active — There are two 256 byte buffers. The number (0, 1, or 2) displayed in front of this status indicates the number of buffers presently active.

If the number 1 or 2 is displayed but the information sent to the printer is not printing, the printer may be faulty or printing may be suspended.

LPI (Lines per Inch) — The numbers in front of this status indicate the current lines per inch setting of the print job.

CPI (Characters per Inch) — The numbers in front of this status indicate the current characters per inch setting of the print job.

Lines/Page (Lines per Page)— The numbers in front of this status indicate the current lines per page setting of the print job.

Chars/Line (Characters per Line) — The numbers in front of this status indicate the current characters per line setting of the print job.

The bottom line on the Printer Control Panel is the status line discussed in Section V. The status line items are active if they are highlighted.

Printer Error Messages

The following tables provide information on the meaning of error check messages on the Printer Control Panel.

Table 7-1: Output Data Field Definitions

Output Data	Error Check	Error Message	Change Font	Change Setup
Invalid Code	ON	INVALID SCS ¹ CONTROL CODE ²		
Command # in Table 7-2	ON	INVALID SCS PARAMETER ³		
Command # in table 7-2	ON	EXCEPTION CONDITION ⁴		
EBCDIC value	ON	GRAPHIC CHECK ⁵		
Font number			ON	
Change Setup: 001 = manual 002 = tractor 003 = cut sheet				BL ON ON ON

- 1 SCS = System Network Architecture Character String
- 2 Invalid SCS Control Code—Invalid or unrecognized printer command received. Commands are listed in Table 7-2.
- 3 Invalid SCS Parameter — A printer command is received with an invalid parameter. For example, a command may be violating page boundaries.

Check your printer configuration both on the host and in IDEACFIG. They must match.
- 4 Exception Condition 1, 2, 3, 4 — A 5219 printer command is received with invalid parameters.
- 5 Graphic Check — unprintable character received.

If your printer configuration is correct, and you are still receiving an error message, contact your system administrator. If the system administrator cannot resolve the problem, call IDEA Technical Support for assistance and give them the number(s) or the error code(s) displayed.

Table 7-2: Printer Command Numbers

Number		Command
01	NL	New Line
02	CR	Carriage Return
03	LF	Line Feed
04	FF	Form Feed
05	PP	Print Position, Absolute Horizontal
06	PP	Print Position, Absolute Vertical
07	PP	Print Position, Relative Horizontal
08	PP	Print Position, Relative Vertical
09	TRN	Transparent
10	SCD	Set Character Distance
11	SLD	Set Line Density
12	SVF	Set Vertical Format
13	STAB	Set Horizontal Tab Stops
14	HT	Horizontal Tab
15	BUS	Begin Underscore
16	EUS	End Underscore
17	SPS	Superscript
18	SBS	Subscript
19	BOS	Begin Overstrike
20	EOS	End Overstrike
21	BS	Backspace
22	SHM	Set Horizontal Margins
23	JTF	Justify Text Field
24	SJM	Set Justify Mode
25	SSLD	Set Single Line Distance
26	[SHMI]	Set Horizontal Motion Index
27	[SVMI]	Set Vertical Motion Index
28	[STM]	Set Top Margin Error
29	[JT]	Justify Text
30	SIC	Set Initial Conditions
31	SFG	Set FID through GFID
32	SIL	Set Indent Level
33	RLM	Release Left Margin
34	SLS	Set Line Spacing
35	SPPS	Set Presentation Page Size
36	SVM	Set Vertical Margins
37	SPSU	Set Print Setup
38	RNL	Required New Line
39	SEA	Set Exception Action
40	SPACE	Space Command
41	PPM	Page Presentation Media (multibin printing)
42	STO	Set Text Orientation (portrait/landscape printing)

Printing Screens (Local Print and PrintScreen)

Use the PrintScreen function to copy the data displayed on the screen to a printer or disk file. Any serial or parallel printer attached to your PC or PS/2 can accept the screen data. With windows, only the screen for the active session is copied.

The keys used for the PrintScreen function are Shift-PrtSc on the PC, XT, and AT keyboards, and Shift-PgUp on the Enhanced keyboard.

When you press the PrintScreen key combination, the information displayed on your screen is sent to the location specified by the PRINT option on the Command Menu. The default is LPT1.

If a disk file was specified, each time PrintScreen is entered the new information is appended to data already in the file.

If the device or disk file is not accessible, the PrintScreen key does nothing.

The PrintScreen feature does not affect the Printer Control Panel. Use the non-emulated Print Screen key on your PC or PS/2.

You can also use the emulated Print key (F5 or PageUp) to print screens through your host. In this case, the host sends the printout either to its default system printer or to the printer you specified in a host command such as PRINTKEY. See your host operating system guide.

The size of the Print Screen file depends on the type of display and mode of display (regular or wide screen).

Display Model	Bytes or Characters
All 80 x 24	1968
3180 (80 x 24)	1968
3180 (132 x 27)	3618

NOTE

For printouts of wide screens (132 x 27), you must have a printer that supports wide carriage or 17 characters per inch.

Graphics screens (for example, from the BGU program) can only be sent to a printer. The printer must be set up for 5292 printing with GR5292.

Section VIII: Configuring User Defined Printers



This section explains how to configure a local PC or PS/2 printer to emulate a System 3X printer with IDEAComm 5251 or 5251/Plus.

For your convenience, IDEA has prepared configuration files for several widely used PC printers. If your printer is one of the choices on the INSTALL menu or the IDEACFIG Select PC Printer menu, all you need do is choose it. No additional configuring is required. If your PC printer is not on these menus, choose the User Defined option of IDEACFIG to set up the parameters you wish your printer to use.

More technical users should refer to the separate *Technical Reference Guide* for details on the System 3X commands that are supported.

Defining Your Own Printer

If your PC printer is one listed in the INSTALL program or the IDEACFIG Select PC Printer screen, the correct control sequences have already been configured for you in the IDEAcmm software. (The only exception is the 5292 printing.) Simply select your printer on that screen.

If your printer type is not listed, choose User Defined. Then when you have finished defining host sessions, go through the following steps:

1. Type 4 on the IDEACFIG Main Options menu to display the Printer Options menu below. If necessary, the program prompts: **Which printer session number do you want to change?** Enter the session number from the top of the screen. After this, an arrow marks the session number of the printer you are currently configuring.

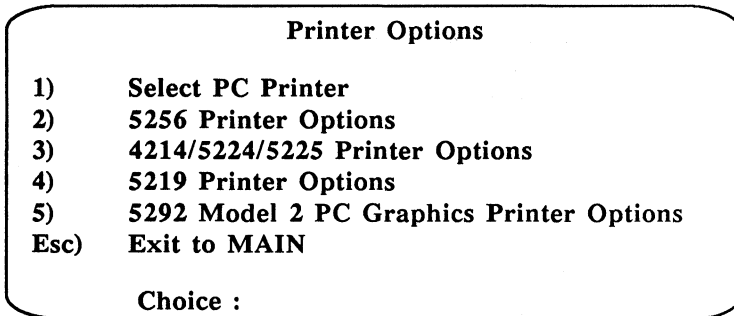

Figure 8-1: Printer Options

2. From the Printer Options menu, first choose Select PC Printer.
3. When you enter the Select PC Printer menu, you see a list similar to the following.

Attached Printer Model	Type
¹ NEC 3550 Spinwriter	parallel
¹ IBM 5216 Wheelprint	parallel
¹ HP LaserJet	serial (9600)
¹ Okidata Microliner 84	parallel
¹ IBM Color Printer	parallel
¹ IBM Quietwriter	parallel
¹ IBM Proprinter	parallel
² Epson FX-286e "IBM Emulation"	parallel
² Epson LQ-1000	parallel
¹ User Defined Printer	parallel

- ¹ Suitable for 5219 printer emulation.
- ² Suitable for 4214, 5224, and 5225 emulation.

Figure 8-2: Select PC Printer Menu

A highlighted bar is displayed on the currently configured printer. Be sure that the bar is on the printer you want and press Enter.

If your printer is close to one of those listed, choose the listed name and make changes. Otherwise, choose User Defined.

4. In answer to the prompt, enter the name of the PC printer you want to define (for example, MINE), and press Enter.
5. The next query is **Change printer interface?** The default printer interface is parallel. If your printer is serial, answer Y and, from the next screen, select the baud rate.

Note on Serial Port Parameters

When you choose a printer port of COM 1 or COM2, additional serial port settings are provided for the parameters listed. The serial port parameters as well as baud rate are initialized when TWINAX is loaded if a serial port is configured. These settings are

used because they are the values used by the majority of serial printers:

Parity: none
Stop bits: 1
Bits: 8

If the parameters used by your printer are different, you should select "serial (no baud)." TWINAX will not initialize the serial port parameters when it is first loaded. In this case, you must be sure that the port is already set up before loading TWINAX. You may do this by using the DOS MODE command (refer to your IBM DOS manual).

6. You return to the list of PC printers. Press Esc to return to the Printer Options Menu.
7. Choose option 2, 3, or 4, depending on which 5250 series printer you want to emulate. Refer to Defining a xxxx Printer in this section.
8. If you will emulate a 5292 model 2 terminal and want to print its graphics on your local PC printer, select option 5. Refer to Setting up a Local PC Printer to Print 5292 Model 2 Graphics in this section.
9. You are asked to save the new file either when you start to define a second file or when you return to the Main Configuration Menu:

Save changes to the xxx (Y/N)? Y <Enter>

If you type Y, your changes are saved in the PRINTER.CMD file. These changes will not be configured or saved in the actual configuration file, TWINAX4.UCM or TWINAX7.UCM, until you exit to DOS. Refer to Saving the Configuration at the end of Section IV. If you type N, your changes are not saved.

Defining a 5256 Printer

The 5256 printer offers basic printer features.

1. Follow steps 1 through 7 on the preceding pages.
2. From the Printer Options Menu, choose 2 (5256 Printer Options). The screen lists the entries used with a 5256 emulated printer:

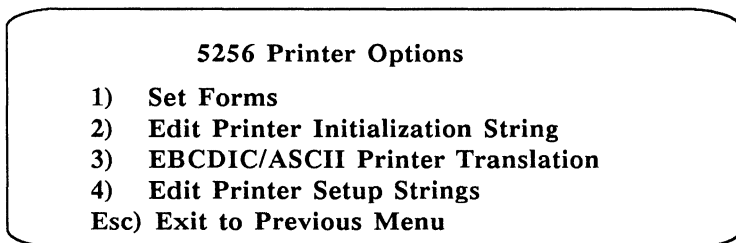

Figure 8-3: 5256 Printer Options Screen

These options are discussed with User Defined Features below.

Defining a 4214, 5224, or 5225 Printer

All of these printers provide flexibility. They allow you to determine such features as characters per inch, lines per page, and forms length, and they are capable of printing graphics. The IDEComm emulation software can take advantage of these printing features provided your PC printer is capable of generating them.

1. Follow steps 1 through 7 on pages 8-2 through 8-4.
2. From the Printer Options Menu, choose 3 (4214, 5224/5225 Printer Options). The screen displayed lists the entries used with a 4214, 5224, or 5225 emulated printer:

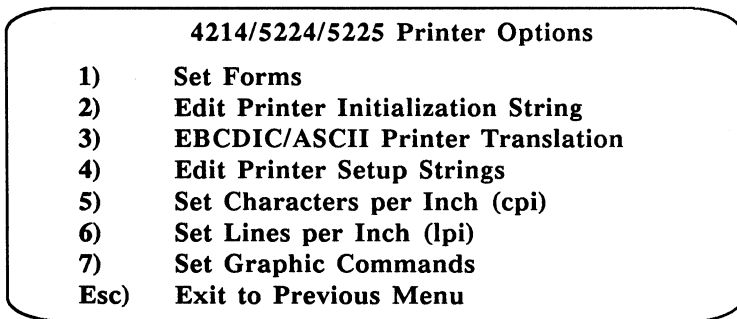

Figure 8-4: 4214/5224/5225 Printer Options Screen

These options are discussed with User Defined Features below.

Defining a 5219 Printer

By using the 5219 printer, you can customize such printer parameters as vertical motion index, subscript, half line feed, right margin. This printer is especially useful in text and word processing applications.

1. Follow steps 1 through 7 on pages 8-2 through 8-4.
2. From the Printer Options Menu, choose 4 (5219 Printer Options). The screen displayed lists the entries used with a 5219 emulated printer. Choose the printer type you wish to emulate from the Printer Options menu. A screen is displayed providing all possible choices for the particular type of emulated printer:

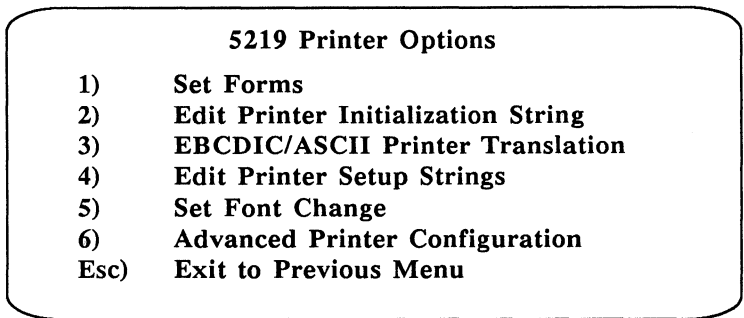

Figure 8-5: 5219 Printer Options Screen

These options are discussed with User Defined Features below.

Setting up a Local PC or PS/2 Printer to Print 5292 Model 2 Graphics

Using IDEACFIG, you can set up your attached PC printer to print color graphics. The only requirement is that you use a dot matrix PC printer with graphics support.

1. Follow steps 1 through 6 on pages 8-2 through 8-4.
2. From the IDEACFIG Printer Options Menu, select 5 (5292 Model 2 PC Graphics Printer Options). Then define options 1 through 5, referring to your printer manual for the required information.

5292 Model 2 PC Graphics Printer Options

- 1) Set 9 Lines Per Inch Spacing Command
 - 2) Set Graphics Control Command
 - 3) Set Color Selection Commands
 - 4) Type of Ribbon Monochrome
 - 5) Current Printer Port Used . . . LPT1
- Esc) Exit to Previous Menu

Figure 8-6: 5292 Graphics Printer Screen

1. **9 Lines per Inch Spacing Command**
Graphic printing requires 9 LPI printing. Enter the length and sequence of the command characters required to set the printer in 9 LPI mode.

For example, if the 9 LPI command sequence for your printer is **Esc&lnD**, you must convert all characters except **n** to hex. (The **n** is the number of lines per inch, which here must be

9.) Use the table at the end of Appendix A. First enter the number of characters or bytes in the command (05); then enter the command sequence in hex (1B 26 6C 09 44). The entire command sequence is:

05 1B 26 6C 09 44

2. Graphics Control Command

To print a graph, a PC printer must be set in Graphics Mode. Enter the command to put your printer in Graphics Mode.

If the graphics command for your printer is one of the options listed (Esc K, Esc L, Esc Y, or Esc Z), just type the respective number. TWINAX fills in the character length and command sequence automatically. Otherwise, select 5 (User Defined Graphics Command) and enter your printer's graphics command in hex.

Note that Esc K allows 132 column printing, while Esc L, Y, or Z allows 80 column printing.

3. Color Selection Commands

For selecting each color (yellow, red, blue, and black), enter the length of your printer's command and then the command sequence in hex.

4. Type of Ribbon

Use the space bar to select the type of printer ribbon (monochrome or color). Then press the Enter key to confirm your selection.

5. Current Printer Port Used

Use the space bar to select the port to which your printer is attached: COM1, COM2, LPT1, LPT2, or LPT3. Then press the Enter key to enter your selection.

6. Press the Escape key (Esc) to save your entries and return to the previous menu.

User Defined Features

These are features of each emulated printer type. If you use a printer type configured by IDEA, you do not need to change these features. To access them, see Defining a Sxxx Printer above.

Set Forms (Forms Length)

NOTE

If you do not fill in this screen, the forms length will be your printer's current setting.

Choose the printer type you wish to emulate from the Printer Options menu. A screen is displayed that provides all possible choices for the particular type of emulated printer. If the forms length choice is applicable to your printer type, it is displayed on this screen. (Refer to Defining Your Own Printer in this section.) Make sure that you have configured a host session for the printer you chose.

Choose Forms Length from the displayed screen and the Forms Length screen is displayed. As the cursor is moved, the message that corresponds to that byte is displayed in the status message area of the screen. Information about the type of command the printer uses is conveyed to the emulation software by the first four bytes or fields shown on this screen. The actual command that is sent to the printer is shown by the last eight bytes on this screen.

NOTE

IDEAcomm software is designed to work in lines per page. If your printer provides a forms length command that is specified in inches OR lines, enter lines. Do NOT enter inches.

A prompt is displayed in the message area of the screen when the cursor is placed over a particular field. The following is a list of the prompts displayed (and examples for determining the entry information) when the cursor is in the field listed.

Field #1 -- Command Length

Enter the number of characters in the command sequence including parameter value. Enter 00 for no command.

Example -- Determining Value of Field 1

To determine the value you must place in field 1, check the manual that came with your printer. Field 1 should contain the Set Page Length value (this may be referred to by other names by other printer manufacturers). Determine the number of characters in the command sequence, including the parameter value(s).

If, for example, `Esc C nm` is the Set Page Length command for your printer, you must first determine what `n` and `m` represent. In this example, `n` represents the page length in lines and `m` represents the page length in inches. The printer manual further indicates that if `n` is specified, the value of `m` must be zero or does not have to be entered. You should choose `n` since you must use page length in lines, so you would have 2 characters in the command sequence (ESC) and (C), and 1 character in the parameter value (`n`). Since this is a total of 3, you would enter 03 in field 1. If you wish to recognize `m` as zero (an option this example allows) you would have 2 characters in the command sequence (ESC) and (C), and 2 characters in the parameter value (`n` and `m`). In this case you would enter 04 in field 1.

Field #2 -- Parameter Value Length and Position

The first digit represents the parameter value length (1 for single byte and greater than 1 for string format). The second digit represents the position

in the command string for the start of the parameter value. Enter 00 for no parameter.

Example -- Determining Value of Field 2

The first digit in field 2 represents the parameter value character length. For the sequence ESC n m, enter 1 to indicate that a single byte is sent. If a string format is being sent, count the number of characters that make up the parameter value and enter that number (a number greater than 1).

To determine the value of the second digit in field 2, determine the location of the parameter value within the command/parameter sequence. In the sequence ESC C n m, n is in position 3.

Therefore, 3 is entered as the second digit of field 2.

Field #3 -- Base Value

Base parameter value (value for a parameter of 0). This number will be added to any parameter value which is sent to the printer. For most printers, it is 0.

Example -- Determining Value of Field 3

If your printer manual says that the printer uses a base parameter value you must enter that value in hexadecimal in field 3. For example, if the base parameter value is @, you would enter 40 Hex. This means that regardless of how many lines the host indicates, an additional 40 Hex is to be added to that figure. Therefore, if 3 lines are specified, an additional 40 Hex is added making a total of 43 Hex which is sent to the printer to specify 3 lines.

Field #4 -- Separator Character

Do not place an entry in this field. This field is not used.

Fields 5 through 12 -- Command Sequence

This is the command sequence from your printer's manual.

Example -- Determining Value of Fields 5 through 12

The information placed in fields 5 through 12 represents the actual command sequence

transmitted to the printer. Only fixed characters in the command sequence should be entered here: do not enter parameter values. All remaining fields should contain zeros. Use the table at the end of Appendix A to convert to hex. Using the command characters **ESC C n m** from the above example, and converting the fixed command characters ESC and C to Hex, you would enter 1B (for ESC) in field 5, and 43 (for C) in field 6. Since there are only two fixed command characters in this example, the remaining fields display zeros.

Edit Printer Initialization String

From the Printer Options Menu in the IDEACFIG program, choose the printer you are emulating. (Refer to Defining Your Own Printer in this section.) One of the options on the screen displayed is Edit Printer Initialization String.

Information entered in this option is sent to the printer when TWINAX is loaded. Placing printer commands in this menu allows you to put the printer into the mode of your choice automatically.

To delete an entry, move to the desired field using the cursor keys, then press the space bar. All fields to the right of the deleted field are shifted left.

Check your printer manual for the code of the command mode you wish to use. For example, if you want to set the printer for bi-directional mode, determine the parameters your printer requires to execute this command.

Suppose that your manual lists **ESC U n** as the command, and that the value of *n* can be 00, 01, 02, or 03. Each option offers a different print mode. However, 03 is set for auto bi-directional mode; therefore, you want to set *n* equal to 03. Next convert the command to hexadecimal. ESC is 1B Hex and U is 55 Hex. Starting at position zero on your screen enter the command: **1B 55 03**.

If you have a second command to enter, begin it in the next unused field. In this example, since you already used fields one, two, and three to enter the first command, the second command would begin in field four.

EBCDIC/ASCII Printer Translation Table

Refer to Section VI for information on altering the EBCDIC/ASCII printer translation table.

Edit Printer Setup Strings

This screen allows you to enter as many as four command strings that you may want to send to the PC printer from the Printer Control Panel described in Section VII.

Use your PC printer manual to determine the ASCII hex code for each command. Then enter each command on a separate line.

During emulation, you may use the **PC Command Strings** option on the Printer Control Panel to send one or more strings by number.

Set Characters per Inch

To configure the characters per inch parameters for your particular PC printer, select the printer you are emulating from the IDEACFIG program's Printer Options Menu. (Refer to Defining Your Own Printer in this section.) One of the options offered is Set Characters per Inch if it is available with your printer type.

Determining Characters Per Inch: Read the manual supplied with your printer to determine the sequence of characters needed to set the various modes your printer supports.

For example, if the CPI command sequence for your printer is `Esc&lnD`, you must convert all characters except `n` to hex. (The `n` is the number of lines per inch.) Use the table at the end of Appendix A. The hex command sequence for 9 lines per inch is then `1B 26 6C 09 44`).

You may find that there is no direct correlation to the density you need. In this case IDEA recommends that you use a mode that compresses a little more than the 10 or 15 characters per inch IBM uses. For example, use 17 CPI for 15. This way all the characters the host sends fit on one line.

The IDEA printer software detects the format command from the host, determines the effective characters per inch, and sends the sequence of characters from the list of options that best matches the requested density. If the list is empty or there is no entry for the character density requested within a range of 2 characters per inch, the command from the host is ignored.

Add Entry: Add Entry adds a new horizontal command. Type 1 (Add Entry). Type the number of characters per inch you wish entered and press ENTER. Notice that the information entered is displayed temporarily above the words Select Option. Type the count value (the number of characters in the command code) and press ENTER. Type the command sequence beginning with the first byte you want sent. When you press the ENTER key after typing the command sequence, the system automatically sorts the information by the number of characters per inch and displays the added entry in its proper position on the screen.

Delete Entry: Delete Entry allows you to erase a horizontal command. Type 2 (Delete Entry) and press ENTER. Type the number of the command you want to delete. When you press ENTER, the entry is deleted and the remaining entries are sorted and displayed in their proper positions.

Change Entry: Change Entry alters information already displayed on your screen. Type 3 (Change Entry) and press ENTER. Type the number of the command you want to alter and press ENTER. There are two ways of entering changes. You can press ENTER after each value is typed, or you can use the TAB key to enter new and unchanged values. If you use the TAB key, you could, for example, change the Chars Per Inch field, Count field, and one byte of the Command Sequence field. After altering the first byte of the Command field, if you press TAB, the new changes are saved as well as the bytes in the Command field that were not changed.

Set Lines per Inch

To configure the lines per inch parameters for your particular PC printer, choose the printer you are emulating from the Printer Options Menu in the IDEACFIG program. (Refer to Defining Your Own Printer in this section.) One of the options available on the screen displayed for that printer is Set Lines per Inch if it applies to your printer.

Determining Lines per Inch: Read the manual supplied with your printer to determine the sequence of characters needed to set the various modes your printer supports.

The IDEA printer software detects the format command from the host, determines the effective lines per inch, and sends the sequence of characters from the list of options that best matches the requested density. If the list is empty or there is no entry for the lines per inch requested within a range of 2 lines per inch, the command from the host is ignored.

Refer to the discussion of Set Characters per Inch on the preceding page for how to enter command sequences on the screen.

Add, Delete, Change Entry: Refer to the discussion of Set Characters per Inch on the preceding page for how to modify entries.

Set Graphics Command

To be able to emulate the graphics features of the 4214, 5224, or 5225 you must configure one host session as a printer and your PC printer must have the following capabilities:

1. The printer must be able to print graphics as a series of 8 vertical dots. Many dot matrix printers print in this way.

Note that printers that support raster graphics can not be used because they print graphics as a series of horizontal dots. An example of a raster printer is the Hewlett-Packard LaserJet™.

2. The printer must be able to print text and graphics on the same line.
3. The graphics command sequence supported by your printer must conform to the following format:

ESC x n1 n2 m1 m2 m3 ...

where:

- ESC = command byte 1
- x = command byte 2
- The total number of graphics characters printed equals n2 times 256 plus n1.
- The number of graphic data bytes (m1, m2, m3, ...) follows n2.

From the Printer Options Menu select 3 (4214/5224/5225 Printer Options). The screen displayed lists the Set Graphic Commands option along with other options available for these printers.

Check your printer manual for the correct graphics command. If the graphics command for your printer is one of the options listed (Esc K, Esc L, Esc Y, or Esc Z), just type the respective number

and TWINAX fills in the character length and command sequence automatically. Otherwise, select 5 (User Defined Graphics Command) and enter your printer's graphics command.

Note that Esc K allows 132 column printing, while Esc L, Y, or Z allows 80 column printing.

If you choose the User Defined Graphics Command on the Set Graphics Command Menu, a screen is displayed that provides information on the graphics command format. You are prompted to enter command byte 1. If, for example, command byte 1 is ESC, you would enter the hexadecimal value for ESC, which is 1B. The screen now prompts you to enter command byte 2. If, for example, command byte 2 is W, you would enter the hexadecimal value for W which is 57.

You can change or configure only command bytes 1 and 2 in the graphics command sequence.

Set Font Change

To use this feature, from the IDEACFIG Printer Options menu type 4 (5219 Printer Options). (Refer to Defining Your Own Printer in this section.)

This feature allows the emulation software to trap font change commands received from the host and send the appropriate escape sequences to the PC printer to enable it to print with the desired font.

A table of font change commands lists a maximum of 10 entries. Five entries at a time may be viewed. Use the arrow keys to view the next five entries or the previous five entries.

The font number is input in decimal and can be 01 to 255.

The font name can be a maximum of 16 characters.

The command sequence is a maximum of 30 decimal characters.

As you configure the Set Font Change menu, a prompt is displayed asking if you wish the printer to Stop on a font change so that you can change a font cartridge. If you select N, the Stop on Font Change is not active. If you select Y, when a font change is requested, the printer will go offline. You should change the font cartridge, then put the printer back online from the Printer Control Panel (refer to Printer Control Panel in Section VII).

Advanced 5219 Printer Configuration Commands

These commands are accessible from the 5219 Printer Options screen. Release 5.0 includes the following commands:

Superscript
Subscript
Reset WP Mode
Set Left Margin
Set Right Margin
Half Line Feed Forward
Half Line Feed Reverse
Set Horizontal Tab Stops
Justify Text Line
Begin Underscore
Reset Underscore Mode
Begin Overstrike Mode
Reset Overstrike Mode
Set Vertical Motion Index
Set Horizontal Motion Index
Superscript/Subscript Off
Bin #1 Select
Bin #2 Select
Bin #3 Select
Envelope Bin Select
Rotate Paper 0 (Portrait)
Rotate Paper 90 (Landscape)

Use the PgDn and PgUp keys to view all of the options.

To emulate the features of a 5219 printer, your PC printer should have the following features:

1. Printer command strings must not be more than 8 bytes long.
2. Parameter values in a command string may be in single byte format or in decimal character string format, but only 1 parameter value may be in a command string except for the Set Horizontal Tab Stops command.

-
3. Printer command strings must be capable of including parameters. For example, a printer whose set left margin command is “set margin at current position” cannot be used. The command string must be able to support a format such as “set margin at column n.”
 4. For full 5219 printer emulation the printer must support the following commands:
 - Backspace
 - Forms Length
 - Superscript or Half Line Feed Reverse
 - Subscript or Half Line Feed Forward
 - Set Left Margin
 - Set Right Margin
 - Set Vertical Motion Index
 - Set Horizontal Motion Index

Before you begin filling in the actual menu on your PC or PS/2 screen, make sure you have all the information you require. Consult your printer manual for the required command sequences for the word processing functions you wish to perform.

Keep in mind the following list of various word processing functions that may be performed and the necessary printer command sequences that must be configured.

The command sequences entered on the Advanced Printer Configuration menu are configured in TWINAX7.UCM or TWINAX4.UCM. They are stored in the PRINTER.CMD file and will automatically load when you select that printer in the future.

Table 8-1: Printer Commands Needed for 5219 Word Processing

Function	Printer Commands Required
Horizontal Margins	Set Left and Right Margins.
Vertical Margins	Set Vertical Motion Index.
Variable Forms Length	Set Forms Length.
Tab Stops*	If the printer supports tab stops, then Set Horizontal Tab Stops must be configured. Otherwise the emulation software will maintain tab stops.
Variable CPI	Set Horizontal Motion Index.
Variable LPI	Set Vertical Motion Index.
Superscripting*	Superscript or Half Line Feed Reverse.
Subscripting*	Subscript or Half Line Feed Reverse.
Text Justification*	Set Left and Right Margins. If the printer supports text justification, then Justify Text Line must be configured to enable justification and Reset Word Processing Mode to disable justification. If this is not done, the emulation software will justify text by using the Set Horizontal Motion Index command.
Underscoring*	If the printer supports underscore, then Begin Underscore Mode and Reset Underscore Mode must be configured. The printer must support backspace if it does not support underscore.
Overstrike/Highlight*	If the printer supports overstrike, then Begin Overstrike Mode and Reset Overstrike Mode must be configured. The printer must support backspace if it does not support overstrike.
* Optional	NOTE
Generally the subscript or superscript command actually performs a half line feed forward and may be issued continuously to advance down the paper. If your printer operates this way, then you do not need to configure the subscript/superscript OFF command. If your printer operates so that a subscript command brings the print position to the subscript position, then you will need to configure the subscript/superscript OFF command as well as the subscript and superscript commands.	

Filling In the Advanced Printer Options Screen

From the IDEACFIG Printer Options screen type 4 (5219 Printer Options). The screen displayed lists the Advanced Printer Configuration option along with others available for 5219 emulated printers.

Highlighted messages are displayed in the status message area of the screen when the cursor is moved into a particular field. The following text lists the field and the message displayed.

The first four fields in the Advanced Printer Configuration menu convey the type of command. The next eight fields convey the actual command. Be sure that you fill in all applicable fields using hexadecimal.

Field #1 -- Command Sequence Length

Enter the number of characters in the command sequence including any parameter values. Enter 00 if your printer does not support the command you are trying to configure.

Example: Set Horizontal Tabs — This command is used to set tab stop positions. When determining the parameter value for this command, be careful. The parameter value may consist of multiple digits with each digit being counted as a separate value. For example, to set a single tab stop, your printer may require a sequence such as the following:

ESC HT n1 n2 n3 CR

where:

ESC HT = Load Horizontal Tabs command
(number of command characters = 2)

n1 n2 n3 = a 3-digit number for a single tab stop

CR = End of command sequence (number of
command characters = 1)

The total number of command and parameter value

characters in this command is 6. Therefore, you would type 06 in Field 1.

Field # 2 -- Parameter Value Length and Position

The first digit represents the length of the parameter value in the command sequence (1 for a single byte value and greater than 1 if specified in string format). The second digit represents the starting position in the command sequence for the parameter value. Notice that not every command has a parameter value to enter. For example, Superscript and Subscript commands have command sequences but no parameter values.

Using the example Set Horizontal Tabs previously used for the Field 1 entry, the Parameter Value Length and Position are determined as follows:

ESC HT n1 n2 n3 CR

Where:

ESC HT = Load Horizontal Tabs command
(number of command characters = 2)

n1 n2 n3 = a 3 digit number for a single tab stop

CR = End of command sequence (number of command characters = 1)

The tab stop position consists of a 3-digit number. Therefore, the first digit of field #2 is 3.

The parameter value in this example begins at position 3 because it comes after ESC HT which take up positions 1 and 2. Therefore, the second digit in Field #2 is 3.

In this example, you would enter 33 in Field 2.

FIELD #3 -- Base Parameter Value

Base parameter value (value for a parameter of 0). This is a number that is added to any parameter value before the command sequence is sent to the printer. For most printers, it is 0.

For example, your printer may have a Set Left Margin command specified as:

ESC U n

where **n** = 40 Hex for a flush left margin.

In this example 40 Hex is entered in Field #3. If a left margin setting of column 3 is desired, 40 Hex is still entered in field 3, but that value is added to the number entered elsewhere as your desired margin (in this example the number is 3) making a total of 43 Hex which is sent to the printer to specify a margin setting at column 3.

The base value is always entered in this field, regardless of the total desired value.

Field #4 -- Separator Character or Motion Index Units

Separator character between multiple parameter values. Enter 00 for no separator value. This field is used for a separator character only as part of the Set Horizontal Tabs command. As an example, some printers require that tab stop positions in the command sequence be separated by a comma (,). You would enter the ASCII value for a comma, which is 2C hex.

Example: Set Horizontal Motion Index

To determine this value, read your printer specification manual. Look for Horizontal Motion Index, HMI or the equivalent. As an example, if your manual shows 1/120 inch, you must determine the Hex value for 120. Since the Hex value for 120 is 78 Hex, you enter 78 in this field.

Fields #5 through #12 -- Printer Command Sequence

Enter all of the fixed values in the command sequence. All parameter value positions in the command sequence should be filled in with zeros if not used. Examples are in the Set Forms Length discussion earlier in this section.

Section IX:

File Transfer and Virtual Disk



IDEA's TWINAX software allows IDEAComm to be used with IBM System 3X file transfers, including the following from International Business Machines Corporation:

- IBM PC Support/36 (5727-WSI)
- IBM PC Support/38 (5714-PC1)

The IDEAComm software is also compatible with many third party file transfer packages such as:

- Decision Link by Laguna Laboratories, Inc.
- Smart Link by G.E. Software International
- ETU by Emerald, Inc.
- Omnilink by On-line Software International, Inc.

Prerequisites

System 3X Level:

PC Support must be installed on the host.

Microcomputer Level: Configuring a Host Session with IBM Transfer Capability

With IDEAComm 5251 (the 4 LU product), when you configure your host display sessions with INSTALL or IDEACFIG, be sure to configure one of them for IBM compatibility by answering YES to the IBM transfer package question. This allows you to use this host session with an IBM file transfer package. See Section IV.

System 36 Examples

Assume that you are working with a PC or PS/2 with one diskette drive and one hard disk. The virtual diskette declared is A, and the emulation software is in subdirectory TWINAX of the hard disk C.

Initial Installation – SSP Release 5.1

IBM's file transfer programs, PC Support/36 and PC Support/38, require that software be installed on the System 3X and on the PC or PS/2. In Release 5.1 the files necessary for PC Support/36 are shipped on a diskette by IBM.

1. Insert the IBM diskette in drive A and type:
INSTALL <Enter>.
2. Choose the option 'Emulation.' In answer to the prompt, specify the fixed disk and drive directory on the PC to which files will be sent. (The default is C:\PCS36.)
3. **INSTALL** displays a menu describing the four emulation programs of IBM and proposes option 5 (Other emulation program). Select option 5.
4. **INSTALL** then asks the name of the emulation program. Answer **TWINAX.EXE** (be sure to type in the .EXE).
5. **INSTALL** asks for any parameters. Enter **R** with release 5.0 or higher of IDEAComm; with release 4.0, enter **G/R**.

Initial Installation – SSP Release 5.0

In Release 5.0 the files necessary for your microcomputer are shipped on an 8 inch diskette by IBM. You must transfer them to the System 3X host, and then download them to the PC or PS/2.

This software creates on the host system a virtual diskette of 180 KB called #IWPCLD1 and a virtual

disk of 2780 KB called #IWPCLD2. The virtual diskette will contain the programs that the PC or PS/2 must use to access the PC Support programs located on the virtual disk.

You should transfer the programs on the virtual diskette to the PC or PS/2 by declaring an extra or "virtual" diskette on the PC or PS/2, using IDEA's diskette driver ADDVDSK.

1. Run ADDVDSK (described at the end of this section).
2. Start emulation (TWINAX) and log on to the system, so that you see the main menu.
3. On the command entry line, type:
IWDOWNL.

(Be sure that ADDVDSK has been run.)

4. An operating menu appears. Enter Shift-Shift or Alt-Esc to return to DOS.
5. From drive C: go to A: (the virtual diskette) and enter **DIR** <Enter>. Compare the list of files that appears with the IBM documentation.
6. From the virtual drive enter: **COPYLINK C: TWINAX**. This batch procedure copies to your disk subdirectory the files necessary for PC Support/36, including the virtual disk driver VDSK.SYS, which will be installed automatically in the root directory.
7. Once COPYLINK is ended, return to drive C: and enter Shift-Shift to return to emulation. Sign off the session, return to the sign-on screen, exit emulation, and reboot the system. Watch the screen to assure that the Support/3X virtual disk facility loads on boot-up.

Everyday Startup (5.0 and 5.1)

1. With Release 5.0, reboot the PC, which loads the virtual disk driver, and go into emulation with **TWINAX** <Enter>.

With Release 5.1, instead of rebooting, run **LINK36**, which loads emulation.

2. Go to the principal help menu (**MAIN**), then return to DOS with **Shift-Shift**.
3. From DOS on drive C in the directory where you copied your PC Support files, enter: **LINK36** <Enter>.
4. The router is loaded on the PC side; the prompt **I>** appears instead of **C>**. You are now in communication with the virtual disk **#IWPCLD2**, which contains all the programs necessary for Support/36.
5. Copy if necessary all the programs onto your hard disk (see IBM documentation).
6. Before leaving PC Support/36, remember to stop the router with the command **STOPRTR** or **ENDRTR Y,FORCE** <Enter>.

System 38 Example

Assume that you are working with a PC or PS/2 with one diskette drive and one hard disk. The virtual diskette declared is A, and the emulation software is in subdirectory TWINAX of the hard disk C.

Initial Installation -- Release 8.0

IBM's file transfer programs, PC Support/36 and PC Support/38, require that software be installed on the System 3X and on the PC or PS/2.

This software creates on the host system a virtual diskette of 180 KB and a virtual disk of 2780 KB called, respectively, QIWPCLD1 and QIWPCLD2. The virtual diskette will contain the programs that the PC or PS/2 must use to access the PC Support programs located on the virtual disk.

You should transfer the programs on the virtual diskette to the PC or PS/2 by declaring an extra, or "virtual" diskette on the PC or PS/2, using the IDEA diskette driver ADDVDSK.

1. From DOS, run ADDVDSK (see the end of this section).
2. Start emulation (TWINAX) and enter the Command Entry display with command 3 from the Programmer's Menu.
3. Be sure that ADDVDSK has been run. Type: **ADDLIBLE QIWS <Enter>**. You should see either the message **library list changed** or **QIWS is already added**.
4. Type: **CALL QIWDOWNL**. The screen displays directions relevant to IBM's emulation software.
5. Enter Shift-Shift to return to DOS. You should see the prompt **C>**.

-
6. From drive C: go to A: (the virtual diskette) and enter **DIR** <Enter>. (There should not be a diskette in drive A.) You will hear clicking until all files are listed. Compare the list of files that appears with the IBM documentation.
 7. If you wish to install your PC Support files in a particular directory on the hard disk, return to C: and log on to the intended target directory, then return to A: From the virtual drive A: enter: **COPYLINK C:TWINAX**. This batch procedure copies to your disk the files necessary for daily use of PC Support/36, including the virtual disk driver **VDSK.SYS**, which will be installed automatically in the boot directory and entered in the file **CONFIG.SYS**. This should be in one of the following forms:

DEVICE = VDSK.SYS

DEVICE = FSDD.SYS (for shared folders)

DEVICE = FSDDX.SYS (for shared folders)

Note

Instead of running **COPYLINK**, you may use the DOS command **COPY *.*** to copy all files into the target directory for later use. Then hot key back to the emulation session. If you do this, however, you must copy the file **VDSK.SYS**, **FSDD.SYS**, or **FSDDX.SYS** to the root directory and add it to **CONFIG.SYS**.

8. Once **COPYLINK** is ended, return to drive C: and enter Shift-Shift to return to emulation. Sign off from the session. Reboot the PC before using PC Support.

Everyday Startup

1. Go into emulation with **TWINAX** <Enter>.
2. Log onto the 38. Go to the command entry menu with Command 3 from the Programmer's Menu.

-
3. Type: **ADDLIBLE QIWS** <Enter>. You should see either the message **library list changed** or **QIWS is already added**.
 4. Return to DOS with Shift-Shift.
 5. From DOS on drive C, enter: **LINK38** <Enter>.
 6. The router is loaded on the PC side, then the screen changes into emulation and the procedure **BGNIWSSRV** appears on the screen, starting the router on the S38. The screen returns to DOS with the prompt **I>** instead of **C>**. You are now in communication with the virtual disk **#IWPCLD2**, which contains all the programs necessary for Support/38.

Note

At the loading of the router (**BGNIWSSRV** called automatically from **LINK38**), you may see the error message:

**IWS0018 - Object QHRINIT of type
*DTAARA not found**

To resolve this problem, invoke the creation of this object with the command: **/CALL QHRINITX.QIWS**. The 38 router will start normally.

7. Copy if necessary all the programs onto your hard disk (see the IBM documentation).
8. Before leaving PC Support/38, remember to stop the router with the command **ENDRTR Y,FORCE** <Enter>.

Note

On a System/38, IDEA recommends adding the library containing PC Support/38 to the list of libraries emulated by the

microcomputer. This avoids using the command **ADDLIBLE QIWS** before each use of PC Support and permits future Program Changes to be applied to PC Support/38 if necessary.

IBM File Transfers

For information on using IBM file transfers, refer to the appropriate IBM manual. If the IBM file transfer you have uses a virtual disk, read the rest of this section.

The IDEA Virtual Disk Driver (ADDVDSK)

Setting up the Virtual Disk Driver

Some IBM file transfers make use of a virtual drive. IDEA provides access to this feature in both the IDEACFIG program on the User Interface Options screen, and in emulation from the VIRTUAL option on the Command Menu. Both screens include the following three items:

Virtual Floppy Drive

You may select drive A through D as a virtual drive.

If you are using an AT, configure Drive A as the virtual drive.

Virtual Floppy Host Session

With IDEAcmm 5251 (the 4 LU product), this must be the host session configured with IBM transfer package capability on the Host Session Setup screen.

Virtual Floppy Timeout

Host computers vary significantly in the amount of time they take to respond to requests from users.

Therefore you can set the timeout to correspond with the performance of the connected host. You are allowed to change a value for this entry only if a virtual drive is configured.

NOTE

If the timeout interval set is long and transfer is not executing correctly, you are not able to detect this condition until the timeout expires. If the timeout interval set is too short, false timeouts may occur that reduce the effectiveness of the transfer.

Switch Settings on the IBM PC Mother Board

If you have a one diskette system and no hard disk, you can change the switch settings in your PC or XT to configure another drive (B). Refer to your IBM Guide to Operations manual for information on changing IBM mother board switch settings.

Do not use drive B on the AT as your virtual drive.

Running the IDEA Virtual Disk Driver Program

If your IBM file transfer program uses a virtual disk, first use IDEACFIG or the VIRTUAL command from the Command Menu to specify the session number and drive for the virtual disk. Then, to run the virtual disk driver, from DOS enter:

ADDVDSK <Enter>

One of the following messages should appear:

- **TWINAX virtual disk driver installed**
The virtual disk driver program has been loaded and will handle requests to the drive indicated as the virtual drive in IDEACFIG.
- **TWINAX not active, virtual disk driver not installed**

You must load emulation with the command **TWINAX** before loading the virtual disk driver.

- **TWINAX virtual disk driver already installed**
The virtual disk driver program has already been installed.

This program must be installed every time you load **TWINAX**. You can include it in a batch file similar to the following:

```
TWINAX R  
ADDVDSK
```

Using the IDEA Virtual Drive

ADDVDSK emulates software commands usually performed on disk drives. For example, you can use the DOS commands **COPY**, **TYPE**, or **DIR** with the virtual drive. **ADDVDSK** intercepts the software commands, relays them to the IBM System 3X host computer and returns the host's results to the PC or PS/2. To the PC or PS/2, the software resembles a disk drive.

When anything goes through the virtual drive you hear intermittent clicks. These let you know that your virtual drive is being accessed.

ADDVDSK has shared access to a microcomputer drive when you are in emulation mode and file transfer is running on the host. With a two diskette system or a hard disk system, specify drive **B** and **ADDVDSK** intercepts the references to drive **B** and checks to determine if the host is ready to accept them. If the host is not ready, the commands are passed on to the real diskette drive. In this way, you can share a drive between the host and your microcomputer.

Do not use drive **B** on the AT as your virtual drive.

Use the command **REMOVDSK** to remove the virtual disk software from memory when you no longer need it.

Appendix A: Troubleshooting, Error Messages, and Charts



Overview

This section includes:

- A list of symptoms and corrective action for troubleshooting IDEComm
- Diagnostics programs
- Error messages
- Installation and cabling of remote controllers
- ASCII hex codes for display and printer characters

Troubleshooting Tips

If you are having difficulty using the emulated printer, display, or file transfer, it may be due to the configuration of the IDEComm hardware or software. The following text provides a description of symptoms and corrective action.

Display

1. Your emulated display is normal but one or several workstations down line from the microcomputer are offline.
 - Check the termination switch on the IDEComm card as well as any external terminators on the TWINAX cable run. The cable run should be terminated only at the end of the run.

-
- Verify the station address that each device is using. Each station address must be unique.
2. The cursor remains in the top left corner of the display. The letters SA are displayed in the bottom left corner of the screen.
- Verify that the station address for this device is a valid station address.
 - From the system console check to be sure you are varied on.
3. The cursor remains in the top right corner of the screen. The letters SA are flashing or are not displayed.
- Verify that the TWINAX card is terminated correctly.
 - Verify that the IDEComm TWINAX cable locking mechanism is correctly connected to the TWINAX run. Also check the other end of the connection. The mounting screws of the 15-pin connector should be tightened with a screwdriver.
 - Swap the IDEComm twinaxial cable and connector with a known good cable and connector.
 - Verify that this junction of the TWINAX allows another device to come up successfully.
 - Verify the station address.
4. The cursor is displayed in the middle of an otherwise blank screen.
- Verify the IDEComm board addresses on both Switch Bank 1 (I/O Address) and 2 (Memory Address), if applicable. The
-

switch settings must match the settings configured in IDEACFIG.

5. Graphics characters blinking and non-blinking cover the screen as soon as you go into emulation.
 - Turn off the PC or PS/2 and check to be sure that the IDEComm card is seated correctly.
 - Turn off the PC or PS/2 and remove the IDEComm card to verify switch bank addresses on both switch bank 1 (I/O Address) and 2 (Memory Address). The switch settings must match the settings configured in IDEACFIG.
6. Snow appears on the color monitor during emulation.
 - If you are using an IBM color display adapter, make sure the Color Screen Handling Option in IDEACFIG is set for IBM.
7. When you send printed output to the display, such as CATALOG or LISTLIBER, there is a display station error.
 - The host may have this session configured as a 3180 (wide screen), while your microcomputer may have it configured as another display type.
8. You are using a monochrome monitor and an IBM color display adapter, and your screen display is not crisp and clear.
 - Run the TWINAX diagnostic program described in this appendix.
 - Make sure Color Attribute mapping in the IDEACFIG Display Options menu is set to monochrome.

9. The words NO LUs CONFIGURED, TWINAX ABORTED appears on your screen.

- No host session (LU) is configured in IDEACFIG; check IDEACFIG for a host session.
- Check to see if the device and address or the configured host session and address are being used by another workstation.

Windows

1. You configured windows, but when you press Ctrl-W no windows appear.
 - Use the Command Menu to check that your current host session (LU) is one of the windows configured.

Virtual Disk

1. You cannot access the Virtual Disk.
 - Verify Switch #7 and #8 settings on the IBM PC mother board.
 - Verify that the virtual disk is configured correctly in IDEACFIG and that you are at the main menu of file transfer before hot keying to DOS to use the virtual disk.
2. Virtual disk appears to be configured correctly; however, DISK ERROR READING message occurs while you are using the virtual disk.
 - Increase the timeout value, using IDEACFIG or the VIRTUAL command from the Command Menu in emulation.

Printer

1. The emulated printer does not print.
 - Verify that there is a printer configured in IDEACFIG, and that the station address is valid with the host.
 - The default parameters send print requests to LPT1. If your printer is not set up to use LPT1, you must configure it in IDEACFIG (see Section IV).
 - Verify that the printer prints locally (from DOS, press Shift PrtSc) before running the TWINAX diagnostic program (refer to TWINAX Diagnostic Program in this appendix).
 - Go to the Printer Control Panel. (Press CTRL-L to toggle between host sessions.) Look at the status. Both READY and PC PRINTER STATUS should be ON.
 - Verify that the PC printer is online by checking the online status light on the front of the printer.
 - Use the test option on the Printer Control Panel screen.
 - Verify that the print job is being routed to the correct printer.
 - Run the System 3X Test Request diagnostic program.
2. The emulated printer does not print correctly.
 - If you are not using one of the printers configured by IDEA, you may have entered incorrect control characters in the IDEACFIG emulation program. Consult your printer manual.

-
- Verify that the printer chosen in IDEACFIG matches the printer physically attached at that address.
3. Superscript and subscript printing do not appear to work correctly.
- Verify that the printer is configured as a 5219 both on the host and in IDEACFIG.
 - Verify that subscript/superscript or half line feed forward/reverse commands are configured in the Advanced Printer Configuration menu in IDEACFIG.
 - Run the Printer Control Panel printer test. If “superscript” seems to be printed correctly but the words “normal” and “subscript” appear on the same line, then your printer may support an absolute subscript and superscript position mode. If this is the case, your printer will have a command string called Set Subscript/Superscript OFF command. This command should be configured for the superscript/subscript OFF command in the Advanced Printer Configuration menu in IDEACFIG.
4. On the HP LaserJet series, the top or bottom two lines do not print.
- The IDEA printer file for this series sets the top line to 0 in the initialization string. If possible, you should allow more margin at the top of the page. Otherwise, change the initialization string for this printer file to all zeros. See Section VIII.

Printer Diagnostics

The Printer Tests from the Control Panel

When the Test PC Printer option is chosen, the host is checked to see if data is being transmitted. If nothing is being transmitted, the host printer is shut off.

As this diagnostic is executing, the status indicators on the Printer Control Panel screen reflect the current status.

If you wish to terminate an active test, press any key after the Select Test message is displayed. When the test mode is exited, the host printer Ready status is returned to the state it held prior to executing this test.

Since there are several System 3X printer types, the output that appears on the printer depends on which of the types is configured. Sample outputs are shown on the following pages. The following disk files must be present in the directory with TWINAX:

P5256.TST

P522X.TST (for 5224/5225 emulation)

P5219.TST

```

1          IDEAcComm 5251 - 5224/5225 Printer Diagnostic 1
2          Version 1.00 2
3
4          IIIIIIIIIIIIIIIIIIIIIIIIIIIIIIIIIIIIIIIIIIIIIIIIIIIIIIIIIIIIIII 4
5          II 5
6          III DDDDDD EEEEEEE AA II 6
7          I D D D E A A II 7
8          I D D D E A A II 8
9          I D D E EEEEE AAAAAAAA II 9
10         I D D D E A A II 10
11         I D D E A A II 11
12         III DDDDDD EEEEEEE A A II 12
13         II 13
14        IIIIIIIIIIIIIIIIIIIIIIIIIIIIIIIIIIIIIIIIIIIIIIIIIIIIIIIIIIIII 14
15
16          The following block of text is printed at 10 cpl and 6 lpi. 16
17
18 ABCDEFGHIJKLMNOPQRSTUVWXYZ 0123456789 #$%&(+)-/*\<>{|} abcdefghijklmn 18
19 BCDEFGHIJKLMNOPQRSTUVWXYZ 0123456789 #$%&(+)-/*\<>{|} abcdefghijklmno 19
20 CDEFGHIJKLMNOPQRSTUVWXYZ 0123456789 #$%&(+)-/*\<>{|} abcdefghijklmnop 20
21 DEFGHIJKLMNOPQRSTUVWXYZ 0123456789 #$%&(+)-/*\<>{|} abcdefghijklmnopq 21
22 EFGHIJKLMNOPQRSTUVWXYZ 0123456789 #$%&(+)-/*\<>{|} abcdefghijklmnopqr 22
23 FGHIJKLMNOPQRSTUVWXYZ 0123456789 #$%&(+)-/*\<>{|} abcdefghijklmnopqrs 23
24 GHIJKLMNOPQRSTUVWXYZ 0123456789 #$%&(+)-/*\<>{|} abcdefghijklmnopqrst 24
25 HIJKLMNOPQRSTUVWXYZ 0123456789 #$%&(+)-/*\<>{|} abcdefghijklmnopqrstu 25
26 IJKLMNOPQRSTUVWXYZ 0123456789 #$%&(+)-/*\<>{|} abcdefghijklmnopqrstuv 26
27 JKLMNOPQRSTUVWXYZ 0123456789 #$%&(+)-/*\<>{|} abcdefghijklmnopqrstuvw 27
28 KLMNOPQRSTUVWXYZ 0123456789 #$%&(+)-/*\<>{|} abcdefghijklmnopqrstuvwx 28
29 LMNOPQRSTUVWXYZ 0123456789 #$%&(+)-/*\<>{|} abcdefghijklmnopqrstuvwxy 29
30
31          The following block of text is printed at 12 cpi and 8 lpi. 31
32          Line numbers should be printed at the end of the line. 32
33
34 ABCDEFGHIJKLMNOPQRSTUVWXYZ 0123456789 #$%&(+)-/*\<>{|} abcdefghijklmnopqrstuvwxyz AB 34
35 BCDEFGHIJKLMNOPQRSTUVWXYZ 0123456789 #$%&(+)-/*\<>{|} abcdefghijklmnopqrstuvwxyz ABC 35
36 CDEFGHIJKLMNOPQRSTUVWXYZ 0123456789 #$%&(+)-/*\<>{|} abcdefghijklmnopqrstuvwxyz ABCD 36
37 DEFGHIJKLMNOPQRSTUVWXYZ 0123456789 #$%&(+)-/*\<>{|} abcdefghijklmnopqrstuvwxyz ABCDE 37
38 EFGHIJKLMNOPQRSTUVWXYZ 0123456789 #$%&(+)-/*\<>{|} abcdefghijklmnopqrstuvwxyz ABCDEF 38
39 FGHIJKLMNOPQRSTUVWXYZ 0123456789 #$%&(+)-/*\<>{|} abcdefghijklmnopqrstuvwxyz ABCDEFG 39
40 GHIJKLMNOPQRSTUVWXYZ 0123456789 #$%&(+)-/*\<>{|} abcdefghijklmnopqrstuvwxyz ABCDEFGH 40
41 HIJKLMNOPQRSTUVWXYZ 0123456789 #$%&(+)-/*\<>{|} abcdefghijklmnopqrstuvwxyz ABCDEFGHI 41
42 IJKLMNOPQRSTUVWXYZ 0123456789 #$%&(+)-/*\<>{|} abcdefghijklmnopqrstuvwxyz ABCDEFGHIJ 42
43 JKLMNOPQRSTUVWXYZ 0123456789 #$%&(+)-/*\<>{|} abcdefghijklmnopqrstuvwxyz ABCDEFGHIJK 43
44
45          The following block of text is printed at 15 cpi and 6 lpi. 45
46          Line numbers should be printed at the end of the line. 46
47
48 ABCDEFGHIJKLMNOPQRSTUVWXYZ 0123456789 #$%&(+)-/*\<>{|} abcdefghijklmnopqrstuvwxyz ABCDEFGHIJKLMNOPQRSTUVWXYZ 48
49 BCDEFGHIJKLMNOPQRSTUVWXYZ 0123456789 #$%&(+)-/*\<>{|} abcdefghijklmnopqrstuvwxyz ABCDEFGHIJKLMNOPQRSTUVWXYZ 49
50 CDEFGHIJKLMNOPQRSTUVWXYZ 0123456789 #$%&(+)-/*\<>{|} abcdefghijklmnopqrstuvwxyz ABCDEFGHIJKLMNOPQRSTUVWXYZ 50
51 DEFGHIJKLMNOPQRSTUVWXYZ 0123456789 #$%&(+)-/*\<>{|} abcdefghijklmnopqrstuvwxyz ABCDEFGHIJKLMNOPQRSTUVWXYZ 0 51
52 EFGHIJKLMNOPQRSTUVWXYZ 0123456789 #$%&(+)-/*\<>{|} abcdefghijklmnopqrstuvwxyz ABCDEFGHIJKLMNOPQRSTUVWXYZ 01 52
53 FGHIJKLMNOPQRSTUVWXYZ 0123456789 #$%&(+)-/*\<>{|} abcdefghijklmnopqrstuvwxyz ABCDEFGHIJKLMNOPQRSTUVWXYZ 01 53
54 GHIJKLMNOPQRSTUVWXYZ 0123456789 #$%&(+)-/*\<>{|} abcdefghijklmnopqrstuvwxyz ABCDEFGHIJKLMNOPQRSTUVWXYZ 0123 54
55 HIJKLMNOPQRSTUVWXYZ 0123456789 #$%&(+)-/*\<>{|} abcdefghijklmnopqrstuvwxyz ABCDEFGHIJKLMNOPQRSTUVWXYZ 01234 55
56 IJKLMNOPQRSTUVWXYZ 0123456789 #$%&(+)-/*\<>{|} abcdefghijklmnopqrstuvwxyz ABCDEFGHIJKLMNOPQRSTUVWXYZ 012345 56
57 JKLMNOPQRSTUVWXYZ 0123456789 #$%&(+)-/*\<>{|} abcdefghijklmnopqrstuvwxyz ABCDEFGHIJKLMNOPQRSTUVWXYZ 0123456 57
58 KLMNOPQRSTUVWXYZ 0123456789 #$%&(+)-/*\<>{|} abcdefghijklmnopqrstuvwxyz ABCDEFGHIJKLMNOPQRSTUVWXYZ 01234567 58
59 LMNOPQRSTUVWXYZ 0123456789 #$%&(+)-/*\<>{|} abcdefghijklmnopqrstuvwxyz ABCDEFGHIJKLMNOPQRSTUVWXYZ 012345678 59
60          THIS IS THE LAST LINE 60

```

Figure A-2: 5224/5225 Printer Test Output

If you are using a 5224/5225 printer with graphics capability, a printer graphics test is run. The following message and graphics pattern should be printed.

Note that if your 5224/5225 is not set up for graphics capability, the following message is printed plus the line of stars, but the graphic box and the word IDEA are not printed.

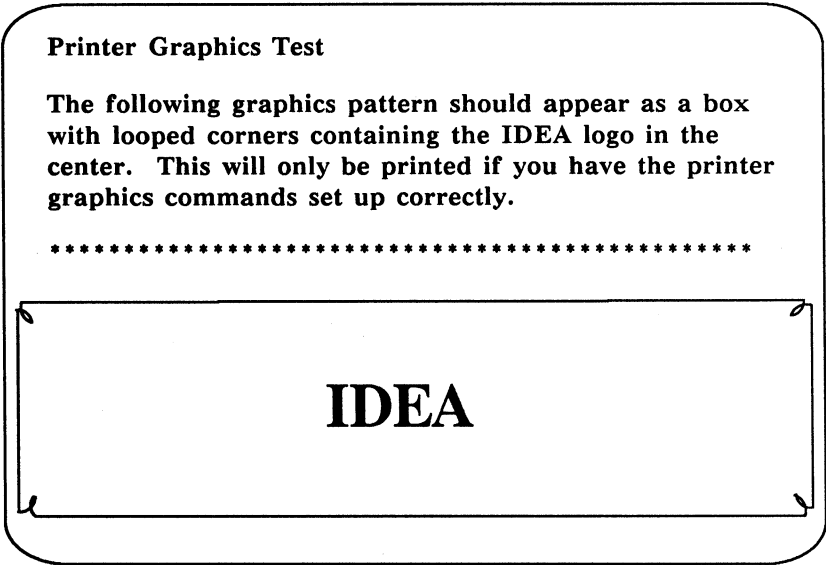

Figure A-3: Graphics Test Output

Printer Output from System 3X

If there is no printer output from the System 3X, you can run the System 3X Test Request and use the results to troubleshoot the problem. To run this test, do the following:

1. From the Logon screen, press F2 and the BACKSPACE key together. The Option Menu is displayed.
2. From the Option Menu, choose the Workstation Printer Verification option. The Workstation Printer Verification Menu is displayed.
3. On the Workstation Printer Verification Menu, enter the appropriate printer identification that corresponds to your printer address. If an error message is displayed it may mean one of the following conditions:
 - printer is offline.
 - the configured printer is not attached.
 - an incorrect station address was chosen.
4. If no error occurred in step 3, a menu is displayed with several test choices you can select. Select the Print Test 1 Time option. When the test has finished, the PC printer should print the System 3X diagnostic code.
5. To back out of the menus, press the C key until you reach the original menu displayed when you began the test.

TWINDIAG Diagnostic Program

In order to run the TWINAX Diagnostic Program, set the termination switch to the TERM position (see Figure 2-1 or 3-1). Make sure that you have already run the INSTALL program. Note that the following files are required:

TWINDIAG.EXE
TWINAXn.UCM
Z80MEM.TSK

NOTE

The older program TWINDIAG.COM, if it exists in the same directory, must be deleted or renamed before you enter the command TWINDIAG.

Type the following at the DOS prompt:

TWINDIAG <Enter>

You see the following menu:

TWINDIAG Version x.x Copyright (C)198x IDEAssociates,Inc.			
What option would you like? <u>1</u>			
<table border="1"><tr><td>1. General Diagnostics</td></tr><tr><td>2. Printer Dump</td></tr><tr><td>3. Memory Burn In Test</td></tr></table>	1. General Diagnostics	2. Printer Dump	3. Memory Burn In Test
1. General Diagnostics			
2. Printer Dump			
3. Memory Burn In Test			
Use Up/Down arrows, Press ENTER to select or ESC to Exit			

Figure A-5: TWINDIAG Main Menu

TWINDIAG General Diagnostics

To assure that this first test performs correctly, you should disconnect the card's cable from the host or controller. (TWINAX should not be resident.) If your card passes this diagnostic program you will see a screen similar to the one shown in Figure A-6.

```
TWINDIAG Version x.x Copyright (C)198x IDEAssociates, Inc.

CONFIGURATION DATA          MEMORY -> E0000
PORT -> 0368
MEMORY MAP -->      C0000 --> NO MEMORY FOUND
                   C4000 --> NO MEMORY FOUND
                   C8000--> NO MEMORY FOUND
                   CC000--> NO MEMORY FOUND
                   D0000--> NO MEMORY FOUND
.
.
                   E0000 -->MEMORY FOUND
.
.

TWINDIAG-016 MEMORY TESTS PASSED.
TWINDIAG-020 INITIAL TRANSMITTER TEST PASSED.
TWINDIAG-022 TRANSMITTER/RECEIVER LOOPBACK
TEST PASSED
Press <Enter> to return to Main Menu
```

Figure A-6: Example of Screen from TWINDIAG
(TWINAX Card is Disconnected from the Host or Controller)

Program message explanations start on page A-17.

If you want to know what station addresses the system found that are currently active on the TWINAX run, do not disconnect the cable from the card. The diagnostic test will not be run, but a screen similar to the one shown in Figure A-7 will be displayed.

```

TWINDIAG Version x.x Copyright (C)198x IDEAssociates, Inc.
-----
CONFIGURATION DATA  MEMORY - E000  PORT - 0368
MEMORY MAP --

C0000 --NO MEMORY FOUND  STATION - 0 PENDING
C4000 --NO MEMORY FOUND           1 PENDING
C8000 -- NO MEMORY FOUND           2 ONLINE
CC000 --NO MEMORY FOUND           3 PENDING
D0000 --NO MEMORY FOUND           4 PENDING
.                                   5 OFFLINE
.                                   6 OFFLINE
E0000  MEMORY FOUND

.
.

TWINDIAG-016  MEMORY TESTS PASSED.

TWINDIAG-018  LINE ACTIVE - UNABLE TO PERFORM
                TRANSMITTER TESTS. DISCONNECT
                CABLE FOR COMPLETE DIAGNOSTICS.
-----
Press <Enter> to return to Main Menu

```

Figure A-7: Example of Screen from TWINDIAG (TWINAX Card is Connected to the Host or Controller)

The words to the right of STATION have the following meaning:

- ONLINE: The station was addressed by the host and responded.
- OFFLINE: The station was not addressed by the host.
- PENDING: The station was addressed by the host and did not respond.

Printer Dump from TWINDIAG

If your printer output does not match the source document, you can run a trace diagnostics test from the main TWINDIAG menu to help trace the problem.

When you select this option, you see the following screen:

TWINDIAG Version x.x Copyright (C) 198x IDEAssociates, Inc.

What option would you like? 1

1. System 3X printer dump
2. PC printer command dump

Use Up/Down arrows, Press <ENTER> to Select or ESC to Exit

Figure A-8: Printer Menu of TWINDIAG

The System 3X dump sends printer data from the host system to the port or file that you name. The program asks you to select an emulated printer to trace, and to name a port or file. See your System 3X manual or host administrator for an analysis of the information.

The PC printer dump sends data from your PC to the port or file that you name. The program asks you to select a PC printer to trace, and to name a port or file. This data includes both printer commands and data to be printed, in ASCII code. The printer commands are listed in Section III of the *Technical Reference Guide*. Abbreviated forms are on page 7-7.

To request a print from the host, first make TWINAX resident, then hot key to DOS. Invoke TWINDIAG and select PRINTER DUMP, then the type of dump you want with printer type, port, and filename. Then hot key back to TWINAX, issue the appropriate host print command, and hot key back to TWINDIAG to begin processing.

This data which is sent from the host should agree with the printed output. For example, if the printout is 8 lines per inch, the trace printout should display an 8 lines per inch character code preceding the data. One such code is SSLD or 2B D2 04 15 0C.

Memory Test from TWINDIAG

This tests memory on the IDEAcomm card. You see a display similar to the following:

TWINDIAG Version x.x Copyright (C) 198x IDEAssociates, Inc.

Pass Number xxxxx

Location 0-1FFF a Errors have occurred.

Location 2000-3FFF b Errors have occurred.

Location 4000-5FFF c Errors have occurred. (32K card only)

Location 6000-7FFF d Errors have occurred. (32K card only)

Press any key to terminate test.

Figure A-9: TWINDIAG Memory Test

This test continues until you press any key.

If you are having problems with your card and this test shows errors, report the errors to IDEA Technical Support.

TWINDIAG Error Messages

**TWINDIAG-001 MEMORY TEST PC SIDE
FAILED LOWER BANK ZERO FILL.**

The memory located from 0 Hex to 1FFF Hex did not retain zeros stored there.

**TWINDIAG-002 MEMORY TEST PC SIDE
FAILED UPPER BANK ZERO FILL.**

The memory located from 2000 Hex to 3FFF Hex did not retain zeros stored there. The memory located from 0 Hex to 1FFF Hex did not retain the value of 0FF Hex stored there.

**TWINDIAG-003 MEMORY TEST PC SIDE
FAILED LOWER BANK 0FFH FILL.**

The memory located from 2000 Hex to 3FFF Hex did not retain the value of 0FF Hex stored there.

**TWINDIAG-004 MEMORY TEST PC SIDE
FAILED UPPER BANK 0FFH FILL.**

Memory not found at the location specified in the configuration file.

**TWINDIAG-005 CONFIGURATION ERROR --
UNABLE TO CONTINUE.**

There has been an error during an attempt to load data from TWINAXn.UCM.

**TWINDIAG-006 MEMORY FAILURE --
UNABLE TO CONTINUE.**

The memory has failed at least one test.

**TWINDIAG-007 UNABLE TO LOAD
CONFIGURATION FILE -- DIAGNOSTICS
ABORTED**

There has been an error during an attempt to load data from TWINAXn.UCM.

**TWINDIAG-008 MEMORY TEST PC SIDE
FAILED ADDRESS TEST.**

The memory as seen by the PC or PS/2 has failed an address integrity test.

**TWINDIAG-009 Z80 MEMORY TEST FILE
NOT FOUND.**

There has been an error during an attempt to load the Z809MEM.TSK file.

TWINDIAG-010 Z80 FAILED STARTUP.

An attempt to start the Z80 has failed.

**TWINDIAG-011 MEMORY TEST Z80 SIDE
FAILED LOWER BANK ZERO FILL.**

The memory located from 0 Hex to 1FFF Hex failed to retain zeros stored there.

**TWINDIAG-012 MEMORY TEST Z80 SIDE
FAILED UPPER BANK ZERO FILL.**

The memory located from 2000 Hex to 3FFF Hex failed to retain zeros stored there.

**TWINDIAG-013 MEMORY TEST Z80 SIDE
FAILED LOWER BANK 0FFH FILL.**

The memory located from 0 Hex to 1FFF Hex failed to retain the value of 0FF Hex stored there.

**TWINDIAG-014 MEMORY TEST Z80 SIDE
FAILED UPPER BANK 0FFH FILL.**

The memory located from 2000 Hex to 3FFF Hex failed to retain the value of 0FF Hex stored there.

**TWINDIAG-015 MEMORY TEST Z80 SIDE
FAILED ADDRESS TEST.**

The memory as seen by the Z80 has failed an address integrity test.

TWINDIAG-016 MEMORY TESTS PASSED.

The memory has passed all tests.

**TWINDIAG-017 Z80 NOT RESPONDING TO
REQUEST**

The Z80 has not responded to a command in the allotted time. It may be receiving data from a controller.

**TWINDIAG-018 LINE ACTIVE -- UNABLE TO
PERFORM TRANSMITTER TESTS.
DISCONNECT CABLE FOR COMPLETE
DIAGNOSTICS.**

The receiver is receiving data that originates outside of this card, that is, from a controller.

**TWINDIAG-019 TRANSMITTER TIME OUT --
TRANSMITTER FAILURE -- ABORTED.**

The simple transmitter test has failed.

**TWINDIAG-020 INITIAL TRANSMITTER TEST
PASSED**

The simple transmitter test has passed.

**TWINDIAG-021 LOOPBACK TEST FAILED --
ABORTED**

A simple loopback test has failed.

**TWINDIAG-022 TRANSMITTER/RECEIVER
LOOPBACK TEST PASSED**

The loopback test has passed.

**TWINDIAG-023 FIFO TEST FAILED --
ABORTED**

The FIFO register failed to hold exactly 16 words.

TWINDIAG-024 FIFO TEST PASSED.

The FIFO register has been tested and confirmed to 17 words deep.

**TWINDIAG-025 INVALID PARAMETER
SPECIFIED.**

An invalid parameter was specified on the command line.

**TWINDIAG-026 PS/2 ERROR - BOARD NOT
INSTALLED**

The PS/2 expansion slots were polled to locate the card ID number, and the IDEAcmm micro channel card was not found.

**TWINDIAG-027 PS/2 ERROR - POS
REGISTER 2 FAILURE**

Programmable Option Select Register 2 test failed. The problem may be card related. Call IDEA Technical Support for assistance.

**TWINDIAG-028 PS/2 ERROR - POS
REGISTER 3 FAILURE**

Programmable Option Select Register 3 test failed. The problem may be card related. Call IDEA Technical Support for assistance.

**TWINDIAG-029 PS/2 ERROR - COULD NOT
DETERMINE BOARD CONFIGURATION**

The configuration could not be determined from values read from the card. The ADF file may be corrupt, or the problem may be card related. Call IDEA Technical Support for assistance.

**TWINDIAG-030 INTERRUPT 3 TEST ON THE
MICRO-CHANNEL BOARD PASSED**

The IDEA micro channel board is set for interrupt 3 and working.

TWINDIAG-031 INTERRUPT 5 TEST ON THE MICRO-CHANNEL BOARD PASSED

The IDEA micro channel board is set for interrupt 5 and working.

TWINDIAG-032 INTERRUPT 3 TEST ON THE MICRO-CHANNEL BOARD FAILED

The IDEA micro channel board is not set for interrupt 3. Check that no other board in your system is using the same interrupt. If necessary, run manual configuration from the Reference Diskette (Section III) to select another interrupt.

TWINDIAG-033 INTERRUPT 5 TEST ON THE MICRO-CHANNEL BOARD FAILED

The IDEA micro channel board is not set for interrupt 5. Check that no other board in your system is using the same interrupt. If necessary, run manual configuration from the Reference Diskette (Section III) to select another interrupt.

TWINDIAG-034 TWINAX NOT RESIDENT, UNABLE TO PERFORM PRINTER DUMP

To perform the printer dump, be sure that TWINAX is loaded (type TWINAX and press Enter), and resident (press Shift-Shift). Then invoke TWINDIAG.

TWINDIAG-035 NO PRINTERS CONFIGURED, PRINTER DUMP ABORTED

You must have at least one printer configured with IDEACFIG or INSTALL.

TWINDIAG-036 DUPLICATE CONFIGURATION FILES TWINAX4.UCM AND TWINAX7.UCM FOUND. ONE OF THE CONFIGURATION FILES MUST BE DELETED

Copy to another directory and then delete one file. TWINAX4.UCM runs with the 4 LU (16K board) product IDEAcmm 5251. TWINAX7.UCM runs with the 7 LU (32K board) product IDEAcmm 5251/Plus.

TWINAX Program Messages

TWIN-001 EXITED TWINAX

Control has returned to DOS.

TWIN-002 FILE I/O ERROR, ACCESS DENIED

The path is not typed correctly.

TWIN-003 INSUFFICIENT FILE HANDLE

TWINAX could not locate specified files.

TWIN-004 ERROR ACCESSING CONFIGURATION FILE

The configuration file TWINAXn.UCM is missing or corrupted. Be sure that you have only one of the files TWINAX7.UCM or TWINAX4.UCM. If necessary, recopy the file from the original diskette.

TWIN-005 NO PRINTER ASSIGNED

No printer is defined with IDEACFIG.

TWIN-006 NO DISPLAY CONFIGURED

You did not specify a terminal in the configuration. You asked for an illegal host session number, or a host session that is not configured as a display, or you typed illegal characters.

TWIN-007 INVALID PATHNAME OR GREATER THAN 63 CHARACTERS

The subdirectory does not exist or the path is incorrect.

TWIN-008 PRINTER TEST FILE NOT FOUND

Since this diagnostic accesses disk files on the current default drive of the PC or PS/2, the following disk files must be present:

P5256.TST

P522X.TST (for 4214 and 5224/5225 emulation)

P5219.TST

TWIN-009 MEMORY TEST FAILURE. CHECK MEMORY ADDRESS CONFIGURATION.

The screen buffer (RAM memory) test executed on

power up and failed. Verify that the board setting for PC memory address or IBM configuration program for the micro channel card matches the memory address in IDEACFIG.

**TWIN-010 NO SESSIONS CONFIGURED --
TWINAX LOAD ABORTED**

No host sessions are configured. Execute IDEACFIG to configure host sessions for display or printer devices.

**TWIN-011 INCOMPATIBLE DISPLAY TYPE
INSTALLED**

Your system has a display adapter not supported by IDEA, usually a 40 column adapter (for example, the PCjr adapter).

TWIN-012 PRINTER I/O ERROR

You issued a local PrintScreen to a nonexistent printer, or one that was out of paper or otherwise inoperative.

**TWIN-013 I/O ERROR ACCESSING
MICROCODE FILE**

The IDEAComm card microcode has been stopped.

TWIN-014 USER DEFINED STRING EMPTY

A necessary printer configuration string has been omitted.

**TWIN-015 TWINAX RESIDENT--USE HOT
KEY TOGGLE TO RE-ENTER EMULATION**

You have entered a QUIT command while TWINAX is resident. To exit TWINAX when TWINAX is resident, you must press both Shift keys.

**TWIN-016 ERROR CONFIGURING
PARALLEL PORT LPT1 PORT NOT
CONFIGURED**

Port LPT1 was not available. If necessary, use IDEACFIG or INSTALL to choose another port on your system.

**TWIN-017 ERROR CONFIGURING PARALLEL
PORT LPT2 PORT NOT CONFIGURED**

Port LPT2 was not available. If necessary, use IDEACFIG or INSTALL to choose another port on your system.

**TWIN-018 ERROR CONFIGURING PARALLEL
PORT LPT3 PORT NOT CONFIGURED**

Port LPT3 was not available. If necessary, use IDEACFIG or INSTALL to choose another port on your system.

**TWIN 019 ERROR CONFIGURING SERIAL
PORT COM1 PORT NOT CONFIGURED**

Port COM1 was not available. If necessary, use IDEACFIG or INSTALL to choose another port on your system.

**TWIN 020 ERROR CONFIGURING SERIAL
PORT COM2 PORT NOT CONFIGURED**

Port COM2 was not available. If necessary, use IDEACFIG or INSTALL to choose another port on your system.

TWIN-022 PS/2 CONFIGURATION ERROR

The IDEAComm micro channel card is either not installed or could not be found.

TWIN-023 PS/2 INSTALLATION ERROR

The configuration could not be determined from values read from the card. The ADF file may be corrupt, or the problem may be card related. Call IDEA Tech Support for assistance.

IDEACFIG Messages

**DUPLICATE CONFIGURATION FILES
TWINAX4.UCM AND TWINAX7.UCM FOUND.
ONE MUST BE DELETED.**

You have configuration files for both the 4-LU and the 7-LU configuration in the same directory. Delete or move the one you do not need and restart IDEACFIG.

Attaching the IDEAcomm TWINAX Line to IBM Remote Controllers

The IDEAcomm card can be attached to the IBM 5251 Model 12 or IBM 5294 remote controller for the IBM System 3X. Since an IBM controller is limited in the number of devices it can support, check your controller to determine the maximum number of devices you can attach. Note that the configuration of the 5251 Model 12 differs from the configuration of the 5294. The following text describes how to reconfigure your 5294 or 5251 Model 12 when you add the IDEAcomm card.

Adding IDEAcomm to a 5294 Remote Controller

1. Verify that all workstations (terminals and printers) are powered ON. (Note that the 5294 does not recognize any device that is powered off.)
2. Check the TWINAX cables on all display devices and printers to be sure they are firmly attached.
3. At the PC or PS/2 with the IDEAcomm card, load TWINAX and go into emulation mode. The cursor will be at the upper right corner of the screen.
4. At the 5294 controller, set the TEST/NORMAL switch to TEST, then set the POWER switch to ON.
5. From any display station (5251 11, 5291 1, 5292, 3180, 3196) or from a microcomputer with IDEAcomm emulation loaded, press the CMD key, then the BACKSPACE key. This allows the 5294 to recognize the devices

attached to its ports. A setup screen displays the attached devices. Verify that the station addresses correspond to the work stations and printers you attached. If this screen does not accurately reflect the attached devices, refer to the *IBM Setup Procedure for the 5294* for instructions. Press the Enter key twice to save the configuration.

NOTE

The system operator at your host site must now configure a new device at the host if he or she has not already done this.

Adding IDEAComm to a 5251 Model 12 Remote Controller

The switch settings on the Port Selector Switch Bank (located on the back of the 5251 Model 12) determine which ports are active. Refer to Table A-1 for appropriate switch settings. The 5251 Model 12 periodically polls ports that are active to determine which devices are currently on line.

Attaching IDEAComm to an Existing TWINAX Run

If a TWINAX run is already attached to an active port, you do not need to change the Port Selector Switch Bank settings when adding IDEAComm.

Creating a New Run

If you have the first device on a Model 12 port, you must set the Port Selector Switch Bank switches to activate the port. (Refer to Table A-1 for appropriate switch settings.)

At the host, if a new device is varied on and the Port Switch Setting switches are incorrect, a **DEVICE MISMATCH ERROR** occurs when the controller is connected to the host System 3X.

Table A-1: Port Selector Switch Bank Settings for 5251 Model 2				
Switch Settings				
Active Ports	1	2	3	4
1	OFF	OFF		
1, 2	OFF	ON		
1, 2, 3	ON	OFF		
1, 2, 3, 4	ON	ON		
5			OFF	OFF
5, 6			OFF	ON
5, 6, 7			ON	OFF
5, 6, 7, 8			ON	ON

ASCII Chart

Use these codes if you must change the ASCII/EBCDIC table in the IDEACFIG file.

<u>ASCII Hex</u>	<u>Non-Display Character</u>
01	soh (CTRL-A)
02	stx (Ctrl-B)
03	etx(Ctrl-C)
04	eot (Ctrl D)
05	enq (Ctrl E)
06	ack (Ctrl-F)
07	bell (Ctrl-G)
08	bs (Ctrl-H)
09	horizontal tab (Ctrl-I)
0A	line feed (Ctrl-J)
0B	vertical tab (Ctrl-K)
0C	form feed(Ctrl-L)
0D	carriage return (Ctrl-M)
0E	so (Ctrl-N)
0F	si (Ctrl-O)
10	dle (Ctrl P)
11	dc1 (Ctrl-Q)
12	dc2 (Ctrl-R)
13	dc3 (Ctrl-S)
14	dc4 (Ctrl T)
15	nak(Ctrl U)

- 16 syn (Ctrl-U)
- 17 etb (Ctrl W)
- 18 can (Ctrl-X)
- 19 em (Ctrl-Y)
- 1A sub (Ctrl-Z)
- 1B esc (Ctrl-[)
- 1C fs (Ctrl-\)
- 1D gs (Ctrl-])
- 1E rs (Ctrl-6)
- 1F us (Ctrl-)

	0	1	2	3	4	5	6	7	8	9	A	B	C	D	E	F
0		▲		0	@	P	'	p	Ç	É	/a	■	↑	↑	α	≡
1	☉	▲		1	A	Q	a	q	ü	æ	/i	■	↑	↑	β	≡
2	☉	↑		"	2	B	R	b	è	œ	/o	■	↑	↑	Γ	≡
3	♥			#	3	C	S	c	â	ø	/n	■	↑	↑	Π	≡
4	♦	↑		\$	4	D	T	d	ä	ö	/r	■	↑	↑	Σ	≡
5	♣	§		%	5	E	U	e	å	ó	/a	■	↑	↑	σ	≡
6	♠	■		&	6	F	V	f	å	ô	/o	■	↑	↑	μ	≡
7	•	↑		'	7	G	W	g	ç	ù	/a	■	↑	↑	τ	≡
8	☐	↑		(8	H	X	h	ê	ÿ	/z	■	↑	↑	φ	≡
9	•	↓)	9	I	Y	i	ë	Û	/l	■	↑	↑	Ω	≡
A	☐	↑		*	:	J	Z	j	è	Ü	/l	■	↑	↑	•	≡
B	♀	↑		+	;	K	[k	ï	€	1/2	■	↑	↑	δ	≡
C	♁	↑		,	<	L	\	l	ï	£	1/4	■	↑	↑	∞	≡
D	♫	↑		-	=	M]	m	ÿ	¥	↑	■	↑	↑	¢	≡
E	♫	▲		.	>	N	^	n	ÿ	¢	↑	■	↑	↑	€	≡
F	☼	▼		/	?	O	_	o	ÿ	¢	↑	■	↑	↑	€	≡

Only on displays; see non-display codes above

Applies only to printers that support the IBM extended ASCII set

Appendix B: Keyboard and Terminal Defaults



Overview

This appendix provides keyboard functions and display attributes of the emulated terminal.

Emulated Keys on the IBM Keyboards

TWINAX includes emulation of the System 3X keyboard on four different microcomputer keyboards: the IBM Enhanced keyboard, the IBM AT, the keyboard for the IBM PC, XT, and Portable, and a generic 3180 keyboard. You can select the mode you want to use from the IDEACFIG Keyboard Options menu.

Shift Keys: When the Shift key is pressed:

- The special characters on the key tops of the numeric and symbol keys are entered.
- The alphabetic characters are entered as uppercase letters.
- The function control keys perform the function shown on the top half of the emulated keys.

Shift Lock Key: When the emulated Shift Lock Key (Ctrl key on the PC keyboard) is pressed:

- The special characters on the key tops of the numeric and symbol keys are entered.
- The alphabetic characters are entered as uppercase letters.

-
- The function control keys perform the function shown on the bottom half of the emulated keys.
 - The keyboard locks in shifted mode until the Shift key is pressed and released.

NOTE

The Shift Lock function operates differently than the Caps Lock or the Num Lock functions found on the IBM Personal Computer.

Free key mode: when used in this section means that your PC is not varied on.

The following tables describe the function of the keys on the PC keyboard when you are in emulation.

Table B-1: Emulated Keys on the Microcomputer		
IBM 3X Key	PC/XT/AT Key	Enhanced Key
Attn	F1	Print Screen
Change Host Session	Ctrl-L	Ctrl-L
Cmd	F2	Esc
Cmd Menu	Ctrl-Esc	Ctrl-Esc
Cursor: Left, Right	F9, F10	Arrow Keypad
Roll Up, Down	F7, F8	Arrow Keypad
Back Tab	Num. Lock	Back Tab
Tab	Tab	Tab
Del	Shifted F3	Delete
Dup	Scroll Lock	Num. Lock
Enter/Rec Adv	Caps Lock	Num. Enter, Ctrl
Erase Input	Shifted F4	Shift-Home
Error Reset	Alt	Left Alt
Field +	Num.+	Num. +
Field -	Num.-	Num. 8
Field Exit	Num.+ , -, Enter	Enter
Help	F6	Page Down
Home	F4	Home
Ins	F3	Insert
New Line	PrtSc	Right Alt
Print	F5	Page Up
PrtSc (Local Print)	Shift-PrtSc	Shift-Scroll Lock
Roll Up	Shifted F7	Shift-↑ on arrow keypad
Roll Down	Shifted F8	Shift-↓ on arrow keypad
Sys Req	Shifted F1	Shift-Print Screen
Test Req	Not Used	Scroll Lock
~	Shift-6	Shift-6
! or cent sign	{ or [[or {
or \	} or [[or }
< or >	\ or ;	\ or ;
{ or }	or ~ ' /	' or -
	1 shifted	1 shifted
CMD1/CMD13	F2-1/ F2-13	F1/F1 Shifted
CMD2/CMD14	F2-2/ F2-14	F2/F2 Shifted
CMD3/CMD15	F2-3/F2-15	F3/F3 Shifted
CMD4/CMD16	F2-4/F2-16	F4/F4 Shifted
CMD5/CMD17	F2-5/F2-17	F5/F5 Shifted
CMD6/CMD18	F2-6/F2-18	F6/F6 Shifted
CMD7/CMD19	F2-7/F2-19	F7/F7 Shifted
CMD8/CMD20	F2-8/F2-20	F8/F8 Shifted
CMD9/CMD21	F2-9/F2-21	F9/F9 Shifted
CMD10/CMD22	F2-10/F2-22	F10/F10 Shifted
CMD11/CMD23	F2-11/F2-23	F11/F11 Shifted
CMD12/CMD24	F2-12/F2-24	F12/F12 Shifted

Table B-2: Emulated Key Functions

IBM 5250 Key	Function
Attn	Notifies host of sign-on change.
Change Host Session	Change Host Session screen. Allows you to view a different emulated host screen or the Printer Control Panel if a printer is configured.
Cmd	Command key is system dependent. With most systems, pressing this key directs the system to disregard the normal function shown on the top row key and to perform the function assigned to the key in the system program.
Cmd Menu	Display the Command Menu.
Cursor Control	<p>Horizontal Movement keys cause the cursor to move in the direction indicated by the arrow on the key top.</p> <p>Vertical Movement keys cause the cursor to move up or down one line depending on the direction of the arrow on the key top.</p> <p>New Line Key moves the cursor forward (right) to the first character position of the field following the field it is in.</p> <p>Field Backspace key moves the cursor back (left) to the first character position of the field it is in. If the cursor is in the first position of a field, it moves back to the first position of the preceding input field.</p> <p>Field Tab key moves the cursor forward (right) to the first character position of the field following the field it is in.</p>
Del	Delete, when pressed with an Upper-shift key, deletes the characters where the cursor is located.

Table B-2: Emulated Key Functions (Continued)

System 3X Key	Function
Dup	Duplicate requests that the system program duplicate the information from the same field in the previous record.
Enter/Rec Adv	Enter/Record Advance indicates that the entered data is ready to be sent to the host system.
Erase Input	Erase Input when pressed with a Shift key erases data entered in all input fields. The cursor moves to the home position on the screen. In free key mode, this key erases everything on the screen and moves the cursor to the first input position on line 1.
Error Reset	Error Reset unlocks the keyboard when it is locked because of an error condition. It can also be used to reset the help, insert, system request, and command modes.
Field +	Field + operates as a field exit key in all fields.
Field -	Field - is system dependent. With most systems it operates the same as Field and Field Exit except that it is allowed in signed numeric and numeric fields only.
Field Exit	Field Exit is used to exit input fields that are specified by a program as right adjusted or field exit required fields.
Help	Help displays a description of the current error condition. Press the Error Reset key to reset the help message and the error condition, restore the display screen, and unlock the keyboard.
Home	Home moves the cursor to the system designated home position when the display screen is under system program control.

Table B-2: Emulated Key Functions (Continued)

System 3X Key	Function
	<p>In Free Key mode, Home returns the cursor to the first input position on line 1.</p> <p>When supported by the host system program, this key is pressed to display a previous record if the cursor is in the home position.</p> <p>NOTE: In some screens, if this key is pressed twice you will lose data.</p>
Ins	Insert sets the keyboard to insert mode so that data will be entered at the cursor position and all data to the right of the cursor will move right. To exit insert mode, press the Error Reset key combination.
Local Print	See Print Screen
New Line	Moves the cursor to the first input position of the first field of a new line.
Print	Print sends a print request to the host system.
Print Screen	Sends a copy of the screen to your local PC printer.
Roll keys	Roll keys when pressed with the Shift key move information up or down. The system program controls the use of these keys for each job.
Sys Req	System Request key is system dependent. With most systems, it can be used to initiate sign-on, select an alternate job, temporarily stop the present display activity and allow selection of a new activity.
Test Req	Test Request is system dependent.

Attribute Appearance for 5250 Display Station and Monochrome Personal Computer

In the following chart:

- Normal means a lighter character on a darker field.
- Reverse means a darker character on a lighter field.
- Light means high intensity.
- Null refers to any keystroke or non-keystroke that displays as a blank or space.

Table B-3: Monochrome Attributes

HEX Code	IBM Meaning	Monochrome PC 5251 Card	Monochrome PC with 5251 Card & 5251 D Card
20	NORMAL	Green characters on black	Green characters on black
21	REVERSE	Black characters on green	Black characters on green
22	HIGH INTENSITY, NORMAL	Light green characters on black	Light green characters on black
23	REVERSE HIGH INTENSITY	Black characters on green	Black characters on green
24	UNDERSCORE NORMAL	Green on black with green underscore	Green on black with green underscore
25	UNDERSCORE REVERSE	Black on green	Black on green with black underscore
26	UNDERSCORE HIGH INTENSITY, NORMAL	Light green on black with light green underscore	Light green on black with light green underscore
27	NO DISPLAY	No display	No display
28	BLINK, NORMAL	Blinking green on black	Blinking green on black
29	BLINK, REVERSE	Blinking black on green	Blinking black on green
2A	BLINK, HIGH INTENSITY, NORMAL	Blinking light green on black	Blinking light green on black
2B	BLINK, HIGH INTENSITY, REVERSE	Blinking black on green	Blinking black on green
2C	BLINK, UNDERSCORE NORMAL	Blinking green on black with blinking green underscore	Blinking green on black with blinking light green underscore
2D	BLINK, UNDERSCORE REVERSE	Blinking black on green with green underscore	Blinking black on green with blinking light green underscore

Table B-3: Monochrome Attributes

HEX Code	IBM Meaning	Monochrome PC 5251 Card	Monochrome PC with 5251 Card and 5251 D Card
2E	BLINK, UNDERScore, HIGH INTENSITY, NORMAL	Blinking light green on black with blinking green underscore	Blinking light green on black, blinking light green underscore
2F	NO DISPLAY	No display	No display
30	COLUMN SEPARATORS, NORMAL	Green on black with green rectangular bars in null positions	Green characters on black with green column separators
31	COLUMN SEPARATORS, REVERSE	Black on green with black rectangular bars in null positions	Black characters on green with black column separators
32	COLUMN SEPARATORS, HIGH INTENSITY NORMAL	Light green on black with light green rectangular bars in null positions	Light green characters on black with light green column separators
33	COLUMN SEPARATOR HIGH INTENSITY, REVERSE	Black on green with black rectangular bars in null positions	Black characters on green with black column separators
34	COLUMN SEPARATOR, UNDERScore, NORMAL	Green on black with green rectangular bars in null positions and green underscore	Green characters on black with green column separators, green underscore
35	COLUMN SEPARATORS, UNDERScore REVERSE	Black on green with black rectangular bars in null positions	Black characters on green with black column black underscore
36	COLUMN SEPARATOR UNDERScore HIGH INTENSITY NORMAL	Light green on black with light green bars in null positions and light green underscore	Light green characters on black with light green column separators, light green underscore
37	COLUMN SEPARATORS	Green rectangular bars on black. No other characters displayed.	Green column separators on black. No other characters displayed.

Table B-3: Monochrome Attributes

HEX Code	IBM Meaning	Monochrome PC 5251 Card	Monochrome PC with 5251 Card and 5251 D Card
38	COLUMN SEPARATORS, BLINK, NORMAL	Blinking green on black with blinking green rectangular bars in null positions	Blinking green characters on black with blinking green column separators
39	COLUMN SEPARATORS, BLINK, REVERSE	Blinking black on green with blinking green rectangular bars in null positions	Blinking black characters on green with blinking black column separators
3A	COLUMN SEPARATORS, BLINK, HIGH INTENSITY NORMAL	Blinking green on black with blinking green rectangular bars in null positions	Blinking light green characters on black with blinking light green column separators
3B	COLUMN SEPARATORS, BLINK, HIGH INTENSITY, REVERSE	Blinking black on green with blinking black rectangular bars in null positions	Blinking black characters on green with blinking black column separators
3C	COLUMN SEPARATORS, BLINK, UNDERSCORE, NORMAL	Blinking green on black with blinking green rectangular bars in null positions and blinking green underscore	Blinking green characters on black with blinking green column separators and blinking green underscore
3D	COLUMN SEPARATORS, BLINK, UNDERSCORE, REVERSE	Blinking black on green with blinking black rectangular bars in null positions	Blinking black characters on green with blinking green column separators and blinking black underscore
3E	COLUMN SEPARATORS, BLINK, UNDERSCORE, HIGH INTENSITY NORMAL	Blinking green on black with blinking green rectangular bars in null positions	Blinking light green characters on black with blinking light green column separators and blinking light green underscore
3F	COLUMN SEPARATORS	Green rectangular bars on black. No other characters displayed.	Green column separators on black. No other characters displayed.

Attribute Appearance for 5292 Display Station and Color Monitor Personal Computer

In the following chart:

- Normal means a lighter character on a darker field.
- Reverse means a darker character on a lighter field.
- Light means high intensity.
- Null refers to any keystroke or non keystroke that displays as a blank or space. For example, if you used Hex Code color 24 (which includes an underscore for nulls) and typed the name JOHN SMITH, JOHN and SMITH would not be underscored, but the space that separates the two parts of the name would be underscored. Also, every blank in the remainder of the field would be underscored. Your screen would show:

JOHN_ SMITH _____

Table B-4: Color Attributes

Hex Code	IBM 5292 Display Station	IDEA Meaning	IDEA Color Monitor Personal Computer
20	GREEN	Normal	Green characters on black
21	GREEN/REVERSE IMAGE	Reverse	Black characters on green
22	WHITE	Normal	White characters on black
23	WHITE/REVERSE IMAGE	Reverse	Black characters on white
24	GREEN/UNDERSC	Bright Normal Underscore	Light green on black with light green underscore characters for nulls
25	GREEN/ UNDERSCORE/ REVERSE IMAGE	Reverse Underscore	Gray on green with gray underscore characters for nulls
26	WHITE/UNDERSC	Bright Normal Undersc	Light white on black with light white underscore characters for nulls
27	NON-DISPLAY	Non-Disp	Black on black
28	RED	Normal	Red characters on black
29	RED/REVERSE IMAGE	Reverse	Black characters on red
2A	RED/BLINK	Blink, Normal	Blinking red on black
2B	RED/REVERSE IMAGE/BLINK	Blink, Reverse	Blinking black on red
2C	RED/UNDERSC	Bright, Normal, Undersc	Light red on black with light red underscore characters for nulls

Table B-4: Color Attributes (Continued)

Hex Code	IBM 5292 Display Station	IDEA Meaning	IDEA Color Monitor Personal Computer
2D	RED/UNDERSC/ REVERSE IMAGE	Reverse, Underscore	Gray on red with gray underscore characters for nulls
2E	RED/UNDERSC BLINK	Bright, Blink, Normal, Underscore	Blinking light red on black with blinking light red underscore characters for nulls
2F	NON-DISPLAY	Non-Disp	Black on black
30	TURQUOISE/COL. SEPARATORS	Normal, Column Separators	Cyan on black with cyan rectangular characters in null positions
31	TURQUOISE/COL. SEPARATORS/ REVERSE IMAGE	Reverse, Column Separators	Black on cyan with black rectangular characters in null positions
32	YELLOW/COL. SEPARATORS	Bright, Normal Column Separators	Light yellow on black with light yellow rectangular characters in null positions
33	YELLOW/COL. SEPARATORS/ REVERSE IMAGE	Reverse, Column Separators	Gray on brown with gray rectangular characters in null positions
34	TURQUOISE/ UNDERSCORE	Bright, Normal Underscore	Light cyan on black with light cyan underscore characters in null positions

Table B-4: Color Attributes (Continued)

Hex Code	IBM 5292 Display Station	IDEA Meaning	IDEA Color Monitor Personal Computer
35	TURQUOISE/ UNDERSCORE/ REVERSE IMAGE	Reverse, Underscore	Gray on cyan with gray underscore characters in null positions
36	YELLOW/UNDERSC	Bright, Normal Underscore	Light yellow on black with light yellow underscore characters in null positions
3A	BLUE	Normal	Blue on black
37	NON-DISPLAY	Non-Display	Non-Display
38	PINK	Normal	Magenta on black
39	PINK/REVERSE IMAGE	Reverse	Black on magenta
3B	BLUE/REVERSE IMAGE	Reverse	Black on blue
3C	PINK/UNDERSC	Bright, Normal, Underscore	Light magenta on black with underscore characters in null positions
3D	PINK/UNDERSC/ REVERSE IMAGE	Normal, Reverse, Underscore	Gray on magenta with gray underscore characters in null positions
3E	BLUE/UNDERSC	Bright Normal Underscore	Light blue on black with light blue underscore characters in null positions
3F	NON-DISPLAY	Non-Display	Non-Display

Appendix C:

Using REVUP.EXE to Update Older Software

REVUP.EXE enables you to transfer old printer configuration information, display information, and keyboard language information into a new revision of TWINAX. Each time a new revision of TWINAX is received, the new TWINAXn.UCM file and PRINTER.CMD file need to be reconfigured to include this information. REVUP.EXE saves you time by reading the old files and writing the appropriate printer, display, and keyboard language data into the new versions.

The program is especially important for users changing to release 5.0 from a lower release, which uses different filenames. It is also recommended for users of non-U. S. A. keyboards who have changed their keyboard configuration, thereby altering the TWINAXn.UCM translation table.

Running REVUP

The program includes screen displays that tell you how to proceed. All you need do is:

1. Rename your current TWINAX.UCM, TWINAX4.UCM, or TWINAX7.UCM to TWINAX.OLD
2. Rename PRINTER.DAT or PRINTER.CMD to PRINTER.OLD
3. If you are running emulation from a hard disk, make a new directory for the new 5251 software. Copy files from all diskettes to this directory.

-
4. Transfer TWINAX.OLD and PRINTER.OLD to the new directory. (If you are running from diskette, transfer TWINAX.OLD and PRINTER.OLD to the diskette containing the new REVUP.)

5. Type:

REVUP <Enter>

Example

Reconfiguring TWINAXn.UCM to Transfer Old Configurations to Upgraded TWINAX

Current Version: 4.0 TWINAX.UCM

Desired Version: 5.0 TWINAX7.UCM

1. Rename your current TWINAX.UCM to TWINAX.OLD.
2. Rename your current PRINTER.DAT to PRINTER.OLD
3. If you are running emulation from a hard disk, create a new directory (V5.0) for the new 5251 software and copy all diskettes to this directory.
4. Copy TWINAX.OLD and PRINTER.OLD to the new software diskette or directory (V5.0).
5. Type **REVUP** <Enter>
6. The new TWINAX7.UCM (V5.0) now has the keyboard, printer, and display configuration that was in TWINAX.OLD. The new PRINTER.CMD has the printer tables that were in PRINTER.OLD.

Appendix D:

Switch Settings

This appendix is for users with the PC and PS/2 Model 30 series. See Figure 2-1 for the location of the Revision letter of your card.

TWINAX Plus Rev. D and Higher Cards

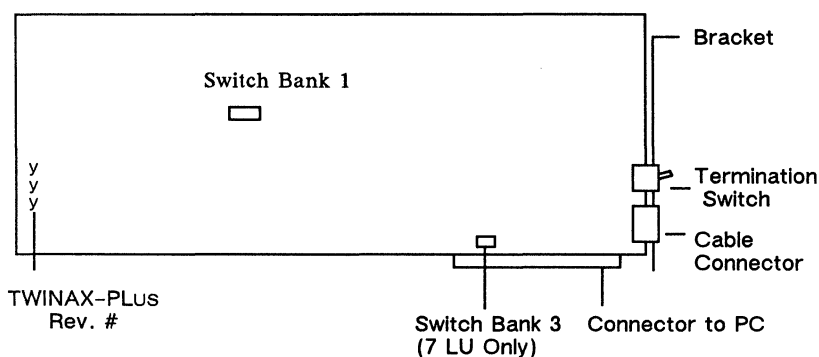

Figure D-1: The IDEAcomm 5251 or 5251/ Plus Card Rev. D and higher

Memory on the Rev. D and higher Cards

The memory address for the TWINAX-PLUS Rev. D and higher cards is configured through the program `INSTALL` or `IDEACFIG`. You do not need to check anything on the card.

If you use the `INSTALL` program, the memory address is set by the software automatically

depending on your options, and is written to the TWINAXn.UCM file.

If you use the IDEACFIG program, you should enter the appropriate memory address on the User Interface Options menu. If you are using an IBM PC, XT, or Portable, enter E000. If you are using an IBM AT or PS/2 with a standard monitor, enter C000. If you have an AT with an EGA monitor, enter C800.

Switch Bank 1: I/O Address

The switches on switch bank 1 were set to 368 Hex at the factory and should look like those shown in Figure D-2.

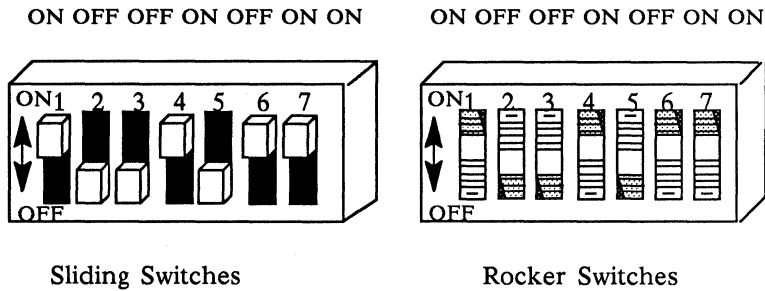

Figure D-2: (Switch Bank 1: I/O Address 368 Hex
(Rev. D and Higher Cards))

If you need to change to address 370 because of a conflict with another card, use the setting in Figure D-3.

NOTE

To set sliding switches, simply slide the tab to the ON or OFF position.

To set rocker switches, press down the ON side of the switch to set it to ON or press down the OFF side of the switch to set it to OFF. Use care when setting rocker switches.

ON OFF OFF OFF ON ON ON

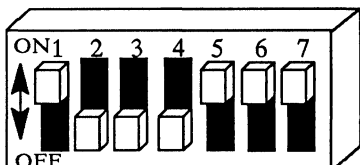

Sliding Switches

ON OFF OFF OFF ON ON ON

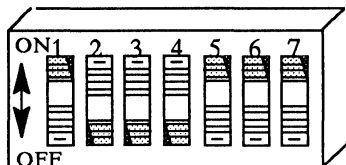

Rocker Switches

Figure D-3: Switch Bank 1 — I/O Address of 370 Hex (Rev. D and Higher Cards)

In order to set the hardware I/O Address to 370 Hex, you must also run the IDEACFIG program on the IDEAComm diskette. You must change the Hardware I/O Address displayed on the User Interface Options menu to reflect the new I/O Address of 370 Hex.

Switch Bank 3 – 7 LU Boards Only

This switch is used only on the 32K (7 LU) product. In Release 5, all switches are set OFF on this switch.

TWINAX-PLUS Rev. C Settings

The TWINAX-PLUS REV. C card is functionally equivalent to the TWINAX-PLUS Rev. D card. However, because the design of the TWINAX-PLUS Rev. C card is slightly different, you must use the switch settings listed here.

Refer to Figure D-4 for the location of the revision number of your card and for switch banks 1 and 3.

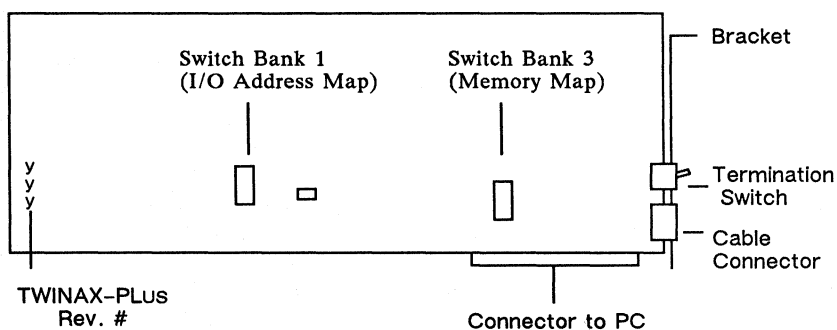

Figure D-4: The IDEAcomm 5251 Card Rev. C

NOTE

To set sliding switches, simply slide the tab to the ON or OFF position.

To set rocker switches, press down the ON side of the switch to set it to ON or press down the OFF side of the switch to set it to OFF. Use care when setting rocker switches.

Switch Bank 1: I/O Address

The switches on switch bank 1 were set to 368 Hex at the factory and should look like those shown in Figure D-5.

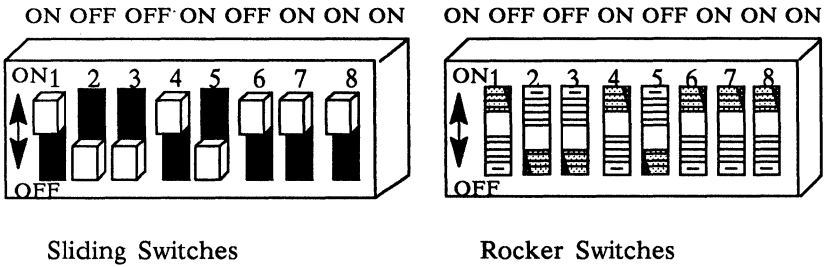

Figure D-5: Switch Bank 1 — I/O Address of 368 Hex (Rev. C Card)

If you have an address conflict (due to the installation of another board, for example), you should change the address to 369 Hex. See Figure D-6.

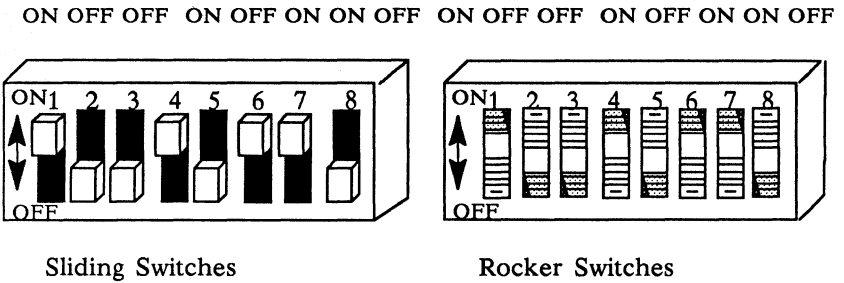

Figure D-6: I/O Address of 369 Hex (Rev. C Card)

In order to set the hardware I/O Address to 369 Hex, you must also run the IDEACFIG program on the IDEAComm 5251 diskette. You must change the Hardware I/O Address displayed on the User Interface Options menu to reflect the new I/O Address of 369 Hex.

Switch Bank 3 -- Memory Address for IBM PC, XT, Portable (Rev. C Card)

Your TWINAX-PLUS Rev. C card is set at the factory with a memory address of E000.

Note that there are two different settings for switch bank 3. Address E000 (the factory setting) is for an IBM PC, XT, or Portable, as shown in Figure D-7.

OFF OFF OFF OFF OFF ON ON ON OFF OFF OFF OFF OFF ON ON ON

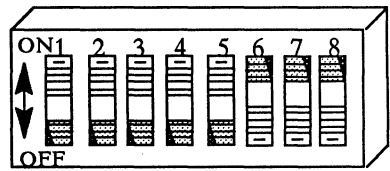
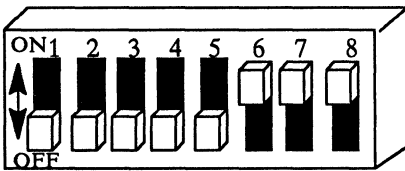

Sliding Switches

Rocker Switches

Figure D-7: Switch Bank 3—Factory Setting E000 for PC, XT, and Portable (Rev. C Card)

Switch Bank 3 --Memory Address for IBM AT (Rev. C Card)

If your IBM personal computer is an IBM AT, you must reset your switches to an address of C000.

See Figure D-8.

OFF OFF OFF OFF ON ON ON ON

OFF OFF OFF OFF ON ON ON ON

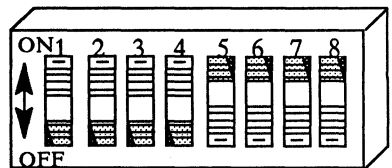
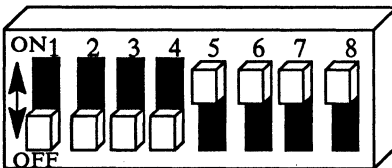

Sliding Switches

Rocker Switches

Figure D-8: Switch Bank 3 — Address C000 for AT (Rev. C Card)

Changing Switch Bank 3 Settings

Switch settings on bank 3 have the following meanings:

Switch	C000	C400	C800	D000	E000
3	OFF	OFF	OFF	OFF	OFF
4	OFF	OFF	OFF	OFF	OFF
5	ON	ON	ON	ON	OFF
6	ON	ON	ON	OFF	ON
7	ON	ON	OFF	ON	ON
8	ON	OFF	ON	ON	ON

The settings for switches 1 and 2 remain unchanged.

If your memory address is, for example, C000, and you wish to change the memory address to D000, switches 3 through 8 must be changed as follows:

OFF OFF OFF OFF ON OFF ON ON OFF OFF OFF OFF ON OFF ON ON

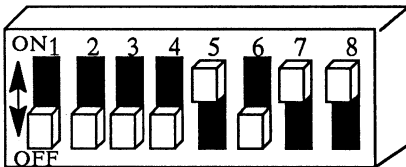

Sliding Switches

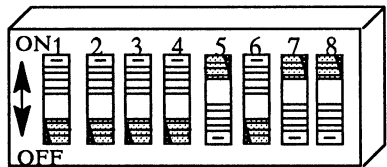

Rocker Switches

Figure D-9: Switch Bank 3 — Address D000 (Rev. C Card)

In order to set the hardware Memory Address to D000, you must also run the IDEACFIG program on the IDEAComm 5251 diskette. You must change the Hardware Memory Address displayed on the User Interface Options menu to reflect the new Memory Address of D000.

TWINAX Rev. A, B, and Older C Settings

See the chart on the following page for a quick reference.

Quick Reference Chart for TWINAX and TWINAX-PLUS Switches

Memory Address (Factory Setting C000 or E000)

5251 Card	IBM PC Type	Memory Address	Switches OFF	Switches ON
OLD TWINAX Rev. A,B,C Switch Bank SW2	PC,XT,PPC, PS/2M30	E000	12345	678
	AT	C000	1345	2678
	AT & EGA	C400 C800	13456 13458	278 267
TWINAX-PLUS Rev. C Switch Bank SW3	PC,XT,PPC, PS/2M30	E000	12345	678
	AT	C000	1234	5678
	AT & EGA	C400 C800	12348 12347	567 568

I/O Address (Factory Setting 368 Hex)

5251 Card	I/O Address	Switches OFF	Switches ON
OLD TWINAX Rev. A,B,C Switch Bank SW1	368 Hex	358	12467
TWINAX-PLUS Rev. C Switch Bank SW1	368 Hex	235	14678
TWINAX-PLUS Rev. D, E, higher Switch Bank SW1	368 Hex	235	1467

PPC: IBM Portable PC

EGA: Enhanced Graphics Adapter.

Appendix E: The SEND File Editor



Overview

You can create a file, called a SEND file, that executes a sequence of commands within emulation.

You can use this file with the SEND utility to send batch files that log on to the host or perform other repeated procedures.

For example, you can use this file to log on to the System 3X, enter DisplayWrite, and open a file for editing. You need enter only one command from DOS.

Running the Editor

From DOS, enter:

SNDEDIT <Enter>

The screen displays all SEND files in the current directory and prompts you to select one for editing. To start a new file, for example, MINE.SND, enter:

SEND MINE <Enter>

SNDEDIT will append the extension .SND to this filename.

You can also choose a file and other options from the DOS command line, with the format:

SNDEDIT [/option] [filename]

where **option** may be:

- /A** Append new records or commands to the specified file. (Otherwise, editing begins at the first record.)
- /In** Start at record or index number n. If the /A option is also used, then the /I option is disregarded. If neither /A nor /I is used, editing starts at record 1.
- /D** Choose a keyboard configuration file for a non-U.S.A. keyboard. An example is /Dgermany. Using /D with no filename causes SNDEDIT to display a list of all filenames available that end in .CFS, from which you may choose one corresponding to your language.

Filling in the Screen

IDEAcomm/5251 SEND Event Editor Copyright (c) 1988 IDEAssociates, Inc. Version x.x	
File: xxxxx.SND	Record #nnn
Session Number:	1
Wait Delay	000
Search String	_____
Event Row	01
Event Column	001
Send Buffer	_____
Display Screen	No
AID Key	none
Use KEYPAD to move, TAB/BACKTAB for next/previous record, ESCAPE to exit	

Figure E-1: Record Screen of the SEND File Editor

One screen represents one record or command. You may use 100 records. You may insert or delete records, with automatic renumbering, by pressing the Ins or Del keys. Fill in the fields in order from left to right and top to bottom. When all fields on a screen are filled, a new blank screen-record appears. Home and End, as well as the arrow keys, allow you to move over the record.

To end, press Esc. A prompt asks whether to save the file. Answer Y to save your entries.

The following fields appear for each record:

Session Number: Enter the LU number (1 through 4 or 1 through 7) for which this file will be used.

Wait Delay: This is the number of seconds to wait for a particular search string to happen. If the event occurs within this limit, the SEND utility will process the record;

otherwise it will terminate. Possible entries are 0 through 255 seconds. The delays that you must allow vary with your system's speed and the speed of your application. In particular, text searches in word processing applications may require many seconds.

Search String: This is the string to check for in the emulation display before processing any more. An example is a host prompt.

There cannot be any spaces in the search string. Upper and lower case must match the screen display.

NOTE

If only one entry is needed on a screen, you do not have to fill in the Search String, Event Row, and Event Column.

Row and Column: Enter the position on the screen in which the search string or host prompt should begin. Possible entries for row are 1 to 24 (1 to 27 for a 3180 display type), and for a column, 1 to 80 or 1 to 132.

Send Buffer: This is the command or set of keystrokes that you want to send in response to the previous search string.

To enter an emulated key, press Alt-P for a list of these keys: Cent, Field-Error Reset, and so on. Note that only those keys that do not cause an Input Inhibited state are allowed. Use the cursor keys to move the highlighted bar to your choice and press Enter. The name of the emulated key will appear in the Send Buffer line.

To complete the Send Buffer line, press Enter or use cursor arrows to move to other fields.

Display Screen: Tells the SEND utility whether to display the screen as it would appear if emulation were running. This option is important if none of the AID (Attention Identification) keys listed below are sent, so that during emulation the user can see when to continue manually. Valid choices are Y and N.

AID Key: This tells the SEND utility which AID key to send once the Send Buffer has been sent. Press the space bar to cycle through choices. The AID keys are:

None	Enter
Attn	Home
Print	Help
Roll Down	Roll Up
Newline	Clear
Test Req	Cmd-1 through 24

Pause for Operator Entry: If no AID key is selected, when SEND is run, it will pause after sending anything in the Send buffer and wait for operator entry until an AID key is sent from the keyboard. Then it returns you to DOS. Use the Hot Key to return to the last screen.

Example

Suppose that your daily startup sequence is the following:

1. You enter **TWINAX** and see the prompt **User ID**.
2. You enter **IDEA** and press the emulated Enter key (Caps Lock on the PC and AT keyboards). That is the only entry you make in screen 1.
3. The screen changes to a menu, with room after the word **Ready** for a command to be typed in. You type **TEXTDOC**, and press Enter. That is the only entry you make in screen 2.
4. The third screen takes some time to appear. It is the **DISPLAYWRITE** menu, on which you make three entries. At the host prompt **Option** on row 4, column 3, you select 5. At the prompt **Document** on row 6, column 3, you enter **MINE**. At the prompt **Folder** on row 7, column 5, you enter **REV**. Then you press Enter.

Fill out five records as shown on the next page.

Use this file with **SEND** in the following steps:

1. Use **SNDEDIT** to create a file with the default name **TWINAX.SND**.
2. Start emulation with the command **TWINAX** <Enter>.
3. Use the Hot Key to return to DOS (default Shift-Shift).
4. Enter **SEND** <Enter>.

You will see the sign-on menu as **IDEA** is placed in the user ID, then the second menu as **TEXTDOC** fills the command line. Then you will see the **DISPLAYWRITE** menu as the entries 5, **MINE**, and **REV** appear. Finally, you will see the DOS prompt.

-
5. From the DOS prompt, press the Hot Key (Shift-Shift) to return to emulation. You will see your text file waiting for you to make changes.

Record 1		Record 2	
Session Number:	1	Session Number:	1
Wait Delay	005	Wait Delay	000
Search String		Search String	
Event Row	<u>01</u>	Event Row	<u>01</u>
Event Column	<u>001</u>	Event Column	<u>001</u>
Send Buffer	IDEA	Send Buffer	TEXTDOC
Display Screen	Yes	Display Screen	Yes
AID Key	<enter>	AID Key	<enter>
Record 3		Record 4	
Session Number:	1	Session Number:	1
Wait Delay	010	Wait Delay	005
Search String	Option	Search String	Document
Event Row	04	Event Row	06
Event Column	003	Event Column	003
Send Buffer	5	Send Buffer	MINE
Display Screen	Yes	Display Screen	Yes
AID Key	<newline>	AID Key	<newline>
Record 5			
Session Number:	1		
Wait Delay	005		
Search String	Folder		
Event Row	07		
Event Column	005		
Send Buffer	REV		
Display Screen	Yes		
AID Key	<enter>		

Appendix F: Using the Keyboard File Editor



Overview

The keyboard file editor allows you to create or remap keyboard files.

Files Required

KYEDIT.EXE

TWIN5251.EXC

xxx.CAP

xxx.KEY

The keyboard editor

Exception code file

Keyboard label file

Key file for the scan codes
sent for each key

Running the KYEDIT Program

Enter: **KYEDIT** <Enter>

You see a screen with the following options:

1. **Load Keyboard Language File**
 2. **Remap Keyboard using Key Labels**
 3. **Remap Keyboard using Scan Codes**
 4. **Advanced Keyboard Customization**
 5. **Display Key Definition**
 6. **Edit Display Translation Table**
 7. **Edit Printer Translation Table**
 8. **Reset Keyboard Configuration**
 9. **Save Configuration to Disk**
- Esc. Exit KYEDIT

Figure F-1: KYEDIT Main Menu

Strategy for Changing Keys

1. First load or create a keyboard language file. If possible, load a file that is close to the one you want, so you will have few editing changes.
2. Make the desired changes. Most users can make all desired changes using option 2 (Remap Keyboard Using Labels). Option 2 is for the non-technical user. Options 3, 6, and 7 are designed for the experienced user who has a working knowledge of system internals. Options 4 and 5 are for IDEA developers.
3. Save the configuration to disk (option 9).
4. Either exit (Esc key) or continue editing a new file.
5. Before you use the changes in emulation, you **must run IDEACFIG to select the new .KEY file you created or changed.**

1. Load Keyboard Language File

When you select option 1, the cursor moves to the bottom part of the screen, where you may enter a new or existing filename or pathname, a brief description, and whether it is intended for the Enhanced keyboard. If you type a filename and press Enter, the software immediately adds the extension .KEY to this file.

If you want to edit an existing file, instead of entering a filename, press Enter again for a display of available files (these all end in .KEY).

Once a language file is loaded, the bottom of the screen lists information about the file being created or modified:

Currently Editing:	Name of key file
File Description:	Comments about the keyboard type and other information
Enhanced Keyboard	Yes or No
Version Number	Version of the key file
Modified	Whether you have made changes since initial shipment

To indicate Yes for No for Enhanced keyboard, press the space bar and then Return. If you choose Yes, the screen then prompts for a pre-scan code. For IBM Enhanced keyboards, the pre-scan code is E0. Consult your keyboard manual or manufacturer for this information.

2. Remap Keyboard Using Key Labels

When you select option 2 from the main screen, you are prompted for the PC key you want to redefine. Press the key (for example, left arrow).

For the key you are editing, you see the following choices:

Normal	<u>Keypad 4</u>
Shift	_____
Control	<u>VIEW LEFT</u>
Control-Shift	<u>VIEW LEFT</u>
Alt	<u>BORDER LEFT</u>
Alt-Shift	<u>BORDER RIGHT</u>
Control-Alt	_____
Control-Alt-Shift	_____
Hot Key	Not a hot key or hot button

Move the cursor arrow to the line with the state that you want to redefine, for example, Ctrl-Alt-. Press Enter. Then use the cursor arrows on the bottom part of the screen to select the name of the emulated key that you want to represent with Ctrl-Alt-left-arrow, for example, PRINT SCREEN. (Keys are listed on the next page.) Press Return.

Normal	_____
Shift	_____
Control	_____
Control-Shift	_____
Alt	_____
Alt-Shift	_____
Control-Alt	_____
Control-Alt-Shift	_____
Hot Key	Not a hot key or hot button

ATTN KEY	CMD KEY	INSERT KEY	HOME	PRINT	HELP	CURSOR UP	CURSOR DOWN
-------------	------------	---------------	------	-------	------	--------------	----------------

MORE ↓

Use ARROWS to choose label, ENTER to select, or ESCAPE to cancel

Figure F-2: Key Label Editing

Attn	Cmd	Insert	Home	Print	Help	Cursor Up	Cursor Dn
Cursor Lft	Cursor Rt	Back Quote	1	2	3	4	5
6	7	8	9	0	Hyphen	Equal	Backsp
Backtab	Dup	Tab	q	w	e	r	t
y	u	i	o	p	Cent	Backslash	Field Exit
Num.7	Num.8	Num.9	Field-	Caps Lock	a	s	d
f	g	h	j	k	l	;	Quote
Left Brace	Num.4	Num.5	Num.6	Field+	Left Shift	Less	z
x	c	v	b	n	m	Comma	Period
Slash	Right Shift	New Line	Num.1	Num.2	Num.3	Error Reset	Enter/RecAdv
Num.0	Num.Per.	Space	SysReq	Del	Erase Inp	Roll Up	Roll Down
Tilde	Line Bar	@	#	\$	%	*	Apostrophe
Asterisk	Left Paren	Right Paren	Undersc	+	Q	W	E
R	T	Y	U	I	O	P	!
BrokenBar	A	S	D	F	G	H	J
K	L	:	Quotes	Right Brace	Greater	Z	X
C	V	B	N	M	?	Cmd1	Cmd2
Cmd3	Cmd4	Cmd5	Cmd6	Cmd7	Cmd8	Cmd9	Cmd10
Cmd11	Cmd12	TestReq	Cmd13	Cmd14	Cmd15	Cmd16	Cmd17
Cmd18	Cmd19	Cmd20	Cmd21	Cmd22	Cmd23	Cmd24	CLEAR
Clear buff	Ctrl-C	Ctrl-Break	Reboot	Toggle LU	Exit	ResetMCde	Toggle Windows
Toggle LUs	Excptn 0A*	View Rt	View Left	View Up	View Dn	Border Rt	Border Left
Border Up	Border Dn	RecordKeys	Playback	Cancel Rec	Erase Rec	Excptn 17*	Excptn 18*
PrintScreen	*Reserved						

Figure F-3: Options on the Key Label Screen

Note that, in this appendix, a **Hot Button** is the equivalent of the IDEA Hot Key, which switches between the current LU and DOS and makes emulation resident. A **Hot Key** is the IBM Hot Key, which cycles through all LUs and then to DOS. IDEA supports both methods for user flexibility.

You may set up any number of keys as Hot Buttons.

Examples

To change the Hot Button (Shift-Shift) to Ctrl-F4:

1. From the main menu, select option 2.
2. Press the key you wish to change (F4)
3. Set F4 as a Hot Button (Option 9). Use the space bar until Hot Button appears, then press Enter.
4. Press Esc to complete this remapping.
5. Press Ctrl.
6. Set Ctrl as a Hot Button.
7. Press Esc to complete this remapping, Esc again to leave option 2, answer NO to **Do you wish to edit the ESCAPE key?**, and press 9 to save your changes.
8. Run IDEACFIG to incorporate the new key file into the configuration file.

F4 and Ctrl may still have other function in various states. When both are pressed consecutively, however, they work as the Hot Button, alternating between DOS and the current LU.

To set Enter as the emulated Enter key:

Enter in the default state is the emulated Field Exit key, so you might change Field Exit to Shift-numeric plus.

-
1. From the main menu, select option 2.
 2. Press the + key on the numeric keypad.
 3. Select 2 (Shifted state) and press Enter.
 4. On the lower half of the screen, select Field Exit and press Enter.
 5. Press Esc to start editing a new key.
 6. Press the Enter key.
 7. Move the lighted bar to 1 (Normal) and press Enter.
 8. On the lower half of the screen, select Enter/RecAdv and press Enter.
 9. Press Esc twice and answer No to the prompt, **Do you wish to edit the ESCAPE key?** Press 9 to save your changes.
 10. Run IDEACFIG to incorporate the new key file into the configuration file.

To set Alt-F3 as the Clear key:

1. From the main menu, select option 2.
2. Press the key you wish to change (F3)
3. Select Option 5 (Alt state) and press Enter.
4. From the list of emulated keys that appears in the lower half of the screen, select Clear and press Return.
5. Press Esc twice and answer No to the prompt, **Do you wish to edit the ESCAPE key?** Press 9 to save your changes.
6. Run IDEACFIG to incorporate the new key file into the configuration file.

3. Remap Keyboard Using Scan Codes

This option allows technical users with a knowledge of system internals to change key configurations. The "Codes Sent" can be found in the *IDEA Technical Reference Manual*, or in the *IBM System 3X documentation*.

When you select option 2 from the main screen, you are prompted for the PC key you want to redefine. Press the key (for example, G). For the key selected, you see the following choices:

Keyboard Description: xxxx Keyboard		Editing Scan Sequence: 4B					
				Typematic			
				Send code after release if no other key pressed			
				Send code for both press and release of key			
				Send multiple characters for key			
				Exception Code			
				Special Status Bit			
				Mask is a toggle			
		Codes Sent	Shift Mask				
Normal	44	-----	00000000	N N	--	N N N Y	
Shift	44	-----	00000000	N N	--	N N N Y	
Ctrl		-----	00000000	N N	0C	- N N N	
Ctrl-Shift		-----	00000000	N N	0C	- N N N	
Alt		-----	00000000	N N	10	- N N Y	
Alt-Shift		-----	00000000	N N	10	- N N Y	
Ctrl-Alt		-----	00000000	N N	00	- N N N	
Ctrl-Alt-Shift		-----	00000000	N N	00	- N N N	

Use ARROWS to position cursor, Enter a 2 byte HEX code, ESCAPE to cancel

Figure F-4: Scan Code Table

Typematic: Y means that this key is processed repeatedly until it is released or another key is pressed. For example, you could send out a string of asterisks by holding down the * key if it is marked as typematic.

Send code after release if no other key pressed: Y means that the code is sent only if the key

combination in question is pressed and released while no other key is pressed. This option and the following one are mutually exclusive.

Send code for both press and release of key: Y means that this key is to be processed both on the press of the key and on its release. An example is the Shift key. This option and the preceding one are mutually exclusive.

Send multiple characters for key: Y means that this key generates more than one code to be sent to the System 3X (as shown in the Codes Sent field). For example, to send shift-D, you would send 57 13 D7 (Shift-D-End-Shift). Enter both codes in the Codes Sent fields. To send CMD 1, send 6F 31.

Exception Code: Y means that pressing this key combination sends one of the following exception codes to the emulation program, which processes them without forwarding them to the host.

Exception Codes

1H	Clear Buffer
2	Reserved
3	Reserved
4	Reboot
5	Cycle through LUs
6	Exit TWINAX
7	Reset microcode
8	Window mode on/off
9	Toggle active LU
A	Reserved
B	Scroll one character right
C	Scroll one character left
D	Scroll one row up
E	Scroll one row down
F	Move window border right one position
G	Move window border left
11	Move window border up
12	Move window border down
13	Record keys

14	Playback keys
15	Cancel record keys
16	Erase record keys
17	Reserved
18	Reserved
19	Print Screen
1A	Cycle between 132 and 80 character display

Special Status Bit: Y means that this key sends out a NULL code if no exception code has been specified, regardless of codes in the Codes Sent field.

Mask is a Toggle: for use by IDEA developers.

Codes Sent: shows which 5250 scan codes will be sent to the System 3X when this key is pressed. (Scan codes are listed in Section I of the *Technical Reference Guide*.)

Shift Mask: for use by IDEA developers.

6. Edit Display Translation Table

This option allows you to make permanent changes in the ASCII translation tables. It is different than the option in IDEACFG (which changes only TWINAXn.UCM) because it makes permanent changes to the tables that are not overwritten with different files.

Change this table only if your system administrator notifies you that the host system is sending unusual characters (such as foreign language characters).

Use the arrow keys to move the cursor to the EBCDIC character whose ASCII translation you want to change. Enter the new ASCII code and press Return. Repeat this process from the main screen for each character you want to change.

For example, you might want to change the appearance of the character that the host is sending as EBCDIC 5B (dollar sign) to ASCII 9C (British £ pound sign). ASCII charts are in Appendix A.

7. Edit Printer Translation Table

This works the same as the Display Translation table. If your printer is unable to print a symbol such as £ that is sent by the host, you can change its translation to a symbol such as # that is available on most printers. ASCII charts are in Appendix A.

8. Reset Keyboard Configuration

Use this option if you wish to cancel a configuration. The loaded table reverts to the last file loaded or saved, whichever happened later.

9. Save Configuration to Disk

This saves the current information as **keyfile.KEY**, the name you chose on the first screen.

Options with the KYEDIT Command

You can use options with the KYEDIT command:

KYEDIT [keyfile [capsfile]]

where **KEYFILE** is the name of the keyboard emulation file ending in **.KEY** and **CAPFILE** is the name of the key caps label file for this type of emulated keyboard, ending in **CAP**.

For example,

KYEDIT USENH US <Enter>

edits the **USENH.KEY** file using the **US.CAP** file.

If the program cannot find either of these two files, then the default setting is loaded, using the equivalent of the **USPC.KEY** file for the PC/XT and AT keyboards, and the **USENH.KEY** file for the Enhanced keyboard.

The .CAP File Structure

The KYEDIT program reads CAP files. You should not try to change these files. If you want to look at a CAP file, such as US.CAP, you can use the **TYPE** command of DOS, or print the file. Its structure is the following:

Typematic	Send on Press and Release of Key	Send on Release Only	Key Cap Label	Scan Codes	Comment
Examples:					
N	N	N	'Attn'	7C	; Key 1
N	N	Y	'Caps Lock'	54 D4	; Key 45
Shifted State Examples:					
N	N	N	'Sys Req'	57 7C D	; Key 1 Shifted
Y	N	N	'Letter P;	57 2A D7	; Key 37 Shifted

The "Key" is the key position shown in the *Technical Reference Guide*.

Appendix G:

Glossary



ADF File

File containing address information for the micro channel card. It must be transferred to the IBM Reference Diskette before automatic or manual configuration is run with this diskette.

AID

Attention Identification key that sends control messages to the System 3X.

ASCII

American Standard Code for Information Interchange, a coding scheme wherein letters, numbers, and special symbols are represented as unique seven-bit values, allowing for standardization between data communications devices. The IBM PC and PS/2 use ASCII.

Backup

A duplicate copy of data.

Batch File

A file that contains commands. It is faster to run than retyping the commands each time. Such filenames, if intended for use with DOS, end with the extension .BAT. Batch files for use with IDEAcmm's SEND utility end in .SND.

Baud

Unit related to bits per second, used to measure the rate at which information moves between computers.

Bit

Abbreviation for **binary digit**. A bit is the smallest unit of information recognized by a computer, expressed as the digits 1 or 0.

Bits per second (bps)

The bit speed with which a device or channel transmits a character.

Board

In this manual, **board** and **card** are used interchangeably for the small printed circuit boards that can be added to the IBM PC or PS/2 family.

Boot

To bring up or restart the microcomputer.

Bootable

Used of a partition or disk to which command transfers at startup time. A diskette or partition is **bootable** if it contains the DOS files that will start the operating system when the IBM is powered on.

Buffer

Temporary storage for characters that need to be collected prior to processing.

Card

In this manual, **card** and **board** are used interchangeably for the small printed circuit boards that plug into the IBM.

Disk operating system (DOS)

An operating system for the IBM PC and PS/2 series of computers.

EBCDIC

Extended Binary Coded Decimal Information Code, a coding scheme wherein letters, numbers and special symbols are represented as unique six-bit values, allowing for standardization between data communications devices; used by the System 3X.

Emulation

The ability to make a host computer (such as the System 3X) recognize a microcomputer as one of its own terminals, printers, or other devices.

Driver

Software that controls a device.

Free key mode

State of a PC or PS/2 not varied on by the host.

Host computer

Primary or controlling computer in a multiple computer system upon which the smaller computers depend to allocate the resources of the system.

Hot Key

A key combination that provides the ability to cycle between PC-DOS applications and emulation without having to log off of the host. The IDEA Hot Key (default Shift-Shift) makes emulation resident and moves directly from the current session to DOS and back.

K or KB

Abbreviation for kilobyte: 1,024 bytes (characters) of information.

LU

Logical Unit, an emulated host session or device.

M or MB

Abbreviation for megabyte (1 million bytes or 1024 KB).

Offline

Used of communications devices not using a communications medium.

Online

Used of communications devices physically connected to and using a communications medium.

Parallel port

Interface located on a host adapter card used for connection with a parallel device such as a printer or mouse. It provides parallel transmission, which is simultaneous transmission of all bits in a byte.

Parity

Checking of whether the sum of bits is odd or even. The integrity of each character read or transmitted can be tested by generation and subsequent checking of character parity.

Peripheral

A noncomputing input or output device, such as a printer or hard disk drive.

Port

A connection that allows communications between the IBM and another device.

Protocol

Rules by which to exchange information, including the organization of units of data to be transferred.

Resident

Used of a program that is in live memory.

Serial port

Common serial communications interface used by devices such as modems and laser printers. It allows serial transmission, whereby data is sent in a regular pattern of bits.

Station address

A unique address in the range of 0–6. It identifies a System 3X terminal or printer on the TWINAX cable run to the System 3X.

System 3X

The IBM System/34, /36, or /38.

TWINAX

The IDEA emulation program or card. Twinaxial cable is a type of cable used in System 3X installations.

TWINAX run

A series of one or more devices all on the same twinaxial cable that connects to the controller.

Typematic

Repeating; keys such as the alphabet keys on a keyboard will repeat when held down.

Varied on

Recognized as ON or set ON by the host. The PC or PS/2 as an emulated terminal must be varied on by the host before the host will accept data from it.

Virtual disk or virtual floppy

Memory that appears to DOS as a single disk but is implemented by some other means.

Appendix H:

IDEA Products

For information or to order these products, contact your dealer or call IDEA at (800) 257-5027. In Massachusetts call 663-6878.

Communications Products

IDEAcomm 5251/Share is a resource sharing software package that allows as many as four PCs or PS/2s to access a System 34/36/38 via an IDEAcomm 5251 board.

IDEAcomm 5251/Gateway is a communications package to link PCs and PS/2s to an IBM System 3X on a network compatible with Netbios (such as the IBM Token Ring Network or PCnet).

IDEAcomm 5250/Remote allows remote connection to the System 3X via synchronous modem, with concurrent access for nine 5250 sessions and file transfer support for IBM's PC Support/36 and 38. Supports PC and micro channel versions.

IDEAcomm 5250/Remote Share allows four remote PCs to access a System 3X with only one 5250/Remote card.

IDEAcomm 5250/Remote Gateway allows four remote Servers and multiple users to access one or more System 3Xs via a Netbios compatible network.

IDEAcomm 3278 allows the IBM AT, PC, XT, or Portable to emulate all the functions of IBM 3179/3278/3279 terminals, plus APL keyboard support and IRMA compatibility mode. Available in both PC and micro channel versions.

IDEAcomm 3270/SNA offers remote communications with an IBM mainframe via synchronous modem, terminal and printer emulation with 8 concurrent host sessions. Available in both PC and micro channel versions.

IDEAcomm 3278/DFT offers coaxial communications with an IBM controller to provide 3270 terminal and printer emulation with 5 concurrent host sessions. Available on both PC series and micro channel.

IDEA Minicom is a versatile communications card that allows communications over telephone lines to IBM mainframes. Three software packages are available:

3270/BSC
3770/SNA
3780/BSC

Disks and Tape

IDEA's full line of personal computer hard disks is designed for the business environment where limited desk space is a fact of life. Extensive software is provided for formatting, partitioning, and backing up disks. Every disk product has IDEA's unique upgrade policy that allows users to trade up in capacity from one unit to another for the difference in price and a small handling fee.

10 to 120 MB fixed internal drives for the XT and AT, which may be combined in one system with tape or removable disk for backup.

Diskit 2, the latest Winchester technology in two removable 10MB disks, with a footprint just big enough to let a monitor ride on it.

Diskit 2 Plus, with all the features of Diskit 2, plus encryption.

IDEAtape, 60MB backup and retrieval (including file by file retrieval of image backup).

Multifunction Cards

IDEAmax 30 provides as much as 8 MB of expanded memory for the PC/XT and PS model 30, compatible with the Lotus/Intel/Microsoft expanded memory specification.

IDEAmax/MC provides up to 12 MB of extended memory for the IBM PS/2. As much as 8MB can be configured to provide expanded memory. It is fully compatible with IBM micro channel architecture.

IDEAmax AT is the only multifunction board for the IBM AT that gives you 16MB of memory (conventional, extended, or expanded), plus two serial ports and a parallel port.

IDEAmax Plus 30 provides as much as 8 MB of expanded memory with 2 serial and 1 parallel port. Fully compatible with Lotus/Intel/Microsoft expanded memory specifications.

IDEAmax Plus MC provides as much as 8 MB of extended memory for the IBM PS/2, with 2 serial ports. Fully compatible with Lotus/Intel/Microsoft expanded memory specifications.

IDEAmini is an I/O short card with one or two serial ports, printer interface, optional clock and game port.

IDEA Minimax, designed for the short slot in the IBM Portable, XT, or AT, lets you add up to 512K on a single card.

Appendix I: Customer Support Information

Telephone Support

If you have any problems using our product, please follow these steps before contacting our technical support staff.

1. Make sure your computer system meets all the hardware requirements listed in the manual.
2. Referring to your manual, carefully check all the cables to make sure they are connected correctly.
3. Complete the following checklist:
 - Software name _____
Serial number _____
Version number _____
 - Computer brand name _____
Model number _____
RAM (memory) _____ bytes
Operating system (name and version, e.g., P.C.-DOS version 2.0)

 - Manufacturer and model number of:
Video adapter board _____
Printer/Plotter _____
Expansion RAM board _____
Hard disk system _____
Modem _____
Other _____

-
4. Be sure you can answer the following questions:
 - Did the program ever work properly? If so, have you changed anything in your operating environment?
 - Did any error messages appear? If so, what were they?
 - What is the exact sequence of steps required to produce the problem?
 5. With your computer on and the software loaded, call the dealer from whom you bought the product. If the dealer is unable to assist you, call IDEA Technical Support at the number below.

Repair Policy

If your product is still under the original one year limited warranty, IDEA will repair or replace it at no charge. If the product is out of the warranty period, IDEA will repair it and charge you on a time and materials basis.

If you are having problems with your IDEA product, take the following steps:

1. Go through the checklist above.
2. Call your dealer for assistance.
3. If your dealer is not able to provide a solution, call the IDEA Technical Support Department at (800) 343-0056. In Massachusetts, call (508)-668-6878. (Be sure that you have the version and serial numbers from your software diskettes and from your IDEA hardware.) If the Technical Support representative determines that your product requires factory service, you

will be issued a Materials Return Authorization (MRA) number. IDEA will not accept returned products without an MRA number.

4. Box the product in the original shipping container or other secure package. Write your MRA number clearly on the outside of the box. For all warranty repairs, enclose a copy of the original purchase receipt as proof of date of purchase.
5. Ship by the most economical means to:

IDEAssociates, Inc.
MRA # _____
29 Dunham Road
Billerica, MA 01821

Once your product has been repaired, IDEA will return it to you by UPS or the most economical carrier at IDEA's expense.

Warranty Card

Please complete and promptly return the enclosed warranty card. The warranty card should be filed by the party who installs the IDEA product.

Limited Warranty

For IDEAssociates' Limited Warranty, see page iii of this manual.

Index

Numbers

3180 (wide screen) display, 6-5

A

ADDVDSK command, 9-9

ADF file, 3-3

AID (Attention Identification) key, E-5

Alternate station address, 4-11

Attribute appearance, B-7

Attributes, changing, 6-10

Attributes, displaying, 5-12

AUTOTWIN command, 5-19

B

Batch files within TWINAX, 5-18

Board defined, G-2

Boot defined, G-2

Bootable defined, G-2

C

Cable, connecting, 3-9

Card defined, G-2

Checklist of parts, 2-2, 3-2

Clear key, defining, F-7

Color attributes, changing, 6-10

Color attribute appearance, B-11

Color attribute mapping, 6-18

Column separator, changing, 6-17

Command Menu, 5-11

Condense key (Ctrl-M), 6-6

Configuration

 Changing, 4-7

 with IDEACFIG, 4-5

 with INSTALL, 4-2

Configuration with IBM Reference Diskette, 3-4
Configuration, saving
 Server, 4-20
 User, 4-20
Configuration, viewing from emulation, 5-14
Cursor type, changing, 6-17
Customer support information, I-1

D

Devices, configuring, 4-8
Diagnostics (TWINDIAG), A-14
Display attributes, changing, 6-10
Display, configuring, 4-8
Displays, 6-1
Displays, troubleshooting, A-1
Driver defined, G-3

E

EBCDIC/ASCII translation, 6-13
Emulation command TWINAX, 5-3
Emulation, ending, 5-7
Emulation, files, 5-1
Error messages
 IDEACFIG, A-24
 INSTALL, 4-4
 Printer, 7-6
 TWINAX, A-22
 TWINDIAG, A-17
EXIT command from emulation, 5-15
EXTENDED option of Command Menu, 5-12

F

FCC certification, ii
Field attributes, displaying, 5-12
File transfer, 9-1
File transfer package, configuring, 4-12
Freeing sessions, 5-13

G

Glossary, G-1
GR5292 graphics feature, 6-8
Graphics, using, 6-8

H

Hardware, micro channel, installing, 3-1

Host Session (LU), 4-9
Hot Key (Shift-Shift), 5-10
Hot Key, changing, F-6

I

I/O address, configuring, 4-16
I/O address, Rev. C card, D-5
I/O address, Rev. D and higher cards, D-2
I/O address, Rev. A, B, and older C cards, D-7
IBM Reference Diskette, using with micro channel,
3-4
IBM remote controller, attaching, A-25
IBM transfer package, configuring, 4-12
IDEA micro channel card, installing, 3-1
IDEA PC card, installing, 2-1
IDEACFIG configuration program, 4-5
IDEAcomm 5251 and 5251/Plus features, 1-1
INSTALL program, 4-2
Installation, micro channel hardware, 3-1
Installation, PC hardware, 2-1
Inventory checklist, 2-2, 3-2

K

K or KB defined, G-3
Keyboard layouts, B-1
Keyboard layouts, specifying, 4-19
Keyboard remapping (KYEDIT), F-1
Key click, specifying, 4-19
Keystroke buffering, 4-13
KYEDIT utility, F-1

L

Limited warranty, iii
Local Print feature, 7-8
Logical Units, moving between, 5-6

M

M or MB defined, G-3
Memory address, configuring, 4-16
Memory address, Rev. A, B, and older C cards,
D-7
Memory address, Rev. C card, D-6
Memory diagnostics from TWINDIAG, A-17

Messages

IDEACFIG, A-24

INSTALL, 4-4

Printer, 7-6

TWINAX, A-22

TWINDIAG, A-17

Micro channel card, installing, 3-1

Memory address, Rev. D and E cards, D-1

Monochrome attribute appearance, B-7

P

Parallel (printer) port, G-3

Parity defined, G-3

Peripheral defined, G-4

Playing back keystrokes, 5-16

Port defined, G-4

Power on reset, configuring, 4-17

Printer Control Panel, 7-2

Printer configuration, user-defined, 8-1

Printer diagnostics from Control Panel, A-7

Printer diagnostics from TWINDIAG, A-15

Printer diagnostics, System 3X, A-7

Printer, configuring, 4-8, 8-1

Printer, selecting, 4-14

Printer, troubleshooting, A-5

Printer, user defined, 8-1

Printer, using, 7-1

PrintScreen feature, 7-8

R

REMOVDSK command, 9-10

REVUP program, C-1

Record keys, saving, 5-14

Recording keystrokes, 5-16

Reference Diskette, using with micro channel, 3-4

Remapping color attributes, 6-10

Remapping the keyboard (KYEDIT), F-1

Remote IBM controller, attaching, A-25

Repair policy, I-2

Reserving sessions, 5-13

Reset, configuring, 4-17

Resident feature, 5-5

Return policy, I-2

S

SAVE CONFIGURATION feature of emulation,
5-13

SEND editor, E-1

SEND utility, 5-18

Serial (COM) port, G-4

Serial number, 2-1, 3-1

Shadow cursor, 3180, 6-7

Station address, 4-10

Status line, 5-8

Switch settings, D-1

T

Technical Reference Guide, ordering, 1-7

Telephone support, I-1

Termination of the card, 3-8

TWINAX emulation command, 5-3

TWINAX.UCM, updating with REVUP, C-1

TWINDIAG program, A-13

Twinaxial cable, connecting, 3-9

Typematic, defined, F-8

U

User Interface options of IDEACFIG, 4-16

V

VIEW SETUP feature of emulation, 5-14

VIRTUAL command from emulation, 5-14

Video adapters, 132 column, 6-6

Virtual disk, 9-1

Virtual disk, troubleshooting, A-4

W

Warranty, iii

WINDOWS feature of Command Menu, 5-12

Wide screen displays, 6-5

Window mode, setting for startup, 6-18

Windows, 6-1

Windows, saving the configuration, 5-14

Windows, troubleshooting, A-4

