



# TECHNICAL INFORMATION

## SURGE IN SOLID TANTALUM CAPACITORS

by John Gill  
AVX Ltd, Tantalum Division  
Paignton, England

### **Abstract:**

A detailed look at factors which can cause surge failures in Tantalum capacitors, how it can be diagnosed, and what can be done to prevent it occurring. Also an explanation of how surge affects the lifetime reliability of a Tantalum capacitor.

# SURGE IN SOLID TANTALUM CAPACITORS

by John Gill  
AVX Ltd, Tantalum Division  
Paignton, England

## 1.0 Introduction

With the introduction of high purity powders, automated assembly and real-time control systems, the base reliability of Tantalum capacitors has been increasing steadily in recent years. However, with the increasing usage of Tantalums in low impedance applications, the relative significance of the surge failure mode has also increased. With the present trend to use In Circuit Test machinery (ICTs) and fast rise time functional testers for board test purposes, the capacitors are more likely to experience a high current surge.

Another reason for the increasing level of awareness of the surge failure mode, is that Tantalum capacitors are increasingly being used in low impedance circuits, where previously Aluminum electrolytic capacitors were used. As a result they are more likely to see a surge condition. The change from Aluminum is because of their difficulty in conversion to surface mount technology packages.

**It should be noted that surge fall-out is characterized by initial failures at the first power up of the board during in house manufacturing test, while the remaining population continue unaffected during operational life.**

While the absolute ppm levels of failure would not normally be considered a problem, the failure mode in Tantalum capacitors is short circuit. Once a capacitor has become a short, if the current is not limited by a series resistance, the capacitor can overheat depending on the amount of fault power the capacitor has available to it. This makes the problem of concern to the industry.

Tantalum capacitor manufacturers have known of the problem for many years, and a great deal of Research and Development has gone into trying to understand the reason for the failure and a way of preventing its occurrence.

Investigation into surge failure has been complicated by the fact that Tantalum capacitors can "self-heal", and thus the failure could clear itself. One mechanism for this is given in Appendix 1.

Manufacturers have historically recommended 3 (or 1) Ohm/Volt resistance [16,17,20] be placed in series with each capacitor. This reduces the probability of a surge failure by limiting the amount of current available to the capacitor at switch on. Indeed for many years surge failures were not seen because the user either derated sufficiently or used the prescribed series resistor which prevented the failure occurring.

Manufacturers also recommend a voltage derating of

between 50 and 75% [16,17,18] be applied if the capacitor is likely to experience fast switch on from a low impedance source, for example using a 35 Volt rated capacitor on a 12 Volt rail. The effect of voltage derating in steady-state conditions is well known, but derating has been empirically shown to reduce the number of failures in dynamic applications also, as will be demonstrated later in this paper.

Many companies have been analyzing the problem and trying to find a total solution. This document summarizes these findings and discusses some of the factors which can decrease the probability of a surge occurring and also explains what effect surge can have on a capacitor.

## 2.0 Cause

The conditions which can cause some Tantalum capacitors to fail by this mode are either a fast switch on from a low impedance circuit or a current spike seen by the capacitor during its operation. To date, research into the failure mechanism has shown that there are many factors which are known to increase the probability of a Tantalum capacitor to suffer a failure due to surge conditions.

### 2.1 Where to look for a surge condition.

Surge current conditions most commonly occur during the testing of a fully assembled board. Since the introduction of in circuit test machines into the vast majority of manufacturing plants throughout the world, this is by far the most common source of failures returned to the manufacturer for analysis.

Specialized test procedures can also produce failures. A typical example occurred with a switch mode power supply manufacturer. Once the power supply was assembled, it was functionally tested by powering it up with maximum working voltage with a maximum current being drawn from the supply. The power supply was then short circuited to simulate the user applying a screwdriver directly across the output terminals of the power supply. When the discharge current through the capacitors was measured it was found to be in the range 80 to 100 Amps, and dependent upon the point in the power supplies working cycle the short was applied.

Another possible cause is when the capacitor is being used to supply the energy required to energize an inductor, for example a relay coil, a DC motor or a loud-speaker, particular if the inductor is turned on or off by

means of a transistor. In this case large discharge currents can be seen by the capacitor, which can cause failure.

Another cause is particularly prevalent in racked electronic systems. It occurs when a card is plugged into a live motherboard. It is known as "hot-plugging" and causes very large current transients to be seen by the capacitors on the card.

## 2.2 What makes the number of surge failures increase?

The three major factors which decrease the likelihood of surge failures are:

- (a) the amount of derating used by the circuit design engineer,
- (b) the dielectric thickness designed into the capacitor by the manufacturer, and
- (c) the circuit impedance in series with the capacitor.

But there are many others, such as the type of resin used as an encapsulant. If it has a significantly different expansion coefficient to that of Tantalum, then mechanical stress can be placed upon the Tantalum anode as the capacitor experiences thermal shock, which may result in internal damage to the anode, increasing the probability of a surge failure occurring.

The purity of the powder used also affects the surge performance, as it directly affects the capacitors' dielectric quality.

## 3.0 Effect

There are actually two theoretical mechanisms for a surge breakdown at present.

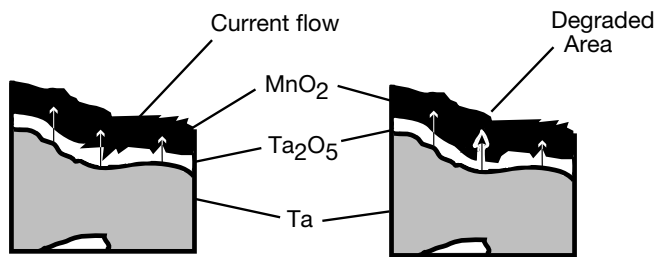

Figure 1. Cross section showing a degraded area of dielectric.

The first is a degraded dielectric due to an impurity in the original Tantalum powder. Figure 1 shows a section of dielectric, which is thinner than its neighboring sections due to an impurity in the Tantalum powder. When a large instantaneous current is now passed through the dielectric more current will pass through that thin section than its neighboring sections. This disproportionate amount of energy can cause self-healing to occur, as described in Appendix 1, or alternatively it can cause the capacitor to enter a thermal run away reaction which ultimately leads to failure of the capacitor.

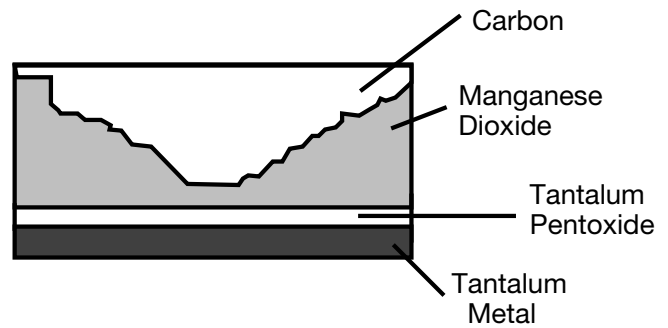

Figure 2. Cross section showing a degraded area of Manganese Dioxide.

The second is that a thin area of the negative electrode plate (Figure 2), Manganese Dioxide, plays a major role. In this theory, because the dielectric layer is uniform, the current is shared evenly throughout the anode. A thin area of dioxide has a lower resistance than a neighboring area, but power is  $I^2R$ , thus the dissipated energy is greater. Thus when a large instantaneous current flows, the power dissipated in the degraded area is higher than in neighboring areas. Again this causes a "hot spot" to develop and the dielectric to be broken down, ultimately leading to a short circuit failure. A more detailed explanation of these mechanisms is given in Appendix 3.

These areas of thin dielectric and manganese exist in all solid Tantalum Capacitors, and their presence does not mean that failures will occur. These features have been observed to be more prevalent in batches giving a higher fall-out on the accelerated surge test machinery used to ensure 100% of AVX SMT C, D, & E case product receives a minimum level of current surge.

When a Tantalum Capacitor fails it can become a short circuit. Thus a large amount of current can be drawn from the power supply. If this is not limited by means of a resistor, or power supply current limit, then the power will cause the capacitor to heat considerably. This may cause the capacitor's resin to blacken and char, which may be localized if associated with a low power level.

This is, of course, undesirable to both the Capacitor Manufacturer and the User. Again it should be remembered that this is a low ppm problem in certain applications only, thus the total number of capacitors affected is very small.

One way of reducing the probability of the Customer experiencing failures is for the Manufacturer to implement a screening program. Another is for the customer to apply derating, as stated in the introduction, or use a specialized part or if the problem is only associated with ICT machines then perhaps modify the voltage profile of the ICT or add resistance in the power line. All these reduce the incidence of failure still further.

Where the possibility of any heat damage or short circuit is required to be absolutely eliminated then AVX, along with several other manufacturers, has developed and introduced a fused range of capacitors.

These are designed to fail open circuit and not burn. For further information see Ian Salisbury's paper [15].

## 4.0 Cure

### 4.1 From the Manufacturer's viewpoint...

#### 4.1.1 Tantalum powder purity.

As we stated in section 3.0, impurities in the Tantalum powder used to produce the capacitor are believed to cause points of lower dielectric strength to form, which during rapid turn-on conditions can lead to a dielectric breakdown. Over the last 10 years the impurity levels of all major contaminants in the tantalum powder have been reduced by joint development programs with the powder suppliers. The leakage current of a sintered Tantalum anode can be measured, and the level of this current is a good measure of the dielectric quality, and hence of the impurity levels. Figure 3 shows a comparison of the wet leakage current levels of a standard powder in use in previous years and one of the new high purity powders presently in use.

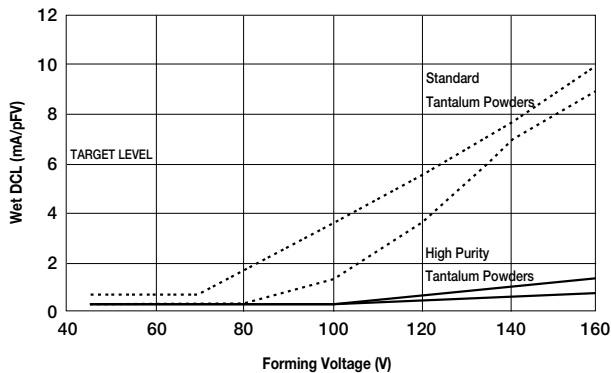

Figure 3. Wet leakage current against formation voltage.

These programs are of course ongoing and further improvements are planned.

#### 4.1.2 Dielectric thickness.

To illustrate this factor four control batches of capacitors were made under the supervision of the Research and Development department at AVX. The batches were made the same capacitance value, but with different dielectric thicknesses (controlled by the forming voltage, the higher the value the thicker the dielectric). 500 units from each of the batches were then "surged" in the accelerating surge failure circuit described in Appendix 2 at rated voltage, and 75% rated voltage. To determine any relationship between power supply current limit and the number of failures, 500 units from each batch were also surged at a higher current limit and 75% rated voltage. The results are shown in Table 1.

The four batches were all 47 $\mu$ F capacitors and their rated voltage was 16 Volts. This capacitor was chosen because it is the highest CV value (752  $\mu$ FV) manufactured in the D case package, and thus has the largest surface area. The more surface area the greater the probability of a weak area in the dielectric. It is also one of the most popular ratings.

**Table 1.**  
**Dielectric thickness against surge voltage**

Capacitor Working Voltage (V)	16	16	16	20
Formulation Ratio	3.4 : 1	3.8 : 1	4.1 : 1	4.3 : 1
Formulation Voltage (V)	54.4	61.2	65.7	87.1
Dielectric Thickness (nm)	<b>92.5</b>	<b>104.0</b>	<b>111.7</b>	<b>148.1</b>
12V Current Limit = 3A	0.4%	0.2%	0%	0%
12V Current Limit = 5A	0.4%	0.2%	0%	0%
16V Current Limit - 3A	6.8%	6.6%	2.4%	0.2%

It can be seen from Table 1 that as the forming voltage increases, the number of failures decreases. It can also be seen that as the derating is increased, fewer failures occur. Derating will be discussed in more detail later in this paper.

The two sets of results in Table 1 for the 12 Volt surge (25% derating) show that the current limit set on the power supply has no effect on the number of failures which are seen. This is due to the relative slowness of the vast majority of power supply current limiting circuits (usually of the order of milliseconds) compared with the microseconds it takes to reach the peak current.

All that the power supply's current limit does is limit the fault current which is seen by a failed Tantalum capacitor. The more fault power available to the capacitor, the more catastrophic the failure will be [7]. At low fault powers it may be seen only as a slight crack in the casing, at higher fault powers the exterior of the capacitor may become completely charred.

#### 4.1.3 Ensuring an even Manganese Dioxide coat.

Since the introduction of the 100% surge testing at AVX (the original equipment used did not distinguish surge fallout from the normal line fallout at final test) it has become possible for AVX to characterize individual batches for this parameter. This is due to the development of dedicated equipment capable of dynamic testing of capacitors, at low series resistance with test statistics being maintained for the individual batches. In addition, this fallout statistic can be monitored using statistical methods, such as SPC, on a code by code basis.

Methodical failure analysis of the surge fallout compared to capacitors which exhibited satisfactory performance revealed a common trend, standard in the external manganese dioxide coating, for failed parts.

Although the average manganese thickness was consistent over all the anode area surfaces, these parts typically demonstrated larger variations in porosity and morphology of the outer layers, as shown in Figure 4.

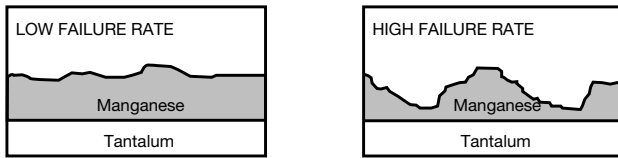

Figure 4. Variations in Manganese layer.

Again it should be remembered that these areas of thin manganese exist in all solid Tantalum capacitors, and their presence does not mean that failure will occur.

The Manganese Dioxide layer is built up by dipping the anodized Tantalum pellet into varying specific densities of Manganese Nitrate solution. The Nitrate is then decomposed to Dioxide by heating the pellet. By varying the specific densities and number of dips it is possible to finely adjust the coverage of the Tantalum pellet with Dioxide to ensure an even thick layer on the outer surface, and excellent coverage of the surface inside the pellet. This is then verified by means of a scanning electron microscope sample from each batch of processed anodes.

#### 4.1.4 Surge screening.

This is where the Tantalum capacitor manufacturer tries to simulate the conditions seen at the customer by simulating a worst case surge scenario. Test methodology already in existence has required much refining as it was not geared to current applications or 100% test capability.

This is one area that is not clearly defined by the Tantalum Industry at present. Each Tantalum capacitor manufacturer has their own set of conditions for this test.

For example, one standard test requires 24 sample units to be connected in parallel to a very large reservoir capacitor through a mercury wetted relay. The reservoir capacitor is charged to 1.3 times the capacitors' under test rated voltage. The total circuit resistance seen by the first capacitor under test, and the reservoir capacitor is less than 0.1 Ohm. As will be shown later in section 4.3.1, this means that the first capacitors in line will receive a very large transient current, but the capacitor farthest away will see very little. As such, the test unequally stresses the capacitors.

#### 4.1.4.1 What screen conditions does AVX use?

AVX uses a circuit as shown in Figure 5.

The test sequence is as follows:

- The 2200 $\mu$ F capacitor is charged to the capacitor's rated voltage.
- The probes are brought down onto the capacitor under test. The switching FET is OFF at this stage so no current will flow.
- The FET is turned ON, thus allowing current to flow and the capacitor to charge.
- The current is monitored by means of the 0.1 $\Omega$  resistor in the source log of the transistor and the part dynamically sentenced according to the following rules. Figure 6 shows the expected current waveform. Figure 7 shows a part which has not received the minimum level of surge current, possibly due to a bad contact, this part will be rejected. Figure 8 shows a part which has failed, because the current has not fallen to around zero after a set time delay.
- The FET is turned OFF, thus stopping the charging process.
- Finally, the probes are lifted and the process starts again with the next capacitor.

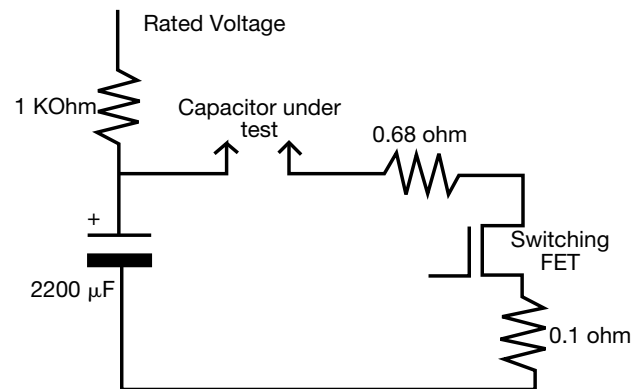

Figure 5. Circuit schematic

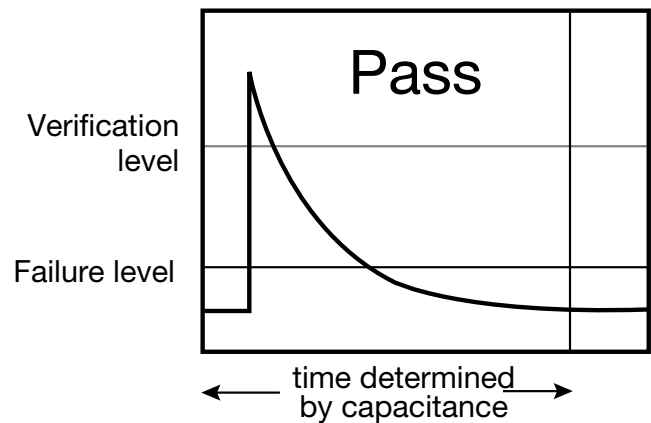

Figure 6. A Pass profile

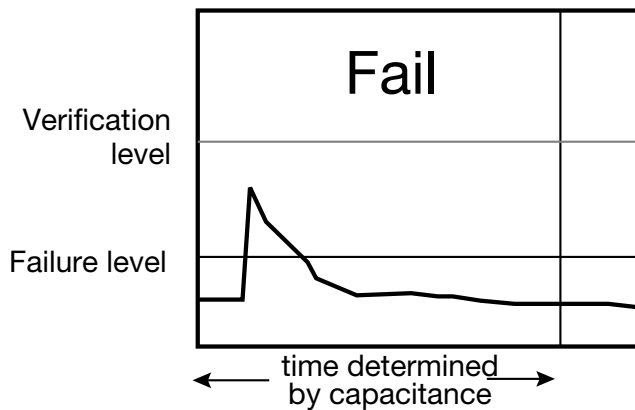

Figure 7. Not enough current seen

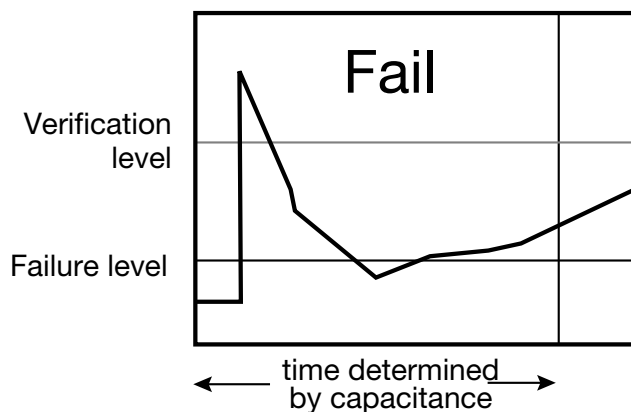

Figure 8. Part failed due to surge mechanism

AVX uses a circuit as shown in figure 5 to test large case size surface mount (chip) product. The lower case size chips inherently have a high ESR which self limits the maximum surge current the capacitor can see, and as such are not tested in the same way. Dipped product use a similar circuit to the large case size chip tester.

The reason for not testing parts in banks (in parallel) will become clear in a following section. The method used by AVX provides verification that 100% of capacitors have survived a minimum level of current surge and gives valuable feedback to the manufacturing engineers on a statistical basis to further enhance the process and design parameters.

#### 4.1.4.2 How many surges should the capacitor receive?

The vast majority of surge failures occur on the first surge, as reported in 1980 by H. W. Holland[1] as occurring on the first pulse. Since then experiments carried out at AVX have shown that even under accelerated conditions this percentage has grown to almost 100%. This is due to the improvement of capacitor technology and the increasing severity of the surge screen test picking up more of the potential failures. The results of a trial of 578,676 capacitors carried out recently prove

this. The capacitors were passed through the previously described surge equipment (section 4.1.4.1) 3 times at maximum stress and the number of failures recorded at each stage.

Thus 99.2% were seen to fail on the first surge and 0.8% subsequently. These figures were determined using a piece of equipment designed to induce failures.

In standard designs (where less current is available and 50% derating is incorporated, see 4.2.1) the acceleration is less aggressive and residual failures after the first surge are unlikely. As such, field surge failures are extremely rare and any residual surge failure is usually confined to manufacturers' testing of completed boards.

State of the art surge testing, as used at AVX, thus includes several acceleration factors over that of a typical customer ICT or functional tester.

In addition to the acceleration factors, product is tested 100% through this system, prior to the final parametric test sequence (see appendix 2).

#### 4.1.5 Leakage current.

A commonly held misconception is that the leakage current of a Tantalum capacitor can predict whether or not the unit will fail on a surge screen. Although the short circuit failure mechanisms can, under lower stress conditions, be so localized as to still allow good readings for other parameters, the resultant leakage current will be high. This fault current is independent of the initial leakage characteristics as shown by the results of an experiment carried out at AVX on 47 $\mu$ F 10V surface mount capacitors. The results are summarized in Table 2.

**Table 2.**  
**Leakage current vs number of surge failures.**

	Number tested	Number failed surge
Standard leakage range 0.1 $\mu$ A to 1 $\mu$ A	10,000	25
Over Catalog limit 5 $\mu$ A to 50 $\mu$ A	10,000	26
Classified Short Circuit 50 $\mu$ A to 500 $\mu$ A	10,000	25

It must be remembered that these results were derived from a highly accelerated surge test machine, used to induce a measurable failure rate.

## 4.2 From the user's viewpoint...

### 4.2.1 Derating.

Most manufacturers of Tantalum capacitors recommend that on a particular voltage rail, say 5 volts, a capacitor rated at twice that value (10 volts in this case) be used, if the capacitor is likely to be subjected to a rapid turn-on from a low impedance source. The capacitor is said to be derated by 50%.

Derating is

$$\left(1 - \frac{\text{user's working voltage}}{\text{capacitors rated voltage}}\right) \times 100\%.$$

The reason for this is that experience has shown that a Tantalum capacitor is less likely to fail the higher the derating applied.

A 10 volt capacitor has a thicker dielectric than a 6.3 volt part, and as such the probability of a defect site existing which has a low enough activation energy to cause a short circuit when 5 volts is applied is lower than with the 6.3 volt part. Thus there are fewer failures than when a 10 volt part is placed on a 5 volt rail and a surge applied, than when a 6.3 volt part is subjected to the same conditions.

Derating can best be summed up by Table 3.

**Table 3.**

Voltage Rail	Working Cap Voltage
3.3	6.3
5	10
10	20
12	25
15	35
≥24	Series Combinations (11)

**Recommended derating table.**

Results of experiments, like those in Table 1, show this rule's effect on the surge fall-out.

This experiment was scaled up using production equipment with several million capacitors being tested. The results are shown in Table 4.

**Table 4.**

Capacitance and Voltage	No. of units tested	50% derating applied	No derating applied
47µF 16V	1,547,587	0.03%	1.1%
100µF 10V	632,875	0.01%	0.5%
22µF 25V	2,256,258	0.01%	0.3%

**Results of production scale derating experiment**

As can clearly be seen from the results of this experiment, the more derating applied by the user, the less likely the probability of a surge failure occurring.

It must be remembered that these results were derived from a highly accelerated surge test machine, and ICT failure rates in the low ppm are more likely with the end customer.

An example: a major manufacturer was experiencing a 4100 ppm failure rate with 22µF 20V product. This part was used on both the 12 and 5 volt rails. When the application was examined more closely it was seen that the failure rate on the 5 volt line was only 20 ppm. 25 volt parts were supplied for trial with the customer who reported that the failure rate had dropped down to 231

ppm. This clearly shows that when the 50% derating rule is applied failure can be dramatically reduced, and by close cooperation between the customer and supplier, this can be eliminated altogether.

An added bonus of increasing the derating applied in a circuit, to improve the ability of the capacitor to withstand surge conditions, is that the steady-state reliability is improved by up to an order. Consider the example of a 6.3 volt capacitor being used on a 5 volt rail. The steady state reliability of a Tantalum capacitor is affected by three parameters; temperature, series resistance and voltage derating. Assuming 40°C operation and 0.1Ω/volt of series resistance, the scaling factor for temperature will be 0.05 and for resistance unity. The factor for derating will be 0.15. The capacitor's reliability will therefore be

$$\begin{aligned} \text{Failure rate} &= F_U \times F_T \times F_R \times 1\%/1000 \text{ hours} \\ &= 0.15 \times 0.05 \times 1 \times 1\%/1000 \text{ hours} \\ &= \frac{7.5 \times 10^{-3}}{1} / 1000 \text{ hours} \end{aligned}$$

$$\text{or an MTBF of } \frac{1}{7.5 \times 10^{-3}} \times 1000 = 133,333 \text{ hours}$$

If a 10 volt capacitor was used instead the new scaling factor would be 0.017, thus the steady-state reliability would be

$$\begin{aligned} \text{Failure rate} &= F_U \times F_T \times F_R \times 1\%/1000 \text{ hours} \\ &= 0.017 \times 0.05 \times 1 \times 1\%/1000 \text{ hours} \\ &= 8.5 \times 10^{-4} / 1000 \text{ hours} \end{aligned}$$

$$\text{or an MTBF of } \frac{1}{8.5 \times 10^{-4}} \times 1000 = 1176,470 \text{ hours}$$

So there is an order improvement in the capacitor's steady-state reliability.

*4.2.2 Voltage profile shaping.*

Figure 9 below shows the profile of a 33µF capacitor subjected to a 12 volt fast turn-on voltage profile with 1 Ohm of circuit resistance in series with it. It can be seen that the peak current is about 12 Amps.

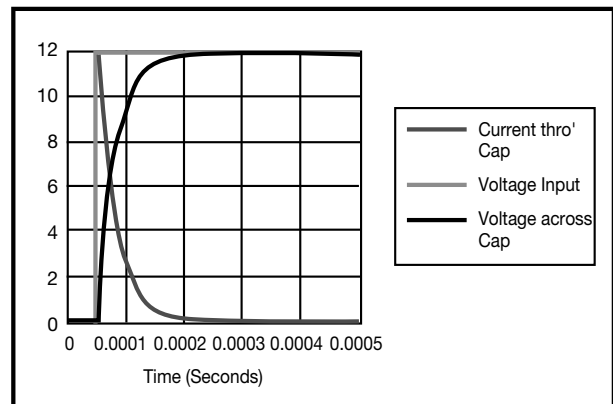

Figure 9. 33µF capacitor, 12 Volt surge, 1 Ohm resistance.

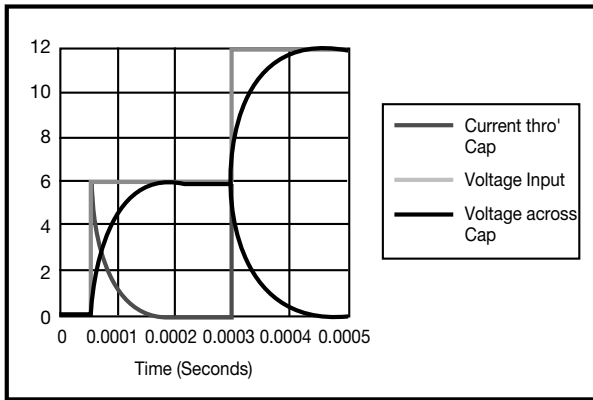

Figure 10. Two stage turn-on for a 33µF capacitor

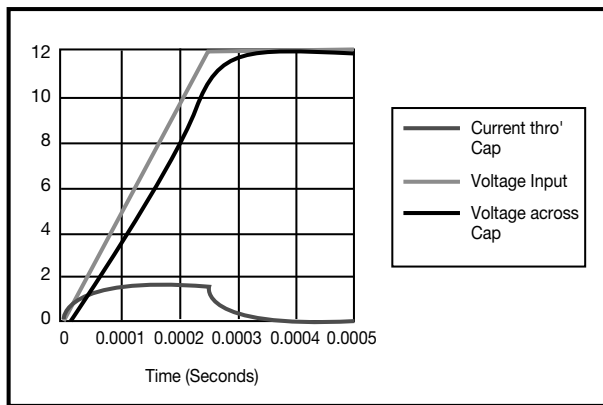

Figure 11. Ramp profile for a 33µF capacitor.

If the profile were then modified to be a two stage turn-on, see Figure 10, the capacitor would then be subjected to two current surges of peak amplitude 6 Amps. This is a less severe test, and even though the capacitor is experiencing twice the number of surges the probability of a failure is less.

Figure 11 shows a voltage profile which is slowly ramped up to its final value. In this case the peak current is less than 2 Amps, and thus this is the least severe of the test conditions. It should be remembered that the slower the ramp up the lower the probability of a failure.

This method of reducing the probability of failure is again of course out of the hands of the Manufacturer, however, he must be aware of the various factors which may cause surge. Thus the voltage and current profiles of a board experiencing failures can help when diagnosing the failure mechanism.

#### 4.2.3 Series Resistance.

The peak current and rise time of the voltage profile are determined by the amount of circuit resistance in series with the capacitor. The instantaneous peak current at turn-on will be limited by the capacitors ESR and the series resistance, thus the peak current can be calculated from Ohms Law.

Example: a 33µF 20V capacitor with a maximum ESR value of 200 mΩ at 100KHz is used on a 10 Volt power line. The power is supplied to the card through a motherboard. Power is supplied to the motherboard by a linear regulator which has an output impedance of 150 mΩ. The contact resistance of the motherboard connector is 100 mΩ maximum. The daughter board's connector has a similar contact resistance. The track resistance is estimated at 50 mΩ maximum. This gives a maximum circuit resistance, external to the capacitor of 150 + 100 + 100 + 50 = 400 mΩ. The theoretical peak current is:

$$\text{Equivalent resistance} = 0.4 + 0.2 = 0.6 \Omega$$

$$\text{Peak current} = \text{Voltage/Resistance} = 10/0.6 = 16.7 \text{ Amps}$$

From this example calculation it is obvious that the larger the series resistor the smaller the peak current, and thus the less likely the capacitor will be to fail.

Example: a major disk drive manufacturer was experiencing problems with 47µF 16V capacitors being used on a 12 volt rail. The capacitor had a 2.2Ω resistor in series with it, across a 12 volt rail. The 12 volt rail supplied the drive motors, which were turned on and off by means of FETs. The resistor was changed to 10Ω, which still allowed the circuit to be operated within its design parameters, but prevented the capacitors experiencing the rapid discharge when the motors were turned on. The failures stopped. Another solution to this would be to redesign the board and utilize two 22µF 25V capacitors of the same case size in parallel to provide the minimum 50% derating that is recommended (as described in section 4.2.1). In highly inductive circuits such as this with no additional resistance available then derating up to 70% may be necessary.

Of course it is usually not possible for the customer to insert a series resistor in his power supply line. But, the customer could reduce the peak current by altering the voltage profile using methods which were described in section 4.2.2.

On one occasion it was necessary for a customer to measure the profile of his ICT tester for a particular board. As no current probe was available a 1Ω resistor was placed in series between the return path from the board and the ICT machine's power supply's ground terminal. Measurements were made but no unusual stresses were seen in the boards tested could be found. However, after the measurements had been made, the line ppm was seen to drop dramatically. During a follow up visit, it was noted that the 1Ω resistor had been left in place, which thus provided an effective example of series resistance reducing surge fall-out.

Most power supplies, and a large number of plug in boards, now have a diode between the power line and the capacitor. This acts as a series resistance during the surge condition. Figure 12 shows the surge on a 22µF 25V capacitor, running on a 10 volt rail in a telecommunications line conditioning card. In the circuit there was no diode. Figure 134 shows the same circuit with a 1N4001 diode in series between the connector and the capacitor.



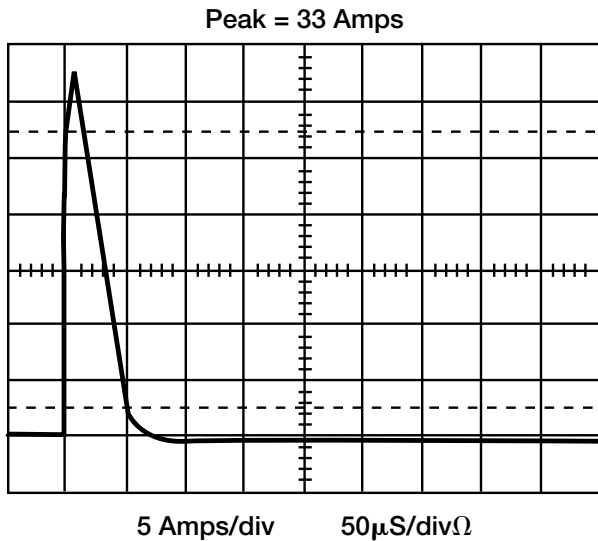

Figure 12. Current waveform without diode.

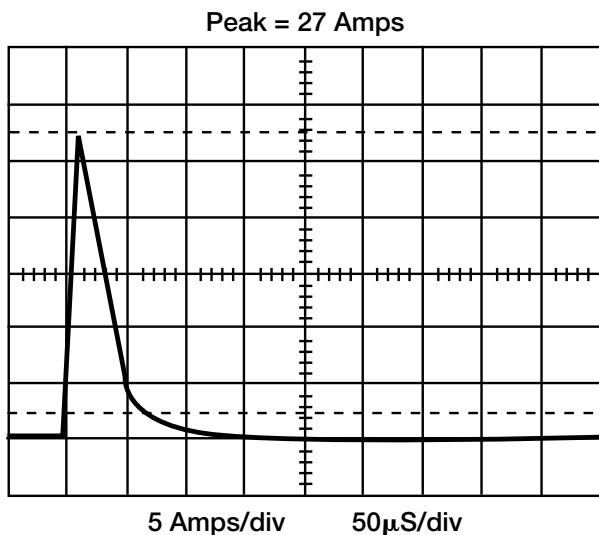

Figure 13. Current waveform with diode

If the resistance is then calculated for these two waveforms, using Ohm's Law, Figure 12 yields 300m $\Omega$  and Figure 13 yields 370m $\Omega$ . It can thus be assumed that the diode has added 70m $\Omega$  to the circuit.

This example shows that a diode may only contribute as little as 70m $\Omega$  of series resistance to a circuit and thus the capacitor can still experience the large current surges which can cause failures.

### 4.3 From the application viewpoint...

#### 4.3.1 Capacitors surged in parallel.

In the vast majority of applications, a board will have more than one capacitor on each power rail. These capac-

itors are generally scattered throughout a board.

When a failure is reported, if the surge mechanism is the culprit, it will be noticed that one location fails more frequently than the other capacitors on the same voltage line. The usual location is that nearest to the connector through which power is applied.

To illustrate the reason why this is the case, a test board was constructed with three 22 $\mu$ F 25V capacitors in parallel on a piece of strip board. The capacitors positive terminals were connected to the strip board by pieces of wire to enable a current probe to be used for monitoring the current through each capacitor during a fast turn-on condition.

The resulting waveforms are shown in Figures 14, 15 and 16.

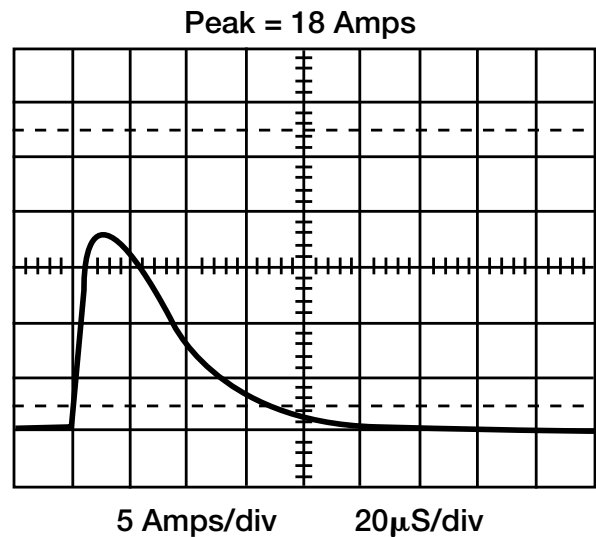

Figure 14. Current through First Capacitor

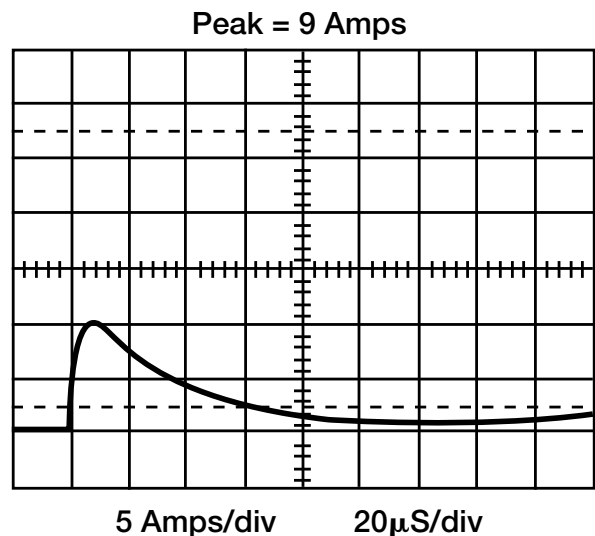

Figure 15. Current through Second Capacitor.

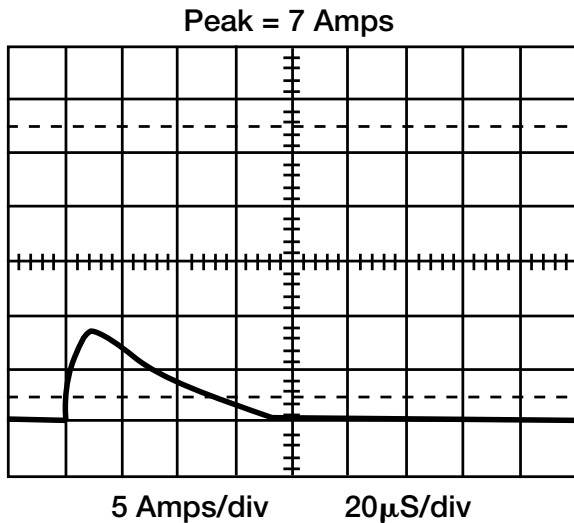

Figure 16. Current through **Third Capacitor**.

As can be clearly seen the capacitor nearest the power supply takes the “lion’s share” of the available current and the farther away from the power supply the capacitor is, the less severe the current surge condition seen. It is for this reason that the capacitor nearest the power supply usually fails more frequently than the others.

### 5.0 Steady-State Reliability of Tantalum capacitors subjected to single and repetitive surges

The reliability of screened Tantalum capacitors is the same as unscreened components[5]. Thus they have identical failure rates and life expectancies. It only reduces the capacitors’ probability of failing due to the surge mechanism.

50 x 22μF 25V capacitors were surged 500 times at rated voltage and 20 Amps. Another sample of 50 pieces was subjected to 10,000 surges at rated voltage and 20 Amps. These were submitted to an independent test house for life test analysis together with a control sample which had received no surges. The results showed that there was no detectable difference between the three samples. That is to say the steady state reliability of the capacitors had not been affected.

## 6.0 Conclusions

- (1) The only real way to screen for components likely to fail under turn-on conditions in low impedance circuits which have a high current availability is to 100% test capacitors manufactured, and verify that the parts have received the required screening current.
- (2) Capacitors should be individually tested by the manufacturer otherwise the current is shared between all the capacitors under test. This makes the test less severe, and the screening less effective.
- (3) The customer should use a derating of 50% where the capacitor is likely to experience a current surge condition and in highly inductive circuits this may need to be increased to 70%.
- (4) The current limit of the power supply should be set to the minimum required to power the board under test, as the lower the current limit the less severe the consequences of a surge failure.
- (5) If possible the voltage profile should be a ramp turn-on, as this reduces the peak current seen by the capacitor.
- (6) **Don’t always assume that the failure is due to surge**, it may be a random failure. A surge failure will mainly occur the first time the board is powered up, particularly if an ICT “shorts/open circuit test” on the board previously showed all components to be good. Surge failures will, however, tend to occur at the specific high stress locations rather than randomly over the board.
- (7) Because derating is one of the biggest contributing factors to irradiating surge failures, AVX has embarked on a program of producing extended range capacitors, specifically for this type of circuit location. For example, AVX was the first manufacturer to produce a 22μF 25V capacitor in a D case, and also has an E case capacitor which allows a 22μF 35V capacitor to be available to the designer.

## Acknowledgements

The Author would like to thank Mr. W. A. Millman, Mr. S. Warden and Mr. M. Stovin, all of AVX, for their assistance in the production of this paper.

## Further reading

- [1] H. W. Holland, "Effects of high current transients on solid Tantalum capacitors", Kemet, 1976.
- [2] B. M. Mogilevsky & G. A. Shirn, "Surge Current Failure in Solid Electrolyte Tantalum Capacitors", IEE Transactions on Components, Hybrids and manufacturing technology, Vol. CHMT-9, No. 4, December 1986.
- [3] Y. Hasegawa, "A Study of Field Failures of Solid Tantalum Capacitors", NEC Res. & Develop., No. 82, July 1986.
- [4] J. D. Moynihan, "Unshackle the Solid Tantalum Capacitor", Sprague, 1979.
- [5] J. D. Moynihan, "Life evaluation of Solid Tantalum Capacitors under ON-OFF cycled conditions", Sprague.
- [6] Dr. A. M. Holladay & J. D. Moynihan, "Effectiveness of Surge Current Screening of Solid Tantalum Capacitors", Sprague TP83-2.
- [7] R. W. Franklin, "Over-Heating in Failed Tantalum Capacitors", AVX.
- [8] R. W. Franklin, "Upgraded surge performance of tantalum capacitors", Electronic Engineering, 1985.
- [9] R. W. Franklin, "Screening beats surge threat", Electronics Manufacture & Test, June 1985.
- [10] R. W. Franklin, "Surge current testing of resin dipped Tantalum Capacitors", CARTS 1985, p147-154.
- [11] J. A. Gill, "Investigation into the effects of connecting Tantalum capacitors in series", AVX.
- [12] "Tantalum Capacitors Technical Summary", AVX.
- [13] C. Reynolds, "Reliability Management of Tantalum capacitors", AVX.
- [14] I. Salisbury, "Thermal Management of Tantalum capacitors", AVX.
- [15] I. Salisbury, "Analysis of fusing technology for Tantalum capacitors", AVX.
- [16] Panasonic capacitors, "Technical guide of Tantalum electrolytic capacitors", First edition, July 1992, Matsushita/Panasonic capacitors, p38.
- [17] "Tantalum Capacitors Technical Summary", AVX.
- [18] Hitachi, "TMC series" data sheet, CAT-No. 0502-6209-3KT, p3.
- [19] D. Richardson, "Low ESR surface mount solid Tantalum capacitors", CARTS 1994, p93-98.
- [20] "Aluminum - und Tantal - Elektrolyte" Kondensatoren Datenbuch 1989/1990, Siemens.

# Appendix 1

## Self-healing in Tantalum Capacitors

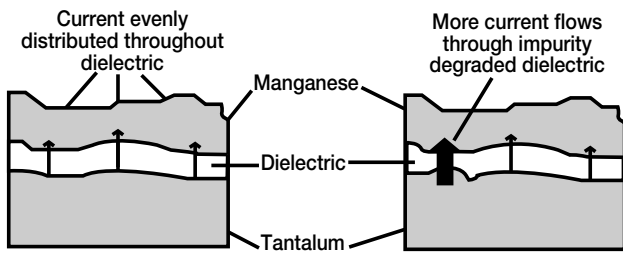
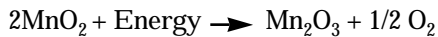

Figure 17. Cross section showing a degraded area.

If there is an area on the Tantalum “slug” (the industries term for an anode) which has a thinner dielectric than the surrounding area, then the larger proportion of the capacitor’s current (charging, leakage, etc.) will flow through that site, see Figure 17, thus that area will heat up. If the temperature at the fault site increases to between 400 and 500°C then a reaction [3] takes place which converts the conductive Manganese Dioxide, which has a resistivity of between 1 to 10 Ohm/cm<sup>3</sup>, to the less conductive Manganese Oxide (Mn<sub>2</sub>O<sub>3</sub>) which has a resistivity of between 10<sup>6</sup> - 10<sup>7</sup> Ohm/cm<sup>3</sup>. Thus the defective site is effectively “plugged” or “capped”, as shown in Figure 18, and the fault site clears.



The oxygen produced is used up by any Tantalum oxides other than Tantalum Pentoxide (Ta<sub>2</sub>O<sub>5</sub>) present in the capacitors dielectric layer, such as TaO<sub>2</sub> or any Mn O in the cathode coating.

This can also occur at sites where cracks have appeared in the Ta<sub>2</sub>O<sub>5</sub> dielectric due to mechanical stress being placed on the component during temperature cycling, due to the different expansion coefficients of the materials used (particularly the resin).

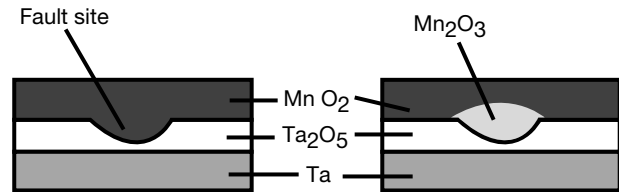

Figure 18. Schematic showing a healed site.

# Appendix 2

## The development of a surge accelerator and test method.

Because of the low levels of failure being dealt with, a way of accelerating the number of failures which are seen had to be found. The factor known to influence the number of surge failures most is the circuit series resistance. Thus a 'zero' series resistance surge tester was designed for use as the accelerator. The circuit resistance was, of course, not zero, however multi-ganged FETs were used together with thick copper cabling between the power supply and the capacitor under test. The reservoir capacitor used was a 10,000 $\mu$ F, 100V low-ESR (<21 m $\Omega$ ) Aluminum capacitor. In this way the resistance was kept to below 200 m $\Omega$ . A circuit schematic is shown in Figure 19.

Relays were not used as the method of switching because of their unreliable nature, and also to cut out any possibility of contact bounce. The FETs were driven hard to ensure a fast turn-on time. The capacitors were tested at their rated voltage. No derating was applied (except where the test condition was to show the effect of derating on a surge performance).

An additional result from the analysis of the data showed that the surge test must be applied 100% to be effective.

Although it has been shown that some batches do suffer more from surge failure than others, it has also been proven that there is capacitor to capacitor variation within a batch. Thus a sampling technique is not really applicable to surge screening. This is particularly true since the number of failures is at the ppm level.

Example: If the fall-out generated for a given batch by surge screening is 100 ppm, the probability of a capacitor failing is 0.0001. If an average batch size is 10000 units, then the number of failures likely in a batch is 1. If each batch is checked by sampling 50 units at random then the probability of catching that failure is 0.005. That is, **the odds on missing faulty units would be 200 to 1.**

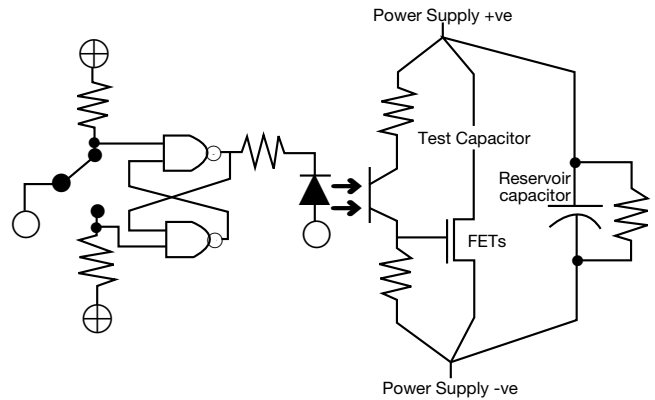

Figure 19. Schematic of the accelerated surge tester.

A failure was defined as being a component which exhibited a voltage or current profile which was not the norm or a component which when measured was outside the components limits.

# Appendix 3

## Surge Breakdown in Tantalum Capacitors

### a) Manganese

Methodical failure analysis of the surge fallout compared to capacitors which exhibited satisfactory performance revealed a common trend standard in the external manganese dioxide coating of the failed parts. Although the average manganese thickness was consistent over all anode surfaces, these parts typically demonstrated larger variations in the porosity and morphology of the outer layers:

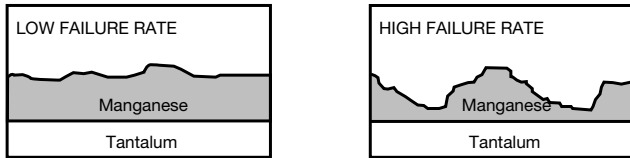

Chemical stripping of the failed parts to expose the dielectric scars indicated a failure location pattern:

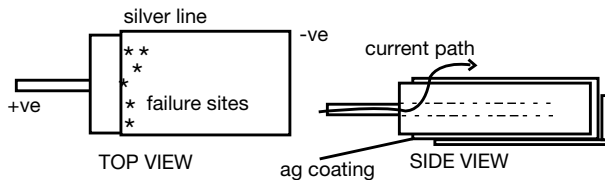

The failure sites were noted to be a single point, intense breakdown area coincident with the current flow path of least resistance between the positive termination wire and the external cathode silver coat.

In order to further understand the association of the visual information collected as compared to the occurrence of surge related failures, a possible model was created.

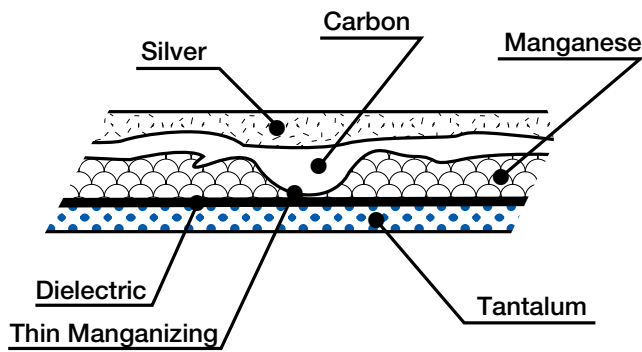

Figure 20.

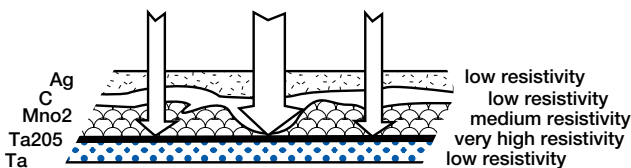
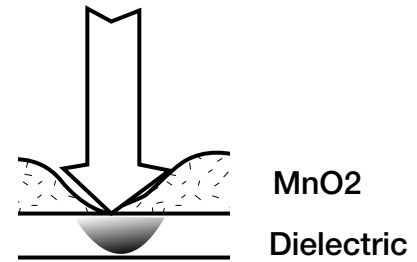

Figure 21.

Figure 20 illustrates an area of thin manganizing on the external body of the Tantalum capacitor, infilled with the higher resistivity coating.

Figure 21 illustrates the uneven current distribution that occurs during a rapid switch-on from a low impedance source. More current will flow locally as indicated by vector B producing a localized "hot spot" as described in Figure 22.



Localized "HOT SPOT"

Figure 22.

The intense local current causes an increase in local temperature due to Joule heating at the point of thin manganizing. If this temperature reaches a sufficiently high level, the normally amorphous dielectric will be converted to its crystalline phase and may develop an extremely localized conductive track through the dielectric, at that site. The probability of developing such a site is also proportional to the intrinsic impurity level of the dielectric. In applications where series resistance is incorporated, this can initiate a self healing mechanism. However, if the current availability is unrestricted, then further heating will occur and the area of affected dielectric will increase until catastrophic failure occurs.

### (b) Dielectric

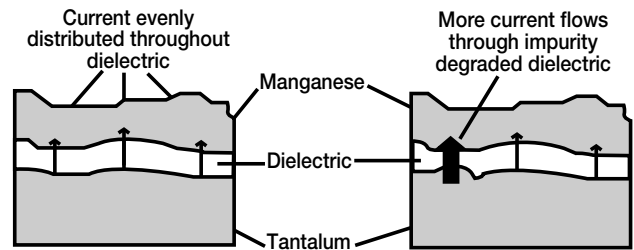

Figure 23. Cross section showing a degraded area.

If there is a degraded area of dielectric (Figure 23), perhaps due to an impurity in the original Tantalum powder used to manufacture the capacitor, and the capacitor is subjected to a rapid charge, more of the current will pass through the degraded area than the neighboring areas of dielectric. This causes the degraded area to heat up.

If the energy has been limited by addition of external

series resistance or sufficient derating has been, the capacitor can self heal, as described previously in Appendix 1. If, however, this is not the case the extreme heat generated causes the Tantalum Pentoxide dielectric layer to change state from the amorphous state to a crystalline state. The crystalline oxide has a lower density than the amorphous oxide, and thus a crack appears in the dielectric.

This allows more current to flow, thus more heat is generated, and more oxide changes to the crystalline form.

The final outcome is that the capacitor becomes a short circuit.

The level of current (or power) then applied to the capacitor determines whether the unit suffers minimal damage, chars or flames. R. W. Franklin's paper on overheating in failed Tantalum capacitors[7] shows that a TAJ surface mount capacitor can withstand 1 Watt with no external damage, but above this level charring will occur.

These areas of thin dielectric and manganese exist in all solid Tantalum capacitors, and their presence does not mean that failures will occur. These features have been observed to be more prevalent in batches giving a higher fall-out on the accelerated surge test machinery used to ensure 100% of AVX product receives a mini-

NOTICE: Specifications are subject to change without notice. Contact your nearest AVX Sales Office for the latest specifications. All statements, information and data given herein are believed to be accurate and reliable, but are presented without guarantee, warranty, or responsibility of any kind, expressed or implied. Statements or suggestions concerning possible use of our products are made without representation or warranty that any such use is free of patent infringement and are not recommendations to infringe any patent. The user should not assume that all safety measures are indicated or that other measures may not be required. Specifications are typical and may not apply to all applications.

## USA

### AVX Myrtle Beach, SC Corporate Offices

Tel: 843-448-9411  
FAX: 843-626-5292

### AVX Northwest, WA

Tel: 360-699-8746  
FAX: 360-699-8751

### AVX North Central, IN

Tel: 317-848-7153  
FAX: 317-844-9314

### AVX Mid/Pacific, MN

Tel: 952-974-9155  
FAX: 952-974-9179

### AVX Southwest, AZ

Tel: 480-539-1496  
FAX: 480-539-1501

### AVX South Central, TX

Tel: 972-669-1223  
FAX: 972-669-2090

### AVX Southeast, NC

Tel: 919-878-6223  
FAX: 919-878-6462

### AVX Canada

Tel: 905-564-8959  
FAX: 905-564-9728

## EUROPE

### AVX Limited, England European Headquarters

Tel: ++44 (0) 1252 770000  
FAX: ++44 (0) 1252 770001

### AVX S.A., France

Tel: ++33 (1) 69.18.46.00  
FAX: ++33 (1) 69.28.73.87

### AVX GmbH, Germany - AVX

Tel: ++49 (0) 8131 9004-0  
FAX: ++49 (0) 8131 9004-44

### AVX GmbH, Germany - Elco

Tel: ++49 (0) 2741 2990  
FAX: ++49 (0) 2741 299133

### AVX srl, Italy

Tel: ++390 (0)2 614571  
FAX: ++390 (0)2 614 2576

### AVX Czech Republic, s.r.o.

Tel: ++420 (0)467 558340  
FAX: ++420 (0)467 558345

## ASIA-PACIFIC

### AVX/Kyocera, Singapore Asia-Pacific Headquarters

Tel: (65) 258-2833  
FAX: (65) 350-4880

### AVX/Kyocera, Hong Kong

Tel: (852) 2-363-3303  
FAX: (852) 2-765-8185

### AVX/Kyocera, Korea

Tel: (82) 2-785-6504  
FAX: (82) 2-784-5411

### AVX/Kyocera, Taiwan

Tel: (886) 2-2696-4636  
FAX: (886) 2-2696-4237

### AVX/Kyocera, China

Tel: (86) 21-6249-0314-16  
FAX: (86) 21-6249-0313

### AVX/Kyocera, Malaysia

Tel: (60) 4-228-1190  
FAX: (60) 4-228-1196

### Elco, Japan

Tel: 045-943-2906/7  
FAX: 045-943-2910

### Kyocera, Japan - AVX

Tel: (81) 75-604-3426  
FAX: (81) 75-604-3425

### Kyocera, Japan - KDP

Tel: (81) 75-604-3424  
FAX: (81) 75-604-3425

### Contact:

