

## Description

### Description

The M16C/62M (80-pin version) group (low voltage version) of single-chip microcomputers are built using the high-performance silicon gate CMOS process using a M16C/60 Series CPU core and are packaged in a 80-pin plastic molded QFP. These single-chip microcomputers operate using sophisticated instructions featuring a high level of instruction efficiency. With 1M bytes of address space, they are capable of executing instructions at high speed. They also feature a built-in multiplier and DMAC, making them ideal for controlling office, communications, industrial equipment, and other high-speed processing applications. The M16C/62M (80-pin version) group (low voltage version) includes a wide range of products with different internal memory types and sizes and various package types.

### Features

- Memory capacity .....ROM (See Figure 1.1.3. ROM Expansion)  
RAM 10K to 20K bytes
- Shortest instruction execution time ..... 100ns (f(XIN)=10MHz, VCC=2.7V to 3.6V)  
142.9ns (f(XIN)=7MHz, VCC=2.2V to 3.6V, with software one-wait)
- Supply voltage ..... 2.7V to 3.6V (f(XIN)=10MHz, without software wait)  
2.4V to 2.7V (f(XIN)= 7MHz, without software wait)  
2.2V to 2.4V (f(XIN)= 7MHz, with software one-wait)
- Low power consumption ..... 28.5mW ( f(XIN)=10MHz, with software one-wait, VCC = 3V)
- Interrupts ..... 25 internal and 5 external interrupt sources, 4 software  
interrupt sources; 7 levels (including key input interrupt)
- Multifunction 16-bit timer ..... 5 output timers + 6 input timers (3 for timer function only)
- Serial I/O ..... 5 channels (2 for UART or clock synchronous, 1 for UART, 2 for clock synchronous)
- DMAC ..... 2 channels (trigger: 24 sources)
- A-D converter ..... 10 bits X 8 channels (Expandable up to 10 channels)
- D-A converter ..... 8 bits X 2 channels
- CRC calculation circuit ..... 1 circuit
- Watchdog timer ..... 1 line
- Programmable I/O ..... 70 lines
- Input port ..... 1 line (P85 shared with  $\overline{\text{NMI}}$  pin)
- Clock generating circuit ..... 2 built-in clock generation circuits  
(built-in feedback resistor, and external ceramic or quartz oscillator)

Note: Memory expansion mode and microprocessor mode are not supported.

### Applications

Audio, cameras, office equipment, communications equipment, portable equipment

### Pin Configuration

Figures 1.1.1 show the pin configurations (top view).

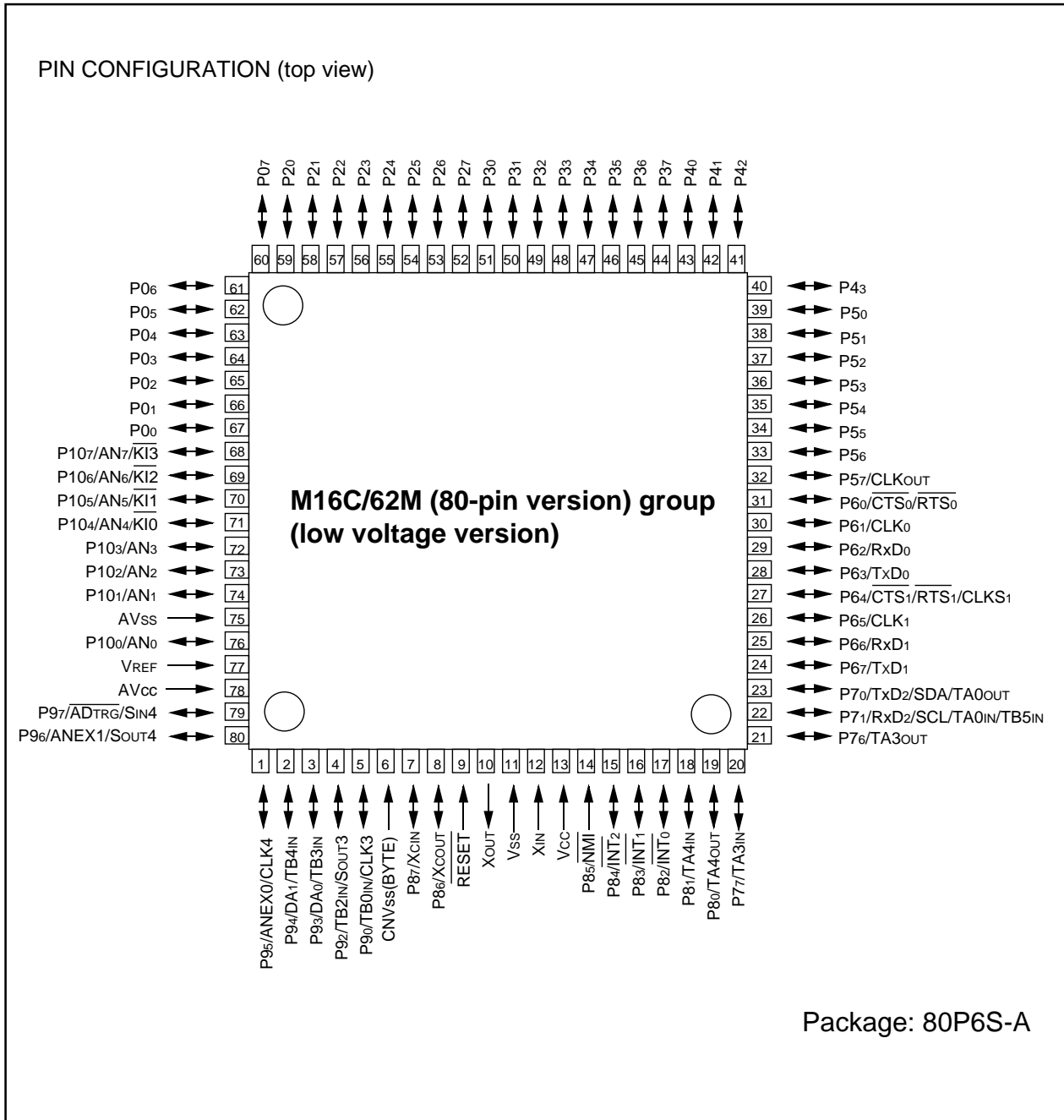

Figure 1.1.1. Pin configuration (top view)

## Description

## Block Diagram

Figure 1.1.2 is a block diagram of the M16C/62M (80-pin version) group (low voltage version).

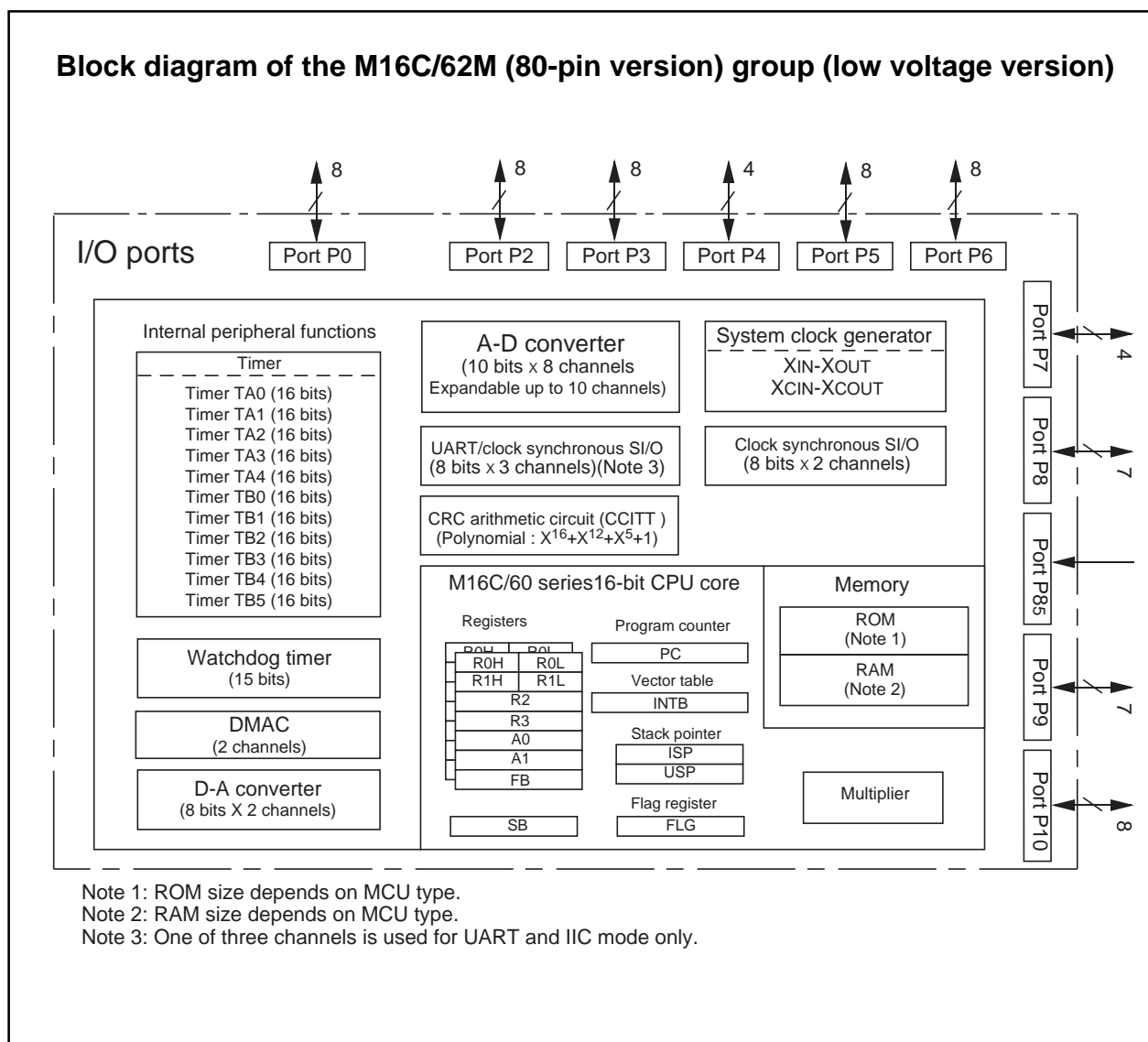

Figure 1.1.2. Block diagram of M16C/62M (80-pin version) group (low voltage version)

Description

**Performance Outline**

Table 1.1.1 is a performance outline of M16C/62M (80-pin version) group (low voltage version).

**Table 1.1.1. Performance outline of M16C/62M (80-pin version) group (low voltage version)**

Item		Performance
Number of basic instructions		91 instructions
Shortest instruction execution time		100ns(f(XIN)=10MHz, VCC=2.7V to 3.6V) 142.9ns (f(XIN)=7MHz, VCC=2.2V to 3.6V, with software one-wait)
Memory capacity	ROM	(See the figure 1.1.3. ROM Expansion)
	RAM	10K to 20K bytes
I/O port	P0 to P10 (except P85)	8 bits x 6, 7 bits x 2, 4 bits x 2
Input port	P85	1 bit x 1
Multifunction timer	TA0, TA3, TA4	16 bits x 3 (timer mode, internal/external event count, one-shot timer mode and pulse width measurement mode)
	TB0, TB2, TB3, TB4, TB5	16 bits x 5 (timer mode, internal/external event count and pulse period/pulse width measurement mode)
	TA1, TA2	16 bits x 2 (timer mode, internal event count and a trigger through one-shot timer mode occurs.)
	TB1	16 bits x 1 (timer mode and internal event count)
Serial I/O	UART0, UART1, UART2	(UART or clock synchronous) x 2, UART x 1(UART2)
	SI/O3, SI/O4	(Clock synchronous) x 2 (SI/O3 is output only)
A-D converter		10 bits x (8 + 2) channels
D-A converter		8 bits x 2
DMAC		2 channels (trigger: 24 sources)
CRC calculation circuit		CRC-CCITT
Watchdog timer		15 bits x 1 (with prescaler)
Interrupt		25 internal and 5 external sources, 4 software sources, 7 levels
Clock generating circuit		2 built-in clock generation circuits (built-in feedback resistor, and external ceramic or quartz oscillator)
Supply voltage		2.7V to 3.6V (f(XIN)=10MHz, without software wait) 2.4V to 2.7V (f(XIN)= 7MHz, without software wait) 2.2V to 2.4V (f(XIN)= 7MHz, with software one-wait)
Power consumption		28.5mW (f(XIN) = 10MHz, VCC=3V with software one-wait)
I/O characteristics	I/O withstand voltage	3V
	Output current	1mA
Device configuration		CMOS high performance silicon gate
Package		80-pin plastic mold QFP

Note : M16C/62M (80-pin version) group (low voltage version) does not support memory expansion or microprocessor mode.

Description

Mitsubishi plans to release the following products in the M16C/62M (80-pin version) group (low voltage version):

(1) Support for mask ROM version and flash memory version

(2) ROM capacity

(3) Package

80P6S-A : Plastic molded QFP (mask ROM and flash memory versions)

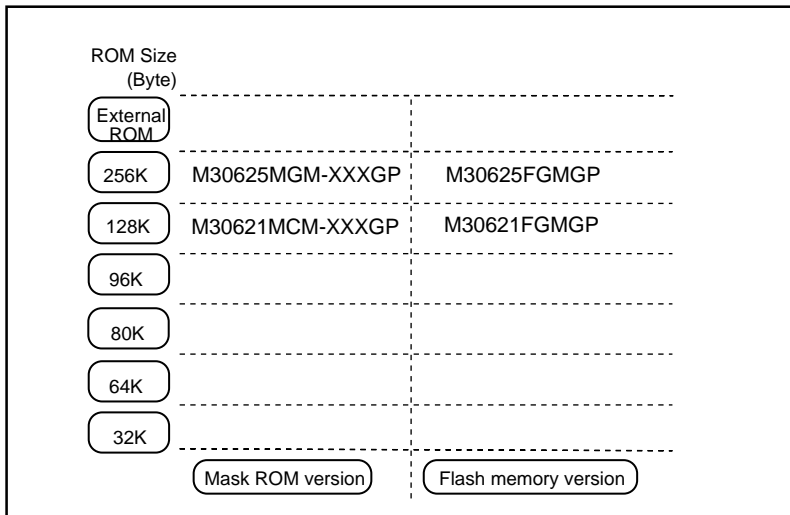

Figure 1.1.3. ROM expansion

The M16C/62M (80-pin version) group (low voltage version) products currently supported are listed in Table 1.1.2.

Table 1.1.2. M16C/62M (80-pin version) group (low voltage version)

As of June 2000

Type No	ROM capacity	RAM capacity	Package type	Remarks
M30621MCM-XXXGP	128 Kbytes	10 Kbytes	80P6S-A	mask ROM version
M30625MGM-XXXGP	256 Kbytes	20 Kbytes	80P6S-A	
M30621FGMGP	128 Kbytes	10 Kbytes	80P6S-A	Flash memory 3V version
M30625FGMGP	256 Kbytes	20 Kbytes	80P6S-A	

Description

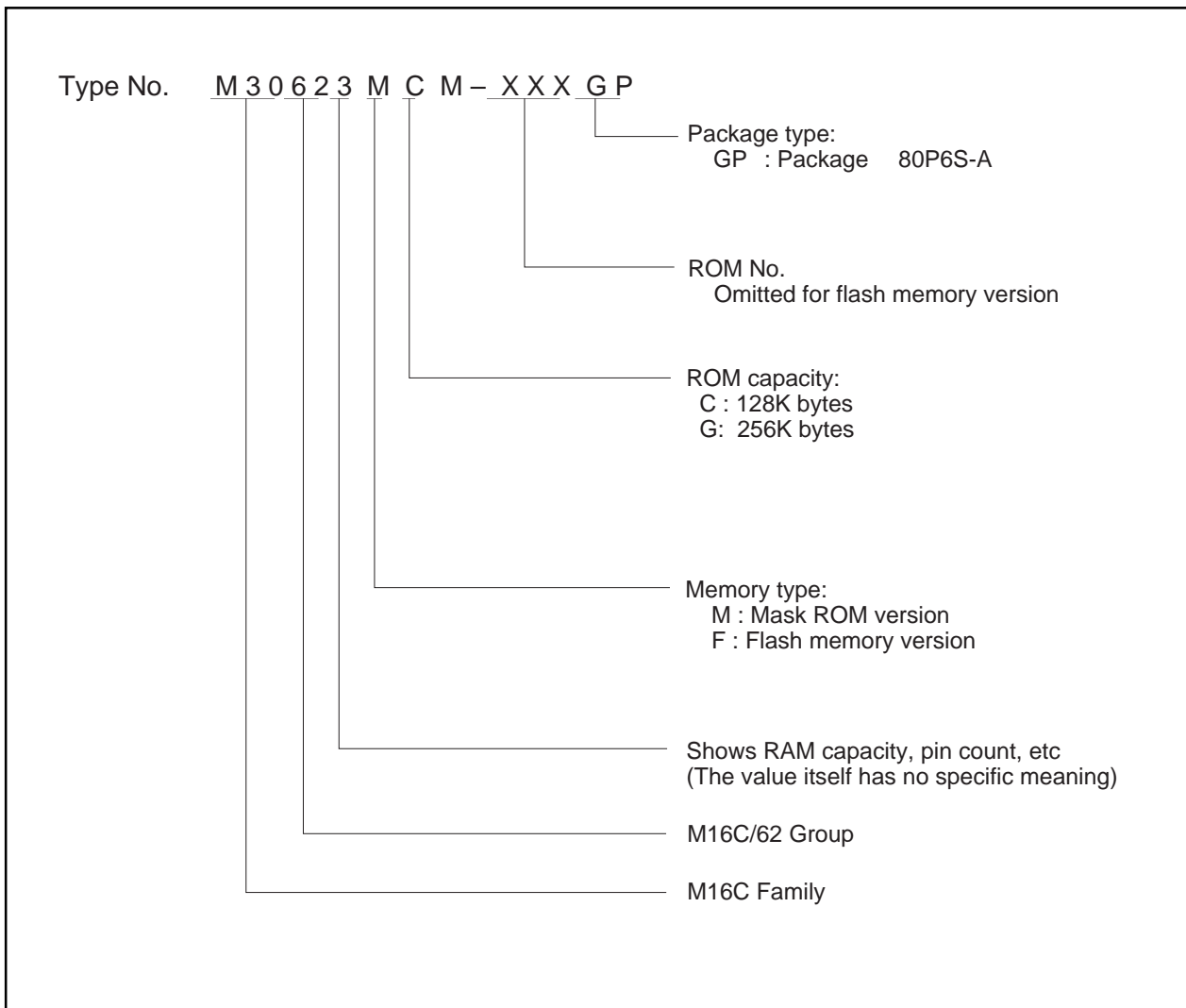

Figure 1.1.4. Type No., memory size, and package

## Description

---

### About the M16C/62M (80-pin version) group (low voltage version)

The M16C/62M (80-pin version) group (low voltage version) is packaged in a 80-pin plastic mold package. The number of pins in comparison with the 100-pin package products is decreased. So be careful about the following.

- (a) The M16C/62M (80-pin version) group (low voltage version) supports single chip mode alone. It supports neither memory expansion mode nor microprocessor mode.
- (b) The input/output ports given below are absent from the M16C/62M (80-pin version) group (low voltage version). To stabilize the internal state, set to output mode the direction register of each input/output port. Failing in setting to output mode involves an increase in current consumption.

<Pins absent from the 80-pin version>

P10 to P17, P44 to P47, P72 to P75, P91

- (c) INT3 to INT5 allocated to P15 to P17 cannot be used. Keep the INT3 interrupt control register disabled for interrupts. The INT4 interrupt control register and the INT5 interrupt control register are shared with SI/O3 and SI/O4. When the user don't use them as SI/O3 and SI/4, set them disabled for interrupts.
- (d) The output pins of timers A1 and A2 - TA1IN, TA1OUT, TA2IN and TA2OUT - allocated to P72 to P75 cannot be used. In connection with this, the gate function and pulse outputting function of timers A1 and A2 cannot be used. Use timer mode and internal event count, or use as trigger signal generation in one-shot timer mode.
- (e) The UART2 input/output pins - CLK2 and  $\overline{\text{CTS}}/\overline{\text{RTS}}$  - allocated to P72 and P73 cannot be used. In connection with this, UART2 solely as UART of the internal clock can be used.
- (f) The input pin TB1IN of timer B1 allocated to P91 cannot be used. With timer B1 under this state, use only timer mode or the internal event count.
- (g) The input pin SIN3 of serial I/O3 allocated to P91 cannot be used. In connection with this, use serial I/O3 as a serial I/O exclusive to transmission.
- (h) The output pins for three-phase motor control allocated to P72 to P75 cannot be used. So set to 0 (ordinary mode) the mode select bit (bit 2) of three-phase PWM control register 0.

Electrical characteristics ( $V_{cc} = 3V$ )

**Table 1.20.1. Absolute maximum ratings**

Symbol	Parameter		Condition	Rated value	Unit
$V_{cc}$	Supply voltage		$V_{cc}=AV_{cc}$	-0.3 to 4.6	V
$AV_{cc}$	Analog supply voltage		$V_{cc}=AV_{cc}$	-0.3 to 4.6	V
$V_i$	Input voltage	RESET, CNV <sub>SS</sub> (BYTE) P0 <sub>0</sub> to P0 <sub>7</sub> , P2 <sub>0</sub> to P2 <sub>7</sub> , P3 <sub>0</sub> to P3 <sub>7</sub> , P4 <sub>0</sub> to P4 <sub>3</sub> , P5 <sub>0</sub> to P5 <sub>7</sub> , P6 <sub>0</sub> to P6 <sub>7</sub> , P7 <sub>6</sub> to P7 <sub>7</sub> , P8 <sub>0</sub> to P8 <sub>7</sub> , P9 <sub>0</sub> , P9 <sub>2</sub> to P9 <sub>7</sub> , P10 <sub>0</sub> to P10 <sub>7</sub> , VREF, XIN		-0.3 to $V_{cc}+0.3$	V
		P7 <sub>0</sub> , P7 <sub>1</sub>		-0.3 to 4.6	V
$V_o$	Output voltage	P0 <sub>0</sub> to P0 <sub>7</sub> , P2 <sub>0</sub> to P2 <sub>7</sub> , P3 <sub>0</sub> to P3 <sub>7</sub> , P4 <sub>0</sub> to P4 <sub>3</sub> , P5 <sub>0</sub> to P5 <sub>7</sub> , P6 <sub>0</sub> to P6 <sub>7</sub> , P7 <sub>6</sub> to P7 <sub>7</sub> , P8 <sub>0</sub> to P8 <sub>4</sub> , P8 <sub>6</sub> , P8 <sub>7</sub> , P9 <sub>0</sub> , P9 <sub>2</sub> to P9 <sub>7</sub> , P10 <sub>0</sub> to P10 <sub>7</sub> , XOUT		-0.3 to $V_{cc}+0.3$	V
		P7 <sub>0</sub> , P7 <sub>1</sub>		-0.3 to 4.6	V
$P_d$	Power dissipation		$T_a=25\text{ }^{\circ}\text{C}$	300	mW
$T_{opr}$	Operating ambient temperature			-20 to 85 / -40 to 85(Note)	$^{\circ}\text{C}$
$T_{stg}$	Storage temperature			-65 to 150	$^{\circ}\text{C}$

Note: Specify a product of -40 to 85°C to use it.



Electrical characteristics (Vcc = 3V)

**Table 1.20.2. Recommended operating conditions (referenced to Vcc = 2.2V to 3.6V at Ta = -20°C to 85°C / -40°C to 85°C(Note3) unless otherwise specified)**

Symbol	Parameter		Standard			Unit
			Min.	Typ.	Max.	
Vcc	Supply voltage		2.2	3.0	3.6	V
AVcc	Analog supply voltage			Vcc		V
Vss	Supply voltage			0		V
AVss	Analog supply voltage			0		V
VIH	HIGH input voltage	P00 to P07, P20 to P27, P30 to P37, P40 to P43, P50 to P57, P60 to P67, P76, P77, P80 to P87, P90, P92 to P97, P100 to P107, XIN, RESET, CNVss (BYTE)	0.8Vcc		Vcc	V
		P70, P71	0.8Vcc		4.6	V
VIL	LOW input voltage	P00 to P07, P20 to P27, P30 to P37, P40 to P43, P50 to P57, P60 to P67, P70, P71, P76, P77, P80 to P87, P90, P92 to P97, P100 to P107, XIN, RESET, CNVss (BYTE)	0		0.2Vcc	V
IOH (peak)	HIGH peak output current	P00 to P07, P20 to P27, P30 to P37, P40 to P43, P50 to P57, P60 to P67, P76, P77, P80 to P84, P86, P87, P90, P92 to P97, P100 to P107			-10.0	mA
IOH (avg)	HIGH average output current	P00 to P07, P20 to P27, P30 to P37, P40 to P43, P50 to P57, P60 to P67, P76, P77, P80 to P84, P86, P87, P90, P92 to P97, P100 to P107			-5.0	mA
IOL (peak)	LOW peak output current	P00 to P07, P20 to P27, P30 to P37, P40 to P43, P50 to P57, P60 to P67, P70, P71, P76, P77, P80 to P84, P86, P87, P90, P92 to P97, P100 to P107			10.0	mA
IOL (avg)	LOW average output current	P00 to P07, P20 to P27, P30 to P37, P40 to P43, P50 to P57, P60 to P67, P70, P71, P76, P77, P80 to P84, P86, P87, P90, P92 to P97, P100 to P107			5.0	mA
f (XIN)	Main clock input oscillation frequency (Note 5)	No wait	Vcc=2.7V to 3.6V	0	10	MHz
			Vcc=2.4V to 2.7V	0	10 X Vcc -17	MHz
			Vcc=2.2V to 2.4V	0	17.5 X Vcc -35	MHz
		with wait	Vcc=2.7V to 3.6V	0	10	MHz
			Vcc=2.2V to 2.7V	0	6 X Vcc -6.2	MHz
f (XCIN)	Subclock oscillation frequency			32.768	50	kHz

Note 1: The mean output current is the mean value within 100ms.

Note 2: The total IOL (peak) for all ports must be 80mA max. The total IOH (peak) for all ports must be 80mA max.

Note 3: Specify a product of -40°C to 85°C to use it.

Note 4: Relationship between main clock oscillation frequency and supply voltage.

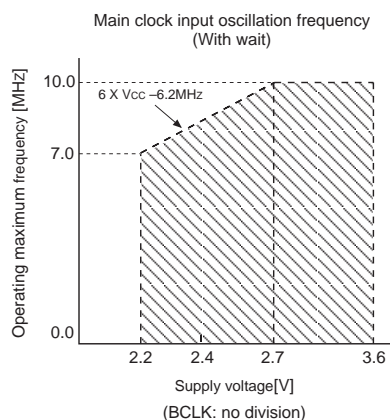
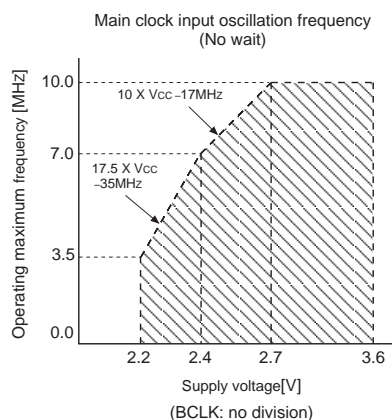

Flash memory version program voltage and read operation voltage characteristics

Flash program voltage	Flash read operation voltage
Vcc=2.7V to 3.6V	Vcc=2.4V to 3.6V
Vcc=2.7V to 3.4V	Vcc=2.2V to 2.4V

Note 5: Execute case without wait, program / erase of flash memory by Vcc=2.7V to 3.6V and f(BCLK) ≤ 6.25 MHz.

Execute case with wait, program / erase of flash memory by Vcc=2.7V to 3.6V and f(BCLK) ≤ 10.0 MHz.

Electrical characteristics ( $V_{CC} = 3V$ )

$V_{CC} = 3V$

**Table 1.20.3. A-D conversion characteristics (referenced to  $V_{CC} = AV_{CC} = V_{REF} = 2.4V$  to  $3.6V$ ,  $V_{SS} = AV_{SS} = 0V$  at  $T_a = -20^{\circ}C$  to  $85^{\circ}C$  /  $-40^{\circ}C$  to  $85^{\circ}C$ (Note2),  $f(X_{IN}) = 10MHz$  unless otherwise specified)**

Symbol	Parameter	Measuring condition	Standard			Unit
			Min.	Typ.	Max	
-	Resolution	$V_{REF} = V_{CC}$			10	Bits
-	Absolute accuracy, sample & hold function not available (8 bit)	$V_{REF} = V_{CC} = 3V$ , $\phi_{AD} = f(X_{IN})/2$			$\pm 2$	LSB
RLADDER	Ladder resistance	$V_{REF} = V_{CC}$	10		40	k $\Omega$
tCONV	Conversion time(8bit), sample & hold function not available	$V_{REF} = V_{CC} = 3V$ , $\phi_{AD} = f(X_{IN}) = f_{AD}/2 = 5MHz$	9.8		$V_{CC}$	$\mu s$
tSAMP	Sampling time		0.3			$\mu s$
VREF	Reference voltage		2.4		$V_{CC}$	V
VIA	Analog input voltage		0		$V_{REF}$	V

Note 1: Connect  $AV_{CC}$  pin to  $V_{CC}$  pin and apply the same electric potential.  
Note 2: Specify a product of  $-40^{\circ}C$  to  $85^{\circ}C$  to use it.

**Table 1.20.4. D-A conversion characteristics (referenced to  $V_{CC} = 2.4V$  to  $3.6V$ ,  $V_{SS} = AV_{SS} = 0V$ ,  $V_{REF} = 3V$ , at  $T_a = -20^{\circ}C$  to  $85^{\circ}C$  /  $-40^{\circ}C$  to  $85^{\circ}C$ (Note2),  $f(X_{IN}) = 10MHz$  unless otherwise specified)**

Symbol	Parameter	Measuring condition	Standard			Unit
			Min.	Typ.	Max.	
-	Resolution				8	Bits
-	Absolute accuracy				1.0	%
t <sub>su</sub>	Setup time				3	$\mu s$
R <sub>o</sub>	Output resistance		4	10	20	k $\Omega$
I <sub>VREF</sub>	Reference power supply input current	(Note)			1.5	mA

Note 1: This applies when using one D-A converter, with the D-A register for the unused D-A converter set to "0016".  
The A-D converter's ladder resistance is not included.  
Also, when DA register contents are not "00", the current I<sub>VREF</sub> always flows even though V<sub>ref</sub> may have been set to be unconnected by the A-D control register.  
Note 2: Specify a product of  $-40^{\circ}C$  to  $85^{\circ}C$  to use it.

**Table 1.20.5. Flash memory version electrical characteristics (referenced to  $V_{CC} = 2.7V$  to  $3.6V$ , at  $T_a = 0^{\circ}C$  to  $60^{\circ}C$  unless otherwise specified)**

Parameter	Standard			Unit
	Min.	Typ.	Max	
Page program time		6	120	ms
Block erase time		50	600	ms
Erase all unlocked blocks time		50 X n (Note)	600 X n (Note)	ms
Lock bit program time		6	120	ms

Note : n denotes the number of block erases.

**Table 1.20.6. Flash memory version program voltage and read operation voltage characteristics ( $T_a = 0^{\circ}C$  to  $60^{\circ}C$ )**

Flash program voltage	Flash read operation voltage
$V_{CC}=2.7V$ to $3.6V$	$V_{CC}=2.4V$ to $3.6V$
$V_{CC}=2.7V$ to $3.4V$	$V_{CC}=2.2V$ to $2.4V$

Electrical characteristics (V<sub>CC</sub> = 3V)

V<sub>CC</sub> = 3V

**Table 1.20.7. Electrical characteristics (referenced to V<sub>CC</sub> = 2.7V to 3.6V, V<sub>SS</sub> = 0V at Ta = -20°C to 85°C / -40°C to 85°C(Note 1), f(X<sub>IN</sub>) = 10MHz without wait unless otherwise specified)**

Symbol	Parameter		Measuring condition	Standard			Unit
				Min.	Typ.	Max.	
V <sub>OH</sub>	HIGH output voltage	P0 <sub>0</sub> to P0 <sub>7</sub> , P2 <sub>0</sub> to P2 <sub>7</sub> , P3 <sub>0</sub> to P3 <sub>7</sub> , P4 <sub>0</sub> to P4 <sub>3</sub> , P5 <sub>0</sub> to P5 <sub>7</sub> , P6 <sub>0</sub> to P6 <sub>7</sub> , P7 <sub>0</sub> , P7 <sub>1</sub> , P7 <sub>6</sub> , P7 <sub>7</sub> , P8 <sub>0</sub> to P8 <sub>4</sub> , P8 <sub>6</sub> , P8 <sub>7</sub> , P9 <sub>0</sub> , P9 <sub>2</sub> to P9 <sub>7</sub> , P10 <sub>0</sub> to P10 <sub>7</sub>	I <sub>OH</sub> =-1mA	2.5			V
V <sub>OH</sub>	HIGH output voltage	X <sub>OUT</sub>	HIGHPOWER I <sub>OH</sub> =-0.1mA	2.5			V
			LOWPOWER I <sub>OH</sub> =-50μA	2.5			
V <sub>OH</sub>	HIGH output voltage	X <sub>CO<sub>UT</sub></sub>	HIGHPOWER With no load applied		3.0		V
			LOWPOWER With no load applied		1.6		
V <sub>OL</sub>	LOW output voltage	P0 <sub>0</sub> to P0 <sub>7</sub> , P2 <sub>0</sub> to P2 <sub>7</sub> , P3 <sub>0</sub> to P3 <sub>7</sub> , P4 <sub>0</sub> to P4 <sub>3</sub> , P5 <sub>0</sub> to P5 <sub>7</sub> , P6 <sub>0</sub> to P6 <sub>7</sub> , P7 <sub>0</sub> , P7 <sub>1</sub> , P7 <sub>6</sub> , P7 <sub>7</sub> , P8 <sub>0</sub> to P8 <sub>4</sub> , P8 <sub>6</sub> , P8 <sub>7</sub> , P9 <sub>0</sub> , P9 <sub>2</sub> to P9 <sub>7</sub> , P10 <sub>0</sub> to P10 <sub>7</sub>	I <sub>OL</sub> =1mA			0.5	V
V <sub>OL</sub>	LOW output voltage	X <sub>OUT</sub>	HIGHPOWER I <sub>OL</sub> =0.1mA			0.5	V
			LOWPOWER I <sub>OL</sub> =50μA			0.5	
V <sub>OL</sub>	LOW output voltage	X <sub>CO<sub>UT</sub></sub>	HIGHPOWER With no load applied		0		V
			LOWPOWER With no load applied		0		
V <sub>T+</sub> -V <sub>T-</sub>	Hysteresis	TA0 <sub>IN</sub> , TA3 <sub>IN</sub> , TA4 <sub>IN</sub> , TB0 <sub>IN</sub> , TB2 <sub>IN</sub> to TB5 <sub>IN</sub> , INT <sub>0</sub> to INT <sub>2</sub> , ADTRG, CTS <sub>0</sub> , CTS <sub>1</sub> , CLK <sub>0</sub> , CLK <sub>1</sub> , CLK <sub>3</sub> , CLK <sub>4</sub> , TA3 <sub>OUT</sub> , TA4 <sub>OUT</sub> , NMI, K <sub>10</sub> to K <sub>13</sub> , S <sub>IN4</sub> , RxD <sub>0</sub> to RxD <sub>2</sub>		0.2		0.8	V
V <sub>T+</sub> -V <sub>T-</sub>	Hysteresis	RESET		0.2		1.8	V
I <sub>IH</sub>	HIGH input current	P0 <sub>0</sub> to P0 <sub>7</sub> , P2 <sub>0</sub> to P2 <sub>7</sub> , P3 <sub>0</sub> to P3 <sub>7</sub> , P4 <sub>0</sub> to P4 <sub>3</sub> , P5 <sub>0</sub> to P5 <sub>7</sub> , P6 <sub>0</sub> to P6 <sub>7</sub> , P7 <sub>0</sub> , P7 <sub>1</sub> , P7 <sub>6</sub> , P7 <sub>7</sub> , P8 <sub>0</sub> to P8 <sub>7</sub> , P9 <sub>0</sub> , P9 <sub>2</sub> to P9 <sub>7</sub> , P10 <sub>0</sub> to P10 <sub>7</sub> , X <sub>IN</sub> , RESET, CNV <sub>SS</sub> (BYTE)	V <sub>I</sub> =3V			4.0	μA
I <sub>IL</sub>	LOW input current	P0 <sub>0</sub> to P0 <sub>7</sub> , P2 <sub>0</sub> to P2 <sub>7</sub> , P3 <sub>0</sub> to P3 <sub>7</sub> , P4 <sub>0</sub> to P4 <sub>3</sub> , P5 <sub>0</sub> to P5 <sub>7</sub> , P6 <sub>0</sub> to P6 <sub>7</sub> , P7 <sub>0</sub> , P7 <sub>1</sub> , P7 <sub>6</sub> , P7 <sub>7</sub> , P8 <sub>0</sub> to P8 <sub>7</sub> , P9 <sub>0</sub> , P9 <sub>2</sub> to P9 <sub>7</sub> , P10 <sub>0</sub> to P10 <sub>7</sub> , X <sub>IN</sub> , RESET, CNV <sub>SS</sub> (BYTE)	V <sub>I</sub> =0V			-4.0	μA
R <sub>PULLUP</sub>	Pull-up resistance	P0 <sub>0</sub> to P0 <sub>7</sub> , P2 <sub>0</sub> to P2 <sub>7</sub> , P3 <sub>0</sub> to P3 <sub>7</sub> , P4 <sub>0</sub> to P4 <sub>3</sub> , P5 <sub>0</sub> to P5 <sub>7</sub> , P6 <sub>0</sub> to P6 <sub>7</sub> , P7 <sub>6</sub> , P7 <sub>7</sub> , P8 <sub>0</sub> to P8 <sub>4</sub> , P8 <sub>6</sub> , P8 <sub>7</sub> , P9 <sub>0</sub> , P9 <sub>2</sub> to P9 <sub>7</sub> , P10 <sub>0</sub> to P10 <sub>7</sub>	V <sub>I</sub> =0V	20	75	300	KΩ
R <sub>I<sub>XIN</sub></sub>	Feedback resistance	X <sub>IN</sub>			3.0		MΩ
R <sub>I<sub>X<sub>CIN</sub></sub></sub>	Feedback resistance	X <sub>CIN</sub>			10.0		MΩ
V <sub>RAM</sub>	RAM retention voltage		When clock is stopped	2.0			V
I <sub>CC</sub>	Power supply current	The output pins are open and other pins are V <sub>SS</sub>	Mask ROM version	f(X <sub>IN</sub> )=10MHz Square wave, no division	9.5	21.25	mA
			Flash memory 3V version	f(X <sub>IN</sub> )=10MHz Square wave, no division	12.0	21.25	mA
			Mask ROM version Flash memory 3V version	f(X <sub>CIN</sub> )=32kHz Square wave	45.0		μA
			Flash memory 3V version Program	f(X <sub>IN</sub> )=10MHz Square wave, division by 2	14.0		mA
			Flash memory 3V version Erase	f(X <sub>IN</sub> )=10MHz Square wave, division by 2	17.0		mA
			Mask ROM version Flash memory 3V version	f(X <sub>CIN</sub> )=32kHz When a WAIT instruction is executed. Oscillation capacity High (Note2)	2.8		μA
				f(X <sub>CIN</sub> )=32kHz When a WAIT instruction is executed. Oscillation capacity Low (Note2)	0.9		μA
	Ta=25°C when clock is stopped			1.0		μA	
	Ta=85°C when clock is stopped			20.0		μA	

Note 1: Specify a product of -40°C to 85°C to use it.  
Note 2: With one timer operated using fC32.

$V_{CC} = 3V$ 

**Timing requirements (referenced to  $V_{CC} = 3V$ ,  $V_{SS} = 0V$  at  $T_a = -20^{\circ}C$  to  $85^{\circ}C$  /  $-40^{\circ}C$  to  $85^{\circ}C$  (\*))  
unless otherwise specified)**

\* : Specify a product of  $-40^{\circ}C$  to  $85^{\circ}C$  to use it.

**Table 1.20.8. External clock input**

Symbol	Parameter	Standard		Unit
		Min.	Max.	
$t_c$	External clock input cycle time	100		ns
$t_{w(H)}$	External clock input HIGH pulse width	40		ns
$t_{w(L)}$	External clock input LOW pulse width	40		ns
$t_r$	External clock rise time		18	ns
$t_f$	External clock fall time		18	ns

$V_{CC} = 3V$

**Timing requirements (referenced to  $V_{CC} = 3V$ ,  $V_{SS} = 0V$  at  $T_a = -20^{\circ}C$  to  $85^{\circ}C$  /  $-40^{\circ}C$  to  $85^{\circ}C$  (\*))  
unless otherwise specified)**

\* : Specify a product of  $-40^{\circ}C$  to  $85^{\circ}C$  to use it.

**Table 1.20.9. Timer A input (counter input in event counter mode)**

Symbol	Parameter	Standard		Unit
		Min.	Max.	
$t_{c(TA)}$	TAiIn input cycle time	150		ns
$t_{w(TAH)}$	TAiIn input HIGH pulse width	60		ns
$t_{w(TAL)}$	TAiIn input LOW pulse width	60		ns

**Table 1.20.10. Timer A input (gating input in timer mode)**

Symbol	Parameter	Standard		Unit
		Min.	Max.	
$t_{c(TA)}$	TAiIn input cycle time	600		ns
$t_{w(TAH)}$	TAiIn input HIGH pulse width	300		ns
$t_{w(TAL)}$	TAiIn input LOW pulse width	300		ns

**Table 1.20.11. Timer A input (external trigger input in one-shot timer mode)**

Symbol	Parameter	Standard		Unit
		Min.	Max.	
$t_{c(TA)}$	TAiIn input cycle time	300		ns
$t_{w(TAH)}$	TAiIn input HIGH pulse width	150		ns
$t_{w(TAL)}$	TAiIn input LOW pulse width	150		ns

**Table 1.20.12. Timer A input (external trigger input in pulse width modulation mode)**

Symbol	Parameter	Standard		Unit
		Min.	Max.	
$t_{w(TAH)}$	TAiIn input HIGH pulse width	150		ns
$t_{w(TAL)}$	TAiIn input LOW pulse width	150		ns

**Table 1.20.13. Timer A input (up/down input in event counter mode)**

Symbol	Parameter	Standard		Unit
		Min.	Max.	
$t_{c(UP)}$	TAiOUT input cycle time	3000		ns
$t_{w(UPH)}$	TAiOUT input HIGH pulse width	1500		ns
$t_{w(UPL)}$	TAiOUT input LOW pulse width	1500		ns
$t_{su(UP-TIN)}$	TAiOUT input setup time	600		ns
$t_{h(TIN-UP)}$	TAiOUT input hold time	600		ns

Electrical characteristics ( $V_{CC} = 3V$ )

$V_{CC} = 3V$

**Timing requirements (referenced to  $V_{CC} = 3V$ ,  $V_{SS} = 0V$  at  $T_a = -20^{\circ}C$  to  $85^{\circ}C$  /  $-40^{\circ}C$  to  $85^{\circ}C$  (\*))  
unless otherwise specified)**

\* : Specify a product of  $-40^{\circ}C$  to  $85^{\circ}C$  to use it.

**Table 1.20.14. Timer B input (counter input in event counter mode)**

Symbol	Parameter	Standard		Unit
		Min.	Max.	
$t_{c(TB)}$	TBiIn input cycle time (counted on one edge)	150		ns
$t_{w(TBH)}$	TBiIn input HIGH pulse width (counted on one edge)	60		ns
$t_{w(TBL)}$	TBiIn input LOW pulse width (counted on one edge)	60		ns
$t_{c(TB)}$	TBiIn input cycle time (counted on both edges)	300		ns
$t_{w(TBH)}$	TBiIn input HIGH pulse width (counted on both edges)	160		ns
$t_{w(TBL)}$	TBiIn input LOW pulse width (counted on both edges)	160		ns

**Table 1.20.15. Timer B input (pulse period measurement mode)**

Symbol	Parameter	Standard		Unit
		Min.	Max.	
$t_{c(TB)}$	TBiIn input cycle time	600		ns
$t_{w(TBH)}$	TBiIn input HIGH pulse width	300		ns
$t_{w(TBL)}$	TBiIn input LOW pulse width	300		ns

**Table 1.20.16. Timer B input (pulse width measurement mode)**

Symbol	Parameter	Standard		Unit
		Min.	Max.	
$t_{c(TB)}$	TBiIn input cycle time	600		ns
$t_{w(TBH)}$	TBiIn input HIGH pulse width	300		ns
$t_{w(TBL)}$	TBiIn input LOW pulse width	300		ns

**Table 1.20.17. A-D trigger input**

Symbol	Parameter	Standard		Unit
		Min.	Max.	
$t_{c(AD)}$	$\overline{ADTRG}$ input cycle time (trigger able minimum)	1500		ns
$t_{w(ADL)}$	$\overline{ADTRG}$ input LOW pulse width	200		ns

**Table 1.20.18. Serial I/O**

Symbol	Parameter	Standard		Unit
		Min.	Max.	
$t_{c(CK)}$	CLKi input cycle time	300		ns
$t_{w(CKH)}$	CLKi input HIGH pulse width	150		ns
$t_{w(CKL)}$	CLKi input LOW pulse width	150		ns
$t_d(C-Q)$	TxDi output delay time		160	ns
$t_h(C-Q)$	TxDi hold time	0		ns
$t_{su}(D-C)$	RxDi input setup time	50		ns
$t_h(C-D)$	RxDi input hold time	90		ns

**Table 1.20.19. External interrupt  $\overline{INTi}$  inputs**

Symbol	Parameter	Standard		Unit
		Min.	Max.	
$t_{w(INH)}$	$\overline{INTi}$ input HIGH pulse width	380		ns
$t_{w(INL)}$	$\overline{INTi}$ input LOW pulse width	380		ns

Electrical characteristics ( $V_{CC} = 3V$ )

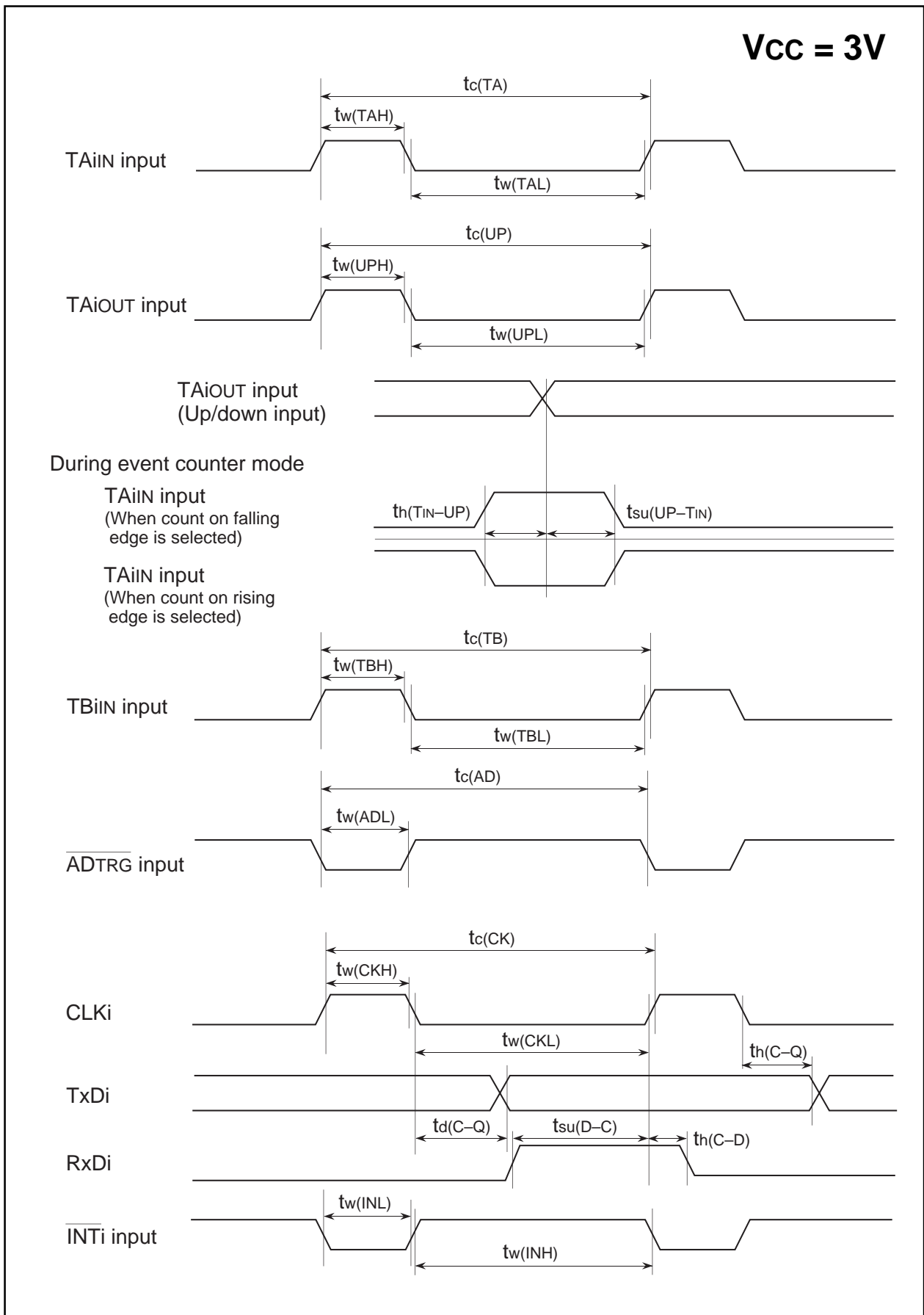

Figure 1.20.2.  $V_{CC}=3V$  timing diagram

## Usage Precaution

### Timer A (timer mode)

- (1) Reading the timer Ai register while a count is in progress allows reading, with arbitrary timing, the value of the counter. Reading the timer Ai register with the reload timing gets "FFFF<sub>16</sub>". Reading the timer Ai register after setting a value in the timer Ai register with a count halted but before the counter starts counting gets a proper value.

### Timer A (event counter mode)

- (1) Reading the timer Ai register while a count is in progress allows reading, with arbitrary timing, the value of the counter. Reading the timer Ai register with the reload timing gets "FFFF<sub>16</sub>" by underflow or "0000<sub>16</sub>" by overflow. Reading the timer Ai register after setting a value in the timer Ai register with a count halted but before the counter starts counting gets a proper value.
- (2) When stop counting in free run type, set timer again.

### Timer A (one-shot timer mode)

- (1) Setting the count start flag to "0" while a count is in progress causes as follows:
  - The counter stops counting and a content of reload register is reloaded.
  - The TAIOUT pin outputs "L" level.
  - The interrupt request generated and the timer Ai interrupt request bit goes to "1".
- (2) The timer Ai interrupt request bit goes to "1" if the timer's operation mode is set using any of the following procedures:
  - Selecting one-shot timer mode after reset.
  - Changing operation mode from timer mode to one-shot timer mode.
  - Changing operation mode from event counter mode to one-shot timer mode.
 Therefore, to use timer Ai interrupt (interrupt request bit), set timer Ai interrupt request bit to "0" after the above listed changes have been made.

### Timer A (pulse width modulation mode)

- (1) The timer Ai interrupt request bit becomes "1" if setting operation mode of the timer in compliance with any of the following procedures:
  - Selecting PWM mode after reset.
  - Changing operation mode from timer mode to PWM mode.
  - Changing operation mode from event counter mode to PWM mode.
 Therefore, to use timer Ai interrupt (interrupt request bit), set timer Ai interrupt request bit to "0" after the above listed changes have been made.
- (2) Setting the count start flag to "0" while PWM pulses are being output causes the counter to stop counting. If the TAIOUT pin is outputting an "H" level in this instance, the output level goes to "L", and the timer Ai interrupt request bit goes to "1". If the TAIOUT pin is outputting an "L" level in this instance, the level does not change, and the timer Ai interrupt request bit does not becomes "1".

### Timer B (timer mode, event counter mode)

- (1) Reading the timer Bi register while a count is in progress allows reading, with arbitrary timing, the value of the counter. Reading the timer Bi register with the reload timing gets "FFFF<sub>16</sub>". Reading the timer Bi register after setting a value in the timer Bi register with a count halted but before the counter starts counting gets a proper value.



### Timer B (pulse period/pulse width measurement mode)

- (1) If changing the measurement mode select bit is set after a count is started, the timer Bi interrupt request bit goes to "1".
- (2) When the first effective edge is input after a count is started, an indeterminate value is transferred to the reload register. At this time, timer Bi interrupt request is not generated.

### A-D Converter

- (1) Write to each bit (except bit 6) of A-D control register 0, to each bit of A-D control register 1, and to bit 0 of A-D control register 2 when A-D conversion is stopped (before a trigger occurs).  
In particular, when the Vref connection bit is changed from "0" to "1", start A-D conversion after an elapse of 1  $\mu$ s or longer.
- (2) When changing A-D operation mode, select analog input pin again.
- (3) Using one-shot mode or single sweep mode  
Read the correspondence A-D register after confirming A-D conversion is finished. (It is known by A-D conversion interrupt request bit.)
- (4) Using repeat mode, repeat sweep mode 0 or repeat sweep mode 1  
Use the undivided main clock as the internal CPU clock.

### Stop Mode and Wait Mode

- (1) When returning from stop mode by hardware reset,  $\overline{\text{RESET}}$  pin must be set to "L" level until main clock oscillation is stabilized.
- (2) When switching to either wait mode or stop mode, instructions occupying four bytes either from the WAIT instruction or from the instruction that sets the every-clock stop bit to "1" within the instruction queue are prefetched and then the program stops. So put at least four NOPs in succession either to the WAIT instruction or to the instruction that sets the every-clock stop bit to "1".

### Interrupts

- (1) Reading address 00000<sub>16</sub>
  - When maskable interrupt is occurred, CPU read the interrupt information (the interrupt number and interrupt request level) in the interrupt sequence.  
The interrupt request bit of the certain interrupt written in address 00000<sub>16</sub> will then be set to "0".  
Reading address 00000<sub>16</sub> by software sets enabled highest priority interrupt source request bit to "0".  
Though the interrupt is generated, the interrupt routine may not be executed.  
Do not read address 00000<sub>16</sub> by software.
- (2) Setting the stack pointer
  - The value of the stack pointer immediately after reset is initialized to 0000<sub>16</sub>. Accepting an interrupt before setting a value in the stack pointer may become a factor of runaway. Be sure to set a value in the stack pointer before accepting an interrupt.  
When using the  $\overline{\text{NMI}}$  interrupt, initialize the stack point at the beginning of a program. Concerning the first instruction immediately after reset, generating any interrupts including the  $\overline{\text{NMI}}$  interrupt is prohibited.
- (3) The  $\overline{\text{NMI}}$  interrupt
  - The  $\overline{\text{NMI}}$  interrupt can not be disabled. Be sure to connect  $\overline{\text{NMI}}$  pin to Vcc via a pull-up resistor if unused.
  - Do not get either into stop mode with the  $\overline{\text{NMI}}$  pin set to "L".

## Usage precaution

### (4) External interrupt

- When the polarity of the  $\overline{\text{INT0}}$  to  $\overline{\text{INT2}}$  pins is changed, the interrupt request bit is sometimes set to "1". After changing the polarity, set the interrupt request bit to "0".

### (5) Rewrite the interrupt control register

- To rewrite the interrupt control register, do so at a point that does not generate the interrupt request for that register. If there is possibility of the interrupt request occur, rewrite the interrupt control register after the interrupt is disabled. The program examples are described as follow:

#### Example 1:

```
INT_SWITCH1:
  FCLR  I           ; Disable interrupts.
  AND.B #00h, 0055h ; Clear TA0IC int. priority level and int. request bit.
  NOP
  NOP
  FSET  I           ; Enable interrupts.
```

#### Example 2:

```
INT_SWITCH2:
  FCLR  I           ; Disable interrupts.
  AND.B #00h, 0055h ; Clear TA0IC int. priority level and int. request bit.
  MOV.W MEM, R0    ; Dummy read.
  FSET  I           ; Enable interrupts.
```

#### Example 3:

```
INT_SWITCH3:
  PUSHC FLG        ; Push Flag register onto stack
  FCLR  I           ; Disable interrupts.
  AND.B #00h, 0055h ; Clear TA0IC int. priority level and int. request bit.
  POPC  FLG        ; Enable interrupts.
```

The reason why two NOP instructions or dummy read are inserted before FSET I in Examples 1 and 2 is to prevent the interrupt enable flag I from being set before the interrupt control register is rewritten due to effects of the instruction queue.

- When a instruction to rewrite the interrupt control register is executed but the interrupt is disabled, the interrupt request bit is not set sometimes even if the interrupt request for that register has been generated. This will depend on the instruction. If this creates problems, use the below instructions to change the register.

Instructions : AND, OR, BCLR, BSET

## Noise

- (1) Insert bypass capacitor between Vcc and Vss pin for noise and latch up countermeasure.
  - Insert bypass capacitor (about 0.1  $\mu\text{F}$ ) and connect short and wide line between Vcc and Vss lines.

GZZ-SH13-96B<02A0>

**MITSUBISHI ELECTRIC-CHIP 16-BIT  
MICROCOMPUTER M30621MCM-XXXGP  
MASK ROM CONFIRMATION FORM**

Mask ROM number	
-----------------	--

Receipt	Date :	
	Section head signature	Supervisor signature

Note : Please complete all items marked \* .

* Customer	Company name	TEL ( )	Issuance signature	Submitted by	Supervisor
	Date issued	Date :			

\*1. Check sheet

Mitsubishi processes the mask files generated by the mask file generation utilities out of those held on the floppy disks you give in to us, and forms them into masks. Hence, we assume liability provided that there is any discrepancy between the contents of these mask files and the ROM data to be burned into products we produce. Check thoroughly the contents of the mask files you give in.

Prepare 3.5 inches 2HD (IBM format) floppy disks. And store only one mask file in a floppy disk.

Microcomputer type No. :  M30621MCM-XXXGP

File code : 

--	--	--	--	--	--	--	--

 (hex)

Mask file name : 

--	--	--	--	--	--	--	--

 .MSK (alpha-numeric 8-digit)

\*2. Mark specification

The mark specification differs according to the type of package. After entering the mark specification on the separate mark specification sheet (for each package), attach that sheet to this masking check sheet for submission to Mitsubishi.

For the M30621MCM-XXXGP, submit the 80P6S mark specification sheet.

\*3. Usage Conditions

For our reference when of testing our products, please reply to the following questions about the usage of the products you ordered.

(1) Which kind of X<sub>IN</sub>-X<sub>OUT</sub> oscillation circuit is used?

- Ceramic resonator                       Quartz-crystal oscillator  
 External clock input                       Other ( )

What frequency do not use?

f(X<sub>IN</sub>) =  MHz

GZZ-SH13-96B<02A0>

Mask ROM number	
-----------------	--

**MITSUBISHI ELECTRIC-CHIP 16-BIT  
MICROCOMPUTER M30621MCM-XXXGP  
MASK ROM CONFIRMATION FORM**

(2) Which kind of XCIN-XCOUT oscillation circuit is used?

- Ceramic resonator                       Quartz-crystal oscillator  
 External clock input                       Other (                      )

What frequency do not use?

$f(XCIN) =$   kHz

(3) Which operating supply voltage do you use?

(Circle the operating voltage range of use)

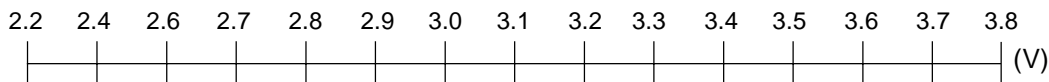

(4) Which operating ambient temperature do you use?

(Circle the operating temperature range of use)

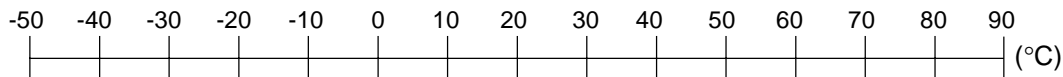

(5) Do you use I<sup>2</sup>C (Inter IC) bus function?

- Not use     Use

(6) Do you use IE (Inter Equipment) bus function?

- Not use     Use

Thank you cooperation.

※4. Special item (Indicate none if there is not specified item)

GZZ-SH13-49B<98A1>

**MITSUBISHI ELECTRIC-CHIP 16-BIT  
MICROCOMPUTER M30625MGM-XXXGP  
MASK ROM CONFIRMATION FORM**

Mask ROM number	
-----------------	--

Receipt	Date :	
	Section head signature	Supervisor signature

Note : Please complete all items marked \* .

* Customer	Company name	TEL ( )	Issuance signature	Submitted by	Supervisor
	Date issued	Date :			

\*1. Check sheet

Mitsubishi processes the mask files generated by the mask file generation utilities out of those held on the floppy disks you give in to us, and forms them into masks. Hence, we assume liability provided that there is any discrepancy between the contents of these mask files and the ROM data to be burned into products we produce. Check thoroughly the contents of the mask files you give in.

Prepare 3.5 inches 2HD (IBM format) floppy disks. And store only one mask file in a floppy disk.

Microcomputer type No. :  M30625MGM-XXXGP

File code : 

--	--	--	--	--	--	--	--

 (hex)

Mask file name : 

--	--	--	--	--	--	--	--

 .MSK (alpha-numeric 8-digit)

\*2. Mark specification

The mark specification differs according to the type of package. After entering the mark specification on the separate mark specification sheet (for each package), attach that sheet to this masking check sheet for submission to Mitsubishi.

For the M30625MGM-XXXGP, submit the 80P6S mark specification sheet.

\*3. Usage Conditions

For our reference when of testing our products, please reply to the following questions about the usage of the products you ordered.

(1) Which kind of X<sub>IN</sub>-X<sub>OUT</sub> oscillation circuit is used?

- Ceramic resonator                       Quartz-crystal oscillator  
 External clock input                       Other ( )

What frequency do not use?

f(X<sub>IN</sub>) =  MHz

GZZ-SH13-49B<98A1>

Mask ROM number	
-----------------	--

**mitsubishi electric-chip 16-bit  
microcomputer M30625MGM-XXXGP  
mask rom confirmation form**

(2) Which kind of XCIN-XCOUT oscillation circuit is used?

- Ceramic resonator                       Quartz-crystal oscillator  
 External clock input                       Other (                      )

What frequency do not use?

f(XCIN) =  kHz

(3) Which operating supply voltage do you use?

(Circle the operating voltage range of use)

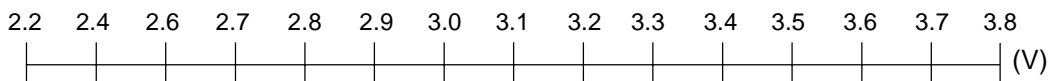

(4) Which operating ambient temperature do you use?

(Circle the operating temperature range of use)

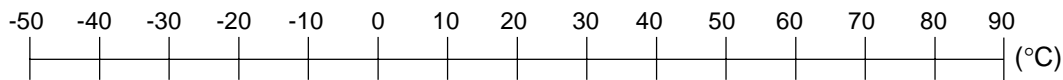

(5) Do you use I<sup>2</sup>C (Inter IC) bus function?

- Not use     Use

(6) Do you use IE (Inter Equipment) bus function?

- Not use     Use

Thank you cooperation.

※4. Special item (Indicate none if there is not specified item)

### Keep safety first in your circuit designs!

- Mitsubishi Electric Corporation puts the maximum effort into making semiconductor products better and more reliable, but there is always the possibility that trouble may occur with them. Trouble with semiconductors may lead to personal injury, fire or property damage. Remember to give due consideration to safety when making your circuit designs, with appropriate measures such as (i) placement of substitutive, auxiliary circuits, (ii) use of non-flammable material or (iii) prevention against any malfunction or mishap.

### Notes regarding these materials

- These materials are intended as a reference to assist our customers in the selection of the Mitsubishi semiconductor product best suited to the customer's application; they do not convey any license under any intellectual property rights, or any other rights, belonging to Mitsubishi Electric Corporation or a third party.
- Mitsubishi Electric Corporation assumes no responsibility for any damage, or infringement of any third-party's rights, originating in the use of any product data, diagrams, charts, programs, algorithms, or circuit application examples contained in these materials.
- All information contained in these materials, including product data, diagrams, charts, programs and algorithms represents information on products at the time of publication of these materials, and are subject to change by Mitsubishi Electric Corporation without notice due to product improvements or other reasons. It is therefore recommended that customers contact Mitsubishi Electric Corporation or an authorized Mitsubishi Semiconductor product distributor for the latest product information before purchasing a product listed herein.  
The information described here may contain technical inaccuracies or typographical errors. Mitsubishi Electric Corporation assumes no responsibility for any damage, liability, or other loss rising from these inaccuracies or errors.  
Please also pay attention to information published by Mitsubishi Electric Corporation by various means, including the Mitsubishi Semiconductor home page (<http://www.mitsubishichips.com>).
- When using any or all of the information contained in these materials, including product data, diagrams, charts, programs, and algorithms, please be sure to evaluate all information as a total system before making a final decision on the applicability of the information and products. Mitsubishi Electric Corporation assumes no responsibility for any damage, liability or other loss resulting from the information contained herein.
- Mitsubishi Electric Corporation semiconductors are not designed or manufactured for use in a device or system that is used under circumstances in which human life is potentially at stake. Please contact Mitsubishi Electric Corporation or an authorized Mitsubishi Semiconductor product distributor when considering the use of a product contained herein for any specific purposes, such as apparatus or systems for transportation, vehicular, medical, aerospace, nuclear, or undersea repeater use.
- The prior written approval of Mitsubishi Electric Corporation is necessary to reprint or reproduce in whole or in part these materials.
- If these products or technologies are subject to the Japanese export control restrictions, they must be exported under a license from the Japanese government and cannot be imported into a country other than the approved destination.  
Any diversion or reexport contrary to the export control laws and regulations of Japan and/or the country of destination is prohibited.
- Please contact Mitsubishi Electric Corporation or an authorized Mitsubishi Semiconductor product distributor for further details on these materials or the products contained therein.

MITSUBISHI SEMICONDUCTORS  
M16C/62M Group (80-pin)  
Specification REV.A

---

June. First Edition 2000

Edited by  
Committee of editing of Mitsubishi Semiconductor

Published by  
Mitsubishi Electric Corp., Kitaitami Works

---

This book, or parts thereof, may not be reproduced in any form without  
permission of Mitsubishi Electric Corporation.

©2000 MITSUBISHI ELECTRIC CORPORATION