

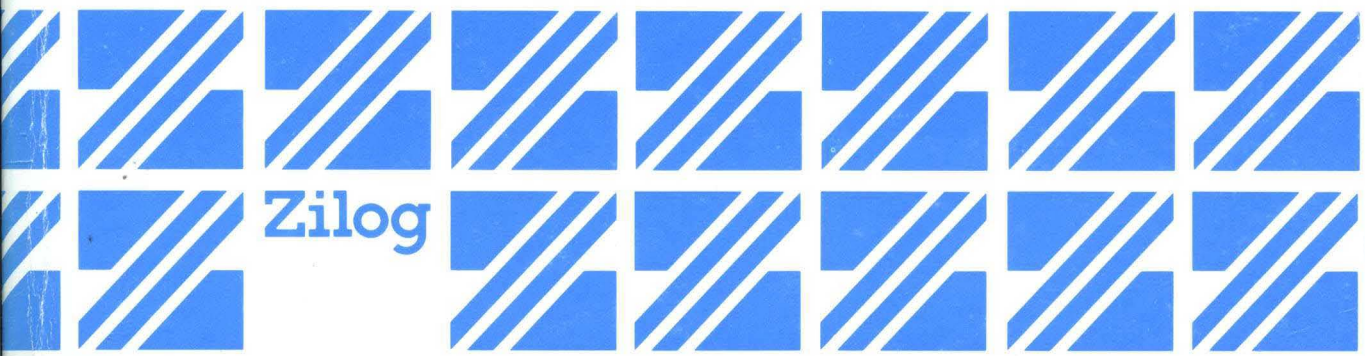

Z80[®]-Assembly Language Programming Manual



Z80 ASSEMBLY LANGUAGE PROGRAMMING MANUAL

Copyright© 1977 by Zilog, Inc. All rights reserved. No part of this publication may be reproduced, stored in a retrieval system, or transmitted, in any form or by any means, electronic, mechanical, photocopying, recording, or otherwise, without the prior written permission of Zilog.

Zilog assumes no responsibility for the use of any circuitry other than circuitry embodied in a Zilog product. No other circuit patent licenses are implied.

3.0 D.S.
REL. 2.1

TABLE OF CONTENTS

	PAGE
I. INTRODUCTION.....	1
II. SPECIFICATION OF Z80 ASSEMBLY LANGUAGE	
A. THE ASSEMBLY LANGUAGE.....	2
B. OPERANDS.....	4
C. RULES FOR WRITING ASSEMBLY STATEMENTS (SYNTAX)..	6
D. ASSEMBLY LANGUAGE CONVENTIONS.....	7
E. ASSEMBLER COMMANDS.....	13
III. MACROS.....	15
IV. SUBROUTINES.....	18
V. Z80 CPU FLAGS.....	20
VI. Z80 INSTRUCTION SET.....	24
INSTRUCTION INDEX.....	275
APPENDIX:	
A. ERROR MESSAGES.....	280
C. INSTRUCTION SORT LISTING (ALPHABETICAL).....	284
C. INSTRUCTION SORT LISTING (NUMERICAL).....	290

JANUARY 1978

Z80 ASSEMBLY LANGUAGE PROGRAMMING MANUAL

INTRODUCTION:

The assembly language provides a means for writing a program without having to be concerned with actual memory addresses or machine instruction formats. It allows the use of symbolic addresses to identify memory locations and mnemonic codes (opcodes and operands) to represent the instructions themselves. Labels (symbols) can be assigned to a particular instruction step in a source program to identify that step as an entry point for use in subsequent instructions. Operands following each instruction represent storage locations, registers, or constant values. The assembly language also includes assembler directives that supplement the machine instruction. A pseudo-op, for example, is a statement which is not translated into a machine instruction, but rather is interpreted as a directive that controls the assembly process.

A program written in assembly language is called a source program. It consists of symbolic commands called statements. Each statement is written on a single line and may consist of from one to four entries: A label field, an operation field, an operand field and a comment field. The source program is processed by the assembler to obtain a machine language program (object program) that can be executed directly by the Z80-CPU.

Zilog provides several different assemblers which differ in the features offered. Both absolute and relocatable assemblers are available with the Development and Microcomputer Systems. The absolute assembler is contained in base level software operating in a 16K memory space while the relocating assembler is part of the RIO environment operating in a 32K memory space.

II SPECIFICATION OF THE Z80 ASSEMBLY LANGUAGE

A. THE ASSEMBLY LANGUAGE

The assembly language of the Z80 is designed to minimize the number of different opcodes corresponding to the set of basic machine operations and to provide for a consistent description of instruction operands. The nomenclature has been defined with special emphasis on mnemonic value and readability.

The movement of data is indicated primarily by a single opcode, LD for example, regardless of whether the movement is between different registers or between registers and memory locations.

The first operand of an LD instruction is the destination of the operation, and the second operand is the source of the operation. For example:

LD A,B

indicates that the contents of the second operand, register B, are to be transferred to the first operand, register A. Similarly,

LD C,3FH

indicates that the constant 3FH is to be loaded into the register C. In addition, enclosing an operand wholly in parentheses indicates a memory location addressed by the contents of the parentheses. For example,

LD HL,(1200)

indicates the contents of memory locations 1200 and 1201 are to be loaded into the 16-bit register pair HL. Similarly,

LD (IX+6),C

indicates the contents of the register C are to be stored in the memory location addressed by the current value of the 16-bit index register IX plus 6.

The regular formation of assembly instructions minimizes the number of mnemonics and format rules that the user must learn and manipulate. Additionally, the resulting programs are easier to interpret which in turn reduces programming errors and improves the maintainability of the software.

B. OPERANDS

Operands modify the opcodes and provide the information needed by the assembler to perform the designated operation.

Certain symbolic names are reserved as key words in the assembly language operand fields. They are:

- 1) The contents of 8-bit registers are specified by the character corresponding to the register names. The register names are A,B,C,D,E,H,L,I,R.
- 2) The contents of 16-bit double registers and register pairs consisting of two 8-bit registers are specified by the two characters corresponding to the register name or register pair. The names of double registers are IX,IY and SP. The names of registers pairs are AF,BC,DE and HL.
- 3) The contents of the auxiliary register pairs consisting of two 8-bit registers are specified by the two characters corresponding to the register pair names followed by an apostrophe. The auxiliary register pair names are AF',BC',DE' and HL'. Only the pair AF' is actually allowed as an operand, and then only in the EX AF,AF' instruction.
- 4) The state of the four testable flags is specified as follows:

<u>FLAG</u>	<u>ON CONDITION</u>	<u>OFF</u>
<u>CONDITION</u>		
Carry	C	NC
Zero	Z	NZ
Sign	M (minus)	P (plus)
Parity	PE (even)	PO (odd)

OPERAND NOTATION

The following notation is used in the description of the assembly language:

- 1) r specifies any one of the following registers: A,B,C,D,E,H,L.
- 2) (HL) specifies the contents of memory at the location addressed by the contents of the register pair HL.
- 3) n specifies a one-byte expression in the range (0 to 255) nn specifies a two-byte expression in the range (0 to 65535).
- 4) d specifies a one-byte expression in the range (-128,127).
- 5) (nn) specifies the contents of memory at the location addressed by the two-byte expression nn.
- 6) b specifies an expression in the range (0,7).
- 7) e specifies a one-byte expression in the range (-126,129).
- 8) cc specifies the state of the Flags for conditional JR, JP, CALL and RET instructions.
- 9) qq specifies any one of the register pairs BC, DE, HL or AF.
- 10) ss specifies any one of the following register pairs: BC,DE,HL,SP.
- 11) pp specifies any one of the following register pairs: BC,DE,IX,SP.
- 12) rr specifies any one of the following register pairs: BC,DE,IY,SP.
- 13) s specifies any of r,n,(HL),(IX+d),(IY+d).
- 14) dd specifies any one of the following register pairs: BC,DE,HL,SP.
- 15) m specifies any of r,(HL),(IX+d),(IY+d).

C. RULES FOR WRITING ASSEMBLY STATEMENTS (SYNTAX)

An assembly language program (source program) consists of labels, opcodes, operands, comments and pseudo-ops in a sequence which defines the user's program.

There are 74 generic opcodes (such as LD), 25 operand key words (such as A), and 694 legitimate combinations of opcodes and operands in the Z80 instruction set.

ASSEMBLER STATEMENT FORMAT:

Statements are always written in a particular format. A typical Assembler statement is shown below:

LABEL	OPCODE	OPERANDS	COMMENT
LOOP:	LD	HL,VALUE	;GET VALUE

In this example, the label, LOOP, provides a means for assigning a specific name to the instruction LOAD (LD), and is used to address the statement in other statements. The operand field contains one or two entries separated by one or more commas, tabs or spaces. The comment field is used by the programmer to quickly identify the action defined by the statement. Comments must begin with a semicolon and labels must be terminated by a colon, unless the label starts in column No. 1.

D ASSEMBLY LANGUAGE CONVENTIONS

LABELS

A label is a symbol representing up to 16 bits of information and is used to specify an address or data. By using labels effectively, the user can write assembly language programs more rapidly and make fewer errors. If the programmer attempts to use a symbol that has been defined as greater than 8 bits for an 8-bit data constant, the assembler will generate an error message.

A label is composed of a string of one or more characters, of which the first six must be unique. For example, the labels 'longname' and 'longnamealso' will be considered to be the same label. The first character must be alphabetic and any following characters must be either alphanumeric, the question mark (?) or the under bar character (_). Any other characters within a label will cause an error. A label can start in any column if immediately followed by a colon. It does not require a colon if started in column one.

The assembler maintains a location counter to provide addresses for the symbols in the label field. When a symbol is found in the label field, the assembler places the symbol and the corresponding location counter value in a symbol table.

The symbol table normally resides in RAM, but it will automatically overflow to disk, so there is no limit to the number of labels that can be processed.

EXPRESSIONS

An expression is an operand entry consisting of either a single term (unary) or a combination of terms (binary). It contains a valid series of constants, variables and functions that can be connected by operation symbols. The Z80 Assembler will accept a wide range of expressions involving arithmetic and logical operations. The assembler will evaluate all expressions from left to right in the order indicated in the table below:

<u>OPERATOR</u>	<u>FUNCTION</u>	<u>PRIORITY</u>
+	UNARY PLUS	1
-	UNARY MINUS	1
.NOT. or \	LOGICAL NOT	1
.RES.	RESULT	1
**	EXPONENTIATION	2
*	MULTIPLICATION	3
/	DIVISION	3
.MOD.	MODULO	3
.SHR.	LOGICAL SHIFT RIGHT	3
.SHL.	LOGICAL SHIFT LEFT	3
+	ADDITION	4
-	SUBTRACTION	4
.AND. or &	LOGICAL AND	5
.OR. or †	LOGICAL OR	6
.XOR.	LOGICAL XOR	6
.EQ. or =	EQUALS	7
.GT. or >	GREATER THAN	7
.LT. or <	LESS THAN	7
.UGT.	UNSIGNED GREATER THAN	7
.ULT.	UNSIGNED LESS THAN	7

Parenthesis can be used to ensure correct expression evaluation. Note, however, that enclosing an expression wholly in parenthesis indicates a memory address.

Delimiters such as spaces or commas are not allowed within an expression since they serve to separate the expression from other portions of the statement.

16-bit integer arithmetic is used throughout.

Note that the negative of an expression can be formed by a preceding minus sign -. For example:

LD HL,-0EA9H.

The five comparison operators (.EQ., .GT., .LT., .UGT.and.ULT.) will evaluate to a logical True (all ones) if the comparison is true logical False (zero) otherwise. The operators .GT. and .LT. deal with signed numbers whereas .UGT. and .ULT. assume unsigned arguments.

The Result operator (.RES.) causes overflow to be

suppressed during evaluation of its argument, thus overflow is not flagged with an error message.

For example:

LD BC,7FFFH+1 would cause an error message,
whereas LD BC,.RES.(7FFFH+1) would not.

The Modulo operator (.MOD.) is defined as:

$X.MOD.Y. = X - Y * (X/Y)$ where the division (X/Y)
is integer division.

The Shift operator (.SHR.,.SHL.) shifts the first argument right or left by the number of positions given in the second argument. Zeros are shifted into the high-order or low-order bits, respectively.

In specifying relative addressing with either the JR (Jump Relative) or DJNZ (Decrement and Jump if Not Zero) instructions, the Assembler automatically subtracts the value of the next instruction's reference counter from the value given in the operand field to form the relative address for the jump instruction. For example:

JR C,LOOP

will jump relative to the instruction labeled LOOP if the Carry flag is set. The limits on the range of a relative address is 128 bytes in either direction from the reference counter of the next instruction. An error message will be generated if this range is exceeded.

The symbol \$ is used to represent the value of the reference counter of the current instruction, and can be used in general expressions. An expression which evaluates to a displacement in the range <-126,+129> can be added to the reference counter to form a relative address. For example:

JR C,\$+5

will jump relative to the instruction which is 5 bytes beyond the current instruction.

PSEUDO-OPS (ASSEMBLER DIRECTIVES)

There are several pseudo-ops which the various Zilog assemblers will recognize. These assembler directives, although written much like processor instructions, are commands to the assembler instead of to the processor. They direct the assembler to perform specific tasks during the assembly process but have no meaning to the Z80 processor. These assembler pseudo-ops are:

ORG	nn	Sets address reference counter to the value nn.
EQU	nn	Sets value of a label to nn in the program: can occur only once for any label.
DEFL	nn	Sets value of a label to nn and can be repeated in the program with different values for the same label.
END		Signifies the end of the source program so that any following statement will be ignored. If there is no end statement, then the end-of-file mark in the last source file will designate the end of the source program.
DEFB	n	Defines the contents of a byte at the current reference counter to be n.
DEFB	's'	Defines the content of one byte of memory to be the ASCII representation of character s.
DEFW	nn	Defines the contents of a two-byte word to be nn. The least significant byte is located at the current reference counter while the most significant byte is located at the reference counter plus one.
DEFS	nn	Reserves nn bytes of memory starting at the current value of the reference counter.

DEFH 's' Defines the content of n bytes of memory to be the ASCII representation of string s, where n is the length of s and must be in the range 0<=n<=63.

MACRO #Po #P1...#Pn Declares the label to be a macro name with formal parameters Po through Pn. Subsequent statements define the body of the macro.

ENDH Marks the end of a macro definition.

Pseudo-ops are assembled exactly like executable instructions, and may be preceded by a label and followed by a comment. (The label is required for EQU, DEFL and MACR pseudo-ops.) In the above pseudo-op definitions, the reference counter corresponds to the program counter and is used to assign and calculate machine-language addresses for the object file.

CONDITIONAL PSEUDO-OPS

Conditional pseudo-ops provide the programmer with the capability to conditionally include or not include portions of his source code in the assembly process. Conditional pseudo-ops are:

COND nn Evaluates expression nn. If the expression is true (non-zero), the COND pseudo-op is ignored. If the expression is false (zero), the assembly of subsequent statements is disabled. COND pseudo-ops cannot be nested.

ENDC Re-enables assembly of subsequent statements.

DELIMITERS

A delimiter is used to specify the bounds of a certain related group of characters in a source program. The delimiters recognized by the assembler are commas or spaces. A delimiter cannot

occur within an expression.

COMMENTS

Comments are not a functional part of an assembly program, but instead are used for program documentation to add clarity, and to facilitate software maintenance. A comment is defined as any string following a semicolon in a line, and is ignored by the assembler. Comments can begin in any column.

I/O BUFFERS

The Z80 Assembler uses a buffered I/O technique for handling the assembly language source file, listing file, object file and temporary files. The assembler automatically determines the available work space and allocates the buffer sizes accordingly. Hence there are no constraints on the size of the assembly language source file that can be assembled.

UPPER/LOWER CASE

The assembler processes source text which contains both upper and lower case alphabetic characters in the following manner. All opcodes and keywords, such as register names or condition codes, must be either all capitals or all lower case. Label names may consist of any permutation of upper and lower case, however, two names which differ in case will be treated as two different names. Thus, LABEL, label and LaBel will be considered as three different names. Notice that one could use a mixture of case to allow definition of labels or macros which look similar to opcodes, such as Push or LdiR, without redefining the meaning of the opcode. All assembler commands, such as *List or *Include (see below) can be in either upper or lower case, as can arithmetic operators such as NOT.,.AND., or .EQ., and numbers can be any mixture of case, such as 0ffffh, 0AbCdH or 011001b.

NUMBER BASES

The Assembler will accept numbers in several

different bases: binary, octal, decimal and hexadecimal. Numbers must always start with a digit (leading zeros are sufficient), and may be followed immediately by a single letter which signifies the base of the number ('B' for binary, 'O' or 'Q' for octal, 'D' for decimal and 'H' for hexadecimal). If no base is specified decimal is assumed. For example, the same number is represented in each of the four bases:

1011100B, 134Q, 134O, 92, 92D, 05CH

E. ASSEMBLER COMMANDS

The Z80 Assembler recognizes several commands to modify the listing format. An assembler command is a line of the source file beginning with an * in column one. The character in column two identifies the type of command. Arguments, if any, are separated from the command by any number of blanks or commas. The following commands are recognized by the assembler:

- | | |
|-------------------|--|
| *Eject | Causes the listing to advance to a new page starting with this line. |
| *Heading s | Causes string s to be taken as a heading to be printed at the top of each new page. Strings s may be any string of zero to 28 characters, not containing leading blanks. This command does an automatic Eject. |
| *List OFF | Causes listing and printing to be suspended, starting with this line. |
| *List ON | Causes listing and printing to resume, starting with this line. |
| *Maclist OFF | Causes listing and printing of macro expansions to be suspended, starting with this line. |
| *Maclist ON | Causes listing and printing of macro expansions to resume, starting with this line. |
| *Include filename | Causes the source file filename to be included in the source stream following the command statement. |

The expected use of *Include is for files of macro definitions, lists of EQUates, or commonly used subroutines, although it can be used anywhere in a program that the other commands would be legal. The filename must follow the normal convention for specifying filenames, and furthermore only file types 'F' through 'T' are allowed. The default type is 'S'. The included file may also contain a *Include command, up to a nested level of four.

*Include will always try to shoe-horn the file in inside a macro definition, and although the *Include statement will appear in a macro expansion, the file will not be included again at the point of expansion. *Include works in the expected manner in conjunction with conditional assembly.

For example:

```
COND exp
```

```
*Include FILE1
```

```
ENDC
```

;FILE1 is included only if the value of exp is non-zero.

III. MACROS

Macros provide a means for the user to define his own opcodes, or to redefine existing opcodes. A macro defines a body of text which will be automatically inserted in the source stream at each occurrence of a macro call. In addition, parameters provide a capability for making limited changes in the macro at each call.

If a macro is used to redefine an existing opcode, a warning message is generated to indicate that future use of that opcode will always be processed as a macro call. If a program uses macros, then the assembly option M must be specified.

MACRO DEFINITION

The body of text to be used as a macro is given in the macro definition. Each definition begins with a MACRO statement and end with an ENDM statement. The general forms are:

```
<name> MACRO [#<P0>,#<P1>,...,#<Pn>]
[<label>] ENDM
```

The label <name> is required, and must obey all the usual rules for forming labels. The quantity in brackets is an optional set of parameters.

There can be any number of parameters, each starting with the symbol #. The rest of the parameter name can be any string not containing a delimiter (blank, comma, semicolon) or the symbol #. However, parameters will be scanned left to right for a match, so the user is cautioned not to use parameter names which are prefix substrings of later parameter names. Parameter names are not entered in the symbol table.

The label on an ENDM is optional, but if one is given it must obey all the usual rules for forming labels.

Each statement between the MACRO and ENDM statements is entered into a temporary macro file. The only restriction on these statements is that they do not include another macro definition. (Nested definitions are not allowed.) They may

include macro calls. (Recursion is allowed.)

The statements of the macro body are not assembled at definition time, so they will not define labels, generate code, or cause errors. Exceptions are the assembler commands such as *List, which are executed wherever they occur. Within the macro body text, the formal parameter names may occur anywhere that an expansion-time substitution is desired. This includes comments and quoted strings. The symbol # may not occur except as the first symbol of a parameter name.

Macros must be defined before they are called.

MACRO CALLS AND MACRO EXPANSION

A macro is called by using its name as an opcode at any point after the definition. The general form is:

```
[<label>] <name> ['<S0>', '<S1>', ..., '<Sn>']
```

The <label> is optional, and <name> must be a previously defined macro. There may be any number of argument strings, <Sn>, separated by any number of blanks or commas. Commas do not serve as parameter place holders, only as string delimiters. If there are too few parameters, the missing ones are assumed to be null. If there are too many, the extras are ignored. The position of each string in the list corresponds with the position of the macro parameter name it is to replace. Thus, the third string in a macro call statement will be substituted for each occurrence of the third parameter name.

The strings may be of any length and may contain any characters. The outer level quotes around the string are generally optional, but are required if the string contains delimiters or the quote character itself. The quote character is represented by two successive quote marks at the inner level. The outer level quotes, if present, will not occur in the substitution. The null string, represented by two successive quote marks at the outer level, may be used in any parameter position.

After processing the macro call statement, the assembler switches its input from the source file

to the macro file. Each statement of the macro body is scanned for occurrences of parameter names, and for each occurrence found, the corresponding string from the macro call statement is substituted. After substitution, the statement is assembled normally.

SYMBOL GENERATOR

Every macro definition has an implicit parameter named #SYM. This may be referenced by the user in the macro body, but should not explicitly appear in the MACRO statement. At expansion time, each occurrence of #SYM in the definition is replaced by a string representing a 4-digit hexadecimal constant.

This string is constant over a given level of macro expansion, but increases by one for each new macro call. The most common use of #SYM is to provide unique labels for different expansion of the same macro. Otherwise, a macro containing a label would cause multiple definition errors if it were called more than once.

LISTING FORMAT

By default, each expanded statement is listed with a blank STMT field. If the Maclist flag is turned off by the NOM option or *M OFF, then only the macro call is listed.

IV. SUBROUTINES

Subroutines are blocks of instructions that can be called during the execution of a sequence of instructions. Subroutines can be called from main programs or from other subroutines. A subroutine is entered by the CALL opcode as in:

CALL REWIND

Parameters such as those used by the macros are not used with subroutines. When a call instruction is encountered during execution of a program, the PC is changed to the first instruction of the subroutine. The subsequent address of the invoking program is pushed on the stack. Control will return to this point when the subroutine is finished. The processor continues to execute the subroutine until it encounters a RET (return) instruction. At this point the return address is popped off the stack into the PC, and the processor returns to the address of the instruction following the CALL, to continue execution from that point.

Subroutines of any size can be invoked from programs or other subroutines of any size, without restriction. Care must be taken when nesting subroutines (subroutines within subroutines) that pushes and pops remain balanced at each level. If the processor encounters a RET with an un-popped push on the stack, the PC will be set to a meaningless address rather than to the next instruction following the CALL.

Tradeoffs must be considered between:

- a) using a block of code repetitively in line, and
- b) calling the block repetitively as a subroutine.

Program size can usually be saved by using the subroutine. If the repetitive block contains N bytes and it is repeated on M occasions in the program,

- a) $M \times N$ bytes would be used in direct programming, while
- b) $3M$ (for CALLS)

+ N (for the block)
+ 1 (for the RET)
= $3M+N+1$ bytes would be required if using a
subroutine.

For example, for a block of 20 bytes used 5 times,
in-line programming would require 100 bytes while a
subroutine would require 36.

An added advantage of subroutines is that with
careful naming, program structures become clearer,
easier to read and easier to debug and maintain.
Subroutines written for one purpose can be employed
elsewhere in other programs requiring the same
function.

Subroutines differ from Macros in several ways:

- a) Subroutine code is assembled into an object
program only once although it may be called
many times. Macro code is assembled in
line every place the macro is used.
- b) Registers and pointers required by a
subroutine must be set up before the
CALL. No parameters are used and no
argument string can be issued. Macros,
through their use of parameters, can modify
the settings of registers on each
occurrence.

V. Z80 STATUS INDICATORS (FLAGS)

The flag register (F and F') supplies information to the user regarding the status of the Z80 at any given time. The bit positions for each flag is shown below:

7	6	5	4	3	2	1	0
S	Z	X	H	X	P/V	N	C

WHERE:

C = CARRY FLAG
N = ADD/SUBTRACT FLAG
P/V = PARITY/OVERFLOW FLAG
H = HALF-CARRY FLAG
Z = ZERO FLAG
S = SIGN FLAG
X = NOT USED

Each of the two Z-80 Flag Registers contains 6 bits of status information which are set or reset by CPU operations. (Bits 3 and 5 are not used.) Four of these bits are testable (C,P/V,Z and S) for use with conditional jump, call or return instructions. Two flags are not testable (H,N) and are used for BCD arithmetic.

CARRY FLAG (C)

The carry bit is set or reset depending on the operation being performed. For 'ADD' instructions that generate a carry and 'SUBTRACT' instructions that generate a borrow, the Carry Flag will be set. The Carry Flag is reset by an ADD that does not generate a carry and a 'SUBTRACT' that generates no borrow. This saved carry facilitates software routines for extended precision arithmetic. Also, the "DAA" instruction will set the Carry Flag if the conditions for making the decimal adjustment are met.

For instructions RLA, RRA, RLS and RRS, the carry bit is used as a link between the LSB and MSB for any register or memory location. During instructions RLCA, RLC s and SLA s, the carry contains the last value shifted out of bit 7 of any register or memory location. During

instructions RRCA, RRC s, SRA s and SRL s the carry contains the last value shifted out of bit 0 of any register or memory location.

For the logical instructions AND s, OR s and XOR s, the carry will be reset.

The Carry Flag can also be set (SCF) and complemented (CCF).

ADD/SUBTRACT FLAG (N)

This flag is used by the decimal adjust accumulator instruction (DAA) to distinguish between 'ADD' and 'SUBTRACT' instructions. For all 'ADD' instructions, N will be set to an '0'. For all 'SUBTRACT' instructions, N will be set to a '1'.

PARITY/OVERFLOW FLAG

This flag is set to a particular state depending on the operation being performed.

For arithmetic operations, this flag indicates an overflow condition when the result in the Accumulator is greater than the maximum possible number (+127) or is less than the minimum possible number (-128). This overflow condition can be determined by examining the sign bits of the operands.

For addition, operands with different signs will never cause overflow. When adding operands with like signs and the result has a different sign, the overflow flag is set. For example:

+120 =	0111 1000	ADDEND
+105 =	0110 1001	AUGEND
+225	1110 0001	(-95) SUM

The two numbers added together has resulted in a number that exceeds +127 and the two positive operands has resulted in a negative number (-95) which is incorrect. The overflow flag is therefore set.

For subtraction, overflow can occur for operands of unlike signs. Operands of like sign will never cause overflow. For example:

+127	0111 1111	MINUEND
(-) -64	1100 0000	SUBTRAHEND
+191	1011 1111	DIFFERENCE

The minuend sign has changed from a positive to a negative, giving an incorrect difference. Overflow is therefore set.

Another method for predicting an overflow is to observe the carry into and out of the sign bit. If there is a carry in and no carry out, or if there is no carry in and a carry out, then overflow has occurred.

This flag is also used with logical operations and rotate instructions to indicate the parity of the result. The number of '1' bits in a byte are counted. If the total is odd, 'ODD' parity (P=0) is flagged. If the total is even, 'EVEN' parity is flagged (P=1).

During search instructions (CPI,CPIR,CPD,CPDR) and block transfer instructions (LDI,LDIR, LDD,LDDR) the P/V flag monitors the state of the byte count register (BC). When decrementing, the byte counter results in a zero value, the flag is reset to 0, otherwise the flag is a Logic 1.

During LD A,I and LD A,R instructions, the P/V flag will be set with the contents of the interrupt enable flip-flop (IFF2) for storage or testing.

When inputting a byte from an I/O device, IN r,(C), the flag will be adjusted to indicate the parity of the data.

THE HALF CARRY FLAG (H)

The Half Carry Flag (H) will be set or reset depending on the carry and borrow status between bits 3 and 4 of an 8-bit arithmetic operation. This flag is used by the decimal adjust accumulator instruction (DAA) to correct the result of a packed BCD add or subtract operation. The H flag will be set (1) or reset (0) according to the following table:

H	ADD	SUBTRACT
1	There is a carry from Bit 3 to Bit 4	There is borrow from bit 4
0	There is no carry from Bit 3 to Bit 4	There is no borrow from Bit 4

THE ZERO FLAG (Z)

The Zero Flag (Z) is set or reset if the result generated by the execution of certain instructions is a zero.

For 8-bit arithmetic and logical operations, the Z flag will be set to a '1' if the resulting byte in the Accumulator is zero. If the byte is not zero, the Z flag is reset to '0'.

For compare (search) instructions, the Z flag will be set to a '1' if a comparison is found between the value in the Accumulator and the memory location pointed to by the contents of the register pair HL.

When testing a bit in a register or memory location, the Z flag will contain the complemented state of the indicated bit (see Bit b,s).

When inputting or outputting a byte between a memory location and an I/O device (INI;IND;OUTI and OUTD), if the result of B-1 is zero, the Z flag is set, otherwise it is reset. Also for byte inputs from I/O devices using IN r,(C), the Z Flag is set to indicate a zero byte input.

THE SIGN FLAG (S)

The Sign Flag (S) stores the state of the most significant bit of the Accumulator (Bit 7). When the Z80 performs arithmetic operations on signed numbers, binary two's complement notation is used to represent and process numeric information. A positive number is identified by a '0' in bit 7. A negative number is identified by a '1'. The binary equivalent of the magnitude of a positive number is stored in bits 0 to 6 for a total range of from 0 to 127. A negative number is represented by the two's complement of the equivalent positive number. The total range for negative numbers is from -1 to -128.

When inputting a byte from an I/O device to a register, IN r,(C), the S flag will indicate either positive (S=0) or negative (S=1) data.

VI. Z80 INSTRUCTION SET

NOTE: Execution time (E.T.) for each instruction is given in microseconds for an assumed 4 MHz clock. Total machine cycles (M) are indicated with total clock periods (T States). Also indicated are the number of T States for each M cycle. For example:

M CYCLES: 2 T STATES: 7(4,3) 4 MHz E.T.: 1.75

indicates that the instruction consists of 2 machine cycles. The first cycle contains 4 clock periods (T States). The second cycle contains 3 clock periods for a total of 7 clock periods or T States. The instruction will execute in 1.75 microseconds.

Register format is shown for each instruction with the most significant bit to the left and the least significant bit to the right.

Z80 INSTRUCTION SET
TABLE OF CONTENTS

	PAGE
-8 BIT LOAD GROUP.....	26
-16 BIT LOAD GROUP.....	52
-EXCHANGE, BLOCK TRANSFER AND SEARCH GROUP.....	76
-8 BIT ARITHMETIC AND LOGICAL GROUP.....	99
-GENERAL PURPOSE ARITHMETIC AND CPU CONTROL GROUPS.....	131
-16 BIT ARITHMETIC GROUP.....	146
-ROTATE AND SHIFT GROUP.....	163
-BIT SET, RESET AND TEST GROUP.....	202
-JUMP GROUP.....	219
-CALL AND RETURN GROUP.....	237
-INPUT AND OUTPUT GROUP.....	252
-INSTRUCTION INDEX.....	275

8 BIT LOAD GROUP

LD r, r'

Operation: $r \leftarrow r'$

Format:

<u>Opcode</u>	<u>Operands</u>
LD	r, r'

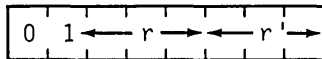

Description:

The contents of any register r' are loaded into any other register r . Note: r, r' identifies any of the registers A, B, C, D, E, H, or L, assembled as follows in the object code:

Register r, r'

A = 111
B = 000
C = 001
D = 010
E = 011
H = 100
L = 101

M CYCLES: 1 T STATES: 4 4 MHZ E.T.: 1.0

Condition Bits Affected: None

Example:

If the H register contains the number 8AH, and the E register contains 10H, the instruction

LD H, E

would result in both registers containing 10H.

LD r, n

Operation: $r \leftarrow n$

Format:

<u>Opcode</u>	<u>Operands</u>
LD	r, n

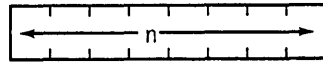
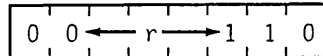

Description:

The eight-bit integer n is loaded into any register r , where r identifies register A, B, C, D, E, H or L, assembled as follows in the object code:

Register r

A = 111
B = 000
C = 001
D = 010
E = 011
H = 100
L = 101

M CYCLES: 2 T STATES: 7(4,3) 4 MHZ E.T.: 1.75

Condition Bits Affected: None

Example:

After the execution of

LD E, A5H

the contents of register E will be A5H.

LD r, (HL)

Operation: r ← (HL)

Format:

<u>Opcode</u>	<u>Operands</u>
LD	r, (HL)

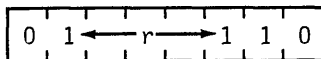

Description:

The eight-bit contents of memory location (HL) are loaded into register r, where r identifies register A, B, C, D, E, H or L, assembled as follows in the object code:

<u>Register</u>	<u>r</u>
A	= 111
B	= 000
C	= 001
D	= 010
E	= 011
H	= 100
L	= 101

M CYCLES: 2 T STATES: 7(4,3) 4 MHZ E.T.: 1.75

Condition Bits Affected: None

Example:

If register pair HL contains the number 75A1H, and memory address 75A1H contains the byte 58H, the execution of

LD C, (HL)

will result in 58H in register C.

LD r, (IX+d)

Operation: $r \leftarrow (IX+d)$

Format:

<u>Opcode</u>	<u>Operands</u>
LD	r, (IX+d)

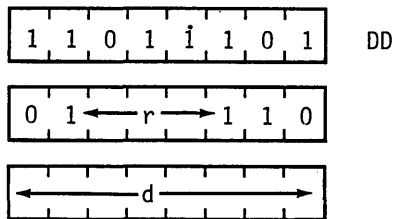

Description:

The operand (IX+d) (the contents of the Index Register IX summed with a two's complement displacement integer d) is loaded into register r, where r identifies register A, B, C, D, E, H or L, assembled as follows in the object code:

Register r

A = 111
B = 000
C = 001
D = 010
E = 011
H = 100
L = 101

M CYCLES: 5 T STATES: 19(4,4,3,5,3) 4 MHZ E.T.: 4.75

Condition Bits Affected: None

Example:

If the Index Register IX contains the number 25AFH, the instruction

LD B, (IX+19H)

will cause the calculation of the sum $25AFH + 19H$, which points to memory location $25C8H$. If this address contains byte $39H$, the instruction will result in register B also containing $39H$.

LD r, (IY+d)

Operation: $r \leftarrow (IY+d)$

Format:

<u>Opcode</u>	<u>Operands</u>
LD	r, (IY+d)

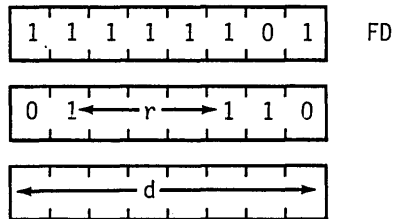

Description:

The operand (IY+d) (the contents of the Index Register IY summed with a two's complement displacement integer d) is loaded into register r, where r identifies register A, B, C, D, E, H or L, assembled as follows in the object code:

Register r

A = 111
B = 000
C = 001
D = 010
E = 011
H = 100
L = 101

M CYCLES: 5 T STATES: 19(4,4,3,5,3) 4 MHZ E.T.: 4.75

Condition Bits Affected: None

Example:

If the Index Register IY contains the number 25AFH, the instruction

LD B, (IY+19H)

will cause the calculation of the sum 25AFH + 19H, which points to memory location 25C8H. If this address contains byte 39H, the instruction will result in register B also containing 39H.

LD (HL), r

Operation: (HL) ← r

Format:

<u>Opcode</u>	<u>Operands</u>
LD	(HL), r

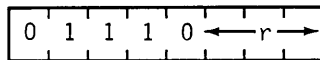

Description:

The contents of register r are loaded into the memory location specified by the contents of the HL register pair. The symbol r identifies register A, B, C, D, E, H or L, assembled as follows in the object code:

Register r

A	=	111
B	=	000
C	=	001
D	=	010
E	=	011
H	=	100
L	=	101

M CYCLES: 2 T STATES: 7(4,3) 4 MHZ E.T.: 1.75

Condition Bits Affected: None

Example:

If the contents of register pair HL specifies memory location 2146H, and the B register contains the byte 29H, after the execution of

LD (HL), B

memory address 2146H will also contain 29H.

LD (IX+d), r

Operation: (IX+d) ← r

Format:

<u>Opcode</u>	<u>Operands</u>
LD	(IX+d), r

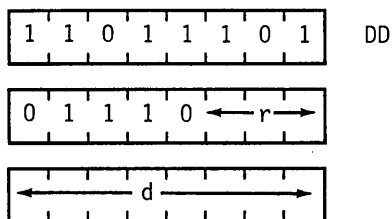

Description:

The contents of register r are loaded into the memory address specified by the contents of Index Register IX summed with d, a two's complement displacement integer. The symbol r identifies register A, B, C, D, E, H or L, assembled as follows in the object code:

<u>Register</u>	<u>r</u>
A	= 111
B	= 000
C	= 001
D	= 010
E	= 011
H	= 100
L	= 101

M CYCLES: 5 T STATES: 19(4,4,3,5,3) 4 MHZ E.T.: 4.75

Condition Bits Affected: None

Example:

If the C register contains the byte 1CH, and the Index Register IX contains 3100H, then the instruction

LD (IX+6H), C

will perform the sum 3100H + 6H and will load 1CH into memory location 3106H.

LD (IY+d), r

Operation: (IY+d) ← r

Format:

<u>Opcode</u>	<u>Operands</u>
LD	(IY+d), r

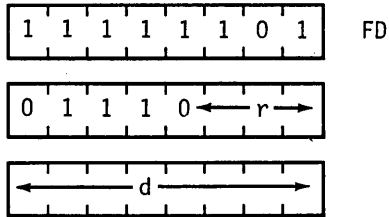

Description:

The contents of register r are loaded into the memory address specified by the sum of the contents of the Index Register IY and d, a two's complement displacement integer. The symbol r is specified according to the following table.

<u>Register</u>	<u>r</u>
A	= 111
B	= 000
C	= 001
D	= 010
E	= 011
H	= 100
L	= 101

M CYCLES: 5 T STATES: 19(4,4,3,5,3) 4 MHZ E.T.: 4.75

Condition Bits Affected: None

Example:

If the C register contains the byte 48H, and the Index Register IY contains 2A11H, then the instruction

LD (IY+4H), C

will perform the sum $2A11H + 4H$, and will load 48H into memory location 2A15.

LD (HL), n

Operation: (HL) ← n

Format:

<u>Opcode</u>	<u>Operand</u>
LD	(HL), n

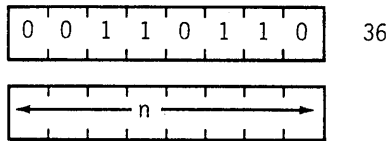

Description:

Integer n is loaded into the memory address specified by the contents of the HL register pair.

M CYCLES: 3 T STATES: 10(4,3,3) 4 MHZ E.T.: 2.50

Condition Bits Affected: None

Example:

If the HL register pair contains 4444H, the instruction

LD (HL), 28H

will result in the memory location 4444H containing the byte 28H.

LD (IX+d), n

Operation: (IX+d) ← n

Format:

<u>Opcode</u>	<u>Operands</u>
LD	(IX+d), n

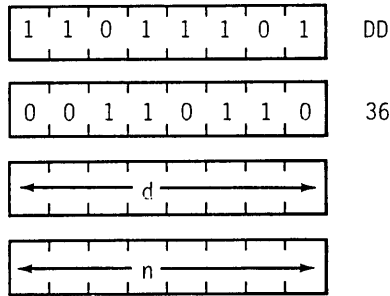

Description:

The n operand is loaded into the memory address specified by the sum of the contents of the Index Register IX and the two's complement displacement operand d.

M CYCLES: 5 T STATES: 19(4,4,3,5,3) 4 MHZ E.T.: 4.75

Condition Bits Affected: None

Example:

If the Index Register IX contains the number 219AH the instruction

LD (IX+5H), 5AH

would result in the byte 5AH in the memory address 219FH.

LD (IY+d), n

Operation: (IY+d) ← n

Format:

<u>Opcode</u>	<u>Operands</u>
LD	(IY+d),n

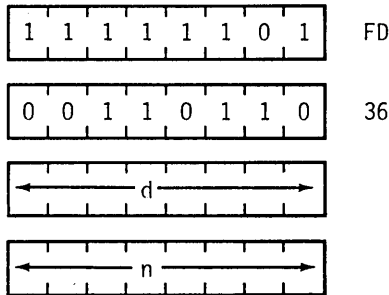

Description:

Integer n is loaded into the memory location specified by the contents of the Index Register summed with the two's complement displacement integer d.

M CYCLES: 5 T STATES: 19(4,4,3,5,3) 4 MHZ E.T.: 4.75

Condition Bits Affected: NONE

Example:

If the Index Register IY contains the number A940H, the instruction

LD (IY+10H), 97H

would result in byte 97 in memory location A950H.

LD A, (BC)

Operation: A ← (BC)

Format:

<u>Opcode</u>	<u>Operands</u>
LD	A, (BC)

0	0	0	0	1	0	1	0
---	---	---	---	---	---	---	---

 0A

Description:

The contents of the memory location specified by the contents of the BC register pair are loaded into the Accumulator.

M CYCLES: 2 T STATES: 7(4,3) 4 MHZ E.T.: 1.75

Condition Bits Affected: None

Example:

If the BC register pair contains the number 4747H, and memory address 4747H contains the byte 12H, then the instruction

LD A, (BC)

will result in byte 12H in register A.

LD A, (DE)

Operation: A ← (DE)

Format:

<u>Opcode</u>	<u>Operands</u>
LD	A, (DE)

0	0	0	1	1	0	1	0
---	---	---	---	---	---	---	---

 1A

Description:

The contents of the memory location specified by the register pair DE are loaded into the Accumulator.

M CYCLES: 2 T STATES: 7(4,3) 4 MHZ E.T.: 1.75

Condition Bits Affected: None

Example:

If the DE register pair contains the number 30A2H and memory address 30A2H contains the byte 22H, then the instruction

LD A, (DE)

will result in byte 22H in register A.

LD A, (nn)

Operation: $A \leftarrow (nn)$

Format:

<u>Opcode</u>	<u>Operands</u>
LD	A, (nn)

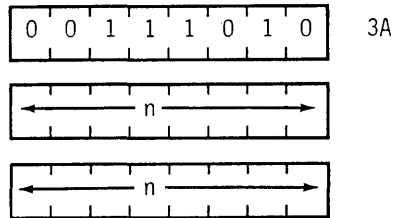

Description:

The contents of the memory location specified by the operands nn are loaded into the Accumulator. The first n operand after the op code is the low order byte of a two-byte memory address.

M CYCLES: 4 T STATES: 13(4,3,3,3) 4 MHZ E.T.: 3.25

Condition Bits Affected: None

Example:

If the contents of nn is number 8832H, and the content of memory address 8832H is byte 04H, after the instruction

LD A, (nn)

byte 04H will be in the Accumulator.

LD (BC), A

Operation: (BC) ← A

Format:

<u>Opcode</u>	<u>Operands</u>
LD	(BC),A

0 0 0 0 0 0 1 0	02
-----------------	----

Description:

The contents of the Accumulator are loaded into the memory location specified by the contents of the register pair BC.

M CYCLES: 2 T STATES: 7(4,3) 4 MHZ E.T.: 1.75

Condition Bits Affected: None

Example:

If the Accumulator contains 7AH and the BC register pair contains 1212H the instruction

LD (BC),A

will result in 7AH being in memory location 1212H.

LD (DE), A

Operation: (DE) ← A

Format:

<u>Opcode</u>	<u>Operands</u>
LD	(DE),A

0 0 0 1 0 0 1 0	12
-----------------	----

Description:

The contents of the Accumulator are loaded into the memory location specified by the contents of the DE register pair.

M CYCLES: 2 T STATES: 7(4,3) 4 MHZ E.T.: 1.75

Condition Bits Affected: None

Example:

If the contents of register pair DE are 1128H, and the Accumulator contains byte A0H, the instruction

LD (DE),A

will result in A0H being in memory location 1128H.

LD (nn), A

Operation: (nn) ← A

Format:

<u>Opcode</u>	<u>Operands</u>
LD	(nn),A

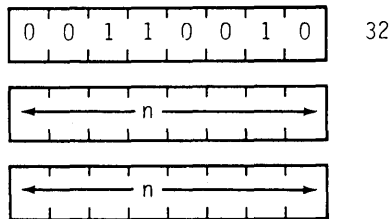

Description:

The contents of the Accumulator are loaded into the memory address specified by the operand nn. The first n operand after the op code is the low order byte of nn.

M CYCLES: 4 T STATES: 13(4,3,3,3) 4 MHZ E.T.: 3.25

Condition Bits Affected: None

Example:

If the contents of the Accumulator are byte D7H, after the execution of

LD (3141H),A

D7H will be in memory location 3141H.

LD A, I

Operation: A ← I

Format:

<u>Opcode</u>	<u>Operands</u>
LD	A, I

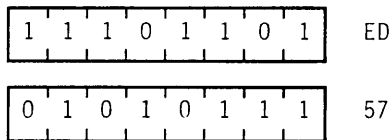

Description:

The contents of the Interrupt Vector Register I are loaded into the Accumulator.

M CYCLES: 2 T STATES: 9(4,5) 4 MHZ E.T.: 2.25

Condition Bits Affected:

S:	Set if I-Reg. is negative; reset otherwise
Z:	Set if I-Reg. is zero; reset otherwise
H:	Reset
P/V:	Contains contents of IFF2
N:	Reset
C:	Not affected

Note:

If an interrupt occurs during execution of this instruction, the Parity flag will contain a 0.

LD A, R

Operation: $A \leftarrow R$

Format:

<u>Opcode</u>	<u>Operands</u>
LD	A, R

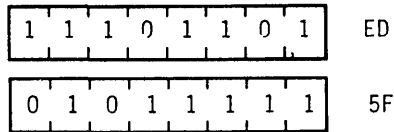

Description:

The contents of Memory Refresh Register R are loaded into the Accumulator.

M CYCLES: 2 T STATES: 9(4,5) 4 MHZ E.T.: 2.25

Condition Bits Affected:

S:	Set if R-Reg. is negative; reset otherwise
Z:	Set if R-Reg. is zero; reset otherwise
H:	Reset
P/V:	Contains contents of IFF2
N:	Reset
C:	Not affected

LD I, A

Operation: $I \leftarrow A$

Format:

<u>Opcode</u>	<u>Operands</u>
LD	I, A

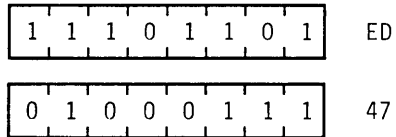

Description:

The contents of the Accumulator are loaded into the Interrupt Control Vector Register, I.

M CYCLES: 2 T STATES: 9(4,5) 4 MHZ E.T.: 2.25

Condition Bits Affected: None

LD R, A

Operation: R ← A

Format:

<u>Opcode</u>	<u>Operands</u>
LD	R,A

1 1 1 0 1 1 0 1	ED
-----------------	----

0 1 0 0 1 1 1 1	4F
-----------------	----

Description:

The contents of the Accumulator are loaded into the Memory Refresh register R.

M CYCLES: 2 T STATES: 9(4,5) 4 MHZ E.T.: 2.25

Condition Bits Affected: None

-16 BIT LOAD GROUP-

LD dd, nn

Operation: $dd \leftarrow nn$

Format:

<u>Opcode</u>	<u>Operands</u>
LD	dd, nn

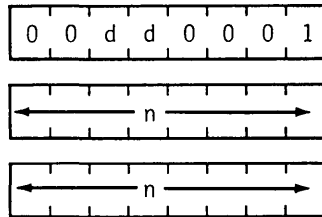

Description:

The two-byte integer nn is loaded into the dd register pair, where dd defines the BC, DE, HL, or SP register pairs, assembled as follows in the object code:

<u>Pair</u>	<u>dd</u>
BC	00
DE	01
HL	10
SP	11

The first n operand after the op code is the low order byte.

M CYCLES: 3 T STATES: 10(4,3,3) 4 MHZ E.T.: 2.50

Condition Bits Affected: None

Example:

After the execution of

```
LD HL, 5000H
```

the contents of the HL register pair will be 5000H.

LD IX, nn

Operation: IX ← nn

Format:

Opcode Operands

LD IX,nn

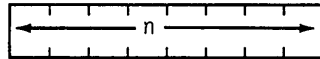
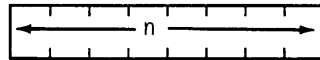
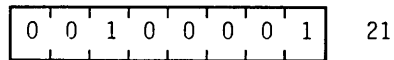
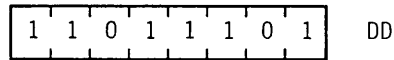

Description:

Integer nn is loaded into the Index Register IX. The first n operand after the op code is the low order byte.

M CYCLES: 4 T STATES: 14(4,4,3,3) 4 MHZ E.T.: 3.50

Condition Bits Affected: None

Example:

After the instruction

LD IX,45A2H

the Index Register will contain integer 45A2H.

LD IY, nn

Operation: IY ← nn

Format:

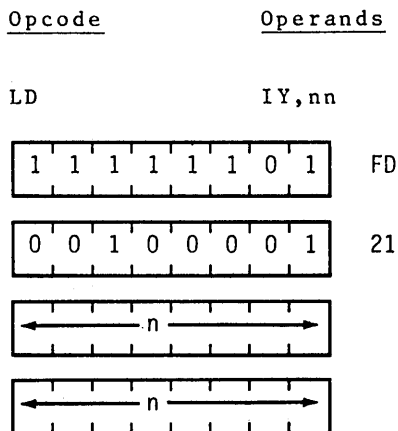

Description:

Integer nn is loaded into the Index Register IY. The first n operand after the op code is the low order byte.

M CYCLES: 4 T STATES: 14(4,4,3,3) 4 MHZ E.T.: 3.50

Condition Bits Affected: None

Example:

After the instruction:

LD IY,7733H

the Index Register IY will contain the integer 7733H.

LD HL, (nn)

Operation: $H \leftarrow (nn+1)$, $L \leftarrow (nn)$

Format:

Opcode Operands

LD HL, (nn)

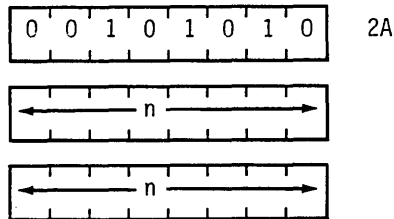

Description:

The contents of memory address (nn) are loaded into the low order portion of register pair HL (register L), and the contents of the next highest memory address (nn+1) are loaded into the high order portion of HL (register H). The first n operand after the op code is the low order byte of nn.

M CYCLES: 5 T STATES: 16(4,3,3,3,3) 4 MHZ E.T.: 4.00

Condition Bits Affected: None

Example:

If address 4545H contains 37H and address 4546H contains A1H after the instruction

LD HL,(4545H)

the HL register pair will contain A137H.

LD dd, (nn)

Operation: $dd_H \leftarrow (nn+1)$ $dd_L \leftarrow (nn)$

Format:

<u>Opcode</u>	<u>Operands</u>
LD	dd, (nn)

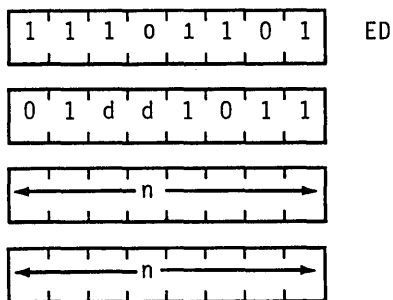

Description:

The contents of address (nn) are loaded into the low order portion of register pair dd, and the contents of the next highest memory address (nn+1) are loaded into the high order portion of dd. Register pair dd defines BC, DE, HL, or SP register pairs, assembled as follows in the object code:

<u>Pair</u>	<u>dd</u>
BC	00
DE	01
HL	10
SP	11

The first n operand after the op code is the low order byte of (nn).

M CYCLES: 6 T STATES: 20(4,4,3,3,3,3) 4 MHZ E.T.: 5.00

Condition Bits Affected: None

Example:

If Address 2130H contains 65H and address 2131M contains 78H after the instruction

LD BC, (2130H)

the BC register pair will contain 7865H.

LD IX, (nn)

Operation: $IX_H \leftarrow (nn+1), IX_L \leftarrow (nn)$

Format:

Opcode Operands

LD IX, (nn)

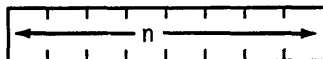
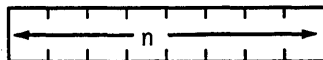
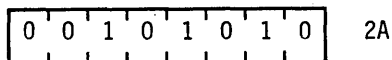
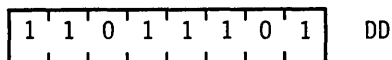

Description:

The contents of the address (nn) are loaded into the low order portion of Index Register IX, and the contents of the next highest memory address (nn+1) are loaded into the high order portion of IX. The first n operand after the op code is the low order byte of nn.

M CYCLES: 6 T STATES: 20(4,4,3,3,3,3) 4 MHZ E.T.: 5.00

Condition Bits Affected: None

Example:

If address 6666H contains 92H and address 6667H contains DAH, after the instruction

LD IX, (6666H)

the Index Register IX will contain DA92H.

LD IY, (nn)

Operation: $IY_H \leftarrow (nn+1)$, $IY_L \leftarrow (nn)$

Format:

Opcode Operands

LD IY, (nn)

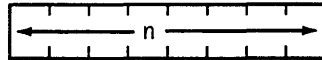
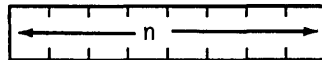
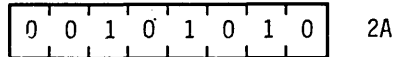

Description:

The contents of address (nn) are loaded into the low order portion of Index Register IY, and the contents of the next highest memory address (nn+1) are loaded into the high order portion of IY. The first n operand after the op code is the low order byte of nn.

M CYCLES: 6 T STATES: 20(4,4,3,3,3,3) 4 MHZ E.T.: 5.00

Condition Bits Affected: None

Example:

If address 6666H contains 92H and address 6667H contains DAH, after the instruction

LD IY, (6666H)

the Index Register IY will contain DA92H.

LD (nn), HL

Operation: (nn+1) ← H, (nn) ← L

Format:

<u>Opcode</u>	<u>Operands</u>
LD	(nn),HL

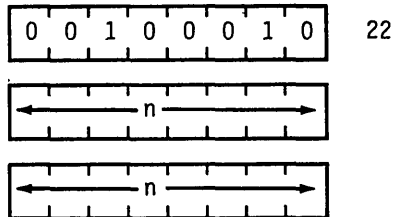

Description:

The contents of the low order portion of register pair HL (register L) are loaded into memory address (nn), and the contents of the high order portion of HL (register H) are loaded into the next highest memory address (nn+1). The first n operand after the op code is the low order byte of nn.

M CYCLES: 5 T STATES: 16(4,3,3,3,3) 4 MHZ E.T.: 4.00

Condition Bits Affected: None

Example:

If the content of register pair HL is 483AH, after the instruction

LD (B229H),HL

address B229H) will contain 3AH, and address B22AH will contain 48H.

LD (nn), dd

Operation: (nn+1) ← dd_H, (nn) ← dd_L

Format:

<u>Opcode</u>	<u>Operands</u>
LD	(nn), dd

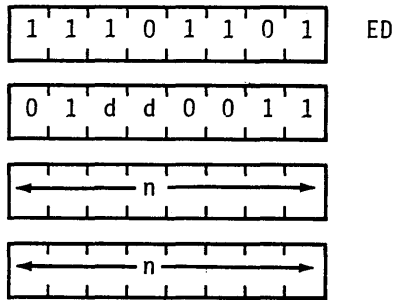

Description:

The low order byte of register pair dd is loaded into memory address (nn); the upper byte is loaded into memory address (nn+1). Register pair dd defines either BC, DE, HL, or SP, assembled as follows in the object code:

<u>Pair</u>	<u>dd</u>
BC	00
DE	01
HL	10
SP	11

The first n operand after the op code is the low order byte of a two byte memory address.

M CYCLES: 6 T STATES: 20(4,4,3,3,3,3) 4 MHZ E.T.: 5.00

Condition Bits Affected: None

Example:

If register pair BC contains the number 4644H, the instruction

LD (1000H),BC

will result in 44H in memory location 1000H, and 46H in memory location 1001H.

LD (nn), IX

Operation: (nn+1) ← IX_H, (nn) ← IX_L

Format:

<u>Opcode</u>	<u>Operands</u>
LD	(nn), IX

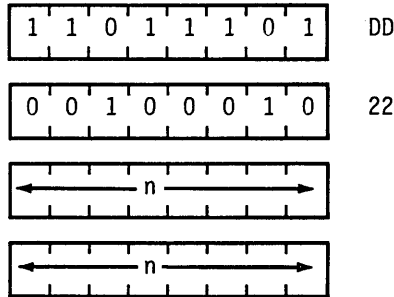

Description:

The low order byte in Index Register IX is loaded into memory address (nn); the upper order byte is loaded into the next highest address (nn+1). The first n operand after the op code is the low order byte of nn.

M CYCLES: 6 T STATES: 20(4,4,3,3,3,3) 4 MHZ E.T.: 5.00

Condition Bits Affected: None

Example:

If the Index Register IX contains 5A30H, after the instruction

LD (4392H), IX

memory location 4392H will contain number 30H and location 4393H will contain 5AH.

LD (nn), IY

Operation: (nn+1) ← IY_H, (nn) ← IY_L

Format:

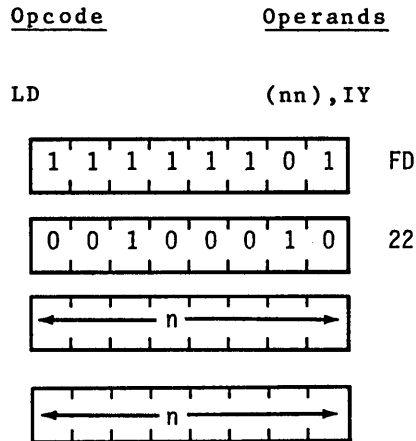

Description:

The low order byte in Index Register IY is loaded into memory address (nn); the upper order byte is loaded into memory location (nn+1). The first n operand after the op code is the low order byte of nn.

M CYCLES: 6 T STATES: 20(4,4,3,3,3,3) 4 MHZ E.T.: 5.00

Condition Bits Affected: None

Example:

If the Index Register IY contains 4174H after the instruction

LD (8838H), IY

memory location 8838H will contain number 74H and memory location 8839H will contain 41H.

LD SP, HL

Operation: SP ← HL

Format:

Opcode Operands

LD SP,HL

1	1	1	1	1	0	0	1
---	---	---	---	---	---	---	---

 F9

Description:

The contents of the register pair HL are loaded into the Stack Pointer SP.

M CYCLES: 1 T STATES: 6 4 MHZ E.T.: 1.50

Condition Bits Affected: None

Example:

If the register pair HL contains 442EH, after the instruction

LD SP,HL

the Stack Pointer will also contain 442EH.

LD SP, IX

Operation: SP ← IX

Format:

Opcode Operands

LD SP, IX

1	1	0	1	1	1	0	1
---	---	---	---	---	---	---	---

 DD

1	1	1	1	1	0	0	1
---	---	---	---	---	---	---	---

 F9

Description:

The two byte contents of Index Register IX are loaded into the Stack Pointer SP.

M CYCLES: 2 T STATES: 10(4,6) 4 MHZ E.T.: 2.50

Condition Bits Affected: None

Example:

If the contents of the Index Register IX are 98DAH, after the instruction

LD SP, IX

the contents of the Stack Pointer will also be 98DAH.

LD SP, IY

Operation: SP ← IY

Format:

Opcode Operands

LD SP, IY

1	1	1	1	1	1	0	1
---	---	---	---	---	---	---	---

 FD

1	1	1	1	1	0	0	1
---	---	---	---	---	---	---	---

 F9

Description:

The two byte contents of Index Register IY are loaded into the Stack Pointer SP.

M CYCLES: 2 T STATES: 10(4,6) 4 MHZ E.T.: 2.50

Condition Bits Affected: None

Example:

If Index Register IY contains the integer A227H, after the instruction

LD SP, IY

the Stack Pointer will also contain A227H.

PUSH qq

PUSH qq

Operation: (SP-2) ← qq_L, (SP-1) ← qq_H

Format:

<u>Opcode</u>	<u>Operands</u>
PUSH	qq

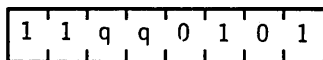

Description:

The contents of the register pair qq are pushed into the external memory LIFO (last-in, first-out) Stack. The Stack Pointer (SP) register pair holds the 16-bit address of the current "top" of the Stack. This instruction first decrements the SP and loads the high order byte of register pair qq into the memory address now specified by the SP; then decrements the SP again and loads the low order byte of qq into the memory location corresponding to this new address in the SP. The operand qq identifies register pair BC, DE, HL, or AF, assembled as follows in the object code:

<u>Pair</u>	<u>qq</u>
BC	00
DE	01
HL	10
AF	11

M CYCLES: 3 T STATES: 11(5,3,3) 4 MHZ E.T.: 2.75

Condition Bits Affected: None

Example:

If the AF register pair contains 2233H and the Stack Pointer contains 1007H, after the instruction

PUSH AF

memory address 1006H will contain 22H, memory address 1005H will contain 33H, and the Stack Pointer will contain 1005H.

PUSH IX

Operation: (SP-2) ← IX_L, (SP-1) ← IX_H

Format:

<u>Opcode</u>	<u>Operands</u>								
PUSH	IX								
<table border="1"><tr><td>1</td><td>1</td><td>0</td><td>1</td><td>1</td><td>1</td><td>0</td><td>1</td></tr></table>	1	1	0	1	1	1	0	1	DD
1	1	0	1	1	1	0	1		
<table border="1"><tr><td>1</td><td>1</td><td>1</td><td>0</td><td>0</td><td>1</td><td>0</td><td>1</td></tr></table>	1	1	1	0	0	1	0	1	E5
1	1	1	0	0	1	0	1		

Description:

The contents of the Index Register IX are pushed into the external memory LIFO (last-in, first-out) Stack. The Stack Pointer (SP) register pair holds the 16-bit address of the current "top" of the Stack. This instruction first decrements the SP and loads the high order byte of IX into the memory address now specified by the SP; then decrements the SP again and loads the low order byte into the memory location corresponding to this new address in the SP.

M CYCLES: 3 T STATES: 15(4,5,3,3) 4 MHZ E.T.: 3.75

Condition Bits Affected: None

Example:

If the Index Register IX contains 2233H and the Stack Pointer contains 1007H, after the instruction

PUSH IX

memory address 1006H will contain 22H, memory address 1005H will contain 33H, and the Stack Pointer will contain 1005H.

PUSH IY

Operation: (SP-2) ← IY_L, (SP-1) ← IY_H

Format:

Opcode Operands

PUSH IY

1	1	1	1	1	1	0	1	FD
---	---	---	---	---	---	---	---	----

1	1	1	0	0	1	0	1	E5
---	---	---	---	---	---	---	---	----

Description:

The contents of the Index Register IY are pushed into the external memory LIFO (last-in, first-out) Stack. The Stack Pointer (SP) register pair holds the 16-bit address of the current "top" of the Stack. This instruction first decrements the SP and loads the high order byte of IY into the memory address now specified by the SP; then decrements the SP again and loads the low order byte into the memory location corresponding to this new address in the SP.

M CYCLES: 4 T STATES: 15(4,5,3,3) 4 MHZ E.T.: 3.75

Condition Bits Affected: None

Example:

If the Index Register IY contains 2233H and the Stack Pointer contains 1007H, after the instruction

PUSH IY

memory address 1006H will contain 22H, memory address 1005H will contain 33H, and the Stack Pointer will contain 1005H.

POP qq

Operation: qq_H ← (SP+1), qq_L ← (SP)

Format:

<u>Opcode</u>	<u>Operands</u>
POP	qq

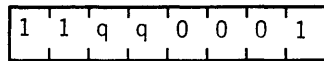

Description:

The top two bytes of the external memory LIFO (last-in, first-out) Stack are popped into register pair qq. The Stack Pointer (SP) register pair holds the 16-bit address of the current "top" of the Stack. This instruction first loads into the low order portion of qq, the byte at the memory location corresponding to the contents of SP; then SP is incremented and the contents of the corresponding adjacent memory location are loaded into the high order portion of qq and the SP is now incremented again. The operand qq identifies register pair BC, DE, HL, or AF, assembled as follows in the object code:

<u>Pair</u>	<u>r</u>
BC	00
DE	01
HL	10
AF	11

M CYCLES: 3 T STATES: 10(4,3,3) 4 MHZ E.T.: 2.50

Condition Bits Affected: None

Example:

If the Stack Pointer contains 1000H, memory location 1000H contains 55H, and location 1001H contains 33H, the instruction

POP HL

will result in register pair HL containing 3355H, and the Stack Pointer containing 1002H.

POP IX

Operation: $IX_H \leftarrow (SP+1), IX_L \leftarrow (SP)$

Format:

<u>Opcode</u>	<u>Operands</u>																
POP	IX																
<table border="1"><tr><td>1</td><td>1</td><td>0</td><td>1</td><td>1</td><td>1</td><td>0</td><td>1</td></tr><tr><td> </td><td> </td><td> </td><td> </td><td> </td><td> </td><td> </td><td> </td></tr></table>	1	1	0	1	1	1	0	1									DD
1	1	0	1	1	1	0	1										
<table border="1"><tr><td>1</td><td>1</td><td>1</td><td>0</td><td>0</td><td>0</td><td>0</td><td>1</td></tr><tr><td> </td><td> </td><td> </td><td> </td><td> </td><td> </td><td> </td><td> </td></tr></table>	1	1	1	0	0	0	0	1									E1
1	1	1	0	0	0	0	1										

Description:

The top two bytes of the external memory LIFO (last-in, first-out) Stack are popped into Index Register IX. The Stack Pointer (SP) register pair holds the 16-bit address of the current "top" of the Stack. This instruction first loads into the low order portion of IX the byte at the memory location corresponding to the contents of SP; then SP is incremented and the contents of the corresponding adjacent memory location are loaded into the high order portion of IX. The SP is now incremented again.

M CYCLES: 4 T STATES: 14(4,4,3,3) 4 MHZ E.T.: 3.50

Condition Bits Affected: None

Example:

If the Stack Pointer contains 1000H, memory location 1000H contains 55H, and location 1001H contains 33H, the instruction

POP IX

will result in Index Register IX containing 3355H, and the Stack Pointer containing 1002H.

POP IY

Operation: $IY_H \leftarrow (SP+1), IY_L \leftarrow (SP)$

Format:

Opcode Operands

POP IY

1	1	1	1	1	1	0	1	FD
---	---	---	---	---	---	---	---	----

1	1	1	0	0	0	0	1	E1
---	---	---	---	---	---	---	---	----

Description:

The top two bytes of the external memory LIFO (last-in, first-out) Stack are popped into Index Register IY. The Stack Pointer (SP) register pair holds the 16-bit address of the current "top" of the Stack. This instruction first loads into the low order portion of IY the byte at the memory location corresponding to the contents of SP; then SP is incremented and the contents of the corresponding adjacent memory location are loaded into the high order portion of IY. The SP is now incremented again.

M CYCLES: 4 T STATES: 14(4,4,3,3) 4 MHZ E.T.: 3.50

Condition Bits Affected: None

Example:

If the Stack Pointer contains 1000H, memory location 1000H contains 55H, and location 1001H contains 33H, the instruction

POP IY

will result in Index Register IY containing 3355H, and the Stack Pointer containing 1002H.

-EXCHANGE, BLOCK TRANSFER AND SEARCH GROUP-

EX DE, HL

Operation: DE ↔ HL

Format:

<u>Opcode</u>	<u>Operands</u>								
EX	DE,HL								
<table border="1"><tr><td>1</td><td>1</td><td>1</td><td>0</td><td>1</td><td>0</td><td>1</td><td>1</td></tr></table>	1	1	1	0	1	0	1	1	EB
1	1	1	0	1	0	1	1		

Description:

The two-byte contents of register pairs DE and HL are exchanged.

M CYCLES: 1 T STATES: 4 4 MHZ E.T.: 1.00

Condition Bits Affected: None

Example:

If the content of register pair DE is the number 2822H, and the content of the register pair HL is number 499AH, after the instruction

EX DE,HL

the content of register pair DE will be 499AH and the content of register pair HL will be 2822H.

EX AF, AF'

Operation: AF ↔ AF'

Format:

<u>Opcode</u>	<u>Operands</u>
EX	AF,AF'

0	0	0	0	1	0	0	0
---	---	---	---	---	---	---	---

 08

Description:

The two-byte contents of the register pairs AF and AF' are exchanged. (Note: register pair AF' consists of registers A' and F'.)

M CYCLES: 1 T STATES: 4 4 MHZ E.T.: 1.00

Condition Bits Affected: None

Example:

If the content of register pair AF is number 9900H, and the content of register pair AF' is number 5944H, after the instruction

EX AF,AF'

the contents of AF will be 5944H, and the contents of AF' will be 9900H.

EXX

Operation: (BC) ↔ (BC'), (DE) ↔ (DE'), (HL) ↔ (HL')

Format:

<u>Opcode</u>	<u>Operands</u>
EXX	

1	1	0	1	1	0	0	1	D9
---	---	---	---	---	---	---	---	----

Description:

Each two-byte value in register pairs BC, DE, and HL is exchanged with the two-byte value in BC', DE', and HL', respectively.

M CYCLES: 1 T STATES: 4 4 MHZ E.T.: 1.00

Condition Bits Affected: None

Example:

If the contents of register pairs BC, DE, and HL are the numbers 445AH, 3DA2H, and 8859H, respectively, and the contents of register pairs BC', DE', and HL' are 0988H, 9300H, and 00E7H, respectively, after the instruction

EXX

the contents of the register pairs will be as follows:
BC: 0988H; DE: 9300H; HL: 00E7H; BC': 445AH; DE': 3DA2H;
and HL': 8859H.

EX (SP), HL

Operation: H ↔ (SP+1), L ↔ (SP)

Format:

<u>Opcode</u>	<u>Operands</u>
EX	(SP),HL

1	1	1	0	0	0	1	1
---	---	---	---	---	---	---	---

 E3

Description:

The low order byte contained in register pair HL is exchanged with the contents of the memory address specified by the contents of register pair SP (Stack Pointer), and the high order byte of HL is exchanged with the next highest memory address (SP+1).

M CYCLES: 5 T STATES: 19(4,3,4,3,5) 4 MHZ E.T.: 4.75

Condition Bits Affected: None

Example:

If the HL register pair contains 7012H, the SP register pair contains 8856H, the memory location 8856H contains the byte 11H, and the memory location 8857H contains the byte 22H, then the instruction

EX (SP),HL

will result in the HL register pair containing number 2211H, memory location 8856H containing the byte 12H, the memory location 8857H containing the byte 70H and the Stack Pointer containing 8856H.

EX (SP), IX

Operation: $IX_H \leftrightarrow (SP+1), IX_L \leftrightarrow (SP)$

Format:

<u>Opcode</u>	<u>Operands</u>
EX	(SP), IX

1 1 0 1 1 1 0 1	DD
-----------------	----

1 1 1 0 0 0 1 1	E3
-----------------	----

Description:

The low order byte in Index Register IX is exchanged with the contents of the memory address specified by the contents of register pair SP (Stack Pointer), and the high order byte of IX is exchanged with the next highest memory address (SP+1).

M CYCLES: 6 T STATES: 23(4,4,3,4,3,5) 4 MHZ E.T.: 5.75

Condition Bits Affected: None

Example:

If the Index Register IX contains 3988H, the SP register pair contains 0100H, the memory location 0100H contains the byte 90H, and memory location 0101H contains byte 48H, then the instruction

EX (SP), IX

will result in the IX register pair containing number 4890H, memory location 0100H containing 88H, memory location 0101H containing 39H and the Stack Pointer containing 0100H.

EX (SP), IY

Operation: IY_H ↔ (SP+1), IY_L ↔ (SP)

Format:

<u>Opcode</u>	<u>Operands</u>
EX	(SP),IY

1 1 1 1 1 1 0 1	FD
-----------------	----

1 1 1 0 0 0 1 1	E3
-----------------	----

Description:

The low order byte in Index Register IY is exchanged with the contents of the memory address specified by the contents of register pair SP (Stack Pointer), and the high order byte of IY is exchanged with the next highest memory address (SP+1).

M CYCLES: 6 T STATES: 23(4,4,3,4,3,5) 4 MHZ E.T.: 5.75

Condition Bits Affected: None

Example:

If the Index Register IY contains 3988H, the SP register pair contains 0100H, the memory location 0100H contains the byte 90H, and memory location 0101H contains byte 48H, then the instruction

EX (SP),IY

will result in the IY register pair containing number 4890H, memory location 0100H containing 88H, memory location 0101H containing 39H, and the Stack Pointer containing 0100H.

LDI

Operation: (DE) ← (HL), DE ← DE+1, HL ← HL+1, BC ← BC-1

Format:

<u>Opcode</u>	<u>Operands</u>								
LDI									
<table border="1"><tr><td>1</td><td>1</td><td>1</td><td>0</td><td>1</td><td>1</td><td>0</td><td>1</td></tr></table>	1	1	1	0	1	1	0	1	ED
1	1	1	0	1	1	0	1		
<table border="1"><tr><td>1</td><td>0</td><td>1</td><td>0</td><td>0</td><td>0</td><td>0</td><td>0</td></tr></table>	1	0	1	0	0	0	0	0	A0
1	0	1	0	0	0	0	0		

Description:

A byte of data is transferred from the memory location addressed by the contents of the HL register pair to the memory location addressed by the contents of the DE register pair. Then both these register pairs are incremented and the BC (Byte Counter) register pair is decremented.

M CYCLES: 4 T STATES: 16(4,4,3,5) 4 MHZ E.T.: 4.00

Condition Bits Affected:

S: Not affected
Z: Not affected
H: Reset
P/V: Set if BC-1≠0;
 reset otherwise
N: Reset
C: Not affected

Example:

If the HL register pair contains 1111H, memory location 1111H contains the byte 88H, the DE register pair contains 2222H, the memory location 2222H contains byte 66H, and the BC register pair contains 7H, then the instruction

LDI

will result in the following contents in register pairs and memory addresses:

HL	:	1112H
(1111H)	:	88H
DE	:	2223H
(2222H)	:	88H
BC	:	6H

LDIR

LDIR

Operation: (DE) ← (HL), DE ← DE+1, HL ← HL+1, BC ← BC-1

Format:

Opcode Operands

LDIR

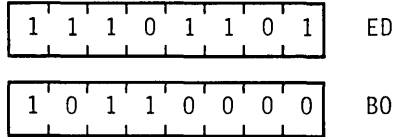

Description:

This two byte instruction transfers a byte of data from the memory location addressed by the contents of the HL register pair to the memory location addressed by the DE register pair. Then both these register pairs are incremented and the BC (Byte Counter) register pair is decremented. If decrementing causes the BC to go to zero, the instruction is terminated. If BC is not zero the program counter is decremented by 2 and the instruction is repeated. Interrupts will be recognized and two refresh cycles will be executed after each data transfer. Note that if BC is set to zero prior to instruction execution, the instruction will loop through 64K bytes.

For BC≠0:

M CYCLES: 5 T STATES: 21(4,4,3,5,5) 4 MHZ E.T.: 5.25

For BC=0:

M CYCLES: 4 T STATES: 16(4,4,3,5) 4 MHZ E.T.: 4.00

Condition Bits Affected:

S: Not affected
Z: Not affected
H: Reset
P/V: Reset
N: Reset
C: Not affected

Example:

If the HL register pair contains 1111H, the DE register pair contains 2222H, the BC register pair contains 0003H, and memory locations have these contents:

(1111H) : 88H	(2222H) : 66H
(1112H) : 36H	(2223H) : 59H
(1113H) : A5H	(2224H) : C5H

then after the execution of

LDIR

the contents of register pairs and memory locations will be:

HL : 1114H
DE : 2225H
BC : 0000H

(1111H) : 88H	(2222H) : 88H
(1112H) : 36H	(2223H) : 36H
(1113H) : A5H	(2224H) : A5H

LDD

Operation: (DE) ← (HL), DE ← DE-1, HL ← HL-1, BC ← BC-1

Format:

<u>Opcode</u>	<u>Operands</u>								
LDD									
<table border="1"><tr><td>1</td><td>1</td><td>1</td><td>0</td><td>1</td><td>1</td><td>0</td><td>1</td></tr></table>	1	1	1	0	1	1	0	1	ED
1	1	1	0	1	1	0	1		
<table border="1"><tr><td>1</td><td>0</td><td>1</td><td>0</td><td>1</td><td>0</td><td>0</td><td>0</td></tr></table>	1	0	1	0	1	0	0	0	A8
1	0	1	0	1	0	0	0		

Description:

This two byte instruction transfers a byte of data from the memory location addressed by the contents of the HL register pair to the memory location addressed by the contents of the DE register pair. Then both of these register pairs including the BC (Byte Counter) register pair are decremented.

M CYCLES: 4 T STATES: 16(4,4,3,5) 4 MHZ E.T.: 4.00

Condition Bits Affected:

S: Not affected
Z: Not affected
H: Reset
P/V: Set if BC-1≠0;
 reset otherwise
N: Reset
C: Not affected

Example:

If the HL register pair contains 1111H, memory location 1111H contains the byte 88H, the DE register pair contains 2222H, memory location 2222H contains byte 66H, and the BC register pair contains 7H, then the instruction

LDD

will result in the following contents in register pairs and memory addresses:

HL	:	1110H
(1111H)	:	88H
DE	:	2221H
(2222H)	:	88H
BC	:	6H

LDDR

Operation: (DE) ← (HL), DE ← DE-1, HL ← HL-1, BC ← BC-1

Format:

<u>Opcode</u>	<u>Operands</u>
LDDR	

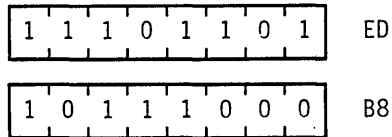

Description:

This two byte instruction transfers a byte of data from the memory location addressed by the contents of the HL register pair to the memory location addressed by the contents of the DE register pair. Then both of these registers as well as the BC (Byte Counter) are decremented. If decrementing causes the BC to go to zero, the instruction is terminated. If BC is not zero, the program counter is decremented by 2 and the instruction is repeated. Interrupts will be recognized and two refresh cycles will be executed after each data transfer. Note that if BC is set to zero prior to instruction execution, the instruction will loop through 64K bytes.

For BC=0:

M CYCLES: 5 T STATES: 21(4,4,3,5,5) 4 MHZ E.T.: 5.25

For BC≠0:

M CYCLES: 4 T STATES: 16(4,4,3,5) 4 MHZ E.T.: 4.00

Condition Bits Affected:

S:	Not affected
Z:	Not affected
H:	Reset
P/V:	Reset
N:	Reset

Example:

If the HL register pair contains 1114H, the DE register pair contains 2225H, the BC register pair contains 0003H, and memory locations have these contents:

(1114H) : A5H	(2225H) : C5H
(1113H) : 36H	(2224H) : 59H
(1112H) : 88H	(2223H) : 66H

then after the execution of

LDDR

the contents of register pairs and memory locations will be:

HL : 1111H
DE : 2222H
BC : 0000H

(1114H) : A5H	(2225H) : A5H
(1113H) : 36H	(2224H) : 36H
(1112H) : 88H	(2223H) : 88H

CPI

Operation: A - (HL), HL ← HL+1, BC ← BC-1

Format:

Opcode Operands

CPI

1	1	1	0	1	1	0	1	ED
---	---	---	---	---	---	---	---	----

1	0	1	0	0	0	0	1	A1
---	---	---	---	---	---	---	---	----

Description:

The contents of the memory location addressed by the HL register pair is compared with the contents of the Accumulator. In case of a true compare, a condition bit is set. Then HL is incremented and the Byte Counter (register pair BC) is decremented.

M CYCLES: 4 T STATES: 16(4,4,3,5) 4 MHZ E.T.: 4.00

Condition Bits Affected:

S: Set if result is negative;
 reset otherwise
Z: Set if A=(HL);
 reset otherwise
H: Set if borrow from
 Bit 4; reset otherwise
P/V: Set if BC-1=0;
 reset otherwise
N: Set
C: Not affected

Example:

If the HL register pair contains 1111H, memory location 1111H contains 3BH, the Accumulator contains 3BH, and the Byte Counter contains 0001H, then after the execution of

CPI

the Byte Counter will contain 0000H, the HL register pair will contain 1112H, the Z flag in the F register will be set, and the P/V flag in the F register will be reset. There will be no effect on the contents of the Accumulator or address 1111H.

CPIR

Operation: A - (HL), HL ← HL+1, BC ← BC-1

Format:

Opcode Operands

CPIR

1	1	1	0	1	1	0	1
---	---	---	---	---	---	---	---

 ED

1	0	1	1	0	0	0	1
---	---	---	---	---	---	---	---

 B1

Description:

The contents of the memory location addressed by the HL register pair is compared with the contents of the Accumulator. In case of a true compare, a condition bit is set. The HL is incremented and the Byte Counter (register pair BC) is decremented. If decrementing causes the BC to go to zero or if A=(HL), the instruction is terminated. If BC is not zero and A=(HL), the program counter is decremented by 2 and the instruction is repeated. Interrupts will be recognized and two refresh cycles will be executed after each data transfer. Note that if BC is set to zero before instruction execution, the instruction will loop through 64K bytes, if no match is found.

For $BC \neq 0$ and $A \neq (HL)$:

M CYCLES: 5 T STATES: 21(4,4,3,5,5) 4 MHZ E.T.: 5.25

For $BC=0$ or $A=(HL)$:

M CYCLES: 4 T STATES: 16(4,4,3,5) 4 MHZ E.T.: 4.00

Condition Bits Affected:

S: Set if result is negative;
reset otherwise
Z: Set if A=(HL);
reset otherwise
H: Set if borrow from
Bit 4; reset otherwise
P/V: Set if BC-1=0;
reset otherwise
N: Set
C: Not affected

Example:

If the HL register pair contains 1111H, the Accumulator contains F3H, the Byte Counter contains 0007H, and memory locations have these contents:

(1111H) : 52H
(1112H) : 00H
(1113H) : F3H

then after the execution of

CPIR

the contents of register pair HL will be 1114H, the contents of the Byte Counter will be 0004H, the P/V flag in the F register will be set and the Z flag in the F register will be set.

CPD

Operation: A-(HL), HL ← HL-1, BC ← BC-1

Format:

Opcode

Operands

CPD

1	1	1	0	1	1	0	1	ED
---	---	---	---	---	---	---	---	----

1	0	1	0	1	0	0	1	A9
---	---	---	---	---	---	---	---	----

Description:

The contents of the memory location addressed by the HL register pair is compared with the contents of the Accumulator. In case of a true compare, a condition bit is set. The HL and the Byte Counter (register pair BC) are decremented.

M CYCLES: 4 T STATES: 16(4,4,3,5) 4 MHZ E.T.: 4.00

Condition Bits Affected:

S: Set if result is negative;
reset otherwise
Z: Set if A=(HL);
reset otherwise
H: Set if borrow from
Bit 4; reset otherwise
P/V: Set if BC-1=0;
reset otherwise
N: Set
C: Not Affected

Example:

If the HL register pair contains 1111H, memory location 1111H contains 3BH, the Accumulator contains 3BH, and the Byte Counter contains 0001H, then after the execution of

CPD

the Byte Counter will contain 0000H, the HL register pair will contain 1110H, the Z flag in the F register will be set, and the P/V flag in the F register will be reset. There will be no effect on the contents of the Accumulator or address 1111H.

CPDR

Operation: A - (HL), HL ← HL-1, BC ← BC-1

Format:

Opcode

Operands

CPDR

1	1	1	0	1	1	0	1
---	---	---	---	---	---	---	---

 ED

1	0	1	1	1	0	0	1
---	---	---	---	---	---	---	---

 B9

Description:

The contents of the memory location addressed by the HL register pair is compared with the contents of the Accumulator. In case of a true compare, a condition bit is set. The HL and BC (Byte Counter) register pairs are decremented. If decrementing causes the BC to go to zero or if A=(HL), the instruction is terminated. If BC is not zero and A=(HL), the program counter is decremented by 2 and the instruction is repeated. Interrupts will be recognized and two refresh cycles will be executed after each data transfer. Note that if BC is set to zero prior to instruction execution, the instruction will loop through 64K bytes, if no match is found.

For BC≠0 and A≠(HL):

M CYCLES: 5 T STATES: 21(4,4,3,5,5) 4 MHZ E.T.: 5.25

For BC=0 or A=(HL):

M CYCLES: 4 T STATES: 16(4,4,3,5) 4 MHZ E.T.: 4.00

Condition Bits Affected:

S: Set if result is negative;
reset otherwise
Z: Set if A=(HL);
reset otherwise
H: Set if borrow from
Bit 4; reset otherwise
P/V: Set if BC-1=0;
reset otherwise
N: Set
C: Not affected

Example:

If the HL register pair contains 1118H, the Accumulator contains F3H, the Byte Counter contains 0007H, and memory locations have these contents:

(1118H) : 52H
(1117H) : 00H
(1116H) : F3H

then after the execution of

CPDR

the contents of register pair HL will be 1115H, the contents of the Byte Counter will be 0004H, the P/V flag in the F register will be set, and the Z flag in the F register will be set.

-8 BIT ARITHMETIC AND LOGICAL GROUP-

ADD A, r

Operation: $A \leftarrow A + r$

Format:

<u>Opcode</u>	<u>Operands</u>
ADD	A,r

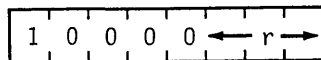

Description:

The contents of register r are added to the contents of the Accumulator, and the result is stored in the Accumulator. The symbol r identifies the registers A,B,C,D,E,H or L assembled as follows in the object code:

<u>Register</u>	<u>r</u>
A	111
B	000
C	001
D	010
E	011
H	100
L	101

M CYCLES: 1 T STATES: 4 4 MHZ E.T.: 1.00

Condition Bits Affected:

S: Set if result is negative;
reset otherwise

Z: Set if result is zero;
reset otherwise

H: Set if carry from
Bit 3; reset otherwise

P/V: Set if overflow;
reset otherwise

N: Reset

C: Set if carry from
Bit 7; reset otherwise

Example:

If the contents of the Accumulator are 44H, and the contents of register C are 11H, after the execution of

ADD A,C

the contents of the Accumulator will be 55H.

ADD A, n

Operation: $A \leftarrow A + n$

Format:

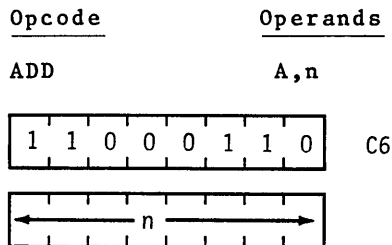

Description:

The integer n is added to the contents of the Accumulator and the results are stored in the Accumulator.

M CYCLES: 2 T STATES: 7(4,3) 4 MHZ E.T.: 1.75

Condition Bits Affected:

S: Set if result is negative;
 reset otherwise
Z: Set if result is zero;
 reset otherwise
H: Set if carry from
 Bit 3; reset otherwise
P/V: Set if overflow;
 reset otherwise
N: Reset
C: Set if carry from
 Bit 7; reset otherwise

Example:

If the contents of the Accumulator are 23H, after the execution of

ADD A,33H

the contents of the Accumulator will be 56H.

ADD A, (HL)

Operation: $A \leftarrow A + (HL)$

Format:

<u>Opcode</u>	<u>Operands</u>
ADD	A, (HL)

1 0 0 0 0 1 1 0	86
-----------------	----

Description:

The byte at the memory address specified by the contents of the HL register pair is added to the contents of the Accumulator and the result is stored in the Accumulator.

M CYCLES: 2 T STATES: 7(4,3) 4 MHZ E.T.: 1.75

Condition Bits Affected:

S:	Set if result is negative; reset otherwise
Z:	Set if result is zero; reset otherwise
H:	Set if carry from Bit 3; reset otherwise
P/V:	Set if overflow; reset otherwise
N:	Reset
C:	Set if carry from Bit 7; reset otherwise

Example:

If the contents of the Accumulator are A0H, and the content of the register pair HL is 2323H, and memory location 2323H contains byte 08H, after the execution of

ADD A, (HL)

the Accumulator will contain A8H.

ADD A, (IX+d)

Operation: $A \leftarrow A + (IX+d)$

Format:

<u>Opcode</u>	<u>Operands</u>
ADD	A, (IX+d)

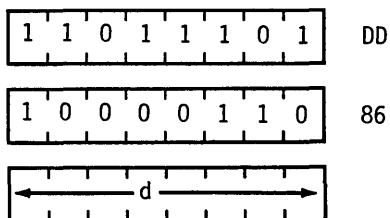

Description:

The contents of the Index Register (register pair IX) is added to a two's complement displacement d to point to an address in memory. The contents of this address is then added to the contents of the Accumulator and the result is stored in the Accumulator.

M CYCLES: 5 T STATES: 19(4,4,3,5,3) 4 MHZ E.T.: 4.75

Condition Bits Affected:

S: Set if result is negative;
 reset otherwise
Z: Set if result is zero;
 reset otherwise
H: Set if carry from
 Bit 3; reset otherwise
P/V: Set if overflow;
 reset otherwise
N: Reset
C: Set if carry from
 Bit 7; reset otherwise

Example:

If the Accumulator contents are 11H, the Index Register IX contains 1000H, and if the content of memory location

1005H is 22H, after the execution of

ADD A,(IX+5H)

the contents of the Accumulator will be 33H.

ADD A, (IY+d)

Operation: $A \leftarrow A + (IY + d)$

Format:

<u>Opcode</u>	<u>Operands</u>
ADD	A, (IY+d)

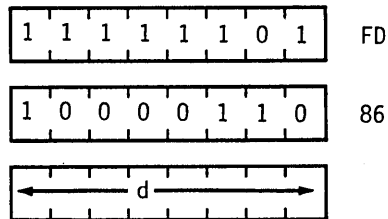

Description:

The contents of the Index Register (register pair IY) is added to a two's complement displacement d to point to an address in memory. The contents of this address is then added to the contents of the Accumulator and the result is stored in the Accumulator.

M CYCLES: 5 T STATES: 19(4,4,3,5,3) 4 MHZ E.T.: 4.75

Condition Bits Affected:

S: Set if result is negative;
reset otherwise

Z: Set if result is zero;
reset otherwise

H: Set if carry from
Bit 3; reset otherwise

P/V: Set if overflow;
reset otherwise

N: Reset

C: Set if carry from bit 7;
reset otherwise

Example:

If the Accumulator contents are 11H, the Index Register pair IY contains 1000H, and if the content of memory

location 1005H is 22H, after the execution of

ADD A, (1Y+5H)

the contents of the Accumulator will be 33H.

ADC A, S

Operation: $A \leftarrow A + s + CY$

Format:

<u>Opcode</u>	<u>Operands</u>
ADC	A, s

The s operand is any of r, n, (HL), (IX+d) or (IY+d) as defined for the analogous ADD instruction. These various possible opcode-operand combinations are assembled as follows in the object code:

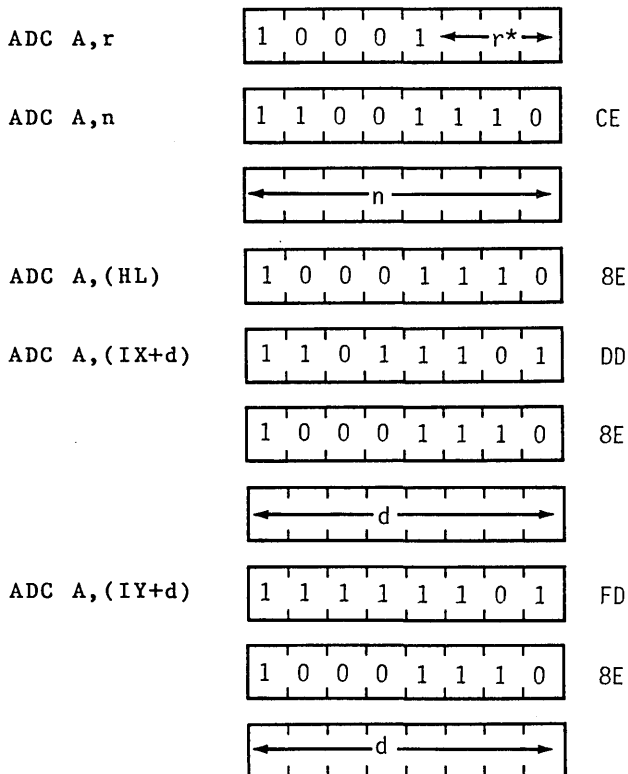

*r identifies registers B, C, D, E, H, L or A assembled as follows in the object code field above:

<u>Register</u>	<u>r</u>
B	000
C	001
D	010
E	011
H	100
L	101
A	111

Description:

The s operand, along with the Carry Flag ("C" in the F register) is added to the contents of the Accumulator, and the result is stored in the Accumulator.

<u>INSTRUCTION</u>	<u>M CYCLES</u>	<u>T STATES</u>	<u>4 MHZ E.T.</u>
ADC A,r	1	4	1.00
ADC A,n	2	7(4,3)	1.75
ADC A,(HL)	2	7(4,3)	1.75
ADC A,(IX+d)	5	19(4,4,3,5,3)	4.75
ADC A,(IY+d)	5	19(4,4,3,5,3)	4.75

Condition Bits Affected:

S: Set if result is negative;
reset otherwise

Z: Set if result is zero;
reset otherwise

H: Set if carry from
Bit 3; reset otherwise

P/V: Set if overflow;
reset otherwise

N: Reset

C: Set if carry from
Bit 7; reset otherwise

Example:

If the Accumulator contains 16H, the Carry Flag is set, the HL register pair contains 6666H, and address 6666H contains 10H, after the execution of

ADC A,(HL)

the Accumulator will contain 27H.

SUB s

Operation: $A \leftarrow A - s$

Format:

<u>Opcode</u>	<u>Operands</u>
SUB	s

The s operand is any of r,n,(HL),(IX+d) or (IY+d) as defined for the analogous ADD instruction. These various possible opcode-operand combinations are assembled as follows in the object code:

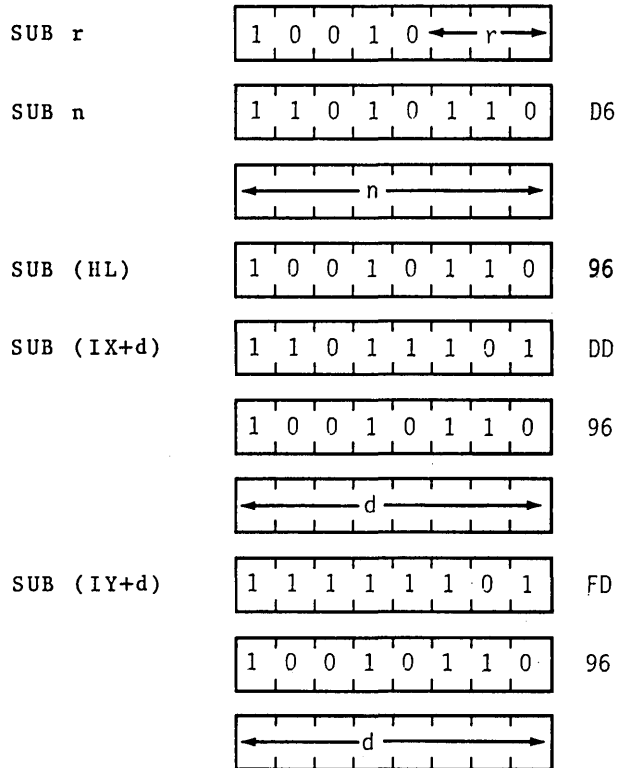

*r identifies registers B,C,D,E,H,L or A assembled as follows in the object code field above:

<u>Register</u>	<u>r</u>
B	000
C	001
D	010
E	011
H	100
L	101
A	111

Description:

The s operand is subtracted from the contents of the Accumulator, and the result is stored in the Accumulator.

<u>INSTRUCTION</u>	<u>M CYCLES</u>	<u>T STATES</u>	<u>4 MHZ E.T.</u>
SUB r	1	4	1.00
SUB n	2	7(4,3)	1.75
SUB (HL)	2	7(4,3)	1.75
SUB (IX+d)	5	19(4,4,3,5,3)	4.75
SUB (IY+d)	5	19(4,4,3,5,3)	4.75

Condition Bits Affected:

S: Set if result is negative;
reset otherwise

Z: Set if result is zero;
reset otherwise

H: Set if borrow from
Bit 4; reset otherwise

P/V: Set if overflow;
reset otherwise

N: Set

C: Set if borrow;
reset otherwise

Example:

If the Accumulator contains 29H and register D contains 11H, after the execution of

SUB D

the Accumulator will contain 18H.

SBC A, s

Operation: $A \leftarrow A - s - CY$

Format:

<u>Opcode</u>	<u>Operands</u>
SBC	A, s

The s operand is any of r, n, (HL), (IX+d) or (IY+d) as defined for the analogous ADD instructions. These various possible opcode-operand combinations are assembled as follows in the object code:

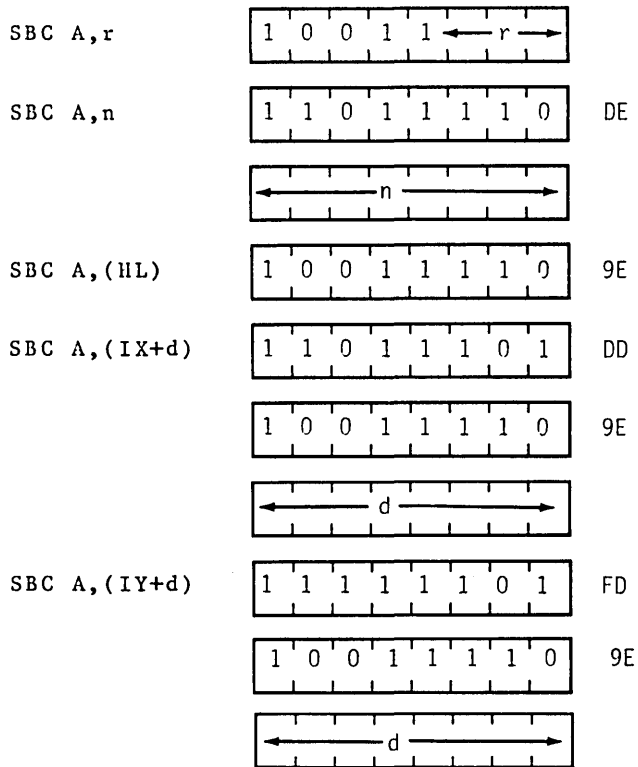

*r identifies registers B, C, D, E, H, L or A assembled as follows in the object code field above:

<u>Register</u>	<u>r</u>
B	000
C	001
D	010
E	011
H	100
L	101
A	111

Description:

The s operand, along with the Carry Flag ("C" in the F register) is subtracted from the contents of the Accumulator, and the result is stored in the Accumulator.

<u>INSTRUCTION</u>	<u>M CYCLES</u>	<u>T STATES</u>	<u>4 MHZ E.T.</u>
SBC A,r	1	4	1.00
SBC A,n	2	7(4,3)	1.75
SBC A,(HL)	2	7(4,3)	1.75
SBC A,(IX+d)	5	19(4,4,3,5,3)	4.75
SBC A,(IY+d)	5	19(4,4,3,5,3)	4.75

Condition Bits Affected:

S: Set if result is negative;
reset otherwise

Z: Set if result is zero;
reset otherwise

H: Set if borrow from
Bit 4; reset otherwise

P/V: Set if overflow;
reset otherwise

N: Set

C: Set if borrow;
reset otherwise

Example:

If the Accumulator contains 16H, the carry flag is set, the HL register pair contains 3433H, and address 3433H contains 05H, after the execution of

SBC A,(HL)

the Accumulator will contain 10H.

AND S

Operation: $A \leftarrow A \wedge s$

Format:

<u>Opcode</u>	<u>Operands</u>
AND	s

The s operand is any of r,n,(HL),(IX+d) or (IY+d), as defined for the analogous ADD instructions. These various possible opcode-operand combinations are assembled as follows in the object code:

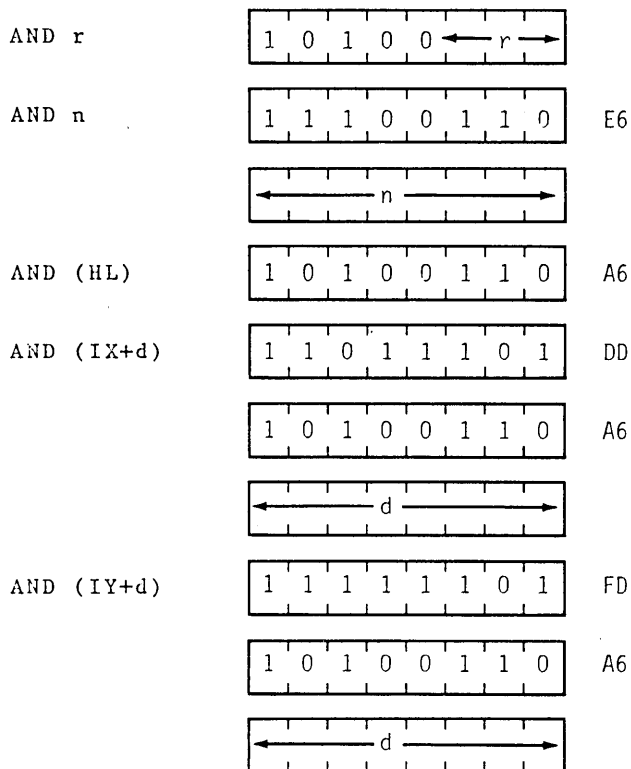

*r identifies registers B,C,D,E,H,L or A assembled as follows in the object code field above:

<u>Register</u>	<u>r</u>
B	000
C	001
D	010
E	011
H	100
L	101
A	111

Description:

A logical AND operation is performed between the byte specified by the s operand and the byte contained in the Accumulator; the result is stored in the Accumulator.

<u>INSTRUCTION</u>	<u>M CYCLES</u>	<u>T STATES</u>	<u>4 MHZ E.T.</u>
AND r	1	4	1.00
AND n	2	7(4,3)	1.75
AND (HL)	2	7(4,3)	1.75
AND (IX+d)	5	19(4,4,3,5,3)	4.75
AND (IX+d)	5	19(4,4,3,5,3)	4.75

Condition Bits Affected:

S: Set if result is negative;
reset otherwise

Z: Set if result is zero;
reset otherwise

H: Set

P/V: Set if parity even;
reset otherwise

N: Reset

C: Reset

Example:

If the B register contains 7BH (0111 1011) and the Accumulator contains C3H (1100 0011) after the execution of

AND B

the Accumulator will contain 43H (01000011).

OR s

Operation: $A \leftarrow A \vee s$

Format:

<u>Opcode</u>	<u>Operands</u>
OR	s

The s operand is any of r,n,(HL),(IX+d) or (IY+d), as defined for the analogous ADD instructions. These various possible opcode-operand combinations are assembled as follows in the object code:

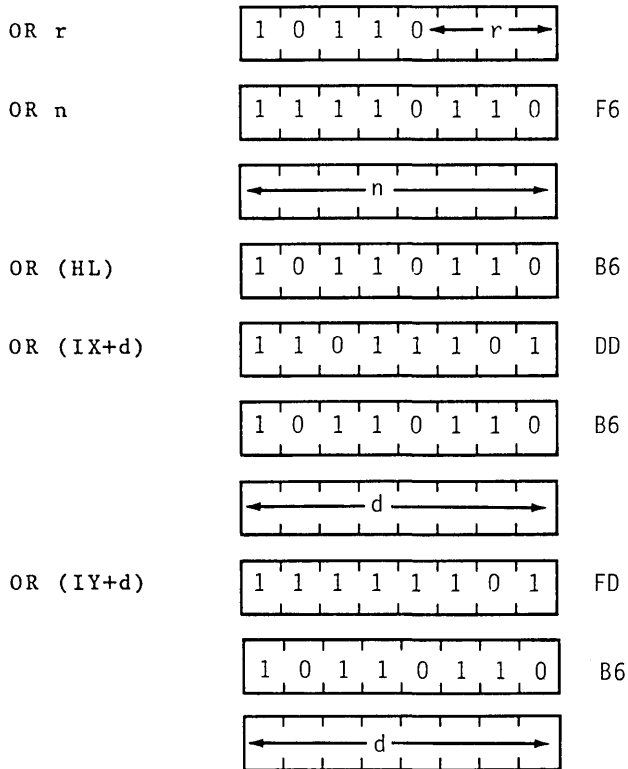

*r identifies registers B,C,D,E,H,L or A assembled as follows in the object code field above:

<u>Register</u>	<u>r</u>
B	000
C	001
D	010
E	011
H	100
L	101
A	111

Description:

A logical OR operation is performed between the byte specified by the s operand and the byte contained in the Accumulator; the result is stored in the Accumulator.

<u>INSTRUCTION</u>	<u>M CYCLES</u>	<u>T STATES</u>	<u>4 MHZ E.T.</u>
OR r	1	4	1.00
OR n	2	7(4,3)	1.75
OR (HL)	2	7(4,3)	1.75
OR (IX+d)	5	19(4,4,3,5,3)	4.75
OR (IY+d)	5	19(4,4,3,5,3)	4.75

Condition Bits Affected:

S: Set if result is negative;
reset otherwise
Z: Set if result is zero;
reset otherwise
H: Reset
P/V: Set if parity even;
reset otherwise
N: Reset
C: Reset

Example:

If the H register contains 48H (010001000) and the Accumulator contains 12H (00010010) after the execution of

OR H

the Accumulator will contain 5AH (01011010).

XOR S

Operation: $A \leftarrow A \oplus s$

Format:

<u>Opcode</u>	<u>Operands</u>
XOR	s

The s operand is any of r,n, (HL),(IX+d) or (IY+d), as defined for the analogous ADD instructions. These various possible opcode-operand combinations are assembled as follows in the object code:

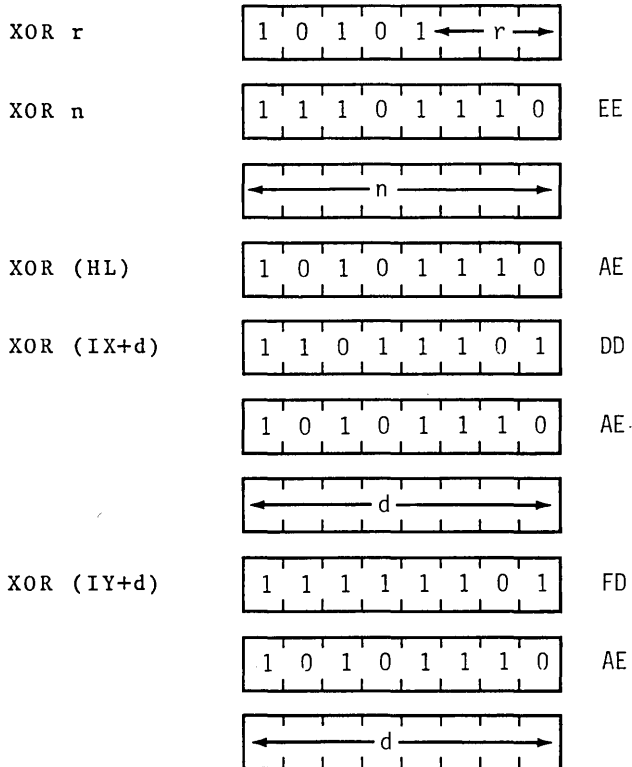

*r identifies registers B,C,D,E,H,L or A assembled as follows in the object code field above:

<u>Register</u>	<u>r</u>
B	000
C	001
D	010
E	011
H	100
L	101
A	111

Description:

A logical exclusive-OR operation is performed between the byte specified by the s operand and the byte contained in the Accumulator; the result is stored in the Accumulator.

<u>INSTRUCTION</u>	<u>M CYCLES</u>	<u>T STATES</u>	<u>4 MHZ E.T.</u>
XOR r	1	4	1.00
XOR n	2	7(4,3)	1.75
XOR (HL)	2	7(4,3)	1.75
XOR (IX+d)	5	19(4,4,3,5,3)	4.75
XOR (IY+d)	5	19(4,4,3,5,3)	4.75

Condition Bits Affected:

S: Set if result is negative;
reset otherwise

Z: Set if result is zero;
reset otherwise

H: Reset

P/V: Set if parity even;
reset otherwise

N: Reset

C: Reset

Example:

If the Accumulator contains 96H (10010110), after the execution of

XOR 5DH (Note: 5DH = 01011101)

the Accumulator will contain CBH (11001011).

CP s

Operation: A-s

Format:

<u>Opcode</u>	<u>Operands</u>
CP	s

The s operand is any of r,n,(HL),(IX+d) or (IY+d), as defined for the analogous ADD instructions. These various possible opcode-operand combinations are assembled as follows in the object code:

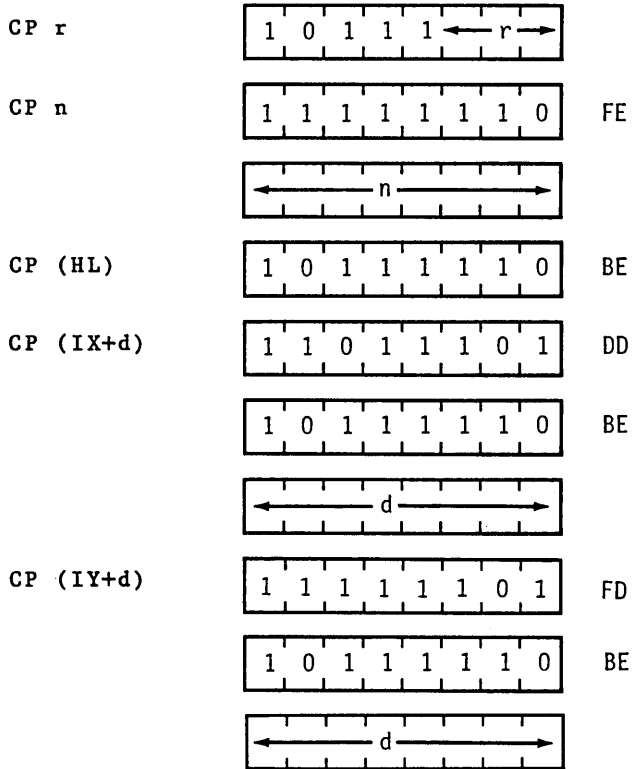

*r identifies registers B,C,D,E,H,L or A assembled as follows in the object code field above:

<u>Register</u>	<u>r</u>
B	000
C	001
D	010
E	011
H	100
L	101
A	111

Description:

The contents of the s operand are compared with the contents of the Accumulator. If there is a true compare, the Z flag is set. The execution of this instruction does not affect the contents of the Accumulator.

<u>INSTRUCTION</u>	<u>M CYCLES</u>	<u>T STATES</u>	<u>4 MHZ E.T.</u>
CP r	1	4	1.00
CP n	2	7(4,3)	1.75
CP (HL)	2	7(4,3)	1.75
CP (IX+d)	5	19(4,4,3,5,3)	4.75
CP (IY+d)	5	19(4,4,3,5,3)	4.75

Condition Bits Affected:

S: Set if result is negative;
reset otherwise

Z: Set if result is zero;
reset otherwise

H: Set if borrow from
Bit 4; reset otherwise

P/V: Set if overflow;
reset otherwise

N: Set

C: Set if borrow;
reset otherwise

Example:

If the Accumulator contains 63H, the HL register pair contains 6000H and memory location 6000H contains 60H, the instruction

CP (HL)

will result in the P/V flag in the F register being reset.

INC r

Operation: $r \leftarrow r + 1$

Format:

<u>Opcode</u>	<u>Operands</u>
INC	r

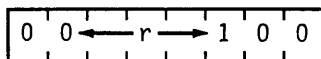

Description:

Register r is incremented. r identifies any of the registers A,B, C,D,E,H or L, assembled as follows in the object code.

<u>Register</u>	<u>r</u>
A	111
B	000
C	001
D	010
E	011
H	100
L	101

M CYCLES: 1 T STATES: 4 4 MHZ E.T.: 1.00

Condition Bits Affected:

S: Set if result is negative;
reset otherwise
Z: Set if result is zero;
reset otherwise
H: Set if carry from
Bit 3; reset otherwise
P/V: Set if r was 7FH before
operation; reset otherwise
N: Reset
C: Not affected

Example:

If the contents of register D are 28H, after the execution of

INC D

the contents of register D will be 29H.

INC (HL)

Operation: (HL) ← (HL)+1

Format:

<u>Opcode</u>	<u>Operands</u>
INC	(HL)

0	0	1	1	0	1	0	0	34
---	---	---	---	---	---	---	---	----

Description:

The byte contained in the address specified by the contents of the HL register pair is incremented.

M CYCLES: 3 T STATES: 11(4,4,3) 4 MHZ E.T.: 2.75

Condition Bits Affected:

S:	Set if result is negative; reset otherwise
Z:	Set if result is zero; reset otherwise
H:	Set if carry from Bit 3; reset otherwise
P/V:	Set if (HL) was 7FH before operation; reset otherwise
N:	Reset
C:	Not Affected

Example:

If the contents of the HL register pair are 3434H, and the contents of address 3434H are 82H, after the execution of

INC (HL)

memory location 3434H will contain 83H.

INC (IX+d)

Operation: $(IX+d) \leftarrow (IX+d)+1$

Format:

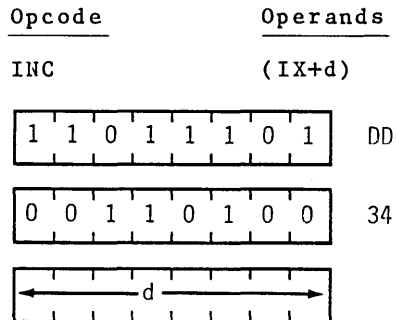

Description:

The contents of the Index Register IX (register pair IX) are added to a two's complement displacement integer d to point to an address in memory. The contents of this address are then incremented.

M CYCLES: 6 T STATES: 23(4,4,3,5,4,3) 4 MHZ E.T.: 5.75

Condition Bits Affected:

S: Set if result is negative;
reset otherwise
Z: Set if result is zero;
reset otherwise
H: Set if carry from
Bit 3; reset otherwise
P/V: Set if (IX+d) was 7FH before
operation; reset otherwise
N: Reset
C: Not affected

Example:

If the contents of the Index Register pair IX are 2020H, and the memory location 2030H contains byte 34H, after the execution of

INC (IX+10H)

the contents of memory location 2030H will be 35H.

INC (IY+d)

Operation: (IY+d) ← (IY+d)+1

Format:

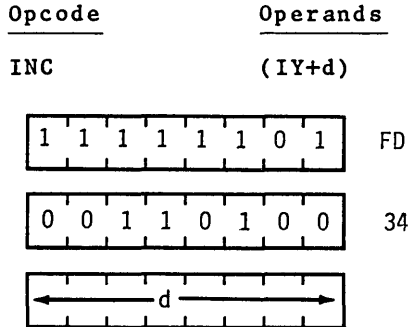

Description:

The contents of the Index Register IY (register pair IY) are added to a two's complement displacement integer d to point to an address in memory. The contents of this address are then incremented.

M CYCLES: 6 T STATES: 23(4,4,3,5,4,3) 4 MHZ E.T.: 5.75

Condition Bits Affected:

S: Set if result is negative;
reset otherwise
Z: Set if result is zero;
reset otherwise
H: Set if carry from
Bit 3; reset otherwise
P/V: Set if (IY+d) was 7FH before
operation; reset otherwise
N: Reset
C: Not Affected

Example:

If the contents of the Index Register pair IY are 2020H, and the memory location 2030H contain byte 34H, after the execution of

INC (IY+10H)

the contents of memory location 2030H will be 35H.

Operation: $m \leftarrow m-1$

Format:

<u>Opcode</u>	<u>Operands</u>
DEC	m

The m operand is any of r, (HL), (IX+d) or (IY+d), as defined for the analogous INC instructions. These various possible opcode-operand combinations are assembled as follows in the object code:

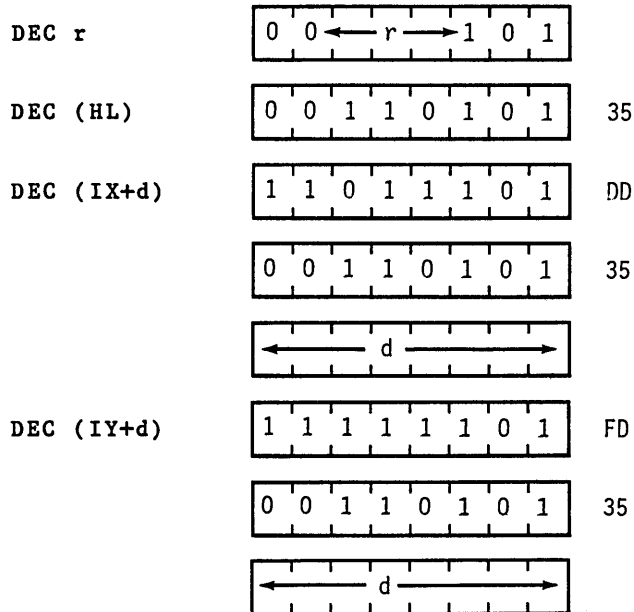

*r identifies registers B,C,D,E,H,L or A assembled as follows in the object code field above:

<u>Register</u>	<u>r</u>
B	000
C	001
D	010
E	011
H	100
L	101
A	111

Description:

The byte specified by the m operand is decremented.

<u>INSTRUCTION</u>	<u>M CYCLES</u>	<u>T STATES</u>	<u>4 MHZ E.T.</u>
DEC r	1	4	1.00
DEC (HL)	3	11(4,4,3)	2.75
DEC (IX+d)	6	23(4,4,3,5,4,3)	5.75
DEC (IY+d)	6	23(4,4,3,5,4,3)	5.75

Condition Bits Affected:

S: Set if result is negative;
reset otherwise

Z: Set if result is zero;
reset otherwise

H: Set if borrow from
Bit 4, reset otherwise

P/V: Set if m was 80H before
operation; reset otherwise

N: Set

C: Not affected

Example:

If the D register contains byte 2AH, after the execution of

DEC D

register D will contain 29H.

-GENERAL PURPOSE ARITHMETIC AND CPU CONTROL GROUPS-

DAA

Operation: —

Format:

Opcode

DAA

0	0	1	0	0	1	1	1
---	---	---	---	---	---	---	---

27

Description:

This instruction conditionally adjusts the Accumulator for BCD addition and subtraction operations. For addition (ADD, ADC, INC) or subtraction (SUB, SBC, DEC, NEG), the following table indicates the operation performed:

OPERATION	C BEFORE DAA	HEX VALUE IN UPPER DIGIT (bit 7-4)	H BEFORE DAA	HEX VALUE IN LOWER DIGIT (bit 3-0)	NUMBER ADDED TO BYTE	C AFTER DAA
ADD } ADC } INC }	0	0-9	0	0-9	00	0
	0	0-8	0	A-F	06	0
	0	0-9	1	0-3	06	0
	0	A-F	0	0-9	60	1
	0	9-F	0	A-F	66	1
	0	A-F	1	0-3	66	1
	1	0-2	0	0-9	60	1
	1	0-2	0	A-F	66	1
	1	0-3	1	0-3	66	1
SUB } SBC } DEC } NEG }	0	0-9	0	0-9	00	0
	0	0-8	1	6-F	FA	0
	1	7-F	0	0-9	A0	1
	1	6-F	1	6-F	9A	1

M CYCLES: 1 T STATES: 4 4 MHZ E.T.: 1.00

Condition Bits Affected:

S: Set if most significant bit
of Acc. is 1 after operation;
reset otherwise
Z: Set if Acc. is zero after operation;
reset otherwise
H: See instruction
P/V: Set if Acc. is even parity after
operation; reset otherwise
N: Not affected
C: See instruction

Example:

If an addition operation is performed between 15 (BCD) and 27 (BCD), simple decimal arithmetic gives this result:

$$\begin{array}{r} 15 \\ +27 \\ \hline 42 \end{array}$$

But when the binary representations are added in the Accumulator according to standard binary arithmetic,

$$\begin{array}{r} 0001 \ 0101 \\ +0010 \ 0111 \\ \hline 0011 \ 1100 \quad 3C \end{array}$$

the sum is ambiguous. The DAA instruction adjusts this result so that the correct BCD representation is obtained:

$$\begin{array}{r} 0011 \ 1100 \\ +0000 \ 0110 \\ \hline 0100 \ 0010 = 42 \end{array}$$

CPL

Operation: $A \leftarrow \bar{A}$.

Format:

Opcode

CPL

0	0	1	0	1	1	1	1
---	---	---	---	---	---	---	---

 2F

Description:

The contents of the Accumulator (register A) are inverted (1's complement).

M CYCLES: 1 T STATES: 4 4 MHZ E.T.: 1.00

Condition Bits Affected:

S: Not affected
Z: Not affected
H: Set
P/V: Not affected
N: Set
C: Not affected

Example:

If the contents of the Accumulator are 1011 0100, after the execution of

CPL

the Accumulator contents will be 0100 1011.

Operation: $A \leftarrow 0-A$

Format:

Opcode

NEG

1	1	1	0	1	1	0	1	ED
---	---	---	---	---	---	---	---	----

0	1	0	0	0	1	0	0	44
---	---	---	---	---	---	---	---	----

Description:

The contents of the Accumulator are negated (two's complement). This is the same as subtracting the contents of the Accumulator from zero. Note that 80H is left unchanged.

M CYCLES: 2 T STATES: 8(4,4) 4 MHZ E.T.: 2.00

Condition Bits Affected:

S: Set if result is negative;
 reset otherwise
 Z: Set if result is zero;
 reset otherwise
 H: Set if borrow from
 Bit 4; reset otherwise
 P/V: Set if Acc. was 80H before
 operation; reset otherwise
 N: Set
 C: Set if Acc. was not 00H before
 operation; reset otherwise

Example:

If the contents of the Accumulator are

1	0	0	1	1	0	0	0
---	---	---	---	---	---	---	---

after the execution of

NEG

the Accumulator contents will be

0	1	1	0	1	0	0	0
---	---	---	---	---	---	---	---

Operation: $CY \leftarrow \overline{CY}$

Format:

Opcode

CCF

0	0	1	1	1	1	1	1
---	---	---	---	---	---	---	---

 3F

Description:

The Carry flag in the F register is inverted.

M CYCLES: 1 T STATES: 4 4 MHZ E.T.: 1.00

Condition Bits Affected:

S: Not affected
 Z: Not affected
 H: Previous carry will be copied
 P/V: Not affected
 N: Reset
 C: Set if CY was 0 before
 operation; reset otherwise

SCF

Operation: CY ← 1

Format:

Opcode

SCF

0	0	1	1	0	1	1	1
---	---	---	---	---	---	---	---

 37

Description:

The Carry flag in the F register is set.

M CYCLES: 1 T STATES: 4 4 MHZ E.T.: 1.00

Condition Bits Affected:

S: Not affected
Z: Not affected
H: Reset
P/V: Not affected
N: Reset
C: Set

NOP

Operation: —

Format:

Opcode

NOP

0	0	0	0	0	0	0	0	0
---	---	---	---	---	---	---	---	---

 00

Description:

The CPU performs no operation during this machine cycle.

M CYCLES: 1 T STATES: 4 4 MHZ E.T.: 1.00

Condition Bits Affected: None

HALT

Operation: —

Format:

Opcode

HALT

0	1	1	1	0	1	1	0
---	---	---	---	---	---	---	---

 76

Description:

The HALT instruction suspends CPU operation until a subsequent interrupt or reset is received. While in the halt state, the processor will execute NOP's to maintain memory refresh logic.

M CYCLES: 1 T STATES: 4 4 MHZ E.T.: 1.00

Condition Bits Affected: None

Operation: IFF ← 0

Format:

Opcode

DI

1	1	1	1	0	0	1	1
---	---	---	---	---	---	---	---

 F3

Description:

DI disables the maskable interrupt by resetting the interrupt enable flip-flops (IFF1 and IFF2). Note that this instruction disables the maskable interrupt during its execution.

M CYCLES: 1 T STATES: 4 4 MHZ E.T.: 1.00

Condition Bits Affected: None

Example:

When the CPU executes the instruction

DI

the maskable interrupt is disabled until it is subsequently re-enabled by an EI instruction. The CPU will not respond to an Interrupt Request (INT) signal.

Operation: IFF ← 1

Format:

Opcode

EI

1	1	1	1	1	0	1	1
---	---	---	---	---	---	---	---

 FB

Description:

The enable interrupt instruction will set both interrupt enable flip flops (IFF1 and IFF2) to a logic '1' allowing recognition of any maskable interrupt. Note that during the execution of this instruction and the following instruction, maskable interrupts will be disabled.

M CYCLES: 1 T STATES: 4 4 MHZ E.T.: 1.00

Condition Bits Affected: None

Example:

When the CPU executes instruction

EI
RETI

the maskable interrupt will be enabled after the execution of the RETI instruction.

Operation: —

Format:

<u>Opcode</u>	<u>Operands</u>								
IM	0								
<table border="1"> <tr> <td>1</td><td>1</td><td>1</td><td>0</td><td>1</td><td>1</td><td>0</td><td>1</td> </tr> </table>	1	1	1	0	1	1	0	1	ED
1	1	1	0	1	1	0	1		
<table border="1"> <tr> <td>0</td><td>1</td><td>0</td><td>0</td><td>0</td><td>1</td><td>1</td><td>0</td> </tr> </table>	0	1	0	0	0	1	1	0	46
0	1	0	0	0	1	1	0		

Description:

The IM 0 instruction sets interrupt mode 0. In this mode the interrupting device can insert any instruction on the data bus for execution by the CPU. The first byte of a multi-byte instruction is read during the interrupt acknowledge cycle. Subsequent bytes are read in by a normal memory read sequence.

M CYCLES: 2 T STATES: 8(4,4) 4 MHZ E.T.: 2.00

Condition Bits Affected: None

IM 1

Operation: —

Format:

<u>Opcode</u>	<u>Operands</u>
IM	1

1 1 1 0 1 1 0 1	ED
-----------------	----

0 1 0 1 0 1 1 0	56
-----------------	----

Description:

The IM instruction sets interrupt mode 1. In this mode the processor will respond to an interrupt by executing a restart to location 0038H.

M CYCLES: 2 T STATES: 8(4,4) 4 MHZ E.T.: 2.00

Condition Bits Affected: None

Operation: —

Format:

<u>Opcode</u>	<u>Operands</u>
IM	2

1	1	1	0	1	1	0	1	ED
---	---	---	---	---	---	---	---	----

0	1	0	1	1	1	1	0	5E
---	---	---	---	---	---	---	---	----

Description:

The IM 2 instruction sets the vectored interrupt mode 2. This mode allows an indirect call to any memory location by an 8 bit vector supplied from the peripheral device. This vector then becomes the least significant 8 bits of the indirect pointer while the I register in the CPU provides the most significant 8 bits. This address points to an address in a vector table which is the starting address for the interrupt service routine.

M CYCLES: 2 T STATES: 8(4,4) 4 MHZ E.T.: 2.00

Condition Bits Affected: None

-16 BIT ARITHMETIC GROUP-

ADD HL, SS

Operation: HL ← HL+ss

Format:

<u>Opcode</u>	<u>Operands</u>
ADD	HL,ss

0	0	s	s	1	0	0	1
---	---	---	---	---	---	---	---

Description:

The contents of register pair ss (any of register pairs BC,DE,HL or SP) are added to the contents of register pair HL and the result is stored in HL. Operand ss is specified as follows in the assembled object code.

<u>Register</u>	
<u>Pair</u>	<u>ss</u>
BC	00
DE	01
HL	10
SP	11

M CYCLES: 3 T STATES: 11(4,4,3) 4 MHZ E.T.: 2.75

Condition Bits Affected:

S: Not affected
Z: Not affected
H: Set if carry out of
Bit 11; reset otherwise
P/V: Not affected
N: Reset
C: Set if carry from
Bit 15; reset otherwise

Example:

If register pair HL contains the integer 4242H and register pair DE contains 1111H, after the execution of

ADD HL,DE

the HL register pair will contain 5353H.

ADC HL, SS

Operation: HL←HL+ss+CY

Format:

<u>Opcode</u>	<u>Operands</u>
ADC	HL,ss

1	1	1	0	1	1	0	1	ED
---	---	---	---	---	---	---	---	----

0	1	s	s	1	0	1	0
---	---	---	---	---	---	---	---

Description:

The contents of register pair ss (any of register pairs BC,DE,HL or SP) are added with the Carry Flag (C flag in the F register) to the contents of register pair HL, and the result is stored in HL. Operand ss is specified as follows in the assembled object code.

<u>Register Pair</u>	<u>ss</u>
BC	00
DE	01
HL	10
SP	11

M CYCLES: 4 T STATES: 15(4,4,4,3) 4 MHZ E.T.: 3.75

Condition Bits Affected:

S:	Set if result is negative; reset otherwise
Z:	Set if result is zero; reset otherwise
H:	Set if carry out of Bit 11; reset otherwise
P/V:	Set if overflow; reset otherwise
N:	Reset
C:	Set if carry from Bit 15; reset otherwise

Example:

If the register pair BC contains 2222H, register pair HL contains 5437H and the Carry Flag is set, after the execution of

ADC HL,BC

the contents of HL will be 765AH.

SBC HL, SS

Operation: HL←HL-ss-CY

Format:

<u>Opcode</u>	<u>Operands</u>
SBC	HL,ss

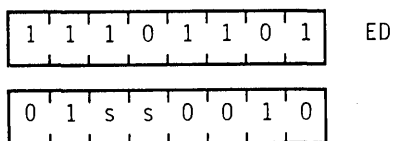

Description:

The contents of the register pair ss (any of register pairs BC,DE,HL or SP) and the Carry Flag (C flag in the F register) are subtracted from the contents of register pair HL and the result is stored in HL. Operand ss is specified as follows in the assembled object code.

<u>Register</u>	
<u>Pair</u>	<u>ss</u>
BC	00
DE	01
HL	10
SP	11

M CYCLES: 4 T STATES: 15(4,4,4,3) 4 MHZ E.T.: 3.75

Condition Bits Affected:

S:	Set if result is negative; reset otherwise
Z:	Set if result is zero; reset otherwise
H:	Set if a borrow from Bit 12;reset otherwise
P/V:	Set if overflow; reset otherwise
N:	Set
C:	Set if borrow; reset otherwise

Example:

If the contents of the HL register pair are 9999H, the contents of register pair DE are 1111H, and the Carry Flag is set, after the execution of

SBC HL,DE

the contents of HL will be 8887H.

ADD IX, pp

Operation: $IX \leftarrow IX + pp$

Format:

<u>Opcode</u>	<u>Operands</u>
ADD	IX,pp

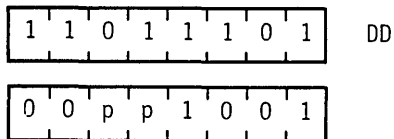

Description:

The contents of register pair pp (any of register pairs BC,DE,IX or SP) are added to the contents of the Index Register IX, and the results are stored in IX. Operand pp is specified as follows in the assembled object code.

<u>Register Pair</u>	<u>pp</u>
BC	00
DE	01
IX	10
SP	11

M CYCLES: 4 T STATES: 15(4,4,4,3) 4 MHZ E.T.: 3.75

Condition Bits Affected:

S:	Not affected
Z:	Not affected
H:	Set if carry out of Bit 11; reset otherwise
P/V:	Not affected
N:	Reset
C:	Set if carry from Bit 15; reset otherwise

Example:

If the contents of Index Register IX are 333H and the contents of register pair BC are 5555H, after the execution of

ADD IX,BC

the contents of IX will be 8888H.

ADD IY, rr

Operation: IY ← IY + rr

Format:

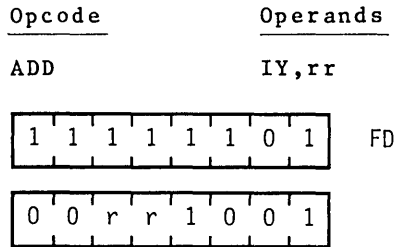

Description:

The contents of register pair rr (any of register pairs BC, DE, IY or SP) are added to the contents of Index Register IY, and the result is stored in IY. Operand rr is specified as follows in the assembled object code.

<u>Register Pair</u>	<u>rr</u>
BC	00
DE	01
IY	10
SP	11

M CYCLES: 4 T STATES: 15(4,4,4,3) 4 MHZ E.T.: 3.75

Condition Bits Affected:

S: Not affected
Z: Not affected
H: Set if carry out of
Bit 11; reset otherwise
P/V: Not affected
N: Reset
C: Set if carry from
Bit 15; reset otherwise

Example:

If the contents of Index Register IY are 333H and the contents of register pair BC are 555H, after the execution of

ADD IY,BC

the contents of IY will be 8888H.

INC SS

Operation: $ss \leftarrow ss + 1$

Format:

<u>Opcodes</u>	<u>Operands</u>
INC	ss

0	0	s	s	0	0	1	1
---	---	---	---	---	---	---	---

Description:

The contents of register pair ss (any of register pairs BC, DE, HL or SP) are incremented. Operand ss is specified as follows in the assembled object code.

<u>Register</u>	<u>ss</u>
<u>Pair</u>	
BC	00
DE	01
HL	10
SP	11

M CYCLES: 1 T STATES: 6 4 MHZ E.T. 1.50

Condition Bits Affected: None

Example:

If the register pair contains 1000H, after the execution of

INC HL

HL will contain 1001H.

INC IX

Operation: $IX \leftarrow IX + 1$

Format:

<u>Opcode</u>	<u>Operands</u>								
INC	IX								
<table border="1"><tr><td>1</td><td>1</td><td>0</td><td>1</td><td>1</td><td>1</td><td>0</td><td>1</td></tr></table>	1	1	0	1	1	1	0	1	DD
1	1	0	1	1	1	0	1		
<table border="1"><tr><td>0</td><td>0</td><td>1</td><td>0</td><td>0</td><td>0</td><td>1</td><td>1</td></tr></table>	0	0	1	0	0	0	1	1	23
0	0	1	0	0	0	1	1		

Description:

The contents of the Index Register IX are incremented.

M CYCLES: 2 T STATES: 10(4,6) 4 MHZ E.T.: 2.50

Condition Bits Affected: None

Example:

If the Index Register IX contains the integer 3300H
after the execution of

INC IX

the contents of Index Register IX will be 3301H.

INC IY

Operation: $IY \leftarrow IY + 1$

Format:

<u>Opcode</u>	<u>Operands</u>
INC	IY

1 1 1 1 1 1 0 1	FD
0 0 1 0 0 0 1 1	23

Description:

The contents of the Index Register IY are incremented.

M CYCLES: 2 T STATES: 10(4,6) 4 MHZ E.T.: 2.50

Condition Bits Affected: None

Example:

If the contents of the Index Register are 2977H, after the execution of

INC IY

the contents of Index Register IY will be 2978H.

Operation: $ss \leftarrow ss - 1$

Format:

<u>Opcode</u>	<u>Operands</u>
DEC	ss

0	0	s	s	1	0	1	1
---	---	---	---	---	---	---	---

Description:

The contents of register pair ss (any of the register pairs BC,DE,HL or SP) are decremented. Operand ss is specified as follows in the assembled object code.

<u>Pair</u>	<u>ss</u>
BC	00
DE	01
HL	10
SP	11

M CYCLES: 1 T STATES: 6 4 MHZ E.T.: 1.50

Condition Bits Affected: None

Example:

If register pair HL contains 1001H, after the execution of

DEC HL

the contents of HL will be 1000H.

DEC IX

Operation: $IX \leftarrow IX - 1$

Format:

<u>Opcode</u>	<u>Operands</u>								
DEC	IX								
<table border="1"><tr><td>1</td><td>1</td><td>0</td><td>1</td><td>1</td><td>1</td><td>0</td><td>1</td></tr></table>	1	1	0	1	1	1	0	1	DD
1	1	0	1	1	1	0	1		
<table border="1"><tr><td>0</td><td>0</td><td>1</td><td>0</td><td>1</td><td>0</td><td>1</td><td>1</td></tr></table>	0	0	1	0	1	0	1	1	2B
0	0	1	0	1	0	1	1		

Description:

The contents of Index Register IX are decremented.

M CYCLES: 2 T STATES: 10(4,6) 4 MHZ E.T.: 2.50

Condition Bits Affected: None

Example:

If the contents of Index Register IX are 2006H, after the execution of

DEC IX

the contents of Index Register IX will be 2005H.

Operation: IY ← IY - 1

Format:

<u>Opcode</u>	<u>Operands</u>								
DEC	IY								
<table border="1" style="display: inline-table; vertical-align: middle;"> <tr> <td>1</td><td>1</td><td>1</td><td>1</td><td>1</td><td>1</td><td>0</td><td>1</td> </tr> </table>	1	1	1	1	1	1	0	1	FD
1	1	1	1	1	1	0	1		
<table border="1" style="display: inline-table; vertical-align: middle;"> <tr> <td>0</td><td>0</td><td>1</td><td>0</td><td>1</td><td>0</td><td>1</td><td>1</td> </tr> </table>	0	0	1	0	1	0	1	1	2B
0	0	1	0	1	0	1	1		

Description:

The contents of the Index Register IY are decremented.

M CYCLES: 2 T STATES: 10 (4,6) 4 MHZ E.T.: 2.50

Condition Bits Affected: None

Example:

If the contents of the Index Register IY are 7649H,
after the execution of

DEC IY

the contents of Index Register IY will be 7648H.

-ROTATE AND SHIFT GROUP-

RLCA

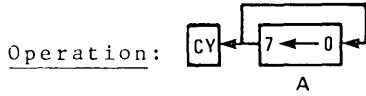

Format:

Opcode Operands

RLCA

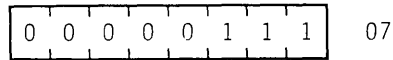

Description:

The contents of the Accumulator (register A) are rotated left one bit position. The sign bit (bit 7) is copied into the Carry Flag and also into bit 0. Bit 0 is the least significant bit.

M CYCLES: 1 T STATES 4 4 MHZ E.T.: 1.00

Condition Bits Affected:

S: Not affected
Z: Not affected
H: Reset
P/V: Not affected
N: Reset
C: Data from Bit 7 of Acc.

Example:

If the contents of the Accumulator are

7	6	5	4	3	2	1	0
1	0	0	0	1	0	0	0

after the execution of

RLCA

the contents of the Accumulator and Carry Flag will be

C	7	6	5	4	3	2	1	0
1	0	0	0	1	0	0	0	1

RLA

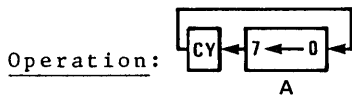

Format:

Opcode Operands

RLA

0	0	0	1	0	1	1	1
---	---	---	---	---	---	---	---

 17

Description:

The contents of the Accumulator (register A) are rotated left one bit position through the Carry Flag. The previous content of the Carry Flag is copied into bit 0. Bit 0 is the least significant bit.

M CYCLES: 1 T STATES: 4 4 MHZ E.T.: 1.00

Condition Bits Affected:

S: Not affected
Z: Not affected
H: Reset
P/V: Not affected
N: Reset
C: Data from Bit 7 of Acc.

Example:

If the contents of the Accumulator and the Carry Flag are

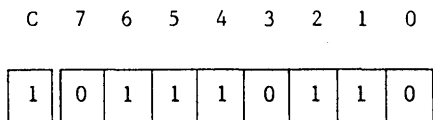

after the execution of

RLA

the contents of the Accumulator and the Carry Flag will be

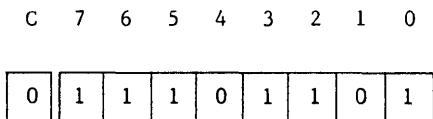

RRCA

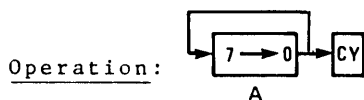

Format:

Opcode Operands

RRCA

0	0	0	0	1	1	1	1
---	---	---	---	---	---	---	---

 OF

Description:

The contents of the Accumulator (register A) are rotated right one bit position. Bit 0 is copied into the Carry Flag and also into bit 7. Bit 0 is the least significant bit.

M CYCLES: 1 T STATES: 4 4 MHZ E.T.: 1.00

Condition Bits Affected:

S: Not affected
Z: Not affected
H: Reset
P/V: Not affected
N: Reset
C: Data from Bit 0 of Acc.

Example:

If the contents of the Accumulator are

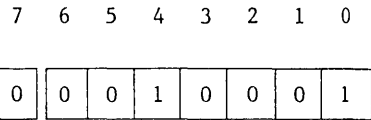

After the execution of

RRCA

the contents of the Accumulator and the Carry Flag will be

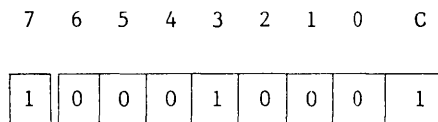

RRA

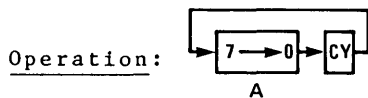

Format:

Opcode Operands

RRA

0	0	0	1	1	1	1	1
---	---	---	---	---	---	---	---

 1F

Description:

The contents of the Accumulator (register A) are rotated right one bit position through the Carry Flag. The previous content of the Carry Flag is copied into bit 7. Bit 0 is the least significant bit.

M CYCLES: 1 T STATES: 4 4 MHZ E.T.: 1.00

Condition Bits Affected:

S: Not affected
Z: Not affected
H: Reset
P/V: Not affected
N: Reset
C: Data from Bit 0 of Acc.

Example:

If the contents of the Accumulator and the Carry Flag are

7	6	5	4	3	2	1	0	C
1	1	1	0	0	0	0	1	0

after the execution of

RRA

the contents of the Accumulator and the Carry Flag will be

7	6	5	4	3	2	1	0	C
0	1	1	1	0	0	0	0	1

RLC r

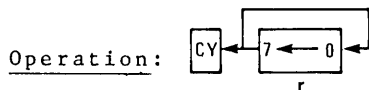

Format:

<u>Opcode</u>	<u>Operands</u>
RLC	r

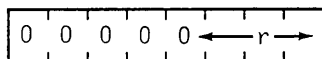
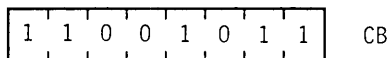

Description:

The contents of register r are rotated left one bit position. The content of bit 7 is copied into the Carry Flag and also into bit 0. Operand r is specified as follows in the assembled object code:

<u>Register</u>	<u>r</u>
B	000
C	001
D	010
E	011
H	100
L	101
A	111

M CYCLES: 2 T STATES: 8(4,4) 4 MHZ E.T.: 2.00

Condition Bits Affected:

S: Set if result is negative;
reset otherwise
Z: Set if result is zero;
reset otherwise
H: Reset
P/V: Set if parity even;
reset otherwise
N: Reset
C: Data from Bit 7 of
source register

Example:

If the contents of register r are

7 6 5 4 3 2 1 0

1	0	0	0	1	0	0	0
---	---	---	---	---	---	---	---

after the execution of

RLC r

the contents of register r and the Carry Flag will be

C 7 6 5 4 3 2 1 0

1	0	0	0	1	0	0	0	1
---	---	---	---	---	---	---	---	---

RLC (HL)

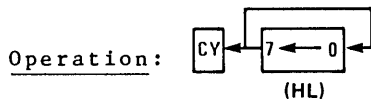

Format:

<u>Opcode</u>	<u>Operands</u>
RLC	(HL)

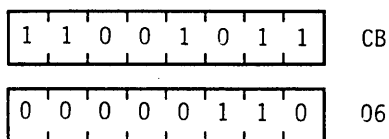

Description:

The contents of the memory address specified by the contents of register pair HL are rotated left one bit position. The content of bit 7 is copied into the Carry Flag and also into bit 0. Bit 0 is the least significant bit.

M CYCLES: 4 T STATES: 15(4,4,4,3) 4 MHZ E.T.: 3.75

Condition Bits Affected:

S: Set if result is negative;
reset otherwise
Z: Set if result is zero;
reset otherwise
H: Reset
P/V: Set if parity even;
reset otherwise
N: Reset
C: Data from Bit 7 of
source register

Example:

If the contents of the HL register pair are 2828H, and the contents of memory location 2828H are

7 6 5 4 3 2 1 0

1	0	0	0	1	0	0	0
---	---	---	---	---	---	---	---

after the execution of

RLC (HL)

the contents of memory location 2828H and the Carry Flag will be

C 7 6 5 4 3 2 1 0

1	0	0	0	1	0	0	0	1
---	---	---	---	---	---	---	---	---

RLC (IX+d)

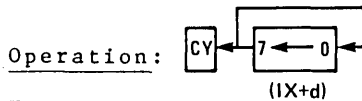

Format:

<u>Opcode</u>	<u>Operands</u>
RLC	(IX+d)

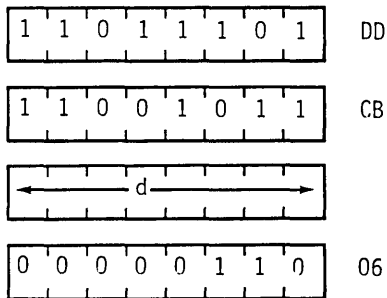

Description:

The contents of the memory address specified by the sum of the contents of the Index Register IX and a two's complement displacement integer d, are rotated left one bit position. The content of bit 7 is copied into the Carry Flag and also into bit 0. Bit 0 is the least significant bit.

M CYCLES: 6 T STATES: 23(4,4,3,5,4,3) 4 MHZ E.T.: 5.75

Condition Bits Affected:

S:	Set if result is negative; reset otherwise
Z:	Set if result is zero; reset otherwise
H:	Reset
P/V:	Set if parity even; reset otherwise
N:	Reset
C:	Data from Bit 7 of source register

Example:

If the contents of the Index Register IX are 1000H, and the contents of memory location 1022H are

7 6 5 4 3 2 1 0

1	0	0	0	1	0	0	0
---	---	---	---	---	---	---	---

after the execution of

RLC (IX+2H)

the contents of memory location 1002H and the Carry Flag will be

C 7 6 5 4 3 2 1 0

1	0	0	0	1	0	0	0	1
---	---	---	---	---	---	---	---	---

RLC (IY+d)

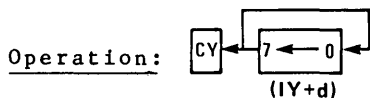

Format:

<u>Opcode</u>	<u>Operands</u>
RLC	(IY+d)

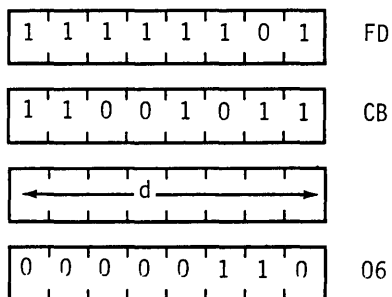

Description:

The contents of the memory address specified by the sum of the contents of the Index Register IY and a two's complement displacement integer d are rotated left one bit position. The content of bit 7 is copied into the Carry Flag and also into bit 0. Bit 0 is the least significant bit.

M CYCLES: 6 T STATES: 23(4,4,3,5,4,3) 4 MHZ E.T.: 5.75

Condition Bits Affected:

S:	Set if result is negative; reset otherwise
Z:	Set if result is zero; reset otherwise
H:	Reset
P/V:	Set if parity even; reset otherwise
N:	Reset
C:	Data from Bit 7 of source register

Example:

If the contents of the Index Register IY are 1000H, and the contents of memory location 1002H are

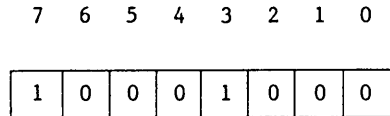

after the execution of

RLC (IY+2H)

the contents of memory location 1002H and the Carry Flag will be

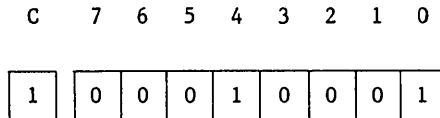

RL m

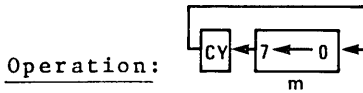

Format:

<u>Opcode</u>	<u>Operands</u>
RL	m

The m operand is any of r, (HL), (IX+d) or (IY+d), as defined for the analogous RLC instructions. These various possible opcode-operand combinations are specified as follows in the assembled object code:

RL r	<div style="border: 1px solid black; padding: 2px; display: flex; justify-content: space-between;"> 11001011 </div>	CB
	<div style="border: 1px solid black; padding: 2px; display: flex; justify-content: space-between;"> 00010 ← r → </div>	
RL (HL)	<div style="border: 1px solid black; padding: 2px; display: flex; justify-content: space-between;"> 11001011 </div>	CB
	<div style="border: 1px solid black; padding: 2px; display: flex; justify-content: space-between;"> 00010110 </div>	16
RL (IX+d)	<div style="border: 1px solid black; padding: 2px; display: flex; justify-content: space-between;"> 11011101 </div>	DD
	<div style="border: 1px solid black; padding: 2px; display: flex; justify-content: space-between;"> 11001011 </div>	CB
	<div style="border: 1px solid black; padding: 2px; display: flex; justify-content: space-between;"> ← d → </div>	
	<div style="border: 1px solid black; padding: 2px; display: flex; justify-content: space-between;"> 00010110 </div>	16

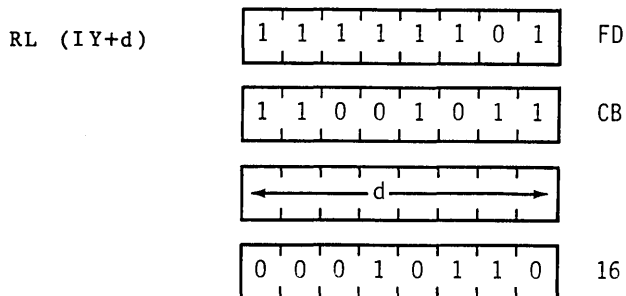

*r identifies registers B,C,D,E,H,L or A specified as follows in the assembled object code above:

<u>Register</u>	<u>r</u>
B	000
C	001
D	010
E	011
H	011
L	101
A	111

Description:

The contents of the m operand are rotated left one bit position. The content of bit 7 is copied into the Carry Flag and the previous content of the Carry Flag is copied into bit 0.

<u>INSTRUCTION</u>	<u>M CYCLES</u>	<u>T STATES</u>	<u>4 MHZ E.T.</u>
RL r	2	8(4,4)	2.00
RL (HL)	4	15(4,4,4,3)	3.75
RL (IX+d)	6	23(4,4,3,5,4,3)	5.75
RL (IY+d)	6	23(4,4,3,5,4,3)	5.75

Condition Bits Affected:

S: Set if result is negative;
reset otherwise
Z: Set if result is zero;
reset otherwise
H: Reset
P/V: Set if parity even;
reset otherwise
N: Reset
C: Data from Bit 7 of
source register

Example:

If the contents of register D and the Carry Flag are

C	7	6	5	4	3	2	1	0
0	1	0	0	0	1	1	1	1

after the execution of

RL D

the contents of register D and the Carry Flag will be

C	7	6	5	4	3	2	1	0
1	0	0	0	1	1	1	1	0

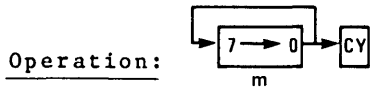

Format:

<u>Opcode</u>	<u>Operands</u>
RRC	m

The m operand is any of r, (HL), (IX+d) or (IY+d), as defined for the analogous RLC instructions. These various possible opcode-operand combinations are specified as follows in the assembled object code:

RRC r	1 1 0 0 1 0 1 1	CB
	0 0 0 0 1 ← r →	
RRC (HL)	1 1 0 0 1 0 1 1	CB
	0 0 0 0 1 1 1 0	OE
RRC (IX+d)	1 1 0 1 1 1 0 1	DD
	1 1 0 0 1 0 1 1	CB
	← d →	
	0 0 0 0 1 1 1 0	OE

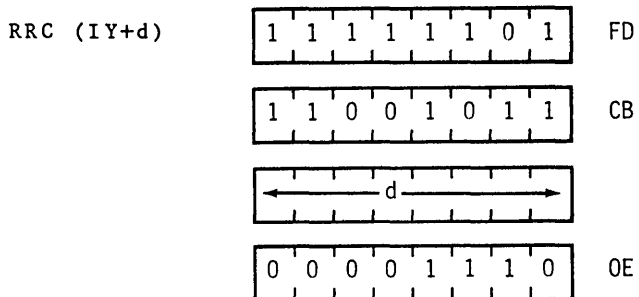

*r identifies registers B,C,D,E,H,L or A specified as follows in the assembled object code above:

<u>Register</u>	<u>r</u>
B	000
C	001
D	010
E	011
H	100
L	101
A	111

Description:

The contents of operand m are rotated right one bit position. The content of bit 0 is copied into the Carry Flag and also into bit 7. Bit 0 is the least significant bit.

<u>INSTRUCTION</u>	<u>M CYCLES</u>	<u>T STATES</u>	<u>4 MHZ E.T.</u>
RRC r	2	8(4,4)	2.00
RRC (HL)	4	15(4,4,4,3)	3.75
RRC (IX+d)	6	23(4,4,3,5,4,3)	5.75
RRC (IY+d)	6	23(4,4,3,5,4,3)	5.75

Condition Bits Affected:

S: Set if result is negative;
reset otherwise
Z: Set if result is zero;
reset otherwise
H: Reset
P/V: Set if parity even;
reset otherwise
N: Reset
C: Data from Bit 0 of
source register

Example:

If the contents of register A are

7 6 5 4 3 2 1 0

0	0	1	1	0	0	0	1
---	---	---	---	---	---	---	---

after the execution of

RRC A

the contents of register A and the Carry Flag will be

7 6 5 4 3 2 1 0 C

1	0	0	1	1	0	0	0	1
---	---	---	---	---	---	---	---	---

RR m

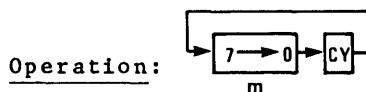

Format:

<u>Opcode</u>	<u>Operand</u>
RR	m

The m operand is any of r, (HL), (IX+d), or (IY+d), as defined for the analogous RLC instructions. These various possible opcode-operand combinations are specified as follows in the assembled object code:

RR r	1 1 0 0 1 0 1 1	CB
	0 0 0 1 1 ← r →	
RR (HL)	1 1 0 0 1 0 1 1	CB
	0 0 0 1 1 1 1 0	1E
RR (IX+d)	1 1 0 1 1 1 0 1	DD
	1 1 0 0 1 0 1 1	CB
	← d →	
	0 0 0 1 1 1 1 0	1E

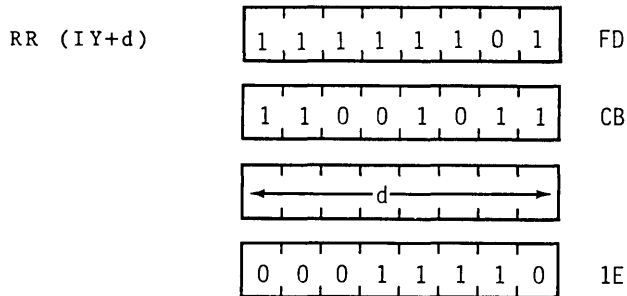

*r identifies registers B,C,D,E,H,L or A specified as follows in the assembled object code above:

<u>Register</u>	<u>r</u>
B	000
C	001
D	010
E	011
H	100
L	101
A	111

Description:

The contents of operand m are rotated right one bit position through the Carry flag. The content of bit 0 is copied into the Carry Flag and the previous content of the Carry Flag is copied into bit 7. Bit 0 is the least significant bit.

<u>INSTRUCTION</u>	<u>M CYCLES</u>	<u>T STATES</u>	<u>4 MHZ E.T.</u>
RR r	2	8(4,4)	2.00
RR (HL)	4	15(4,4,4,3)	3.75
RR (IX+d)	6	23(4,4,3,5,4,3)	5.75
RR (IY+d)	6	23(4,4,3,5,4,3)	5.75

Condition Bits Affected:

S: Set if result is negative;
reset otherwise
Z: Set if result is zero;
reset otherwise
H: Reset
P/V: Set if parity is even;
reset otherwise
N: Reset
C: Data from Bit 0 of
source register

Example:

If the contents of the HL register pair are 4343H, and the contents of memory location 4343H and the Carry Flag are

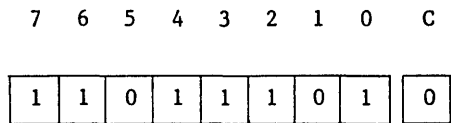

after the execution of

RR (HL)

the contents of location 4343H and the Carry Flag will be

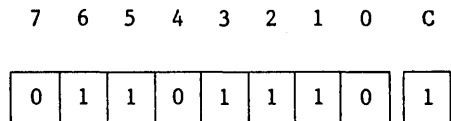

SLA m

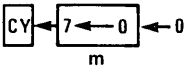
Operation: 

Format:

<u>Opcode</u>	<u>Operands</u>
SLA	m

The m operand is any of r, (HL), (IX+d) or (IY+d), as defined for the analogous RLC instructions. These various possible opcode-operand combinations are specified as follows in the assembled object code:

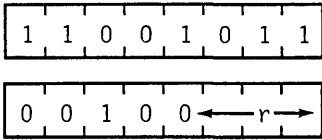
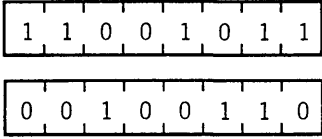
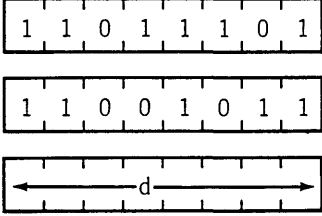
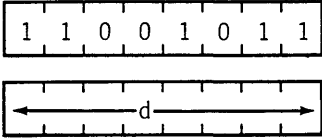
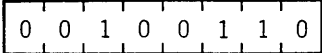
SLA r		CB
SLA (HL)		CB
SLA (IX+d)		DD
		CB
		26

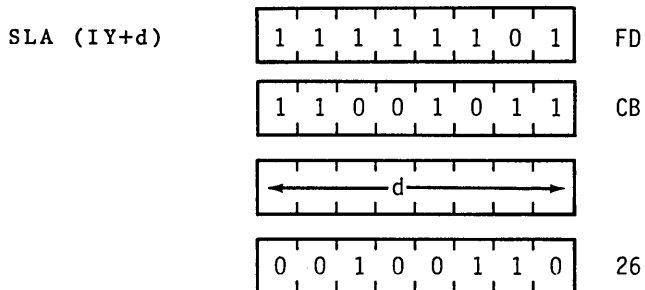

*r identifies registers B,C,D,E,H,L or A specified as follows in the assembled object code field above:

<u>Register</u>	<u>r</u>
B	000
C	001
D	010
E	011
H	100
L	101
A	111

Description:

An arithmetic shift left one bit position is performed on the contents of operand m. The content of bit 7 is copied into the Carry Flag. Bit 0 is the least significant bit.

<u>INSTRUCTION</u>	<u>M CYCLES</u>	<u>T STATES</u>	<u>4 MHZ E.T.</u>
SLA r	2	8(4,4)	2.00
SLA (HL)	4	15(4,4,4,3)	3.75
SLA (IX+d)	6	23(4,4,3,5,4,3)	5.75
SLA (IY+d)	6	23(4,4,3,5,4,3)	5.75

Condition Bits Affected:

S: Set if result is negative;
reset otherwise
Z: Set if result is zero;
reset otherwise
H: Reset
P/V: Set if parity is even;
reset otherwise
N: Reset
C: Data from Bit 7

Example:

If the contents of register L are

7 6 5 4 3 2 1 0

1	0	1	1	0	0	0	1
---	---	---	---	---	---	---	---

after the execution of

SLA L

the contents of register L and the Carry Flag will be

C 7 6 5 4 3 2 1 0

1	0	1	1	0	0	0	1	0
---	---	---	---	---	---	---	---	---

SRA m

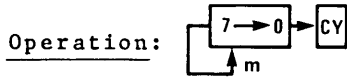

Format:

<u>Opcode</u>	<u>Operands</u>
SRA	m

The m operand is any of r, (HL), (IX+d) or (IY+d), as defined for the analogous RLC instructions. These various possible opcode-operand combinations are specified as follows in the assembled object code:

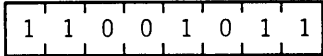
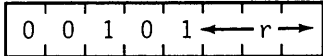
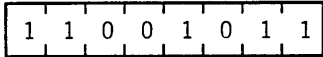
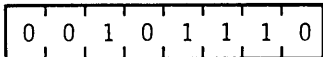
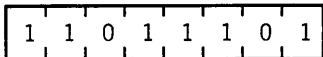
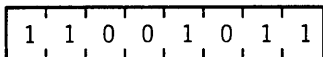
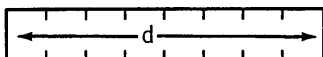
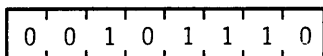
SRA r		CB
		
SRA(HL)		CB
		2E
SRA(IX+d)		DD
		CB
		
		2E

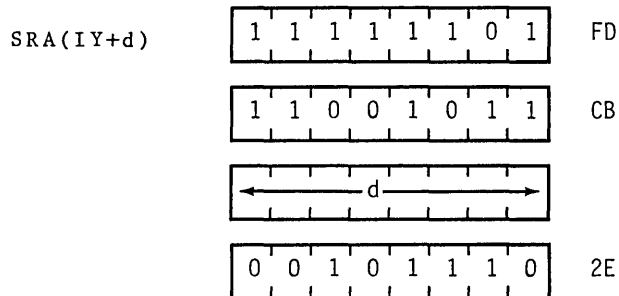

*r identifies registers B,C,D,E,H,L or A specified as follows in the assembled object code field above:

<u>Register</u>	<u>r</u>
B	000
C	001
D	010
E	011
H	100
L	101
A	111

An arithmetic shift right one bit position is performed on the contents of operand m. The content of bit 0 is copied into the Carry Flag and the previous content of bit 7 is unchanged. Bit 0 is the least significant bit.

<u>INSTRUCTION</u>	<u>M CYCLES</u>	<u>T STATES</u>	<u>4 MHZ E.T.</u>
SRA r	2	8(4,4)	2.00
SRA (HL)	4	15(4,4,4,3)	3.75
SRA (IX+d)	6	23(4,4,3,5,4,3)	5.75
SRA (IY+d)	6	23(4,4,3,5,4,3)	5.75

Condition Bits Affected:

S: Set if result is negative;
reset otherwise
Z: Set if result is zero;
reset otherwise
H: Reset
P/V: Set if parity is even;
reset otherwise
N: Reset
C: Data from Bit 0 of
source register

Example:

If the contents of the Index Register IX are 1000H, and
the contents of memory location 1003H are

7 6 5 4 3 2 1 0

1	0	1	1	1	0	0	0
---	---	---	---	---	---	---	---

after the execution of

SRA (IX+3H)

the contents of memory location 1003H and the Carry Flag
will be

7 6 5 4 3 2 1 0 C

1	1	0	1	1	1	0	0	0
---	---	---	---	---	---	---	---	---

SRL m

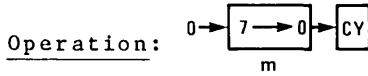

Format:

<u>Opcode</u>	<u>Operands</u>
SRL	m

The operand m is any of r, (HL), (IX+d) or (IY+d), as defined for the analogous RLC instructions. These various possible opcode-operand combinations are specified as follows in the assembled object code:

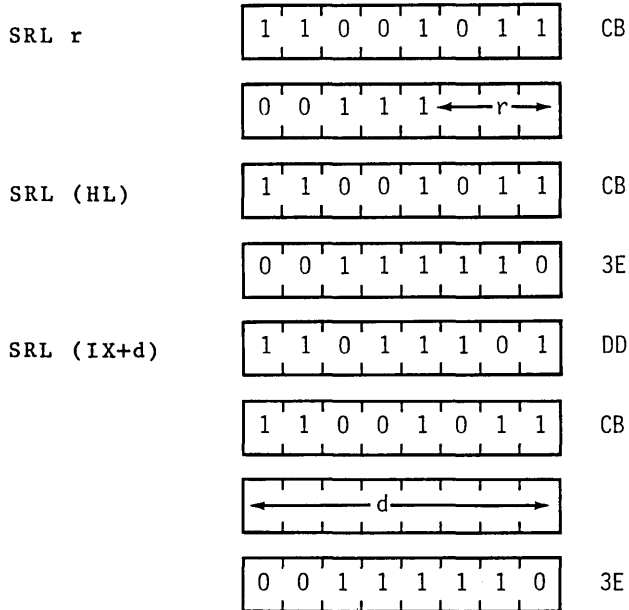

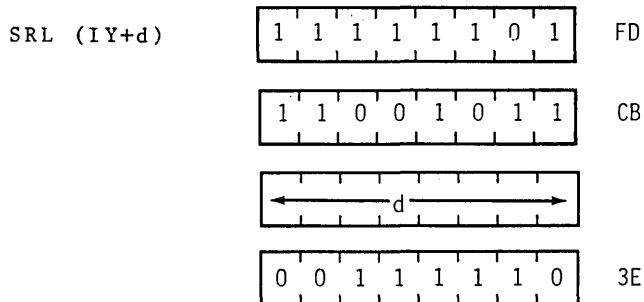

*r identifies registers B,C,D,E,H,L or A specified as follows in the assembled object code fields above:

<u>Register</u>	<u>r</u>
B	000
C	001
D	010
E	011
H	100
L	101
A	111

Description:

The contents of operand m are shifted right one bit position. The content of bit 0 is copied into the Carry Flag, and bit 7 is reset. Bit 0 is the least significant bit.

<u>INSTRUCTION</u>	<u>M CYCLES</u>	<u>T STATES</u>	<u>4 MHZ E.T.</u>
SRL r	2	8(4,4)	2.00
SRL (HL)	4	15(4,4,4,3)	3.75
SRL (IX+d)	6	23(4,4,3,5,4,3)	5.75
SRL (IY+d)	6	23(4,4,3,5,4,3)	5.75

Condition Bits Affected:

S: Reset
Z: Set if result is zero;
reset otherwise
H: Reset
P/V: Set if parity is even;
reset otherwise
N: Reset
C: Data from Bit 0 of
source register

Example:

If the contents of register B are

7 6 5 4 3 2 1 0

1	0	0	0	1	1	1	1
---	---	---	---	---	---	---	---

after the execution of

SRL B

the contents of register B and the Carry Flag will be

7 6 5 4 3 2 1 0 c

0	1	0	0	0	1	1	1	1
---	---	---	---	---	---	---	---	---

RLD

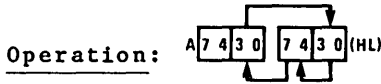

Format:

<u>Opcode</u>	<u>Operands</u>
RLD	

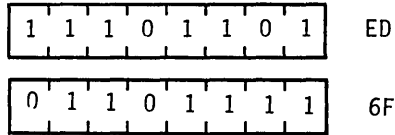

Description:

The contents of the low order four bits (bits 3,2,1 and 0) of the memory location (HL) are copied into the high order four bits (7,6,5 and 4) of that same memory location; the previous contents of those high order four bits are copied into the low order four bits of the Accumulator (register A); and the previous contents of the low order four bits of the Accumulator are copied into the low order four bits of memory location (HL). The contents of the high order bits of the Accumulator are unaffected. Note: (HL) means the memory location specified by the contents of the HL register pair.

M CYCLES: 5 T STATES: 18(4,4,3,4,3) 4 MHZ E.T.: 4.50

Condition Bits Affected:

S:	Set if Acc. is negative after operation; reset otherwise
Z:	Set if Acc. is zero after operation; reset otherwise
H:	Reset
P/V:	Set if parity of Acc. is even after operation; reset otherwise
N:	Reset
C:	Not affected

Example:

If the contents of the HL register pair are 5000H, and the contents of the Accumulator and memory location 5000H are

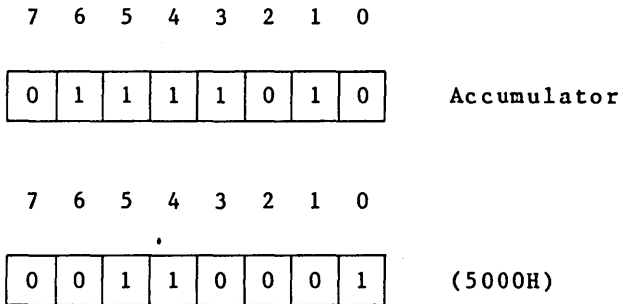

after the execution of

RLD

the contents of the Accumulator and memory location 5000H will be

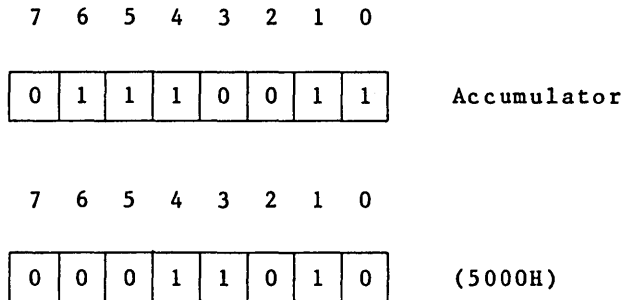

RRD

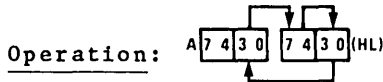

Format:

Opcode Operands

RRD

1	1	1	0	1	1	0	1
---	---	---	---	---	---	---	---

 ED

0	1	1	0	0	1	1	1
---	---	---	---	---	---	---	---

 67

Description:

The contents of the low order four bits (bits 3,2,1 and 0) of memory location (HL) are copied into the low order four bits of the Accumulator (register A); the previous contents of the low order four bits of the Accumulator are copied into the high order four bits (7,6,5 and 4) of location (HL); and the previous contents of the high order four bits of (HL) are copied into the low order four bits of (HL). The contents of the high order bits of the Accumulator are unaffected. Note: (HL) means the memory location specified by the contents of the HL register pair.

M CYCLES: 5 T STATES: 18(4,4,3,4,3) 4 MHZ E.T.: 4.50

Condition Bits Affected:

S: Set if Acc. is negative after operation; reset otherwise
Z: Set if Acc. is zero after operation; reset otherwise
H: Reset
P/V: Set if parity of Acc. is even after operation; reset otherwise
N: Reset
C: Not affected

Example:

If the contents of the HL register pair are 5000H, and the contents of the Accumulator and memory location 5000H are

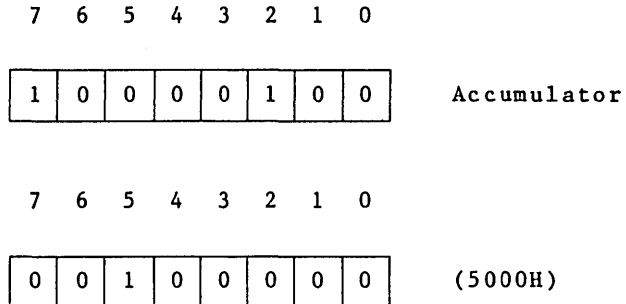

after the execution of

RRD

the contents of the Accumulator and memory location 5000H will be

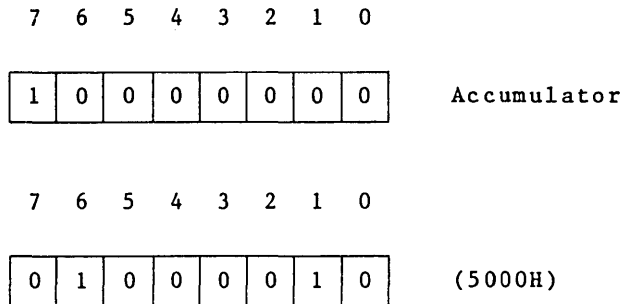

-BIT SET, RESET AND TEST GROUP-

BIT b, r

Operation: $Z \leftarrow \bar{r}_b$

Format:

Opcode Operands

BIT b,r

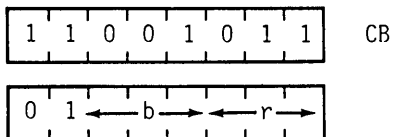

Description:

This instruction tests Bit b in register r and sets the Z flag accordingly. Operands b and r are specified as follows in the assembled object code:

<u>Bit Tested</u>	<u>b</u>	<u>Register</u>	<u>r</u>
0	000	B	000
1	001	C	001
2	010	D	010
3	011	E	011
4	100	H	100
5	101	L	101
6	110	A	111
7	111		

M CYCLES: 2 T STATES: 8(4,4) 4 MHZ E.T.: 2.00

Condition Bits Affected:

S: Unknown
Z: Set if specified Bit is
0; reset otherwise
H: Set
P/V: Unknown
N: Reset
C: Not affected

Example:

If bit 2 in register B contains 0, after the execution of

BIT 2,B

the Z flag in the F register will contain 1, and bit 2 in register B will remain 0. Bit 0 in register B is the least significant bit.

BIT b, (HL)

Operation: $Z \leftarrow \overline{(HL)_b}$

Format:

<u>Opcode</u>	<u>Operands</u>
BIT	b, (HL)

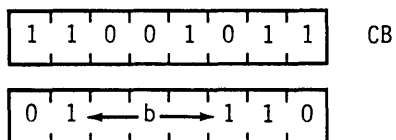

Description:

This instruction tests bit b in the memory location specified by the contents of the HL register pair and sets the Z flag accordingly. Operand b is specified as follows in the assembled object code:

<u>Bit Tested</u>	<u>b</u>
0	000
1	001
2	010
3	011
4	100
5	101
6	110
7	111

M CYCLES: 3 T STATES: 12(4,4,4) 4 MHZ E.T.: 3.00

Condition Bits Affected:

S:	Unknown
Z:	Set if specified Bit is 0; reset otherwise
H:	Set
P/V:	Unknown
H:	Reset
C:	Not affected

Example:

If the HL register pair contains 4444H, and bit 4 in the memory location 444H contains 1, after the execution of

BIT 4, (HL)

the Z flag in the F register will contain 0, and bit 4 in memory location 4444H will still contain 1. (Bit 0 in memory location 4444H is the least significant bit.)

BIT b, (IX+d)

Operation: $Z \leftarrow \overline{(IX+d)_b}$

Format:

Opcode Operands

BIT b, (IX+d)

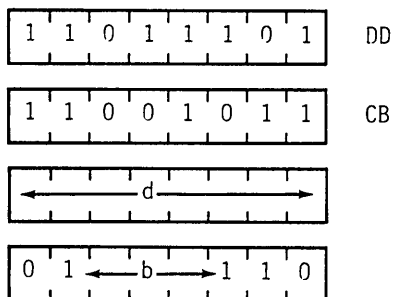

Description:

This instruction tests bit b in the memory location specified by the contents of register pair IX combined with the two's complement displacement d and sets the Z flag accordingly. Operand b is specified as follows in the assembled object code.

<u>Bit Tested</u>	<u>b</u>
0	000
1	001
2	010
3	011
4	100
5	101
6	110
7	111

M CYCLES: 5 T STATES: 20(4,4,3,5,4) 4 MHZ E.T.: 5.00

Condition Bits Affected:

S: Unknown
Z: Set if specified Bit is
 0; reset otherwise

Condition Bits Affected:

S: Unknown
Z: Set if specified Bit is
0; reset otherwise
H: Set
P/V: Unknown
N: Reset
C: Not affected

Example:

If the contents of Index Register IX are 2000H, and bit 6 in memory location 2004H contains 1, after the execution of

BIT 6, (IX+4H)

the Z flag in the F register will contain 0, and bit 6 in memory location 2004H will still contain 1. (Bit 0 in memory location 2004H is the least significant bit.)

BIT b, (IY+d)

BIT b, (IY+d)

Operation: $Z \leftarrow \overline{(IY+d)_b}$

Format:

<u>Opcode</u>	<u>Operands</u>
BIT	b, (IY+d)

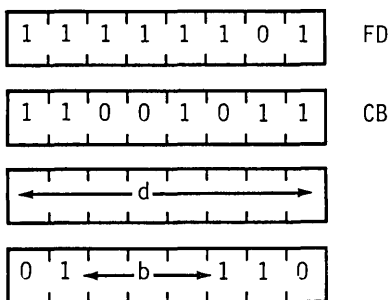

Description:

This instruction tests bit b in the memory location specified by the contents of register pair IY combined with the two's complement displacement d and sets the Z flag accordingly. Operand b is specified as follows in the assembled object code:

<u>Bit Tested</u>	<u>b</u>
0	000
1	001
2	010
3	011
4	100
5	101
6	110
7	111

M CYCLES: 5 T STATES: 20(4,4,3,5,4) 4 MHZ E.T.: 5.00

Condition Bits Affected:

S: Unknown
Z: Set if specified Bit is
0; reset otherwise
H: Set
P/V: Unknown
N: Reset
C: Not affected

Example:

If the contents of Index Register are 2000H, and bit 6 in memory location 2004H contains 1, after the execution of

BIT 6, (IY+4H)

the Z flag in the F register will contain 0, and bit 6 in memory location 2004H will still contain 1. (Bit 0 in memory location 2004H is the least significant bit.)

SET b, r

Operation: $r_b \leftarrow 1$

Format:

<u>Opcode</u>	<u>Operands</u>
SET	b,r

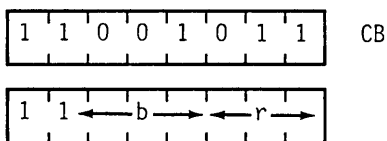

Description:

Bit b in register r (any of registers B,C,D,E,H,L or A) is set. Operands b and r are specified as follows in the assembled object code:

<u>Bit</u>	<u>b</u>	<u>Register</u>	<u>r</u>
0	000	B	000
1	001	C	001
2	010	D	010
3	011	E	011
4	100	H	100
5	101	L	101
6	110	A	111
7	111		

M CYCLES: 2 T STATES: 8(4,4) 4 MHZ E.T.: 2.00

Condition Bits Affected: None

Example:

After the execution of

SET 4,A

bit 4 in register A will be set. (Bit 0 is the least significant bit.)

SET b, (HL)

Operation: (HL)_b ← 1

Format:

<u>Opcode</u>	<u>Operands</u>
SET	b, (HL)

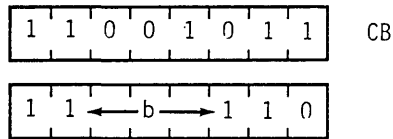

Description:

Bit b in the memory location addressed by the contents of register pair HL is set. Operand b is specified as follows in the assembled object code:

<u>Bit Tested</u>	<u>b</u>
0	000
1	001
2	010
3	011
4	100
5	101
6	110
7	111

M CYCLES: 4 T STATES: 15(4,4,4,3) 4 MHZ E.T.: 3.75

Condition Bits Affected: None

Example:

If the contents of the HL register pair are 3000H, after the execution of

SET 4, (HL)

bit 4 in memory location 3000H will be 1. (Bit 0 in memory location 3000H is the least significant bit.)

SET b, (IX+d)

Operation: $(IX+d)_b \leftarrow 1$

Format:

<u>Opcode</u>	<u>Operands</u>
SET	b, (IX+d)

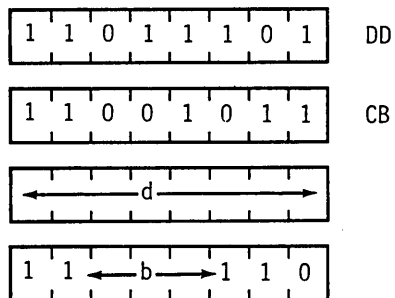

Description:

Bit b in the memory location addressed by the sum of the contents of the IX register pair and the two's complement integer d is set. Operand b is specified as follows in the assembled object code:

<u>Bit Tested</u>	<u>b</u>
0	000
1	001
2	010
3	011
4	100
5	101
6	110
7	111

M CYCLES: 6 T STATES: 23(4,4,3,5,4,3) 4 MHZ E.T.:
5.75

Condition Bits Affected: None

Example:

If the contents of Index Register are 2000H, after the execution of

SET 0,(IX+3H)

bit 0 in memory location 2003H will be 1. (Bit 0 in memory location 2003H is the least significant bit.)

SET b, (IY+d)

Operation: $(IY+d)_b \leftarrow 1$

Format:

<u>Opcode</u>	<u>Operands</u>
SET	b, (IY+d)

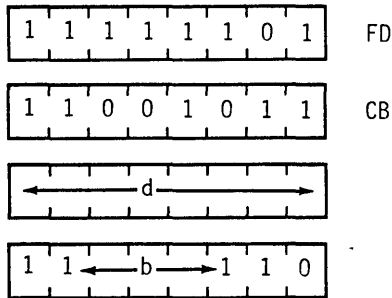

Description:

Bit b in the memory location addressed by the sum of the contents of the IY register pair and the two's complement displacement d is set. Operand b is specified as follows in the assembled object code:

<u>Bit Tested</u>	<u>b</u>
0	000
1	001
2	010
3	011
4	100
5	101
6	110
7	111

M CYCLES: 6 T STATES: 23(4,4,3,5,4,3) 4 MHZ E.T.: 5.75

Condition Bits Affected: None

Example:

If the contents of Index Register IY are 2000H, after

the execution of

SET 0,(IY+3H)

bit 0 in memory location 2003H will be 1. (Bit 0 in memory location 2003H is the least significant bit.)

RES b, m

Operation: $s_b \leftarrow 0$

Format:

<u>Opcode</u>	<u>Operands</u>
RES	b,m

Operand b is any bit (7 through 0) of the contents of the m operand, (any of r, (HL), (IX+d) or (IY+d)) as defined for the analogous SET instructions. These various possible opcode-operand combinations are assembled as follows in the object code:

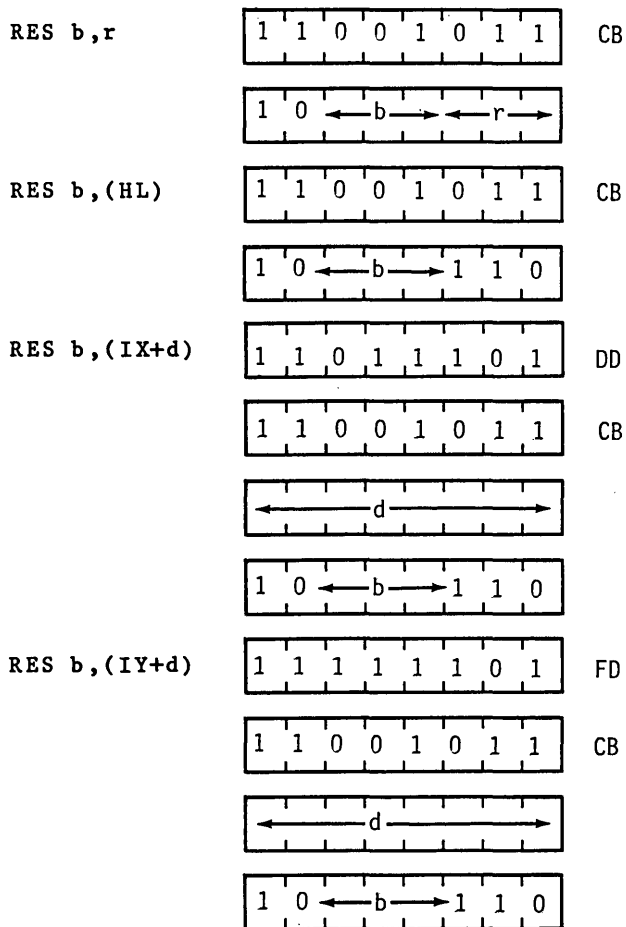

<u>Bit Reset</u>	<u>b</u>	<u>Register</u>	<u>r</u>
0	000	B	000
1	001	C	001
2	010	D	010
3	011	E	011
4	100	H	100
5	101	L	101
6	110	A	111
7	111		

Description:

Bit b in operand m is reset.

<u>INSTRUCTION</u>	<u>M CYCLES</u>	<u>T STATES</u>	<u>4 MHZ E.T.</u>
RES r	4	8(4,4)	2.00
RES (HL)	4	15(4,4,4,3)	3.75
RES (IX+d)	6	23(4,4,3,5,4,3)	5.75
RES (IY+d)	6	23(4,4,3,5,4,3)	5.75

Condition Bits Affected: None

Example:

After the execution of

RES 6,D

bit 6 in register D will be reset. (Bit 0 in register D is the least significant bit.)

-JUMP GROUP-

JP nn

Operation: PC ← nn

Format:

<u>Opcode</u>	<u>Operands</u>
JP	nn

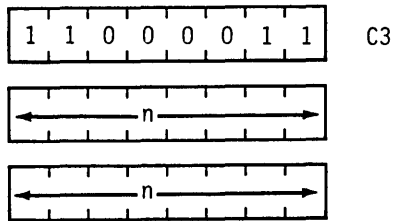

Note: The first operand in this assembled object code is the low order byte of a 2-byte address.

Description:

Operand nn is loaded into register pair PC (Program Counter). The next instruction is fetched from the location designated by the new contents of the PC.

M CYCLES: 3 T STATES: 10(4,3,3) 4 MHZ E.T.: 2.50

Condition Bits Affected: None

Operation: IF cc TRUE, PC ← nn

Format:

Opcode	Operands
JP	cc, nn

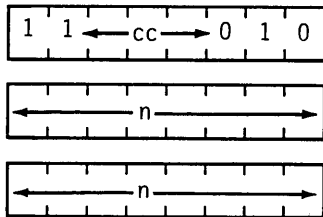

Note: The first n operand in this assembled object code is the low order byte of a 2-byte memory address.

Description:

If condition cc is true, the instruction loads operand nn into register pair PC (Program Counter), and the program continues with the instruction beginning at address nn. If condition cc is false, the Program Counter is incremented as usual, and the program continues with the next sequential instruction. Condition cc is programmed as one of eight status which corresponds to condition bits in the Flag Register (register F). These eight status are defined in the table below which also specifies the corresponding cc bit fields in the assembled object code.

cc	CONDITION	RELEVANT FLAG
000	NZ non zero	Z
001	Z zero	Z
010	NC no carry	C
011	C carry	C
100	PO parity odd	P/V
101	PE parity even	P/V
110	P sign positive	S
111	M sign negative	S

M CYCLES: 3 T STATES: 10(4,3,3) 4 MHZ E.T.: 2.50

Condition Bits Affected: None

Example:

If the Carry Flag (C flag in the F register) is set and the contents of address 1520 are 03H, after the execution of

 JP C,1520H

the Program Counter will contain 1520H, and on the next machine cycle the CPU will fetch from address 1520H the byte 03H.

Operation: $PC \leftarrow PC + e$

Format:

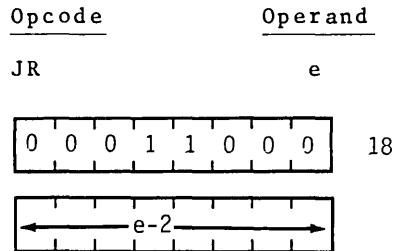

Description:

This instruction provides for unconditional branching to other segments of a program. The value of the displacement e is added to the Program Counter (PC) and the next instruction is fetched from the location designated by the new contents of the PC. This jump is measured from the address of the instruction opcode and has a range of -126 to $+129$ bytes. The assembler automatically adjusts for the twice incremented PC.

M CYCLES: 3 T STATES: 12(4,3,5) 4 MHZ E.T.: 3.00

Condition Bits Affected: None

Example:

To jump forward 5 locations from address 480, the following assembly language statement is used:

JR \$+5

The resulting object code and final PC value is shown below:

<u>Location</u>	<u>Instruction</u>
480	18
481	03
482	—
483	—
484	—
485	← PC after jump

JR C, e

Operation: If C = 0, continue

If C = 1, $PC \leftarrow PC + e$

Format:

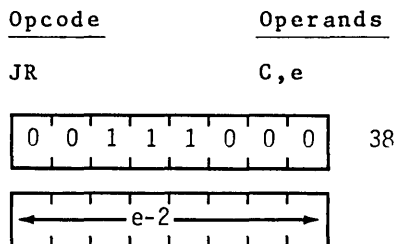

Description:

This instruction provides for conditional branching to other segments of a program depending on the results of a test on the Carry Flag. If the flag is equal to a '1', the value of the displacement e is added to the Program Counter (PC) and the next instruction is fetched from the location designated by the new contents of the PC. The jump is measured from the address of the instruction opcode and has a range of -126 to +129 bytes. The assembler automatically adjusts for the twice incremented PC.

If the flag is equal to a '0', the next instruction to be executed is taken from the location following this instruction.

If condition is met:

M CYCLES: 3 T STATES: 12(4,3,5) 4 MHZ E.T.: 3.00

If condition is not met:

M CYCLES: 2 T STATES: 7(4,3) 4 MHZ E.T.: 1.75

Condition Bits Affected: None

Example:

The Carry Flag is set and it is required to jump back 4 locations from 480. The assembly language statement is:

JR C,\$-4

The resulting object code and final PC value is shown below:

<u>Location</u>	<u>Instruction</u>
47C	← PC after jump
47D	—
47E	—
47F	—
480	38
481	FA (2's complement-6)

JR NC, e

Operation: If C = 1, continue
If C = 0, PC ← PC + e

Format:

<u>Opcode</u>	<u>Operands</u>
JR	NC, e

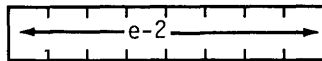
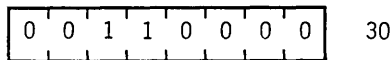

Description:

This instruction provides for conditional branching to other segments of a program depending on the results of a test on the Carry Flag. If the flag is equal to '0', the value of the displacement e is added to the Program Counter (PC) and the next instruction is fetched from the location designated by the new contents of the PC. The jump is measured from the address of the instruction opcode and has a range of -126 to +129 bytes. The assembler automatically adjusts for the twice incremented PC.

If the flag is equal to a '1', the next instruction to be executed is taken from the location following this instruction.

If the condition is met:

M CYCLES: 3 T STATES: 12(4,3,5) 4 MHZ E.T.: 3.00

If the condition is not met:

M CYCLES: 7 T STATES: 7(4,3) 4 MHZ E.T.: 1.75

Condition Bits Affected: None

Example:

The Carry Flag is reset and it is required to repeat the jump instruction. The assembly language statement is:

JR NC,\$

The resulting object code and PC after the jump are shown below:

<u>Location</u>	<u>Instruction</u>
480	30 ← PC after jump
481	00

JR Z, e

Operation: If Z = 0, continue
If Z = 1, PC ← PC + e

Format:

<u>Opcode</u>	<u>Operands</u>
JR	Z, e

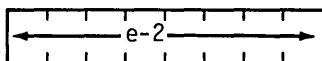
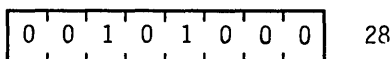

Description:

This instruction provides for conditional branching to other segments of a program depending on the results of a test on the Zero Flag. If the flag is equal to a '1', the value of the displacement e is added to the Program Counter (PC) and the next instruction is fetched from the location designated by the new contents of the PC. The jump is measured from the address of the instruction opcode and has a range of -126 to +129 bytes. The assembler automatically adjusts for the twice incremented PC.

If the Zero Flag is equal to a '0', the next instruction to be executed is taken from the location following this instruction.

If the condition is met:

M CYCLES: 3 T STATES: 12(4,3,5) 4 MHZ E.T.: 3.00

If the condition is not met:

M CYCLES: 2 T STATES: 7(4,3) 4 MHZ E.T.: 1.75

Condition Bits Affected: None

Example:

The Zero Flag is set and it is required to jump forward 5 locations from address 300. The following assembly language statement is used:

JR Z,\$ +5

The resulting object code and final PC value is shown below:

<u>Location</u>	<u>Instruction</u>
300	28
301	03
302	—
303	—
304	—
305	← PC after jump

JR NZ, e

Operation: If Z = 1, continue
If Z = 0, PC ← PC + e

Format:

<u>Opcode</u>	<u>Operands</u>
JR	NZ, e

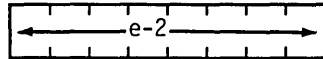
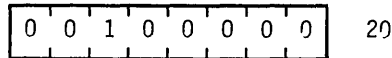

Description:

This instruction provides for conditional branching to other segments of a program depending on the results of a test on the Zero Flag. If the flag is equal to a '0', the value of the displacement e is added to the Program Counter (PC) and the next instruction is fetched from the location designated by the new contents of the PC. The jump is measured from the address of the instruction opcode and has a range of -126 to +129 bytes. The assembler automatically adjusts for the twice incremented PC.

If the Zero Flag is equal to a '1', the next instruction to be executed is taken from the location following this instruction.

If the condition is met:

M CYCLES: 3 T STATES: 12(4,3,5) 4 MHZ E.T.: 3.00

If the condition is not met:

M CYCLES: 2 T STATES: 7(4,3) 4 MHZ E.T.: 1.75

Condition Bits Affected: None

Example:

The Zero Flag is reset and it is required to jump back 4 locations from 480. The assembly language statement is:

JR NZ, \$-4

The resulting object code and final PC value is shown below:

<u>Location</u>	<u>Instruction</u>
47C	← PC after jump
47D	—
47E	—
47F	—
480	20
481	FA (2' complement-6)

JP (HL)

Operation: PC ← HL

Format:

<u>Opcode</u>	<u>Operands</u>
JP	(HL)

1	1	1	0	1	0	0	1	E9
---	---	---	---	---	---	---	---	----

Description:

The Program Counter (register pair PC) is loaded with the contents of the HL register pair. The next instruction is fetched from the location designated by the new contents of the PC.

M CYCLES: 1 T STATES: 4 4 MHZ E.T.: 1.00

Condition Bits Affected: None

Example:

If the contents of the Program Counter are 1000H and the contents of the HL register pair are 4800H, after the execution of

JP (HL)

the contents of the Program Counter will be 4800H.

Operation: PC ← IX

Format:

<u>Opcode</u>	<u>Operands</u>
JP	(IX)

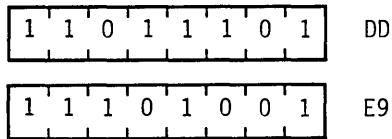

Description:

The Program Counter (register pair PC) is loaded with the contents of the IX Register Pair. The next instruction is fetched from the location designated by the new contents of the PC.

M CYCLES: 2 T STATES: 8(4,4) 4 MHZ E.T.: 2.00

Condition Bits Affected: None

Example:

If the contents of the Program Counter are 1000H, and the contents of the IX Register Pair are 4800H, after the execution of

JP (IX)

the contents of the Program Counter will be 4800H.

JP (IY)

Operation: PC ← IY

Format:

<u>Opcode</u>	<u>Operands</u>
JP	(IY)

1	1	1	1	1	1	0	1	FD
---	---	---	---	---	---	---	---	----

1	1	1	0	1	0	0	1	E9
---	---	---	---	---	---	---	---	----

Description:

The Program Counter (register pair PC) is loaded with the contents of the IY Register Pair. The next instruction is fetched from the location designated by the new contents of the PC.

M CYCLES: 2 T STATES: 8(4,4) 4 MHZ E.T.: 2.00

Condition Bits Affected: None

Example:

If the contents of the Program Counter are 1000H and the contents of the IY Register Pair are 4800H, after the execution of

JP (IY)

the contents of the Program Counter will be 4800H.

Operation: —

Format:

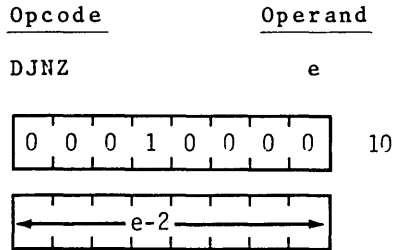

Description:

This instruction is similar to the conditional jump instructions except that a register value is used to determine branching. The B register is decremented and if a non zero value remains, the value of the displacement e is added to the Program Counter (PC). The next instruction is fetched from the location designated by the new contents of the PC. The jump is measured from the address of the instruction opcode and has a range of -126 to +129 bytes. The assembler automatically adjusts for the twice incremented PC.

If the result of decrementing leaves B with a zero value, the next instruction to be executed is taken from the location following this instruction.

If B≠0:

M CYCLES: 3 T STATES: 13(5,3,5) 4 MHZ E.T.: 3.25

If B=0:

M CYCLES: 2 T STATES: 8(5,3) 4 MHZ E.T.: 2.00

Condition Bits Affected: None

Example:

A typical software routine is used to demonstrate the use of the DJNZ instruction. This routine moves a line from an input buffer (INBUF) to an output buffer

(OUTBUF). It moves the bytes until it finds a CR, or until it has moved 80 bytes, whichever occurs first.

```
LD          B,80          ;Set up counter
LD          HL,Inbuf      ;Set up pointers
LD          DE,Outbuf

LOOP:      LD          A,(HL)      ;Get next byte from
                                ;input buffer
LD          (DE),A        ;Store in output buffer
CP          ODH           ;Is it a CR?
JR          Z,DONE        ;Yes finished
INC        HL            ;Increment pointers
INC        DE
DJNZ      LOOP           ;Loop back if 80
                                ;bytes have not
                                ;been moved

DONE:
```

-CALL AND RETURN GROUP-

CALL nn

Operation: (SP-1) ← PC_H, (SP-2) ← PC_L, PC ← nn

Format:

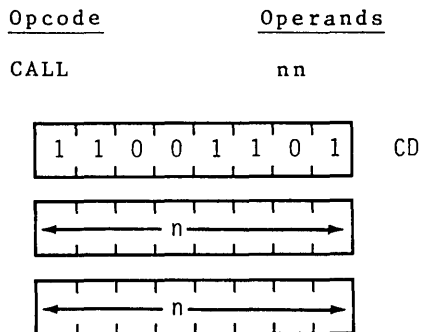

Note: The first of the two n operands in the assembled object code above is the least significant byte of a two-byte memory address.

Description:

The current contents of the Program Counter (PC) are pushed onto the top of the external memory stack. The operands nn are then loaded into the PC to point to the address in memory where the first opcode of a subroutine is to be fetched. (At the end of the subroutine, a RETURN instruction can be used to return to the original program flow by popping the top of the stack back into the PC.) The push is accomplished by first decrementing the current contents of the Stack Pointer (register pair SP), loading the high-order byte of the PC contents into the memory address now pointed to by the SP; then decrementing SP again, and loading the low-order byte of the PC contents into the top of stack. Note: Because this is a 3-byte instruction, the Program Counter will have been incremented by 3 before the push is executed.

M CYCLES: 5 T STATES: 17(4,3,4,3,3) 4 MHZ E.T.: 4.25

Condition Bits Affected: None

Example:

If the contents of the Program Counter are 1A47H, the contents of the Stack Pointer are 3002H, and memory locations have the contents:

Location	Contents
1A47H	CDH
1A48H	35H
1A49H	21H

then if an instruction fetch sequence begins, the three-byte instruction CD3521H will be fetched to the CPU for execution. The mnemonic equivalent of this is

CALL 2135H

After the execution of this instruction, the contents of memory address 3001H will be 1AH, the contents of address 3000H will be 4AH, the contents of the Stack Pointer will be 3000H, and the contents of the Program Counter will be 2135H, pointing to the address of the first opcode of the subroutine now to be executed.

CALL cc, nn

Operation: IF cc TRUE: (SP-1) \leftarrow PC_H
(SP-2) \leftarrow PC_L, PC \leftarrow nn

Format:

<u>Opcode</u>	<u>Operands</u>
CALL	cc, nn

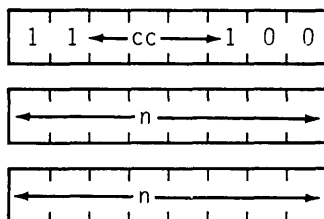

Note: The first of the two n operands in the assembled object code above is the least significant byte of the two-byte memory address.

Description:

If condition cc is true, this instruction pushes the current contents of the Program Counter (PC) onto the top of the external memory stack, then loads the operands nn into PC to point to the address in memory where the first opcode of a subroutine is to be fetched.

(At the end of the subroutine, a RETURN instruction can be used to return to the original program flow by popping the top of the stack back into PC.) If condition cc is false, the Program Counter is incremented as usual, and the program continues with the next sequential instruction. The stack push is accomplished by first decrementing the current contents of the Stack Pointer (SP), loading the high-order byte of the PC contents into the memory address now pointed to by SP; then decrementing SP again, and loading the low-order byte of the PC contents into the top of the stack. Note: Because this is a 3-byte instruction, the Program Counter will have been incremented by 3 before

the push is executed. Condition cc is programmed as one of eight status which corresponds to condition bits in the Flag Register (register F). These eight status are defined in the table below, which also specifies the corresponding cc bit fields in the assembled object code:

<u>cc</u>	<u>Condition</u>	<u>Relevant Flag</u>
000	NZ non zero	Z
001	Z zero	Z
010	NC non carry	C
011	C carry	C
100	PO parity odd	P/V
101	PE parity even	P/V
110	P sign positive	S
111	M sign negative	S

If cc is true:

M CYCLES: 5 T STATES: 17(4,3,4,3,3) 4 MHZ E.T.: 4.25

If cc is false:

M CYCLES: 3 T STATES: 10(4,3,3) 4 MHZ E.T.: 2.50

Condition Bits Affected: None

Example:

If the C Flag in the F register is reset, the contents of the Program Counter are 1A47H, the contents of the Stack Pointer are 3002H, and memory locations have the contents:

<u>Location</u>	<u>Contents</u>
1A47H	D4H
1A48H	35H
1A49H	21H

then if an instruction fetch sequence begins, the three-byte instruction D43521H will be fetched to the CPU for execution. The mnemonic equivalent of this is

CALL NC,2135H

After the execution of this instruction, the contents of memory address 3001H will be 1AH, the contents of address 3000H will be 4AH, the contents of the Stack Pointer will be 3000H, and the contents of the Program Counter will be 2135H, pointing to the address of the first opcode of the subroutine now to be executed.

RET

Operation: $PC_L \leftarrow (SP)$, $PC_H \leftarrow (SP+1)$

Format:

Opcode

RET

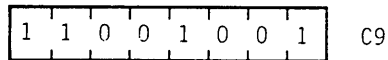

Description:

The byte at the memory location specified by the contents of the Stack Pointer (SP) register pair are moved to the low order eight bits of the Program Counter (PC). The SP is now incremented and the byte at the memory location specified by the new contents of the SP are moved to the high order eight bits of the PC. The SP is now incremented again. The next op code following this instruction will be fetched from the memory location specified by the PC. This instruction is normally used to return to the main line program at the completion of a routine entered by a CALL instruction.

M CYCLES: 3 T STATES: 10(4,3,3) 4 MHZ E.T.: 2.50

Condition Bits Affected: None

Example:

If the contents of the Program Counter are 3535H, the contents of the Stack Pointer are 2000H, the contents of memory location 2000H are B5H, and the contents of memory location 2001H are 18H, then after the execution of

RET

the contents of the Stack Pointer will be 2002H and the contents of the Program Counter will be 18B5H, pointing to the address of the next program opcode to be fetched.

RET cc

Operation: IF cc TRUE: $PC_L \leftarrow (SP)$, $PC_H \leftarrow (SP+1)$

Format:

<u>Opcode</u>	<u>Operand</u>
RET	cc

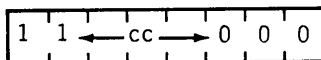

Description:

If condition cc is true, the byte at the memory location specified by the contents of the Stack Pointer (SP) register pair are moved to the low order eight bits of the Program Counter (PC). The SP is now incremented and the byte at the memory location specified by the new contents of the SP are moved to the high order eight bits of the PC. The SP is now incremented again. The next op code following this instruction will be fetched from the memory location specified by the PC. This instruction is normally used to return to the main line program at the completion of a routine entered by a CALL instruction. If condition cc is false, the PC is simply incremented as usual, and the program continues with the next sequential instruction. Condition cc is programmed as one of eight status which correspond to condition bits in the Flag Register (register F). These eight status are defined in the table below, which also specifies the corresponding cc bit fields in the assembled object code.

<u>cc</u>	<u>Condition</u>	<u>Relevant Flag</u>
000	NZ non zero	Z
001	Z zero	Z
010	NC non carry	C
011	C carry	C
100	PO parity odd	P/V
101	PE parity even	P/V
110	P sign positive	S
111	M sign negative	S

If cc is true:

M CYCLES: 3 T STATES: 11(5,3,3) 4 MHZ E.T.: 2.75

If cc is false:

M CYCLES: 1 T STATES: 5 4 MHZ E.T.: 1.25

Condition Bits Affected: None

Example:

If the S flag in the F register is set, the contents of the Program Counter are 3535H, the contents of the Stack Pointer are 2000H, the contents of memory location 2000H are B5H, and the contents of memory location 2001H are 18H, then after the execution of

RET M

the contents of the Stack Pointer will be 2002H and the contents of the Program Counter will be 18B5H, pointing to the address of the next program opcode to be fetched.

RETI

Operation: Return from interrupt

Format:

Opcode

RETI

1	1	1	0	1	1	0	1	ED
---	---	---	---	---	---	---	---	----

0	1	0	0	1	1	0	1	4D
---	---	---	---	---	---	---	---	----

Description:

This instruction is used at the end of a maskable interrupt service routine to:

1. Restore the contents of the Program Counter (PC) (analogous to the RET instruction)
2. To signal an I/O device that the interrupt routine has been completed. The RETI instruction also facilitates the nesting of interrupts allowing higher priority devices to temporarily suspend service of lower priority service routines. Note: This instruction does not enable interrupts which were disabled when the interrupt routine was entered. Before doing the RETI instruction, the enable interrupt instruction (EI) should be executed to allow recognition of interrupts after completion of the current service routine.

M CYCLES: 4 T STATES: 14(4,4,3,3) 4 MHZ E.T.: 3.50

Condition Bits Affected: None

Example:

Given: Two interrupting devices, A and B connected in a daisy chain configuration with A having a higher priority than B.

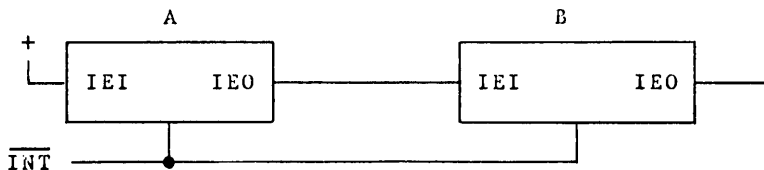

B generates an interrupt and is acknowledged. (The interrupt enable out, IEO, of B goes low, blocking any lower priority devices from interrupting while B is being serviced). Then A generates an interrupt, suspending service of B. (The IEO of A goes 'low' indicating that a higher priority device is being serviced.) The A routine is completed and a RETI is issued resetting the IEO of A, allowing the B routine to continue. A second RETI is issued on completion of the B routine and the IEO of B is reset (high) allowing lower priority devices interrupt access.

RETN

Operation: Return from non maskable interrupt

Format:

Opcode

RETN

1	1	1	0	1	1	0	1
---	---	---	---	---	---	---	---

 ED

0	1	0	0	0	1	0	1
---	---	---	---	---	---	---	---

 45

Description:

This instruction is used at the end of a non-maskable interrupt service routine to restore the contents of the Program Counter (PC) (analogous to the RET instruction).

The state of IFF2 is copied back into IFF1 so that maskable interrupts are enabled immediately following the RETN if they were enabled before the non-maskable interrupt.

M CYCLES: 4 T STATES: 14(4,4,3,3) 4 MHZ E.T.: 3.50

Condition Bits Affected: None

Example:

If the contents of the Stack Pointer are 1000H and the contents of the Program Counter are 1A45H when a non maskable interrupt (NMI) signal is received, the CPU will ignore the next instruction and will instead restart to memory address 0066H. That is, the current Program Counter contents of 1A45H will be pushed onto the external stack address of 0FFFH and 0FFEh, high order-byte first, and 0066H will be loaded onto the Program Counter. That address begins an interrupt service routine which ends with RETN instruction. Upon the execution of RETN, the former Program Counter contents are popped off the external memory stack, low-order first, resulting in a Stack Pointer contents again of 1000H. The program flow continues where it left off with an opcode fetch to address 1A45H.

order-byte first, and 0066H will be loaded onto the Program Counter. That address begins an interrupt service routine which ends with RETN instruction. Upon the execution of RETN, the former Program Counter contents are popped off the external memory stack, low-order first, resulting in a Stack Pointer contents again of 1000H. The program flow continues where it left off with an opcode fetch to address 1A45H.

RST p

Operation: (SP-1) ← PC_H , (SP-2) ← PC_L , PC_H ← 0 , PC_L ← P

Format:

<u>Opcode</u>	<u>Operand</u>
RST	p

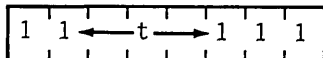

Description:

The current Program Counter (PC) contents are pushed onto the external memory stack, and the page zero memory location given by operand p is loaded into the PC. Program execution then begins with the opcode in the address now pointed to by PC. The push is performed by first decrementing the contents of the Stack Pointer (SP), loading the high-order byte of PC into the memory address now pointed to by SP, decrementing SP again, and loading the low-order byte of PC into the address now pointed to by SP. The ReStart instruction allows for a jump to one of eight addresses as shown in the table below. The operand p is assembled into the object code using the corresponding T state. Note: Since all addresses are in page zero of memory, the high order byte of PC is loaded with 00H. The number selected from the "p" column of the table is loaded into the low-order byte of PC.

<u>p</u>	<u>t</u>
00H	000
08H	001
10H	010
18H	011
20H	100
28H	101
30H	110
38H	111

M CYCLES: 3 T STATES: 11(5,3,3) 4 MHZ E.T.: 2.75

Example:

If the contents of the Program Counter are 15B3H, after the execution of

RST 18H (Object code 1101111)

the PC will contain 0018H, as the address of the next opcode to be fetched.

-INPUT AND OUTPUT GROUP-

IN A, (n)

Operation: $A \leftarrow (n)$

Format:

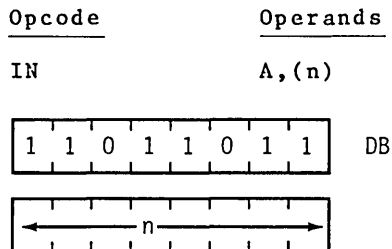

Description:

The operand n is placed on the bottom half (A0 through A7) of the address bus to select the I/O device at one of 256 possible ports. The contents of the Accumulator also appear on the top half (A8 through A15) of the address bus at this time. Then one byte from the selected port is placed on the data bus and written into the Accumulator (register A) in the CPU.

M CYCLES: 3 T STATES: 11(4,3,4) 4 MHZ E.T.: 2.75

Condition Bits Affected: None

Example:

If the contents of the Accumulator are 23H and the byte 7BH is available at the peripheral device mapped to I/O port address 01H, then after the execution of

IN A, (01H)

the Accumulator will contain 7BH.

IN r, (C)

Operation: $r \leftarrow (C)$

Format:

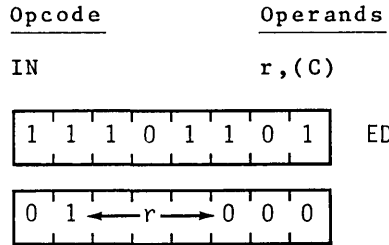

Description:

The contents of register C are placed on the bottom half (A0 through A7) of the address bus to select the I/O device at one of 256 possible ports. The contents of Register B are placed on the top half (A8 through A15) of the address bus at this time. Then one byte from the selected port is placed on the data bus and written into register r in the CPU. Register r identifies any of the CPU registers shown in the following table, which also shows the corresponding 3-bit "r" field for each. The flags will be affected, checking the input data.

<u>Reg.</u>	<u>r</u>
B	000
C	001
D	010
E	011
H	100
L	101
A	111

M CYCLES: 3 T STATES: 12(4,4,4) 4 MHZ E.T.: 3.00

Condition Bits Affected:

S: Set if input data is negative;
reset otherwise
Z: Set if input data is zero;
reset otherwise
H: Reset
P/V: Set if parity is even;
reset otherwise
N: Reset
C: Not affected

Example:

If the contents of register C are 07H, the contents of register B are 10H, and the byte 7BH is available at the peripheral device mapped to I/O port address 07H, then after the execution of

IN D,(C)

Operation: (HL) \leftarrow (C) , B \leftarrow B-1 , HL \leftarrow HL + 1

Format:

Opcode

INI

1	1	1	0	1	1	0	1	ED
---	---	---	---	---	---	---	---	----

1	0	1	0	0	0	1	0	A2
---	---	---	---	---	---	---	---	----

Description:

The contents of register C are placed on the bottom half (A0 through A7) of the address bus to select the I/O device at one of 256 possible ports. Register B may be used as a byte counter, and its contents are placed on the top half (A8 through A15) of the address bus at this time. Then one byte from the selected port is placed on the data bus and written to the CPU. The contents of the HL register pair are then placed on the address bus and the input byte is written into the corresponding location of memory. Finally the byte counter is decremented and register pair HL is incremented.

M CYCLES: 4 T STATES: 16(4,5,3,4) 4 MHZ E.T.: 4.00

Condition Bits Affected:

S: Unknown
 Z: Set if B-1=0;
 reset otherwise
 H: Unknown
 P/V: Unknown
 N: Set
 C: Not affected

Example:

If the contents of register C are 07H, the contents of register B are 10H, the contents of the HL register pair are 1000H, and the byte 7BH is available at the peripheral device mapped to I/O port address 07H, then

after the execution of

INI

memory location 1000H will contain 7BH, the HL register pair will contain 1001H, and register B will contain 0FH.

Operation: (HL) ← (C) , B ← B-1 , HL ← HL + 1

Format:

Opcode

INIR

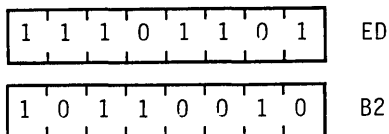

Description:

The contents of register C are placed on the bottom half (A0 through A7) of the address bus to select the I/O device at one of 256 possible ports. Register B is used as a byte counter, and its contents are placed on the top half (A8 through A15) of the address bus at this time. Then one byte from the selected port is placed on the data bus and written to the CPU. The contents of the HL register pair are placed on the address bus and the input byte is written into the corresponding location of memory. Then register pair HL is incremented, the byte counter is decremented. If decrementing causes B to go to zero, the instruction is terminated. If B is not zero, the PC is decremented by two and the instruction repeated. Interrupts will be recognized and two refresh cycles will be executed after each data transfer. Note that if B is set to zero prior to instruction execution, 256 bytes of data will be input.

If $B \neq 0$:

M CYCLES: 5 T STATES: 21(4,5,3,4,5) 4 MHZ E.T.: 5.25

If $B = 0$:

M CYCLES: 4 T STATES: 16(4,5,3,4) 4 MHZ E.T.: 4.00

Condition Bits Affected:

S: Unknown
Z: Set
H: Unknown
P/V: Unknown
N: Set
C: Not affected

Example:

If the contents of register C are 07H, the contents of register B are 03H, the contents of the HL register pair are 1000H, and the following sequence of bytes are available at the peripheral device mapped to I/O port of address 07H:

51H
A9H
03H

then after the execution of

INIR

the HL register pair will contain 1003H, register B will contain zero, and memory locations will have contents as follows:

Location	Contents
1000H	51H
1001H	A9H
1002H	03H

Operation: (HL) ← (C), B ← B-1, HL ← HL-1

Format:

Opcode

IND

1	1	1	0	1	1	0	1	ED
---	---	---	---	---	---	---	---	----

1	0	1	0	1	0	1	0	AA
---	---	---	---	---	---	---	---	----

Description:

The contents of register C are placed on the bottom half (A0 through A7) of the address bus to select the I/O device at one of 256 possible ports. Register B may be used as a byte counter, and its contents are placed on the top half (A8 through A15) of the address bus at this time. Then one byte from the selected port is placed on the data bus and written to the CPU. The contents of the HL register pair are placed on the address bus and the input byte is written into the corresponding location of memory. Finally the byte counter and register pair HL are decremented.

M CYCLES: 4 T STATES: 16(4,5,3,4) 4 MHZ E.T.: 4.00

Condition Bits Affected:

S: Unknown
 Z: Set if B-1=0;
 reset otherwise
 H: Unknown
 P/V: Unknown
 N: Set
 C: Not affected

Example:

If the contents of register C are 07H, the contents of register B are 10H, the contents of the HL register pair are 1000H, and the byte 7BH is available at the

peripheral device mapped to I/O port address 07H, then after the execution of

IND

memory location 1000H will contain 7BH, the HL register pair will contain 0FFFH, and register B will contain 0FH.

Operation: (HL) ← (C), B ← B-1, HL ← HL-1

Format:

Opcode

INDR

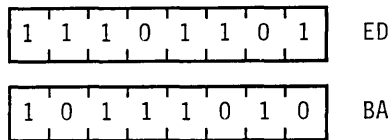

Description:

The contents of register C are placed on the bottom half (A0 through A7) of the address bus to select the I/O device at one of 256 possible ports. Register B is used as a byte counter, and its contents are placed on the top half (A8 through A15) of the address bus at this time. Then one byte from the selected port is placed on the data bus and written to the CPU. The contents of the HL register pair are placed on the address bus and the input byte is written into the corresponding location of memory. Then HL and the byte counter are decremented. If decrementing causes B to go to zero, the instruction is terminated. If B is not zero, the PC is decremented by two and the instruction repeated. Interrupts will be recognized and two refresh cycles will be executed after each data transfer. Note that if B is set to zero prior to instruction execution, 256 bytes of data will be input.

If B ≠ 0:

M CYCLES: 5 T STATES: 21(4,5,3,4,5) 4 MHZ E.T.: 5.25

If B = 0:

M CYCLES: 4 T STATES: 16(4,5,3,4) 4 MHZ E.T.: 4.00

Condition Bits Affected:

S: Unknown
Z: Set
H: Unknown
P/V: Unknown
N: Set
C: Not affected

Example:

If the contents of register C are 07H, the contents of register B are 03H, the contents of the HL register pair are 1000H, and the following sequence of bytes are available at the peripheral device mapped to I/O port address 07H:

51H
A9H
03H

then after the execution of

INDR

the HL register pair will contain OFFDH, register B will contain zero, and memory locations will have contents as follows:

Location	Contents
OFFEH	03H
OFFFH	A9H
1000H	51H

OUT (n), A

Operation: (n) ← A

Format:

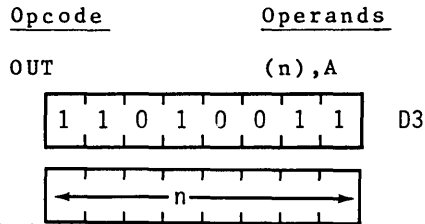

Description:

The operand n is placed on the bottom half (A0 through A7) of the address bus to select the I/O device at one of 256 possible ports. The contents of the Accumulator (register A) also appear on the top half (A8 through A15) of the address bus at this time. Then the byte contained in the Accumulator is placed on the data bus and written into the selected peripheral device.

M CYCLES: 3 T STATES: 11(4,3,4) 4 MHZ E.T.: 2.75

Condition Bits Affected: None

Example:

If the contents of the Accumulator are 23H, then after the execution of

OUT (01H),A

the byte 23H will have been written to the peripheral device mapped to I/O port address 01H.

OUT (C), r

Operation: (C) ← r

Format:

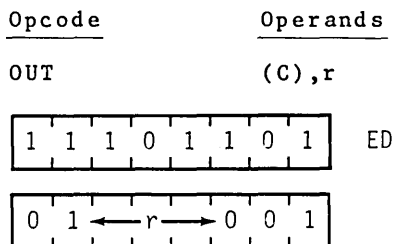

Description:

The contents of register C are placed on the bottom half (A0 through A7) of the address bus to select the I/O device at one of 256 possible ports. The contents of Register B are placed on the top half (A8 through A15) of the address bus at this time. Then the byte contained in register r is placed on the data bus and written into the selected peripheral device. Register r identifies any of the CPU registers shown in the following table, which also shows the corresponding 3-bit "r" field for each which appears in the assembled object code:

<u>Register</u>	<u>r</u>
B	000
C	001
D	010
E	011
H	100
L	101
A	111

M CYCLES: 3 T STATES: 12(4,4,4) 4 MHZ E.T.: 3.00

Condition Bits Affected: None

Example:

If the contents of register C are 01H and the contents of register D are 5AH, after the execution of

OUT (C),D

the byte 5AH will have been written to the peripheral device mapped to I/O port address 01H.

OUTI

Operation: (C) ← (HL), B ← B-1, HL ← HL + 1

Format:

Opcode

OUTI

1	1	1	0	1	1	0	1
---	---	---	---	---	---	---	---

 ED

1	0	1	0	0	0	1	1
---	---	---	---	---	---	---	---

 A3

Description:

The contents of the HL register pair are placed on the address bus to select a location in memory. The byte contained in this memory location is temporarily stored in the CPU. Then, after the byte counter (B) is decremented, the contents of register C are placed on the bottom half (A0 through A7) of the address bus to select the I/O device at one of 256 possible ports. Register B may be used as a byte counter, and its decremented value is placed on the top half (A8 through A15) of the address bus. The byte to be output is placed on the data bus and written into selected peripheral device. Finally the register pair HL is incremented.

M CYCLES: 4 T STATES: 16(4,5,3,4) 4 MHZ E.T.: 4.00

Condition Bits Affected:

S: Unknown
Z: Set if B-1=0;
reset otherwise
H: Unknown
P/V: Unknown
N: Set
C: Not affected

Example:

If the contents of register C are 07H, the contents of register B are 10H, the contents of the HL register pair are 1000H, and the contents of memory address 1000H are

59H, then after the execution of

OUTI

register B will contain 0FH, the HL register pair will contain 1001H, and the byte 59H will have been written to the peripheral device mapped to I/O port address 07H.

OTIR

Operation: (C) ← (HL), B ← B-1, HL ← HL + 1

Format:

Opcode

OTIR

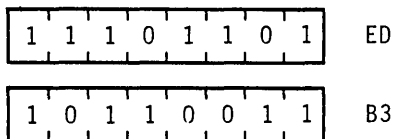

Description:

The contents of the HL register pair are placed on the address bus to select a location in memory. The byte contained in this memory location is temporarily stored in the CPU. Then, after the byte counter (B) is decremented, the contents of register C are placed on the bottom half (A0 through A7) of the address bus to select the I/O device at one of 256 possible ports. Register B may be used as a byte counter, and its decremented value is placed on the top half (A8 through A15) of the address bus at this time. Next the byte to be output is placed on the data bus and written into the selected peripheral device. Then register pair HL is incremented. If the decremented B register is not zero, the Program Counter (PC) is decremented by 2 and the instruction is repeated. If B has gone to zero, the instruction is terminated. Interrupts will be recognized and two refresh cycles will be executed after each data transfer. Note that if B is set to zero prior to instruction execution, the instruction will output 256 bytes of data.

If B ≠ 0:

M CYCLES: 5 T STATES: 21(4,5,3,4,5) 4 MHZ E.T.: 5.25

If B = 0:

M CYCLES: 4 T STATES: 16(4,5,3,4) 4 MHZ E.T.: 4.00

Condition Bits Affected:

S: Unknown
Z: Set
H: Unknown
P/V: Unknown
N: Set
C: Not affected

Example:

If the contents of register C are 07H, the contents of register B are 03H, the contents of the HL register pair are 1000H, and memory locations have the following contents:

Location	Contents
1000H	51H
1001H	A9H
1002H	03H

then after the execution of

OTIR

the HL register pair will contain 1003H, register B will contain zero, and a group of bytes will have been written to the peripheral device mapped to I/O port address 07H in the following sequence:

51H
A9H
03H

OUTD

Operation: (C) ← (HL), B ← B-1, HL ← HL-1

Format:

Opcode

OUTD

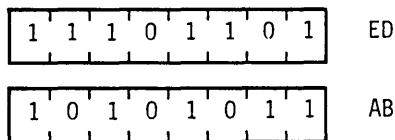

Description:

The contents of the HL register pair are placed on the address bus to select a location in memory. The byte contained in this memory location is temporarily stored in the CPU. Then, after the byte counter (B) is decremented, the contents of register C are placed on the bottom half (A0 through A7) of the address bus to select the I/O device at one of 256 possible ports. Register B may be used as a byte counter, and its decremented value is placed on the top half (A8 through A15) of the address bus at this time. Next the byte to be output is placed on the data bus and written into the selected peripheral device. Finally the register pair HL is decremented.

M CYCLES: 4 T STATES: 16(4,5,3,4) 4 MHZ E.T.: 4.00

Condition Bits Affected:

S: Unknown
Z: Set if B-1=0;
 reset otherwise
H: Unknown
P/V: Unknown
N: Set
C: Not affected

Example:

If the contents of register C are 07H, the contents of

register B are 10H, the contents of the HL register pair are 1000H, and the contents of memory location 1000H are 59H, after the execution of

OUTD

register B will contain 0FH, the HL register pair will contain OFFFH, and the byte 59H will have been written to the peripheral device mapped to I/O port address 07H.

OTDR

Operation: (C) ← (HL), B ← B-1, HL ← HL-1

Format:

Opcode

OTDR

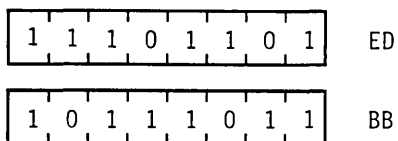

Description:

The contents of the HL register pair are placed on the address bus to select a location in memory. The byte contained in this memory location is temporarily stored in the CPU. Then, after the byte counter (B) is decremented, the contents of register C are placed on the bottom half (A0 through A7) of the address bus to select the I/O device at one of 256 possible ports. Register B may be used as a byte counter, and its decremented value is placed on the top half (A8 through A15) of the address bus at this time. Next the byte to be output is placed on the data bus and written into the selected peripheral device. Then register pair HL is decremented and if the decremented B register is not zero, the Program Counter (PC) is decremented by 2 and the instruction is repeated. If B has gone to zero, the instruction is terminated. Interrupts will be recognized and two refresh cycles will be executed after each data transfer. Note that if B is set to zero prior to instruction execution, the instruction will output 256 bytes of data.

If B≠0:

M CYCLES: 5 T STATES: 21(4,5,3,4,5) 4 MHZ E.T.: 5.25

If B=0:

M CYCLES: 4 T STATES: 16(4,5,3,4) 4 MHZ E.T.: 4.00

Condition Bits Affected:

S: Unknown
Z: Set
H: Unknown
P/V: Unknown
N: Set
C: Not affected

Example:

If the contents of register C are 07H, the contents of register B are 03H, the contents of the HL register pair are 1000H, and memory locations have the following contents:

Location	Contents
OFFEH	51H
OFFFH	A9H
1000H	03H

then after the execution of

OTDR

the HL register pair will contain OFFDH, register B will contain zero, and a group of bytes will have been written to the peripheral device mapped to I/O port address 07H in the following sequence:

03H
A9H
51H

Z80-CPU INSTRUCTION SET

ALPHABETICAL ASSEMBLY MNEMONIC	OPERATION	PAGE
ADC HL,ss	Add with Carry Reg. pair ss to HL.....	149
ADC A,s	Add with carry operand s to Acc.....	108
ADD A,n	Add value n to Acc.....	102
ADD A,r	Add Reg. r to Acc.....	100
ADD A,(HL)	Add location (HL) to Acc.....	103
ADD A,(IX+d)	Add location (IX+d) to Acc.....	104
ADD A,(IY+d)	Add location (IY+d) to Acc.....	106
ADD HL,ss	Add Reg. pair ss to HL.....	147
ADD IX,pp	Add Reg. pair pp to IX.....	153
ADD IY,rr	Add Reg. pair rr to IY.....	155
AND s	Logical 'AND' of operand s and Acc.....	114
BIT b,(HL)	Test BIT b of location (HL).....	205
BIT b,(IX+d)	Test BIT b of location (IX+d).....	207
BIT b,(IY+d)	Test BIT b of location (IY+d).....	209
BIT b,r	Test BIT b of Reg. r.....	203
CALL cc,nn	Call subroutine at location nn if condition cc is true.....	240
CALL nn	Unconditional call subroutine at location nn.....	238
CCF	Complement carry flag.....	137
CP s	Compare operand s with Acc.....	120
CPD	Compare location (HL) and Acc. decrement HL and BC.....	95
CPDR	Compare location (HL) and Acc. decrement HL and BC, repeat until BC=0.....	97
CPI	Compare location (HL) and Acc. increment HL and decrement BC.....	91
CPIR	Compare location (HL) and Acc. increment HL, decrement BC repeat until BC=0.....	93
CPL	Complement Acc. (1's comp).....	134
DAA	Decimal adjust Acc.....	132
DEC m	Decrement operand m.....	129
DEC IX	Decrement IX.....	161
DEC IY	Decrement IY.....	162
DEC ss	Decrement Reg. pair ss.....	160
DI	Disable interrupts.....	141
DJNZ e	Decrement B and Jump relative if B=0.....	235
EI	Enable interrupts.....	142
EX (SP),HL	Exchange the location (SP) and HL.....	80

EX (SP),IX	Exchange the location (SP) and IX	81
EX (SP),IY	Exchange the location (SP) and IY	82
EX AF,AF'	Exchange the contents of AF and AF'	78
EX DE,HL	Exchange the contents of DE and HL	77
EXX	Exchange the contents of BC,DE,HL with contents of BC',DE',HL' respectively	79
HALT	HALT (wait for interrupt or reset)	140
IM 0	Set interrupt mode 0	143
IM 1	Set interrupt mode 1	144
IM 2	Set interrupt mode 2	145
IN A,(n)	Load the Acc. with input from device n	253
IN r,(C)	Load the Reg. r with input from device (C)	254
INC (HL)	Increment location (HL)	124
INC IX	Increment IX	158
INC (IX+d)	Increment location (IX+d)	125
INC IY	Increment IY	159
INC (IY+d)	Increment location (IY+d)	127
INC r	Increment Reg. r	122
INC ss	Increment Reg. pair ss	157
IND	Load location (HL) with input from port (C), decrement HL and B	260
INDR	Load location (HL) with input from port (C), decrement HL and decrement B, repeat until B=0	262
INI	Load location (HL) with input from port (C); and increment HL and decrement B	256
INIR	Load location (HL) with input from port (C), increment HL and decrement B, repeat until B=0	258
JP (HL)	Unconditional Jump to (HL)	232
JP (IX)	Unconditional Jump to (IX)	233
JP (IY)	Unconditional Jump to (IY)	234
JP cc,nn	Jump to location nn if condition cc is true	221
JP nn	Unconditional jump to location nn	220
JR C,e	Jump relative to PC+e if carry=1	224
JR e	Unconditional Jump relative to PC+e	223
JR NC,e	Jump relative to PC+e if carry=0	226

JR NZ,e	Jump relative to PC+e if non zero (Z=0).....	230
JR Z,e	Jump relative to PC+e if zero (Z=1).....	228
LD A,(BC)	Load Acc. with location (BC).....	42
LD A,(DE)	Load Acc. with location (DE).....	43
LD A,I	Load Acc. with I.....	48
LD A,(nn)	Load Acc. with location nn.....	44
LD A,R	Load Acc. with Reg. R.....	49
LD (BC),A	Load location (BC) with Acc.....	45
LD (DE),A	Load location (DE) with Acc.....	46
LD (HL),n	Load location (HL) with value n.....	39
LD dd,nn	Load Reg. pair dd with value nn.....	53
LD dd,(nn)	Load Reg. pair dd with location (nn).....	57
LD HL,(nn)	Load HL with location (nn).....	56
LD (HL),r	Load location (HL) with Reg. r.....	34
LD I,A	Load I with Acc.....	50
LD IX,nn	Load IX with value nn.....	54
LD IX,(nn)	Load IX with location (nn).....	59
LD (IX+d),n	Load location (IX+d) with value n.....	40
LD (IX+d),r	Load location (IX+d) with Reg. r.....	35
LD IY,nn	Load IY with value nn.....	55
LD IY,(nn)	Load IY with location (nn).....	60
LD (IY+d),n	Load location (IY+d) with value n.....	41
LD (IY+d),r	Load location (IY+d) with Reg. r.....	37
LD (nn),A	Load location (nn) with Acc.....	47
LD (nn),dd	Load location (nn) with Reg. pair dd.....	62
LD (nn),HL	Load location (nn) with HL.....	61
LD (nn),IX	Load location (nn) with IX.....	64
LD (nn),IY	Load location (nn) with IY.....	65
LD R,A	Load R with Acc.....	51
LD r,(HL)	Load Reg. r with location (HL).....	29
LD r,(IX+d)	Load Reg. r with location (IX+d).....	30
LD r,(IY+d)	Load Reg. r with location (IY+d).....	32
LD r,n	Load Reg. r with value n.....	28
LD r,r'	Load Reg. r with Reg. r'.....	27
LD SP,HL	Load SP with HL.....	66
LD SP,IX	Load SP with IX.....	67
LD SP,IY	Load SP with IY.....	68
LDD	Load location (DE) with location (HL), decrement DE,HL and BC.....	87
LDDR	Load location (DE) with location (HL), decrement DE,HL and BC; repeat until BC=0.....	89

LDI	Load location (DE) with location (HL), increment DE,HL, decrement BC.....	83
LDIR	Load location (DE) with location (HL), increment DE,HL, decrement BC and repeat until BC=0.....	85
NEG	Negate Acc. (2's complement).....	135
NOP	No operation.....	139
OR s	Logical 'OR' of operand s and Acc.....	116
OTDR	Load output port (C) with location (HL), decrement HL and B, repeat until B=0.....	273
OTIR	Load output port (C) with location (HL), increment HL, decrement B, repeat until B=0.....	269
OUT (C),r	Load output port (C) with Reg. r.....	265
OUT (n),A	Load output port (n) with Acc.....	264
OUTD	Load output port (C) with location (HL), decrement HL and B.....	271
OUTI	Load output port (C) with location (HL), increment HL and decrement B.....	267
POP IX	Load IX with top of stack.....	74
POP IY	Load IY with top of stack.....	75
POP qq	Load Reg. pair qq with top of stack.....	72
PUSH IX	Load IX onto stack.....	70
PUSH IY	Load IY onto stack.....	71
PUSH qq	Load Reg. pair qq onto stack.....	69
RES b,m	Reset Bit b of operand m.....	217
RET	Return from subroutine.....	243
RET cc	Return from subroutine if condition cc is true.....	244
RETI	Return from interrupt.....	246
RETN	Return from non maskable interrupt.....	248
RL m	Rotate left through carry operand m.....	180
RLA	Rotate left Acc. through carry.....	166
RLC (HL)	Rotate location (HL) left circular.....	174
RLC (IX+d)	Rotate location (IX+d) left circular.....	176
RLC (IY+d)	Rotate location (IY+d) left circular.....	178
RLC r	Rotate Reg. r left circular.....	172
RLCA	Rotate left circular Acc.....	164
RLD	Rotate digit left and right between Acc. and location (HL).....	198
RR m	Rotate right through carry operand m.....	186
RRA	Rotate right Acc. through carry.....	170
RRC m	Rotate operand m right circular.....	183

RRCA	Rotate right circular Acc.....	168
RRD	Rotate digit right and left between Acc. and location (HL).....	200
RST p	Restart to location p.....	250
SBC A,s	Subtract operand s from Acc. with carry.....	112
SBC HL,ss	Subtract Reg. pair ss from HL with carry.....	151
SCF	Set carry flag (C=1).....	138
SET b,(HL)	Set Bit b of location (HL).....	212
SET b,(IX+d)	Set Bit b of location (IX+d).....	213
SET b,(IY+d)	Set Bit b of location (IY+d).....	215
SET b,r	Set Bit b of Reg. r.....	211
SLA m	Shift operand m left arithmetic.....	189
SRA m	Shift operand m right arithmetic.....	192
SRL m	Shift operand m right logical.....	195
SUB s	Subtract operand s from Acc.....	110
XOR s	Exclusive 'OR' operand s and Acc.....	118

APPENDIX A
ERROR MESSAGES AND EXPLANATIONS

- 1) WARNING - OPCODE REDEFINED
Indicates that an opcode has been redefined by a macro so that future uses of the opcode will result in the appropriate macro call. This message may be suppressed by the NOW option.
- 2) NAME CONTAINS INVALID CHARACTERS
Indicates that a name (either a label or an operand) contains illegal characters. Names must start with an alphabetic character and any following characters must be either alphanumeric (A...Z or 0...9), a question mark (?) or an underbar ().
- 3) INVALID OPCODE
Indicates that the opcode was not recognized. Occurs when the opcode contains an illegal character (including non-printing control characters), when the opcode is not either all upper case or all lower case, or when macros are used and the M option is not specified.
- 4) INVALID NUMBER
Indicates an invalid character in a number. Occurs when a number contains an illegal character (including non-printing control characters) or a number contains a digit not allowed in the specified base (e.g., 8 or 9 in an octal number or a letter in a hexadecimal number where the trailing H was omitted.)
- 5) INVALID OPERATOR
Indicates use of an invalid operator in an expression. Occurs when an operator such as AND or XOR is misspelled or contains illegal characters.
- 6) SYNTAX ERROR
Indicates the syntax of the statement is invalid. Occurs when an expression is incorrectly formed, unmatched parenthesis are found in an operand field, or a DEFM string is either too long (greater than 63 characters) or contains unbalanced quotes.
- 7) ASSEMBLER ERROR
Indicates that the assembler has failed to process this instruction. Usually occurs when an expression is incorrectly formed.
- 8) UNDEFINED SYMBOL
Indicates that a symbol in an operand field

- was never defined. Occurs when a name is misspelled or not declared as a label for an instruction or pseudo-op.
- 9) INVALID OPERAND COMBINATION
Indicates that the operand combination for this opcode is invalid. Occurs when a register name or condition code is misspelled or incorrectly used with the particular opcode.
 - 10) EXPRESSION OUT OF RANGE
Indicates that the value of an expression is either too large or too small for the appropriate quantity. Occurs on 16-bit arithmetic overflow or division by zero in an expression, incrementing the reference counter beyond a 16-bit value, or trying to use a value which will not fit into a particular bit-field - typically a byte.
 - 11) MULTIPLE DECLARATION
Indicates that an attempt was made to redefine a label. Occurs when a label is misspelled, or mistakenly used several times. The pseudo-op DEFL can be used to assign a value to a label which can then be redefined by another DEFL.
 - 12) MACRO DEFINITION ERROR
Indicates that a macro is incorrectly defined. Occurs when the M option is not specified but macros are used, when a macro is defined within another macro definition, when the parameters are not correctly specified, or an unrecognized parameter is found in the macro body.
 - 13) UNBALANCED QUOTES
Indicates that a string is not properly bounded by single quote marks or quote marks inside a string are not properly matched in pairs.
 - 14) ASSEMBLER COMMAND ERROR
Indicates that an assembler command is not recognized or is incorrectly formed. The command must begin with an asterisk (*) in column one, the first letter identifies the command, and any parameters such as 'ON', 'OFF' or a filename must be properly delimited. The command will be ignored.
 - 15) MACRO EXPANSION ERROR
Indicates that the expansion of a single line in a macro has overflowed the expansion buffer. Occurs when substitution of parameter causes the line to increase in length beyond the capacity of the buffer (currently 128

- bytes). The line will be truncated.
- 16) **MACRO STACK OVERFLOW**
Indicates that the depth of nesting of macro calls has exceeded the macro parameter stack buffer capacity. Occurs when the sum of the parameter string lengths (plus some additional information for each macro call) is longer than the buffer (currently 256 bytes), which often happens if infinitely recursive macro calls are used. The macro call which caused the error will be ignored.
 - 17) **INCLUDE NESTED TOO DEEP**
Indicates that a *Include command was found which would have caused a nesting of included source files to a depth greater than four, where the original source file is considered to be level one. The command will be ignored.
 - 18) **GLOBAL DEFINITION ERROR**
Indicates that either a label was present on a GLOBAL pseudo-op statement, or there was an attempt to give an absolute value to a GLOBAL symbol in a relocatable module. The latter case is not allowed since all GLOBALS in a relocatable module will be relocated by the Linker. May occur either after a GLOBAL pseudo-op or after an EQU or DEFL statement which is attempting to absolutize a relocatable GLOBAL symbol.
 - 19) **EXTERNAL DEFINITION ERROR**
Indicates that either a label was present on an EXTERNAL pseudo-op statement, or there was an attempt to declare a symbol to be EXTERNAL which had previously been defined within the module to have an absolute value. May occur due to a misspelling or other oversight.
 - 20) **NAME DECLARED GLOBAL AND EXTERNAL**
Indicates that the name was found in both a GLOBAL pseudo-op and an EXTERNAL pseudo-op which is contradictory. May occur due to a misspelling or other oversight.
 - 21) **LABEL DECLARED AS EXTERNAL**
Indicates that a name has been declared in both an EXTERNAL pseudo-op and as a label in this module. May occur due to a misspelling or other oversight.
 - 22) **INVALID EXTERNAL EXPRESSION**
Indicates that a symbol name which has been declared in an EXTERNAL pseudo-op is improperly used in an expression. May occur when invalid arithmetic operators are applied to an external expression or when the mode of

- an operand must be either absolute or relocatable.
- 23) **INVALID RELOCATABLE EXPRESSION**
Indicates that an expression which contains a relocatable value (either a label or the reference counter symbol \$ in a relocatable module) is improperly formed or used. May occur when invalid arithmetic operators are applied to a relocatable expression or when the mode of an operand must be absolute. Remember that all relocatable values (addresses) must be represented in 16 bits.
 - 24) **EXPRESSION MUST BE ABSOLUTE**
Indicates that the mode of an expression is not absolute when it should be. May occur when a relocatable or external expression is used to specify a quantity that must be either constant or representable in less than 16 bits.
 - 25) **UNDEFINED GLOBAL(S)**
Indicates that one or more symbols which were declared in a GLOBAL pseudo-op were never actually defined as a label in this module. May occur due to a misspelling or other oversight.
 - 26) **WARNING - ORG IS RELOCATABLE**
Indicates that an ORG statement was encountered in a relocatable module. This warning is issued to remind the user that the reference counter is set to a relocatable value, not an absolute one. May occur when the Absolute option is not specified for an absolute module. This warning may be suppressed by the NOW option.

APPENDIX B
INSTRUCTION SET ALPHABETICAL ORDER

Z-80 CROSS ASSEMBLER VERSION 1.06 OF 06/18/76
07/09/76 10:22:47 OPCODE LISTING

LUC	OBJ CODE	STMT	SOURCE STATEMENT	LOC	OBJ CODE	STMT	SOURCE STATEMENT
0000	8E	1	ADC A,(HL)	007C	CB56	70	BIT 2,(HL)
0001	DD8E05	2	ADC A,(IX+IND)	007E	DDCB0556	71	BIT 2,(IX+IND)
0004	FD8E05	3	ADC A,(IY+IND)	0082	FDCB0556	72	BIT 2,(IY+IND)
0007	8F	4	ADC A,A	0086	CB57	73	BIT 2,A
0008	88	5	ADC A,B	0088	CB50	74	BIT 2,B
0009	89	6	ADC A,C	008A	CB51	75	BIT 2,C
000A	8A	7	ADC A,D	008C	CB52	76	BIT 2,D
000B	8B	8	ADC A,E	008E	CB53	77	BIT 2,E
000C	8C	9	ADC A,H	0090	CB54	78	BIT 2,H
000D	8D	10	ADC A,L	0092	CB55	79	BIT 2,L
000E	CE20	11	ADC A,N	0094	CB5E	80	BIT 3,(HL)
0010	ED4A	12	ADC HL,BC	0096	DDCB055E	81	BIT 3,(IX+IND)
0012	ED5A	13	ADC HL,DE	009A	FDCB055E	82	BIT 3,(IY+IND)
0014	ED6A	14	ADC HL,HL	009E	CB5F	83	BIT 3,A
0016	ED7A	15	ADC HL,SP	00A0	CB58	84	BIT 3,B
0018	86	16	ADD A,(HL)	00A2	CB59	85	BIT 3,C
0019	DD8605	17	ADD A,(IX+IND)	00A4	CB5A	86	BIT 3,D
001C	FD8605	18	ADD A,(IY+IND)	00A6	CB5B	87	BIT 3,E
001F	87	19	ADD A,A	00A8	CB5C	88	BIT 3,H
0020	80	20	ADD A,B	00AA	CB5D	89	BIT 3,L
0021	81	21	ADD A,C	00AC	CB66	90	BIT 4,(HL)
0022	82	22	ADD A,D	00AE	DDCB0566	91	BIT 4,(IX+IND)
0023	83	23	ADD A,E	00B2	FDCB0566	92	BIT 4,(IY+IND)
0024	84	24	ADD A,H	00B6	CB67	93	BIT 4,A
0025	85	25	ADD A,L	00B8	CB60	94	BIT 4,B
0026	C620	26	ADD A,N	00BA	CB61	95	BIT 4,C
0028	09	27	ADD HL,BC	00BC	CB62	96	BIT 4,D
0029	19	28	ADD HL,DE	00BE	CB63	97	BIT 4,E
002A	29	29	ADD HL,HL	00C0	CB64	98	BIT 4,H
002B	39	30	ADD HL,SP	00C2	CB65	99	BIT 4,L
002C	DD09	31	ADD IX,BC	00C4	CB6E	100	BIT 5,(HL)
002E	DD19	32	ADD IX,DE	00C6	DDCB056E	101	BIT 5,(IX+IND)
0030	DD29	33	ADD IX,IX	00CA	FDCB056E	102	BIT 5,(IY+IND)
0032	DD39	34	ADD IX,SP	00CE	CB6F	103	BIT 5,A
0034	FD09	35	ADD IY,BC	00D0	CB68	104	BIT 5,B
0036	FD19	36	ADD IY,DE	00D2	CB69	105	BIT 5,C
0038	FD29	37	ADD IY,IY	00D4	CB6A	106	BIT 5,D
003A	FD39	38	ADD IY,SP	00D6	CB6B	107	BIT 5,E
003C	A6	39	AND (HL)	00D8	CB6C	108	BIT 5,H
003D	DDA605	40	AND (IX+IND)	00DA	CB6D	109	BIT 5,L
0040	FDA605	41	AND (IY+IND)	00DC	CB76	110	BIT 6,(HL)
0043	A7	42	AND A	00DE	DDCB0576	111	BIT 6,(IX+IND)
0044	A0	43	AND B	00E2	FDCB0576	112	BIT 6,(IY+IND)
0045	A1	44	AND C	00E6	CB77	113	BIT 6,A
0046	A2	45	AND D	00E8	CB70	114	BIT 6,B
0047	A3	46	AND E	00EA	CB71	115	BIT 6,C
0048	A4	47	AND H	00EC	CB72	116	BIT 6,D
0049	A5	48	AND L	00EE	CB73	117	BIT 6,E
004A	E620	49	AND N	00F0	CB74	118	BIT 6,H
004C	CB46	50	BIT 0,(HL)	00F2	CB75	119	BIT 6,L
004E	DDCB0546	51	BIT 0,(IX+IND)	00F4	CB7E	120	BIT 7,(HL)
0052	FDCB0546	52	BIT 0,(IY+IND)	00F6	DDCB057E	121	BIT 7,(IX+IND)
0056	CB47	53	BIT 0,A	00FA	FDCB057E	122	BIT 7,(IY+IND)
0058	CB40	54	BIT 0,B	00FE	CB7F	123	BIT 7,A
005A	CB41	55	BIT 0,C	0100	CB78	124	BIT 7,B
005C	CB42	56	BIT 0,D	0102	CB79	125	BIT 7,C
005E	CB43	57	BIT 0,E	0104	CB7A	126	BIT 7,D
0060	CB44	58	BIT 0,H	0106	CB7B	127	BIT 7,E
0062	CB45	59	BIT 0,L	0108	CB7C	128	BIT 7,H
0064	CB4E	60	BIT 1,(HL)	010A	CB7D	129	BIT 7,L
0066	DDCB054E	61	BIT 1,(IX+IND)	010C	DC8405	130	CALL C,NN
006A	FDCB054E	62	BIT 1,(IY+IND)	010F	FC8405	131	CALL M,NN
006E	CB4F	63	BIT 1,A	0112	D48405	132	CALL NC,NN
0070	CB48	64	BIT 1,B	0115	CD8405	133	CALL NN
0072	CB49	65	BIT 1,C	0118	C48405	134	CALL NZ,NN
0074	CB4A	66	BIT 1,D	011B	F48405	135	CALL P,NN
0076	CB4B	67	BIT 1,E	011E	EC8405	136	CALL PE,NN
0078	CB4C	68	BIT 1,H	0121	E48405	137	CALL PO,NN
007A	CB4D	69	BIT 1,L	0124	CC8405	138	CALL Z,NN

Z-80 CROSS ASSEMBLER				VERSION 1.06 OF 06/18/76			
07/09/76 10:22:47		OPCODE LISTING					
LOC	OBJ CODE	STMT	SOURCE STATEMENT	LOC	OBJ CODE	STMT	SOURCE STATEMENT
0127	3F	139	CCF	018F	2C	208	INC L
0128	BE	140	CP (HL)	0190	33	209	INC SP
0129	DDBE05	141	CP (IX+IND)	0191	EDAA	210	IND
012C	FDBE05	142	CP (IY+IND)	0193	EDBA	211	INDR
012F	BF	143	CP A	0195	EDA2	212	INI
0130	88	144	CP B	0197	E0B2	213	INIR
0131	89	145	CP C	0199	E9	214	JP (HL)
0132	BA	146	CP D	019A	DDE9	215	JP (IX)
0133	BB	147	CP E	019C	FDE9	216	JP (IY)
0134	BC	148	CP H	019E	DA8405	217	JP C,NN
0135	BD	149	CP L	01A1	FA8405	218	JP M,NN
0136	FE20	150	CP N	01A4	D28405	219	JP NC,NN
0138	EDA9	151	CPD	01A7	C38405	220	JP NN
013A	EDB9	152	CPDR	01AA	C28405	221	JP NZ,NN
013C	EDA1	153	CPI	01AD	F28405	222	JP P,NN
013E	EDB1	154	CPIR	01B0	EA8405	223	JP PE,NN
0140	2F	155	CPL	01B3	E28405	224	JP PO,NN
0141	27	156	DAA	01B6	CA8405	225	JP Z,NN
0142	35	157	DEC (HL)	01B9	382E	226	JR C,DIS
0143	DD3505	158	DEC (IX+IND)	01BB	182E	227	JR DIS
0146	FD3505	159	DEC (IY+IND)	01BD	302E	228	JR NC,DIS
0149	3D	160	DEC A	01BF	202E	229	JR NZ,DIS
014A	05	161	DEC B	01C1	282E	230	JR Z,DIS
014B	0B	162	DEC BC	01C3	02	231	LD (BC),A
014C	0D	163	DEC C	01C4	12	232	LD (DE),A
014D	15	164	DEC D	01C5	77	233	LD (HL),A
014E	1B	165	DEC DE	01C6	70	234	LD (HL),B
014F	1D	166	DEC E	01C7	71	235	LD (HL),C
0150	25	167	DEC H	01C8	72	236	LD (HL),D
0151	2B	168	DEC HL	01C9	73	237	LD (HL),E
0152	DD2B	169	DEC IX	01CA	74	238	LD (HL),H
0154	FD2B	170	DEC IY	01CB	75	239	LD (HL),L
0156	2D	171	DEC L	01CC	3620	240	LD (HL),N
0157	3B	172	DEC SP	01CE	DD7705	241	LD (IX+IND),A
0158	F3	173	DI	01D1	DD7005	242	LD (IX+IND),B
0159	102E	174	DJNZ DIS	01D4	DD7105	243	LD (IX+IND),C
015B	FB	175	EI	01D7	DD7205	244	LD (IX+IND),D
015C	E3	176	EX (SP),HL	01DA	DD7305	245	LD (IX+IND),E
015D	DDE3	177	EX (SP),IX	01DD	DD7405	246	LD (IX+IND),H
015F	FDE3	178	EX (SP),IY	01E0	DD7505	247	LD (IX+IND),L
0161	08	179	EX AF,AF'	01E3	DD360520	248	LD (IX+IND),N
0162	EB	180	EX DE,HL	01E7	FD7705	249	LD (IY+IND),A
0163	D9	181	EXX	01EA	FD7005	250	LD (IY+IND),B
0164	76	182	HALT	01ED	FD7105	251	LD (IY+IND),C
0165	ED46	183	IM 0	01F0	FD7205	252	LD (IY+IND),D
0167	ED56	184	IM 1	01F3	FD7305	253	LD (IY+IND),E
0169	ED5E	185	IM 2	01F6	FD7405	254	LD (IY+IND),H
016B	ED78	186	IN A,(C)	01F9	FD7505	255	LD (IY+IND),L
016D	DB20	187	IN A,(N)	01FC	FD360520	256	LD (IY+IND),N
016F	ED40	188	IN B,(C)	0200	328405	257	LD (NN),A
0171	ED48	189	IN C,(C)	0203	ED438405	258	LD (NN),BC
0173	ED50	190	IN D,(C)	0207	ED538405	259	LD (NN),DE
0175	ED58	191	IN E,(C)	020B	228405	260	LD (NN),HL
0177	ED60	192	IN H,(C)	020E	DD228405	261	LD (NN),IX
0179	ED68	193	IN L,(C)	0212	FD228405	262	LD (NN),IY
017B	34	194	INC (HL)	0216	ED738405	263	LD (NN),SP
017C	DD3405	195	INC (IX+IND)	021A	0A	264	LD A,(BC)
017F	FD3405	196	INC (IY+IND)	021B	1A	265	LD A,(DE)
0182	3C	197	INC A	021C	7E	266	LD A,(HL)
0183	04	198	INC B	021D	DD7E05	267	LD A,(IX+IND)
0184	03	199	INC BC	0220	FD7E05	268	LD A,(IY+IND)
0185	0C	200	INC C	0223	3A8405	269	LD A,(NN)
0186	14	201	INC D	0226	7F	270	LD A,A
0187	13	202	INC DE	0227	78	271	LD A,B
0188	1C	203	INC E	0228	79	272	LD A,C
0189	24	204	INC H	0229	7A	273	LD A,D
018A	23	205	INC HL	022A	7B	274	LD A,E
018B	DD23	206	INC IX	022B	7C	275	LD A,H
018D	FD23	207	INC IY	022C	ED57	276	LD A,I

LOC	OBJ CODE	STMT	SOURCE STATEMENT	LOC	OBJ CODE	STMT	SOURCE STATEMENT
022E	7D	277	LD A,L	02A8	DD6E05	346	LD L,(IX+IND)
022F	3E20	278	LD A,N	02AB	FD6E05	347	LD L,(IY+IND)
0231	46	279	LD B,(HL)	02AE	6F	348	LD L,A
0232	DD4605	280	LD B,(IX+IND)	02AF	68	349	LD L,B
0235	FD4605	281	LD B,(IY+IND)	02B0	69	350	LD L,C
0238	47	282	LD B,A	02B1	6A	351	LD L,D
0239	40	283	LD B,B	02B2	6B	352	LD L,E
023A	41	284	LD B,C	02B3	6C	353	LD L,H
023B	42	285	LD B,D	02B4	6D	354	LD L,L
023C	43	286	LD B,E	02B5	2E20	355	LD L,N
023D	44	287	LD B,H,NN	02B7	ED7B8405	356	LD SP,(NN)
023E	45	288	LD B,L	02B8	F9	357	LD SP,HL
023F	0620	289	LD B,N	02BC	DDF9	358	LD SP,IX
0241	ED4B8405	290	LD BC,(NN)	02BE	DDF9	359	LD SP,IY
0245	018405	291	LD BC,NN	02C0	318405	360	LD SP,NN
0248	4E	292	LD C,(HL)	02C3	EDA8	361	LDD
0249	DD4E05	293	LD C,(IX+IND)	02C5	ED88	362	LDOR
024C	FD4E05	294	LD C,(IY+IND)	02C7	EDA0	363	LDI
024F	4F	295	LD C,A	02C9	EDB0	364	LDIR
0250	48	296	LD C,B	02CB	ED44	365	NEG
0251	49	297	LD C,C	02CD	00	366	NOP
0252	4A	298	LD C,D	02CE	B6	367	OR (HL)
0253	4B	299	LD C,E	02CF	DDB605	368	OR (IX+IND)
0254	4C	300	LD C,H	02D2	FDB605	369	OR (IY+IND)
0255	4D	301	LD C,L	02D5	B7	370	OR A
0256	0E20	302	LD C,N	02D6	B0	371	OR B
0258	56	303	LD D,(HL)	02D7	B1	372	OR C
0259	DD5605	304	LD D,(IX+IND)	02D8	B2	373	OR D
025C	FD5605	305	LD D,(IY+IND)	02D9	B3	374	OR E
025F	57	306	LD D,A	02DA	B4	375	OR H
0260	50	307	LD D,B	02DB	B5	376	OR L
0261	51	308	LD D,C	02DC	F620	377	OR N
0262	52	309	LD D,D	02DE	ED88	378	OTDR
0263	53	310	LD D,E	02E0	EDB3	379	OTIR
0264	54	311	LD D,H	02E2	ED79	380	OUT (C),A
0265	55	312	LD D,L	02E4	ED41	381	OUT (C),B
0266	1620	313	LD D,N	02E6	ED49	382	OUT (C),C
0268	ED5B8405	314	LD DE,(NN)	02E8	ED51	383	OUT (C),D
026C	118405	315	LD DE,NN	02EA	ED59	384	OUT (C),E
026F	5E	316	LD E,(HL)	02EC	ED61	385	OUT (C),H
0270	DD5E05	317	LD E,(IX+IND)	02EE	ED69	386	OUT (C),L
0273	FD5E05	318	LD E,(IY+IND)	02F0	D320	387	OUT N,A
0276	5F	319	LD E,A	02F2	EDAB	388	OUTD
0277	58	320	LD E,B	02F4	EDA3	389	OUTI
0278	59	321	LD E,C	02F6	F1	390	POP AF
0279	5A	322	LD E,D	02F7	C1	391	POP BC
027A	5B	323	LD E,E	02F8	D1	392	POP DE
027B	5C	324	LD E,H	02F9	E1	393	POP HL
027C	5D	325	LD E,L	02FA	DDE1	394	POP IX
027D	1E20	326	LD E,N	02FC	FDE1	395	POP IY
027F	66	327	LD H,(HL)	02FE	F5	396	PUSH AF
0280	DD6605	328	LD H,(IX+IND)	02FF	C5	397	PUSH BC
0283	FD6605	329	LD H,(IY+IND)	0300	D5	398	PUSH DE
0286	67	330	LD H,A	0301	E5	399	PUSH HL
0287	60	331	LD H,B	0302	DDE5	400	PUSH IX
0288	61	332	LD H,C	0304	FDE5	401	PUSH IY
0289	62	333	LD H,D	0306	C886	402	RES 0,(HL)
028A	63	334	LD H,E	0308	DDCB0586	403	RES 0,(IX+IND)
028B	64	335	LD H,H	030C	FDCB0586	404	RES 0,(IY+IND)
028C	65	336	LD H,L	0310	C887	405	RES 0,A
028D	2620	337	LD H,N	0312	C880	406	RES 0,B
028F	2A8405	338	LD HL,(NN)	0314	C881	407	RES 0,C
0292	218405	339	LD HL,NN	0316	C882	408	RES 0,D
0295	ED47	340	LD I,A	0318	C883	409	RES 0,E
0297	DD2A8405	341	LD IX,(NN)	031A	C884	410	RES 0,H
029B	DD218405	342	LD IX,NN	031C	C885	411	RES 0,L
029F	FD2A8405	343	LD IY,(NN)	031E	C88E	412	RES 1,(HL)
02A3	FD218405	344	LD IY,NN	0320	DDCB058E	413	RES 1,(IX+IND)
02A7	6E	345	LD L,(HL)	0324	FDCB058E	414	RES 1,(IY+IND)

Z-80 CROSS ASSEMBLER VERSION 1.06 OF 06/18/76

07/09/76 10:22:47

OPCODE LISTING

LOC	OBJ CODE	STMT	SOURCE STATEMENT	LOC	OBJ CODE	STMT	SOURCE STATEMENT
0328	CB8F	415	RES 1,A	03C8	F8	484	RET M
032A	CB88	416	RES 1,B	03C9	D0	485	RET NC
032C	CB89	417	RES 1,C	03CA	C0	486	RET NZ
032E	CB8A	418	RES 1,D	03CB	F0	487	RET P
0330	CB8B	419	RES 1,E	03CC	E6	488	RET PE
0332	CB8C	420	RES 1,H	03CD	E0	489	RET PO
0334	CB8D	421	RES 1,L	03CE	C8	490	RET Z
0336	CB96	422	RES 2,(HL)	03CF	ED4D	491	RETI
0338	DDCB0596	423	RES 2,(IX+IND)	03D1	ED45	492	RETN
033C	FDCB0596	424	RES 2,(IY+IND)	03D3	CB16	493	RL (HL)
0340	CB97	425	RES 2,A	03D5	DDCB0516	494	RL (IX+IND)
0342	CB90	426	RES 2,B	03D9	FDCB0516	495	RL (IY+IND)
0344	CB91	427	RES 2,C	03DD	CB17	496	RL A
0346	CB92	428	RES 2,D	03DF	CB10	497	RL B
0348	CB93	429	RES 2,E	03E1	CB11	498	RL C
034A	CB94	430	RES 2,H	03E3	CB12	499	RL D
034C	CB95	431	RES 2,L	03E5	CB13	500	RL E
034E	CB9E	432	RES 3,(HL)	03E7	CB14	501	RL H
0350	DDCB059E	433	RES 3,(IX+IND)	03E9	CB15	502	RL L
0354	FDCB059E	434	RES 3,(IY+IND)	03EB	17	503	RLA
0358	CB9F	435	RES 3,A	03EC	CB06	504	RLC (HL)
035A	CB98	436	RES 3,B	03EE	DDCB0506	505	RLC (IX+IND)
035C	CB99	437	RES 3,C	03F2	FDCB0506	506	RLC (IY+IND)
035E	CB9A	438	RES 3,D	03F6	CB07	507	RLC A
0360	CB9B	439	RES 3,E	03F8	CB00	508	RLC B
0362	CB9C	440	RES 3,H	03FA	CB01	509	RLC C
0364	CB9D	441	RES 3,L	03FC	CB02	510	RLC D
0366	CBAA	442	RES 4,(HL)	03FE	CB03	511	RLC E
0368	DDCB05AA	443	RES 4,(IX+IND)	0400	CB04	512	RLC H
036C	FDCB05AA	444	RES 4,(IY+IND)	0402	CB05	513	RLC L
0370	CBAT	445	RES 4,A	0404	07	514	RLCA
0372	CBAA	446	RES 4,B	0405	ED6F	515	RLO
0374	CBAB	447	RES 4,C	0407	CB1E	516	RR (HL)
0376	CBAA	448	RES 4,D	0409	DDCB051E	517	RR (IX+IND)
0378	CBAA	449	RES 4,E	040D	FDCB051E	518	RR (IY+IND)
037A	CBAA	450	RES 4,H	0411	CB1F	519	RR A
037C	CBAA	451	RES 4,L	0413	CB18	520	RR B
037E	CBAA	452	RES 5,(HL)	0415	CB19	521	RR C
0380	DDCB05AA	453	RES 5,(IX+IND)	0417	CB1A	522	RR D
0384	FDCB05AA	454	RES 5,(IY+IND)	0419	CB1B	523	RR E
0388	CBAA	455	RES 5,A	041B	CB1C	524	RR H
038A	CBAA	456	RES 5,B	041D	CB1D	525	RR L
038C	CBAA	457	RES 5,C	041F	1F	526	RRA
038E	CBAA	458	RES 5,D	0420	CB0E	527	RRC (HL)
0390	CBAA	459	RES 5,E	0422	DDCB050E	528	RRC (IX+IND)
0392	CBAC	460	RES 5,H	0426	FDCB050E	529	RRC (IY+IND)
0394	CBAD	461	RES 5,L	042A	CB0F	530	RRC A
0396	CB86	462	RES 6,(HL)	042C	CB08	531	RRC B
0398	DDCB05B6	463	RES 6,(IX+IND)	042E	CB09	532	RRC C
039C	FDCB05B6	464	RES 6,(IY+IND)	0430	CB0A	533	RRC D
03A0	CB87	465	RES 6,A	0432	CB0B	534	RRC E
03A2	CB80	466	RES 6,B	0434	CB0C	535	RRC H
03A4	CB81	467	RES 6,C	0436	CB0D	536	RRC L
03A6	CB82	468	RES 6,D	0438	0F	537	RRCA
03A8	CB83	469	RES 6,E	0439	ED67	538	RRD
03AA	CB84	470	RES 6,H	043B	C7	539	RST 0
03AC	CB85	471	RES 6,L	043C	D7	540	RST 10H
03AE	CB8E	472	RES 7,(HL)	043D	DF	541	RST 18H
03B0	DDCB05BE	473	RES 7,(IX+IND)	043E	E7	542	RST 20H
03B4	FDCB05BE	474	RES 7,(IY+IND)	043F	EF	543	RST 28H
03B8	CB8F	475	RES 7,A	0440	F7	544	RST 30H
03BA	CB88	476	RES 7,B	0441	FF	545	RST 38H
03BC	CB89	477	RES 7,C	0442	CF	546	RST 8
03BE	CB8A	478	RES 7,D	0443	9E	547	SBC A,(HL)
03C0	CB8B	479	RES 7,E	0444	DD9E05	548	SBC A,(IX+IND)
03C2	CB8C	480	RES 7,H	0447	FD9E05	549	SBC A,(IY+IND)
03C4	CB8D	481	RES 7,L	044A	9F	550	SBC A,A
03C6	C9	482	RET	044B	98	551	SBC A,B
03C7	D8	483	RET C	044C	99	552	SBC A,C

07/09/76 10:22:47

OPCODE LISTING

LOC	OBJ CODE	STMT	SOURCE STATEMENT	LOC	OBJ CODE	STMT	SOURCE STATEMENT
044D	9A	553	SBC A,D	04EA	CBED	622	SET 5,L
044E	9B	554	SBC A,E	04EC	CBF6	623	SET 6,(HL)
044F	9C	555	SBC A,H	04EE	DDCB05F6	624	SET 6,(IX+IND)
0450	9D	556	SBC A,L	04F2	FDCB05F6	625	SET 6,(IY+IND)
0451	DE20	557	SBC A,N	04F6	CBF7	626	SET 6,A
0453	ED42	558	SBC HL,BC	04F8	CBF0	627	SET 6,B
0455	ED52	559	SBC HL,DE	04FA	CBF1	628	SET 6,C
0457	ED62	560	SBC HL,HL	04FC	CBF2	629	SET 6,D
0459	ED72	561	SBC HL,SP	04FE	CBF3	630	SET 6,E
045B	37	562	SCF	0500	CBF4	631	SET 6,H
045C	CBC6	563	SET 0,(HL)	0502	CBF5	632	SET 6,L
045E	DDCB05C6	564	SET 0,(IX+IND)	0504	CBFE	633	SET 7,(HL)
0462	FDCB05C6	565	SET 0,(IY+IND)	0506	DDCB05FE	634	SET 7,(IX+IND)
0466	CBC7	566	SET 0,A	050A	FDCB05FE	635	SET 7,(IY+IND)
0468	CBC0	567	SET 0,B	050E	CBFF	636	SET 7,A
046A	CBC1	568	SET 0,C	0510	CBF8	637	SET 7,B
046C	CBC2	569	SET 0,D	0512	CBF9	638	SET 7,C
046E	CBC3	570	SET 0,E	0514	CBFA	639	SET 7,D
0470	CBC4	571	SET 0,H	0516	CBFB	640	SET 7,E
0472	CBC5	572	SET 0,L	0518	CBFC	641	SET 7,H
0474	CBCE	573	SET 1,(HL)	051A	CBFD	642	SET 7,L
0476	DDCB05CE	574	SET 1,(IX+IND)	051C	CB26	643	SLA (HL)
047A	FDCB05CE	575	SET 1,(IY+IND)	051E	DDCB0526	644	SLA (IX+IND)
047E	CBCF	576	SET 1,A	0522	FDCB0526	645	SLA (IY+IND)
0480	CBC8	577	SET 1,B	0526	CB27	646	SLA A
0482	CBC9	578	SET 1,C	0528	CB20	647	SLA B
0484	CBCA	579	SET 1,D	052A	CB21	648	SLA C
0486	CBCB	580	SET 1,E	052C	CB22	649	SLA D
0488	CBCC	581	SET 1,H	052E	CB23	650	SLA E
048A	CBCD	582	SET 1,L	0530	CB24	651	SLA H
048C	CBD6	583	SET 2,(HL)	0532	CB25	652	SLA L
048E	DDCB05D6	584	SET 2,(IX+IND)	0534	CB2E	653	SRA (HL)
0492	FDCB05D6	585	SET 2,(IY+IND)	0536	DDCB052E	654	SRA (IX+IND)
0496	CB07	586	SET 2,A	053A	FDCB052E	655	SRA (IY+IND)
0498	CB00	587	SET 2,B	053E	CB2F	656	SRA A
049A	CB01	588	SET 2,C	0540	CB28	657	SRA B
049C	CB02	589	SET 2,D	0542	CB29	658	SRA C
049E	CB03	590	SET 2,E	0544	CB2A	659	SRA D
04A0	CB04	591	SET 2,H	0546	CB2B	660	SRA E
04A2	CB05	592	SET 2,L	0548	CB2C	661	SRA H
04A4	CB08	593	SET 3 B	054A	CB2D	662	SRA L
04A6	CBDE	594	SET 3,(HL)	054C	CB3E	663	SRL (HL)
04A8	DDCB05DE	595	SET 3,(IX+IND)	054E	DDCB053E	664	SRL (IX+IND)
04AC	FDCB05DE	596	SET 3,(IY+IND)	0552	FDCB053E	665	SRL (IY+IND)
04B0	CBDF	597	SET 3,A	0556	CB3F	666	SRL A
04B2	CB09	598	SET 3,C	0558	CB38	667	SRL B
04B4	CBDA	599	SET 3,D	055A	CB39	668	SRL C
04B6	CBDB	600	SET 3,E	055C	CB3A	669	SRL D
04B8	CBDC	601	SET 3,H	055E	CB3B	670	SRL E
04BA	CBDD	602	SET 3,L	0560	CB3C	671	SRL H
04BC	CBE6	603	SET 4,(HL)	0562	CB3D	672	SRL L
04BE	DDCB05E6	604	SET 4,(IX+IND)	0564	96	673	SUB (HL)
04C2	FDCB05E6	605	SET 4,(IY+IND)	0565	DD9605	674	SUB (IX+IND)
04C6	CBE7	606	SET 4,A	0568	FD9605	675	SUB (IY+IND)
04C8	CBE0	607	SET 4,B	056B	97	676	SUB A
04CA	CBE1	608	SET 4,C	056C	90	677	SUB B
04CC	CBE2	609	SET 4,D	056D	91	678	SUB C
04CE	CBE3	610	SET 4,E	056E	92	679	SUB D
04D0	CBE4	611	SET 4,H	056F	93	680	SUB E
04D2	CBE5	612	SET 4,L	0570	94	681	SUB H
04D4	CBE6	613	SET 5,(HL)	0571	95	682	SUB L
04D6	DDCB05EE	614	SET 5,(IX+IND)	0572	D620	683	SUB N
04DA	FDCB05EE	615	SET 5,(IY+IND)	0574	AE	684	XOR (HL)
04DE	CBEF	616	SET 5,A	0575	DDAE05	685	XOR (IX+IND)
04E0	CBE8	617	SET 5,B	0578	FDAE05	686	XOR (IY+IND)
04E2	CBE9	618	SET 5,C	057B	AF	687	XOR A
04E4	CBEA	619	SET 5,D	057C	A8	688	XOR B
04E6	CBEB	620	SET 5,E	057D	A9	689	XOR C
04E8	CBEC	621	SET 5,H	057E	AA	690	XOR D

057F	AB	691	XOR	E
0580	AC	692	XOR	H
0581	AD	693	XOR	L
0582	EE20	694	XOR	N
0584		695	NN DEFS	2
		696	IND EQU	5
		697	M EQU	10H
		698	N EQU	20H
		699	DIS EQU	30H
		700	END	

APPENDIX C
INSTRUCTION SET NUMERICAL ORDER

Z-80 CROSS ASSEMBLER VERSION 1.06 OF 06/18/76							
07/09/76	10:20:50	.OPCODE LISTING					
LOC	OBJ CODE	STMT	SOURCE STATEMENT	LOC	OBJ CODE	STMT	SOURCE STATEMENT
0000	00	1	NOP	0063	45	70	LD B,L
0001	018405	2	LD BC,NN	0064	46	71	LD B,(HL)
0004	02	3	LD (BC),A	0065	47	72	LD B,A
0005	03	4	INC BC	0066	48	73	LD C,B
0006	04	5	INC B	0067	49	74	LD C,C
0007	05	6	DEC B	0068	4A	75	LD C,D
0008	0620	7	LD B,N	0069	4B	76	LD C,E
000A	07	8	RLCA	006A	4C	77	LD C,H
0008	08	9	EX AF,AF'	006B	4D	78	LD C,L
000C	09	10	ADD HL,BC	006C	4E	79	LD C,(HL)
000D	0A	11	LD A,(BC)	006D	4F	80	LD C,A
000E	0B	12	DEC BC	006E	50	81	LD D,B
000F	0C	13	INC C	006F	51	82	LD D,C
0010	0D	14	DEC C	0070	52	83	LD D,D
0011	0E20	15	LD C,N	0071	53	84	LD D,E
0013	0F	16	RRC A	0072	54	85	LD D,H
0014	102E	17	DJNZ DIS	0073	55	86	LD D,L
0016	118405	18	LD DE,NN	0074	56	87	LD D,(HL)
0019	12	19	LD (DE),A	0075	57	88	LD D,A
001A	13	20	INC DE	0076	58	89	LD E,B
001B	14	21	INC D	0077	59	90	LD E,C
001C	15	22	DEC D	0078	5A	91	LD E,D
001D	1620	23	LD D,N	0079	5B	92	LD E,E
001F	17	24	RLA	007A	5C	93	LD E,H
0020	182E	25	JR DIS	007B	5D	94	LD E,L
0022	19	26	ADD HL,DE	007C	5E	95	LD E,(HL)
0023	1A	27	LD A,(DE)	007D	5F	96	LD E,A
0024	1B	28	DEC DE	007E	60	97	LD H,B
0025	1C	29	INC E	007F	61	98	LD H,C
0026	1D	30	DEC E	0080	62	99	LD H,D
0027	1E20	31	LD E,N	0081	63	100	LD H,E
0029	1F	32	RRA	0082	64	101	LD H,H
002A	202E	33	JR NZ,DIS	0083	65	102	LD H,L
002C	218405	34	LD HL,NN	0084	66	103	LD H,(HL)
002F	228405	35	LD (NN),HL	0085	67	104	LD H,A
0032	23	36	INC HL	0086	68	105	LD L,B
0033	24	37	INC H	0087	69	106	LD L,C
0034	25	38	DEC H	0088	6A	107	LD L,D
0035	2620	39	LD H,N	0089	6B	108	LD L,E
0037	27	40	DAA	008A	6C	109	LD L,H
0038	282E	41	JR Z,DIS	008B	6D	110	LD L,L
003A	29	42	ADD HL,HL	008C	6E	111	LD L,(HL)
003B	2A8405	43	LD HL,(NN)	008D	6F	112	LD L,A
003E	2B	44	DEC HL	008E	70	113	LD (HL),B
003F	2C	45	INC L	008F	71	114	LD (HL),C
0040	2D	46	DEC L	0090	72	115	LD (HL),D
0041	2E20	47	LD L,N	0091	73	116	LD (HL),E
0043	2F	48	CPL	0092	74	117	LD (HL),H
0044	302E	49	JR NC,DIS	0093	75	118	LD (HL),L
0046	318405	50	LD SP,NN	0094	76	119	HALT
0049	328405	51	LD (NN),A	0095	77	120	LD (HL),A
004C	33	52	INC SP	0096	78	121	LD A,B
004D	34	53	INC (HL)	0097	79	122	LD A,C
004E	35	54	DEC (HL)	0098	7A	123	LD A,D
004F	3620	55	LD (HL),N	0099	7B	124	LD A,E
0051	37	56	SCF	009A	7C	125	LD A,H
0052	382E	57	JR C,DIS	009B	7D	126	LD A,L
0054	39	58	ADD HL,SP	009C	7E	127	LD A,(HL)
0055	3A8405	59	LD A,(NN)	009D	7F	128	LD A,A
0058	3B	60	DEC SP	009E	80	129	ADD A,B
0059	3C	61	INC A	009F	81	130	ADD A,C
005A	3D	62	DEC A	00A0	82	131	ADD A,D
005B	3E20	63	LD A,N	00A1	83	132	ADD A,E
005D	3F	64	CCF	00A2	84	133	ADD A,H
005E	40	65	LD B,B	00A3	85	134	ADD A,L
005F	41	66	LD B,C	00A4	86	135	ADD A,(HL)
0060	42	67	LD B,D	00A5	87	136	ADD A,A
0061	43	68	LD B,E	00A6	88	137	ADC A,B
0062	44	69	LD B,H,NN	00A7	89	138	ADC A,C

LOC	OBJ CODE	STMT	SOURCE STATEMENT	LOC	OBJ CODE	STMT	SOURCE STATEMENT
00A8	8A	139	ADC A,D	00FB	D0	208	RET NC
00A9	8B	140	ADC A,E	00FC	D1	209	POP DE
00AA	8C	141	ADC A,H	00FD	D28405	210	JP NC,NN
00AB	8D	142	ADC A,L	0100	D320	211	OUT N,A
00AC	8E	143	ADC A,(HL)	0102	D48405	212	CALL NC,NN
00AD	8F	144	ADC A,A	0105	D5	213	PUSH DE
00AE	90	145	SUB B	0106	D620	214	SUB N
00AF	91	146	SUB C	0108	D7	215	RST 10H
00B0	92	147	SUB D	0109	D8	216	RET C
00B1	93	148	SUB E	010A	D9	217	EXX
00B2	94	149	SUB H	010B	DA8405	218	JP C,NN
00B3	95	150	SUB L	010E	DB20	219	IN A,N
00B4	96	151	SUB (HL)	0110	DC8405	220	CALL C,NN
00B5	97	152	SUB A	0113	DE20	221	SBC A,N
00B6	98	153	SBC A,B	0115	DF	222	RST 18H
00B7	99	154	SBC A,C	0116	E0	223	RET PO
00B8	9A	155	SBC A,D	0117	E1	224	POP HL
00B9	9B	156	SBC A,E	0118	E28405	225	JP PO,NN
00BA	9C	157	SBC A,H	011B	E3	226	EX (SP),HL
00BB	9D	158	SBC A,L	011C	E48405	227	CALL PO,NN
00BC	9E	159	SBC A,(HL)	011F	E5	228	PUSH HL
00BD	9F	160	SBC A,A	0120	E620	229	AND N
00BE	AO	161	AND B	0122	E7	230	RST 20H
00BF	A1	162	AND C	0123	E8	231	RET PE
00C0	A2	163	AND D	0124	E9	232	JP (HL)
00C1	A3	164	AND E	0125	EA8405	233	JP PE,NN
00C2	A4	165	AND H	0128	EB	234	EX DE,HL
00C3	A5	166	AND L	0129	EC8405	235	CALL PE,NN
00C4	A6	167	AND (HL)	012C	EE20	236	XOR N
00C5	A7	168	AND A	012E	EF	237	RST 28H
00C6	A8	169	XOR B	012F	F0	238	RET P
00C7	A9	170	XOR C	0130	F1	239	POP AF
00C8	AA	171	XOR D	0131	F28405	240	JP P,NN
00C9	AB	172	XOR E	0134	F3	241	DI
00CA	AC	173	XOR H	0135	F48405	242	CALL P,NN
00CB	AD	174	XOR L	0138	F5	243	PUSH AF
00CC	AE	175	XOR (HL)	0139	F620	244	OR N
00CD	AF	176	XOR A	013B	F7	245	RST 30H
00CE	B0	177	OR B	013C	F8	246	RET M
00CF	B1	178	OR C	013D	F9	247	LD SP,HL
00D0	B2	179	OR D	013E	FA8405	248	JP M,NN
00D1	B3	180	OR E	0141	FB	249	EI
00D2	B4	181	OR H	0142	FC8405	250	CALL M,NN
00D3	B5	182	OR L	0145	FE20	251	CP N
00D4	B6	183	OR (HL)	0147	FF	252	RST 38H
00D5	B7	184	OR A	0148	CB00	253	RLC B
00D6	B8	185	CP B	014A	CB01	254	RLC C
00D7	B9	186	CP C	014C	CB02	255	RLC D
00D8	BA	187	CP D	014E	CB03	256	RLC E
00D9	BB	188	CP E	0150	CB04	257	RLC H
00DA	BC	189	CP H	0152	CB05	258	RLC L
00DB	BD	190	CP L	0154	CB06	259	RLC (HL)
00DC	BE	191	CP (HL)	0156	CB07	260	RLC A
00DD	BF	192	CP A	0158	CB08	261	RRC B
00DE	CO	193	RET NZ	015A	CB09	262	RRC C
00DF	C1	194	POP BC	015C	CB0A	263	RRC D
00E0	C28405	195	JP NZ,NN	015E	CB0B	264	RRC E
00E3	C38405	196	JP NN	0160	CB0C	265	RRC H
00E6	C48405	197	CALL NZ,NN	0162	CB0D	266	RRC L
00E9	C5	198	PUSH BC	0164	CB0E	267	RRC (HL)
00EA	C620	199	ADD A,N	0166	CB0F	268	RRC A
00EC	C7	200	RST 0	0168	CB10	269	RL B
00ED	C8	201	RET Z	016A	CB11	270	RL C
00EE	C9	202	RET	016C	CB12	271	RL D
00EF	CA8405	203	JP Z,NN	016E	CB13	272	RL E
00F2	CC8405	204	CALL Z,NN	0170	CB14	273	RL H
00F5	CD8405	205	CALL NN	0172	CB15	274	RL L
00F8	CE20	206	ADC A,N	0174	CB16	275	RL (HL)
00FA	CF	207	RST 8	0176	CB17	276	RL A

LOC	OBJ CODE	STMT	SOURCE STATEMENT	LOC	OBJ CODE	STMT	SOURCE STATEMENT
0178	CB18	277	RR B	0202	CB65	346	BIT 4,L
017A	CB19	278	RR C	0204	CB66	347	BIT 4,(HL)
017C	CB1A	279	RR D	0206	CB67	348	BIT 4,A
017E	CB1B	280	RR E	0208	CB68	349	BIT 5,B
0180	CB1C	281	RR H	020A	CB69	350	BIT 5,C
0182	CB1D	282	RR L	020C	CB6A	351	BIT 5,D
0184	CB1E	283	RR (HL)	020E	CB6B	352	BIT 5,E
0186	CB1F	284	RR A	0210	CB6C	353	BIT 5,H
0188	CB20	285	SLA B	0212	CB6D	354	BIT 5,L
018A	CB21	286	SLA C	0214	CB6E	355	BIT 5,(HL)
018C	CB22	287	SLA D	0216	CB6F	356	BIT 5,A
018E	CB23	288	SLA E	0218	CB70	357	BIT 6,B
0190	CB24	289	SLA H	021A	CB71	358	BIT 6,C
0192	CB25	290	SLA L	021C	CB72	359	BIT 6,D
0194	CB26	291	SLA (HL)	021E	CB73	360	BIT 6,E
0196	CB27	292	SLA A	0220	CB74	361	BIT 6,H
0198	CB28	293	SRA B	0222	CB75	362	BIT 6,L
019A	CB29	294	SRA C	0224	CB76	363	BIT 6,(HL)
019C	CB2A	295	SRA D	0226	CB77	364	BIT 6,A
019E	CB2B	296	SRA E	0228	CB78	365	BIT 7,B
01A0	CB2C	297	SRA H	022A	CB79	366	BIT 7,C
01A2	CB2D	298	SRA L	022C	CB7A	367	BIT 7,D
01A4	CB2E	299	SRA (HL)	022E	CB7B	368	BIT 7,E
01A6	CB2F	300	SRA A	0230	CB7C	369	BIT 7,H
01A8	CB38	301	SRL B	0232	CB7D	370	BIT 7,L
01AA	CB39	302	SRL C	0234	CB7E	371	BIT 7,(HL)
01AC	CB3A	303	SRL D	0236	CB7F	372	BIT 7,A
01AE	CB3B	304	SRL E	0238	CB80	373	RES 0,B
01B0	CB3C	305	SRL H	023A	CB81	374	RES 0,C
01B2	CB3D	306	SRL L	023C	CB82	375	RES 0,D
01B4	CB3E	307	SRL (HL)	023E	CB83	376	RES 0,E
01B6	CB3F	308	SRL A	0240	CB84	377	RES 0,H
01B8	CB40	309	BIT 0,B	0242	CB85	378	RES 0,L
01BA	CB41	310	BIT 0,C	0244	CB86	379	RES 0,(HL)
01BC	CB42	311	BIT 0,D	0246	CB87	380	RES 0,A
01BE	CB43	312	BIT 0,E	0248	CB88	381	RES 1,B
01C0	CB44	313	BIT 0,H	024A	CB89	382	RES 1,C
01C2	CB45	314	BIT 0,L	024C	CB8A	383	RES 1,D
01C4	CB46	315	BIT 0,(HL)	024E	CB8B	384	RES 1,E
01C6	CB47	316	BIT 0,A	0250	CB8C	385	RES 1,H
01C8	CB48	317	BIT 1,B	0252	CB8D	386	RES 1,L
01CA	CB49	318	BIT 1,C	0254	CB8E	387	RES 1,(HL)
01CC	CB4A	319	BIT 1,D	0256	CB8F	388	RES 1,A
01CE	CB4B	320	BIT 1,E	0258	CB90	389	RES 2,B
01D0	CB4C	321	BIT 1,H	025A	CB91	390	RES 2,C
01D2	CB4D	322	BIT 1,L	025C	CB92	391	RES 2,D
01D4	CB4E	323	BIT 1,(HL)	025E	CB93	392	RES 2,E
01D6	CB4F	324	BIT 1,A	0260	CB94	393	RES 2,H
01D8	CB50	325	BIT 2,B	0262	CB95	394	RES 2,L
01DA	CB51	326	BIT 2,C	0264	CB96	395	RES 2,(HL)
01DC	CB52	327	BIT 2,D	0266	CB97	396	RES 2,A
01DE	CB53	328	BIT 2,E	0268	CB98	397	RES 2,B
01E0	CB54	329	BIT 2,H	026A	CB99	398	RES 2,C
01E2	CB55	330	BIT 2,L	026C	CB9A	399	RES 2,D
01E4	CB56	331	BIT 2,(HL)	026E	CB9B	400	RES 2,E
01E6	CB57	332	BIT 2,A	0270	CB9C	401	RES 2,H
01E8	CB58	333	BIT 2,B	0272	CB9D	402	RES 2,L
01EA	CB59	334	BIT 2,C	0274	CB9E	403	RES 2,(HL)
01EC	CB5A	335	BIT 2,D	0276	CB9F	404	RES 2,A
01EE	CB5B	336	BIT 2,E	0278	CB9A	405	RES 2,B
01F0	CB5C	337	BIT 2,H	027A	CBA1	406	RES 2,C
01F2	CB5D	338	BIT 2,L	027C	CBA2	407	RES 2,D
01F4	CB5E	339	BIT 2,(HL)	027E	CBA3	408	RES 2,E
01F6	CB5F	340	BIT 2,A	0280	CBA4	409	RES 2,H
01F8	CB60	341	BIT 2,B	0282	CBA5	410	RES 2,L
01FA	CB61	342	BIT 2,C	0284	CBA6	411	RES 2,(HL)
01FC	CB62	343	BIT 2,D	0286	CBA7	412	RES 2,A
01FE	CB63	344	BIT 2,E	0288	CBA8	413	RES 2,B
0200	CB64	345	BIT 2,H	028A	CBA9	414	RES 2,C

LOC	OBJ CODE	STMT	SOURCE STATEMENT	LOC	OBJ CODE	STMT	SOURCE STATEMENT
028C	CBAA	415	RES 5,D	0316	CBEF	484	SET 5,A
028E	CBAB	416	RES 5,E	0318	CBF0	485	SET 6,B
0290	CBAC	417	RES 5,H	031A	CBF1	486	SET 6,C
0292	CBAD	418	RES 5,L	031C	CBF2	487	SET 6,D
0294	CBAE	419	RES 5,(HL)	031E	CBF3	488	SET 6,E
0296	CBAF	420	RES 5,A	0320	CBF4	489	SET 6,H
0298	CB80	421	RES 6,B	0322	CBF5	490	SET 6,L
029A	CB81	422	RES 6,C	0324	CBF6	491	SET 6,(HL)
029C	CB82	423	RES 6,D	0326	CBF7	492	SET 6,A
029E	CB83	424	RES 6,E	0328	CBF8	493	SET 7,B
02A0	CB84	425	RES 6,H	032A	CBF9	494	SET 7,C
02A2	CB85	426	RES 6,L	032C	CBFA	495	SET 7,D
02A4	CB86	427	RES 6,(HL)	032E	CBFB	496	SET 7,E
02A6	CB87	428	RES 6,A	0330	CBFC	497	SET 7,H
02A8	CB88	429	RES 7,B	0332	CBFD	498	SET 7,L
02AA	CB89	430	RES 7,C	0334	CBFE	499	SET 7,(HL)
02AC	CB8A	431	RES 7,D	0336	CBFF	500	SET 7,A
02AE	CB8B	432	RES 7,E	0338	DD09	501	ADD IX,BC
02B0	CB8C	433	RES 7,H	033A	DD19	502	ADD IX,DE
02B2	CB8D	434	RES 7,L	033C	DD218405	503	LD IX,NN
02B4	CB8E	435	RES 7,(HL)	0340	DD228405	504	LD (NN),IX
02B6	CB8F	436	RES 7,A	0344	DD23	505	INC IX
02B8	CB90	437	SET 0,B	0346	DD29	506	ADD IX,IX
02BA	CB91	438	SET 0,C	0348	DD2A8405	507	LD IX,(NN)
02BC	CB92	439	SET 0,D	034C	DD2B	508	DEC IX
02BE	CB93	440	SET 0,E	034E	DD3405	509	INC (IX+IND)
02C0	CB94	441	SET 0,H	0351	DD3505	510	DEC (IX+IND)
02C2	CB95	442	SET 0,L	0354	DD360520	511	LD (IX+IND),N
02C4	CB96	443	SET 0,(HL)	0358	DD39	512	ADD IX,SP
02C6	CB97	444	SET 0,A	035A	DD4605	513	LD B,(IX+IND)
02C8	CB98	445	SET 1,B	035D	DD4E05	514	LD C,(IX+IND)
02CA	CB99	446	SET 1,C	0360	DD5605	515	LD D,(IX+IND)
02CC	CB9A	447	SET 1,D	0363	DD5E05	516	LD E,(IX+IND)
02CE	CB9B	448	SET 1,E	0366	DD6605	517	LD H,(IX+IND)
02D0	CB9C	449	SET 1,H	0369	DD6E05	518	LD L,(IX+IND)
02D2	CB9D	450	SET 1,L	036C	DD7005	519	LD (IX+IND),B
02D4	CB9E	451	SET 1,(HL)	036F	DD7105	520	LD (IX+IND),C
02D6	CB9F	452	SET 1,A	0372	DD7205	521	LD (IX+IND),D
02D8	CB00	453	SET 2,B	0375	DD7305	522	LD (IX+IND),E
02DA	CB01	454	SET 2,C	0378	DD7405	523	LD (IX+IND),H
02DC	CB02	455	SET 2,D	037B	DD7505	524	LD (IX+IND),L
02DE	CB03	456	SET 2,E	037E	DD7705	525	LD (IX+IND),A
02E0	CB04	457	SET 2,H	0381	DD7E05	526	LD A,(IX+IND)
02E2	CB05	458	SET 2,L	0384	DD8605	527	ADD A,(IX+IND)
02E4	CB06	459	SET 2,(HL)	0387	DD8E05	528	ADC A,(IX+IND)
02E6	CB07	460	SET 2,A	038A	DD9605	529	SUB (IX+IND)
02E8	CB08	461	SET 3 B	038D	DD9E05	530	SBC A,(IX+IND)
02EA	CB09	462	SET 3,C	0390	DDA605	531	AND (IX+IND)
02EC	CB0A	463	SET 3,D	0393	DDAE05	532	XOR (IX+IND)
02EE	CB0B	464	SET 3,E	0396	DDB605	533	OR (IX+IND)
02F0	CB0C	465	SET 3,H	0399	DDBE05	534	CP (IX+IND)
02F2	CB0D	466	SET 3,L	039C	DDE1	535	POP IX
02F4	CBDE	467	SET 3,(HL)	039E	DDE3	536	EX (SP),IX
02F6	CBDF	468	SET 3,A	03A0	DDE5	537	PUSH IX
02F8	CBE0	469	SET 4,B	03A2	DDE9	538	JP (IX)
02FA	CBE1	470	SET 4,C	03A4	DDF9	539	LD SP,IX
02FC	CBE2	471	SET 4,D	03A6	DDCB0506	540	RLC (IX+IND)
02FE	CBE3	472	SET 4,E	03AA	DDCB050E	541	RRC (IX+IND)
0300	CBE4	473	SET 4,H	03AE	DDCB0516	542	RL (IX+IND)
0302	CBE5	474	SET 4,L	03B2	DDCB051E	543	RR (IX+IND)
0304	CBE6	475	SET 4,(HL)	03B6	DDCB0526	544	SLA (IX+IND)
0306	CBE7	476	SET 4,A	03BA	DDCB052E	545	SRA (IX+IND)
0308	CBE8	477	SET 5,B	03BE	DDCB053E	546	SRL (IX+IND)
030A	CBE9	478	SET 5,C	03C2	DDCB0546	547	BIT 0,(IX+IND)
030C	CBEA	479	SET 5,D	03C6	DDCB054E	548	BIT 1,(IX+IND)
030E	CBEB	480	SET 5,E	03CA	DDCB0556	549	BIT 2,(IX+IND)
0310	CBEC	481	SET 5,H	03CE	DDCB055E	550	BIT 3,(IX+IND)
0312	CBED	482	SET 5,L	03D2	DDCB0566	551	BIT 4,(IX+IND)
0314	CBEE	483	SET 5,(HL)	03D6	DDCB056E	552	BIT 5,(IX+IND)

Z-80 CROSS ASSEMBLER				VERSION 1.06				OF 06/18/76			
07/09/76 10:20:50		.OPCODE LISTING									
LOC	OBJ CODE	STMT	SOURCE STATEMENT	LOC	OBJ CODE	STMT	SOURCE STATEMENT	LOC	OBJ CODE	STMT	SOURCE STATEMENT
03DA	DDCB0576	553	BIT 6,(IX+IND)	0494	E0B9	622	CPDR				
03DE	DDCB057E	554	BIT 7,(IX+IND)	0496	EDBA	623	INDR				
03E2	DDCB0586	555	RES 0,(IX+IND)	0498	ED8B	624	OTDR				
03E6	DDCB058E	556	RES 1,(IX+IND)	049A	F009	625	ADD IY,BC				
03EA	DDCB0596	557	RES 2,(IX+IND)	049C	FD19	626	ADD IY,DE				
03EE	DDCB059E	558	RES 3,(IX+IND)	049E	FD218405	627	LD IY,NN				
03F2	DDCB05A6	559	RES 4,(IX+IND)	04A2	FD228405	628	LD (NN),IY				
03F6	DDCB05AE	560	RES 5,(IX+IND)	04A6	FD23	629	INC IY				
03FA	DDCB05B6	561	RES 6,(IX+IND)	04A8	FD29	630	ADD IY,IY				
03FE	DDCB05BE	562	RES 7,(IX+IND)	04AA	FD2A8405	631	LD IY,(NN)				
0402	DDCB05C6	563	SET 0,(IX+IND)	04AE	FD2B	632	DEC IY				
0406	DDCB05CE	564	SET 1,(IX+IND)	04B0	FD3405	633	INC (IY+IND)				
040A	DDCB05D6	565	SET 2,(IX+IND)	04B3	FD3505	634	DEC (IY+IND)				
040E	DDCB05DE	566	SET 3,(IX+IND)	04B6	FD360520	635	LD (IY+IND),N				
0412	DDCB05E6	567	SET 4,(IX+IND)	04BA	FD39	636	ADD IY,SP				
0416	DDCB05EE	568	SET 5,(IX+IND)	04BC	FD4605	637	LD B,(IY+IND)				
041A	DDCB05F6	569	SET 6,(IX+IND)	04BF	FD4E05	638	LD C,(IY+IND)				
041E	DDCB05FE	570	SET 7,(IX+IND)	04C2	FD5605	639	LD D,(IY+IND)				
0422	ED40	571	IN B,(C)	04C5	FD5E05	640	LD E,(IY+IND)				
0424	ED41	572	OUT (C),B	04C8	FD6605	641	LD H,(IY+IND)				
0426	ED42	573	SBC HL,BC	04CB	FD6E05	642	LD L,(IY+IND)				
0428	ED438405	574	LD (NN),BC	04CE	FD7005	643	LD (IY+IND),B				
042C	ED44	575	NEG	04D1	FD7105	644	LD (IY+IND),C				
042E	ED45	576	RETN	04D4	FD7205	645	LD (IY+IND),D				
0430	ED46	577	IM 0	04D7	FD7305	646	LD (IY+IND),E				
0432	ED47	578	LD I,A	04DA	FD7405	647	LD (IY+IND),H				
0434	ED48	579	IN C,(C)	04DD	FD7505	648	LD (IY+IND),L				
0436	ED49	580	OUT (C),C	04E0	FD7705	649	LD (IY+IND),A				
0438	ED4A	581	ADC HL,BC	04E3	FD7E05	650	LD A,(IY+IND)				
043A	ED4B8405	582	LD BC,(NN)	04E6	FD8605	651	ADD A,(IY+IND)				
043E	ED4D	583	RETI	04E9	FD8E05	652	ADC A,(IY+IND)				
0440	ED50	584	IN D,(C)	04EC	FD9605	653	SUB (IY+IND)				
0442	ED51	585	OUT (C),D	04EF	FD9E05	654	SBC A,(IY+IND)				
0444	ED52	586	SBC HL,DE	04F2	FDA605	655	AND (IY+IND)				
0446	ED538405	587	LD (NN),DE	04F5	FDAE05	656	XOR (IY+IND)				
044A	ED56	588	IM 1	04F8	FDB605	657	OR (IY+IND)				
044C	ED57	589	LD A,I	04FB	FDBE05	658	CP (IY+IND)				
044E	ED58	590	IN E,(C)	04FE	FDE1	659	POP IY				
0450	ED59	591	OUT (C),E	0500	FDE3	660	EX (SP),IY				
0452	ED5A	592	ADC HL,DE	0502	FDE5	661	PUSH IY				
0454	ED5B8405	593	LD DE,(NN)	0504	FDE9	662	JP (IY)				
0458	ED5E	594	IM 2	0506	FD9F	663	LD SP,IY				
045A	ED60	595	IN H,(C)	0508	FDCB0506	664	RLC (IY+IND)				
045C	ED61	596	OUT (C),H	050C	FDCB050E	665	RRC (IY+IND)				
045E	ED62	597	SBC HL,HL	0510	FDCB0516	666	RL (IY+IND)				
0460	ED67	598	RRD	0514	FDCB051E	667	RR (IY+IND)				
0462	ED68	599	IN L,(C)	0518	FDCB0526	668	SLA (IY+IND)				
0464	ED69	600	OUT (C),L	051C	FDCB052E	669	SRA (IY+IND)				
0466	ED6A	601	ADC HL,HL	0520	FDCB053E	670	SRL (IY+IND)				
0468	ED6F	602	RLD	0524	FDCB0546	671	BIT 0,(IY+IND)				
046A	ED72	603	SBC HL,SP	0528	FDCB054E	672	BIT 1,(IY+IND)				
046C	ED738405	604	LD (NN),SP	052C	FDCB0556	673	BIT 2,(IY+IND)				
0470	ED78	605	IN A,(C)	0530	FDCB055E	674	BIT 3,(IY+IND)				
0472	ED79	606	OUT (C),A	0534	FDCB0566	675	BIT 4,(IY+IND)				
0474	ED7A	607	ADC HL,SP	0538	FDCB056E	676	BIT 5,(IY+IND)				
0476	ED7B8405	608	LD SP,(NN)	053C	FDCB0576	677	BIT 6,(IY+IND)				
047A	EDA0	609	LDI	0540	FDCB057E	678	BIT 7,(IY+IND)				
047C	EDA1	610	CPI	0544	FDCB0586	679	RES 0,(IY+IND)				
047E	EDA2	611	INI	0548	FDCB058E	680	RES 1,(IY+IND)				
0480	EDA3	612	OUTI	054C	FDCB0596	681	RES 2,(IY+IND)				
0482	EDA8	613	LDD	0550	FDCB059E	682	RES 3,(IY+IND)				
0484	EDA9	614	CPD	0554	FDCB05A6	683	RES 4,(IY+IND)				
0486	EDAA	615	IND	0558	FDCB05AE	684	RES 5,(IY+IND)				
0488	EDAB	616	OUTD	055C	FDCB05B6	685	RES 6,(IY+IND)				
048A	EDB0	617	LDIR	0560	FDCB05BE	686	RES 7,(IY+IND)				
048C	EDB1	618	CPIR	0564	FDCB05C6	687	SET 0,(IY+IND)				
048E	EDB2	619	INIR	0568	FDCB05CE	688	SET 1,(IY+IND)				
0490	EDB3	620	OTIR	056C	FDCB05D6	689	SET 2,(IY+IND)				
0492	EDB8	621	LDDR	0570	FDCB05DE	690	SET 3,(IY+IND)				

LOC	OBJ CODE	STMT	SOURCE STATEMENT
0574	FDCB05E6	691	SET 4,(IY+IND)
0578	FDCB05EE	692	SET 5,(IY+IND)
057C	FDCB05F6	693	SET 6,(IY+IND)
0580	FDCB05FE	694	SET 7,(IY+IND)
0584		695 NN	DEFS 2
		696 IND	EQU 5
		697 M	EQU 10H
		698 N	EQU 20H
		699 DIS	EQU 30H
		700	END

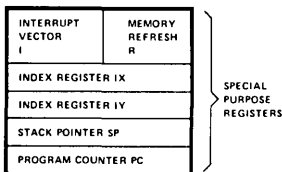
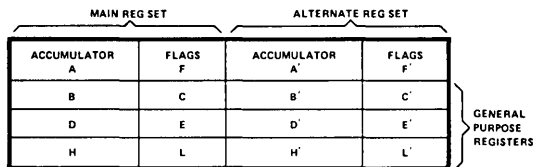

Z80-CPU REGISTER CONFIGURATION

HEXADECIMAL COLUMNS					
6	5	4	3	2	1
HEX = DEC	HEX = DEC	HEX = DEC	HEX = DEC	HEX = DEC	HEX = DEC
0	0	0	0	0	0
1	1,048,576	1 65,536	1 4,096	1 256	1 16
2	2,097,152	2 131,072	2 8,192	2 512	2 32
3	3,145,728	3 196,608	3 12,288	3 768	3 48
4	4,194,304	4 262,144	4 16,384	4 1,024	4 64
5	5,242,880	5 327,680	5 20,480	5 1,280	5 80
6	6,291,456	6 393,216	6 24,576	6 1,536	6 96
7	7,340,032	7 458,752	7 28,672	7 1,792	7 112
8	8,388,608	8 524,288	8 32,768	8 2,048	8 128
9	9,437,184	9 589,824	9 36,864	9 2,304	9 144
A	10,485,760	A 655,360	A 40,960	A 2,560	A 160
B	11,534,336	B 720,896	B 45,056	B 2,816	B 176
C	12,582,912	C 786,432	C 49,152	C 3,072	C 192
D	13,631,488	D 851,968	D 53,248	D 3,328	D 208
E	14,680,064	E 917,504	E 57,344	E 3,584	E 224
F	15,728,640	F 983,040	F 61,440	F 3,840	F 240
0 1 2 3	4 5 6 7	0 1 2 3	4 5 6 7	0 1 2 3	4 5 6 7
BYTE		BYTE		BYTE	

ASCII CHARACTER SET (7-BIT CODE)									
	MSD	0	1	2	3	4	5	6	7
LSD	000	001	010	011	100	101	110	111	
0	0000	NUL	DLE	SP	0	@	P		p
1	0001	SOH	DC1	!	1	A	Q	a	q
2	0010	STX	DC2	"	2	B	R	b	r
3	0011	ETX	DC3	#	3	C	S	c	s
4	0100	EOT	DC4	\$	4	D	T	d	t
5	0101	ENG	NAK	%	5	E	U	e	u
6	0110	ACK	SYN	&	6	F	V	f	v
7	0111	BEL	ETB	'	7	G	W	g	w
8	1000	BS	CAN	(8	H	X	h	x
9	1001	HT	EM)	9	I	Y	i	y
A	1010	LF	SUB	*	:	J	Z	j	z
B	1011	VT	ESC	+	;	K	[k	{
C	1100	FF	FS	,	<	L	\	l	
D	1101	CR	GS	-	=	M]	m	~
E	1110	SO	RS	.	>	N	^	n	DEL
F	1111	SI	VS	/	?	O	_	o	

POWERS OF 2

2 ⁿ	n
256	8
512	9
1 024	10
2 048	11
4 096	12
8 192	13
16 384	14
32 768	15
65 536	16
131 072	17
262 144	18
524 288	19
1 048 576	20
2 097 152	21
4 194 304	22
8 388 608	23
16 777 216	24

2 ⁰ = 16 ⁰
2 ⁴ = 16 ¹
2 ⁸ = 16 ²
2 ¹² = 16 ³
2 ¹⁶ = 16 ⁴
2 ²⁰ = 16 ⁵
2 ²⁴ = 16 ⁶
2 ²⁸ = 16 ⁷
2 ³² = 16 ⁸
2 ³⁶ = 16 ⁹
2 ⁴⁰ = 16 ¹⁰
2 ⁴⁴ = 16 ¹¹
2 ⁴⁸ = 16 ¹²
2 ⁵² = 16 ¹³
2 ⁵⁶ = 16 ¹⁴
2 ⁶⁰ = 16 ¹⁵

POWERS OF 16

16 ⁿ	n
1	0
16	1
256	2
4 096	3
65 536	4
1 048 576	5
16 777 216	6
268 435 456	7
4 294 967 296	8
68 719 476 736	9
1 099 511 627 776	10
17 592 186 044 416	11
281 474 976 710 656	12
4 503 599 627 370 496	13
72 057 594 037 927 936	14
1 152 921 504 606 846 976	15

Zilog

10460 Bubb Road
Cupertino, CA 95014
Tel: (408) 446-4666
TWX 910-338-7621

Price: \$7.5

