

Electronic Design 16

VOL. 17 NO.

FOR ENGINEERS AND ENGINEERING MANAGERS

AUG. 2, 1969

Slashing prices by 50 per cent, a digital voltmeter and multimeter halve the number of necessary components with a recirculating remainder conversion technique.

Automatic ranging and polarity indication, high accuracies as well as fast measurement times are additional features. For more detailed information see p. 122.

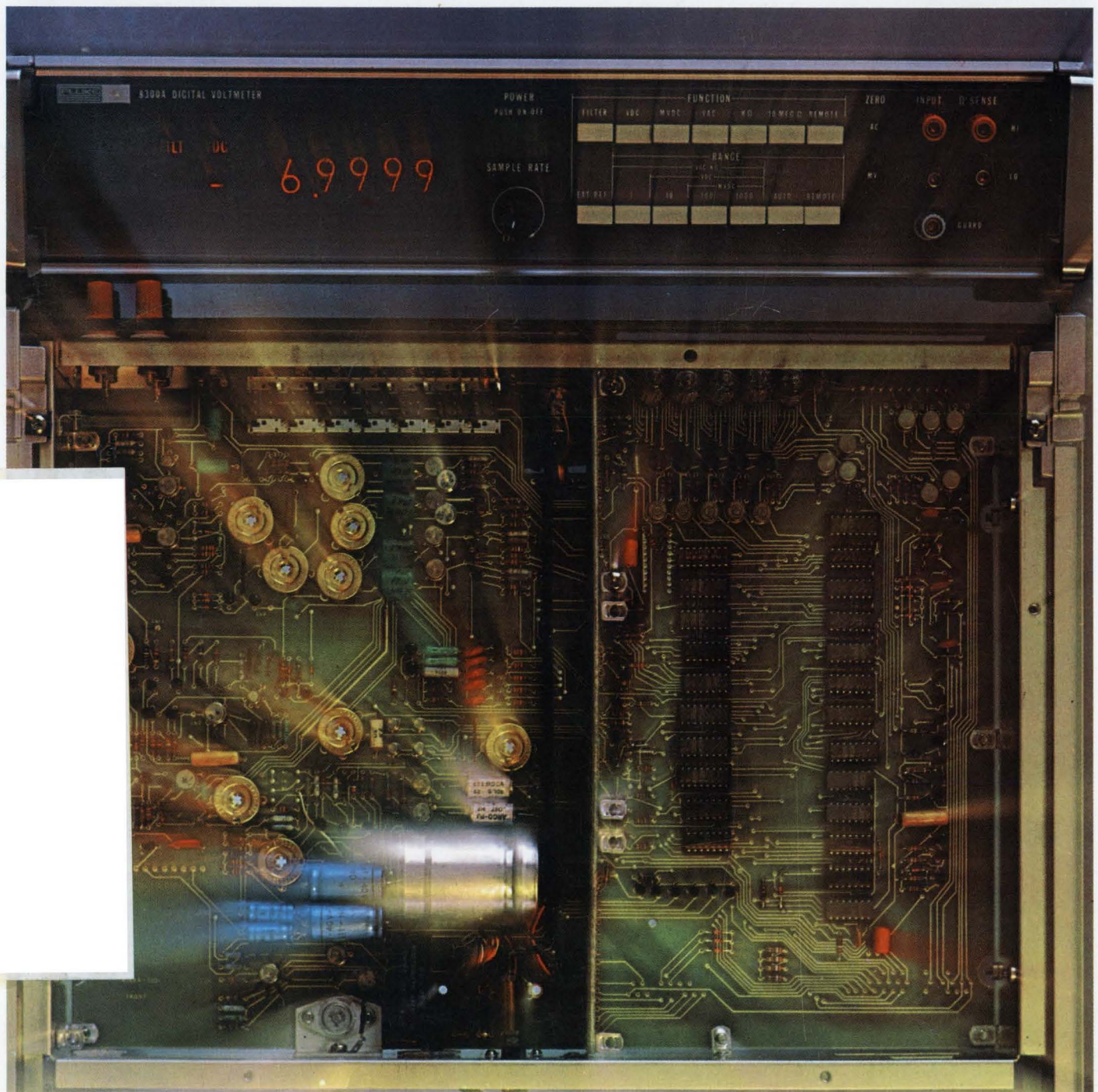

X 1 0 0

fA pA nA nV μ V

AT 1 Hz BANDWIDTH

+ 0 10 20 30 dB



Our singularly accurate transistor noise analyzer tells you the whole story

The singular advantage of Hewlett-Packard's new 4470A is its inherent ability to read out transistor noise voltage (e_n), noise current (i_n) and noise figure (NF), accurate to better than ± 1 dB. And when you tie these factors into one neat package, you end up with the most complete noise performance story ever told. Unless you want accuracy an order of magnitude greater by calculating your measurements with e_n and i_n .

The 4470A was designed for accuracy and convenience in laboratory, for incoming device inspection and for QC testing applications on FET and bipolar transistors. Yet the analyzer is simple enough to be used by production personnel.

Measurements are made at 4 Hz bandwidths, for precise checks at 11 spot frequencies between 10 Hz and 1 MHz. Noise figure is read directly

in dB, using conveniently applied external or internal source resistances.

Since transistor gain varies between devices, an automatic gain control normalizes overall system gain to a fixed value independent of the transistor being used. And the 4470A is completely flexible for biasing transistors under test. The price is just \$4450.

Find out more about the simplicity of measuring transistor noise from your HP field engineer, or write to Hewlett-Packard, Palo Alto, Calif. 94304; Europe: 1217 Meyrin-Geneva, Switzerland.

HEWLETT  PACKARD

The easy way to sort R-L-C components

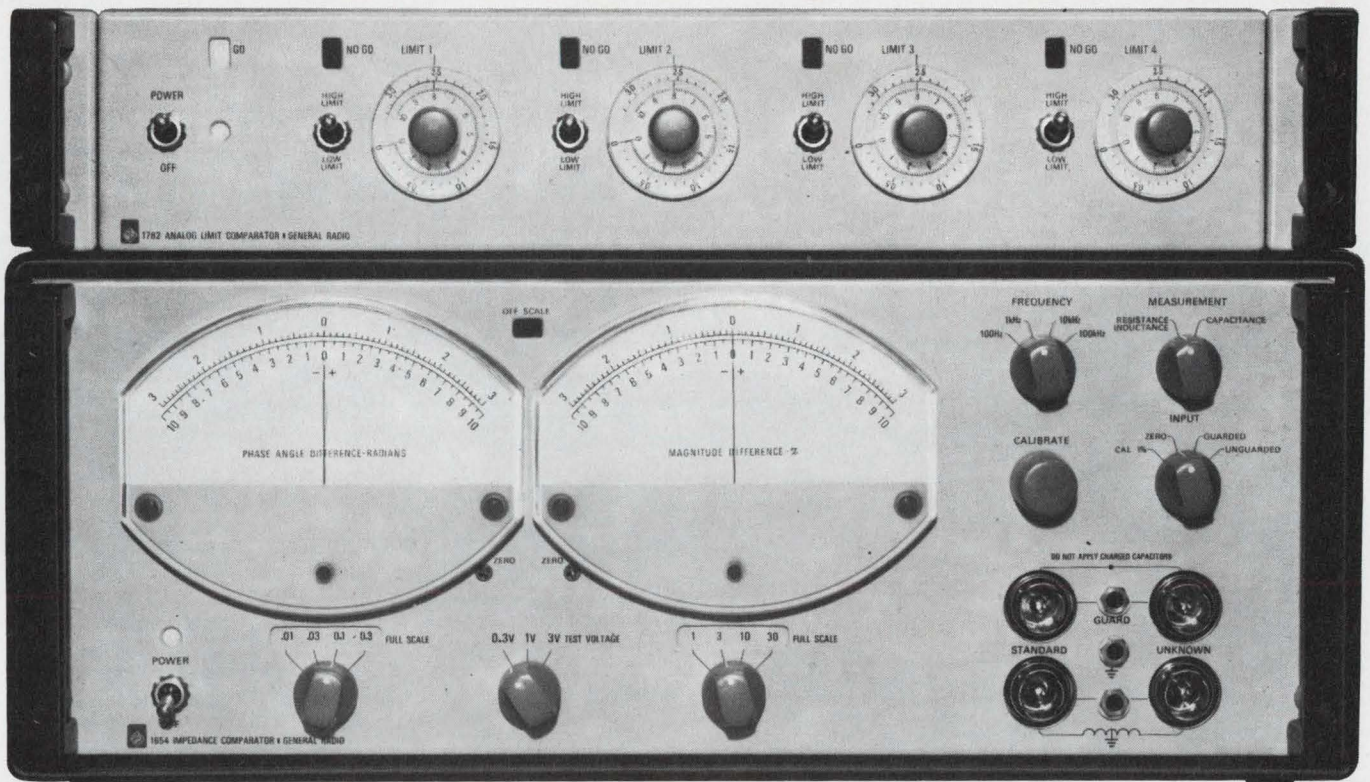

FAST

Measure and sort R-L-C components as rapidly as you can move your hands, using the new 1654 Impedance Comparator and 1782 Analog Limit Comparator. With the optional relay-equipped models of the 1782 you can attain automatic sorting rates as fast as 10,000 components per hour.

FLEXIBLE-VERSATILE

The same setup works for either R, L, or C components because the 1654 measures in terms of impedance difference. Setup is easy. Just connect your production sample or standard to one side of the bridge and your unknowns to the other side. On two large meters read the differences in magnitude and phase-angle between the sample and unknown; for relatively pure components the readout effectively is in terms of ΔR , ΔL , ΔC , ΔQ , or ΔD . Comparison precision is 30 ppm. Manual sorting decisions can be based on the 1654's meter readings or on the 1782's GO/NO GO lights. Or, you don't have to look at anything if you use the relay-equipped models with automatic sorting devices.

The 1782 has four independent limits, each settable to either a high or low limit of either $\Delta\theta$ or ΔZ . Resolution of GO/NO GO limit settings is one percent of full scale and several 1782's can be used with a 1654 for multiple-limit sorting.

LOW COST

One of the best features of this component-sorting system is the price. For \$1250 you can get the basic 1654 Impedance Comparator (rack model) for manual use where meter readout is acceptable. Analog output voltages are available to drive recorders, DVM's, or limit devices. For an additional \$570 you can add the 1782 Analog Limit Comparator and have four preset GO/NO GO limits. Or, for \$645 you can get a 1782 equipped with relays for automatic sorter control. Thus, for \$1250, \$1820, or \$1895 you get a sorting system that can't be beaten in price or performance. Prices apply only in the U. S. A.

Condensed Specifications 1654 Impedance Comparator

Measuring Ranges (dependent upon frequency and voltage): R - 2 Ω to 20 M Ω ; C - 0.1 pF to 1000 μ F; L - 20 μ H to 1000 H.

Test Voltage Across Unknown: 0.3, 1, or 3 V, switch selectable.

Internal Test Frequencies: 100 Hz, 1, 10 and 100 kHz.

For complete information, write General Radio Company, W. Concord, Massachusetts 01781; telephone (617) 369-4400. In Europe: Postfach 124, CH 8034, Zurich 34, Switzerland.

GENERAL RADIO 

If signal analysis from 10 Hz to 50,000 Hz is your concern, Systron-Donner's new spectrum analyzer will simplify your tasks and extend your measuring capabilities as never before.

Our 710/800 gives you absolute amplitude measurements over a 140 dB dynamic range, any 60 dB of which appears on a large 7 x 10 cm high-contrast display. Wave analysis, distortion studies, and spectral display are enhanced by a full 50 kHz scan and a narrow 10 Hz resolution. For measuring EMI and other low-level signals, you get very high sensitivity (calibrated to 30 nanovolts/cm) plus selectable input impedances of 50 ohms, 600 ohms, 10k ohms, and 1 megohm. And you get X-Y outputs, pen lift, sync and sweep inputs, plug-in versatility and many other standard features—all for \$2495.

This spectrum analyzer is truly portable. It weighs only 25 lbs.—or 30 lbs. with an optional internal battery that operates up to 8 hours before recharging.

Write for complete specifications. Ask for a demonstration. Contact Microwave Division, Systron-Donner Corporation, 14844 Oxnard St., Van Nuys, Calif. 91409. Phone: 213-786-1760.

New spectrum analyzer covers 10 to 50,000 Hz with universal measuring capability*

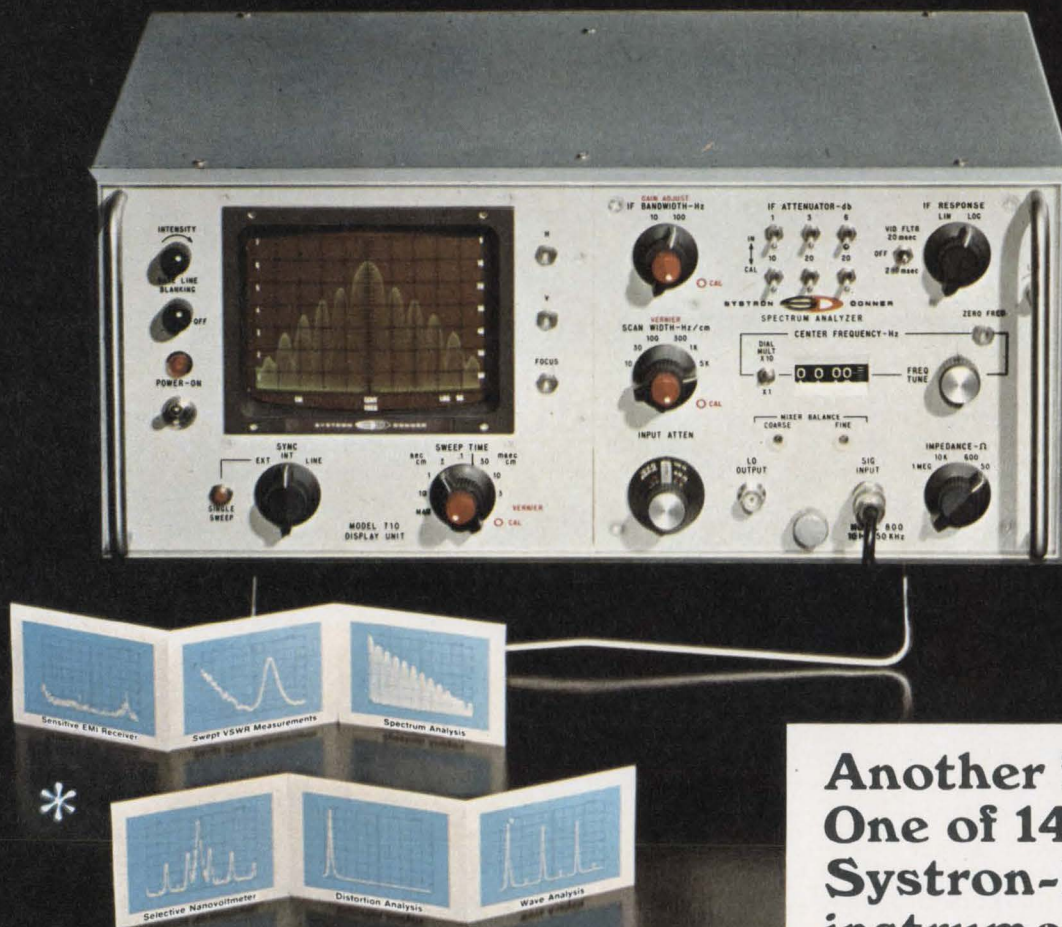

**Another first.
One of 145
Systron-Donner
instruments**

SYSTRON  DONNER

Electronic counters	Digital voltmeters
Pulse generators	Spectrum analyzers
Microwave frequency indicators	Digital panel meters
Digital clocks	Microwave signal generators
Memory testers	Laboratory magnets
Analog computers	Data acquisition systems
Time code generators	Microwave test sets
Data generators	

NEWS

- 21 **News Scope**
- 24 **LSI testing is a large scale headache!**
Harried users and manufacturers are leaning on printed-circuit board experience for relief
- 38 **Area navigation: Relief for air traffic jams**
A 20-year-old system revived by FAA and aviation industry lets pilots 'move' airways electronically
- 42 New phosphors convert infrared to 4 colors
- 47 **Washington Report**
- 49 **Sidelights of the Issue**
- 51 **Wescon Preview: A look ahead to the big show**
- 67 **Editorial: The great ABM debate . . . or has it really been great?**

TECHNOLOGY

- 74 **Determine inverter risetime quickly** with a handy nomograph that also predicts the turnoff mechanism.
- 84 **It makes sense to use LEDs in sensing.** Pulsed light-emitting diodes improve signal-to-noise ratio and reduce average power requirements.
- 90 **Design attenuator pads the easy way** with this BASIC computer program. Losses and impedances are provided for six pad types.
- 98 **Managerial sensitivity training works,** 'alumni' say, a month after 'graduation day.'
- 104 **Semiannual index articles:** January through June, 1969.
- 112 **Ideas for Design**

PRODUCTS

- 122 **Instrumentation:** Digital voltmeters halve price tags and components.
- 126 **Components:** IC-compatible ceramic chip capacitors, only 15 mils thick.
- 128d Modules & Subassemblies
- 130 ICs & Semiconductors
- 133 Data Processing
- 135 Packaging
- 136 Microwaves & Lasers
- 138 Production

Departments

- | | | | |
|-----|---------------------|-----|-------------------------------|
| 14 | Designers' Datebook | 141 | Application Notes |
| 139 | Evaluation Samples | 142 | New Literature |
| 140 | Annual Reports | 150 | Advertisers' Index |
| 140 | Design Aids | 152 | Information Retrieval Service |

Information Retrieval Service Card inside back cover

Cover Photo by Roger Dudley and Herb Franklin
for John Fluke Mfg. Co., Inc., Seattle, Wash.

Everybody talks about beam lead.



This is the dawning of the age of the leaded chip. In other words, sports fans, August is the month Raytheon uncorks beam lead, and the old semiconductor business will never again be the same.

- Simply meaning that now you can buy semiconductor chips with leads already formed and integrally attached. This lets you control packaging, save system assembly time and boost reliability.

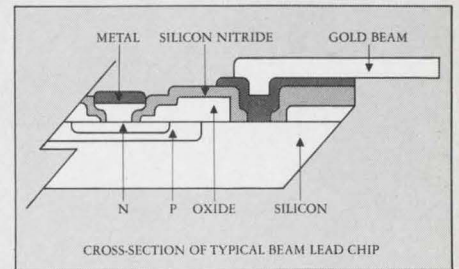

- Take a for instance. With a beam lead chip, bonding's a step, not a career. Every lead's bonded at once, whether you're working with diodes or LSI.
- And the chip stays healthier. Your operator can mash down on those little leads and cook them to a turn. The chip sits there, to one side of the action, calm, cool and uncracked.

- But there's more. Every beam lead chip sports a Silicon Nitride passivation coat to give it complete hermetic sealing at all junctions. Raytheon's wafer separation process exorcises that evil old chip-cracker, the scribe.

Chips are separated by a delicate anisotropic etching process that eases those little babies apart with TLC. No more hidden cracks to surprise you in final testing, or after your

system's been fired up for a week. And just to sweeten the pot, in case you *really* hate surprises, we can provide 100% chip testing against all AC and DC parameters at -55 to $+125^{\circ}\text{C}$.

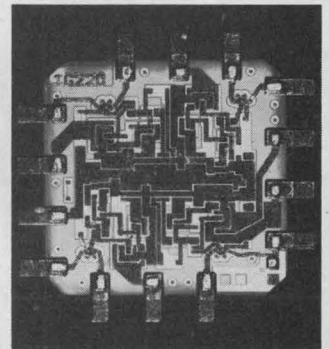

**But we
deliver it.**



Type No.	Device (-55 to $+125^{\circ}\text{C}$)	100-999
RM709	Op amp	\$6.80
RG250	Expandable quad 2 input OR gate	4.05
RG220	Quad 2 input NAND gate	4.05
RG240	Dual 4 input NAND gate	4.05
RG200	Expandable single 8 input NAND gate	4.05
RG230	Quad 2 input OR expander gate	2.60
RF200	JK flip flop (AND inputs)	6.00
RF100	Dual JK flip flop (separate clock)	7.10
1N914	Fast switching diode	1.25
1N3600	High conductance fast switching diode	1.30
2N2484	Low level amplifier NPN	1.75
2N2605	Low level amplifier PNP	2.15

*In segments of 5 chips only.
Commercial grade units at lower prices; delivery to start 4th quarter 1969.*

- We're kicking off our Beam Lead Derby with an even dozen types, available in quantity from our exclusive beam-lead-franchised distributors, Avnet Electronics and Cramer Electronics. Later on you can buy our whole line in beam lead... TTL, DTL, linears, transistors, diodes.
- After that, onward and upward to multi-chip arrays, MSI, LSI and so on. Proving once again the wisdom of doing business with the company that puts its chips where its mouth is. Send for data, including Raytheon-approved list of sources for beam lead bonders. Raytheon Semiconductor, Mountain View, California. (415) 968-9211.

LOW COST MULTIPLIER

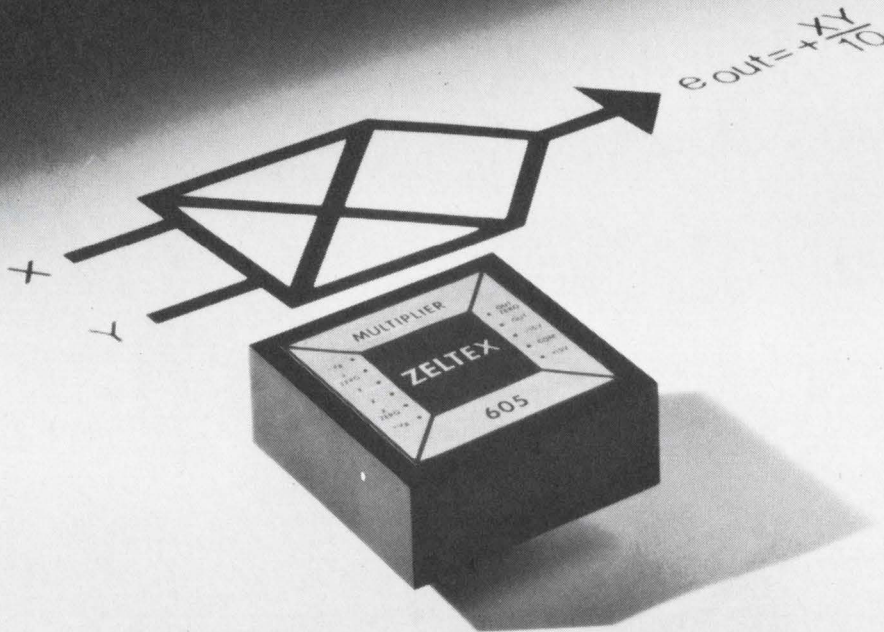

New from
ZELTEK!

A four-quadrant modular multiplier that requires no external amplifiers for

\$48*

- 1% Accuracy
- 10V, 4mA Output
- 1mV rms Noise
- 500 kHz Bandwidth
- 100 kHz Full Output Frequency
- 6V/ μ s Slew Rate

The Model 605 comes to you from the makers of the industry's most accurate multiplier—the Zeltek Model 601 with accuracy within 1mV (0.005%). For complete information on these or any other Zeltek electronic products, write or phone today.
*In quantity.



1000 Chalamar Road, Concord, Calif. 94520 / (415) 686-6660

INFORMATION RETRIEVAL NUMBER 5

INFORMATION RETRIEVAL NUMBER 6 ►

**Environment Proof
is what we call it.**



Tough New Arrival

The Stackpole Series 100 miniature rotary switch is here! New, compact $1\frac{1}{8}$ " diameter body size. Totally enclosed to protect against exposure, contact contamination and production damage. Explosion-proof. Ideally suited for today's rugged demands and space applications.

Reliability and long life are assured by Stackpole's unique mode of switching—field proven

in the larger Series 600 switch. Internal intermixing of electrical functions and interconnection of decks and terminals provide unprecedented switching versatility. Inherently economical—Stackpole enclosed rotaries are competitively priced with open deck, clip type switches. This new versatility and economy encourage complete freedom of design and afford the use of enclosed rotary switches for all applications.

Sample switches, made to your exact specifications, are shipped in 2 to 3 days and production quantities in 2 to 3 weeks. For prompt quotations and samples, send your wiring diagrams or specifications to: Stackpole Components Company, P. O. Box 14466, Raleigh, North Carolina 27610. Telephone: 919-828-6201. TWX: 510-928-0520.

Now in two sizes

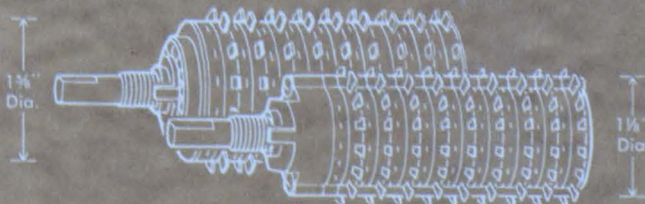

STACKPOLE
COMPONENTS COMPANY

Truth is stronger than fiction.



The truth about our A/D converters is stronger than the fiction you hear about others.

The truth about ours is that word lengths vary from 4 bits to 9 bits; word conversion rates vary from 1 MHz to 25 MHz; and aperture time is as low as 0.2 nanosecond!

Prices range from only \$4,200 to \$9,660 and include internal sample-and-hold, power supplies, and self-test features.



COMPUTER LABS

for tomorrow's technology today

(919) 292-6427 • 1109 SOUTH CHAPMAN ST.
GREENSBORO, N. C. 27403

COS/MOS—RCA's technological breakthrough breaks through in economics, too!

New design flexibility! New operating features! RCA-CD4006D brings both to digital circuits with MSI complexity! Newest in RCA's growing line of COS/MOS integrated circuits, this Complementary Symmetry MOS 18-Stage Static Shift Register gives you:

Flexibility. It provides multiple register sections of 4, 5, 8 and 9 stages or single register sections of 10, 12, 13, 14, 16, 17, and 18 stages. And outputs are available from both fourth and fifth stages. Here's real flexibility—in both design and operation.

Low Power. Take advantage of COS/MOS low power requirements. Quiescent dissipation is only 100 nanowatts (typical). Even in dynamic operation, the dissipation is only 2 milliwatts at 1 MHz with input of

alternate "ones" and zeros.

Workability. CD4006D operates with a single power supply and with a single-phase clock. Clock amplitude is the same as logic swing. No need to supply an additional voltage level. And you won't lose stored information if the clock is interrupted. No information recirculation required.

Economy to Match

CD4006D—at \$17.25 (1,000 units)—provides full military temperature range operation and 18 flip-flops for less than \$1.00 each. That means you get the design and operating advantages of RCA's unique COS/MOS technology with real-world economics.

Check these device design innovations:

- -55° to +125°C operation
- 100 nanowatt quiescent dissipation (typ.)
- Static to 2 MHz shift rate
- Single 6- to 15-volt positive or negative power supply
- 4-V noise margin (10-V logic)
- Large fanout—up to 50

CD4006D is only one of the new circuits that are ready now to prove the practicality and economy of COS/MOS. Order now from your local RCA Representative or through your RCA Distributor. For technical data, write to RCA Electronic Components, Commercial Engineering, Section ICG-7-2, Harrison, N.J. 07029.

RCA-CD4006D 18-Stage Static Shift Register. MSI density with design flexibility.

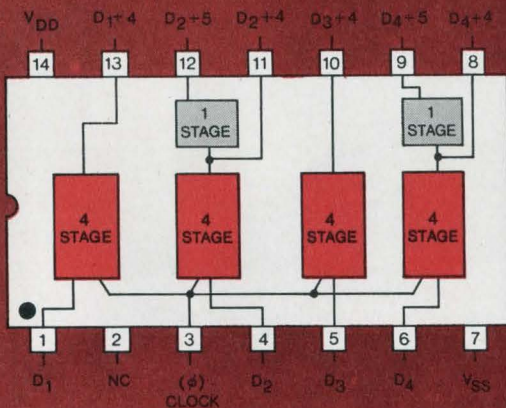

RCA-CD4006D in DIC. \$25.00 (1-99 units).
RCA-CD4006 in ceramic flat pack is \$26.50 (1-99 units).

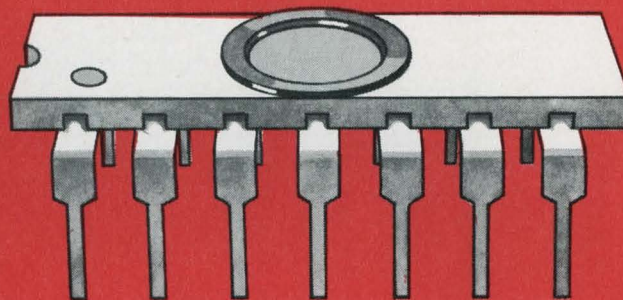

Design with these other COS/MOS Circuits—ready now:

Dual 3-Input Gate and Inverter	CD4000D	7-Stage Counter/Divider	CD4004T*
Quad 2-Input Gate	CD4001D	16-Bit NDRO Memory	CD4005D
Dual 4-Input Gate	CD4002D	Dual Complementary Transistor Pair and Inverter	CD4007D
Dual "D"-Type Flip-Flop	CD4003D		

*12-lead TO-5 Style Package

RCA Integrated Circuits

**You can imagine what
the future holds
in state-of-the-art,
silicon power
circuit designs...**

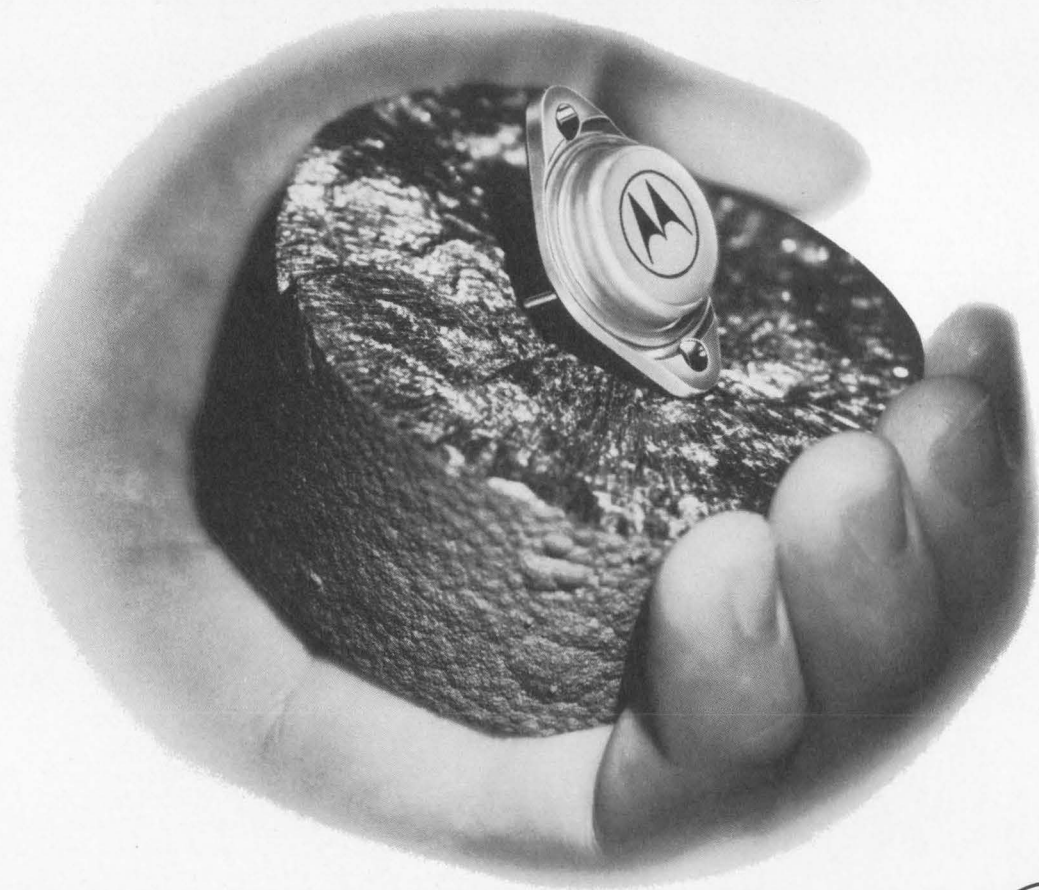

- where the priceless ingredient is care!



Maximum Current Rating	Consumer		Industrial		Military	
	Switching Voltage (max) V	Amplifying Voltage (max) V	Switching Voltage (max) V	Amplifying Voltage (max) V	Switching Voltage (max) V	Amplifying Voltage (max) V
100mA	250 - 325			300 - 350		
250mA	325	325				
500mA	200 - 325		200 - 325	225 - 350		
1A				40	250 - 300	
2A			40 - 80	120 - 325		120 - 200
2.5A			400	400		
3A	30 - 80	30 - 80	40 - 80	30 - 80 225 - 300	60 - 80	225 - 300
3.5A	200 - 325			200 - 325		
4A	1,400*	40 - 80		40 - 80		60
5A	500*	40 - 80	60 - 80	40 - 80	80 - 100	80 - 100
7A			80 - 100		80 - 100	80 - 100
7.5A				60 - 100		80 - 120
10A	700*	60 - 100	100 - 140	40 - 100 100 - 325	80†	
16A			100 - 140	100 - 140		
20A				60		
30A		40 - 90		40 - 80	100	100
50A			60 - 80	60 - 80		
60A					80 - 100	

*V_{CE5}

■ Shaded Area = Complementary Capability

† Darlington Amplifier

...when you see our
state-of-the-art past and
present

Write Box 20912, Phoenix, Arizona 85036 for our new Silicon Power Transistor Selector Guide — biography of today's most complete silicon power device capability. You'll find the broadest complementary offering... the highest voltage current capability... Annular, EpiBase,* hybrid and triple-diffused devices... and 10 different plastic and metal package styles. Then contact your franchised Motorola distributor about any of them.

*Trademark Motorola Inc.

MOTOROLA Silicon Power Transistors

INFORMATION RETRIEVAL NUMBER 9



For the widest selection of high-quality front-panel components, ask your distributor for Nobex

NOBEX control knobs are available in 72 different sizes, including low-profile concentrics and miniatures, with snap-in color caps in 9 standard colors, and bodies in 3 standard and 25 special-order colors.

NOBEX binding posts are made in standard and miniature sizes in 6 colors to match NOBEX control knobs.

NOBEX unbreakable instrument cases are injection molded in 9 colors.

For digital displays, specify the low-cost DIGIBEZEL™—the numeric display tube bezel with built-in Polaroid* filter. DIGIBEZEL is de-

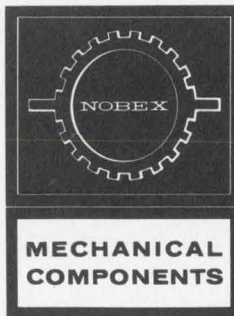

signed to enhance your instrument's lines while providing maximum contrast and readability in high ambient light levels. DIGIBEZEL installs in seconds with hidden mounting hardware.

Next time you talk to your distributor about front-panel components, talk about NOBEX. If he doesn't carry NOBEX, phone or write directly to NOBEX DIVISION GRIFFITH PLASTIC PRODUCTS COMPANY.

Write today for a free, full-color catalog containing complete NOBEX specifications, dimensions and ordering information.

*A trademark of Polaroid Corporation

NOBEX DIVISION GRIFFITH PLASTIC PRODUCTS COMPANY

1027 California Drive, Burlingame, California 94010
Telephone (415) 344-7691 • TWX 910-374-2840

INFORMATION RETRIEVAL NUMBER 10

How our Variplate™ connecting system keeps your fifty-cent IC's from becoming four-dollar headaches.

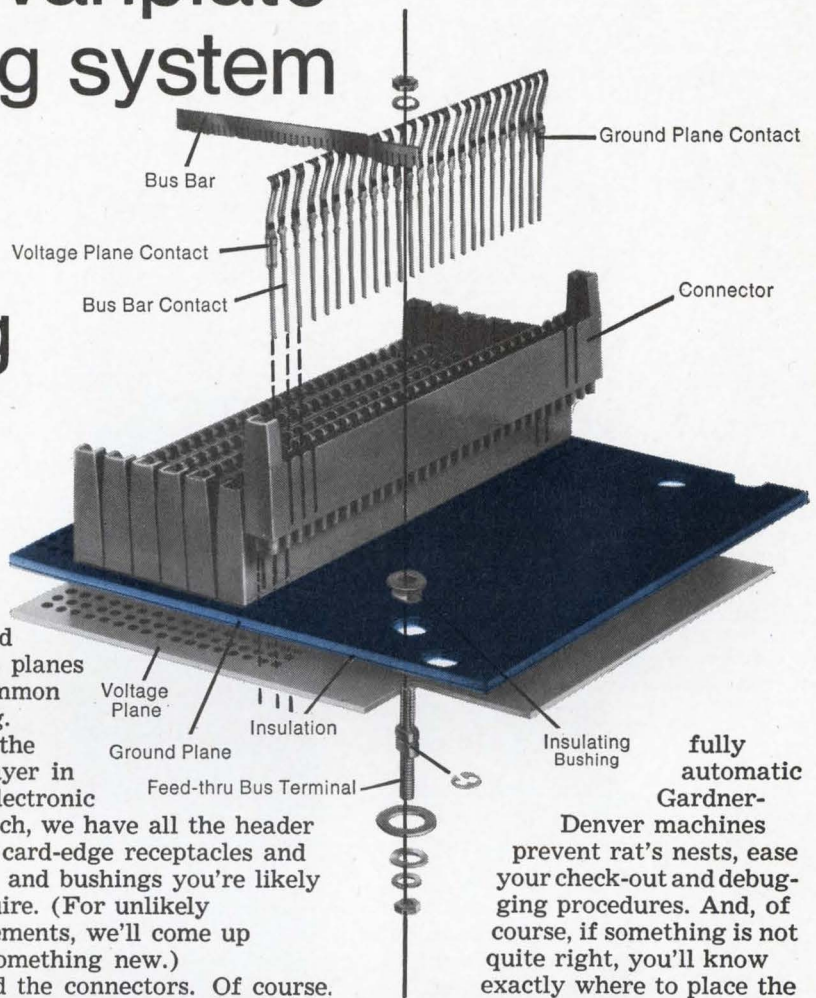

IC's don't cost much. Until you use them. You can buy, say 20,000 IC's for the innards of a compact computer, packed in the transistor cans, flat packs, or Dual-in-Line (DIP) packages, for a unit cost of less than fifty cents.

Great.

But then you have to connect them.

Not so great.

Because those 20,000 IC's have anywhere from 200,000 to 280,000 leads waiting to be connected. Fine leads. Closely spaced. And, of course, you want to pack the IC's as densely as possible. So it's really no surprise that your *in-place* cost of an IC can climb to \$4.00.

Fortunately, we have a system that can keep your in-place cost down: the Variplate interconnection system.

With the Variplate system, you can pack those IC's—and all the pc boards and other components you have—as densely as the application demands. You can do it on automated equipment—and we'll even do the wiring for you.

All the components you need.

The system begins with the base plate, a self-supporting structural member. It carries the insulated contact modules, accommodates secondary components and hardware, and provides for mounting to support framework.

The plate can be a single metal sheet that provides a ground plane, or it can be a sandwich that provides both volt-

age and ground planes for common bussing.

For the next layer in your electronic sandwich, we have all the header plates, card-edge receptacles and guides, and bushings you're likely to require. (For unlikely requirements, we'll come up with something new.)

And the connectors. Of course. Our own respected Varimate™, Varicon™, and Varilok™ connectors, or standard fork-and-blade, terminal stud, card-edge, or bus strip contacts. Your choice.

No holes barred.

We put all these components together in any size, any shape, and almost any density of package you require. Plates can be any size. Contacts can be spaced on .100", .125", .150", or .200" centers, in square or offset grids—on non-standard configurations where you need them.

What you get is a solid electrical and mechanical foundation for your electronic network, so precisely made that any automated assembly equipment can take over from there.

However.

You'll save time and money if you let us go one step further and wire your network for you. Our

fully automatic Gardner-Denver machines prevent rat's nests, ease your check-out and debugging procedures. And, of course, if something is not quite right, you'll know exactly where to place the responsibility.

Altogether, it's quite a system. And worth all the work we've put into it. Because if we can save you just a nickel on the cost of installing each of your 20,000 IC's you can add a thousand dollars to

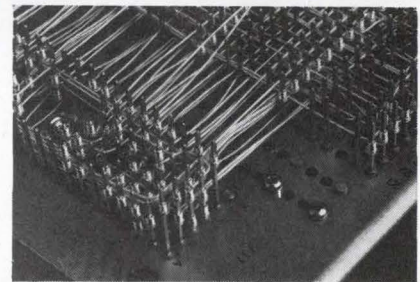

your company's profits.

We're sure we can save you that nickel, and more. For more information, write, wire, call, or TWX us for our Variplate interconnecting systems catalog. Elco Corporation, Willow Grove, Pa. 19090. 215-659-7000; TWX 510-665-5573.



ELCO Variplate Connectors

INFORMATION RETRIEVAL NUMBER 11

Knock it off its pedestal

and win a job
at Bell & Howell!

For two years we've
tried to top the VR 5000.
So has the competition.

But the VR 5000 was
so far ahead of its
time — in concept, per-
formance, reliability —
that even our best
heads (human and mag-
netic) have been
unable to surpass it.

And no other
instrumentation
recorder has
been able to
equal it.

Admittedly,
several others have
come fairly close. But
being close doesn't put
you on a pedestal.

If you'd care to accept
the challenge, or would
just like the facts
about the world's finest
instrumentation
recorder — call our
nearest office. Or write
Bell & Howell,
Pasadena, California
91109. Ask for Bulletin
Kit 3302-X9.

CEC/DATA INSTRUMENTS DIVISION

 **BELL & HOWELL**

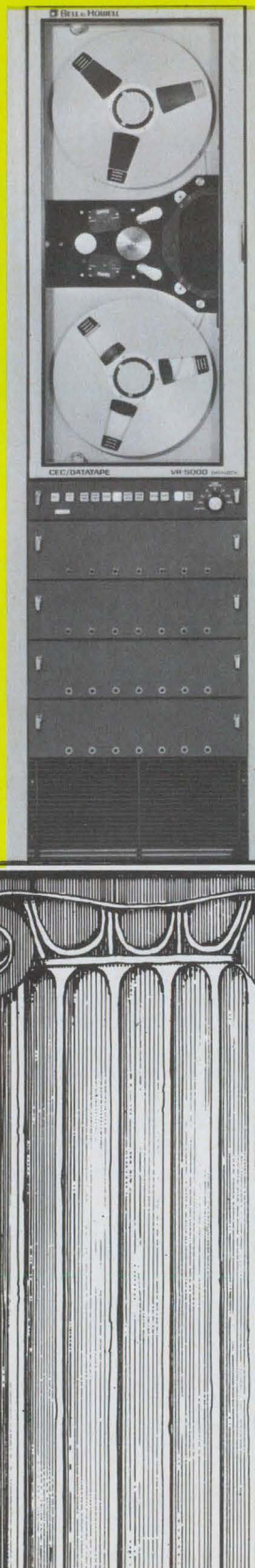

Designer's Datebook

AUGUST 1969						
Sun	Mon	Tue	Wed	Thu	Fri	Sat
					1	2
3	4	5	6	7	8	9
10	11	12	13	14	15	16
17	18	19	20	21	22	23
24	25	26	27	28	29	30
31						

SEPTEMBER 1969						
Sun	Mon	Tue	Wed	Thu	Fri	Sat
	1	2	3	4	5	6
7	8	9	10	11	12	13
14	15	16	17	18	19	20
21	22	23	24	25	26	27
28	29	30				

For further information on meet-
ings, use Information Retrieval Card.

Aug. 19-22

**Western Electronic Show & Con-
vention (WESCON)** (San Fran-
cisco) Sponsor: IEEE, WEMA, T.
Shields, WESCON, 3600 Wilshire
Blvd., Los Angeles, Calif. 90005

CIRCLE NO. 401

Aug. 19-22

**Science and Technology of Infor-
mation Display Seminar** (Farm-
ingdale, N.Y.) Sponsor: Polytech-
nic Institute of Brooklyn, Mrs. H.
Warren, Adm. Officer, L.I. Grad.
Center, Polytechnic Institute of
Brooklyn, Farmingdale, N. Y.
11735

CIRCLE NO. 402

Aug. 24-27

**Electronic Materials Technical
Conference** (Boston, Mass.) Spon-
sor: AIME, Edward L. Kern,
Metallurgical Society of AIME,
345 E. 47th St., New York, N.Y.
10017

CIRCLE NO. 403

Sept. 7-11

Electrical Insulation Conference
(Boston) Sponsor: IEEE et al, H.
P. Walker, NAVSEC, Code 6156D,
Washington, D. C. 20360

CIRCLE NO. 404

Sept. 8-10

Aerospace Computer Conference
(Los Angeles) Sponsor: AIAA,
R. W. Rector, American Institute
of Aeronautics and Astronautics,
1290 Sixth Ave., New York City
10019

CIRCLE NO. 405

Sept. 15-17

**International Telemetry Con-
ference** (Washington, D.C.) Spon-
sor: ITC et al, R. J. Blanchard,
Defense Electronics Inc., Rock-
ville, Md. 20854

CIRCLE NO. 406

When the chips are down, they ought to be on our IC packages.

It's not just because we want to sell our products (which we do).

Or because we're proud of them (which we are).

We think you should buy our IC packages for a number of reasons.

First of all, we make all our own parts. (Many of our competitors must buy frames and ceramics for assembly.)

We assemble the packages ourselves.

We test our packages for insulation, thermal shock resistance, hermeticity, lack of internal shorts, excess glass-ceramic flow.

And if one of our growing line of packages

doesn't fit your requirements, we'll design one that will.

One more thing. Just because you're getting the best IC package money can buy, don't think it takes a lot of money. In fact, ours probably costs less than any others.

Isn't that where you should put your chips?

Sylvania Metals & Chemicals, Parts Division,
Warren, Pennsylvania 16365.

SYLVANIA
GENERAL TELEPHONE & ELECTRONICS

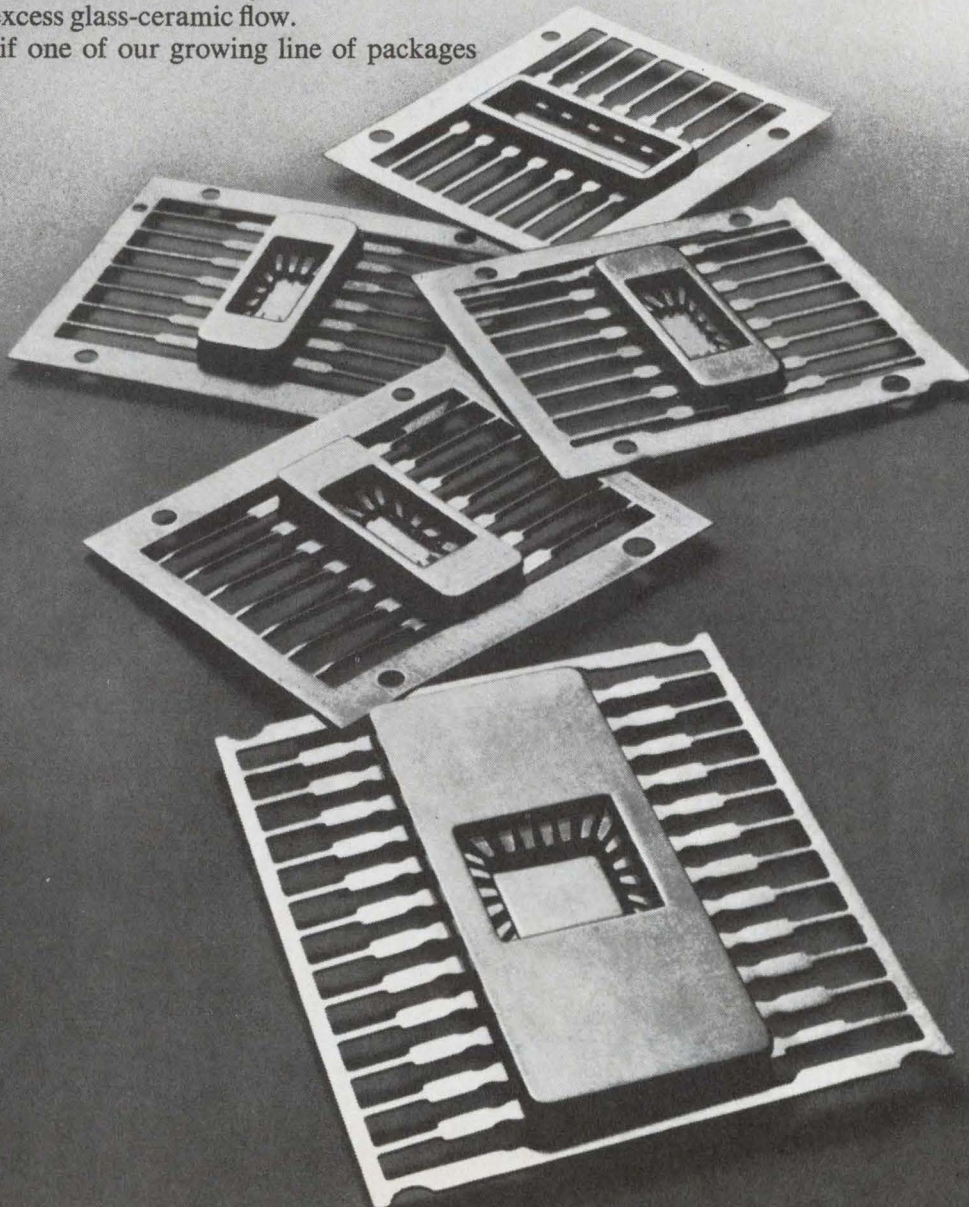

We had big things in mind when we developed our tiny toggle switches.



Things like airplanes,
ware, communications gear and
Things where small size
But where long-life operating
For instance, excellent

position." Our TW toggle switches provide both. The result of a 35° toggle throw and positive detent. And for aircraft applications, there's a new, large bat handle that meets your human factor requirements.

Then there's switching versatility. Both standard 1/4" and our new 15/32" bushing versions are available with a two or three-position, maintained or momentary action and in either one or two-pole circuitry. All can be obtained with standard or pull-to-unlock toggle levers to meet your needs.

Sealed, molded-in solder terminals won't pull out. Go ahead, try.

What this all adds up to is reliability. The kind that's evidenced by meeting MIL-S-3950 requirements for shock, vibration, moisture, corrosion and altitude.

There are accessories, too. Dress hardware, lever caps, boot seals, panel seals. Each improves switch effectiveness as well as panel appearance.

It's all in Product Sheet TW. Plus a lot more. You can get a copy from your MICRO SWITCH Branch Office or Distributor. (They're in the Yellow Pages under "Switches, Electric.") Or write and we'll send a copy. You're sure to find it a big help.

MICRO SWITCH

FREEPORT, ILLINOIS 61032
A DIVISION OF HONEYWELL
INFORMATION RETRIEVAL NUMBER 14

FOR ADDITIONAL COPIES OF THE
POWER/MATE CORP. INSERT, CIRCLE 236 ►

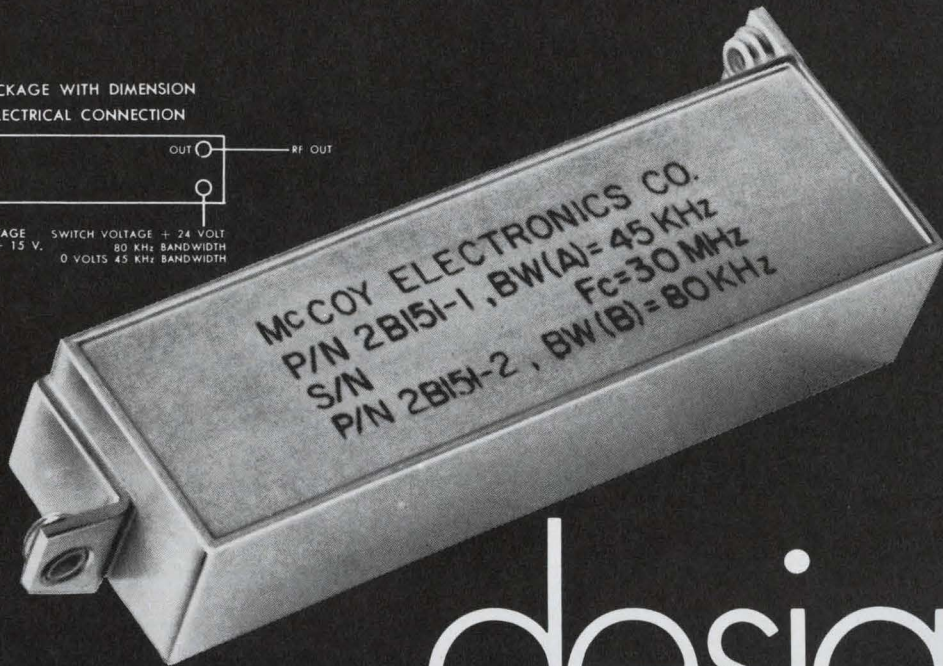
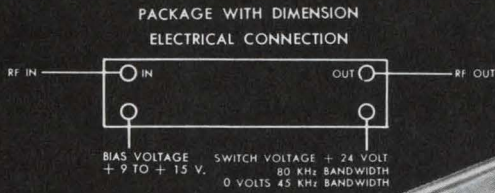

design freedom

yours with the new switchable dual bandwidth
crystal filters

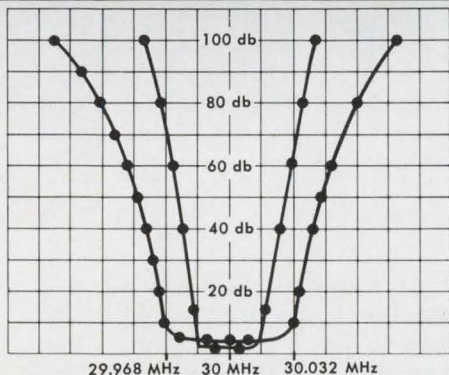

SPECIFICATION filter (A)

1 db Bandwidth 35 KHz Min.
6 db Bandwidth 45 KHz Min.
60 db Bandwidth 90 KHz Max.
Ultimate Attenuation 80 db
Impedance 50 Ω in & out
Ripple 1 db Max.
I.L. \leq 4 db

ENVIRONMENTAL:

TR -55°C to 105°C
Vibration—Mil. Std. 202
Shock—Mil. Std. 202

CENTER FREQUENCY 30 MHz filter (B)

1 db Bandwidth 64 KHz Min.
6 db Bandwidth 80 KHz Min.
60 db Bandwidth 160 KHz Max.
Ultimate Attenuation 80 db
Impedance 50 Ω in & out
Ripple 1 db Max.
I.L. \leq 4 db

Tol.

Center Frequency \pm .005%
Method 204 A Test Cond. D
Method 205 C Test Cond. C

For multi-mode communication systems, M^CCoy has added another technological achievement in expanding applications for crystal filters. The switchable filter is custom-made to your specifications, economically, and in a small package.

At M^CCoy Electronics, the integration of crystal and filter engineering technology is your assurance of the finest crystal filter performance available today. And we'll be ready for tomorrow with the next dimension in crystal filters to suit your future needs.

Put our experience to work for you!



MCCOY ELECTRONICS COMPANY
MT. HOLLY SPRINGS, PENNSYLVANIA 17065
Tel. 717-486-3411 TWX: 510-650-3548
a subsidiary of OAK ELECTRO/NETICS CORP

Something *New* Has Been Added!

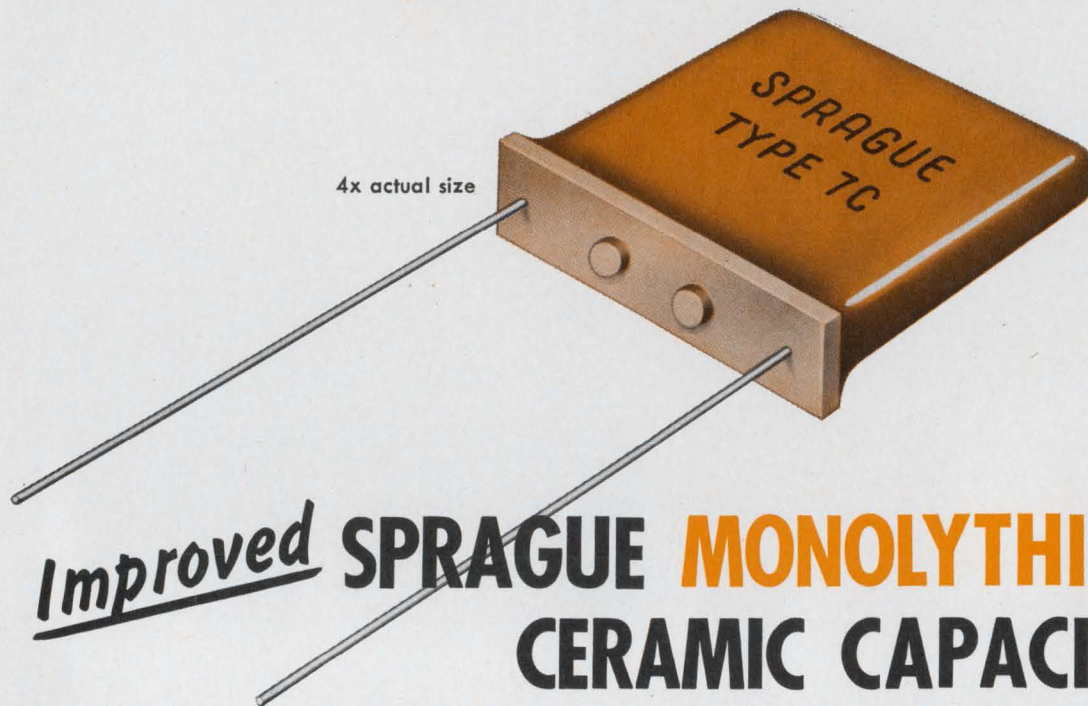

Improved SPRAGUE MONOLYTHIC[®] CERAMIC CAPACITORS

now have a phenolic terminal base

Type 7C Radial-lead Capacitors are made with alternate layers of sprayed ceramic dielectric material and screened metallic electrodes, fired into a solid homogeneous block and coated with a tough phenolic resin. Their new bossed terminal base construction provides these advantages: (1) No resin run-down on leads. (2) Uniform lead spacing is automatically maintained. (3) No dirt and moisture entrapment; degreasing fluid flows freely between capacitor and board.

Body Code	EIA Characteristic	Operating Temperature Range	Maximum Cap. Change over Temp. Range	WVDC	Capacitance Range	Capacitance Tolerance
082	NPO	-55 C to +125 C	±60ppm/°C	50 100 200	51 pF to .024 μF	±20% ±10% ±5% ±2%
075	N750	+25 C to +85 C	-750 ± 120 ppm/°C	50 100 200	.001 μF to .082 μF	±20% ±10% ±5% ±2%
		-55 C to +125 C	Meets MIL-C-20 Char. UJ			
067	X7R	-55 C to +125 C	±15%	50 100	.0018 μF to 1.5 μF	±20% ±10%
023	Z5U	+10 C to +85 C	+22%, -56%	50	.01 μF to 3.3 μF	+80, -20% ±20%



Also made with axial leads, Monolythic[®] Ceramic Capacitors are available in four body formulations, including a newly-developed 075 ceramic material, as described in the adjacent chart.



For complete technical data write for engineering bulletins on Monolythic Ceramic Capacitors to: Technical Literature Service, Sprague Electric Co., 347 Marshall St., North Adams, Mass. 01247.

SPRAGUE COMPONENTS

CAPACITORS
TRANSISTORS
RESISTORS
INTEGRATED CIRCUITS
THIN-FILM MICROCIRCUITS

PULSE TRANSFORMERS
INTERFERENCE FILTERS
PULSE-FORMING NETWORKS
TOROIDAL INDUCTORS
ELECTRIC WAVE FILTERS

CERAMIC-BASE PRINTED NETWORKS
PACKAGED COMPONENT ASSEMBLIES
BOBBIN and TAPE WOUND MAGNETIC CORES
SILICON RECTIFIER GATE CONTROLS
FUNCTIONAL DIGITAL CIRCUITS



'Sprague' and '®' are registered trademarks of the Sprague Electric Co.

News

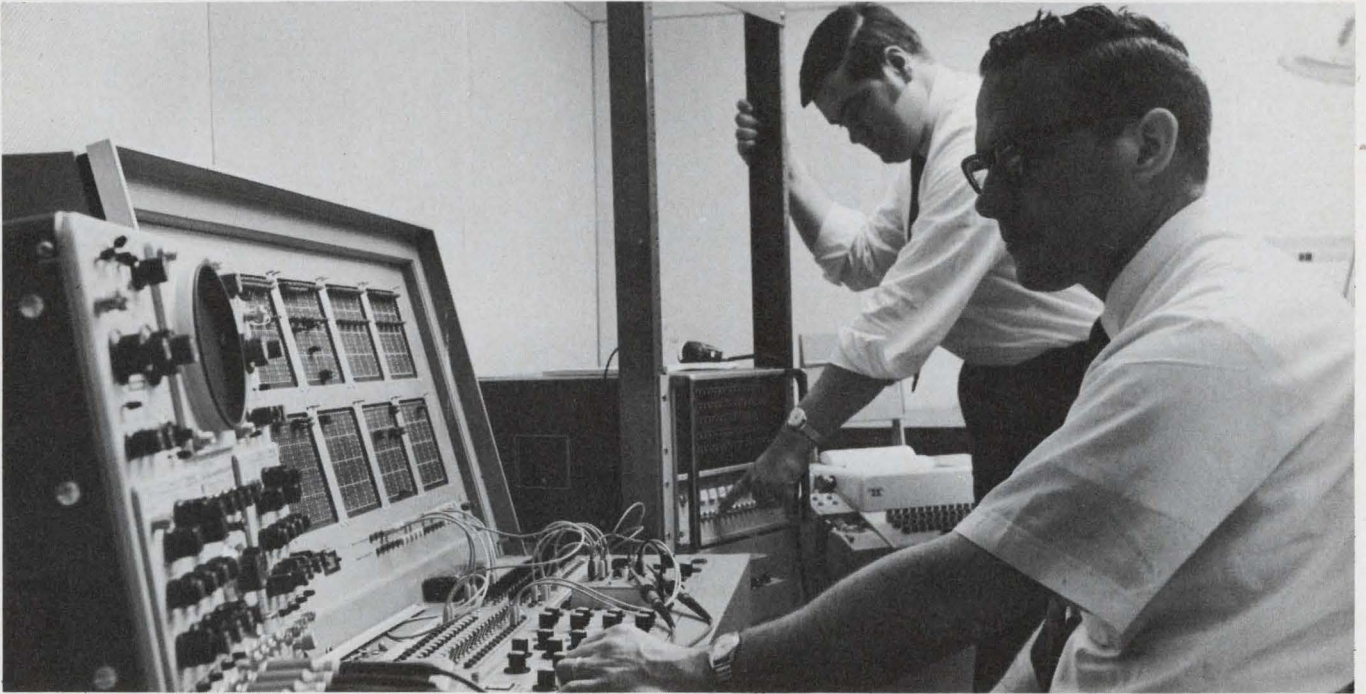

Testing LSI arrays, as at Viatron Computer Systems (above), is a major headache for

LSI makers and users. PC-board technology may provide some answers. p. 24



Undecided on whether to attend this year's Wescon show? Here's a preview. p. 51

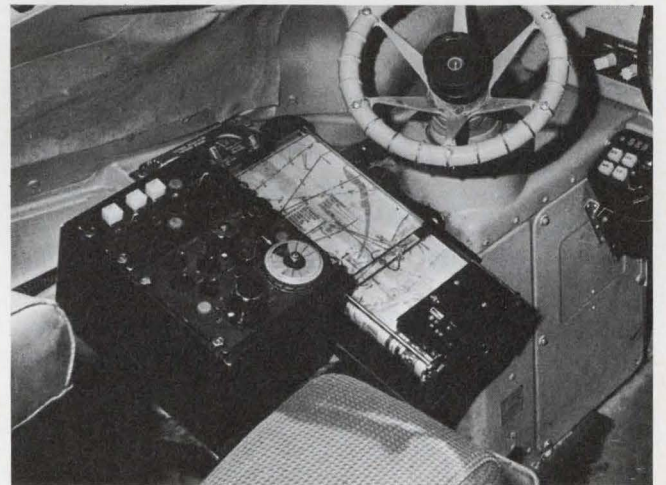

Area navigation equipment is expected to help relieve air-traffic congestion. p. 40

Also in this section:

New phosphors convert infrared to four colors. p. 42

News Scope, p. 21 . . . **Washington Report**, p. 47 . . . **Editorial**, p. 67

This readout tube never tells a lie



Others do

(and you never know when they fail)

Whatever data you input, a NIXIE® tube reads out. Exactly! You always have reliably accurate readouts, with no risk of a 1 when there should be a 7, a 0 instead of an 8, or a 3 instead of a 9. Rather than tell a lie, honest NIXIE tubes give you no reading ... protect you against false readouts caused by multiple segments that break down, blank out ... and don't indicate that they're wrong. You never know when they are faulty.

Selecting a readout display involves more than truth, so weigh every aspect. Check NIXIE tubes for their unmatched reliability, their proven long life (over

200,000 hours), natural readability, and uniform brightness (200 ft. lamberts, with no chance of partial fade-outs). See how only NIXIE tubes are unaffected by static charge ... meet mil specs ... offer unsurpassed packaging and design flexibility (no extra top leads required for decimals). All this, in the most complete and advanced line of tubes and accessories. No wonder NIXIE tubes lead the field.

For information, call or write: Burroughs Corporation, Electronics Components Division, P.O. Box 1226, Dept. N5, Plainfield, N. J. 07061; tel. (201) 757-5000.



View above display from 6 ft. distance for complete realism

the leader
in the world of displays

Burroughs



AEC develops batteries for ocean and the moon

Two thermoelectric power supplies for such widely varied uses as moon-surface exploration and deep-sea research have been developed under the Atomic Energy Commission's SNAP (Systems for Nuclear Auxiliary Power) program.

The 70-watt moon battery, SNAP-27, is fueled by plutonium 238; the ocean batteries, SNAP-21, use strontium 90 to produce heat, which is directly converted to electricity. The thermoelectric pile assemblies are being produced by the 3M Co.

The moon battery is to be left on the lunar surface by astronauts from Apollo 12—the next U. S. manned space flight. It will be used to power a number of experiments for ALSEP (Apollo Lunar Surface Experiments Package). This 200-pound package will measure seismic-wave velocities, positive ions and electron-flux variations, the moon's magnetic field and the magnetic properties of the moon's core and its mantle.

The AEC project manager on SNAP-27, Bernard J. Rock, says the

radioisotope thermoelectric generator will weigh 43 pounds fully fueled. It will contain 8.36 pounds of plutonium 238 to supply 1480 thermal watts of power. The generator will be placed in the Apollo 12 package, but the radioactive fuel capsule will be carried in a lead cask mounted on one of the legs of the Lunar Module.

Using a special handling tool, one of the astronauts from Apollo 12 will lift off the fuel capsule and insert it into the generator. The unit is designed to provide power for at least a year for ALSEP and its telemetry equipment.

The underwater batteries are designed to power navigational aids, sonar beacons, seismological stations and oceanographic research. They can operate for 5 to 10 years at 22,000 feet, but are now being tested at depths of 500 feet or less, according to the 3M Co.

The underwater nuclear generators use the ocean environment to dissipate the heat generated by radioactive decay. These units will be monitored continuously to determine their long-term behavior in free-flowing water, and when buried in the ocean bottom and placed where there is considerable marine growth. They eventually will be recovered for laboratory analysis and evaluation.

Each of the underwater units is 16 inches in diameter, 28 inches high and weighs about 700 pounds, including shielding and a pressure vessel.

'Laser circuitry' explored in the lab

Light may take the place of electricity in some of the integrated circuits of the future, according to scientists at Bell Telephone Laboratories. They have used a simple prism to couple laser light into thin crystal films that, they say, "may

be the forerunners of miniature laser circuits."

In their experiments, they placed a prism parallel to the film, but at a precise distance from it. As they predicted, the light waves passing through the prism are not wholly reflected in accordance with the laws of conventional optics. More than 50 per cent of the light energy "tunnels" through the gap between the prism and the film and generates electromagnetic fields on the film.

Future communications systems using laser amplifiers, light modulators, harmonic generators and parametric oscillators may be useful in thin-film form, says Bell Laboratories. If that time comes, the ins and outs of light energy from such thin films may be accomplished with one of the oldest optical tools: the prism.

New Navy plane facing the ax in Congress

A new Navy carrier plane, the E-2C, may become an early casualty in the current Congressional drive to cut Defense Dept. funds.

Designed as a follow-on to the carrier-based early-warning E-2A, the C model has not been recommended for production by the Senate Armed Services Committee in its report to the Senate.

The Navy will continue to fight for the new aircraft with its improved radar because of the good record its predecessor chalked up in Vietnam. (See "New E-2A radar to take less for granted," ED 17, Aug. 15, 1968, p. 46.)

Sent over to guard the fleet, the E-2A directs other aircraft, acts as a command and control station for controlling air strikes, guides fighters to tankers and finds pilots downed in the sea.

The Senate Committee has turned down the Navy's request for production of the E-2C because an Airborne Warning and Control System (AWACS) is in the works for the Air Force; the committee feels two such planes would be redundant. But the Navy sees a world of difference between the two—the E-2A is based on a carrier while AWACS will be as large as a commercial Boeing 707 jetliner.

Sources close to the Senate committee said that among its other

Stand by for Apollo

The biggest engineering story of the century—Apollo 11's fantastic success—splashed down too late for full, careful coverage in this edition of ELECTRONIC DESIGN. Rather than print a piecemeal account, we are planning a 20-page special Apollo moon section in the Aug. 16 issue of the magazine. It will include an interview with NASA's deputy director of the Apollo program, George H. Hage, and a look at what NASA plans in the next decade. Don't miss it.

reasons for spurning the E-2C were these: money is scarce, and it's the "in" thing to do this year to be hard-nosed about defense requests.

The House Armed Services Committee could breathe life into the E-2C and could make it a full-blown program again, if it could make the Senate committee change its mind.

One strong argument for the E-2C is that it exists; a prototype is flying, and its AN/APS-111 radar has demonstrated an improved capability to pick up low flying targets over land (once impossible to do with radar, because of interference from the ground).

AWACS, on the other hand, is a long way from becoming hardware; it is still a controversial design. The radar hasn't been selected yet, and its R&D budget has been reduced.

Another plus for the E-2C is that \$30 million has already been spent on it since Grumman Aerospace received a letter contract for the work in June, 1968.

Solid-state alarm to speak its warning

A solid-state memory that can speak to an airliner's pilot or a ship's captain and warn him of a malfunction is being developed.

Heretofore, voice-warning systems have been essentially tape-recorded messages. The new alarm digitizes, compresses and stores voice sounds in a microchip memory.

The design calls for the alarm to issue a voice signal, such as: "Fire in left engine." This alarm is activated by warning sensors placed at critical monitoring points in the engine and circuitry. Sensor signals are read out, expanded, converted from digital to analog, and spoken from a microphone.

The alarm is being developed by the Multiplex Systems Div. of Instrument Systems Corp., Huntington, N.Y.

A manager of digital systems at

Multiplex, Ephraim Laifer, says his group is now working on the problem of compressing the millions of bits in a simple spoken phrase to a practical size. To do this, redundancies in the various words are being studied and catalogued.

Laifer estimates that a 1-million word digital vocabulary can be compressed into a 1000-word solid-state memory. For the warning system, he feels that 100 8-bit words will be stored on less than 50 microcircuit chips.

The new talking memory uses techniques created by Instrument Systems Corp. in designing and developing the passenger service and entertainment system for Boeing's new 747 superjet, which goes into airline service later this year.

The prototype memory stores 64,000, 8-bit words, which gives 3.6 seconds of fast talking.

2-trillion-bit memory will use videotape

The U. S. Dept. of Defense has placed a \$4.1-million order for an on-line, random-access bulk computer memory system with a storage capacity of two trillion bits.

The new memory, called the terabit memory (TBM) system, adapts videotape recording techniques to computer technology.

Work has been under way since 1966 at Ampex Corp., Redwood City, Calif. Dr. William A. Gross, vice president and general manager of Ampex's Research and Advanced Technology Div., says the storage capacity of the system is about 1000 times greater than that of the largest random-access erasable and updatable memory system available today.

The conventional videotape recorder uses four recording and playback heads mounted on a small metal disc that rotates perpendicularly across the moving tape for recording or playback. The TBM system uses eight heads in a similar configuration. It achieves very high data packing density with recording bits that are shorter and narrower and with data tracks that are much closer together than is practical with standard computer tape transports.

The system stores up to 50 million bits of coded information on

each of 36 reels of standard 10 1/2-inch videotape. Each reel has approximately 1000 times the storage capacity of a single standard computer tape reel.

An experimental model storing 10¹¹ bits has been built and tested. Data accuracies are such, Ampex reports, that only one uncorrectable error occurs in approximately 10¹¹ bits.

Computerized carver aids ship-model studies

A small computer controls a milling operation that makes boat models out of large blocks of wood. The models are being used to study hull design, propulsion and the motion of ships that may someday ply the waterways of the world.

A spokesman for Digital Equipment Corp., Maynard, Mass., manufacturer of the computer, says it is physically impossible to make these models symmetrical without the computer to monitor the cutting.

A machine-control unit in the operation transfers computer information to a milling machine.

The PDP-8/1 computer, which controls all the cutting, is equipped with a disk, an arithmetic element, a real-time clock, 8192 words of core memory and an X-Y plotter and tape recorder.

The division of Mechanical Engineering at Canada's National Research Council in Ottawa, Ontario, is using the computer to prepare milling instructions for test models up to 25 feet long.

Standards to be studied for medical electronics

The increasing use and growing complexity of medical electronics has created a pressing need for standards for this equipment, says the United States of America Standards Institute in New York City. The institute has formed a committee to coordinate the safety and performance of apparatus used in hospitals and doctors' offices.

The following equipment will be considered by the committee: prosthetic devices, monitorial devices and analytical devices.

The first meeting of this committee is expected to be held in the fall.

In the power tetrode field we're defining the state of the art by demonstrating intermodulation distortion better than any other known tubes. In 1966 we introduced the 4CX1500B, a 1.5 kW tetrode with the highest linearity then known: better than -40 dB 3rd order IM distortion. Since then we produced the 4CX600J, a 600 watt tube with -45 dB 3rd order IM products—without feedback—and later a 5 kW tetrode with the same figure. Now the latest tetrode in our program, a 15 kW tube, exhibits -40 dB 3rd order IM products. We can show IM distortion improvements from 10 to 20 dB in a practical quiescent plate current range.

Other tetrodes now under development will deliver up to 40 kW with linearity as high as -45 dB IMD, according to preliminary data. Such performance advances are part of a long range program employing computer-assisted design studies to optimize internal tube geometry—all part of our plan to insure you get state of the art products every time you buy from Eimac.



Contact your nearest Varian/Eimac distributor or ask Information Operator for Varian Electron Tube and Device Group.

**No tetrodes
with higher
linearity.**



LSI testing is a large-scale headache!

By Elizabeth deAtley, West Coast Editor

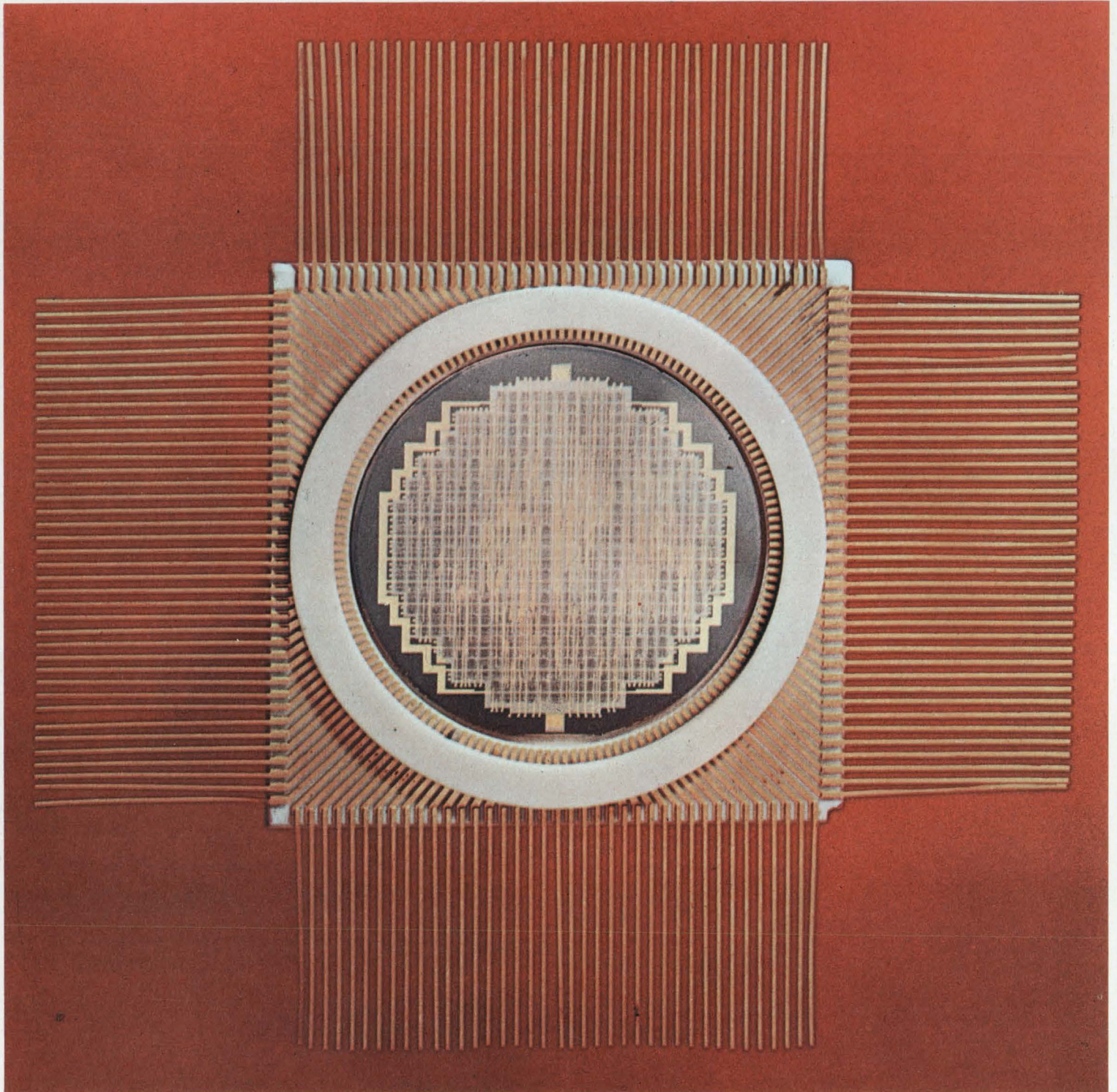

Texas Instruments' standard LSI package contains 156 leads. A wafer with hundreds of logic functions is processed through one level of metal interconnects and

probe-tested. The positions of any defective logic cells are stored in computer memory and the customer's logic array is built by interconnecting the good cells.

Harried users and manufacturers are leaning on printed-circuit-board experiences for relief

One of the major problems facing manufacturers and users of custom LSI (large-scale integration) today is testing. So serious is this problem that some experts fear it may offset the reduction in system cost that can be achieved with this technology.

From the standpoint of testing, an LSI array with 100 gates resembles a printed-circuit board with about 50 IC's. But there is one big difference: You can't probe inside an LSI array. Its only test points are the inputs and outputs.

Confronted with the problem of testing such arrays, manufacturers and users are asking themselves:

- What can we measure from the inputs and outputs that will distinguish good arrays from bad ones?

- What hardware do we need to make the tests?

Their search for answers is causing cross-fertilization between PC-board technology and custom LSI. Software techniques used by large system houses to develop PC-board testing programs are being applied to LSI. Conversely, LSI testing hardware now under development can be used to test PC boards.

Custom-design problems

Any complex unit is difficult to test. But custom LSI presents particular problems. To understand why, consider the trade-offs a designer faces as he partitions a logic system into LSI. His primary limitation, for reasons of cost, is the silicon area he can use for each array. The more area for each array, the lower the manufacturer's yield and the higher the cost. Very regular functions, such as storage elements, require relatively little area compared with random control logic, so the designer may find it convenient to use storage elements redundantly. Instead of putting the whole accumulator, for ex-

ample, in one array, he may place parts or all of it in each of several arrays. If he is using MOS technology, the outputs will take up more area than the inputs because each output requires a large buffer to supply current to the outside environment. Therefore he will juggle the logic to have more inputs than outputs, if he can.

If he follows the rules carefully, his finished arrays will very likely contain a number of storage elements and inputs. But because he partitioned his system with a view to minimizing area, probably none of the arrays will have a clear-cut function.

The designer can't use a functional test with an array that has no function. What can he use? If he knows what inputs the array will meet in his system, he can confine his test program to these. But very likely he won't be sure that any of the possible input combinations are constrained in his system. He can play it safe and include all possible input combinations in his test program. But then the number of tests becomes an exponential function of the number of inputs.

If n is the number of inputs to an array, 2^n is the total number of input combinations possible. Furthermore an array with m internal states can assume any of 2^m combinations of those states. In the worst case, for every possible combination of internal states, the array could meet any or all of the 2^n possible input combinations. Thus, to test an array exhaustively with n inputs and m internal states, the designer would have to apply 2^{m+n} sets of tests.

For an array with 75 inputs and 25 storage elements, that would be 2^{100} or 10^{30} sets of tests. At a rate of 10,000 tests a second, the total test time for each array would be more than 10^{19} years—or about 1 billion times as long as the

universe is believed to have existed! And packages with far more than 75 inputs are already here. Texas Instruments' standard LSI package, for example, has 156 leads, 126 of which can be either inputs or outputs.

Fortunately it is not necessary to apply all possible input combinations multiplied by all possible internal states to test an array thoroughly. What one really wants is not a complete truth-table exercise of the logic, but a set of tests that will cull bad arrays. Even a single set of input combinations may spot a number of different faults. So the problem reduces to finding a reasonable number of input combinations that will find all or most faults.

PC tests are a guide

To find this reasonable number of tests, semiconductor companies have turned to the sophisticated, automatic techniques that large system houses—like IBM—have developed for PC-board tests.

Some of the largest semiconductor houses—Texas Instruments, Fairchild, Motorola and Autonetics—have developed programs of this sort. Most of these programs are interactive—that is, they employ computer aids and semi-automatic routines to supplement the designer's ingenuity. In addition to interactive programs, a few companies claim fully automated test generation capabilities, but they guard their algorithms tightly.

Typically the interactive programs give the designer a software simulation of his logic that he can use for two purposes: (1) To verify that his logic diagram does the job he requires, and (2) To assist him in generating test patterns that will separate the good arrays from the bad. To verify his logic, he selects a number of in-

put/output patterns, applies the inputs to the simulator and checks the outputs this produces with the outputs he requires.

Isolating bad arrays

Once the designer is satisfied that the simulated array meets his logic requirements, he must generate a set of tests that will cull faulty arrays from good ones. Chances are that the set of input/output patterns he has already developed to verify his logic will spot many of the common faults. But to find out how many and what additional tests are necessary, he needs some systematic way of modeling faults. One common approach is to assume that a number, N , of faults can occur one at a time and to simulate $N + 1$ arrays—one for each of the N -assumed faults plus one good array. Input patterns—generated either by the logic designer or by automatic techniques—are applied to the $N + 1$ simulated arrays, and the computer keeps a record of the faults that

have *not* been detected by the applied inputs. In addition the computer may use algorithms that minimize the number of inputs needed to detect a set of faults.

What to simulate?

The designer's first problem is to decide what faults to simulate. John Fike, former manager of the Functional Test Section, Design Automation Dept., Texas Instruments, Dallas, and now with Telpar, Inc., of Dallas, says:

"First, we must admit that we can't possibly model or even imagine everything that can possibly go wrong. All kinds of crazy things can go wrong. For example, suppose we have an array which we mount in some kind of package and then we ball-bond it between the array terminals and the package pins. Suppose the assembly-line girl interchanges those bonds, or suppose she offsets every one. This is clearly a class of fault that could occur, but it would hardly be worth your while to model it specifically."

Faults of this kind are readily caught by visual inspection, Fike notes.

Most logic designers, he says, will accept a test that "exercises" each node in a circuit at least once—that is, causes it to go from ONE to a ZERO and back again—provided this fact can be detected by a change in the outputs. Such a test proves that none of the nodes is permanently stuck at a ONE or a ZERO condition.

Those who use this approach—and it is widely used—defend it by saying that most failures in a logic system will manifest themselves as a stuck-at-ONE, stuck-at-ZERO condition at one of the nodes.

"For example," says Dr. Charles Meyer, manager of IC modeling and diagnostics at Motorola's Semiconductor Div., Phoenix, Ariz., "if the collector of an output stage in a DTL circuit is shorted to ground, the output will be held at ZERO regardless of the input. Similarly, in the same circuit if the collector is open and you have just a resistor going to the power supply, that point is stuck at ONE."

One fault at a time

The stuck-at-ONE and stuck-at-ZERO faults are assumed to occur singly. Why? Partly because it would be too much work to assume they occurred in combination. "After all," Fike points out, "250 failures taken even just two at a time in any combination is a pretty big number." However, the experts generally agree that an input pattern devised to catch stuck-ONE, stuck-ZERO faults that occur singly would also spot most of the faults that occur in pairs. If you don't believe it, they say, you can try assuming faults two at a time and see how many of these combinations are not spotted by tests devised with the single-fault hypothesis.

"Most of the exceptions to this general assumption contain redundant circuitry," says Dr. Edwin Jones, a member of the technical staff of Fairchild Research and Development, Palo Alto, Calif. "If you have redundant circuitry, one part of the circuit can fail and the other part takes over, so you can't test to make sure the whole array is working."

Suppose you want to use computer aids to generate your own



"Our approach to hardware is that if you want to know whether a device will operate at 1 MHz—or 10—test it at that speed. —Gene B. Rosen, manager, Instrumentation Systems, Mellonics Systems Development Div., Litton, Sunnyvale, Calif.

Register here:

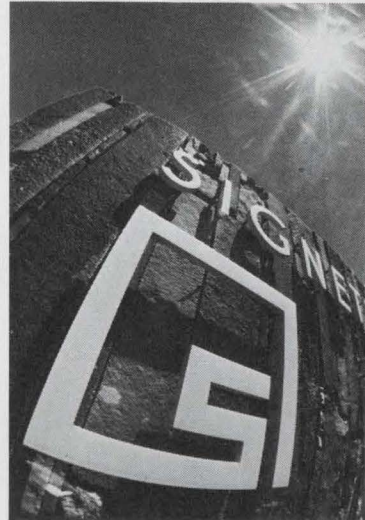

In fact, there are lots of registers here. Because nobody but nobody makes more — or more magical — registers than Signetics.

Take our 8270/71. We pack more capability into it than any other 4-bit shift register on the market today. (Think a minute. Do you know another single one that's fully synchronous, with parallel, serial input or output? And a clock rate to 20 MHz? And a common reset line? And separate load and shift lines to eliminate clock skew problems? And a "HOLD" state to allow free-running clock?)

Then there's our 8275: the transfer register we call a quad latch. And 8276: our serial-in, serial-out, 8-bit shift register. Unlike competing devices, it's the only register that actually prevents the transfer of data from master to slave sections of all eight flip-flops! Result: it lets you "stop the clock" internally.

And coming soon: the 8200/01 dual 5-bit buffer register. Plus the 8202/03 10-bit buffer register! For specs, diagrams, other data on our magic-making family of registers, just register your interest — by dropping us a line.

Today. The sooner you register, the sooner we can win your vote!

More
complex magic
from

Signetics  **MSI**

Signetics Corporation / 811 E. Arques Ave., Sunnyvale, Calif. 94086/A subsidiary of Corning Glass Works

INFORMATION RETRIEVAL NUMBER 19

(LSI, continued)

test programs? You can either work with one of the large semiconductor houses (in which case you would order your arrays from that company) or you can obtain software assistance from any of several other companies not in semiconductors. Three of these are Mellonics Systems Development Div., Litton Systems, Inc., Sunnyvale, Calif.; Telpar, Inc., Dallas, Tex., and E-H Research Laboratories, Oakland, Calif.

Parallel hardware needed

Once you have devised a set of tests that will exercise every node in the array and produce a corresponding change in the output, the next problem is to design the hardware to carry out the tests. A test program may vary in length from about 20 to 500 tests for each pin, depending on the complexity of the array.

Because of the many pins and the number of tests for each, much parallel hardware is necessary to minimize the testing time. But MOS arrays impose an additional constraint on testing time. These devices lose their internal storage if they are operated below a certain minimum frequency—usually around 10 kHz. Thus the test rate on such devices must exceed 10 kHz.

One method of making operational tests on an LSI array at well above this rate is to use a computer-controlled system. In this the test program is commonly loaded, one word at a time, from core memory into a set of storage registers. Each stage of each register is attached to one pin of the array. The contents of the register are strobed into the array, and the results at the outputs are returned to the central processing unit of the computer. The next set of tests is then loaded into the storage registers, and the process is repeated.

The test rate of such a system is determined by the cycle time of the computer, the word length of its memory and the number of pins on the array. Typically the test rate may vary from 10 to 50 kHz.

If, in addition to the operational

tests, dc parametric tests are made on certain pins, this will slow the test rate considerably. In a dc parametric test, a current is forced onto a given pin and the voltage is measured, or vice versa. To make precise measurements of a range of voltages or currents, a very accurate, programmable power supply is required. For economic reasons, the power supply is shared with all the pins through a relay matrix. The maximum speed is limited by the closure time of the relay matrix to about 1.5 milliseconds per test. For this reason, MOS manufacturers normally do not apply dc parametric tests. Instead, they test-load capability by operating the array with the maximum specified load on each pin.

Dynamic testing a problem

The real hardware headache is dynamic testing of LSI arrays—that is, testing their speed capability. On this subject, the experts line up in two sharply opposing camps: (1) Those who believe that dynamic testing should be done on a sample basis only, and (2) Those who insist that all units must be dynamically tested. Representatives of both camps often coexist within the same company.

Gordon Padwick, functional test systems engineering manager of Fairchild's Instrumentation Div., Sunnyvale, Calif., belongs to the first camp. He feels that arrays should be specified conservatively for dynamic performance so that, if they pass the operational tests at any speed, they will almost certainly work at the maximum speed. Many of those who test bipolar LSI at both Fairchild and Texas Instruments agree. For example, Jerry Jeansonne, senior engineer, Advanced Integration Programs, Texas Instruments, Dallas, says:

"We spec speeds very conservatively, so that if the device will pass the operational tests, usually it will work at high speed. Then, in addition, we try to verify by probe tests on individual gates on the wafer that the array will work at high speed. If we need an h_{fe} of 15, for example, we test for 30."

Jeansonne points out that, in addition, TI sample-tests certain paths for speed when necessary, using a sampling scope for very

fast arrays.

Those who believe in 100% dynamic testing of LSI arrays generally recommend one of these hardware approaches:

- Perform the operational tests at the maximum specified speed.

- Perform these tests at a rate that is convenient to implement in hardware, and strobe the outputs at a specified time after the input. This way you can determine whether the propagation delay from input to output is within the specified limit.

- Measure the propagation delays through every path of interest.

Testing at maximum speed

Since the top speed of most MOS random-logic arrays is 2 MHz or less, it is feasible to design equipment that will test such arrays at their maximum rated speed. For this reason, most manufacturers of this type of MOS array—Texas Instruments, General Instrument, Autonetics, American Microsystems and others—have gone the high-speed route. They have designed expensive in-house equipment that will perform operational tests at a rate varying from nearly dc to 1 or 2 MHz.

The commonest way of doing this is to store the entire test pattern for each pin in a separate shift register. The pattern for each input pin is applied, one test at a time, to that pin from the output stage of the attached shift register. The required pattern for each output pin is also stored in a shift register, and it is compared at each clock time with the corresponding output of the array. This is normally done by strobing a comparator at some specified moment during each clock time. This allows the designer to verify operation at maximum speed and also to determine whether the outputs have changed state within the specified time.

A non-computer-controlled test system of this type is American Microsystems' new PAFT, now available through Redcor, Los Angeles. In this system, test patterns are stored on paper tape and loaded into high-speed, 200-bit recirculating shift registers, which feed the word patterns to the inputs and

outputs of the array. Also programmed onto the paper tape are the clock levels, power supply voltages and input/output ONE and ZERO levels. The machine can vary these automatically to test high and low voltage limits. The system has 60 input/output channels, four power supplies and an option of either two or four clocks. Thus it can accommodate a four-phase device with up to 68 pins. Its clock rate can be varied from 2 Hz to 2 MHz. The total cost for a four-phase system is about \$100,000.

A very complex high-speed computer-controlled system was announced at the IEEE show in New York last March by Texas Instruments' Industrial Products Div., Houston. It can supply 500-bit recirculating word patterns simultaneously to 120 leads of an MOS device, with speeds up to 2 MHz. A future modification will be able to test a 120-lead bipolar array with shorter word patterns—probably about 16—at speeds up to 25 MHz. Each output has a variable-position strobe with a 5-ns window that can be positioned in 1-ns increments from 1 ns to 1 s. Thus it can check propagation delays on a go-no-go basis even in arrays that are faster than the maximum test rate. The entire system, including Texas Instruments' APC computer, peripherals, MOS high-speed test capability and a dc parametric unit, would cost around \$300,000, says Robert Renker, manager of TI's Parametric Test Section.

120-MHz test rates?

Is 2 MHz fast enough for speed-testing? Already MOS designers would like 10 MHz to test some fast shift-register arrays. What will the speed-test enthusiasts do when the day comes—as it surely will—that LSI arrays are built with emitter-coupled logic circuits capable of operating at 120 MHz? These are questions many engineers are asking. Some who are involved with testing very fast circuits of medium-scale complexity (about 50 gates) question not only the practicality of testing them at maximum speed but also the adequacy of such tests.

For example, Owen Williams, product development manager, Digital Integrated Electronics

Dept., Fairchild Research and Development, Palo Alto, Calif., points out that testing at maximum speed will not always uncover race conditions. For example, in a clocked system, all the required inputs must be at every gate by clock time. If the propagation delays through certain paths are either slower or faster than the design tolerances allow, the system will fail. Williams says that although race conditions within the array can be detected by high-speed testing, *system* race conditions, which occur between one array and

another, cannot.

"For example," he explains, "let's suppose we have two arrays and the system clock arrives at the first array before it gets to the second, because the two paths are of different length. Let's say the output of the first array is tied directly to the input of the next, so there is no delay between the two arrays. When the clock arrives at the first array, the output of that array changes from ONE to a ZERO. That information is fed immediately to the input of the second, causing it to change from

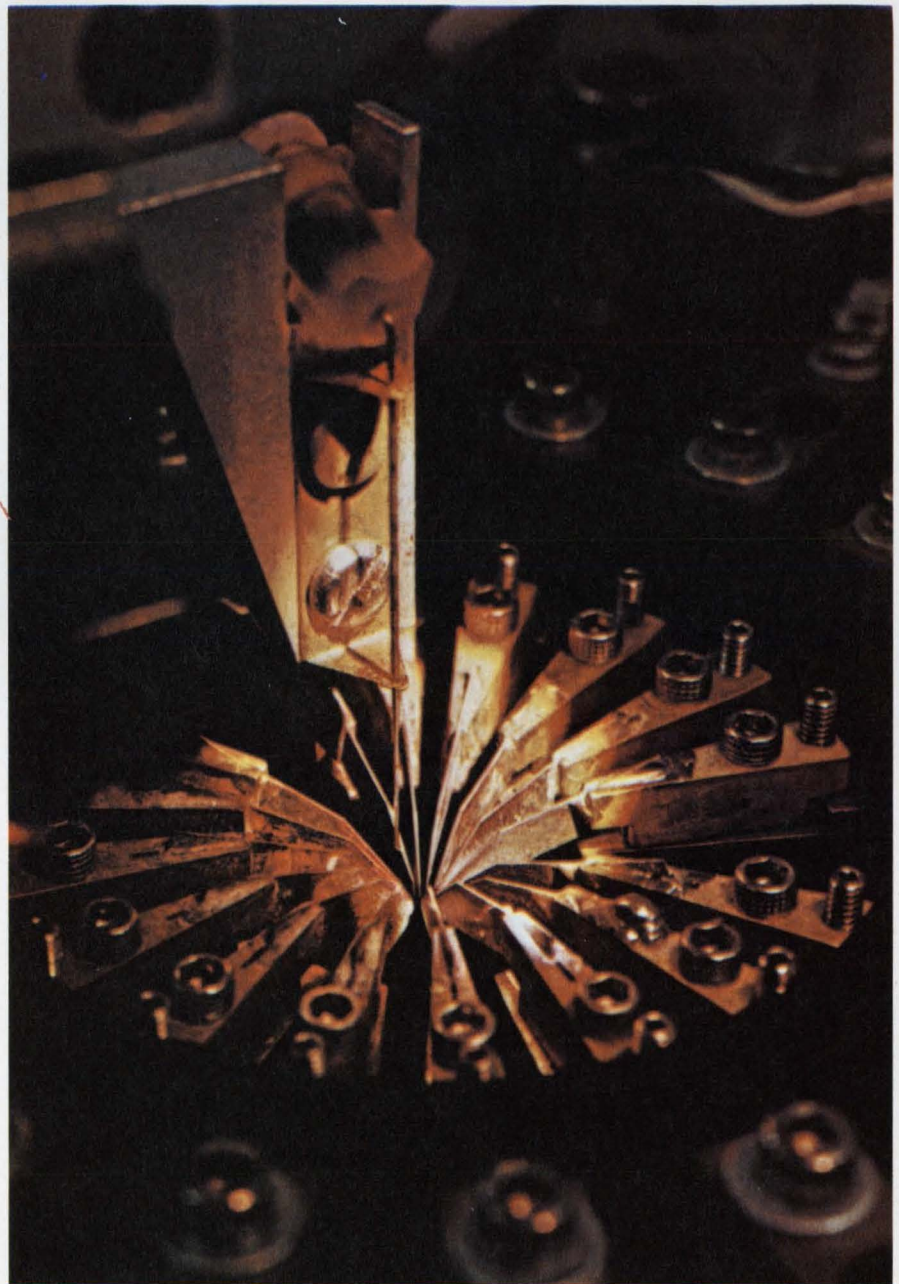

A complex array for dc and functional testing is probe-tested on the production line at Fairchild Camera and Instrument Corp.

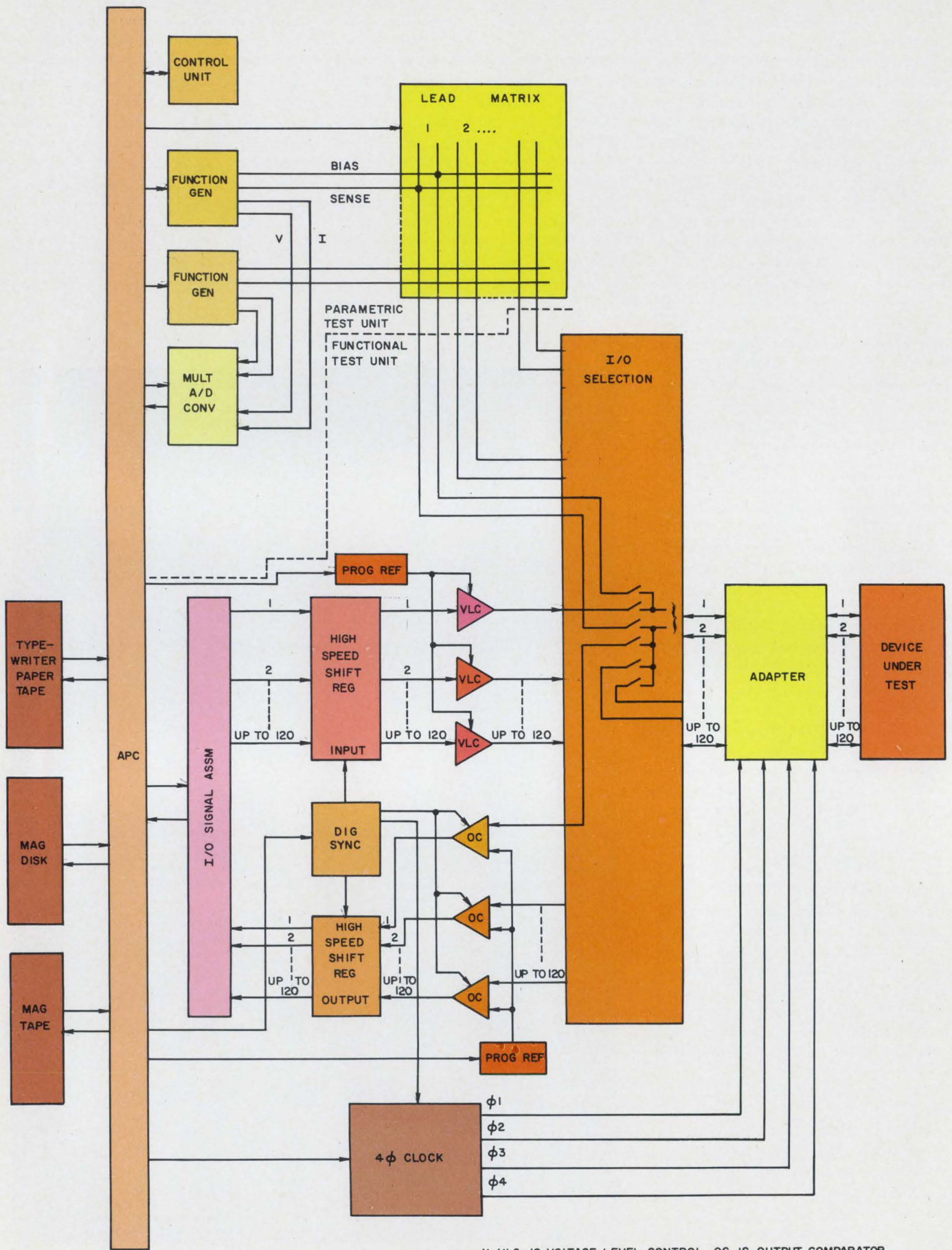

* VLC IS VOLTAGE LEVEL CONTROL, OC IS OUTPUT COMPARATOR

LSI tester can test up to 120 MOS leads at a 2-MHz rate. It's Texas Instruments' Model 561.

(LSI, continued)

a ONE to a ZERO also. Then, after a delay, the clock arrives at the second array, and that ZERO is erroneously clocked in. If the clock had arrived simultaneously at the two arrays, this would not have occurred."

Williams explains that this situation is less likely to occur in relatively slow arrays, like MOS, because "the skew in the clock system is somewhat offset by the propagation delays through the arrays."

"For example," he continues, "when the clock arrives at the first array, the output takes some time to respond. The more time it takes, the more skew you can afford in your clock. But in Current Mode Logic, where you have 1-nanosecond propagation delays through an array, you have to have a pretty tight-skew system."

This type of problem can be found only by measuring the propagation delays through the critical paths, Williams says.

He points out that testing straight operational capability at a slow rate can also cause problems in very fast circuits. A noise spike on a slow rising or falling waveform at the input to such a circuit can easily cause it to trigger. Thus the waveforms for the operational tests must be applied from high-speed pulse generators "with 1 nanosecond rise and fall times and 50-ohm terminations." This can be done today for medium-scale circuits, Williams says, because there are only a few different types and they are built in large volume. Thus it is feasible to build special test boxes with fast pulse generators and 50-ohm terminations for each type of device. But what about the ultra-high-speed custom LSI of tomorrow?

Strobing the outputs

One approach to testing such arrays is to perform the tests at a rate dictated by the hardware but to use input pulses whose rise times are fast compared with the switching time of the gates in the array. A high-resolution strobe is



Engineers — are your hands tied?

Frustrated by the limitations of the average inductor? Nytronics research and development have created an inductor line that unties their hands, and their imaginations, to reach for hitherto unattained heights of quality and performance. An inductor line that is as close to perfection as it is possible to come.

NEW!

WEE CHIP-INDUCTOR—Magnetically shielded, wrap-around termination permitting contact to either face or ends. Designed to meet MIL-C-15305, Grade 2, Class B. .280" x .195" x .100". Presently available .15 μ H to 1000 μ H.

NEW!

PEE-CEE-DUCTOR—Magnetically shielded Fixed Inductor—Range 0.1 to 100,000 μ H. Designed to MIL-C-15305, Grade 1, Class B. Epoxy molded 0.300" diameter x 0.270" height. Printed circuit mounting—0.200" grid spacing and unit has shielded construction to allow maximum density packaging.

MILI-DUCTOR—Subminiature Unshielded with Inductance Range 0.1 to 1000 μ H. Designed to MIL-C-15305, Grade 1, Class B. Molded Envelope: .095" diameter x 0.250" length.

MS LINE 90537 TYPE—Manufactured in accordance with MS90537, Molded Magnetically shielded with inductance range 0.1 to 100,000 μ H \pm 10% tolerance. Molded Envelope: 0.163" diameter x 0.410" length.

WEE-DUCTOR—Magnetically shielded with inductance range 0.1 to 180,000 μ H, designed to MIL-C-15305, Grade 1, Class B. Encapsulated Envelope: 0.157" diameter x .450" length.

SUPER WEE-DUCTOR—Manufactured in accordance with MIL-C-15305, Grade 1, Class B. Molded magnetically shielded with inductance range 0.1 to 100,000 μ H \pm 10% std. tolerance. Other tolerances and lead materials available on request. Molded Envelope: 0.163" diameter x 0.410" length.

SUPER WEE-WEE-DUCTOR—Miniature shielded with inductance range 0.1 μ H to 10,000 μ H. Designed to MIL-C-15305, Grade 1, Class B. Epoxy-Molded Envelope: 0.125" diameter x 0.335" length.

VARIABLE INDUCTOR—Unshielded with adjustable range 0.1 to 4700 μ H. Designed to meet MIL-C-15305, Grade 1, Class B. Encapsulated Envelope: 0.400" diameter x 0.500" length. Vertical or Horizontal mounting.

■ Send for our new 44-page catalog with the quality line of standard components.



NYTRONICS, INC.

The quality line of standard components

550 Springfield Ave., Berkeley Heights, N.J. 07922 ■ (201) 464-9300 ■ TWX: 710-984-7977

INFORMATION RETRIEVAL NUMBER 20

(LSI, continued)

used to strobe the output to determine whether it has changed state within the few nanoseconds required. The higher the speed of the array, the higher the resolution required on the strobe and the faster the rise times on the input pulses must be. This technique is incorporated in Texas Instruments' high-speed tester.

One disadvantage of this approach is that it will not detect race conditions in an array that contains combinatorial logic driving sequential circuitry. For example, the set and reset inputs on a clocked flip-flop might be

driven by logic chains of different length, and the output stage of the flip-flop may be a ONE or a ZERO, depending on which is triggered first. To test an array of this type for dynamic performance, it would be necessary (1) To operate it at the maximum rate, or (2) To measure the propagation delays through many different paths and determine the unknown delays through individual gates, by setting up and solving a set of simultaneous equations.

Measuring propagation delays

The normal way to measure propagation delays is to use a bench setup with an oscilloscope.

This is obviously not suitable for testing arrays in a production environment on a 100% basis. However, it can be used to test on a sample basis, provided the scope has the resolution necessary to measure the waveforms from the array. Most MOS arrays can be measured with a standard scope, but a sampling scope is generally used for high-speed bipolar arrays. A sampling scope achieves high resolution by taking a sample of a repetitive waveform at a different point on that waveform each time it appears. It displays these samples one after another as dots on an extended time base. James Fogle, Chief Engineer, Triangle Systems, Inc., Los Angeles, explains that this is normally done by using two voltage ramps—a fast one for the samples, or dots, on the display and a slow one for the time base. The fast ramp follows the waveform in real time, whereas the slow one is produced by storing an increment of charge on a capacitor each time the waveform appears. For every slow ramp, there may be 100 to 1000 or more fast ones. Whenever the voltage levels of the two ramps are equal, a dot is displayed on the screen. Thus the actual waveform is spread out along the desired time base. A typical sampling scope takes about 100 samples per cm along the time base.

Such a technique is difficult to use with LSI. In any circuit, the propagation delay can be measured only when a change occurs at the output. But in an LSI array, the output may change only once after a long chain of input patterns, and with a sampling scope the whole chain must be repeated 100 or more times. This means a long test time. For example, if you take a minimum of 100 samples of a single output in a test pattern 500 bits long at a test rate of 10 kHz, it would require at least five seconds to measure the propagation delay through a single path.

The single-shot approach

"If you've only got one pulse, you'd better be careful what you do with it," says Robert Broughton, product manager for semiconductor test equipment, E-H Research

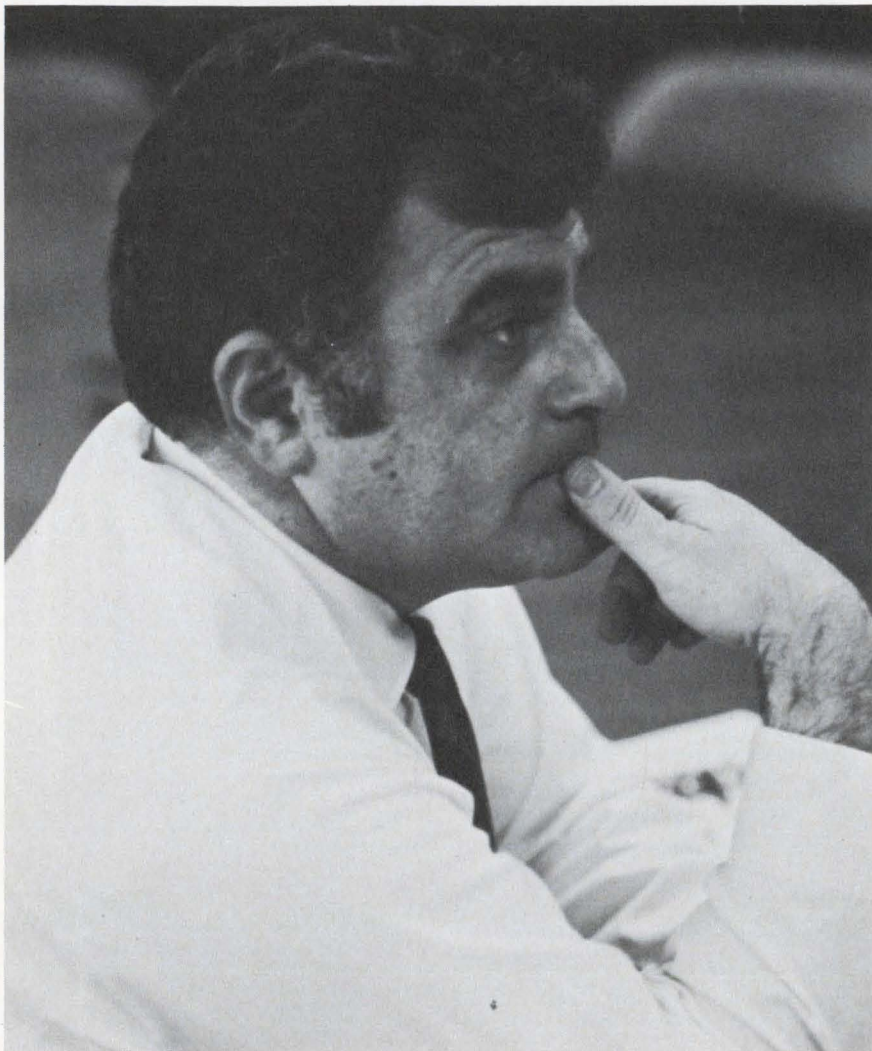

"Now that I've built the device, how do I test it? This kind of question is best resolved by the system designer before he designs the system."—Robert Sihakian, director of advanced engineering operations, Instrumentation Div., Fairchild Camera and Instrument Corp., Sunnyvale, Calif.



Desk-type hp 9100A programmable calculator. Provides dynamic range from 10^{-99} to 10^{99} with resolution to 10 significant figures, and a memory which accommodates 196 program steps. Printed circuit board from calculator shows extensive use of Allen-Bradley hot-molded resistors.

“We specify Allen-Bradley hot-molded resistors for quality, reliability, price and delivery”

Hewlett-Packard

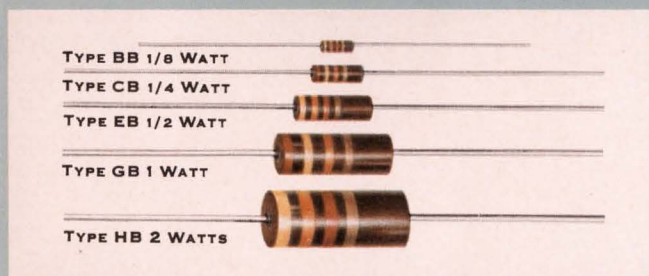

A-B hot-molded fixed resistors are available in all standard resistance values and tolerances, plus values above and below standard limits. A-B hot-molded resistors meet or exceed all applicable military specifications including the new Established Reliability Specification at the S level. Shown actual size.

The computer-like capabilities in this compact hp Model 9100A Calculator have placed severe demands on component performance. Reliability must be of the highest level.

Allen-Bradley hot-molded resistors completely meet the challenge. This is shown by the fact that they satisfy the requirements of the latest MIL-R-390008A Established Reliability Specifications at the *highest* level—the S level. This is true for all three ratings—the 1 watt, ½ watt, and ¼ watt—over the *complete* resistance range from 2.7 ohms to 22 megohms!

The unsurpassed performance of A-B resistors results from an exclusive hot molding manufacturing technique. The equipment is fully automatic—developed and used only by Allen-Bradley. The “built-in” precision control ensures the highest uniformity from resistor to resistor—year after year. Physical properties are constant. Performance is predictable.

For complete specifications on this quality line of hot-molded resistors, please write to Henry G. Rosenkranz and request Technical Bulletin 5000. Allen-Bradley Co., 1201 S. Second St., Milwaukee, Wis. 53204. Export Office: 1293 Broad Street, Bloomfield, N. J., U.S.A. 07003. In Canada: Allen-Bradley Canada Limited.



ALLEN-BRADLEY
QUALITY ELECTRONIC COMPONENTS

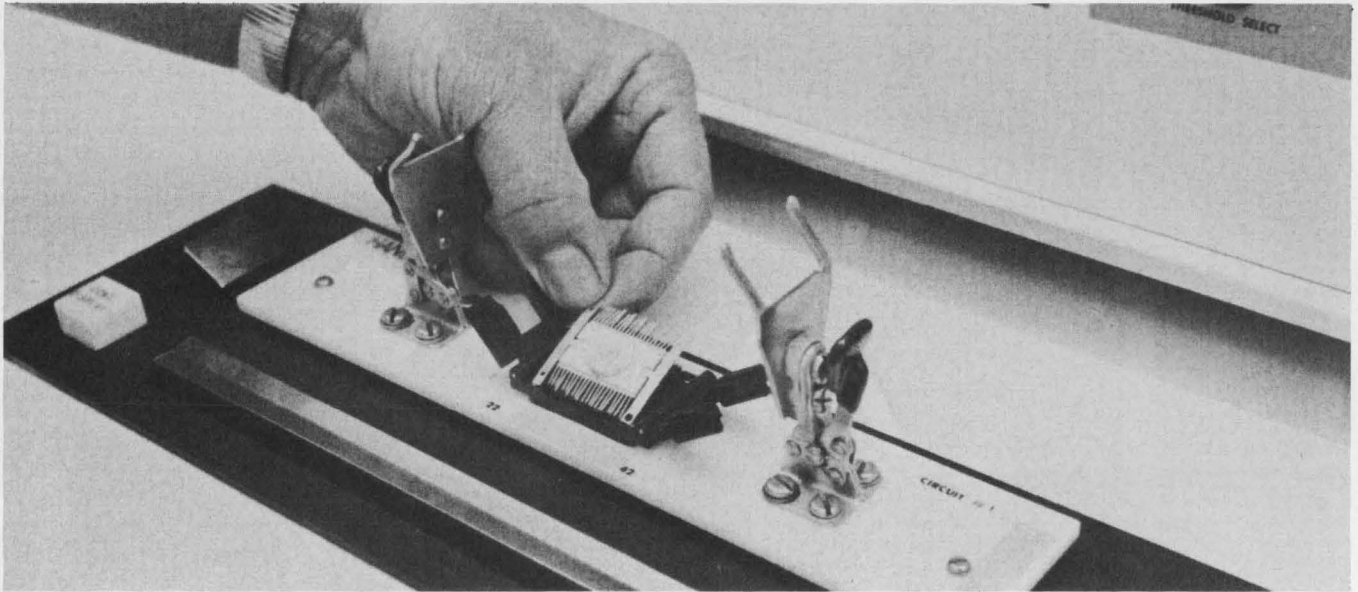

An LSI package undergoing final test at Autonetics.

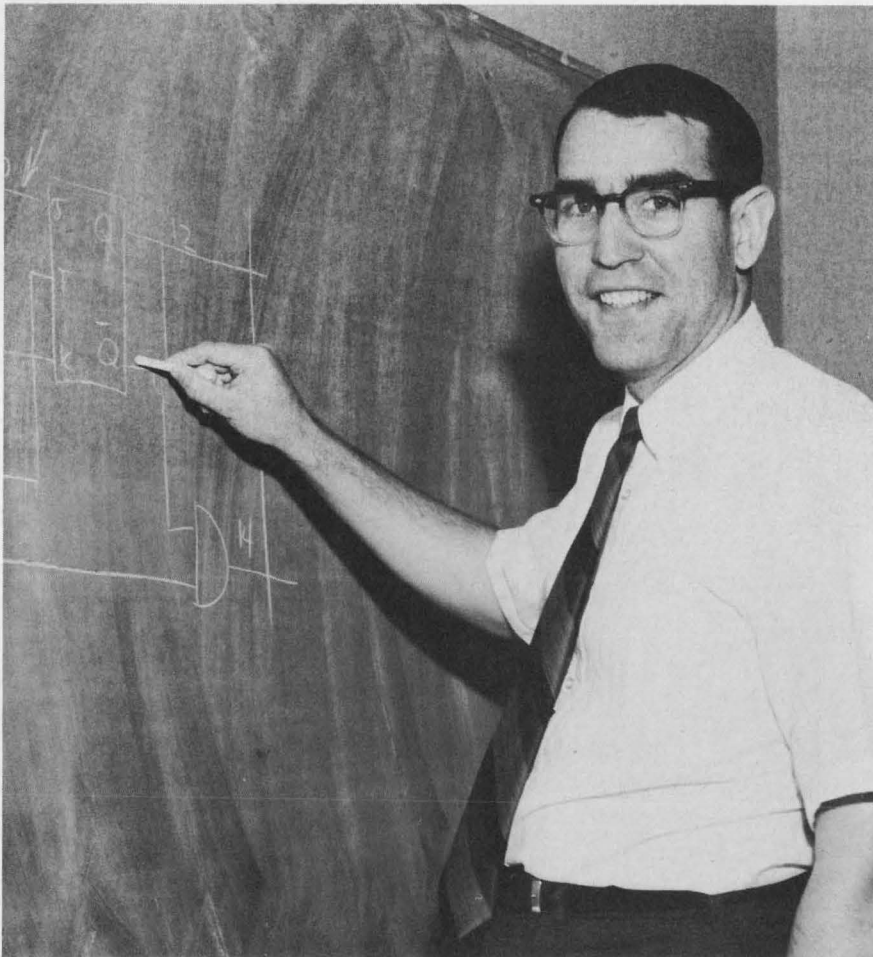

"If you've only got a single pulse to work with you'd better be darn careful what you do with it."—Robert Broughton, product manager for semiconductor test equipment, E-H Research Laboratories, Oakland, Calif.

Laboratories. E-H makes instrumentation that can measure voltage and time on a single pulse. This instrumentation includes a switching time converter with a minimum range of 1 ns full scale (maximum range of 1 microsecond), and a strobing voltmeter capable of measuring within 1% a single pulse width of greater than 4 ns.

E-H has a new computer-controlled LSI testing system, it's Model 4500, incorporating the instrumentation necessary to do time/voltage measurements and operational testing. The test rate depends on the number of input/output pins. For 32 pins, for example, the speed would be about 50 kHz, Broughton says. Under software command, the system will select the input and output terminals to be measured during each test time, perform these measurements and record the results in the computer. A system capable of testing a 40-pin device would cost between \$195,000 and \$245,000, counting the interface to an IBM 1130. The computer would cost about \$25,000 more Broughton notes, or it could be rented for about \$605 a month.

The test fixture included with the system has a rise time of less than 1 ns from input to output, strapped to the device socket. ■■

Allen-Bradley cuts space requirements with new sealed type Z cermet trimmers

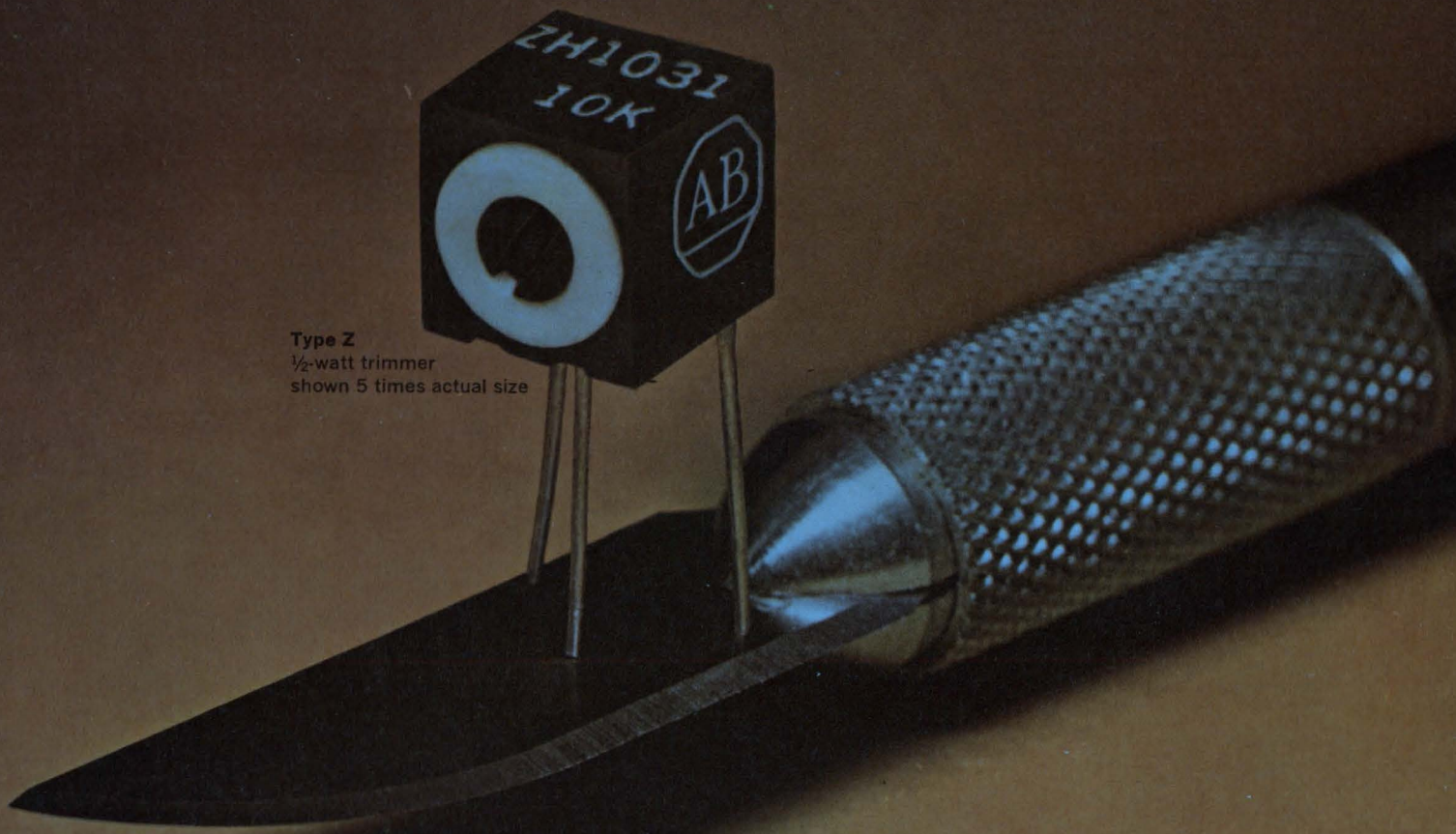

Type Z
1/2-watt trimmer
shown 5 times actual size

this latest addition to the Allen-Bradley line of cermet trimmers...the type Z...affords high performance in an especially compact package

The cermet material—an exclusive formulation developed by Allen-Bradley—provides superior load life, operating life, and electrical performance. For example, the full load operation (1/2 watt) for 1000 hours at 70°C produces less than 3% total resistance change. And the temperature coefficient is less than ± 250 PPM/°C for all resistance values and throughout the complete temperature range (-55°C to +125°C).

The Type Z is ruggedly constructed to withstand shock and vibration. The unique rotor design ensures smooth adjustment and complete stability under severe environments. The leads are permanently anchored and bonded. The connection exceeds the lead strength—opens cannot occur. Leads are weldable.

The enclosure is *SEALED*. It is both dust-tight as well as watertight, and can be potted. Mounting pads prevent moisture migration and also post-solder washout. For full specifications on this new spacesaving cermet trimmer, please write Henry G. Rosenkranz, Allen-Bradley Co., 1201 S. Second St., Milwaukee, Wis. 53204. Export Office: 1293 Broad Street, Bloomfield, N.J., U.S.A. 07003. In Canada: Allen-Bradley Canada Ltd.

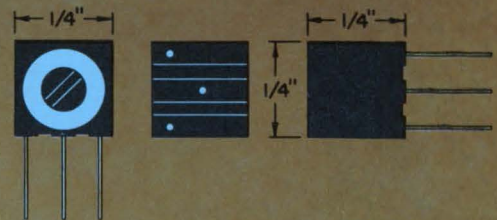

SPECIFICATIONS SUMMARY

Adjustment: Horizontal or vertical.

Temperature Range: -55°C to +125°C.

Resistances: 50 ohms through 1 megohm.
Lower resistances available.

Tolerances: $\pm 20\%$ standard, $\pm 10\%$ available.

Resolution: Essentially infinite.

Rotational Life: Less than 2% total resistance change after 200 cycles.

Rotation: 300° single turn.

End Resistance: Less than 3 ohms.





We make components for guys who can't stand failures.

You can't court-martial a capacitor or a resistor for refusing to carry out orders. But at Corning we make our capacitors and resistors for guys who are demanding enough to wish that they could.

We make components that give you an extra measure of performance. Components that let you make sure your system will deliver all you designed into it. Because like you and the guys who use your equipment, we can't stand failures either.

Take our glass capacitors, for instance. There's only one reason why they've been designed into the Surveyor, Minuteman, Gemini, Apollo, Saturn, Titan, Syncom, Sparrow, Hawk and a number of other major aerospace and missile projects. With our glass capacitors, their circuit designers could get the proven stability and reliability that these important systems demanded.

U.S. Air Force tests have established that our glass capacitors deliver much better stability and much higher insulation resistance than ceramic and mica capacitors.

And take our precision tin

oxide resistors. They're the best of the metal film class. Because the resistive tin film is completely oxidized and molecularly bonded to the glass substrate, our tin oxide resistors are impervious to moisture and environmental degradation. No other resistor can deliver the same stability and reliability over load life. They offer guaranteed moisture resistance across all ohmic values to set a standard of reliability that can't be matched by metal film, wire wounds, carbon comps or metal glaze resistors. After a 56-day-long heat test in an environment of extremely high humidity, our tin oxide resistors showed a resistance change of just 0.2 per cent. And in an ambient temperature test—now in its ninth year—not one of the 600 tin oxide resistors being tested has exceeded a resistance change of 1.5 per cent.

But don't only think of Corning for military and other precision applications. We've got something to offer when economy and value are the prime considerations. At Corning we've been active in improving these important capacitor

and resistor characteristics, too.

We've developed the Glass-K™ capacitor to give you the volumetric efficiency and economy of monolithic ceramic capacitors, but with the much improved stability and reliability that a glass dielectric can add.

In resistors, our tin oxide resistors already offer long-term economy over metal film, precision wire wound and metal glaze resistors. And our new C3 resistors, in addition to giving you a small case size, compete costwise with carbon comps.

At Corning we make components for guys who can't stand failures. Guys like your most important customers. Guys like you. So, next time you're designing a system, reach for your CORNING® capacitor and resistor catalogs and call your local Corning authorized distributor for off-the-shelf delivery. They'll help you design-in that extra measure of performance.

If you don't have our catalogs, ask your Corning distributor for copies or drop us a line at: Corning Glass Works, Electronic Products Division, Corning, New York 14830.

CORNING
ELECTRONICS

INFORMATION RETRIEVAL NUMBER 23

Area navigation: Relief for air traffic jams

20-year old system, revived by FAA and aviation industry, lets pilots 'move' airways electronically

Jim McDermott
East Coast Editor

A giant step towards reducing air-traffic congestion has been taken by the Federal Aviation Administration in its recent sanction of area navigation—a system that permits the pilot to tune in any of 600 VOR/DME navigation stations along the airways and "move" the station electronically to any point he wishes within range. As a result, he is no longer restricted to flying the airways prescribed by the station. Instead, he can fly courses removed from, but parallel, to these airways.

The immediate benefit is the creation of hundreds of additional

airways for any aircraft equipped with area navigation equipment.

A new FAA advisory circular establishes equipment requirements and guidelines on area navigation.

Tried originally, some 20 years ago by the Government at an experimental center in Indianapolis, the concept was abandoned, according to Allen Morrissey, chief of the evaluation staff, FAA Flight Standards Service, because of equipment limitations and because the large network of VOR/DME navigational stations available today simply wasn't around at that time.

But within the last two years the system has passed experimental trials conducted by the

FAA and by three airlines—American, Eastern and United. Area navigation is making its debut in a rare show of agreement between the FAA, the airlines, general aviation (all flying except that done by the airlines and military) and the avionics industry. There is unanimous agreement that the new system provides traffic relief both en route and in terminal areas.

So far area navigation is the only system in sight that can increase air-traffic capacity without additional Government funds for new ground facilities—because it makes use of present facilities and because the cost is borne by the user. And the system can be used as fast as equipment becomes available.

But area navigation won't give the airlines actual relief for a year

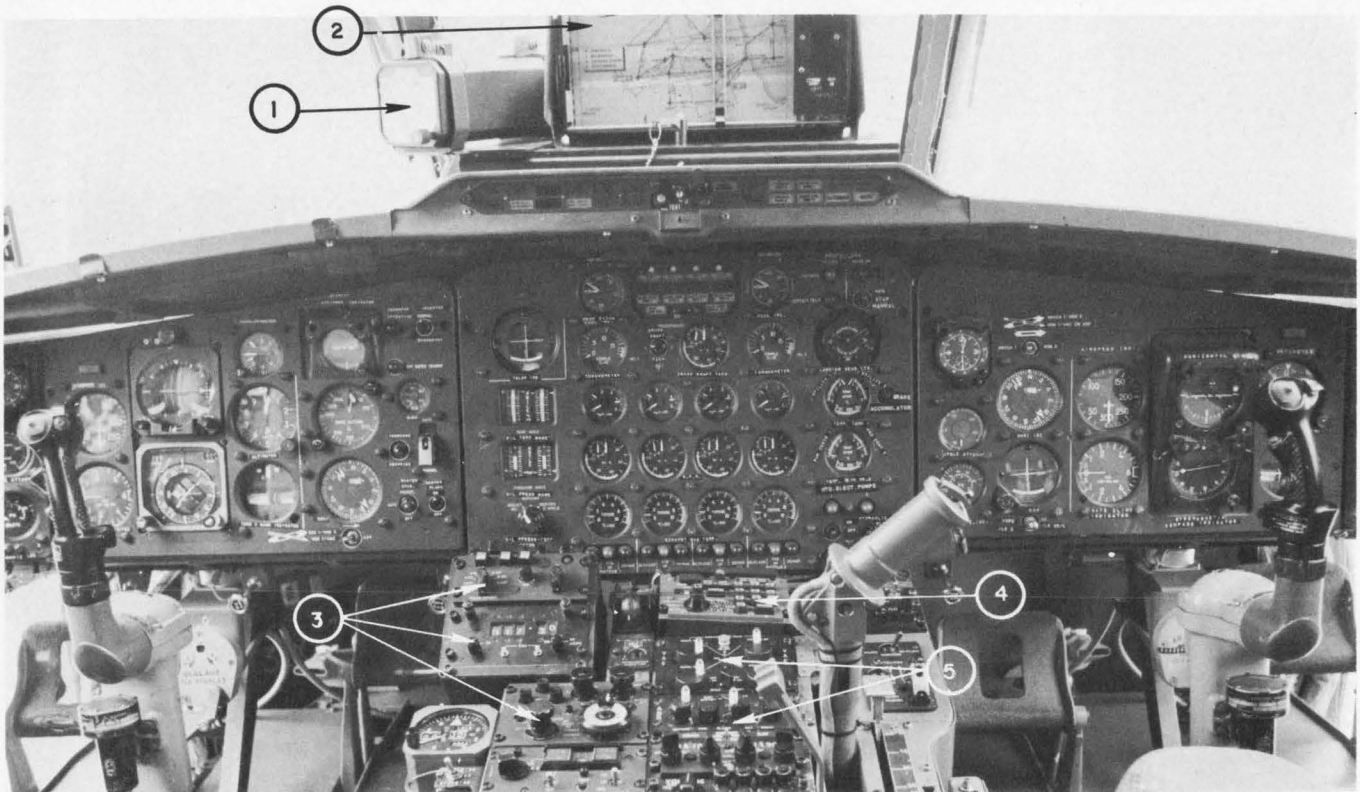

Area navigation instruments on American Airlines STOL evaluation aircraft. The instruments include: (1) Butler-National Vector Analog computer display; (2) Moving-map display for the Decca Omnitrac system; (3) Omni-

trac control panel; (4) Control panel and display for Litton LTN-51 inertial navigation system; and (5) Control panel for Butler-National area navigation system. This aircraft is currently flying in the Chicago area.

Light Sensors



Any bright ideas?

How about a detector to track the sun, moon and stars for an inertial navigation system. Or an optoelectronic array to read punched cards and tape. Or in recognition equipment such as credit card readers, check recorders and bill changers.

Maybe a brushless motor needed in an explosive environment, or a tone generator for an electric organ. And there are burglar alarms, optical sound track readers and infrared film recorders. Also accelerometers and gyros. And instruments for measuring gas, liquids and even freight packages.

TI's light sensors are 1000 times faster than the electromechanical

TI Preferred Light Sensors and Emitters		
LIGHT SENSORS	PACKAGE/LENS	SENSITIVITY
1N2175	Elongated/Round	0.1 mA
LS400	Elongated/Round	1.0 mA
LS600	Std/Round	0.8 mA
TIL601	Std/Round	0.5-3 mA
TIL605	Std/Flat	0.5-3 mA
TIL602	Std/Round	2-5 mA
TIL606	Std/Flat	2-5 mA
TIL603	Std/Round	4-8 mA
TIL607	Std/Flat	4-8 mA
TIL604	Std/Round	7 mA
TIL608	Std/Flat	7 mA
LIGHT EMITTERS	PACKAGE/LENS	POWER OUTPUT
TILO1	Std/Round	50 mW
TILO9	IR/Flat	500 mW

devices they replace and they're up to 20 times more reliable.

TI has eleven light sensors and two light emitters in its line of preferred semiconductors. That means they're "application proven," in volume production and are readily available from distributor and factory stocks.

For TI's *Preferred Semiconductors and Components* catalog, write Texas Instruments Incorporated, PO Box 5012, MS 308, Dallas, Texas 75222.

Or simply circle reader service card number 160.



TEXAS INSTRUMENTS
INCORPORATED

NEWS

(navigation, continued)

or more, according to James Ungry of United Air Lines and chairman of the area navigation subcommittee of ARINC (Aircraft Radio Inc., official standardization agency for the airlines). Ungry has told ELECTRONIC DESIGN that this much time will be required for ARINC to define and implement hardware standards.

While he estimates that the specifications should be finished and approved by mid-1970, American Airlines is pushing to have it done by the end of this year.

General aviation, on the other hand, is beating the airlines to the punch, just as it did with distance-measuring equipment, by installing equipment now. According to Gil Quinby, vice president of Narco Avionics, Fort Washington, Pa., more than 100 of the company's \$2885 Free Flight Course-Line Computers for VFR (visual flight rule) area navigation were in the field by mid-July. And Butler-National Corp., Mission, Kan., has already installed a number of its \$16,000 Vector Analog Computers in corporate aircraft (for photos of the Narco and Butler controls and indicators, see "Avionics for the Private Flier Ready for Takeoff," ED 15, July 19, 1969).

VOR/DME Stations now provide some quarter million miles of fed-

eral airways. Each station produces both bearing and distance signals, which tell the pilot the direction to the station and his distance from it. The airways are made up of radial courses emanating from these stations, like spokes from the hub of a wheel (see chart). Air traffic is funneled along these airways, with only altitude separation to keep the aircraft apart. Routes and traffic converge over the stations, creating potential hazards. Also, by limiting navigation to this point-to-point basis, the system severely limits the configuration and number of routes available between two points.

Area navigation equipment is comprised of a course-line computer and a symbolic, or pictorial, display. Operation of the computer electronically shifts the VOR/DME station in accord with the pilot's commands. New "phantom" stations or way points are created wherever the pilot intends to fly—even to some remote airport without any present navigational facilities of its own.

In effect, area navigation converts the present polar navigation system to a rectilinear one. The advantages are significant.

First, whereas tracking accuracy decreases with distance from a VOR station with conventional equipment (because of angular spread), area navigation systems

provide a constant, improved accuracy at any distance.

Second, the pilot can fly a course parallel to any selected track, such as an airway, thus effectively adding new airways and increasing system capacity.

Also, because the pilot can navigate anywhere within the VOR/DME station coverage, doglegs in the various routes can be eliminated, and new routes can be established without requiring new stations or adding to the radar controllers' work load.

Tests prove the system

Last year the FAA ran a five-month series of tests at its National Aviation Experimental Center in Atlantic City, N.J. Recently, newer equipment was evaluated under radar surveillance in the Dulles International Airport area outside Washington, D.C. And yet another series of tests verified system accuracies with theodolite observations.

American Airlines evaluated the Butler-National system in a BAC-111 jet liner flying between Boston, New York and Washington in late 1967, and in 1968 the carrier equipped two Boeing 727's with newer versions of the Butler system and flew them on 700 flights between New York and Chicago.

In a STOL (short takeoff and landing) operation utilizing a McDonnell-Douglas MDC-188, an airliner made by Breguet Aviation of France, American recently installed three systems—the Butler-National Vector Analog Computer; the Decca Omnitrac, made by ITT Navigator Systems, Washington, D.C.; and the Litton LTN-51 inertial navigator, made by Litton Industries, Woodland Hills, Calif. (see photo). Flying to date has been in the Chicago area.

Bendix Avionics, Fort Lauderdale, Fla., has also provided American with a parallel-lane navigation system.

Two of Eastern Air Lines' airshuttle DC-9s have made hundreds of flights between Boston, New York and Washington in the last two years with an experimental system by Collins Radio, Cedar Rapids, Iowa, in one, and a Decca Omnitrac, with its moving chart display, in the other. ■■

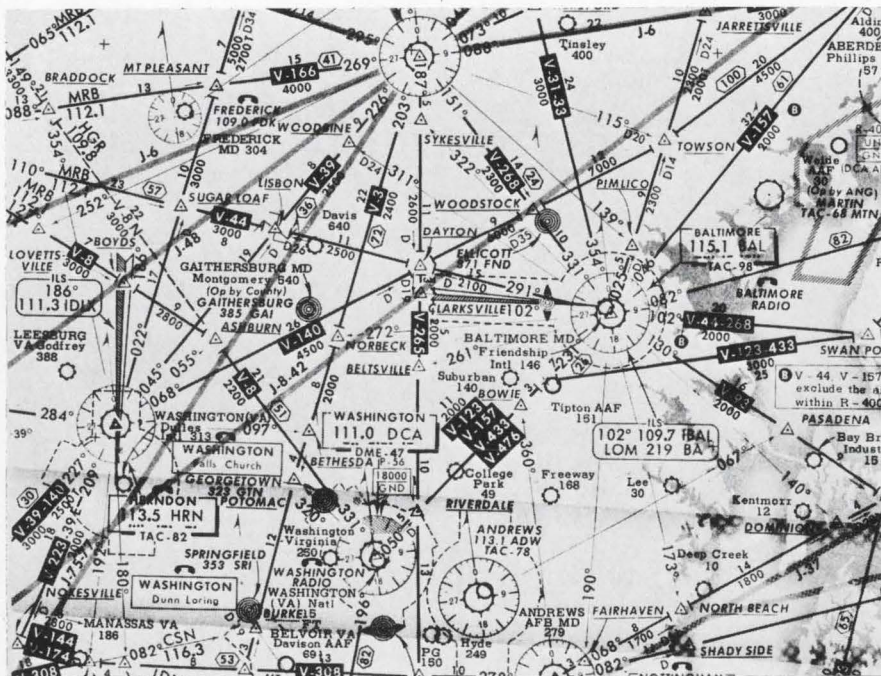

Position of a low-altitude navigation chart copyrighted (1969) by Jeppesen & Co., Denver, showing the airways converging on the VOR navigation stations under present airways system. Chart is reduced to two-thirds size.

BLACKBOXING...?

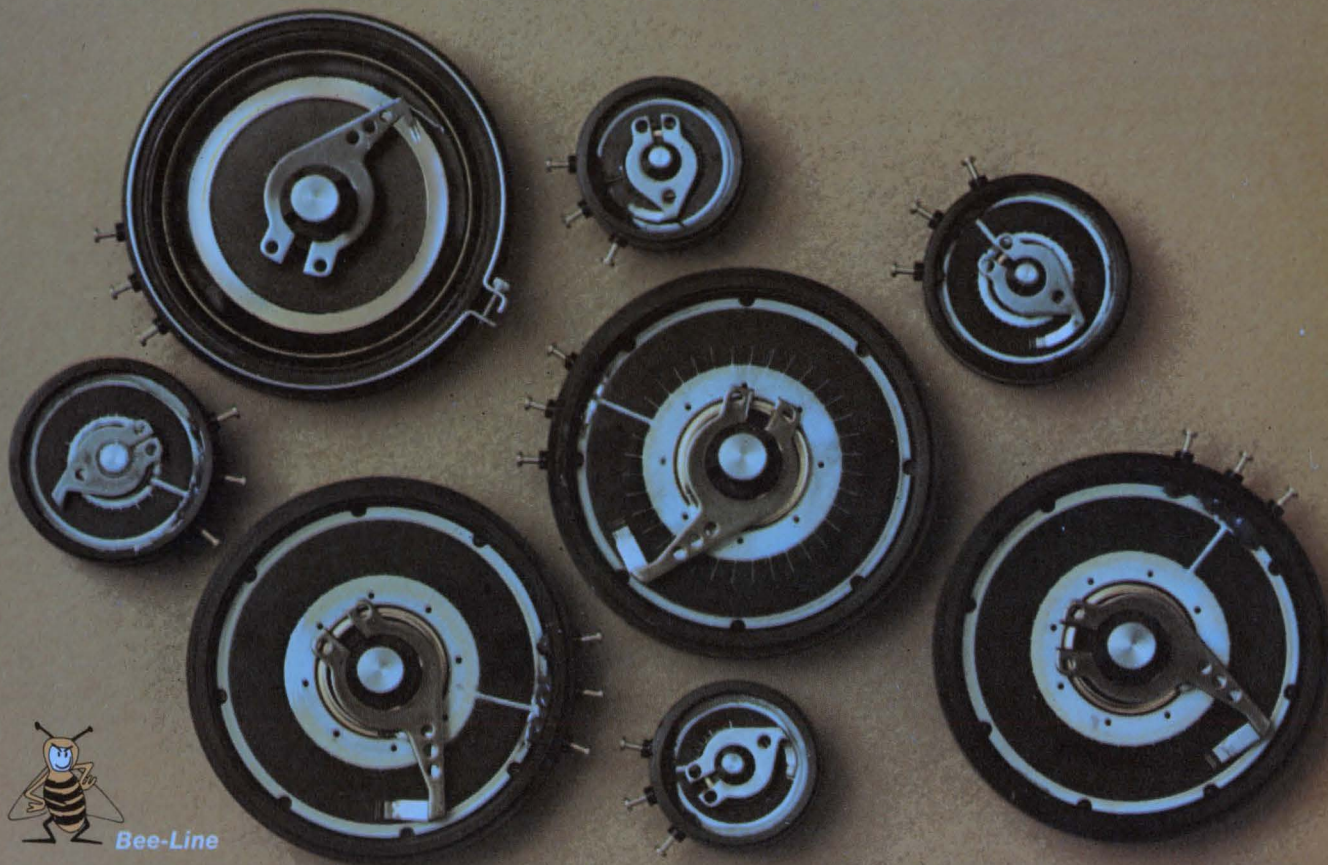

FORGET ABOUT POTENTIOMETER ELEMENT— ... DESIGN FOR SIZE AND DEPTH!

Eliminate size restrictions previously imposed by electrical application! *Bee-Line* does it! Regardless of the type of element — wirewound, conductive plastic, cermet or BiFilm™* . . . The *Bee-Line* series, in the new standard size and a compact, sturdy package, lets you design your black box before the elements are chosen!

To the packager

Three standard diameters — $\frac{7}{8}$ " , $1\frac{1}{16}$ " , 2". No more "hands-tied" electrical specifications that dictate overall size!

To the buyer

Standard size—0.2" per extra cup—avoid headaches of "almost the same as", "just like", etc.

To you

Whatever your function, the Bourns *Bee-Line* can solve a problem in your responsibility area. It truly provides an answer where no one before has dared to tread!

Get complete details on the versatile, slim, trim *Bee-Line* from the factory, your local Bourns Sales Office or Representative today!

*BiFilm is Bourns new, low TC Conductive Plastic



New phosphors convert infrared to 4 colors

Bell Labs' energy transfer from rare earths increases the efficiency of solid-state lamps

John N. Kessler
News Editor

Solid-state lamps in four bright colors can now be made with rare-earth phosphors recently developed at Bell Telephone Laboratories, Murray Hill, N.J. When used as

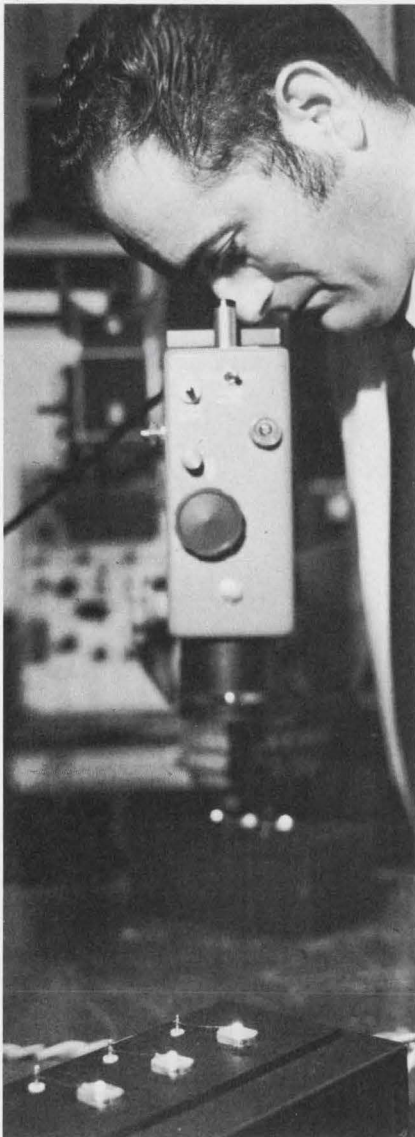

Four colors can be given off by infrared diodes coated with new phosphors from Bell Labs. Here technician uses photometer to measure amount of emitted light. Three of the diodes are in foreground.

coatings on silicon-doped gallium arsenide diodes, these phosphors convert infrared light to red, green, yellow or blue light.

The phosphors also make it possible to vary the color of the emitted light—when the intensity of the IR source is increased or certain rare earths are added to the phosphor.

These advances come at a time when there is an increasing need for efficient light-emitting diodes. A new generation of solid-state displays is in the offing (see "IC Compatible Solid-State Readout Module Puts Light-Emitting Diodes in Segmented Array," ED 13, June 21, 1969, p. 138). Solid-state lamps are needed for information displays for auto, avionic and marine equipment; for space vehicles, optical radar, card/tape readers and other areas. The new phosphors could be used by themselves as light detectors or conceivably as light sources for a flat-screen color TV.

Rare earths increase efficiency

Since the mid-1960's there has been continuous development of the use of rare earths to increase the efficiency of luminescent materials. In 1965, Bell Laboratories physicists used energy transfer from ytterbium to erbium and holmium to improve the performance of solid-state lasers. In 1966, French and Russian physicists demonstrated that this transfer process could be used to produce visible fluorescence with IR excitation.

Making the invisible visible

In 1967, General Electric developed silicon carbide solid-state lamps that glowed with a whitish-yellow light. Then, in April, 1968, scientists at GE reported the discovery of green-light emission from gal-

lium arsenide diodes doped with silicon and coated with rare-earth phosphors. These were the industry's first infrared lamps able to produce green light, according to GE.

At Bell Laboratories, researchers used the same IR source that GE did, but instead of retaining GE's lanthanum fluoride matrix for the phosphor, Bell developed two new host crystals: barium yttrium fluoride (BaYF_5) and yttrium oxychloride (Y_3OCl_7) doped with varying amounts of ytterbium, erbium and holmium. Combinations of these host crystals and rare earths produce phosphors that combine with IR radiation to emit light at 6600 angstroms (red), 5500 (green), 4800 (blue) and 3800, 3200 and 3050 (all ultraviolet).

The gallium arsenide diode sources are not lasing but are normal spontaneous emitters. When these diodes are coated with the phosphors, GaAs radiation at 9300 angstroms is absorbed by ytterbium, which in turn excites erbium, holmium or thulium atoms. Emission arises from 2-, 3-, and 4-photon excitation of erbium involving successive energy transfers from ytterbium.

Colors can be changed

The color of the light according to Bell scientists is controlled by the concentration of rare earth atoms and the intensity of the GaAs pump. The higher ytterbium concentration yields red. The lower concentrations produce yellowish light. When the pump intensity is stepped up, the light changes from green to red.

The green light produced by the Bell Laboratories phosphors is eight times brighter than that emitted by the lanthanum-fluoride phosphors. The new phosphors have a power conversion efficiency equal to that of green-emitting gallium phosphide diodes, which have been under development for years at a number of laboratories. ■■

Rip cords, tire cords, window sash cords. Will your product flop because of a "little" thing? Like unacceptable abrasion wear that shows up only after use under actual conditions. Perhaps it's corrosion and/or heat degradation of small or inexpensive components. Or a lubricant that doesn't make the grade under certain conditions.

You'd be surprised how inexpensive it is for Ogden to environmentally test what may seem to be "little" things in your products. Test us. Ask for a quote from any of our seven test labs listed below. We'll also be happy to give you a quote for testing "big" things. Like entire refrigerated vans or critical spacecraft assemblies. We've been doing it since 1952. Or write to us for our whole environmental testing story.

Ogden Technology Laboratories, Inc.

Facility locations:

Deer Park, New York
(516) 667-7200
Oklahoma City, Oklahoma
(405) 946-9986
Sunnyvale, California
(408) 739-5900
Beaumont, California
(714) 845-1103
Woodside, New York
(212) 478-2010
Monterey Park, California
(213) 289-4425
Fullerton, California
(714) 879-6110



**It's little failures,
that make the biggest flops!**



INFORMATION RETRIEVAL NUMBER 25

No other general purpose counter is so useful in so many ways. No other counter offers you so many accessories to fit so many measurement jobs.

First, you can get the Model 5248M with a time base that's stable to better than 5 parts in 10^{10} per day, a precision frequency standard in itself. You can measure any frequency from dc to 135 MHz to 8 places ± 1 count. Or use to 18 GHz at the same accuracy with simple plug-ins.

You can measure period, multiple period average, frequency ratio, multiple ratios, or you can scale frequencies or totalize.

With accessories that plug into the front panel you can:

Resolve time interval to 10 nano-seconds.

Measure to 18 GHz with a 1 Hz resolution in 4 seconds.

Measure CW or pulsed signals out to 18 GHz.

Prescale for direct readout to 350 MHz

Increase sensitivity to 1 millivolt.

Make dc voltage measurement up to 1000 volts.

Normalize readings to engineering units or perform high speed batch counting or control.

And with the newest plug-in, the 5268A Frequency Multiplier, you can make high accuracy low-frequency measurements as much as 1000 times faster

You can get much more out of this counter. Because you can put much more in.

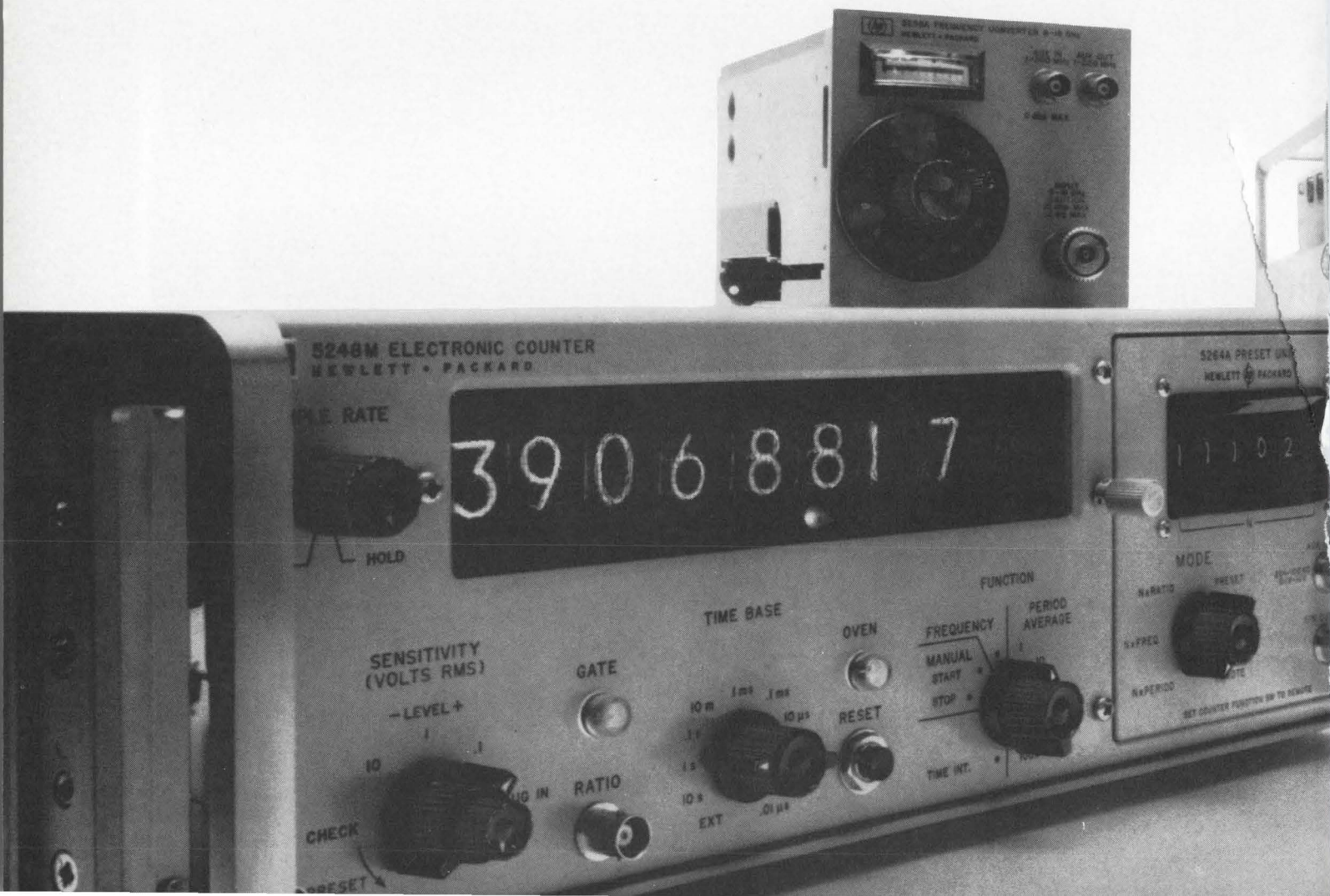

than you ever could before.

Plug-in accessory performance is unequalled. Even the 18 GHz heterodyne converter is completely free of spurious responses. And the transfer oscillator plug-in operates on a new principle which offers versatility, range (50 MHz to 18 GHz) and performance you can't get elsewhere. Add-on accessories even further extend counter usefulness by permitting manual measurements to

40 GHz or automatic measurements from 0.3 to 12.4 GHz.

The 5248M is but one member of a series of 10 closely-related models based upon the highly popular 5245L Counter. All models use the same accessories. And you'll get the same quality and field-proven design no matter whether you choose the top-of-the-line 5248M for \$3300, the original 5245L for \$2480, the economy model 5246L for \$1800 or any of the

seven other models.

For a 32-page guide to the highly versatile "5245 Series" call your local HP field engineer. Or write Hewlett-Packard, Palo Alto, California 94304; Europe: 1217 Meyrin-Geneva, Switzerland.

HEWLETT  PACKARD

ELECTRONIC COUNTERS

02908
INFORMATION RETRIEVAL NUMBER 26

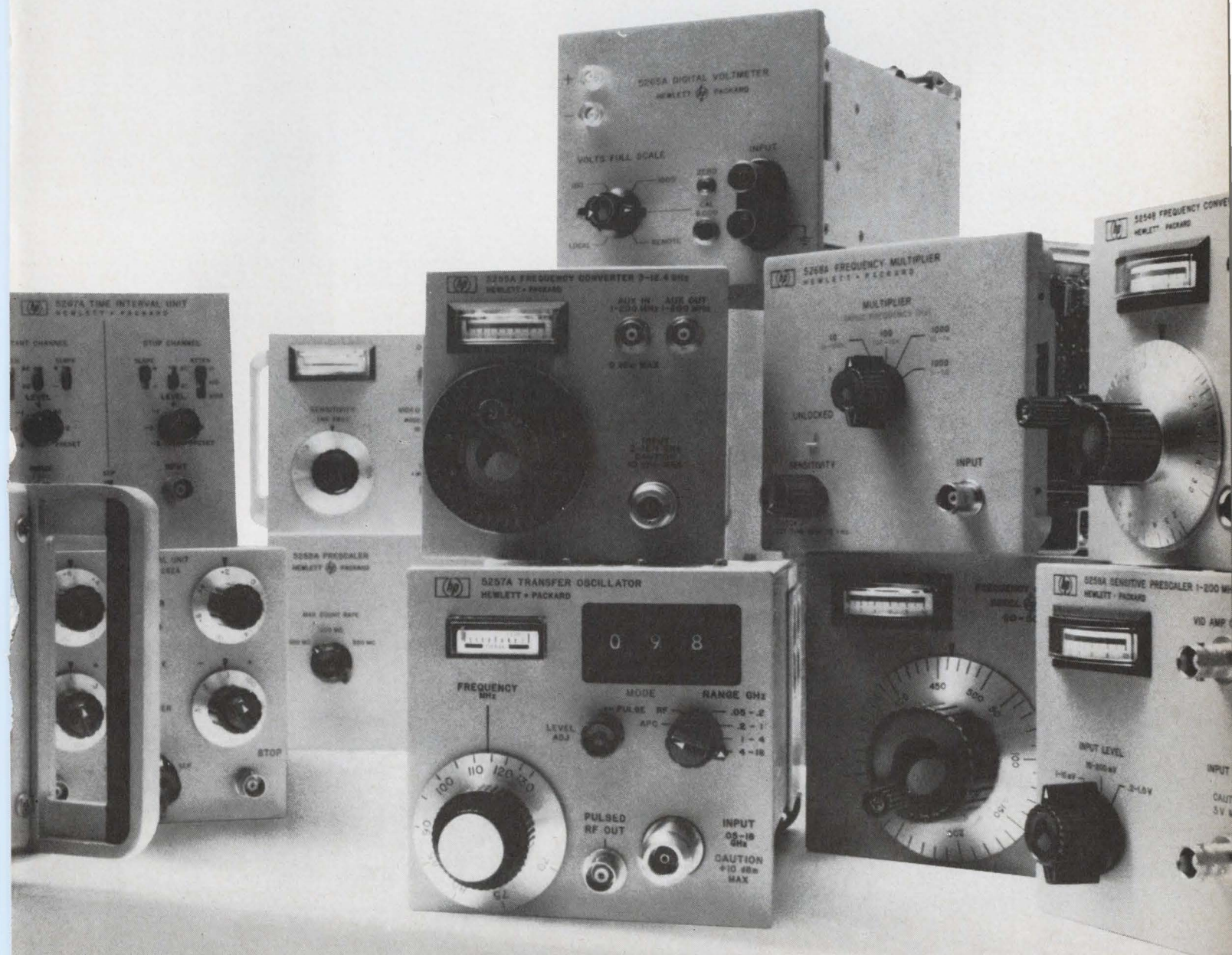

The Standard of Excellence

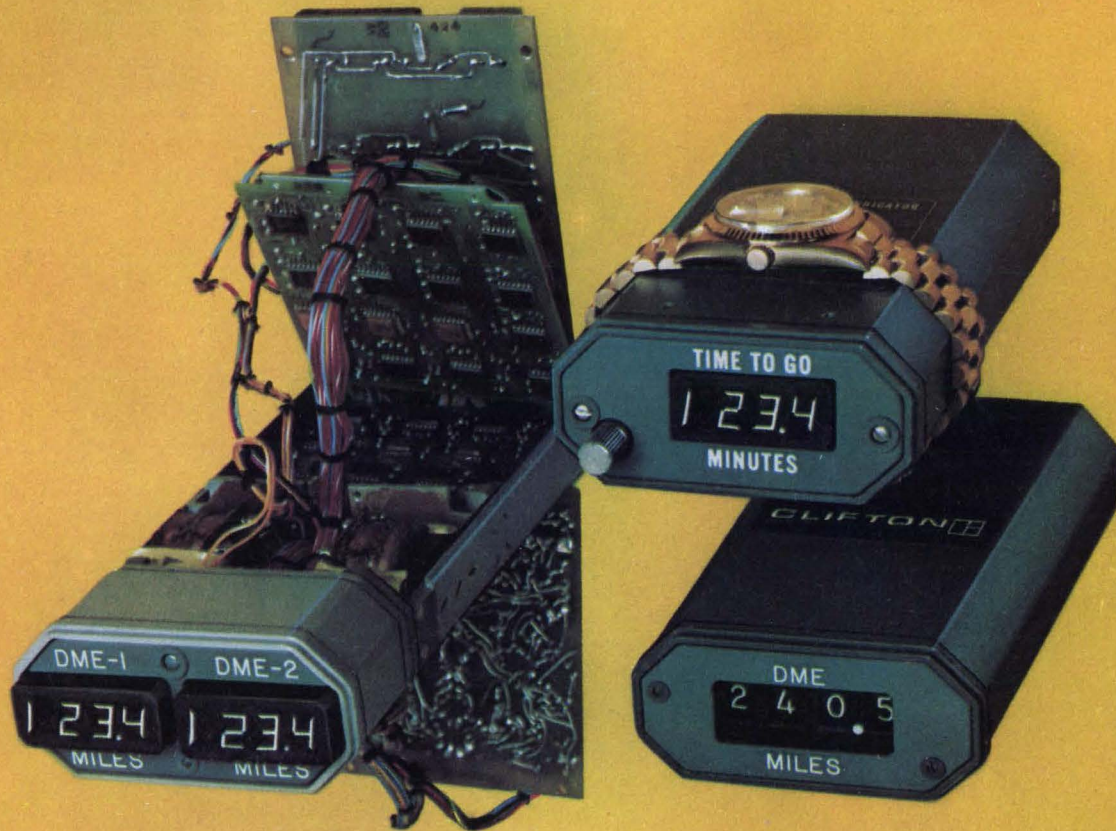

Digital Indicators by Clifton

In the Clifton family of ARINC type, solid state, Time-To-Go, INS and DME indicators, we are proud to have anticipated and produced advanced cockpit hardware for the new generation of commercial transports.

Important design advances in the areas of fault monitoring and detect circuitry plus central dimming capabilities are incorporated into the basic design.

In operation, each indicator recognizes the address of a specific function pa-

rameter, decodes the serial BCD data, and provides a digital display of the information. Each basic indicator in the family has the capability of being converted to any other indicator format by simply changing a lightplate and programmable connector. Seven segment lamp or magnetic wheel readouts are available for most designs.

Two basic display families, a 4 Digit and Dual 4 Digit configuration, are included in the INS and DME indicator product line. Sim-

ilar indicators are available for AIR DATA applications. A variety of indicator readout configurations meet all INS, DME or AIR DATA indicator requirements.

You can obtain full information on this advanced line of indicators which is available and now flying by calling your Local Clifton Sales Office or area 215 622-1000; TWX 510 669-8217.

CLIFTON 
DIVISION OF LITTON INDUSTRIES

Chronometer and Band from J. E. Caldwell Co., Philadelphia—\$1200.

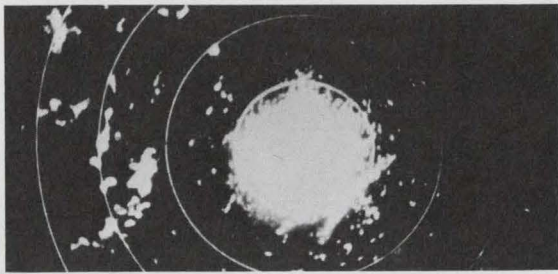

Five-year weather study urged

It may not surprise you to learn that accurate weather forecasts can be made for only about two days ahead. Beyond this, says Dr. Jule G. Charney, chairman of the National Committee for the Global Atmospheric Research Program (National Research Council), forecasting accuracy drops rapidly. But Charney asserts we are on the verge of advances in theory and observation that could certainly enable us to forecast accurately for four or five days, or longer. What is really needed now, he says, is a computer generation 100 times faster than the most advanced systems available today.

The National Research Council, in its report on "U. S. Participation in the Global Atmospheric Research Program," recommends a major program to learn more about atmospheric interactions and the systems and techniques used for long-range weather forecasting. In brief, the report prepared by Dr. Charney's committee urges a five-year effort including the following:

- A test, by 1973, in the Pacific Ocean area of a global weather observation system and an associated large-scale atmospheric study.
- A series of relatively small regional studies, by late 1969 or early 1970, of atmospherics and observing techniques.
- Experiments to improve significantly atmospheric numerical models for use in computer forecasting (presumably to be ready for use with the massive ILLIAC IV quad-parallel processor now in development at the Illinois Institute of Technology.)

Shore duty for Omega system?

The Army is testing the Navy developed Omega Navigation System for use on land. The Electronics Command at Fort Monmouth, N.J., has given Northrop Corp., which builds Omega ship and aircraft receiver subsystems for the Navy, a contract of nearly \$100,000 to perform the tests.

Washington Report

CHARLES D. LAFOND
WASHINGTON BUREAU

Omega is a low-frequency, hyperbolic-grid system that eventually will employ eight long-range, high-power transmitter stations around the world to provide relatively accurate position fixes to ships at sea—up to one mile by day and two miles by night. The Army tests involve a new approach that, Northrop says, could "provide accuracies at least 10 times greater than the basic Omega positions."

Called "differential Omega," it functions as follows: A moving vehicle on land would use its Omega receiver to get a position fix and then employ a correction factor received by radio from a nearby Army transmitting station. The latter, with an effective range of 200 miles, would determine the signal correction necessary by continually measuring the day-to-night variations of the ionosphere, whose height and composition strongly affect the phase of lf radio transmissions.

Apollo TV based on 1940 method

Dr. Peter C. Goldmark, developer of the first practical field-sequential color television system, has presented the original prototype to the Smithsonian Institution in Washington. The gift couldn't have been more timely, says Frank A. Taylor, director-general of the museum, for the same rotating disk technique is used in the Apollo color TV cameras (developed for NASA by Westinghouse).

Dr. Goldmark, president of CBS Laboratories in Stamford, Conn., recalled that the first color telecast using his system was made on Sept. 4, 1940 from the top of the Chrysler Building in New York City. The system had limited use through 1953, but it never really took hold because of its limitations—receivers had to be equipped with a similar synchronized color disc, and the technique was incompatible with black-and-white telecasting.

Washington Report

CONTINUED

The system is used in the Apollo program because of its unique advantage: the field-sequential method of color separation and transmission produces a brilliant picture, even at very low light levels. A scan-converter developed by CBS Laboratories is required at earth receiving stations to reconstruct pictures compatible with today's commercial TV system.

In addition to the prototype equipment, CBS Laboratories gave the Smithsonian all of the original design and engineering drawings and the first color photographs obtained during the 1940 demonstration telecast. These, together with FCC documents pertinent to color TV hearings in the late 1940s and early 1950s, soon will become part of a permanent and probably working display.

Vlf bio-hazards to be studied

What are the potential biological effects on plants, animals and human life of high-power, very-low-frequency radio signals? The answer is important because the Navy's Project Sanguine involves a proposed massive installation in northern Wisconsin for transmitting vlf communications at multi-megawatts to Polaris and other nuclear submarines around the world.

TRW's Hazleton Laboratories in Falls Church, Va., has been awarded a \$173,000 contract to perform the bio-hazard studies for the Naval Electronics Systems Command. Dr. William B. Coate will direct the research team at TRW.

RCA is now building a sub-scale test facility at the Wisconsin site to support the R&D phase of the program.

FAA presses automation plan

The Federal Aviation Administration has awarded a \$2,535,779 contract to Electronic Laboratories, Inc., Houston, for additional equipment to automate the nation's air traffic control system. The contract covers the purchase of 21 solid-state system maintenance

monitors for the computerized system now being installed in 20 traffic control centers in the United States.

In addition to providing information on system performance and configuration, the monitors will also provide information on the condition and use of the teletype-like devices used in airport towers and airline dispatch offices to receive and send flight plan information. The first monitor system, to be delivered within a year, will be installed at the FAA Academy at Oklahoma City, Okla., for training purposes. The remaining 20 units will be delivered over a period of 52 months to the traffic control centers.

All elements of the nationwide automated air traffic control network are expected to be in operation by the end of 1973.

Vitro makes comeback on Navy contract

While Vitro Laboratories Div. of Vitro Corp. has served as a consultant and provided engineering services to the Navy on nearly all its missile development programs for some two decades, it has had problems in other areas. The latest Navy award to the division of nearly \$13 million for 12 months of continued engineering services in support of the Fleet Ballistic Missile program, nearly \$6 million for the new Poseidon missile, and \$7 million for Polaris systems will go far to erase those problems.

During most of the past 20 years Vitro, which is in Silver Spring, Md., has grown steadily, both internally and by acquisition, but in recent years sales and profits began to decline. Key personnel left, and several nearby competing firms were established by former Vitro personnel. One, DEI, Inc., purchased the Vitro Electronics Div., and later the remaining divisions of Vitro were acquired by Automation Industries, Inc. a Los Angeles company.

Operating as a wholly owned but relatively independent subsidiary, Vitro Laboratories now appears on firmer ground financially. Says Wayne G. Shaffer, lab director, "This [the Navy award] is one of the largest contracts in our 21-year history. We're operating at the busiest pace since the plant was established."

hp adds 250 MHz to the 180 Scope System

This all-solid-state plug-in system now covers 50 MHz, 100 MHz and 250 MHz Real Time, calibrated time domain reflectometry with 35 ps risetime, 12.4 GHz sampling with 28 ps risetime, storage and variable persistence...

089/10

HEWLETT  PACKARD

OSCILLOSCOPE SYSTEMS

The preceding 12 pages are a presentation of the complete HP 180 Scope System—including the new 183A 250 MHz Oscilloscope. If the insert is missing, you can get a copy by circling Electronic Design Information Retrieval Number 100.

SIDELIGHTS OF THE ISSUE

Always glad to help out old friends

Elizabeth deAtley's special report on testing large-scale integration chips (p. 24) began with a series of complaints from friends who had become involved in work with LSI systems: It was taking six or eight months just to build test equipment; designers couldn't agree on how the testing should be done; they didn't even seem to be talking the same language when they discussed testing methods. Elizabeth heard the complaints when she visited friends with whom she had worked in Philco-Ford's Microelectronics Div. in Santa Clara, Calif., before the plant moved to Philadelphia. Some of the engineers said they needed testing information badly but hadn't the time to investigate.

Investigation is Elizabeth's business, as a West Coast Editor for **ELECTRONIC DESIGN**, and her talks with friends started her on a tour that led from San Francisco to Phoenix, Ariz., to Dallas and Houston, Tex., and eventually to New York City. She found that interest in testing LSI was unusually high in every company she visited and that it was also the subject of conferences by various groups of engineers.

In her travels, Elizabeth first had to learn why LSI was so difficult to test and what methods were being used. Then she had to sift the sometimes conflicting information she received. The problem, she says, was somewhat like a childhood legend about an elephant that she seemed to recall—different people were touching different parts of the elephant while blindfolded and conjuring up different animals. Elizabeth had to study all the answers about LSI testing and put the "elephant" together into recognizable shape.



West Coast Editor Elizabeth deAtley talks with Bill McKinley, Manager of MOS Engineering at Fairchild Semiconductor.

**This portable will record
more facts in less time, at less cost
than any other 2-channel recorder
on the market.**

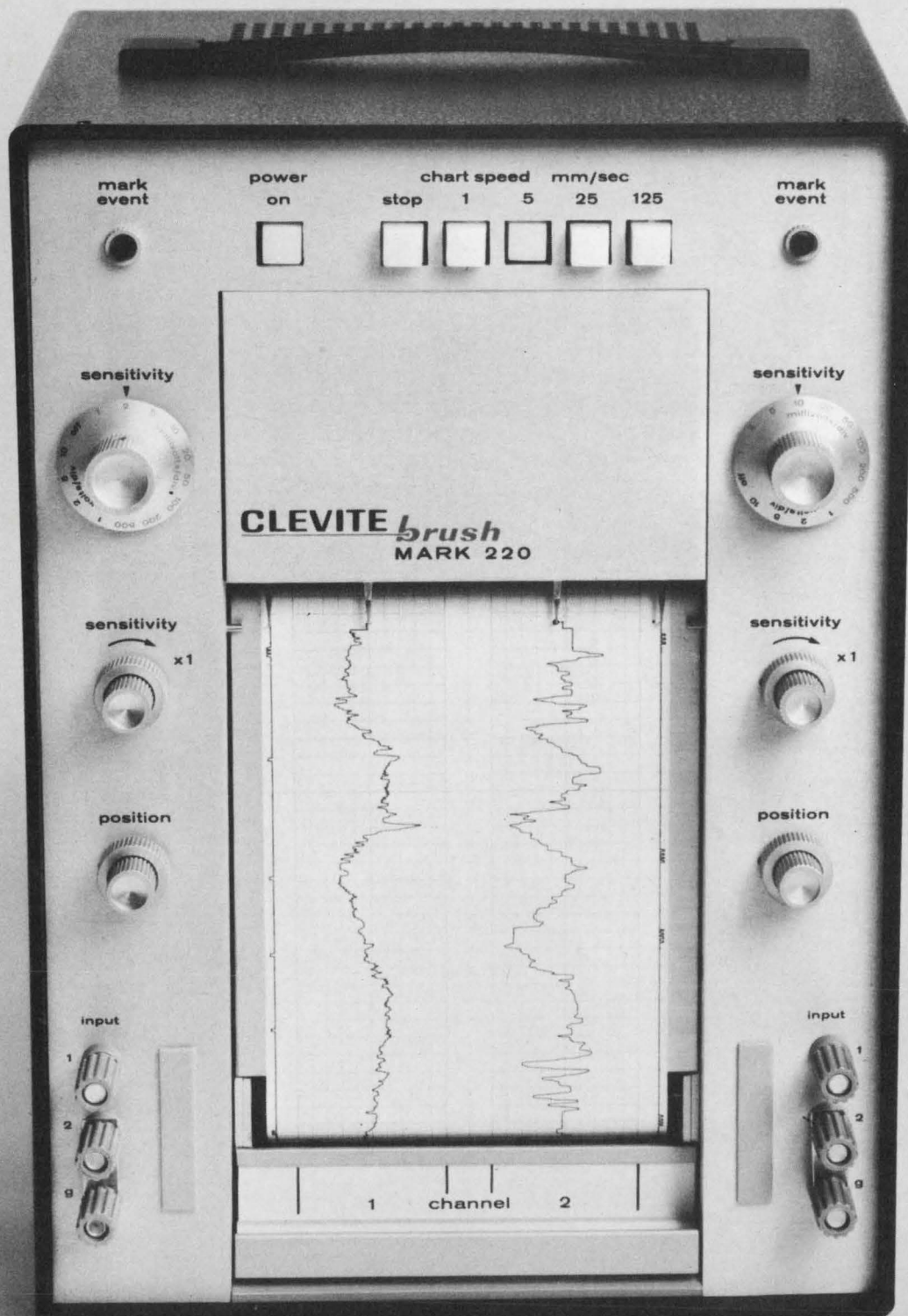

We call it the Mark 220.

And once we put it through its paces for you, you'll call it the most amazing piece of recording gear around.

To begin with, we *guarantee* the Mark 220 to be 99½% accurate. Which is a good deal better than almost anything else on the market . . . regardless of size or price. The pressurized ink-writing system is the same one you'll find in our six and eight channel systems. Instead of laying the trace on the

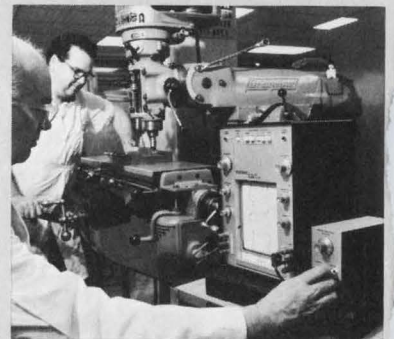

paper, it forces it *in*. Run your finger over it. There's no smear, no smudge. And trace crispness and uniformity is in a class by itself.

Built-in preamplifiers give you measurement range from 1 mV per division to 500 V full scale — and you never have to re-calibrate. Pushbutton controlled chart speeds. Two handy event markers. Ink supply is a disposable cartridge, good for a year.

Yes, for a 25 pound portable that's no bigger than a breadbox, the Mark 220 is quite a recorder. Ask your Brush representative for a demonstration. Or, write for complete details. Clevite Corporation, Brush Instruments Division, 37th and Perkins, Cleveland, Ohio 44114. We'll include our informative booklet "Elimination of Noise in Low-Level Circuits".

CLEVITE BRUSH

INFORMATION RETRIEVAL NUMBER 28

WESCON PREVIEW



Trying to make up your mind on whether to attend the big Wescon show in San Francisco later this month? Here's a peek at the significant papers and products to help you decide.

AN ELECTRONIC DESIGN PREVIEW

Wescon, 1969: It's smaller but better

23 technical sessions organized by technology,
1192 booths and side shows galore await visitors

David N. Kaye
West Coast Editor

Wescon has matured to the point where quantity stops and quality takes over. This year the emphasis will be on the usefulness of the show to the working engineer. For the first time, technical sessions will be organized according to the type of technology to be presented.

And wherever possible, an attempt has been made to see that technical sessions of interest to any particular group of engineers do not overlap. Although three sessions will always be going on simultaneously, the area of interest in each session will be different. To make this possible, the number of technical sessions has been cut from 32 last year to 23.

The sessions that have been eliminated were for the most part state-of-the-art or theoretical in nature. This year's sessions will be aimed at what can be done in today's world.

Once again, exhibits will be grouped by product category. To carry out this goal of the show, several companies have split up their exhibits to allow different divisions to have their own displays in different parts of the Cow Palace in San Francisco.

1192 booths to see

Over 250,000 square feet of space will house the 1192 exhibit booths in the Palace. More than 600 companies will play host to the 45,000 visitors expected at the show. Out-of-town visitors will occupy more than 8000 hotel and motel rooms as they spend Aug. 19-22 touring the exhibits and tak-

ing part in technical sessions.

A private mass transportation system will be set up to ferry people by bus from their hotels or motels to the Cow Palace. Regular bus service will be maintained not only from downtown San Francisco but also from Palo Alto in the heart of the bay area.

Upon arriving at the show and registering, each person will receive a personalized plastic "credit card" with which he will be able to request information and literature from the various exhibitors for subsequent mailing to him. This will eliminate the cumbersome task of carrying around pounds of catalogs and other material available at the show.

Computers to locate booths

To find a particular exhibit in the Cow Palace, time-shared computer terminals with cathode-ray-tube displays will be set up at strategic locations, programmed to direct a visitor to any booth he wants to visit. The same terminals will also give bus directions and possibly even a profile of the average visitor to the show.

According to Ted Shields, the manager who works all year to see that each Wescon is better than the last: "We haven't yet decided what additional information will be on the computer, but whatever it is, it will be helpful and interesting."

One convenience that Shields has instituted this year is a cafeteria in the Palace, built especially for Wescon.

Along with product exhibits and technical sessions, side activities abound. They include parties, luncheons, films, an art exhibit

and a special Circuit Packaging Symposium. Activities are planned at the San Francisco Hilton.

The Sponsors Luncheon, which sets the show in perspective, will be held in the Imperial Ballroom of the Hilton at noon on opening day. About 800 industrial and engineering executives are expected to gather to hear an assessment of progress and to honor outstanding performance. WEMA will present its medal of achievement, and IEEE will make two major awards. All Wescon registrants are invited to attend the luncheon at \$6.50 a plate.

Last April prophets of doom were predicting California would slip away into the sea, leaving Howard Hughes with oceanfront Las Vegas property. To celebrate the nonoccurrence, Wescon will hold a Mirthquake in the Hilton ballroom between 6 and 8 p.m. on opening day. For \$6, any showgoer can celebrate with hors d'oeuvres, beverages and considerable shaking on the dance floor.

At the Eta Kappa Nu Awards Luncheon on Wednesday, Aug. 20, Patrick E. Haggerty, chairman of the board of Texas Instruments, will speak.

At the Wescon Future Engineers Luncheon on Thursday, Robert H. Brunner, Hewlett-Packard technical executive, will speak.

Symposium on circuit packaging

An additional highlight of the show this year is the special Circuit Packaging Symposium to be held in the Hilton. The program will last two days and include eight technical sessions at which 28 papers will be presented. A symposium digest will be printed

and a keynote luncheon will precede the activities. The speaker at the luncheon will be William Shockley, president of Nuclear Systems, Inc., of Dallas.

Once again Wescon will have a Science Film Theater. Outstanding technical motion pictures will be shown daily during the show in the South Hall of the Cow Palace.

The 21 winners of the annual Wescon Industrial Design Awards will be on display in the East Hall all week.

A new touch this year is a one-man art show by a nationally recognized technologist and executive who is also a serious fine artist. He creates under the name "Elbon," but is better known as Dr. Daniel E. Noble, vice chairman of the board of Motorola.

Something for the ladies

The women's program at Wescon is extra special this year. The theme of the program is "Age of Elegance in San Francisco." A champagne luncheon is planned on opening day at the beautiful St. Francis Yacht Club, near the Golden Gate Bridge. Bus service from the Hilton will be provided. The afternoon program includes an illustrated talk on modern art by Dr. Noble.

On Wednesday, the scene shifts to the Fairmont Hotel on Nob Hill, for a fashion luncheon. Models will be wearing gowns from famous periods in San Francisco's colorful history, and the commentary will describe the golden days of the city.



Dual-beam, high-gain, low-frequency oscilloscope will be introduced by Tektronix, Inc. at Wescon later this month.

On Thursday morning, a continental breakfast will precede a conducted tour of the Wescon show.

All week at the Hilton a hospitality suite will be operated for the enjoyment of the more than 600 wives who are expected to accompany their husbands to Wescon.

It's a relaxing town

Aside from the electronics spectacle, there is for all showgoers and their wives the inviting panorama of San Francisco: Sea, hills, cable cars, bustling docks, beautiful parks and long bridges to places with names like Treasure Island.

The city's cable cars, now designated a National Historic Monument, offer a thrilling roller-

coaster experience. The natives hop on and off with abandon, but visitors are advised to be more cautious.

The city's restaurants are diverse and numerous. The gold of the mining camps attracted some of the finest chefs in the world to San Francisco, and this heritage persists. Chinatown features the exotic cuisine of the Orient; the Fisherman's Wharf is famous for its dinners fresh from the sea; and Mexican, Italian, French, Armenian, Russian and American cooking are all here. You can make a culinary trip around the world without leaving San Francisco. Among the noted restaurants are Ernie's, Sally Stanford's Valhalla, Alioto's, DiMaggio's, Kan's, Trader Vic's and Paoli's.

Let's examine the technical and product aspects of Wescon more closely. ■■

Technical sessions accent the practical

The present rather than the future is being stressed at the Wescon technical sessions this year.

Chairman Dalton W. Martin, vice president of engineering, Vidar Corp., Mountain View, Calif., and his technical program committee examined 75 session

proposals and chose 23 they considered most significant. Each session presents a group of complementary papers on a single subject of technology or management.

The sessions can be broken down into these major categories:

- Components and Microelectronics.

- Instruments and Instrumentation.

- Solid-State Fabrication.
- Communications and Science Systems.

- Microwave Technology.
- Computers and Data Processing.

- Management, Education,

Marketing.

Important papers are scheduled in all categories. Here is a sampling:

Components and microelectronics

Session 4 discusses integrated circuits in active filters. According to the session chairman, Gunnar Hurtig 3d of Kinetic Technology, Inc., Los Gatos, Calif., technology rather than theory will be stressed. "The papers will emphasize what we can do now with the present technology," he says. Such a paper is the one on "Building Active Filters Using Thin-Film Construction Techniques," by Dr. George Moschytz of Bell Telephone Laboratories, Holmdel, N.J. He shows how positive feedback active filters can be designed with high stability.

Session 15 is focusing on MOS integrated circuits. Session chairman Ray Speer, an ELECTRONIC DESIGN technical editor, has attempted to bring the MOS user and vendor together for better understanding. Larry Drew of Viatron Computer Systems Corp., Burlington, Mass., establishes the theme in his paper "MOS IC's: In-depth User-Vendor Dialogue Is a Must." He proposes interface guidelines that will ensure efficient communication between the IC designer and vendor and the system designer and user.

Session 17 talks about high-power microcircuits. Chairman Bob Koeper of Electronic Design News has arranged several examples of how the high-power problem is being handled with currently available microcircuits. William D. Whittekin of Texas Instruments, Inc., Dallas, tells the how of "Controlling Power on a Chip." He discusses the pros and cons of the monolithic marriage of low-level circuits and power elements.

Session 20 asks, What new solid-state devices have been developed in the last year? Dr. M. M. Atalla and Robert Noyce, the session co-chairmen, have gathered papers from the field of opto-electronics, digital circuitry, microwave semiconductors and linear circuitry.

Instruments and instrumentation

Of the sessions on instruments and instrumentation, the most im-

portant message comes from one on computer-aided testing, management and implementation (Session 21). According to A. Machi of Bendix Corp., Teterboro, N.J., the session chairman: "Nothing stands alone. It is an integrated approach. The hardware and software people must work together." This is well illustrated in a paper by Frank M. Stutesman of Bendix on "A Computer-Controlled Test System." The paper discusses both the system organization and the companion software. It is one of several papers at Wescon that show how far automatic testing has come in the last year.

Solid-state fabrication

It's estimated that two trillion semiconductors were produced in 1968 and that this figure will be trebled in 10 years. The goal can be reached through the use of automated production techniques. This is the subject of Session 16. The chairman, Orville Baker of Signetics Corp., Sunnyvale, Calif., will show how far automatic processing has already advanced and what is currently in the works. A good feeling for what can be achieved with automatic processing will be gained from Donald G. Pedrotti of Hugel Industries, Sunnyvale, Calif., in his paper on "Equipment For Automatic Processing." He will discuss each of the semiconductor production processes and show how they can be automated.

Communications and science systems

For several years, engineers have been investigating the problem of broadcasting from a satellite to many receivers on the ground. Now interest has shifted to the reverse, and a problem of prime importance has become the transmission of data from many points on the surface simultaneously to a single satellite. This is the theme of Session 12. The subject is data-relay satellites. According to Edwin J. Istvan of Comsat Corp., chairman of the session: "Low-data-rate transmission from thousands of earth sensors to a single satellite can be handled in several ways. All them will work, and this session will discuss some

of the proposals." A good example is a paper being given by P. J. Heffernan of the Goddard Space Flight Center, Greenbelt, Md., and C. E. Gilchrist of the Jet Propulsion Laboratory, Pasadena, Calif. The subject is "A Multiple-Access Satellite Relay System For Low-Data-Rate Users." The system discussed utilizes fixed-gain to fixed-gain rf links at vhf or low uhf frequencies.

Microwave technology

The microwave technology category is dominated by papers on solid-state devices, computer-aided-design and microwave integrated circuits. Session 3 examines current solid-state microwave devices and circuits. William E. Kunz of Watkins-Johnson Co., Palo Alto, Calif., the session chairman, has organized a group of comprehensive review papers that deal with solid-state oscillators, amplifiers and delay devices. Perhaps the most far-reaching of these papers is the one by James R. Reid of Avantek Corp., Santa Clara, Calif. He deals with "Microwave Transistor Amplifier Design." His paper is one of many that demonstrate the use of computer-aided-design to advance the state of the art.

An entire session has once again been devoted to computer-aided-design of high-frequency circuits. It is Session 6, and the chairman is Frank Arams of Airborne Instruments Laboratory, Melville, N.Y. According to session organizer Gerald Schaffner of Ryan Electronics, "We are trying to show how the computer can help in the modeling of the components that go into high-frequency circuits, and then the design of the circuits themselves."

One of the outstanding papers at Wescon this year will be the one in this session by Fuad Musa of Motorola Semiconductor, Phoenix, Ariz. In a paper on "Computer-Aided Small-Signal Transistor Modeling," Musa presents a computer program that relates a new, comprehensive, small-signal transistor model to measured two-port parameters. According to Musa, "The paper shows how the transistor model can be used to predict the effect of a device design change where predetermined transistor

electrical performance is sought." Using this model, Musa has characterized and designed devices up to 4 GHz with remarkable accuracy. He told ELECTRONIC DESIGN that with minor changes, the model could also be used for low-frequency design.

Computers and data processing

With high interest focused on computer-aided-design, it is only natural that several sessions should also be devoted to the computer itself. These concern themselves with time-sharing and the use of computers in industry. Nonetheless the highlight of this category is another session on computer-aided-design. It is Session 23, and it also covers computer-aided-testing. The session chairman is Ron Rohrer of Fairchild Semiconductor, Mountain View, Calif. In keeping with the theme of the technical program, Rohrer says that "the session tries to point out what can be done in the real world of computer-aided-design at the present time."

One of the better papers at the show is by S. W. Director of the University of Florida on the "Network Design by Mathematical Optimization." The unique feature of his approach is that it takes man out of the loop. One can give the computer the circuit performance requirements, and the computer automatically feeds back the circuit parameters and the physical structure. The paper describes an oper-



Airlines are increasingly going to computer-controlled test systems to check out their complex avionics equipment. Bendix Corp.'s test system shown above is the subject of Wescon paper 21/3.

ational amplifier designed completely by computer.

Management, education, marketing

One of the most useful and profitable sessions for the engineering executive at Wescon will probably be Session 14 on overseas marketing. C. Gerald Diamond of Sensus International, San Francisco, is the session chairman.

This session will discuss electronics markets in Europe and Japan, and the Asian market outside of Japan. The most revealing paper, though, is one by Carl J. Bradshaw of Oak Electronics

Corp., Crystal Lake, Ill., on "Alternatives to Export Sales: License, Joint Venture and Subsidiary." The paper presents many of the pros and cons for each of the three techniques with clarity.

Help for the speakers

To help speakers hone their delivery of papers to maximum efficiency, Wescon is offering several aids. The most unique is a "speakers' room," where any speaker can rehearse his talk on video tape and then have it played back by instant replay. Here the speaker can practice until he is satisfied that the audience will be pleased with his talk. ■■

New instruments star in product parade

There will be eight product categories in the exhibit area this year, as in the past, and instrumentation grabs a big share of the attention. The highlights this year will be instruments that are completely programmable. Digital counters and digital multimeters abound like never before.

Other areas of high interest are circuit components and micro-electronics.

One of the Industrial Design

Award winners at the show is the Digilin Type 340 Digital Multimeter. The new input-amplifier technique developed by Digilin, Inc., Glendale, Calif., eliminates circuit loading at all times. The design is such that the instrument never needs tilting or propping for better visibility. In addition the automatic zero adjustment completely eliminates drift and assures instant stability.

Dana Laboratories, Irvine, Calif.,

is showing a digital voltmeter that comes in two sections that can be mounted side-by-side for a rack or one on top of the other for bench use. There is, however, a power-supply difference between the two configurations. It is the Dana Model 4500 digital voltmeter. The instrument is actually a multimeter with all the normal multimeter functions, including dc/dc ratio measuring. It has 0.01% long-term accuracy and 80-dB nor-

mal mode noise rejection. The price is less than \$2000.

A multifunction instrument with not only multimeter capability but also frequency capability from 10.000 Hz to 11.99999 MHz has been developed by Wavetek Corp., San Diego, Calif. It is the Model 220 Dialomatic Multimeter/Calibrator, and it provides six precision measurement functions and two highly accurate calibration capabilities in one compact package with no plug-ins.

Systron-Donner, Concord, Calif., is showing its Model 153 Microwave Mini-Counter. It combines very small size with the capability of automatically counting from 300 MHz to 3.0 GHz.

From Hewlett-Packard, comes a fully programmable Transistor Noise Analyzer, Model 4470A. The instrument measures the transistor noise figure; e_n , or the thermal noise contribution to the noise figure, and i_n , from which the $1/f$ noise and the shot noise can be determined.

Also from H-P is a fully programmable preset counter, the 5330 A&B. This instrument is primarily for industrial use, where accurate counting between two limits or from a non-zero starting point is necessary.

Tektronix Inc., Beaverton, Ore., is displaying a new dual-beam scope, the Type R5030. This is a high-gain, differential-input, low-frequency scope. The most unique feature is that scale factors are read out digitally via fiber-optics.

Readouts indicate current or voltage amplitude plus the time, as set by the deflection controls.

Several solid-state microwave signal generators and sweep generators will be shown this year. One of the more interesting is the Model 1522A solid-state signal generator from Kay Electric Co., Pine Brook, N.J. It is completely frequency programmable to work in L and S bands.

Something a little different comes from General Radio. It is a digital capacitance bridge called the Model GR1682. In line with the apparent trend toward automated measurements, this instrument is completely programmable.

A variety of components

Varian Associates, Palo Alto, Calif., is showing two outstanding new products this year. One is an X-band, YIG-tuned Gunn oscillator. It is tunable from 8 to 12.4 GHz with 10 mW minimum output. The second is a K_A band Gunn oscillator. It has 10 mW minimum output and is mechanically tunable over any one GHz in the frequency range of 26.4 to 40 GHz.

From Radiation, Inc., Melbourne, Fla., comes a 16-channel analog multiplexer, the Model RS1000. This device makes use of LSI. Both MOS and bipolar transistors, and both vertical and horizontal structures, are used. The access time is 800 ns, and the commutation rate is 1.3 MHz.

A new current-sensitive CRT

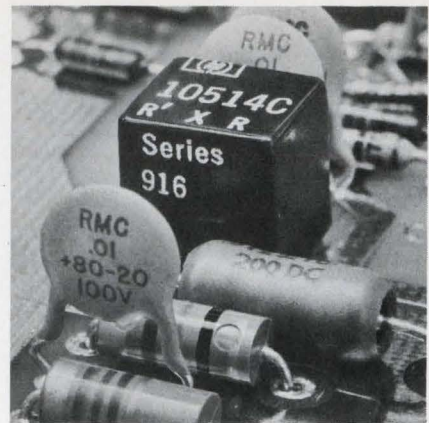

Hewlett-Packard miniature 500-MHz mixer mounts like a dual in-line package.

that is a single-gun multicolor comes from the ITT Electron Tube Div. It is the Model F3522, and it has a 5-inch-diameter face. The phosphor screen changes color as the current density changes.

Telonic Engineering, Laguna Beach, Calif., enters the microwave varactor tuned-filter field with its series TVF filter. The first model to reach the market tunes from 225 to 400 MHz. It comes with helical resonators in either 2, 3, or 4-section designs and weighs only 1 ounce.

A 500-MHz, double-balanced mixer by Hewlett-Packard will be on view. It is the Model 10514C and is the smallest mixer of its type and frequency to go on display. It is designed to fit on a printed-circuit board and to mount with the same pin spacing as a standard dual, in-line integrated-circuit package.

The product categories for the Wescon exhibits are similar to those for the technical sessions. They are:

- Instruments and Instrumentation.
- Circuit Components and Microelectronics.
- Computers and Electronic Data Processing.
- Circuit Packaging.
- Production and Processing Equipment.
- Microwave Equipment and Laser Systems.
- Solid-State Fabrication Equipment.
- Science Systems and Communications Equipment.

Plan your visit carefully and enjoy the show. ■■



The 23 technical sessions at this year's Wescon will be held in air-conditioned meeting rooms at the Cow Palace in San Francisco. About 45,000 engineers are expected to attend the big show.

The delicate art of packaging

Symposium to consider protection of circuitry in space, at cryogenic temperatures and elsewhere

John F. Mason
Military-Aerospace Editor

The vital, yet often-neglected, problems of packaging electronic circuits get the full treatment again this year at Wescon.

Scheduled to last two days, the International Electronic Circuit Packaging Symposium, Aug. 20 and 21, consists of eight sessions and a luncheon.

The keynote speaker, who is making a strong bid for standardization of techniques, is William L. Shockley, known for his work in thin-film and digital frequency synthesizer techniques. Formerly with Collins Radio, Shockley is now president of Nuclear Systems, Inc., in Dallas.

The fee for the sessions, luncheon and a copy of the proceedings is \$40.

"Our sessions will deal less with theory than most Wescon sessions and more with practical application," the organizing committee chairman, H. J. Scagnelli of Bell Telephone Laboratories, has told *ELECTRONIC DESIGN*. "We're going to have a number of special sessions this year. For example, packaging equipment for space flights will get heavy emphasis."

William S. Read of Jet Propulsion Laboratory starts off the space session, "Important Advances in Aerospace Avionics," by describing how JPL packaged the electronics for equipment to determine the survivability of a Mars rough lander.

Besides the normal problems of building equipment to survive the test and flight environments, the rough lander had to be sterilized at 125°C, prepared for an impact force of 2500 G at an impact

velocity of up to 125 feet a second.

Flexibility was the major design goal, Read says. The majority of the subassemblies were packaged in a standard profile with uniform attachments to the chassis. They were made flexible by designing the width to accommodate any special requirements that might come up. The packaging philosophy, he says, was to incorporate many different facets, such as planar packaging, welded cordwood and modular packaging.

Packaging for the deep freeze

Packaging electronics for use in cryogenic temperatures is described by Bernard J. Schebler of the Bendix Corp., Davenport, Iowa. Schebler presents actual cases: ex-

ternal and internal package concepts, printed-circuit card assemblies and components.

The techniques he describes were used in the design of optical discrete liquid-level point sensors for the Titan I and are being used successfully on the S-1C initial booster stage of the Saturn V launch vehicle.

Schebler talks about a new technique in packaging cryogenic instrumentation and control systems. It has been standard practice, he says, to run electrical cables carrying low-level signals for considerable distances from sensors and transducers to the electronic signal-condition equipment. Often, however, system performance is degraded by the dc resistance, capacitance, induced voltage, radio

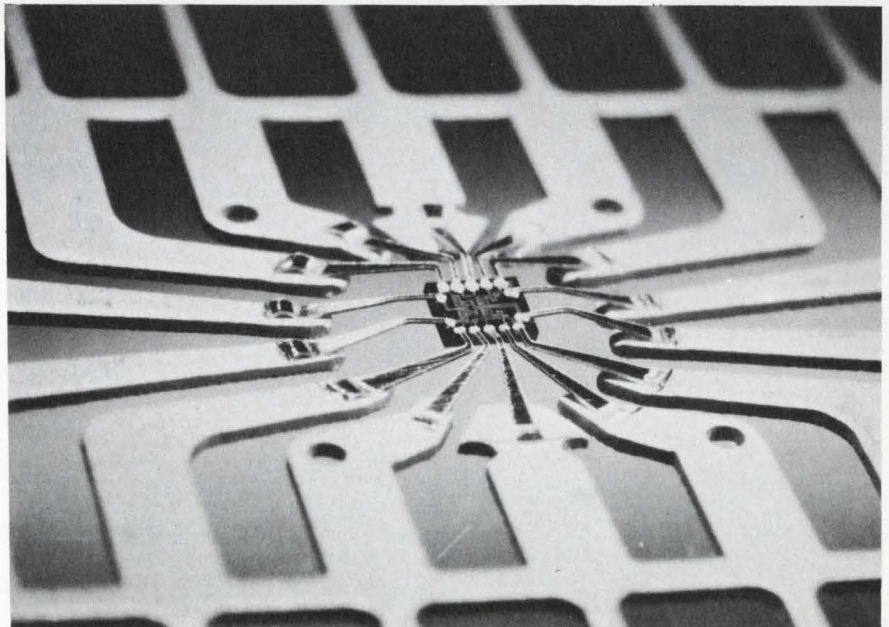

Spider bonding was used to mount this IC chip on a dual in-line lead frame. The spider is a stamped configuration with radiating fingers that match the bonding pads on the die at one extremity and the corresponding package lead at the other. Motorola developed spider bonding to cut costs.

frequency interference and galvanic voltage that normally prevail in long cables. The solution was to put the electronics next to the sensor or transducer. In some cases it was possible to use unshielded leads and even to house the electronics and sensor or transducer in a single package.

A single package offers advantages in system performance, weight, complexity and logistics, and it eliminates the interconnecting cables. The disadvantage is that the electronics must withstand the cryogenic temperature environment.

A real packaging challenge is being described by Denver J. Miller of the Electronic Systems Div. of TRW, Inc., Redondo Beach, Calif. Miller tells how his group packaged 2800 electronic components in a single housing that is capable of withstanding the environments encountered by spacecraft. The device is an electrical integration assembly that processes a command when combinations of horizontal and vertical matrix leads

are actuated.

The design ultimately chosen uses four double-sided printed circuit boards to provide flexibility for circuit changes.

Borrowing from microelectronics

Advances in microwave receivers are expected to come from improvements that have already been achieved in microelectronics. These include improved reliability, size and weight, cost, power consumption, thermal design and ruggedness of digital circuits. These improvements have revolutionized the mechanical design and appearance of digital equipment and low-frequency electronic assemblies. Now, however, according to Leonard Urban of TRW, it will shortly be possible to bring the benefits of microelectronics to microwave equipment. The preliminary design of the microelectronic microwave receiver illustrates the nature of the impending changes.

Many problems, of course, await the evaluation of trade-offs, Urban

says. Microwave equipment, for example, requires the use of closely aligned and finely tuned circuits. The optimum manner in which this is to be accomplished will be arrived at only after considerable experimentation and evaluation of results. Methods of shielding, interconnections and circuit design will probably require adaptation and innovation to meet the demands of microelectronic packaging.

Urban predicts widespread use of microwave receivers. Ultimately, he says, it is likely that with the expansion of satellite television and new information systems, microwave receivers and readout equipment will be consumer items that will permit every home in America to be a satellite ground receiving station.

New ways to make connections

An entire session is being devoted to discussing new ways to connect integrated circuit chips to packages and to hybrid circuits. While not widely used yet, these new technologies are important because they portend the future.

Murray Siegel of Intersil, Inc., Cupertino, Calif., describes flip-chip packaging, the ease with which this technique is used and its present disadvantages. High thermal resistance through the solder bumps limits the use of flip-chip packaging to low dissipation devices. And the bumps make bond inspection difficult because they're underneath the chip.

The bonds are visible in the beam-leaded chips (as described by a second speaker, Melvin G. Snyder of Raytheon, Mountain View, Calif.). But the same high thermal resistance holds true for beam-leaded chips as for flip-chip packaging. Also, beam-leaded chips require extra—and therefore more expensive—processing.

Spider-bonding integrated circuits, described by Robert W. Helda of Motorola Semiconductor Products Div., Phoenix, Ariz., is a quick process and therefore costs less. Motorola chose the approach because of its adaptability to a completely mechanized in-line process at low cost.

The spider is a stamped configuration with radiating fingers that match the bonding pads on the die

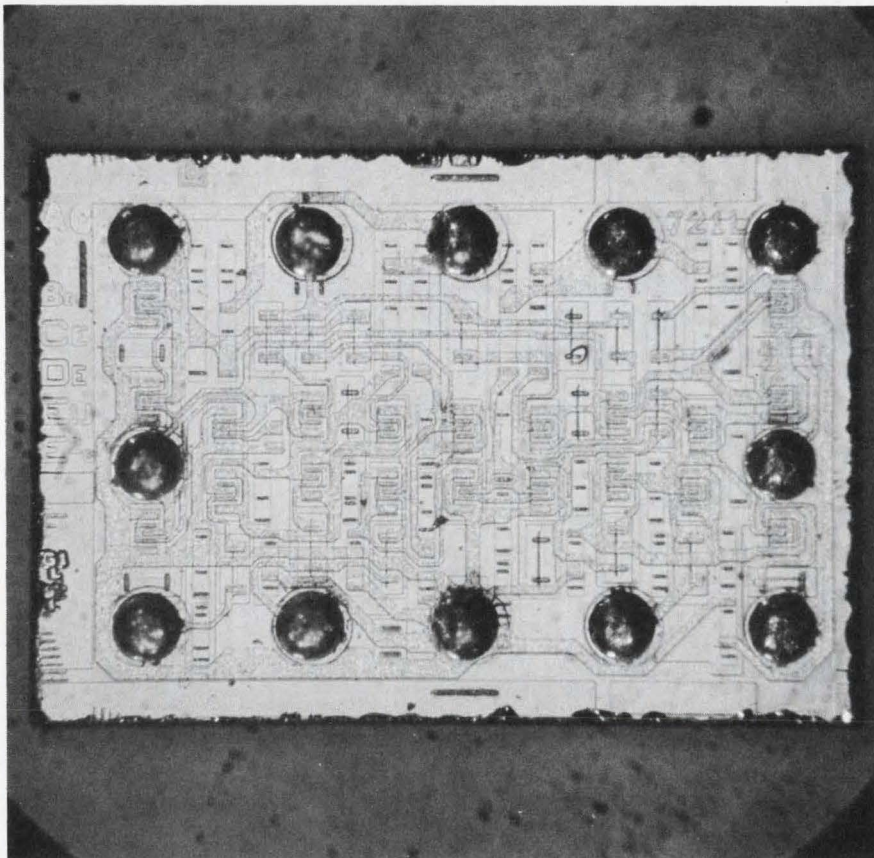

Monolithic chip is protected by a thin film of rf-sputtered silicon dioxide. The chip is 43 by 63 mils. All of the input terminals are linked to the peripheral pads, enabling all electrical connections to be made from one side of the chip. The technique is described by O. Bilous and E. J. Rymaszewski of IBM Components Div., Fishkill, N.Y.

at one extremity and the corresponding package leads at the other. The leads are held together by a common frame element, which is removed after the bonding is completed.

The biggest single advantage of this system, Helda says, is that the lead frames can be handled in continuous coils through die bond, frame bond, molding, frame cutting and forming, as well as through final test operations. Interim handling or reloading into carriers of the individual packages is avoided.

Besides aluminum, it is also possible to stamp the spider from copper and thus produce a spider that is ultrasonically bonded on the chip and may be soldered or thermo-compression bonded to a printed-circuit board or a ceramic substrate.

The single factor in the program at Motorola that was most difficult to achieve, Helda says, was the tooling for repeated stamping of the spiders to the accuracy and equal finger width required to achieve uniform and reliable bonding of 14 leads at one time.

In general, Helda says, Motorola feels that spider bonding is a timely solution to the high cost of wire bonding. Its versatility and potential has not yet been fully realized, since it's still undergoing the growing pains of a new production process.

Packaging with light

Expected to be of particular interest to packaging engineers this year is the session on laser applications in packaging.

The session organizers, Sidney Charschan of Western Electric in Princeton and Burton Unger of Bell Telephone Laboratories in Holmdel, N.J., are both engaged in laser packaging, and have taken care to insure that the talks of the four speakers are aimed at the engineer working in the field.

The organizers and the session moderator, R. H. Cushman, also of Western Electric in Princeton, are available for questions after the talks.

The main topics of the session are the pros and cons of various techniques used for bonding, trimming and measuring.

Welding uncommon metal combinations with a commercial ruby laser is being described in detail by F. P. Gagliano, Western Electric, Princeton.

Good fusion was obtained, Gagliano says, in welding with one pulse of the laser a pair of 0.010-inch-diameter precious-metal contact wires to a 0.009-inch-thick phosphor bronze spring leaf. The application was developed for production of a contact spring assembly of a relay used in public telephones.

Gagliano gives a second example of a current study on joining a 0.0005-inch-diameter tungsten wire to an aluminum stud. The bond was not a true fusion weld, Gagliano says, in that only the aluminum underwent melting. But pull tests have shown that the bond strength is equal to or greater than those made by conventional techniques.

At present, Gagliano says, it doesn't appear that the laser will replace the oxyacetylene torch for welding ship-plate thickness of steel and similarly thick metals. Aside from the economics of such an application, the weld depth is a limiting factor. Depending on the joint geometry, the maximum thickness of metal that can be welded, where full penetration is desired, is approximately 40 mils. Up to about twice this thickness can be welded with complete fusion penetration, if one can accept some material depletion from the laser irradiated surface.

For a pulsed laser, the duration of the light energy is short, nominally 2 to 10 milliseconds for welding. For the relatively small amount of molten metal that is achieved at the surface, the depth of the fusion front that is generated into the material is limited.

Continuous-wave lasers, such as the carbon dioxide nitrogen helium type, have not been fully investigated as welders yet, Gagliano says, "though some preliminary results in our own and other laboratories indicate appreciable depth of weld penetration can be achieved." The relatively low powers of the carbon dioxide laser and its highly reflective output radiation at 10.6-micron wavelength have until recently hindered its use in metal-joining processes. On the other hand, Gagliano points out, "the

pulsed laser, such as the ruby or neodymium-glass, can produce very high powers on the surface of materials, so as to melt them easily."

So far, Gagliano says, the laser has found its largest area of application as a welding tool in relatively small-scale and microminiature devices. Large-scale materials (50 mils in cross-sectional thickness) can be joined, with some limitations, by pulsed lasers, and they appear also to be very well suited for welding with cw lasers.

Value-trimming with light

A laser production process for helixing high precision metal film resistors is described in a paper prepared by D. V. Haffner and J. W. Summerford of Texas Instruments, Dallas. The glass encapsulated carbon film resistors are value-trimmed with a small ruby laser, with an energy capability of approximately 1 joule per pulse.

Cutting speed increases, the authors point out, as laser power capability increases and as mechanization speed reaches that required to be compatible with laser power. In addition, when continuous high-power visible lasers become prevalent, better metal film absorption of these visible wavelengths will permit rapid cutting with lower absolute optical power.

In other component fabrication operations, the authors foresee laser applications substantially increasing control of precision production operations, which provide inherent component reliability improvement. To the degree that such a laser application eases the tolerance requirements for other production operations, this concept is bound to have substantial impact on vital production costs.

The practical use of laser equipment in component fabrication will depend on solutions the laser can provide for present critical fabrication problems, the authors say. Among the operations that appear to lend themselves to production improvements, Haffner and Summerford list these: thin-film component value trimming, thick-film component value trimming, detector array cutting, ceramic substrate cutting, semiconductor wafer scribing and photomask master production. ■■

WHAT, WHEN AND WHERE

Wescon's technical timetable

1

LSI in Systems: The Design Task Interface

(Tue./a.m./A)

Chairman: Stephen E. Scrupski, Electronics Magazine, New York City.

1/1 Who Needs LSI In-House Capability?—George Hare, Singer Co., Palo Alto, Calif.

1/2 Using Computer-Aided Design in Production and Testing of Custom LSI—Robert Ulrickson, Fairchild Semiconductor, Mountain View, Calif.

1/3 Impact of LSI Technology on the Electronics Market—Glenn E. Penisten, Texas Instruments, Dallas.

1/4 The Vendor User Interface with MOS Universal Arrays—M. M. Kaufman and G. E. Skorup, RCA Defense Electronics, Moorestown, N.J.

2

Handling Microcircuits Automatically

(Tue./a.m./B)

Chairman: T. P. Long, Western Electric Co., Princeton, N.J.

2/1 Solid Logic Technology Manufacturing—Walter J. Schuelke, IBM, Hopewell Junction, N.Y.

Code to abbreviations

a.m.—Morning sessions (10 a.m. to 12:30 p. m.)

p.m.—Afternoon sessions (2 p.m. to 4:30 p.m.)

All sessions will be held in the following meeting rooms at the Cow Palace:

A—Meeting Room A

B—Meeting Room B

C—Meeting Room C

Numerals refer to sessions and to papers within a session—for example, 6/1 is paper 1 in session 6.

2/2 Bonding Techniques for Integrated Circuits—Robert W. Helda, Motorola Inc., Phoenix, Ariz.

2/3 Beam-Lead Assembly Technology—Brian Dale, Sylvania Electronics System, Woburn, Mass.

2/4 Manufacturing Concept for Beam-Lead Assembly—D. K. Thomson, Western Electric Co., Allentown, Pa.

3

Current Solid-State Microwave Devices and Circuits

(Tues./a.m./C)

Chairman: William E. Kunz, Watkins-Johnson Co., Palo Alto, Calif.

3/1 Solid-State Microwave Variable Delay Devices—Ernest K. Kirchner, Microwave Electronics, Palo Alto, Calif.

3/2 Bulk GaAs and IMPATT Microwave Sources—W. Keith Kennedy, Jr., Watkins-Johnson, Palo Alto, Calif.

3/3 Microwave Transistor Amplifier Design—James R. Reid, Avantek, Inc., Santa Clara, Calif.

3/4 Parameters Used in Specifying Varactor-Tuned Solid-State Oscillators—William D. Heichel and Thomas R. Bushnell, Stewart Div., Watkins-Johnson, Scotts Valley, Calif.

3/5 UHF Integrated Microcircuits—Robert M. Knox, IIT Research Institute, Chicago.

4

Integrated Circuits In Active Filters

(Tues./p.m./A)

Chairman: Gunnar Hurtig III, Kinetic Technology, Los Gatos, Calif.

4/1 Survey of Active Filtering Techniques Using Integrated Circuits—Sanjit Mitra, University of California, Davis, Calif.

4/2 A State Variable and Gyrator Realization-Comparison. Robert Newcomb, Stanford University, Stanford, Calif.

4/3 Active Filters Employing Silicon Monolithic Gytrators—Robert Hove, Boeing Co., Seattle.

4/4 Multiloop Negative Feedback Active Filters Using Thick-Film Integrated Circuit Techniques—Dennis Hollenbeck, Kinetic Technology, Los Gatos, Calif.

4/5 Fen Filter Design Using Hybrid Integrated Blocks—George Moschytz, Bell Telephone Labs., Holmdel, N.J.

4/6 ICs and Thick Films Add Up to Improved RC Active Filters—William Broyles, Sprague Electric, North Adams, Mass.

5

New Company Start-Ups: The Engineer Becomes Entrepreneur

(Tues./p.m./B)

Chairman: Don C. Hoefler, Electronic News, San Francisco.

5/1 The Many Routes to the Money Market—William B. Hugle, Hugle Industries, Sunnyvale, Calif.

5/2 Selling the Package: What They Want to Hear—David C. Thompson, Linear Systems, Watsonville, Calif.

5/3 Holding Your Own in the Money Market—Gordon L. Ness, Ness Industries, Palo Alto, Calif.

5/4 Why, How and When to Go Public—David S. M. Lanier Jr., Compar Corp., Burlingame, Calif.

6

Computer-Aided Design of High-Frequency Circuits

(Tues./p.m./C)

Chairman: Frank Arams, Airborne Instrument Labs., Melville, N.Y.

6/1 Strip-Line Characterization by Computer—H. E. Brenner, Bell Telephone Labs., Holmdel, N.J.

6/2 Computer-Aided Small Signal Transistor Modeling—F. H. Musa, Motorola Semiconductor, Phoenix, Ariz.

6/3 Computer-Aided Design of GaAs Impatt Diodes—C. K. Kim, Microstate Electronics, Murray Hill, N.J.

6/4 Microwave Circuit Synthesis and Measurement—H. Stinehelfer and W. Atwood, Microwave Associates, Burlington, Mass.

6/5 Computerized Wide-Band Amplifier Design—Les Besser, Hewlett-Packard, Palo Alto, Calif.

6/6 Computer-Aided Design of Microwave Integrated Circuits—Gary J. Policky, Texas Instruments, Dallas.

7

Time-Sharing and the Electronics Industry

(Wed./a.m./A)

Chairman: Joseph T. Hootman, Remote Computing Corp., Los Angeles.

7/1 Time Sharing: Why, When, Whither?—Robert Forest, Datamation Magazine, Pasadena, Calif.

7/2 What Can the Electronics Industry Do for Time-Sharing—Kas Terhorst, Computer Design Corp., Santa Monica, Calif.

7/3 Computer Languages—Why So Many, and What Is the Application For Each in the Engineering Community?—Paul Sleeper, Remote Computing Corp., Los Angeles.

7/4 Time-Sharing in Engineering Education—and After—Eugene H. Koff, California State College,

8

Manufacturing and Computers

(Wed./a.m./B)

Chairman: George H. Ebel, Conrac Corp., Caldwell, N.J.

8/1 The Stand Alone, Central or Satellite Approach for Computer Control of Manufacturing Processes?—James E. Stuehler, IBM, White Plains, N.Y.

8/2 Factory Data Collection—A Case Study—James D. Edwards, Lockheed, Sunnyvale, Calif.

8/3 Computer Controlled On-Line Testing and Inspection—Peter H. Goebel, General Radio, West Concord, Mass.

8/4 Automated Factory—An Overview and Predictions—Walter R. Anderson, IRA Systems, Waltham, Mass.

9

Linear Integrated Circuits in Communications

(Wed./a.m./C)

Chairman: Alan B. Grebene, Signetics

Corp., Sunnyvale, Calif.

9/1 VHF MOS Receiver Front-End—Richard Q. Lane, Fairchild Semiconductor, Palo Alto, Calif.

9/2 Linear ICs in Consumer Television and AM/FM Receivers—S. B. Marshall and G. W. Haines, Sprague Electric Co., Worcester, Mass.

9/3 Efficient Use of Pins in Complex Communication Subsystems—Robert A. Hirschfeld, National Semiconductor, Santa Clara, Calif.

9/4 The Systems Approach to the Design of Integrated Communication Circuits—Hans R. Camenzind, Signetics Corp., Sunnyvale, Calif.

10

Instructional TV and What It Means to Industry

(Wed./p.m./A)

Chairman: Donald J. Grace, Stanford University, Stanford, Calif.

10/1 University-Industry Television, Radio and Telephone Links—Albert J. Morris, Genesys Systems, Inc., Mountain View, Calif.

10/2 Stanford Instructional TV Network—Joseph M. Pettit and Donald J. Grace, Stanford University, Stanford, Calif.

10/3 Association for Continuing Education (ACE)—Julian Johnson, ACE.

10/4 University of California at Berkeley—TV Plans and Status—George Maslach, University of California, Berkeley, Calif.

10/5 University of Santa Clara—TV Plans and Status—Charles Dirksen, University of Santa Clara, Santa Clara, Calif.

10/6 Television Instruction at San Jose State College—Norman Gunderson, San Jose State, San Jose, Calif.

10/7 University of California at Irvine—UCLA—TV Systems, Plans and Status—Robert M. Saunders, University of California, Irvine, Calif.

10/8 University of Southern California—Instructional TV Network—Jack Munushian, University of Southern California, Los Angeles.

11

Signal Processing in Digital Communications

(Wed./p.m./B)

Chairman: Adam Lender, Lenkurt Electric Co., San Carlos, Calif.

11/1 Digital Implementation of Data Transmission Modulators and De-

modulators—W. J. Melvin, Collins Radio, Newport Beach, Calif.

11/2 A Simple Adaptive Equalizer for Efficient Data Transmission—D. Hirsch and W. J. Wolf, Bell Telephone Labs., Holmdel, N.J.

11/3 Practical Adaptive Equalizers for Data Transmission—Gerald K. McAuliffe, IBM Watson Research Center, Yorktown Heights, N.Y.

11/4 Recent Developments in Error Control Techniques—Allen H. Levesque, General Telephone and Electronics Labs., Waltham, Mass.

12

Data Relay Satellites

(Wed./p.m./C)

Chairman: E. J. Istvan, Comsat Corp., Washington, D.C.

12/1 Collection of Data from In Situ Sensors Via Satellite—S. D. Dorfman, Hughes Aircraft Co., El Segundo, Calif.

12/2 Application of Satellites to Domestic Record Data and Video Transmission—W. B. Gross, General Electric, Valley Forge, Pa.

12/3 A Multiple-Access Satellite Relay System for Low Data Rate Users—P. J. Heffernan, NASA-Goddard Space Flight Center, Greenbelt, Md.

12/4 Wideband Transmission of Photographic Data Using the IDCSP Satellites—W. J. Gill, Philco-Ford, Palo Alto, Calif.

12/5 Coding and Signal Selection for the Data Relay Satellite Interrogation Channel—G. D. Boyce, General Dynamics Convair, San Diego, Calif.

13

High-Speed Oscilloscope Recording

(Thur./a.m./A)

Chairman: James R. Pettit, Hewlett-Packard, Colorado Springs, Colo.

13/1 Computer Techniques in High-Frequency Circuit Design—Alan J. DeVilbiss, Hewlett-Packard, Colorado Springs, Colo.

13/2 A Novel Approach to High-Frequency Trigger Circuit Design—Richard McMorrow and William Farnbach, Hewlett-Packard Co., Colorado Springs, Colo.

13/3 Transient Oscillography with Photographic Media—A. E. Ames, R. C. Jones, G. R. Bird, Polaroid Corp. Research Labs., Cambridge, Mass.

13/4 High-Speed Single Transient Oscilloscopes, The State of the Art, and Current Potential for Mating to On-Line Computers—Gordon Longer-

beam, Jay Wiedwald and Larry Ferderber, Lawrence Radiation Lab., Livermore, Calif.

14

Overseas Marketing: A Perplexing Opportunity

(Thur./a.m./B)

Chairman: C. Gerald Diamond, Sensus International, San Francisco.

14/1 European Electronics Market: 1969—R. J. Larkin Jr., Ampex Corp., Redwood City, Calif.

14/2 Marketing Electronic Products in Japan—James K. Imai, Mentor, Japan.

14/3 The New Asian Electronics Market Outside of Japan—G. B. Levine, Mentor International, San Francisco.

14/4 Alternatives to Direct Sales: License, Joint Venture, and Subsidiary—Carl J. Bradshaw, Oak Electronics Corp., Crystal Lake, Ill.

15

MOS ICs: A Critical Review

(Thur./a.m./C)

Chairman: Raymond D. Speer, ELECTRONIC DESIGN Magazine, New York City.

15/1 MOS ICs: The Designer's Dilemma—Glen Madland, Integrated Circuit Engineering Corp., Phoenix, Ariz.

15/2 MOS ICs: Answers to Systems Problems—Ralph Parris, Burroughs Corp., Plymouth, Mich.

15/3 MOS/LSI: A Joint Business Venture—Larry Drew, Viatron Computer Systems Corp., Burlington, Mass.

15/4 MOS ICs: Bipolar Compatibility is Here—Leland Seely, General Instrument Corp., Hicksville, N.Y.

15/5 MOS ICs: The Promise of Things to Come—Al Phillips, Autometrics, Anaheim, Calif.

16

Automatic Production of Semiconductors

(Thur./p.m./A)

Chairman: Orville R. Baker, Signetics Corp., Sunnyvale, Calif.

16/1 Theory of Automatic Processing—Frank E. Boerger, IBM Corp., East Fishkill, N.Y.

16/2 Equipment for Automatic Processing—Donald G. Pedrotti, Hugel Industries, Sunnyvale, Calif.

16/3 Case History of Automatic Processing—Robert Schuffler Jr., Hewlett-Packard Co., Loveland, Colo.

16/4 The Future of Automatic Processing—C. Clifford Roe, Fairchild Semiconductor, Mountain View, Calif.

17

High-Power Microcircuits —The Real Challenge

(Thur./p.m./B)

Chairman: Robert E. Koeper, EDN Magazine, Denver, Colo.

17/1 Monolithic Voltage Regulators—Thomas M. Frederiksen, Motorola Integrated Circuits Center, Mesa, Ariz.

17/2 Voltage Regulator Capabilities Using Hybrid Techniques—George W. Smith, Beckman Instruments Inc., Fullerton, Calif.

17/3 High-Power Hybrid Amplifiers—Herb Miesel, Dale Baugher, and Leon Balents, RCA, Somerville, N.J.

17/4 Controlling Power on a Chip—William D. Whittekin Sr., Texas Instruments, Dallas.

17/5 What is Needed in Power Microcircuits—James W. Williams, Hughes Aircraft Co., Culver City, Calif.

18

Trends in Large System Data Display

(Thur./p.m./C)

Chairman: E. R. Owen, General Electric Co., Daytona Beach, Fla.

18/1 Status Trends & Predictions of Display Devices—Edwin H. Hilborn, NASA Electronics Research Center, Cambridge, Mass.

18/2 Displaying Engineering Data in Systems Applications on a Color CRT—I. M. C. Griesacker, General Electric Co., Houston, Texas, and Walter H. Tew, General Electric, Daytona Beach, Fla.

18/3 Image Distribution System, an Approach Toward Personal Displays—Joe T. Ma, IBM Corp., Los Gatos, Calif.

18/4 The Application of Digital Television Displays to Computer-Directed Control Systems—S. E. Grooms, Philco-Ford, Houston.

18/5 On-Line Graphics for Information Handling & Display—John E. Peyton Jr., Boeing Co., Seattle, Wash.

19

Future Avionics System Architecture

(Fri./a.m./A)

Chairman: R. K. Whitford, TRW Systems Group, Redondo Beach, Calif. and Joseph Rodriguez, Grumman Aircraft Engineering Corp., Bethpage, N.Y.

19/1 Integrated Avionics—Richard D. Alberts, AF Avionics Lab., Wright-Patterson AFB, Ohio

19/2 Federated vs. Integrated Computer Systems—J. H. Crenshaw, IBM Federal Systems Div., Owego, N.Y.

19/3 Role of Man and Machine in Future Avionics Systems—L. S. Guarino, Naval Air Development Center, Johnsville, Warminster, Pa.

19/4 Realizing Objectives for Complex Avionic Computer Systems—H. Barry Schoenky, Teledyne Computer Systems Div., Northridge, Calif.

19/5 Design Concepts in Avionics and Space Equipment—J. R. Goodykoontz, V. A. Karpendo, TRW Systems Group, Redondo Beach, Calif.

20

New Solid-State Devices

(Fri./a.m./B)

Chairman: Robert N. Noyce, Intel Corp., Mountain View, Calif.

20/1 Ecological Niches for Optoelectronic Devices—E. E. Loebner and H. Borden, Hewlett-Packard Co., Palo Alto, Calif.

20/2 New Solid-State Products—Digital Circuits—Morris Chang, Texas Instruments Semiconductor Circuits Division, Dallas.

20/3 Bulk Semiconductor Devices for Microwaves, Millimeter Waves, and Beyond—John A. Copeland, Bell Telephone Labs., Murray Hill, N.J.

20/4 Linear Circuits for Communications Applications—Derek Bray, Fairchild Semiconductor, Mountain View, Calif.

21

Computer-Aided Testing: Problems and Solutions

(Fri./a.m./C)

Chairman: A. Machi, Bendix Navigation & Control Div., Teterboro, N.J.

21/1 Designing Avionic Equipment for Automatic Testing—Richard O.

Barrett, Honeywell Aerospace Division, Minneapolis, Minn.

21/2 Development of Software Systems for Automated Test Equipment (CATE)—Eddie J. Johnson and James V. McCarthy, System Development Corp., Paramus, N.J.

21/3 A Computer Controlled Test System—Frank M. Stutesman, Bendix Navigation & Control Div., Teterboro, N.J.

21/4 Hardware/Software Management—Computer Aided Testing—D. S. Bassett, Emerson Electric Co., St. Louis, Mo.

22

Instrumentation for High-Speed Phenomena

(Fri./p.m./A)

Chairman: Gordon T. Longerbeam, Lawrence Radiation Lab., Livermore, Calif., and Sid Sternick, EG&G, San Ramon, Calif.

22/1 The Trac System—G. St. Leger-Barter, Lawrence Radiation Lab., Livermore, Calif., and S. Walter, EG&G, San Ramon, Calif.

22/2 Wideband Attenuation and Phase Measurements on High-Quality Coaxial Cables—R. L. Rhoads and A. M. Evans, Lawrence Radiation

Lab., Livermore, Calif.

22/3 Wideband System Function Analyzer Employing Time to Frequency Domain Translation—A. M. Nicolson, Sperry Rand, Sudbury, Mass.

22/4 An Iterative, Time Domain Method of System Response Correction—M. P. Ekstrom, Lawrence Radiation Lab., Livermore, Calif.

23

Computer-Aided Circuit Design and Testing

(Fri./p.m./B)

Chairman: Ron Rohrer, Fairchild Semiconductor, Mountain View, Calif.

23/1 Computer-Aided Circuit Analysis—Harry B. Lee, Massachusetts Institute of Technology, Lincoln Lab., Lexington, Mass.

23/2 Bipolar Transistor Modeling for Computer-Aided Design—William G. Howard Jr., University of California, Berkeley, Calif.

23/3 Network Design by Mathematical Optimization—S. W. Director, University of Florida, Gainesville, Fla.

23/4 Computer-Aided Layout—Les Hazlett, Motorola, Phoenix, Ariz.

23/5 Automatic Test Synthesis—E. R. Jones, Fairchild Semiconductor, R&D Lab., Palo Alto, Calif.

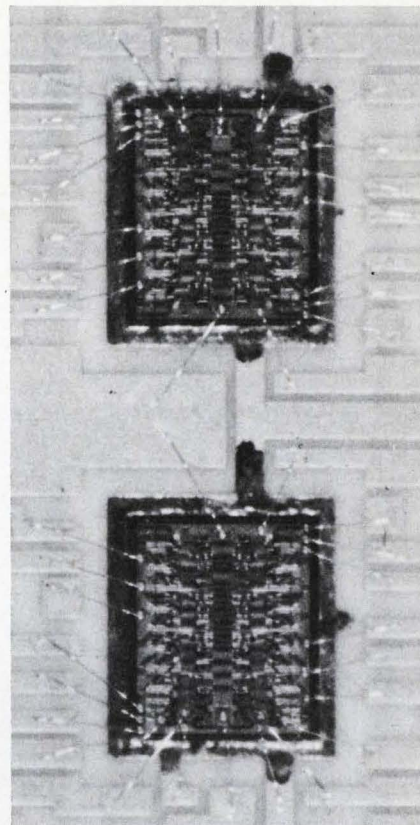

Complex digital circuits, such as this 104-gate, 32-bit ECL active element memory from Texas Instruments, will be discussed in Wescon paper 20/2.

Guide to packaging symposium

1

Important Advances in Aerospace Avionics

(Wed./9 a.m.-11:15 a.m.)

Moderator: F. E. Grace, IBM Corp., Poughkeepsie, N.Y.

1/1 Electronic Packaging and Cabling of a Mars Rough Lander—William S. Read, Jet Propulsion Lab., Pasadena, Calif.

1/2 Packaging of Electronics for Use at Cryogenic Temperatures—Bernard J. Schebler, Bendix Instruments and Live Support Div., Davenport, Iowa.

1/3 Techniques Utilized in Packaging Spacecraft Electronics—Denver J. Miller, TRW Redondo Beach, Calif.

1/4 Advanced Concept for a Microelectronic Microwave Receiver—Leonard Urban, TRW, Redondo Beach, Calif.

2

Modern Packaging Materials and Processes

(Wed./11:15 a.m.-3 p.m.)

Moderator: R. C. Mayne, Jet Propulsion Lab., Pasadena, Calif.

2/1 Polyimide Film in Chip Packaging and Interconnection—K. C. Hu, Hughes Aircraft Co., Newport Beach, Calif.

2/2 Powder Construction of Conductive Holes—L. F. Miller, IBM Components Div., Hopewell Junction, N.Y.

2/3 The Application of Polyamide-Imide Materials for Computer Memory Jumper Cables—J. R. Cannizzaro and P. E. Twigg, IBM Electronics Systems Center, Owego, N.Y.

2/4 Testing for Chemical Inertness in Electronic Coolants—A. A. Arcus,

3

Lubrication in High Vacuum or Space

(Wed./3:15 p.m.-5:15 p.m.)

Moderator: J. C. Rubin, Eastman Kodak, Rochester, N.Y.

3/1 Development Use of Solid Film Lubricants—Charles E. Vest, Goddard Space Flight Center, Greenbelt, Md.

3/2 Testing of Solid Lubricants—Hayni T. Azzam, Dow Corning Corp., Stamford, Conn.

3/3 Application of Solid Film in Aircraft and Aerospace Industries—Lowell Horwedel, Electrofilm Corp., North Hollywood, Calif.

3/4 Solid Lubricants in the Communications Industry—George Kitchen, Bell Telephone Labs., Murray Hill, N.J.

4

Which Microcircuit Package—Flip-Chip, Beam Lead, or Spider?

(Wed./3:15 p.m.-5:15 p.m.)

Moderators: M. I. Ross, The Milton Ross Co., Southampton, Pa., and Dr. W. B. Hogle, Hogle Industries, Sunnyvale, Calif.

4/1 Experience with the Flip-Chip Package—Murray Siegel, Intersil, Inc., Cupertino, Calif.

4/2 Experience with the Beam-Lead Package—Melvin G. Snyder, Raytheon, Mountain View, Calif.

4/3 Spider Bonding Technique with I/Cs—Robert W. Helda, Motorola Semiconductor Prods. Div., Phoenix, Ariz.

4/4 Production Equipment for the

New Packages—Dr. Hans M. Wagner, Hogle Industries, Sunnyvale, Calif.

5

Intra/Inter-Connections—What's New?

(Thur./9 a.m.-11:15 a.m.)

Moderator: E. J. Lorenz, IBM Corp., Poughkeepsie, N.Y.

5/1 Bonding Devices to Hybrid Circuits with Formed Projections—M. H. Bester, Autonetics, Anaheim, Calif.

5/2 Reflow Soldering with Radiant Heating—David Schoenthaler, Western Electric Co., Princeton, N.J.

5/3 High-Efficiency Packaging Using Total Flex Circuitry—Charles H. Kahaian and Alfred Righini, Sylvania Electronics Systems, Needham Heights, Mass.

5/4 Pulsed Arc Spot Welder—M. J. Davis, Sandia Lab., Albuquerque, N.M.

6

Emphasis on Microelectronic Packages

(Thur./11:15 a.m.-2:30 p.m.)

Moderator: T. A. Telfer, General Electric Co., Utica, N.Y.

6/1 Medium-Density Monolithic Logic Technology—Orest Bilous and E. J. Rymaszewski, IBM Components Div., Hopewell Junction, N.Y.

6/2 A Plastic Dual-in-Line Approach for Thick-Film Hybrids—Dean C. Bailey, Transformer-Electronics Co., Boulder, Colo.

6/3 A High-Density Packaging Approach for Integrated Circuits—R. F. David and R. F. Peluso, Martin-Marietta Corp., Denver, Colo.

7

Evaluation Methods in Packaging

(Thur./2:45 p.m.-4:45 p.m.)

Moderator: J. R. Goodykoontz, TRW Systems, Redondo Beach, Calif.

7/1 Nondestructive Evaluation of Printed Wiring Boards. Bernard Stiefel, Sandia Corp., Albuquerque, N. M.

7/2 Liquid Crystal and Infrared Thermal Measurements of Monolithic Integrated Circuit Chips—J. W. Mulligan and P. W. Ing, IBM, New York, N.Y.

7/3 Plastic Encapsulated Semiconductor Reliability Today—Edward B. Hakim, U.S. Army Electronics Command, Fort Monmouth, N.J.

7/4 Test Sites for Microelectronics—Franklin Miller, Dynetec Systems Corp., Upper Saddle River, N.J.

8

Laser Applications in Packaging

(Thur./2:45 p.m.-5:15 p.m.)

Moderator: R. H. Cushman, Western Electric, Princeton, N.J.

8/1 Use of the CO₂ Laser in Cutting Applications—Ted A. Osial, Westinghouse Electric, Sykesville, Md.

8/2 Laser Microwelding of Uncommon Metal Combinations. L. P. Gagliano, Western Electric, Princeton, N.J.

8/3 Laser Trimming of Thick-Film Resistors—R. L. Waters, Union Carbide Corp., Santa Monica, Calif.

8/4 Yag Laser Resistor Trimmer. John Summerford, Texas Instruments, Dallas.

8/5 In-Process Applications of Laser Metrology. S. Minkowitz, The Perkin-Elmer Corp., Wilton, Conn.

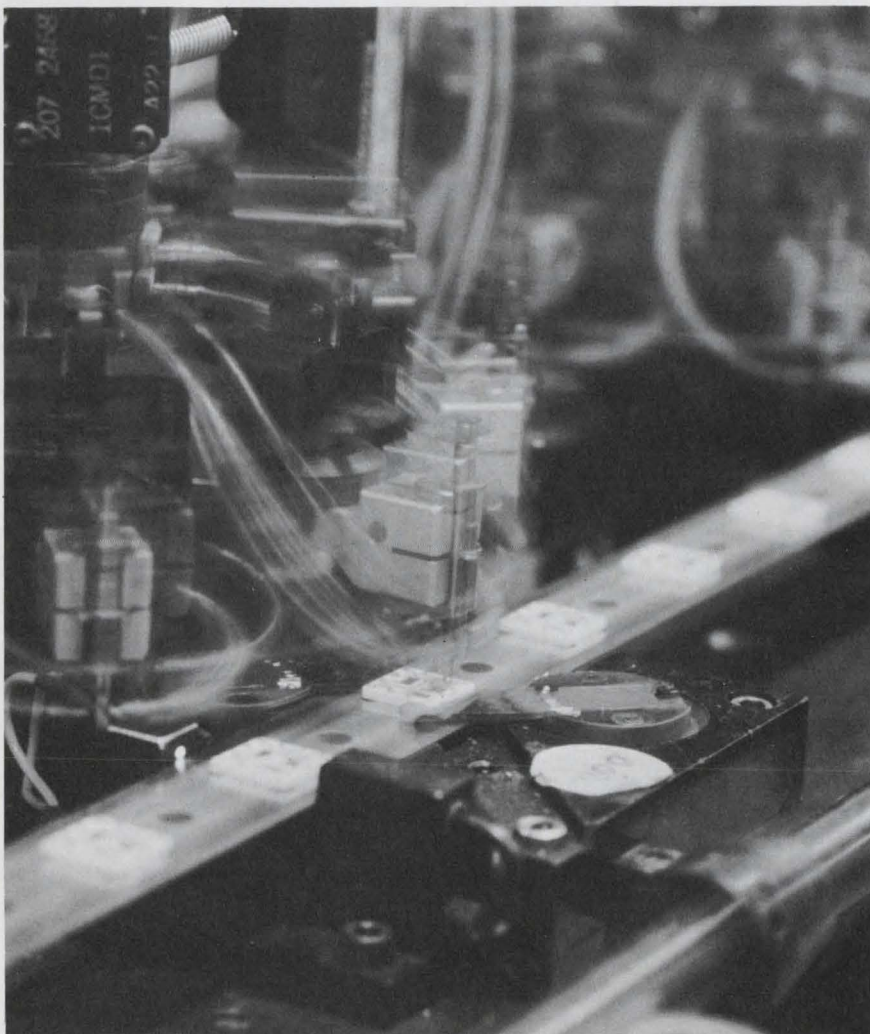

Chip transistors and diodes are placed on alumina substrate at IBM's solid logic manufacturing facility, Hopewell Junction, N.Y. (Paper 2/1).

Prevent Indatagestion

Overstuffed with data? And fed-up with confining equipment?

Do what modern engineers and researchers do. Reach for a soothing Datatron.

These fast-acting data acquisition and reduction systems quickly convert analog and digital inputs into a computer-compatible format. Efficient assimilation of data means more effective use of information handling equipment. Not to mention the substantial savings in engineering and research time.

A Datatron system begins by accepting multi-channel analog and/or digital inputs. A self-contained A to D converter then formats the analog data. Finally, the processed data outputs to any commonly-used recording device or directly to a digital computer.

Moreover, the family-size Model 1500 Series systems are conveniently packaged complete with their own output equipment—a digital tape recorder (Models 1500 and 1510), teletype machine (Model 1520), printer (Model 1530), or tape punch (Model 1540). This recommended dose needs only to be connected to the data source to reach full-strength system operation.

On the other hand, if an output device already exists, just the interfacing/converting portion of the system can be taken. In dimensions and price, this system—known as the Model 1000 Series—is truly an economy-size packet.

For an additional pick-me-up, both systems will accommodate such on-the-spot data verification functions as a search and playback mode, D to A converter, and printer readout.

What puts the fizz in Datatron? When taken into your system, thousands of tiny TTL and DTL IC's go to work, bringing fast, fast relief. This type of solid-state design reduces power and size requirements... while providing excellent noise immunity (except, of course, for the bubbles).

So feed your data handling system all you want. But to get rid of that stuffy feeling, take one or two Datatrons. As directed in our fully-detailed, 12-page brochure.

Send for it today. It'll help get your data in shape.

No matter what shape your data's in.

Datatron Inc.

1562 Reynolds Avenue
Santa Ana, California 92705
(714) 540-9330

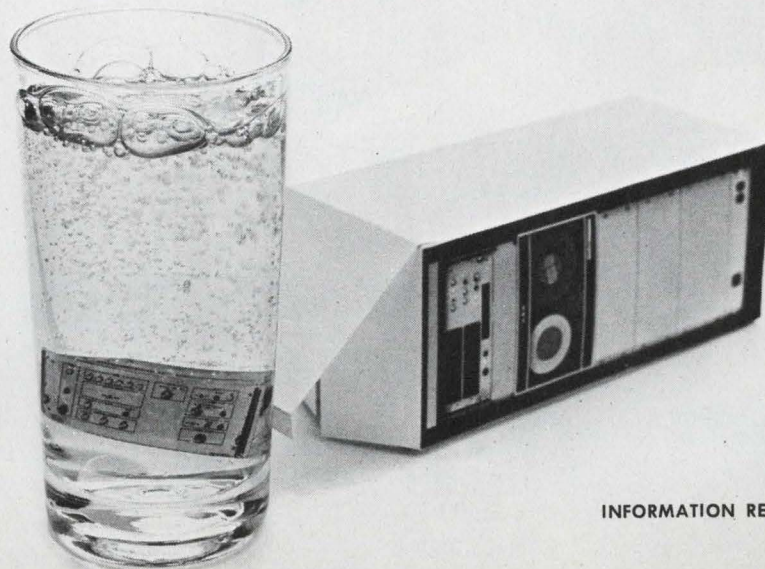

INFORMATION RETRIEVAL NUMBER 29

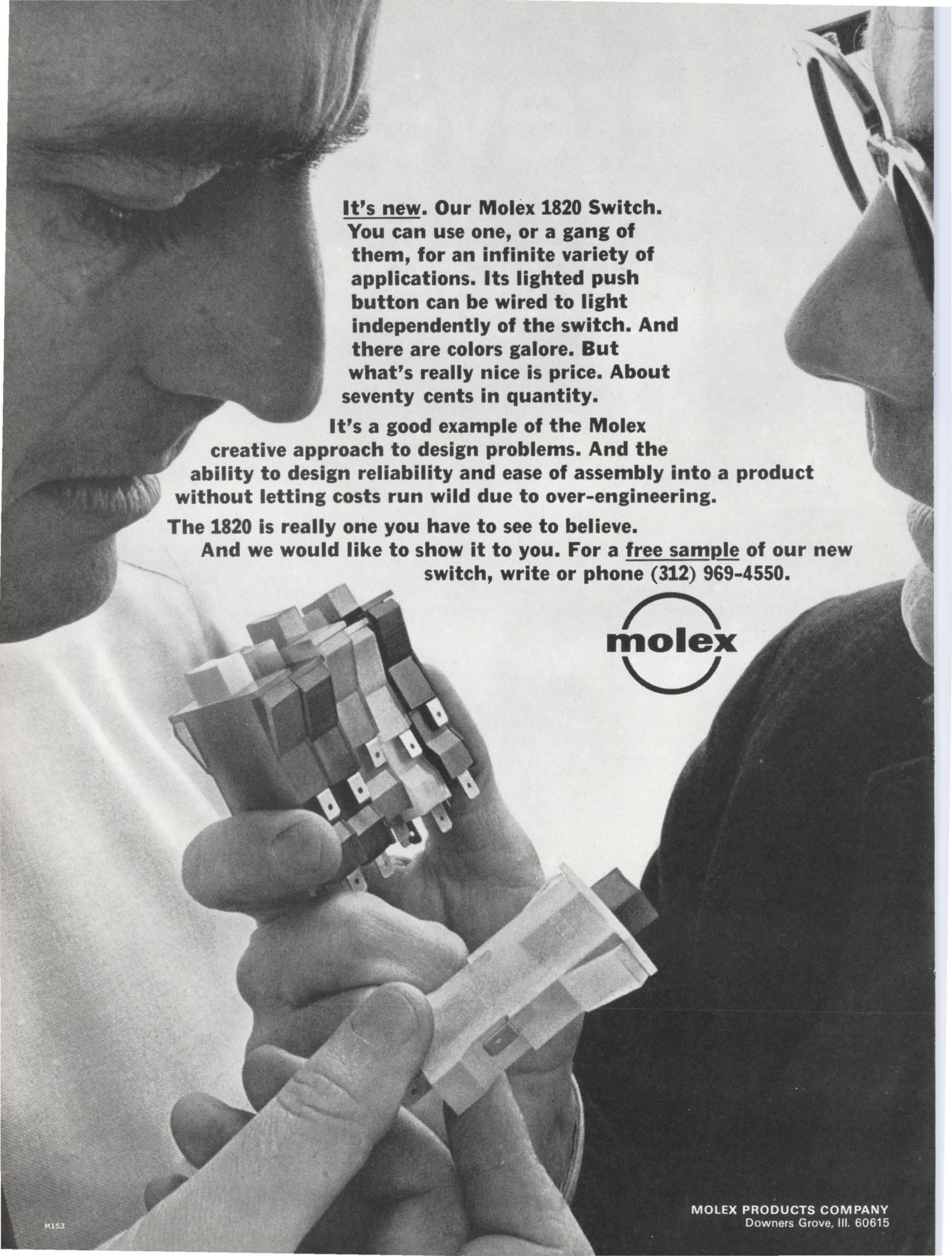

It's new. Our Molex 1820 Switch. You can use one, or a gang of them, for an infinite variety of applications. Its lighted push button can be wired to light independently of the switch. And there are colors galore. But what's really nice is price. About seventy cents in quantity.

It's a good example of the Molex creative approach to design problems. And the ability to design reliability and ease of assembly into a product without letting costs run wild due to over-engineering.

The 1820 is really one you have to see to believe.

And we would like to show it to you. For a free sample of our new switch, write or phone (312) 969-4550.



Publisher

Hugh R. Roome

Editor

Howard Bierman

Managing Editor

Frank Egan

Technical EditorsMilton J. Lowenstein
Michael J. Riezenman
Raymond D. Speer
Stella Lawrence**Management and Careers Editor**

Richard L. Turmail

News EditorsRalph Dobriner, Chief
John N. Kessler**Washington News Bureau**

Charles D. LaFond, Chief

Military/Aerospace Editor

John F. Mason

East Coast Editor

Jim McDermott

West Coast EditorsElizabeth deAtley
David N. Kaye**New Products Editor**

Lucinda Mattera

Copy Editor

Marion Allen

Editorial ProductionDollie S. Viebig
Anita F. Needleman**Art Director**

Clifford M. Gardiner

Art Assistant

William Kelly

Technical IllustratorsWilliam Alvarez
Rita Jendrzejewski
Lynn E. Thompson**Production Manager**

Thomas V. Sedita

Asst. Production Manager

Helen De Polo

Production AssistantsBernard Wolinsky
Carl A. Merkin**Circulation Manager**

Nancy L. Merritt

Information Retrieval

Genate Piccinetti

EDITORIAL



The great ABM debate . . . or, Has it really been that great?

Some disturbing issues have been raised in the verbal tug-of-war over whether or not to start deploying the Safeguard system, but even more disturbing are the argumentative techniques and motivations that have emerged.

Will Safeguard work? Is it necessary for the national defense? Is it really a threat to peace?

As the long controversy over questions like these heated up to sizzling pitch by late spring, it became apparent that in many prominent cases rhetoric was replacing reason, and facts were giving way to generalizations and cliches.

True objectivity is not enhanced by having well-known entertainers ridicule pro-ABM arguments at anti-ABM rallies. Nor is reason served by those who characterize ABM opponents as "phony peaceniks" or worse.

On questions as significant as the ones affecting ABM, facts and respected opinion should—in actuality, must—be the ultimate criteria in reaching a decision. This means that politicians, for their part, should treat as irrelevant such considerations as possible embarrassment of the Administration or possible advantage at the polls in the next Presidential election. Likewise, painful though it may be, industry proponents should treat as irrelevant any immediate economic gain, such as the possibility of a juicy contract in what shapes up as a multibillion-dollar program.

What *is* relevant?

The studied and carefully considered opinions of respected scientists and engineers. The thoughtful analyses of competent diplomats.

But since when do respected scientists qualify automatically as competent diplomats?

Yet, in the thick of the ABM debate, we have been "warned" again and again by some *scientists* that Safeguard is a threat to international peace; that it will doom any meaningful disarmament talks with the Soviet Union. History is filled with examples of experts who stumbled when they attempted to transfer their expertise to unfamiliar fields. One has only to recall Dr. J. Robert Oppenheimer and his opposition to the H-bomb—an opposition based largely on moral grounds without full consideration of whether other nationals besides the U. S. would respect these moral grounds.

Nor has there been any shortage in the ABM debate of competent businessmen, economists and others who have become instant "experts" in science.

It's time the nation learned, in making great decisions like this one, to stop the shouting and posturing and let the real facts emerge—calmly, quietly, sanely.

FRANK EGAN

**Pick
a winner.
We did.**

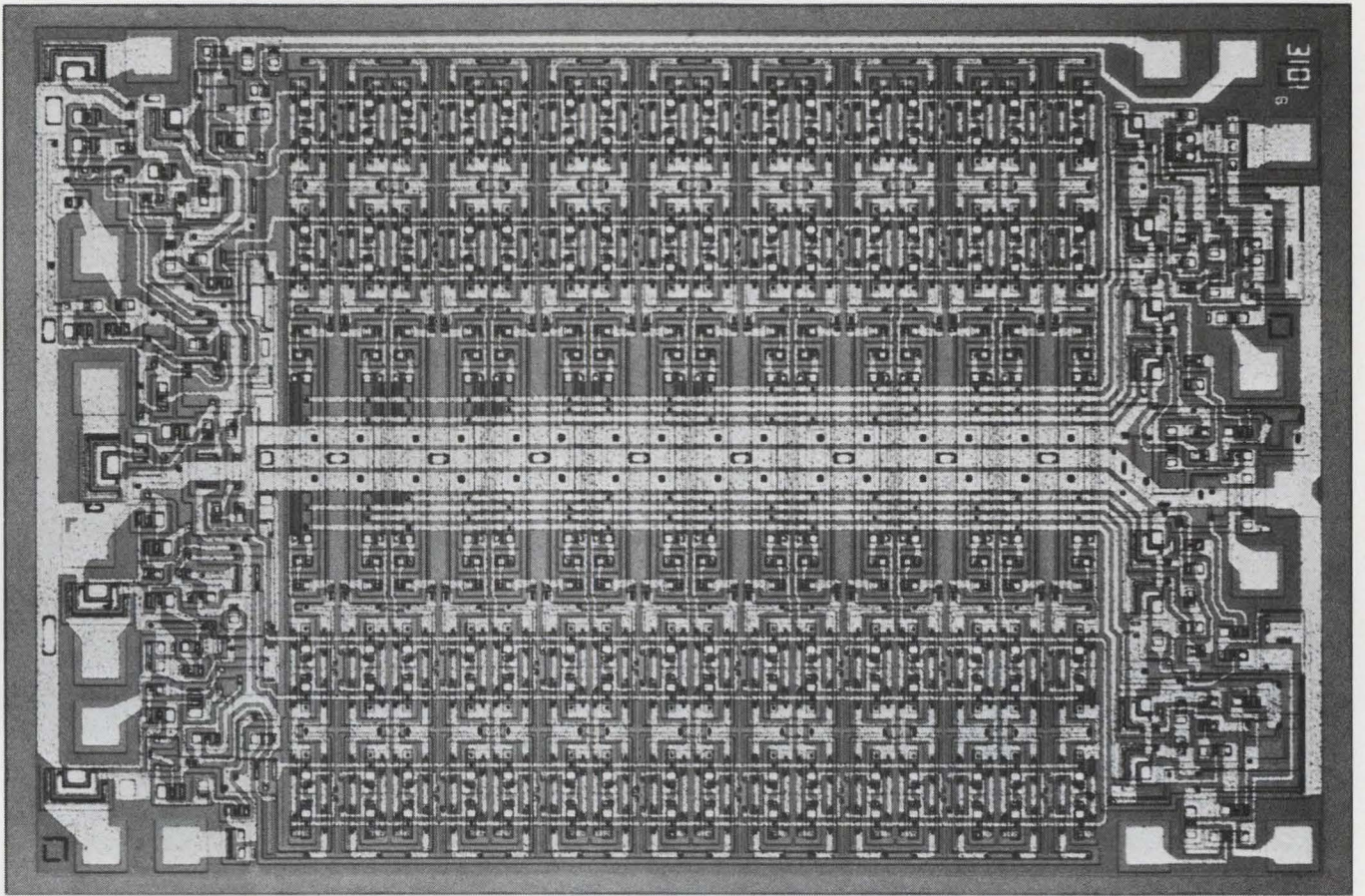

Introducing the Intel Schottky process Model 3101 Bipolar Scratch Pad Memory. 64 bits—16 x 4/fully decoded / 50 nanoseconds access time / OR-tie capability/simple memory expansion through chip select input/6 milliwatts per bit power dissipation/16 lead D.I.P.

If you are interested in a winner, too, call your nearest Intel distributor.

Intel LSI Memory circuits are available from 40 outlets throughout the United States and Canada. Call your local Intel distributor, Cramer Electronics or Hamilton Electro Sales, for instant service. If it is more convenient, you may write or call us collect (415-961-8080).

intel

INTEL CORPORATION, 365 Middlefield Road, Mountain View, California 94040/(415) 969-1670/Telex INTEL 34-8366
Regional Offices: 1741 Pitcairn, Costa Mesa, California 92626/(714) 545-8541
P.O. Box 206, Andover, Massachusetts 01810/(617) 536-0700

INFORMATION RETRIEVAL NUMBER 31

**Pick
a winner.
We did.**

Intel LSI memory circuits now available through our fine distributors, Cramer Electronics and Hamilton Electro Sales.

To place an order or obtain more information, call the most convenient office listed below. If it is easier, you may write or phone us collect (415) 961-8080.

ALABAMA	Huntsville	Cramer Electronics, 222 N. Memorial Parkway (205) 536-4493
ARIZONA	Phoenix	Hamilton Electro Sales, 1741 North 28th Avenue (602) 272-2601
	Tempe	Hyer-Cramer Electronics, 3300 S. Mill (602) 967-8786
CALIFORNIA	Culver City	Hamilton Electro Sales, 10912 W. Washington Blvd. (213) 871-0404
	Glendale	R & C Cramer Electronics, 608 Sonora Avenue (213) 243-6224
	Mountain View	Hamilton Electro Sales, 340 E. Middlefield Road (415) 961-7000
	Redwood City	Cramer Electronics, 695 Veterans Blvd. (415) 365-4000
	San Diego	Hamilton Electro Sales, 5567 Kearny Villa Road (714) 279-2421
	San Diego	R & C Cramer Electronics, 7969 Engineer Road (714) 279-6300
COLORADO	Denver	Hamilton Electro Sales, 1400 West 46th Avenue (303) 433-8551
	Englewood	Hyer-Cramer Electronics, 7895 E. Prentice Avenue (303) 771-5285
CONNECTICUT	North Haven	Cramer Electronics, 35 Dodge Avenue, Wharton Brook Industrial Center (203) 239-5641
FLORIDA	Ft. Lauderdale	Cramer Electronics, 4141 N. E. 6th Avenue (305) 566-7511
	Orlando	Hamilton Electro Sales, 419 27th Street (305) 241-5461
GEORGIA	Atlanta	Cramer Electronics, 3130 Marjan Drive (404) 451-5421
ILLINOIS	Addison	Hamilton Electro Sales, 920 S. Westwood Avenue (312) 543-8594
MARYLAND	Baltimore	Cramer Baltimore Inc., 922-24 Patapsco Avenue (301) 354-0100
	Baltimore	Hamilton Electro Sales, 8809 Satyr Hill Road (301) 668-4900
	College Park	Hamilton Electro Sales, 4915 Niagara Road (301) 935-5600
	Rockville	Cramer Electronics, 692 Lofstrand Lane (301) 424-2700
MASSACHUSETTS	Newton	Cramer Electronics, 320 Needham Street (617) 969-7700
MINNESOTA	Bloomington	Cramer Electronics, 8053 Bloomington Freeway, Suite 105 (612) 881-8678
MISSOURI	Hazelwood	Hamilton Electro Sales, 400 Brookes Lane (314) 731-1144
NEW JERSEY	Cedar Grove	Hamilton Electro Sales, 220 Little Falls Road (201) 239-0800
	Cherry Hill	Hamilton Electro Sales, 1608 Marlton Pike (609) 662-9337
	Pennsauken	Cramer Electronics, 7300 Route 130 North, Industrial Center, Bldg. 2 (609) 662-5061
NEW MEXICO	Albuquerque	Hyer-Cramer Electronics, 130 Alvarado, N. E. (505) 265-5767
NEW YORK	Elmhurst	Cramer Electronics, 96-10 23rd Avenue (212) 479-1380
	Rochester	Cramer Eastern Inc., 3259 Winton Road South (716) 275-0300
	Syracuse	Cramer Eastern Inc., Pickard Blvd., E. Molloy Road (315) 455-6641
	Syracuse	Hamilton Electro Sales, 222 Boss Road (315) 437-2641
NO. CAROLINA	Greensboro	Hamilton Electro Sales, 1023 E. Wendover Avenue (919) 275-9969
	Raleigh	Cramer Electronics, 3331 North Blvd. (919) 832-6441
OHIO	Cincinnati	Cramer Electronics, 666 Redna Terrace (513) 771-6441
TEXAS	Dallas	Hamilton Electro Sales, 2344 Irving Blvd. (214) 638-0900
	Houston	Hamilton Electro Sales, 1216 West Clay (713) 526-4661
UTAH	Salt Lake City	Hyer-Cramer Electronics, 1425 S. 2nd West (801) 487-3681
WASHINGTON	Seattle	Hamilton Electro of the Pacific Northwest, 2320 Sixth Avenue (206) 624-5930
CANADA	Toronto, Ontario	Cramer Electronics, 3077 Bathurst Street (416) 789-1937



INTEL CORPORATION, 365 Middlefield Road, Mountain View, California 94040/(415) 969-1670/Telex INTEL 34-8366
Regional Offices: 1741 Pitcairn, Costa Mesa, California 92626/(714) 545-8541
P.O. Box 206, Andover, Massachusetts 01810/(617) 536-0700

INFORMATION RETRIEVAL NUMBER 32

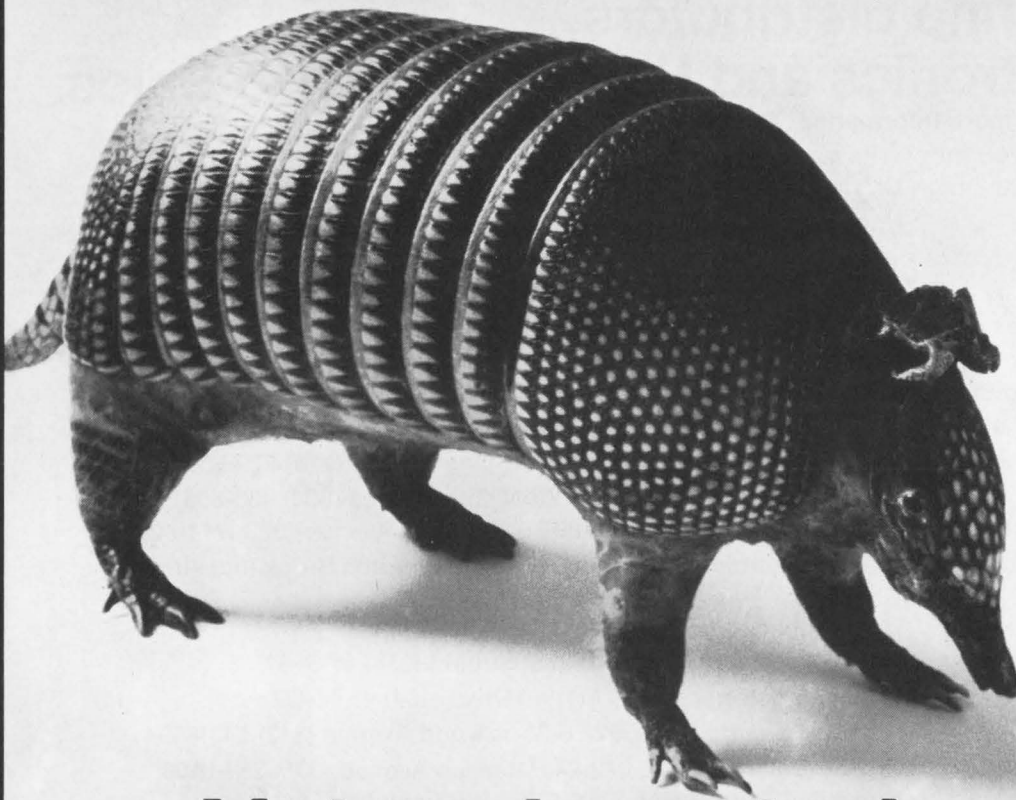

**Nature invented
hard-shell protection.**

We swiped it.



The Armadillo Connector is here. We take a connector design that's already foolproof, and make sure it'll stay that way. By wrapping a coat of stainless steel armor around it to protect it from all abuse in the field.

It's complete protection. For our new D Series connectors that deserve it. For example, they have the Hughes exclusive PolarHex center jackscrew coupling system.

This means polarization every time. Perfect alignment. Easy mat-

ing and unmating.

These connectors are fully environmental, too. They come in five shell sizes, with 18 to 138 contacts. They have the famous Hughes crimp snap-in contacts and retention mechanism. And you can use our new Pull-Thru insertion tool with them for faster wiring.

Now the most advanced of all rectangulars come in the most advanced packages. (For example, the shells are mechanically keyed to

prevent mismatching.)

Another Hughes innovation.

With armadillos, hard-shell protection is very old. But with connectors, it's very new.

Write Hughes Aircraft Company,  Connecting Devices, 500 Superior Avenue, Newport Beach, California 92663. Phone (714) 548-0671. TWX 714-642-1353.

HUGHES

HUGHES AIRCRAFT COMPANY

**If it's happening in connectors,
it probably started at Hughes.**

Technology

CAREER REFLECTIONS

Managers reflect on their careers four weeks after taking a sensitivity training course

that's designed to make the 'graduates' more effective on the job. p. 98.

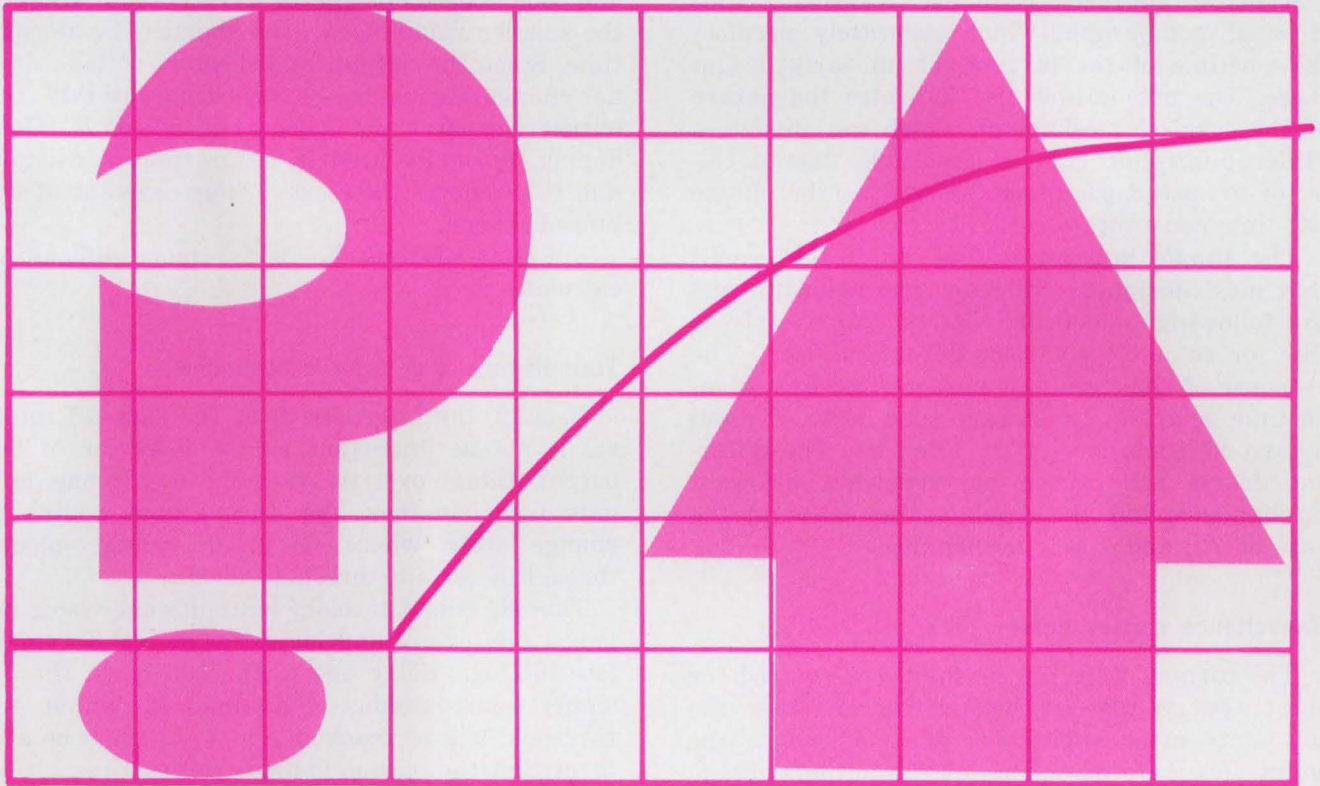

Inverter risetime is determined quickly, whether limited by simple RC time constants

or feedback effect, with a nomograph that also predicts the turnoff mechanism. p. 74

Also in this section:

Used pulse LEDs in sensing and improve signal-to-noise ratio. p. 84.

Design attenuator pads the easy way, with this BASIC computer program. p. 90.

ELECTRONICS DESIGN semiannual index of articles. p. 104.

Ideas for Design. p. 112.

Determine inverter risetime quickly

with a handy nomograph that also predicts the turn-off mechanism.

The inverter is one of the most important circuits in any digital system, and its design has been given a great deal of attention. But predicting inverter risetime analytically is still difficult because of the cumbersome mathematical expressions involved. The circuit designer, in frustration, usually resorts to direct measurements on a breadboard prototype.

A better approach is to use a specially constructed nomograph, which accurately predicts the risetime of the inverter at an early design stage. The nomograph also indicates the nature of the turn-off mechanism, which can involve a Miller multiplier type of feedback, due to collector-to-base capacitance, as well as the simple RC time constant.

The simple inverter of Fig. 1a is the circuit that most designers will be concerned with, and the following nomograph design applies only to this, or to a closely related configuration. The response of the circuit is characterized by a turn-on time delay, T_{on} ; a storage time delay, T_s ; and a turn-off time delay, T_{off} , (Fig. 2). The different delays are caused by somewhat different mechanisms, but the fundamental cause in the case of T_{on} and T_{off} is capacitance.

Capacitance causes delay

The turn-on time, T_{on} , is the time required for the output voltage of the inverter to fall to the low state after application of a logic 1 to the input. The rate of change of the output voltage during turn-on is directly proportional to both the forward base drive, I_{b1} , and the current gain of the inverter transistor, and it is inversely proportional to the collector load-capacitance, C_L , and the collector-to-base feedback capacitance, C_{ob} (Fig. 3). The fall of output voltage over turn-on time T_{on} is in most cases fairly linear with time.

Generally, T_{on} can be calculated with straight forward techniques if the characteristics of the

transistor are known; it is normally much less than T_{off} .

Storage time T_s is a phenomenon that occurs if the inverter transistor is allowed to saturate. Charge is stored within the transistor, and when the input pulse drops to 0 level, this charge sustains conduction for a short time. The storage time is a function of turn-off base current I_{b2} , and thus depends on the value of resistor R_{be} , for the smaller value of R_{be} , the shorter the storage time. Since the output, or collector, voltage does not change during the storage time interval, the output capacitance C_L does not affect T_s . Gold doping, normally used in saturating transistors and ICs, reduces the storage time constant of the stored charge.

But turn-off time T_{off} is far more difficult to calculate.

Turn-off time: a designer's headache

Usually, the total length of the turn-off interval is not as important as the behavior of the output voltage over the turnoff time. If one logic gate feeds another, the second gate begins to change state when its input voltage passes through a certain threshold level.

This threshold level is located somewhere between the logic 0 and logic 1 voltages. To calculate the logic delay due to turn-off time, the designer must predict the time at which the threshold will be reached, and so he must be able to predict the output voltage versus time.

The turn-off mechanism is quite simple (Fig. 3). Forward base drive I_{b1} is removed, leaving the base grounded through emitter resistor R_{be} . After a possible delay due to stored charge effects, the collector voltage, or output voltage, begins to rise toward V_{cc} .

Two situations are possible during this interval:

1. The feedback current, I_{fb} , flowing through the collector-base capacitance C_{ob} , flows to ground through resistor R_{be} and produces a bias voltage across the resistor that is less than the emitter-base turn-on potential. This is called the unlimited case; turn-off speed is limited by RC time con-

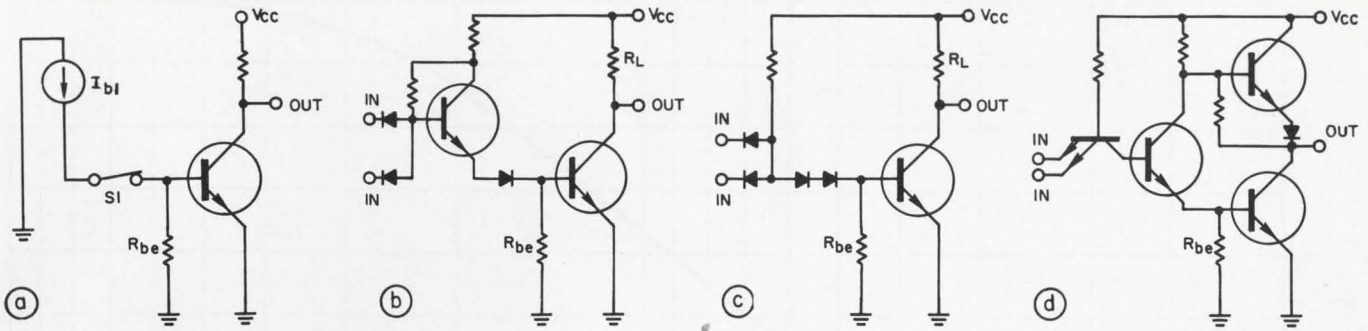

1. A simple inverter circuit (a) is used repeatedly in DTL (b and c) and TTL (d) saturating logic, in both

simple gates and complex functions. The turn-off time is limited by charge storage and parasitic capacitance.

starts, but not by transistor action.

2. The feedback current, flowing through C_{ob} and R_{be} , produces a voltage large enough to bias the emitter-base junction in the forward direction and turn on the transistor (into its active region). This is called the limited case; the transistor amplification of I_{fb} limits turn-off speed.

Determine the boundary region

In the unlimited case, the transistor is not conducting and the output voltage response is easily calculated. The bias on resistor R_{be} is less than the emitter-base turn-on voltage, and we may safely assume that the base-voltage is zero and the collector voltage versus time curve assumes the form of the well known RC network (with C being the parallel combination of C_L and C_{ob}).

Then

$$V_{out} = V_{cc} [1 - \exp(-t/RL(C_{ob} + C_L))]. \quad (1)$$

A normalized plot of this expression is shown in Fig. 4. It is an aid to calculation and will be used later.

If Eq. 1 is differentiated, we obtain an expression for the C_{ob} limited case:

$$dV_{out}/dt = V_{cc} \exp(-t/RL(C_{ob} + C_L)) / RL(C_{ob} + C_L)$$

$$dV_{out}/dt = (V_{cc} - V_{out}) / RL(C_{ob} + C_L). \quad (2)$$

Referring to Fig. 3a, we know from circuit theory that $I_{fb} = C_{ob} (dV_{out}/dt)$. The boundary condition for the unlimited case is

$$I_{fb} R_{be} < V_{be_{on}}$$

and since $I_{fb} = C_{ob} (dV_{out}/dt)$ we can put the boundary condition as

$$[(V_{cc} - V_{out}) / RL(C_{ob} + C_L)] C_{ob} R_{be} < V_{be_{on}}$$

Rearranging terms, we get

$$(V_{cc} - V_{out}) [(C_{ob} / (C_{ob} + C_L))] (R_{be} / RL) < V_{be_{on}} \quad (3)$$

and this expression is used as the basis for the nomograph.

The transistor model of Fig. 3b is used to solve for turn-off time in the C_{ob} limited domain. Although it is a simple model, it has proved to be accurate. Its use is based on several critical assumptions, however:

1. The transistor current gain, β , is constant

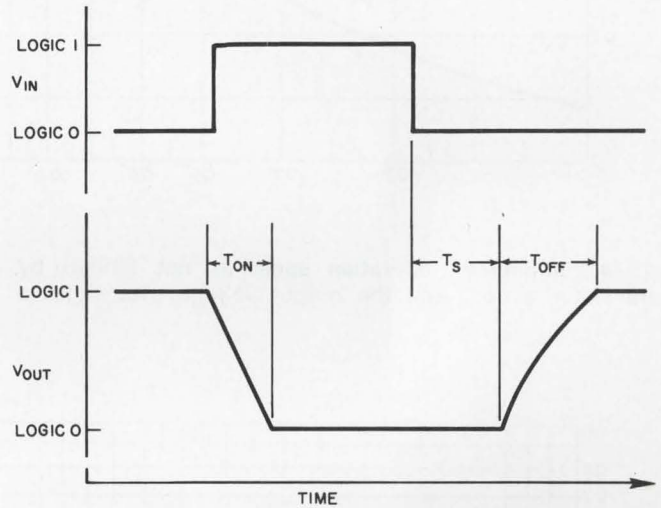

2. The response of an inverter to an input pulse has three distinct areas of interest. In changing from a 1 to a 0 state, the inverter exhibits a "fall-time" effect called the "turn-on" time, T_{on} . When the output pulse returns to logic 0 the inverter output remains in the on state for an interval that is designated the "storage time," T_s ; it then changes to the off state over an interval called the "turn-off" time, T_{off} .

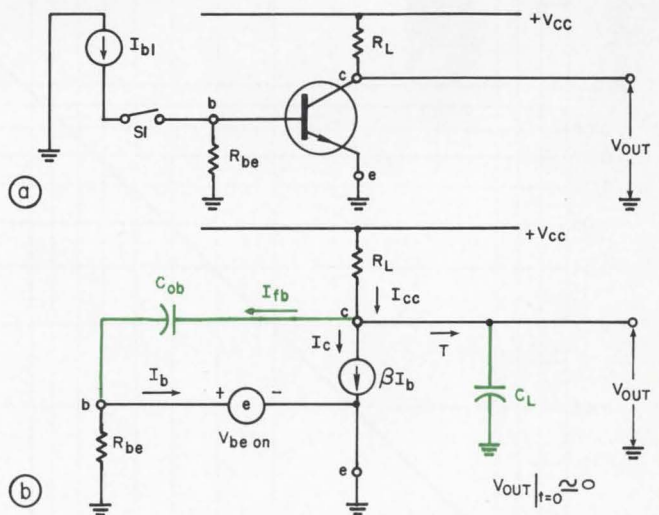

3. The equivalent circuit for the transistor inverter includes the collector-to-base feedback capacitance C_{ob} and the collector load capacitance C_L , which limit the rate of change of output voltage during turn-on.

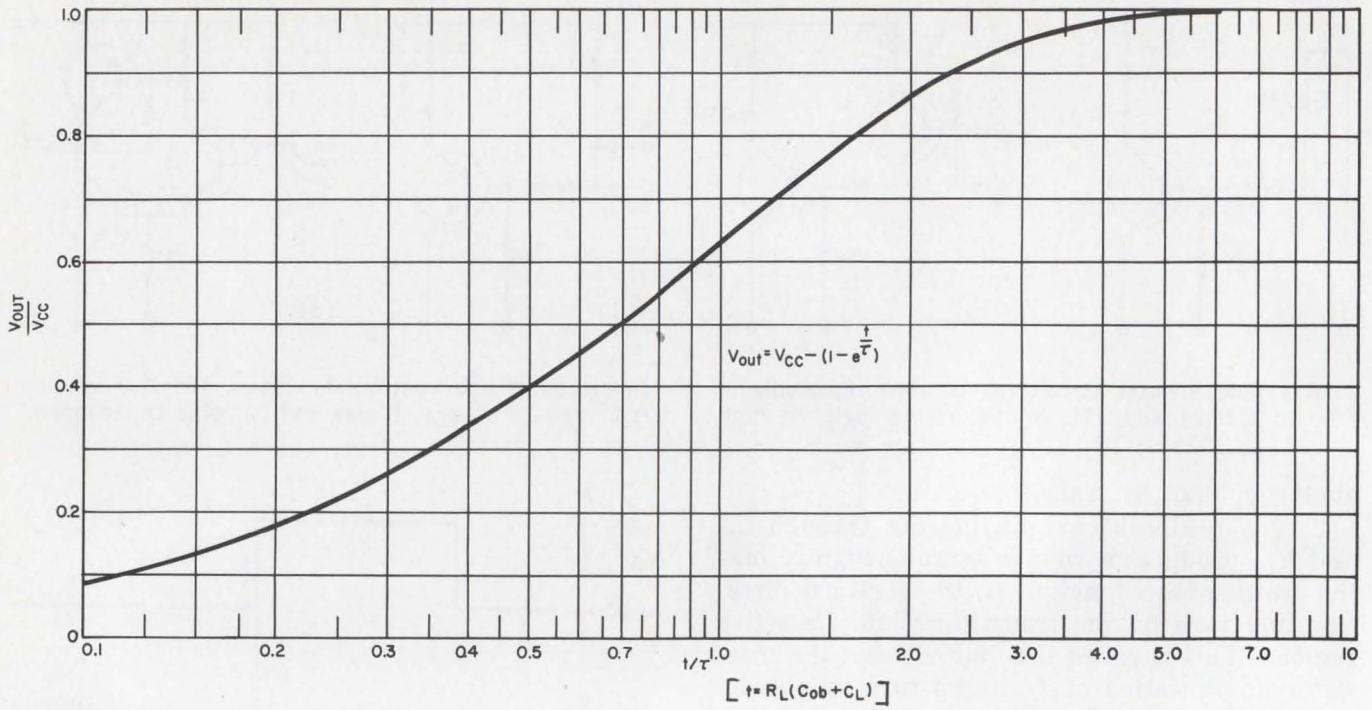

4. In "unlimited" operation speed is not limited by transistor action, and the output voltage over time, a

simple RC network response, can be accurately calculated. The curve provides a quick solution.

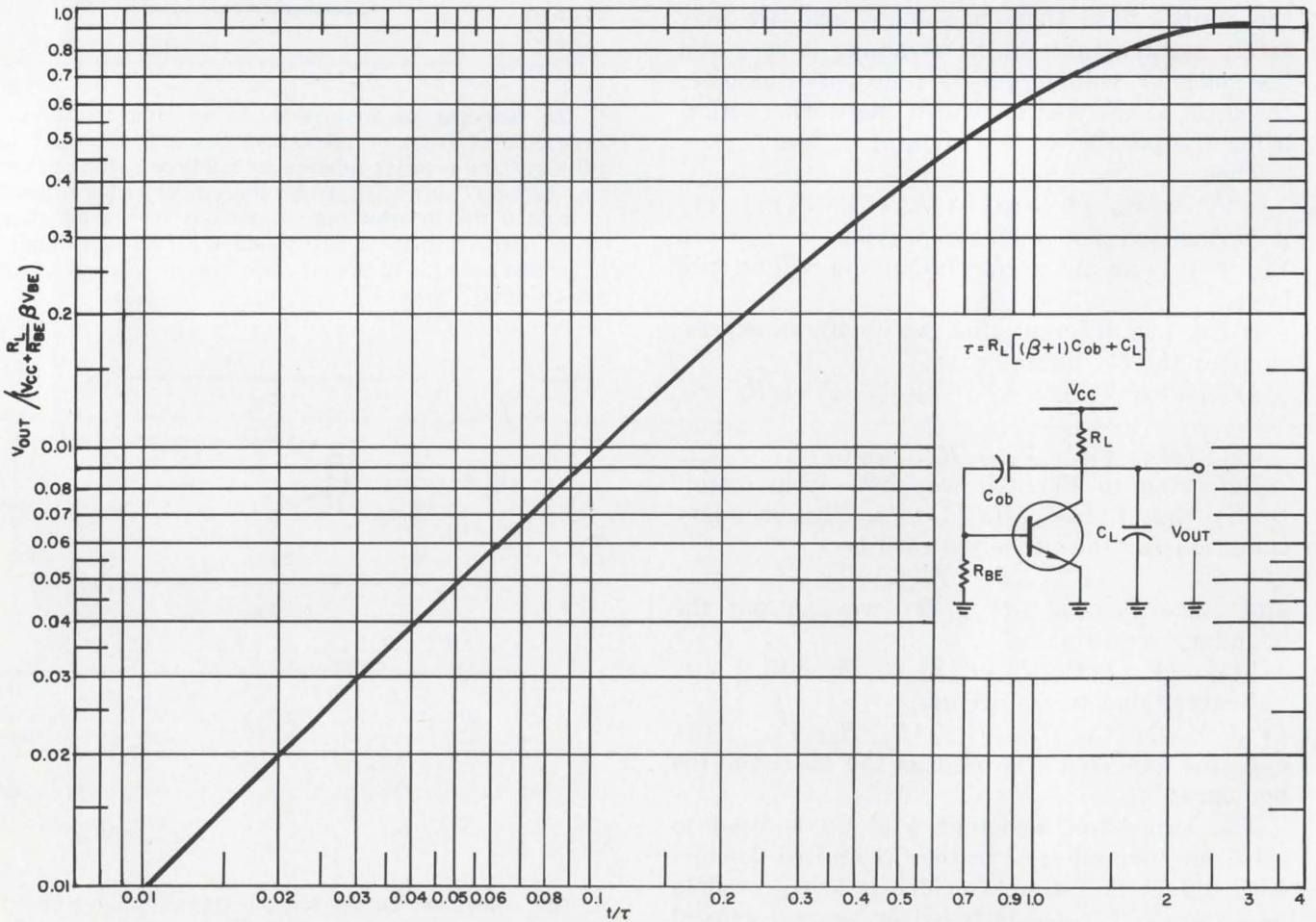

5. In "limited" operation the feedback through the collector-to-base capacitance C_{ob} has a controlling effect on

inverter speed. The final output voltage value is increased, and the speed of the circuit slowed considerably.

over the operating range. This is a valid assumption since, from the expression we obtained for the transistor response, the response is not a strong function of β for β greater than 20.

2. The base-emitter forward voltage drop, V_{be} , is a constant. This assumption is valid since the magnitude of emitter current never varies greatly on an absolute scale.

3. Emitter-base capacitance is not critical, and does not enter into the expression for transient response. This fact is self-explanatory from assumption 2.

We now derive the expression for risetime in the C_{ob} limited case. Referring to Fig. 3b, we know that:

$$I_{cc} = (V_{cc} - V_{out}) / R_L,$$

$$I_{LOAD} = C_L (dV_{out}/dt),$$

$$I_{fb} = C_{ob} (dV_{out}/dt),$$

$$I_C = \beta I_b,$$

and

$$I_b = I_{fb} - (V_{be_{on}}/R_{be}).$$

Summing the currents at the collector of the transistor, we have: $I_{cc} = I_{LOAD} + I_{fb} + I_C$.

Replacing these currents with their equivalent time-dependent expressions yields

$$(V_{cc} - V_{out}) / R_L = C_{ob} (dV_{out}/dt) + \beta [(C_{ob} (dV_{out}/dt) - V_{be_{on}}/R_{be})] + C_L (dV_{out}/dt),$$

and by rearrangement of terms we obtain

$$[V_{cc} + (R_L/R_{be})\beta V_{be_{on}} - V_{out}] / R_L = (dV_{out}/dt) [(\beta + 1)C_{ob} + C_L]$$

This is the classical first-order differential equation with the following solution:

$$V_{out} = [V_{cc} + (R_L/R_{be})\beta V_{be_{on}}] [1 - (\exp -t/R_L((\beta + 1)C_{ob} + C_L))] \quad (4)$$

By comparing Eq. 4, (the risetime in the C_{ob} limited case) with Eq. 1 (the unlimited case), we can see the effect of the feedback current on the time response. First, the final value to which the output voltage rises is now increased from V_{cc} by the amount $(R_L/R_{be}) V_{be_{on}}$. Second, the time constant has increased significantly, from $R_L(C_{ob} + C_L)$ to $R_L[(\beta + 1)C_{ob} + C_L]$.

The net result is a slower risetime in the C_{ob} limited case. With C_{ob} multiplied by $(\beta + 1)$ in the time-constant expression the load capacity C_L has little effect on the response.

Although the expression for the risetime shows a final value greater than V_{cc} , we know the output voltage cannot physically exceed V_{cc} . It turns out that the total transient time in the C_{ob} limited case is less than one time constant. A normalized plot of Eq. 4 is shown in Fig. 5, for low values of t/τ . This plot permits quick solution to the C_{ob} limited risetime computation.

Use the nomograph for fast solutions

All the preceding work is of little value unless we have some quick and easy means of determin-

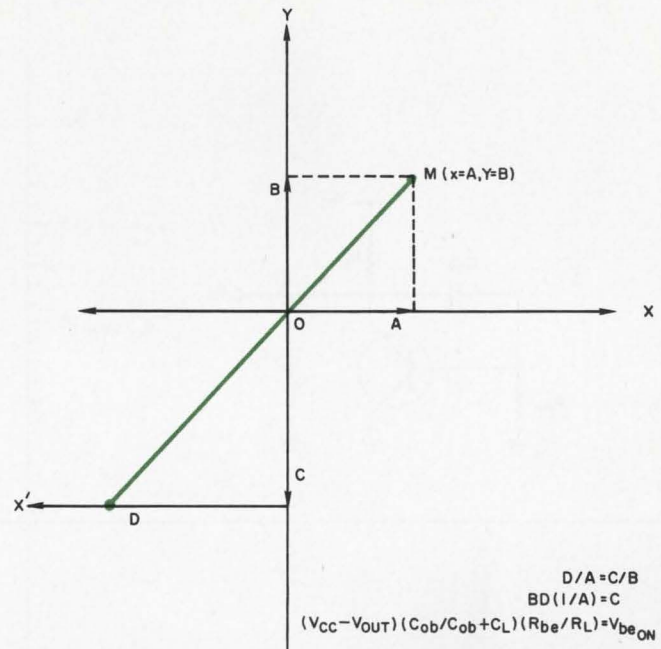

6. The graphical basis for the nomograph is a pair of similar triangles. The simple relationship $BD(1/A) = C$ is equivalent in form to Eq. 3, as shown.

ing which expression for turn-off or risetime is valid for a given set of circuit values. As a matter of fact, several circuit component values give a risetime that is C_{ob} limited in the first part of the response and then becomes the unlimited case for the remainder. A method of determining at what point this occurs is mandatory for a complete and accurate description of the output voltage with time.

A simple geometrical explanation of the nomograph is shown in Fig. 6. A line drawn from any point M in the first quadrant of the plane through the origin and intersecting the X' axis produces a pair of similar triangles. The following expression holds true for all points M :

$$D/A = C/B.$$

Rewriting the expression as

$$DB(1/A) = C,$$

we have an equation identical in form to Eq. 3.

If we define the length B as $(V_{cc} - V_{out})$ and $1/A$ as R_{be}/R_L , or A as R_L/R_{be} , the first quadrant of the plane becomes a field of all possible values of V_{cc} , V_{out} and R_L/R_{be} . If we now scale the distance C so that

$$C \propto V_{be_{on}},$$

and likewise make

$$D \propto C_{ob}/(C_{ob} + C_L),$$

we have a nomograph that solves Eq. 3.

Figure 7 is the final version of the nomograph. Three sets of the X' axis are given, corresponding to $V_{be_{on}} = 0.7$ volt @ $25^\circ C$, $V_{be_{on}} = 0.5$ volt @ $+125^\circ C$, and $V_{be_{on}} = 0.86$ volt @ $-55^\circ C$. The X' axis itself is graduated in the term C_{ob}/C_L , rather than $C_{ob}/(C_{ob} + C_L)$, since it is a bit easier to use this way.

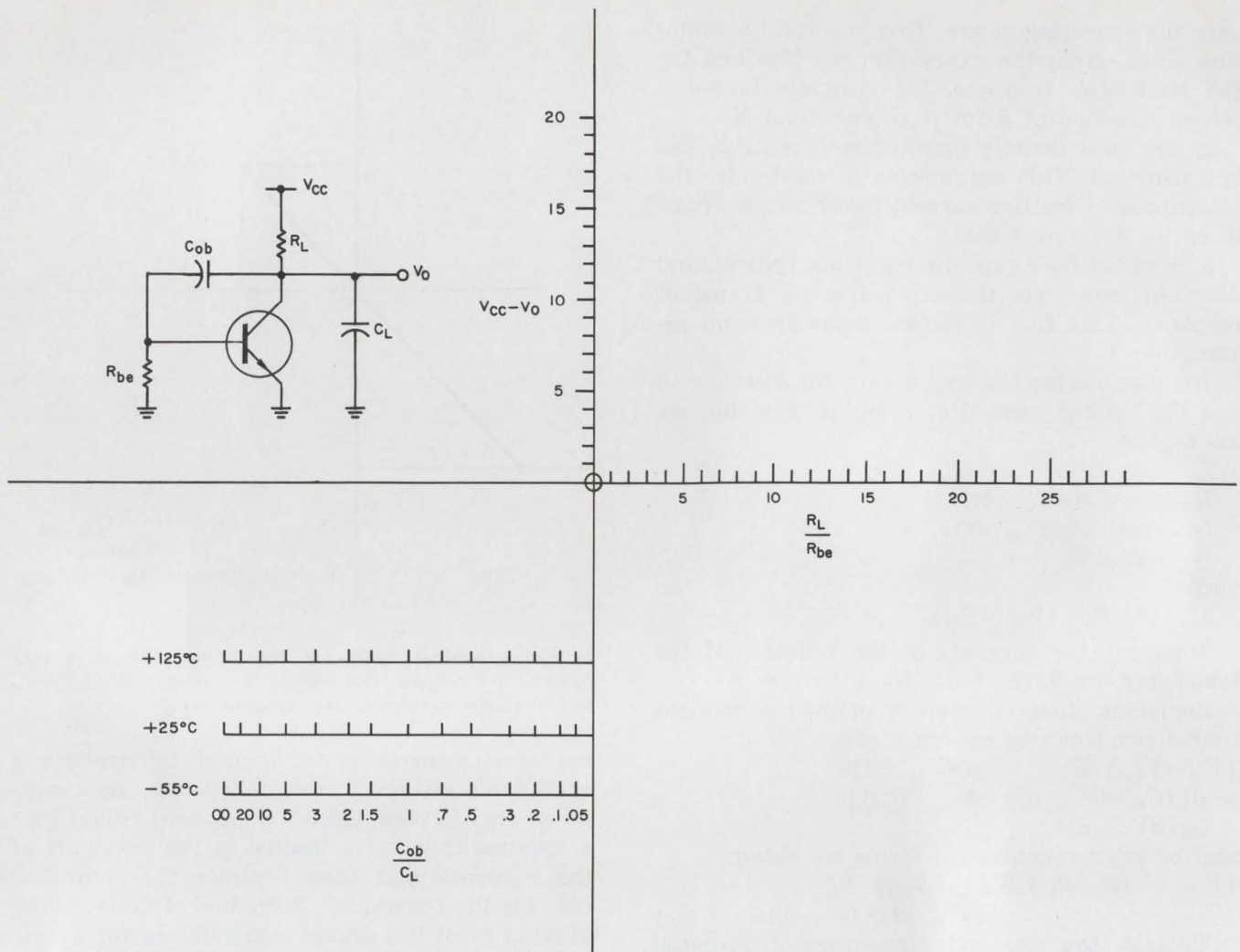

7. The risetime nomograph provides convenient, quick and accurate solutions for inverter risetime, and can

There are several different problems for which the nomograph, used in conjunction with Figs. 4 and 5, provides easy solutions. These can best be illustrated by means of examples:

Problem 1: Calculate the 0% to 90% risetime, at 25°C, of an inverter using a 2N2369 transistor with a measured h_{FE} of 43 and $C_{ob} = 5$ pF, $R_L = 1$ k, $R_{be} = 2$ k, $V_{cc} = 10$ V and $C_L = 5$ pF.

Solution: As shown in Fig. 8a, we draw a line from $C_{ob}/C_L = 1$ through the origin. This gives the boundary condition that separates C_{ob} limited risetime domain (above line) from unlimited risetime domain (below the line).

Since the ratio of R_L/R_{be} is fixed, and not a function of time or voltage, all operation must be on the vertical line at $R_L/R_{be} = 0.5$. The risetime begins at point A, with V_{out} equal to zero and $(V_{cc} - V_{out}) = +10$. The 90% value occurs when $(V_{cc} - V_{out}) = 1$ V at point B. Operation is along the line AB and is entirely in the C_{ob} limited domain. Using Fig. 5, we find the value of the expression $V_{out}/V_{cc} + (R_L/R_{be})\beta V_{be_{on}}$, namely 0.36 when V_{out} is 9 volts. From Fig. 5 this yields a value of t/τ of 0.44. τ is easily calculated as

solve for active pull-up, or totem-pole, risetimes as well.

225 nanoseconds, and hence the total risetime is $(0.44)(225 \text{ ns})$ or 99 nanoseconds.

The scope trace in Fig. 8b shows the actual risetime in the completed circuit to be 95 nanoseconds. The voltage response is markedly linear, as opposed to exponential. The waveform is actually exponential, but for only 0.44 of one time constant.

Problem 2: (1) Calculate the 0% to 90% risetime, at 25°C, for a transistor inverter using a 2N4141 transistor with an h_{FE} of 150 and $C_{ob} = 10$ pF, $R_L = 5$ k, $R_{be} = 1$ k, and $C_L = 20$ pF. (2) Calculate the rise time for $V_{cc} = +10$ and $V_{cc} = +20$ V.

Solution: As shown in Fig. 9a, we can draw a line from point X on the 25°C C_{ob}/C_L axis through the origin. This line defines the boundary between C_{ob} limited risetime and unlimited risetime.

For part (1), the 0% to 90% transition begins at point A and ends at point C. All operation is in the unlimited risetime domain. This gives the conventional exponential risetime with a time constant of $R_L(C_{ob} + C_L)$. Referring back to

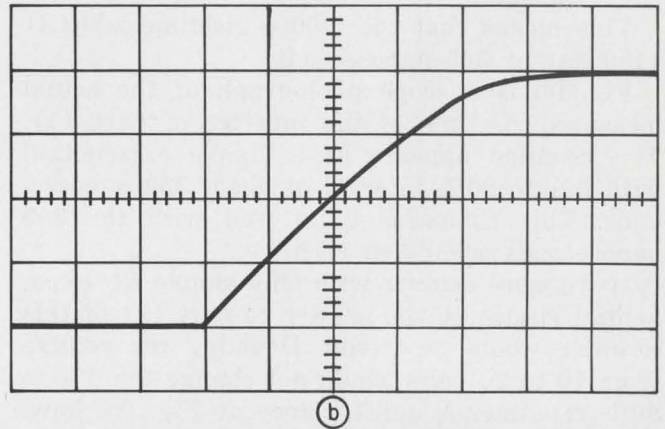
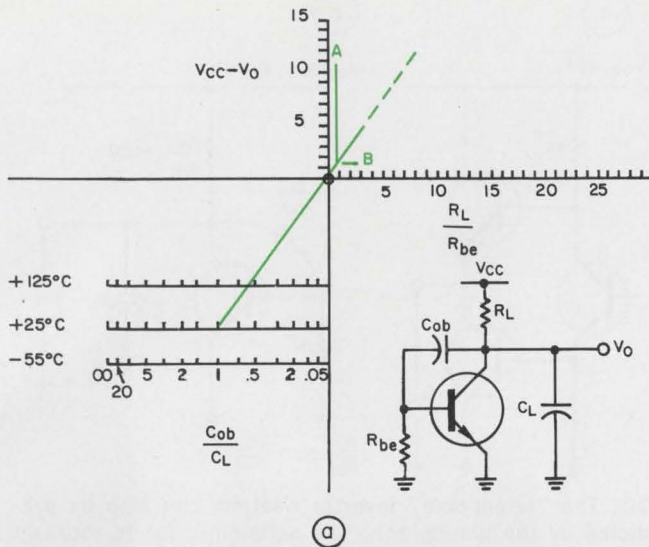

8. The boundary condition separating "limited" from "unlimited" operation is defined by a line drawn from C_{ob}/C_L to the origin (a). Above this line the speed is limited by feedback through C_{ob} ; below the line speed is not limited by this effect. All operation in this sample takes place along the line $R_L/R_{be} = 0.5$, since this resistance ratio is fixed. The actual circuit performance (b) is almost exactly as indicated by the nomograph.

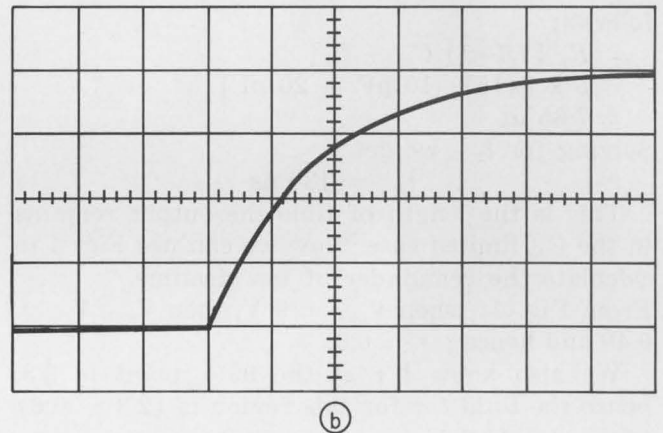
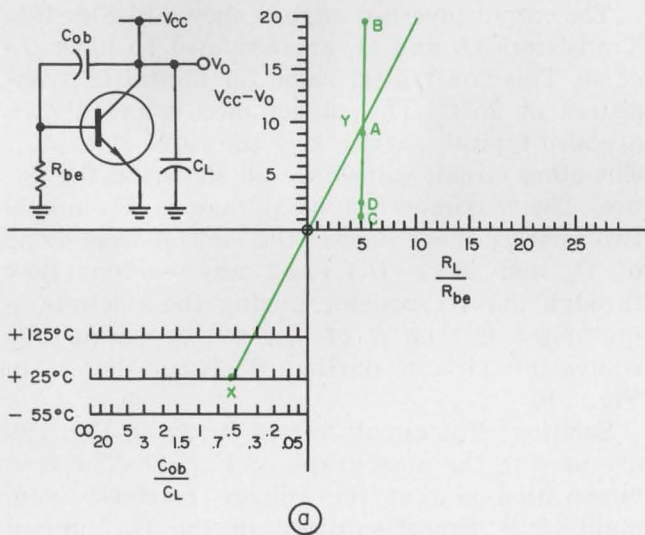

9. Inverter operation is completely within the "unlimited" risetime domain for $V_{cc} = 10$ V, which occurs on the line AC. For $V_{cc} = +20$ V, however, operation is from point B to point D, and the total risetime is the sum of two intervals, calculated separately for the two domains (a). The performance of the inverter for the two cases, (b) and (c), is almost exactly as predicted.

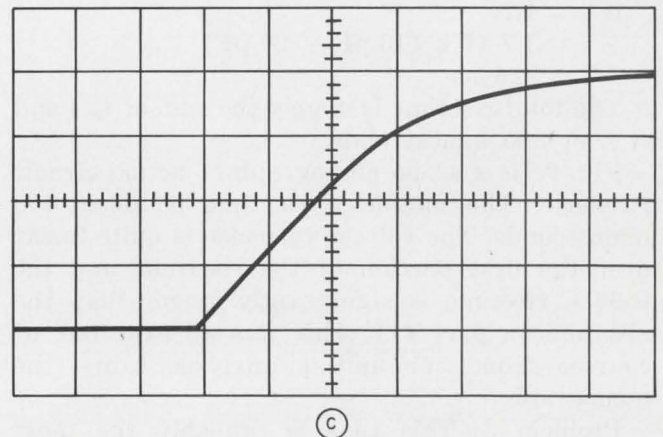

Fig. 3, at 0% to 90% transition takes 2.3τ seconds. The time constant is easily calculated as:

$$\begin{aligned}\tau &= R_L (C_{ob} + C_L) \\ &= 5 \text{ k} (10 \text{ pF} + 20 \text{ pF}) \\ &= 150 \text{ ns}\end{aligned}$$

This means that the 0-90% risetime is (2.3) (150 ns) or 345 nanoseconds.

Fig. 9b is a scope photograph of the actual measured risetime of the inverter of part (1). The risetime appears as a simple exponential with 0% to 90% interval of about 350 nanoseconds. This compares quite well with the 345 nanoseconds calculated risetime.

If we were dealing with only simple RC exponential risetimes, the answer to part (2) of this example would be trivial. Doubling the voltage from 10 to 20 volts would not change the 0% to 90% risetime. A quick glance at Fig. 9a, however, shows that operation at a V_{cc} of 20 V leads to nearly half the output swing occurring in the C_{ob} limited area of operation.

In Fig. 9a, the operation for (2) is from point B to point D. This is broken up into two sections. Operation from B to point Y lies in the C_{ob} limited domain, and that from point Y to D in the unlimited domain.

We see that V_{out} at point Y is 9 volts. Using Fig. 5, we first calculate $V_{out}/[V_{cc} + (R_L/R_{be})V_{be_{on}}] = 0.0165$. This, in turn, gives us a $t_{B-Y} = 0.017\tau$

The τ for the C_{ob} limited case is calculated as follows:

$$\begin{aligned}&= R_L [(\beta+1) C_{ob} + C_L] \\ &= 5 \text{ k} [(151) 10 \text{ pF} + 20 \text{ pF}] \\ &= 7.65 \mu\text{s}\end{aligned}$$

Solving for t_{B-Y} we get:

$$t_{B-Y} = 130 \text{ ns}$$

This is the length of time the output remains in the C_{ob} limited case. Now we can use Fig. 4 to calculate the remainder of the risetime.

From Fig. 4: when $V_{out} = 9 \text{ V}$, then $V_{out}/V_{cc} = 0.45$ and hence $t/\tau = 0.6$.

We also know t/τ at the 90% point is 2.3, hence the total t/τ for this region is $(2.3 - 0.6) t/\tau = 1.7 t/\tau$.

Solving for the remaining time,

$$\begin{aligned}t_{Y-D} &= 1.7\tau \\ &= 1.7 (5 \text{ k} (10 \text{ pF} + 20 \text{ pF})) \\ &= 225 \text{ ns}\end{aligned}$$

The total risetime is simply the sum of t_{B-Y} and t_{Y-D} , or 385 nanoseconds.

Fig. 9c is a scope photograph of actual circuit response. The measured risetime is about 400 nanoseconds. The voltage response is quite linear over the first portion of the risetime, and the 0-90% risetime is significantly longer than the risetime on part (1). This was all expected, of course, from our initial analysis using the nomograph.

Problem 3: This case is probably the most

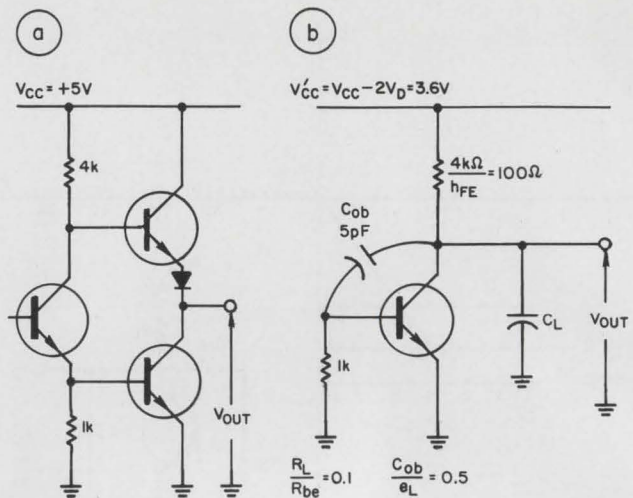

10. The "totem-pole" inverter risetime can also be predicted by the nomograph. The schematic (a) is redrawn (b) with an equivalent load resistor replacing the active load. The nomograph is then used as previously, but in this case operation, from point A to the origin, is confined almost exclusively to the "limited" domain. Also, the measured responses of the circuit, for 10-pF and 20-pF load capacities, are within 15% of the nomograph values.

interesting to the IC designer, in that it shows how to deal with the active pull-up or "totem-pole" output so popular in high-speed saturating digital circuits. Some interesting results are obtained, which have significant bearing on LSI and complex chip design.

The output inverter stage is shown in Fig. 10a. Transistors Q_1 and Q_2 are assumed to have β 's of 40. This is a typical value for digital IC transistors at 25°C. The capacitance values shown are also typical, particularly the ratio of C_{ob}/C_L . The other circuit values are all shown in the figure. The maximum output voltage is V_{cc} minus two forward diode drops (the emitter-base diode of Q_2 and diode D_1), and any current flow through the 4-k resistor during the risetime is multiplied by the β of Q_2 , so we obtain the equivalent circuit during risetime shown in Fig. 10b.

Solution: The circuit values shown in Fig. 10b are used in the nomograph of Fig. 11. The first observation is that the voltage response from point A is almost entirely in the C_{ob} limited domain. As a matter of fact, if the load capacitance were doubled to 20 pF this would still be true. The dashed line for $C_{ob}/C_L = 0.25$ is shown to verify this.

Referring back to Fig. 5, again we calculate the 0 to 90% risetime.

At 90% we have:

$$\begin{aligned}V_{out}/[V_{cc} + (R_L/R_{be})\beta V_{be_{on}}] \\ &= (0.9 (3.6) / (3.6 + (0.1) (40) (0.7))) \\ &= 0.492\end{aligned}$$

This gives a normalized time of $t/\tau = 0.68$, and solving for τ we obtain

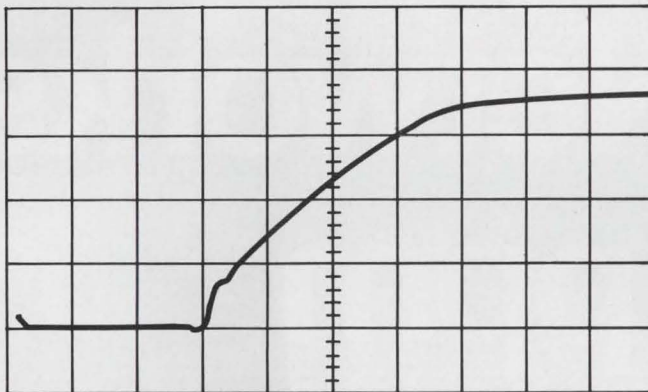
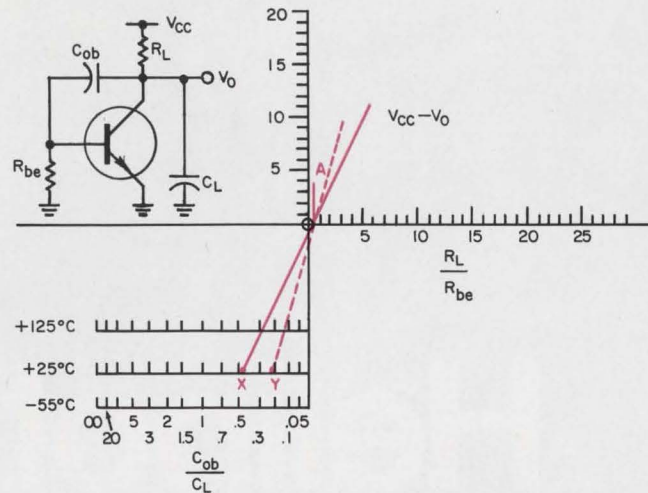

(b)

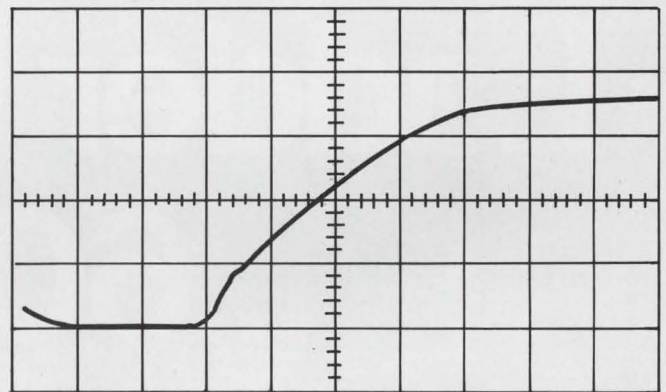

(c)

11. The totem-pole voltage response lies almost entirely within the C_{ob} -limited domain (a), even if the load capacitance is doubled to 20 pF, as shown by the dashed line corresponding to $C_{ob}/C_L = 0.25$. The responses of actual circuits, (b) and (c), again fall within 15% of the nomograph prediction.

$$\begin{aligned}\tau &= R_L [\beta + 1] C_{ob} + C_L \\ &= 0.1 \text{ k} [(41) 5 \text{ pF} + 10 \text{ pF}] \\ &= 21.5 \text{ ns}\end{aligned}$$

Notice, from the expression for τ , that because of the β multiplier on C_{ob} the load capacity C_L has little effect on τ . In fact, if the load capacity is doubled to 20 pF the time constant becomes only 22.5 nanoseconds.

Solving now for the 0 to 90% risetime we have, first for a load of 10 pF:

$$t = 0.68\tau = 0.68 (21.5 \text{ ns})$$

$$t = 14.6 \text{ ns}$$

and if the load capacity were doubled

$$t = 0.68 = 0.68 (22.5 \text{ ns})$$

$$t = 15.3 \text{ ns}$$

Figures 11b and 11c show scope photographs of the actual circuit response. The measured risetimes are about 17 nanoseconds. The load capacitance, of course, has an almost negligible effect. ■■

Acknowledgment:

The basic nomograph design work was done at National Semiconductor Corp., Sunnyvale, Calif.

Test your retention

Here are questions based on the main points of this article. Their purpose is to help you make sure you have not overlooked any important ideas. You'll find the answers in the article.

1. There are two distinctly different domains in the operation of a simple transistor inverter. What are they?

2. What are the two most important capacitances with regard to their effect on inverter speed?

3. The transient response of an inverter stage is characterized by three different delay times. What are they?

4. Which is the hardest delay time to calculate, and why?



**Helipot
Ladder Networks
...60 ppm
accuracy for \$27.00
from stock***

* Model 811-A12, 100 piece price.

Helipot offers the widest variety of off-the-shelf miniature ladder networks. From low cost networks with 9-bit accuracies to precision 14-bit units. Either binary or BCD designs. And with a variety of stock resistance values and a selection of standard temperature ranges.

They typically feature:

- 60 ppm accuracy (initial worst case accuracy at 25°C)
- 0.6 ppm/°C tempco
- 50 nanosecond settling
- 20 ppm per year stability
- low profile

They are constructed of Helipot's exclusive cermet thick film passive elements and fused to alumina substrates at extremely high temperatures. By screen printing all resistors on each network simultaneously, uniform electrical characteristics and excellent stability are achieved. In addition, every unit is 100% tested at 5 temperature points and serialized accuracy tapes are available for only \$1.00 more.

For more information, contact your local Helipot Sales Representative or Distributor or circle the Reader Service No.

Beckman®

INSTRUMENTS, INC.

HELIPOT DIVISION

FULLERTON, CALIFORNIA • 92634

INTERNATIONAL SUBSIDIARIES: AMSTERDAM; CAPE TOWN; GENEVA; GLENROTHES, SCOTLAND; LONDON; MEXICO CITY; MUNICH; PARIS; STOCKHOLM; TOKYO; VIENNA

Model 811:
A 12-bit Binary Ladder Network for use in DAC/ADC applications requiring fast switching and high accuracy over a wide temperature range.

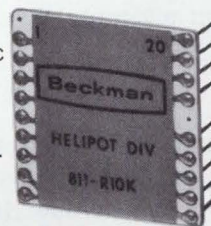

Model 812:
A 12-bit R-2R Binary Ladder Network designed specifically for MOSFET switch applications.

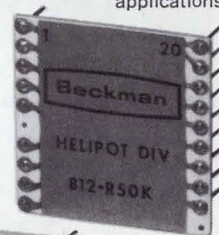

Model 813:
A Conductance Ladder designed to be used with Fairchild's μ A722 10-bit current source.

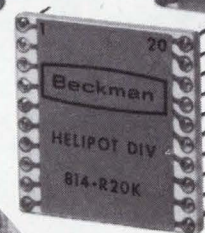
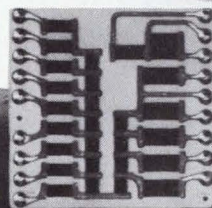

Model 814:
An Ultraprecision 14-bit R-2R Binary Ladder Network with accuracies to ± 30 ppm from -20° to $+80^\circ$ C.

BCD Ladder Networks are also available in many standard configurations.

INFORMATION RETRIEVAL NUMBER 34

It makes sense to use LEDs in sensing.

Pulsed light-emitting diodes improve signal-to-noise ratio and reduce average power requirements.

If you are using incandescent-lamp techniques for such applications as sensing punched holes in data cards, you may be having problems with signal-to-noise ratio or excessive heat dissipation. Your answer may very likely be a pulsed, solid-state light-emitting diode (LED) coupled with a silicon phototransistor. Thanks to the phenomenon of turn-on delay in the phototransistor and fast light output rise time of the LED, this combination has resulted in a typical improvement in S/N as a factor of seven, as well as significant savings in power requirements.

The LED-phototransistor combination can be used in a variety of position-measuring or hole-sensing applications, such as sensing the position of a document in transport, or to detect reflective coatings or slots on a timing disc.

LEDs are fast

LEDs can be made from such semiconductors as gallium arsenide (GaAs), silicon carbide (SiC), and gallium phosphide (GaP). Photon emission in a GaAs LED is achieved by recombination. As a result, the light output rises and falls very rapidly, typically less than 50 ns. Therefore, short pulses of diode current can give rise to equally short pulses of light in the infrared. The band gap energy of the devices is about 1.38 electron volts, and the forward biased voltage is 1.1 or 1.2 volts. Forward dc currents are typically limited to 50 to 100 mA because of power dissipation limitations; pulsed currents, on the other hand, can be significantly higher and can achieve greater light outputs.

Typical silicon phototransistors available today are two-terminal (collector-emitter) npn devices. The static, forward, common-emitter characteristics of these devices appear like those of a conventional transistor, with the exception that base current is replaced with incident light intensity or irradiance.

An approximation of the phototransistor is the equivalent circuit shown in Fig. 1. Transistor Q is assumed to be an ideal transistor—one that can be described with small signal parameters. C_{CB} and C_{BE} are junction capacitances. The diode is assumed to be an ideal, back-biased photodiode; that is, it generates a current (I) directly proportional to the incident irradiance (H). The collector (C) and emitter (E) terminals are the only accessible points.

Essentially, as a step function of irradiance impinges on the phototransistor, the photodiode generates a current that charges the capacitors. There is a delay until they forward-bias the base-emitter junction enough to permit some appreciable base current to flow. As collector current then starts to flow, the RC time constant causes the collector voltage to change exponentially to its final value. It is the delay between the incidence of the light pulse and the forward-biasing of the base-emitter junction that is of particular benefit in improving S/N.

Read punched cards with pulsed light

In electro-optical data card readers, a tungsten filament light source is most often used to illuminate the area of interest on the data card. On the side of the card opposite the light source, light-sensitive detectors, such as phototransistors, are positioned to collect the light energy that passes through punched holes as the card passes over them. The output signals of the phototransistors represent the presence or absence of punched holes. The reliability of this system depends heavily upon the ratio of the phototransistor output current for a punched hole to the no-punched hole current—or, as loosely defined in this application, the S/N.

In general, S/Ns vary in card readers depending upon the optical design. Since a manila-colored card can transmit 20% of the light incident on it, the S/N could conceivably be as low as 5/1. With more thoughtful design, S/Ns approaching 100/1 can be effectively realized—50/1 to 75/1 is not uncommon.

Normal D. Kline, Manager, Logic Applications, IBM Systems Development Division, Rochester, Minn.

To date, the most effective way of achieving high S/N has been to move the phototransistor back from the card. The phototransistor then subtends a smaller solid angle with respect to the light that is transmitted through the card stock, since this light intensity has a cosine distribution. Consequently, a low noise (N) is achievable. Unfortunately, in the case of a hole, the signal (S) is also a function of the separation distance, and a limit is soon reached that yields a marginally low signal.

Some of the factors that adversely affect the required S/N ratio in a multichannel read head are:

- Light variation across all channels of the read head.
- Phototransistor light sensitivity across all channels of the read head.
- Component degradation.
- Temperature effects.
- Maximum card transmission.
- Phototransistor amplifier switching points.

This list is not meant to be all inclusive; it simply illustrates that the product of these factors can have quite a large effect. For worst-case guarantee of operation, the actual S/N must exceed the product of all the variations.

The interaction of the source and detector in card reader design can be easily deduced intuitively. Recall the equivalent circuit of Fig. 1. The photodiode current (I) generated by the incident irradiance has to bias the base-emitter junction ON by charging the capacitors. Therefore, one would expect there would be a turn-on delay directly related to the capacitance and base-emitter voltage, and inversely related to the diode current or light intensity.

This is, in fact, the case. When a hole is present in a card, the light from the pulsed LED incident on the phototransistor is large, the photodiode current is large, and the delay is short. For a no-hole condition, the photodiode current is small and the delay long. Therefore, if a light pulse of duration shorter than the no-hole delay is used and the hole-no-hole decision is made during that time, the effective S/N can be greatly enhanced. Of course, if the pulse duration is much longer than the delay, the S/N must approach the same value as for the dc illumination.

The big improvement comes about because the no-hole phototransistor current is very small, thus permitting the switching point of the amplifier to be set very low.

The demonstration of this phenomenon is straight-forward, using the circuit of Fig. 1. If the phototransistor has been in a dark condition, only a small leakage current (I_{CEO}) will be flowing—10 nA is a representative value for this current at 25° C. For this magnitude of current, the phototransistor will be said to be OFF. How-

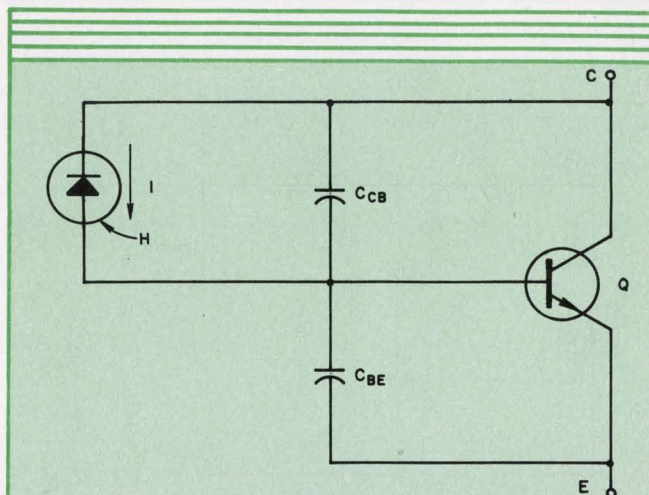

1. Phototransistor equivalent circuit consists of a photodiode that injects current into a pseudo base in response to incident light H. The base-to-collector and base-to-emitter capacitances are also shown. The actual phototransistor has no external connection to a base region, and this makes it difficult to measure the parameters.

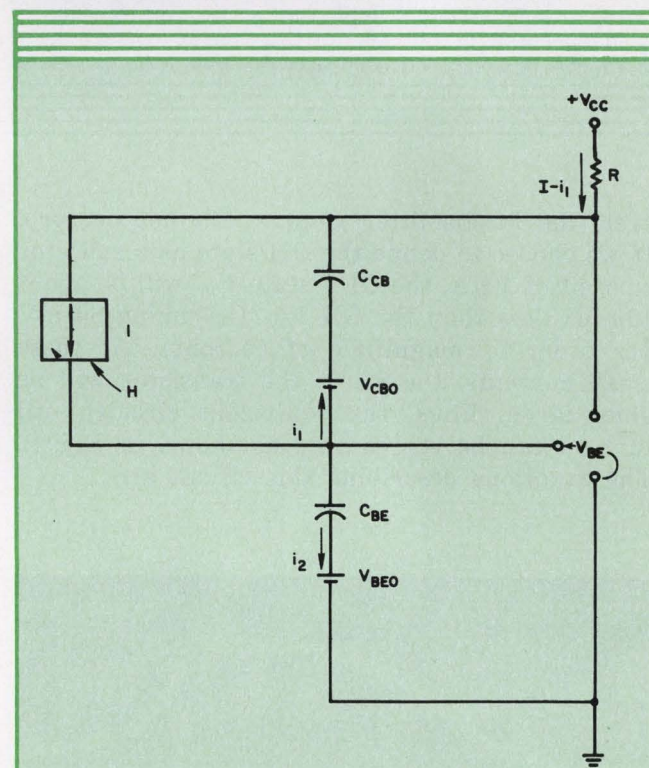

2. Prior to turn-on the phototransistor equivalent circuit is shown with an additional load resistor and external supply. The circuit is based on assumptions: (a) the high photodiode impedance can be neglected; (b) the photodiode response introduces no delay; (c) h_{ie} is very large; (d) C_{CB} and C_{BE} are independent of voltage; and (e) V_{CBO} and V_{BE0} represent initial capacitor voltages.

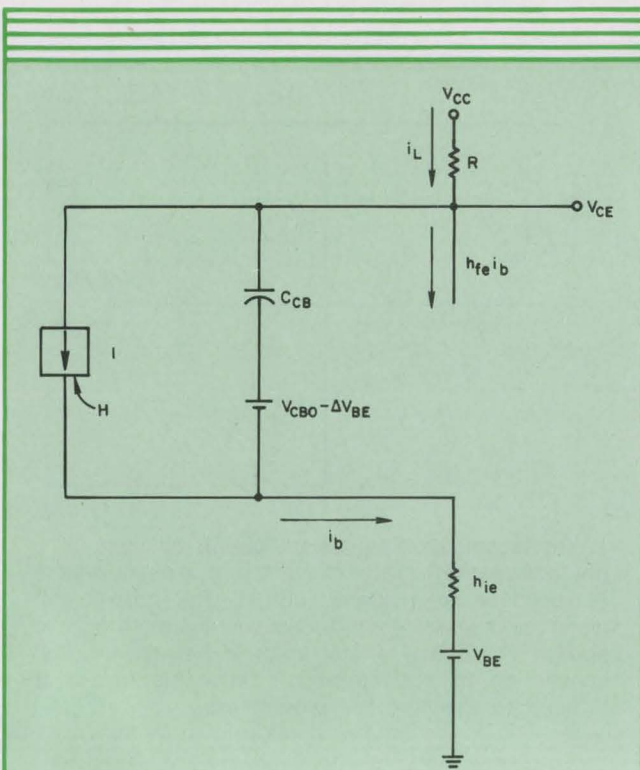

3. For the ON state, the phototransistor equivalent circuit is based on the following assumptions: (a) h_{ef} is constant and very large; (b) C_{CB} is independent of voltage; (c) C_{BE} can be neglected; (d) $h_{fe} R \gg h_{ie}$; and (e) $V_{BE} = V_{BE0} + \Delta V_{EB}$.

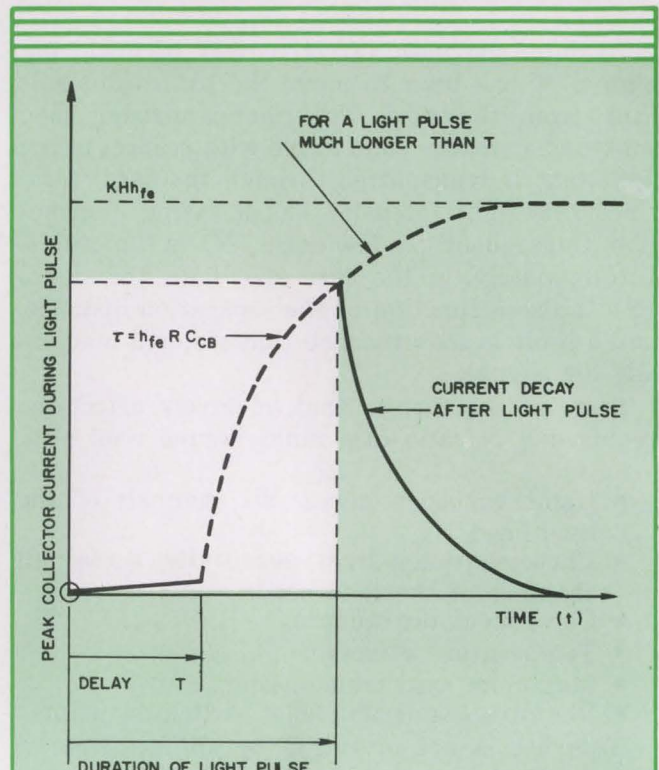

4. The response of a phototransistor to a pulse of light that is long enough to cause switching to the ON state shows the delay time, T , and the rise with a time constant of t , and exponential decay of collector current.

ever, the base-emitter voltage will not be zero. If we choose to define the ON state as a collector current of $1 \mu A$, the OFF state V_{BE} will be about 120 mV less than the ON V_{BE} (assuming 60 mV per order of magnitude of current). At these small currents, the h_{ie} of the transistor will be quite large. Thus, the equivalent circuit until turn-on can be represented as shown in Fig. 2. The equations describing this circuit are:

$$V_{BE} = V_{BE0} + \frac{1}{C_{BE}} \int_0^t i_2 dt,$$

$$I = i_1 + i_2,$$

$$V_{BE} = V_{CC} - C_{CB0} + \frac{1}{C_{CB}} \int_0^t i_1 dt - (I - i_1) R.$$

Substituting,

$$C = C_{BE} C_{CB} / (C_{BE} + C_{CB}),$$

$$V_{BE0} = V_{CC} - V_{CB0}, \text{ and}$$

$$I = kH, \text{ where } k \text{ is a proportionally constant}$$

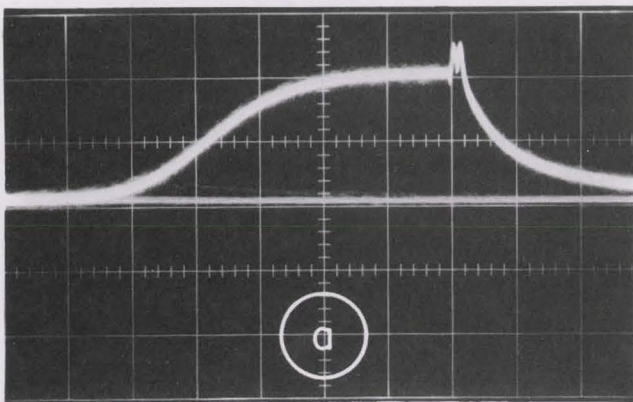

5. Waveforms show collector current for no hole in card (a) and a hole in card (b). For (a), the light pulse duration is $70 \mu s$, the vertical scale is $5 \mu A/cm$ and the horizontal scale is $10 \mu s/cm$. The long pulse illustrates dc noise level. For (b), the light pulse duration is $12 \mu s$,

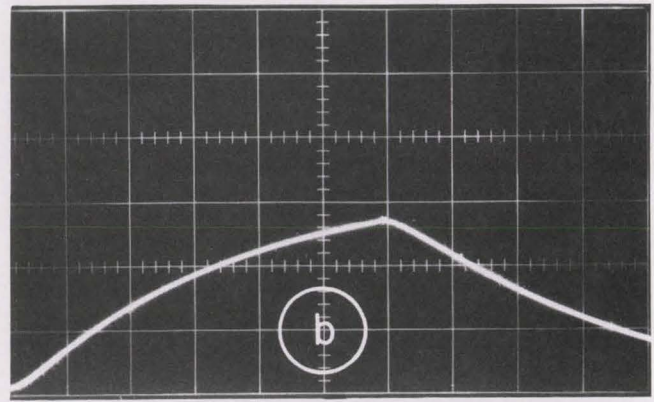

the vertical scale is $357 \mu A/cm$, the horizontal scale is $2 \mu s/cm$, the current at $10 \mu s \approx 930 \mu A$, and the rise time constant is approximately $10 \mu s$ which would result in a steady state dc level of $1300 \mu A$.

and H is irradiance.

The equations can be solved by use of Laplace transform methods to obtain:

$$V_{BE}(t) = V_{BEO} + \frac{kH}{C_{CB} + C_{BE}} [t - RC(1 - e^{-t/RC})]$$

The term within the brackets must change ΔV_{BE} in time T to turn the transistor on. So,

$$\Delta V_{BE} = \frac{kH}{C_{CB} + C_{BE}} [T - RC(1 - e^{-T/RC})]. \quad (1)$$

Consideration of a typical example can permit simplification of Eq. 1. For example, for an $R = 10 \text{ k}\Omega$ and a $C = 100 \text{ pF}$.

$$RC = 10^4 \times 10^{-10} = 1 \text{ }\mu\text{s}$$

Therefore, for delays, T , much greater than RC , or $1 \text{ }\mu\text{s}$, Eq. 1 can be approximated by

$$\Delta V_{BE} = kHT / (C_{CB} + C_{BE}).$$

Solving for the time duration then gives

$$T = (C_{CB} + C_{BE}) \Delta V_{BE} / kH. \quad (2)$$

This is in agreement with the intuitive derivation made previously.

After T , the base current will increase rapidly as the device becomes sufficiently forward biased. When this happens, the equivalent circuit will be as shown in Fig. 3. Solving the circuit of Fig. 3 for i_L in much the same procedure as before yields:

$$i_L = kHh_{fe}(1 - e^{-(t-T)/h_{fe}RC_{CB}}), \text{ for } t \geq T \quad (3)$$

Considering Eqs. 2 and 3, the current in the load resistor will appear as in Fig. 4 for a step function light input.

To take full advantage of the low-light-level delay effect, the light pulse duration must be less than the low-light-level turn-on delay. Therefore, Fig. 4 represents the hole, or high light level, phototransistor response, in which the turn-on delay is negligible and the current rises in accordance with Eq. 3 toward some peak value.

For the low light level (no-hole), the turn-on delay is not negligible and the light pulse turns off before the phototransistor turns on, thus keeping the load current very small. Also, h_{fe} is smaller at low currents, accentuating the phenomenon. Representative data taken with Texas Instruments LS600 phototransistors, with $V_{CC} = 10 \text{ V}$, $R = 5.6 \text{ k}\Omega$ and illuminated by pulsed LEDs fabricated at IBM's Thomas J. Watson Research Center, are shown in the table. Commercially available diodes will give comparable performance. Performance with steady-state illumination is also shown for comparison.

The improvement in S/N is more than a factor of 7 in this case. The peak hole current is somewhat decreased, but the no-hole is improved by an order of magnitude.

In this application, the average phototransistor sensitivity for standard measuring condition was:

$$I_L = 3.3 \text{ mA @ } H = 20 \text{ mW/cm}^2 \text{ tungsten}$$

Pulse technique improves S/N

LED current	Phototransistor peak current		S/N
	Hole in card	no hole in card	
60 mA for 10 μs	930 μA	1 μA	930
60 mA dc	1300 μA	10 μA	130

irradiance at a color temperature of 2870° K and $V_{CE} = 3 \text{ V}$. The typical GaAs LED produced $65 \text{ }\mu\text{W}$ of power into a 10° half-angle cone for an input current of 60 mA .

For these conditions, the measured T was $30 \text{ }\mu\text{s}$ —the time for the collector to rise to $1 \text{ }\mu\text{A}$ for the no-hole condition. Therefore, a $30\text{-}\mu\text{s}$ light pulse could have been used rather than a $12\text{-}\mu\text{s}$ pulse as shown in Fig. 5b, resulting in a greater hole current and S/N. Figure 5a illustrates the dc noise level with the light pulse lengthened to $70 \text{ }\mu\text{s}$.

The drawbacks of applying this technique on a mass production scale are in specifying the junction capacitances and the device "gain" ($k = i_L/H$). Since the phototransistors have only two terminals, parameter measurement is difficult. However, measurements on a number of phototransistors of a given type in various gain bands should yield good statistical information and possibly eliminate the need for knowing exact parameter values. For a one-time, application or other limited applications, irradiance conditions can be adjusted to give excellent performance. ■■

Test your retention

Here are questions based on the main points of this article. Their purpose is to help you make sure you have not overlooked any important ideas. You'll find the answers in the article.

1. What is the significance of signal-to-noise ratio in this application?
2. What two factors account for the improvement in S/N when pulsed LEDs are used with phototransistors?
3. What secondary benefit is gained by using pulsed LEDs as light sources?
4. What is the distribution of light passing through the card stock?
5. What is the "gain" of a phototransistor?

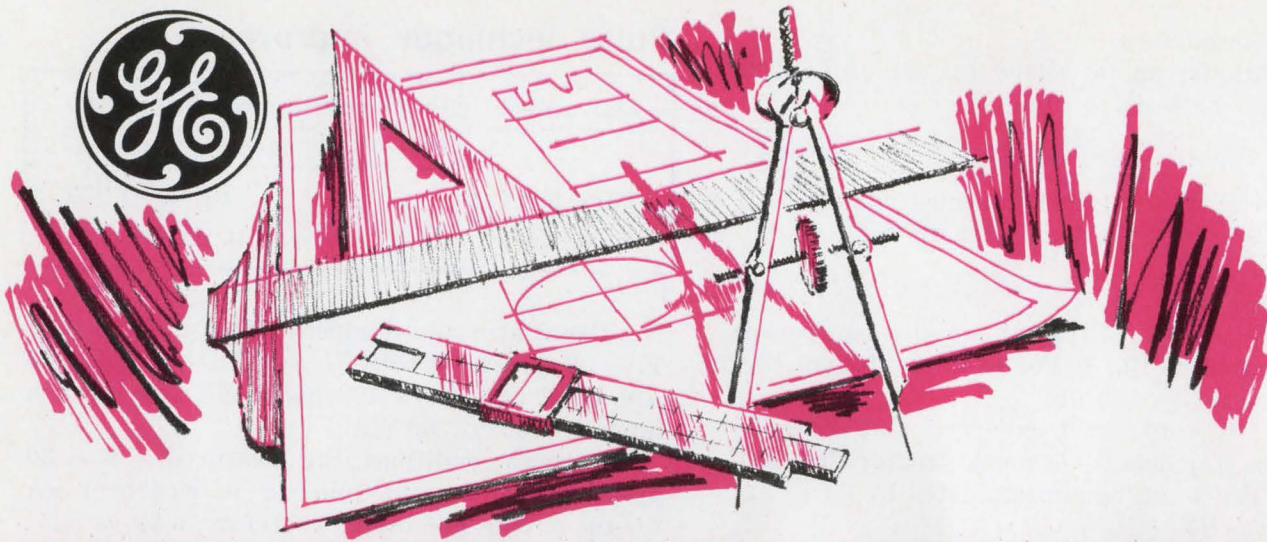

New 25 amp triac offers several exceptional performance features

GE has extended its broad thyristor line with the addition of a new 25 ampere triac. SC60 (stud-mounted) and SC61 (press-fit) offer several exceptional features:

Current rating 25A RMS
Voltage 200V, 400V, 500V rating
Surge current 250A Peak
Commutating 5V/ μ sec. dv/dt MIN.
Static 200V/ μ sec. dv/dt TYP.

The SC60/61 triac can handle up to 6KW at 240 volts and is compatible with PA424 and PA436 IC's for control of heaters, lamps and motors.

SC60/61 is well suited to high volume use in residential and industrial space heating, large lamp-dimming controls, temperature control in copying machines and many other applications. For details, circle 211.



Pin-sized Lodex® magnet

Now get proved Lodex® permanent magnets in sizes smaller than a pin

When designs call for tiny (even less than 1 millimeter) permanent magnets, GE has the answer. GE can produce powerful micro-miniature magnets at low cost—and in complex configurations, too.

The magnets are made of proved Lodex material. This exclusive GE product makes it possible to produce magnets in tiny, intricate shapes meeting extremely tight physical and magnetic tolerances.

Close piece-to-piece physical and magnetic uniformity often eliminates the need for final testing of the end product. These magnets are the perfect answer for such precise applications as reed switches.

For details, circle 212.



General Electric meter relays give you reliability at lower cost

Reliable performance at lower cost makes GE your best meter relay choice.

Functions include energizing alarms; close differential relaying; and controlling temperature, power, speed and frequency.

Proved GE design is better three ways:

- **New contactless control action.** Solid-state, light sensitive switch means simple, reliable control.
- **"Piggyback" control module.** Plug-in design saves installation time.
- **Choice of styles.** Easy-reading BIG LOOK® or low-profile HORIZON LINE® meter relays.

Applications range from critical monitoring in hospital intensive-care units to deep-well drilling control.

For details, circle 213.



100-CFM unit

Get reliable cooling for computer cabinets with proved GE fan assemblies

GE cooling fan assemblies offer years of continuous duty without maintenance. Available in two sizes, these blower fans feature all-angle operation and efficient air flow.

Small 90 and 100 CFM fans have KSB33-frame Unitized® motors and fit an opening 4 $\frac{3}{4}$ " square. Near perfect bearing bores, accurate shaft-bearing alignment and metered oil bearings virtually eliminate bearing wear for long motor life.

GE's 500 CFM fan mounts on a 9.7" diameter bolt circle through holes in its aluminum venturi. Its KSP11-frame unit-bearing shaded-pole motor provides quiet, long-life operation.

For more information, circle 214.



New GE transistor is the ideal epoxy replacement for "hermetic" devices

General Electric's GET transistor series is a new answer to design problems. GET is the newest addition to GE's proved family of epoxy-encapsulated transistors dating back to 1962 . . . over 7 years of epoxy experience.

GET is the ideal epoxy replacement for "hermetic" devices . . . no expensive redesign needed. The new D32 package conforms to TO-18 mounting patterns and is available in these silicon planar, passivated models:

GE Model	Type	JEDEC No.
GET706, 708, 914	NPN	2N706, 708, 914
GET2221, 2222	NPN	2N2221, 2222
GET3638, 3638A	PNP	2N3638, 3638A
GET2869, 3013, 3014, 3646	NPN	2N2869, 3013, 3014, 3646
GET929, 930	NPN	2N929, 930

GE's quality epoxy forms a true chemical bond with metal to provide increased resistance to moisture and vibration damage. Low profile package means smaller circuits and lower cost.

For more information on GET and GE's "specials" capability, circle 215.

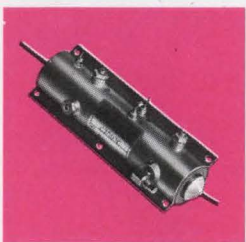

Check this new GE transmitter design

GE's C2003C transmitter is a Microwave Circuit Module containing a master oscillator and power amplifier using planar ceramic triodes.

It is one of many GE MCM's that help reduce design cycles, provide retrofit and lead to improved system performance.

C2003C benefits: meets performance and military requirements of the transmitter portion of IFF transponder

- permits two transmitters to function in space formerly used by one
- light weight
- significantly smaller
- simplified heat sinking
- excellent frequency stability with wide variations in antenna VSWR. For details, circle 221.

11 more

electronic components tailored for designers

General Electric components are engineered for reliability and cost effectiveness. No other single manufacturer offers such a wide selection of quality electronic components as General Electric. Specify GE in your designs.



GE fused quartz and fused silica add design flexibility to many applications

Highest purity GE Fused Quartz is being applied in crystal pulling, zone refining, semiconductor diffusion and research labware. And many new electronic applications are constantly being developed.

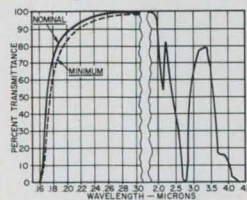

Transmittance Curve—151 Fused Silica for 1cm thickness*

GE type 151 Fused Silica, for critical optical jobs, is a schlieren grade material offering highest ultra-violet transmission.

Type 151 is one of five optical grades available. It is ideal for use in laser optics, absorption cells, spectrophotometer optical elements and schlieren photography.

For technical data and application assistance, circle 216.

*Excluding surface reflection losses



Tough, dependable indicating lights come in four sizes for varied application

GE has a broad assortment of low cost, high quality indicating lights (CR103, type H) that come with four mounting hole diameters for varied applications — 5/16", 15/32", 11/16" and 1". They all feature Lexan® (polycarbonate resin) lenses which diffuse light, eliminate "hot spots" and are virtually unbreakable.

Lens shapes include crown, spherical, torpedo and cylindrical. Lamps and lenses for most models install from the front without removing the assembly or opening the panel.

And a low-cost miniature indicating light (the CR103 HE) has been added to the line for applications where space is at a premium and minimum cost is essential.

The CR103 H line is perfect for applications such as panel indicators, lab equipment, appliances, meters, gauges, timers, and illuminated pointers and indicators for dials.

Get full-line details, circle 217 on the reader service card.



Innovative design gives GE Klystrons greater bandwidth, gain and efficiency

An experienced team of GE specialists uses innovative techniques to produce high-power Klystrons with greater bandwidth, gain and efficiency.

The Klystron above is just one example of GE's high-power pulsed microwave amplifier used in applications such as radar and particle accelerators.

GE Klystron designs can be developed in tunable and broadband types for all frequencies from UHF to X-band. They feature metal-ceramic construction, integral ion pumps and modular design for long life, low operating costs, and economical repair.

Put GE's team to work on your special Klystron application. For details, circle 218.

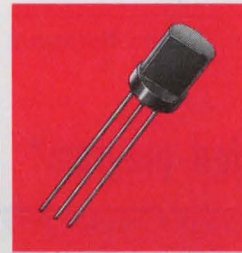

New GE integrated voltage regulator smoothes ripple and protects IC's

GE's new integrated voltage regulator (IVR) is a monolithic IC that helps your power supply deliver constant, ripple-free voltage for solid-state circuit components. The device operates as a shunt regulator over a range of 10 to 40 volts at up to 400mW avg. power.

Total Avg. Power	400mW
Voltage	10-40V
Peak Current	1A
(10 sec pulse width, 1% duty cycle)	
Operating Temp. Range	-15C to +125C
Temp. Coefficient of rated voltage	.03%/°C typ.

Housed in the standard epoxy TO-98 package, GE's IVR is a low-cost means to stabilizing voltage for solid-state circuits. Applications are found in auto radios, TV ripple filters and as a reference amplifier for high-power regulation. The IVR can also be used where other voltage regulation methods have been too costly for high-volume use.

For details, circle 219.



Get over 1/2 farad at 5 volts with GE computer-grade capacitors

GE 86F500 high-capacitance computer-grade capacitors provide up to 540,000 μ f at five volts (34,000 μ f at 100 volts) in a single case.

These units are excellent when large blocks of capacitance are required, as in power supply filters.

86F500 units are rated for continuous duty at 65C or at 85C with proper voltage derating. GE's computer-grade capacitors provide highest capacitance per case size, high ripple current capability, low ESR and long life.

Units are available in nine case sizes — diameters 1 3/8" to 3" with lengths up to 8 5/8" — for operation up to 100 VDC.

For details, circle 220.

LOOK TO GENERAL ELECTRIC—your best source for more in electronic components.

285-53

ELECTRONIC COMPONENTS SALES OPERATION

GENERAL  ELECTRIC

Design attenuator pads the easy way

using this simple BASIC computer program. Losses and impedances are provided for six pad types.

Attenuator pad design can easily get bogged down in arithmetic. Using a time-shared computer to perform the routine calculations can save time, money—and wear and tear on the designer's disposition. PAD is a simple BASIC-

Bill E. Johnson, Engineer, Pacific Northwest Bell Telephone Co., Portland, Ore.

language program designed to take the arithmetic out of pad design.

BASIC was chosen since it is close to plain English and it allows equations to be expressed in a form similar to the handwritten version. Another advantage of BASIC is its wide availability from time-sharing companies.

The PAD program, as shown in Table 1, is

Table 1. PAD design program*

```

100 PRINT "WHAT IS Z IN, Z OUT AND LOSS";
110 INPUT A,B,L
120 IF A=B THEN 580
130 IF B>A THEN 190
140 LET Z1=A
150 LET Z2=B
160 LET C=1
170 LET D=2
180 GOTO 230
190 LET Z1=B
200 LET Z2=A
210 LET C=2
220 LET D=1
230 LET K5=(Z1+SQR((Z1^2)-(Z1*Z2)))/Z2
240 LET L5=LOG(K5/SQR(Z1/Z2))/(LOG(10)/20)
250 IF L<L5 THEN 870
260 LET K=(EXP(L*(LOG(10)/20)))*(SQR(Z1/Z2))
270 LET N=EXP(L*(LOG(10)/10))
280 LET X1=Z1*((K*Z2)*(K-2)+Z1)
290 LET Y2=Z2*((K^2*Z2)-Z1*(2*K-1))
300 LET V2=((K^2)*Z2)-Z1
310 LET S(1)=X1/V2
320 LET S(2)=Y2/V2
330 LET P3=(2*SQR(N*Z1*Z2))/(N-1)
340 LET P(2)=(((K^2)*(Z2^2)-(Z1*Z2))/((K*Z2*(K-2)+Z1))
350 LET P(1)=(Z1*((K^2)*Z2)-Z1)/(((K^2)*Z2)-(2*K*Z1)+Z1)
360 LET S3=(P(2)*Z2*(K-1))/(P(2)+Z2)
370 PRINT
380 PRINT "FOR UNSYMMETRICAL BALANCED PADS WHERE Z1=";A"OHMS,"
390 PRINT "Z2=";B"OHMS AND LOSS IS"L"DB, THEN,"
400 PRINT
410 PRINT
420 PRINT "      FOR THE H CONFIGURATION:"
430 PRINT
440 PRINT " INPUT SERIES RESISTORS, S1A AND S1B, ARE";S(3-D)/2"OHMS"
450 PRINT "OUTPUT SERIES RESISTORS, S2A AND S2B, ARE";S(3-C)/2"OHMS"
460 PRINT "SHUNT RESISTOR, P, IS";P3"OHMS."
470 PRINT
480 PRINT
490 PRINT "      FOR THE SQUARE CONFIGURATION:"

```

relatively short and can be typed in at any keyboard terminal of a BASIC-equipped time-sharing system. The only inputs the program requires are the input and output impedances (in ohms) which the pad must work into, and the desired voltage or current loss expressed in decibels. Once the required information has been typed in, the computer will provide resistance

and minimum-loss figures for the six types of attenuation networks shown in Table 2.

The pad equation derivations are straightforward^{1,2} with two exceptions: the lattice equations are obtained by first converting to an equivalent T , and a square root is involved in the equation for the minimum possible matching loss. The computer might have trouble taking the

```

500 PRINT
510 PRINT " INPUT SHUNT RESISTOR, P1, IS";P(3-D)"OHMS"
520 PRINT "OUTPUT SHUNT RESISTOR, P2, IS";P(3-C)"OHMS"
530 PRINT "SERIES RESISTORS, SA AND SB, ARE";S3/2"OHMS."
540 PRINT
550 PRINT
560 PRINT "MINIMUM LOSS IS";L5"DB."
570 GOTO 830
580 LET Z=A
590 LET K=EXP(L*LOG(10)/20)
600 LET S=(.5*Z)*(K-1)/(K+1)
610 LET P=2*Z*K/((K↑2)-1)
620 LET T=Z*((K↑2)-1)/(4*K)
630 LET F=Z*(K+1)/(K-1)
640 LET M=2*S
650 LET Y=Z/2
660 LET V=Z*(K-1)/2
670 LET W=Z/(K-1)
680 PRINT
690 PRINT
700 PRINT "FOR BALANCED SYMMETRICAL PADS OF";Z"OHMS AND"L"DB LOSS:"
710 PRINT
720 PRINT "H PAD SERIES RESISTORS, S, ARE";S"OHMS,"
730 PRINT "THE SHUNT RESISTOR, P,";P"OHMS."
740 PRINT
750 PRINT "SQUARE PAD SERIES RESISTORS, S, ARE";T"OHMS,"
760 PRINT "SHUNT RESISTORS, P, ARE";F"OHMS."
770 PRINT
780 PRINT "RESISTORS FOR LATTICE PAD ARE, X OR Y,";F"AND, Y OR X,";M"OHMS."
790 PRINT
800 PRINT "BRIDGED H SERIES RESISTORS, S, ARE";V"OHMS,"
810 PRINT "THE SHUNT RESISTOR, P, IS";W"OHMS. THIS PAD USES";Y"OHM"
820 PRINT "FIXED RESISTORS FOR ALL VALUES OF LOSS."
830 PRINT
840 PRINT "EXCEPT FOR THE SYMMETRICAL LATTICE PAD, MULTIPLY SERIES"
850 PRINT "RESISTOR VALUES BY TWO FOR THE UNBALANCED PAD VALUES."
860 STOP
870 PRINT
880 PRINT "MINIMUM LOSS FOR THESE IMPEDANCES IS";L5"DB."
890 END

```

Table 2. Attenuator pad configurations

Unsymmetrical pads**		
Pad	Equations	Program line nos.
<p>(a)</p>	$S_1 = S_{1A} + S_{1B} = \frac{Z_{IN} [KZ_{OUT} (K - 2) + Z_{IN}]}{K^2 Z_{OUT} - Z_{IN}}$ $S_2 = S_{2A} + S_{2B} = \frac{Z_{OUT} [K^2 Z_{OUT} - Z_{IN} (2K - 1)]}{K^2 Z_{OUT} - Z_{IN}}$ $P = \frac{2 \sqrt{NZ_{IN}Z_{OUT}}}{N - 1}$	<p>280, 300, 310</p> <p>290, 300, 320</p> <p>330</p>
<p>(b)</p>	$S = S_A + S_B = \frac{P_2 Z_{OUT} (K - 1)}{P_2 + Z_{OUT}}$ $P_1 = \frac{Z_{IN} (K^2 Z_{OUT} - Z_{IN})}{K^2 Z_{OUT} - 2KZ_{IN} + Z_{IN}}$ $P_2 = \frac{K^2 Z_{OUT}^2 - Z_{IN} Z_{OUT}}{KZ_{OUT} (K - 2) + Z_{IN}}$	<p>360</p> <p>350</p> <p>340</p>
Symmetrical pads**		
<p>(c)</p>	$S = \frac{0.5 Z (K - 1)}{K + 1}$ $P = \frac{2 Z K}{N - 1}$	<p>600</p> <p>610</p>
<p>(d)</p>	$S = \frac{Z (N - 1)}{4K}$ $P = \frac{Z (K + 1)}{K - 1}$	<p>620</p> <p>630</p>
<p>(e)</p>	$X \text{ or } Y = \frac{Z (K + 1)}{K - 1}$ $Y \text{ or } X = \frac{Z (K - 1)}{K + 1}$	<p>630</p> <p>600, 640</p>
<p>(f)</p>	$S = \frac{Z (K - 1)}{2}$ $P = \frac{Z}{K - 1}$	<p>660</p> <p>670</p>

* $N = \text{Power Loss} = \text{antilog}_{10} \frac{\text{dB loss}}{10}$ (line 270)

** When $Z_1 = Z_2$, $P_1 = P_2$, $S_1 = S_2$, and $K = \text{antilog} \left(\frac{\text{dB loss}}{20} \right) \times \sqrt{\frac{Z_1}{Z_2}}$ (line 260)

When $Z_1 = Z_2$, $P_1 = P_2$, $S_1 = S_2$, and $K = \text{antilog} \frac{\text{dB loss}}{20}$ (line 590)

*** Minimum loss for H pad occurs when the series resistances next to the lowest impedance becomes zero. For square pad it occurs when the shunt resistor next to the highest impedance becomes infinity. Both then have the same configuration, and:

$$K_{\text{Min}} = \frac{Z_1 + \sqrt{Z_1^2 - Z_1 Z_2}}{Z_2}, \text{ (line 230)}$$

$$L_{\text{Min}} = 20 \left[\log \frac{K_{\text{Min}}}{\sqrt{Z_1/Z_2}} \right] \text{ (line 240)}$$

Where $Z_1 = \text{larger of } (Z_{IN}, Z_{OUT})$, $Z_2 = \text{smaller of } (Z_{IN}, Z_{OUT})$.

Table 3. Samples of PAD program results

(a)

WHAT IS Z IN, Z OUT AND LOSS? 600,150,20

FOR UNSYMMETRICAL BALANCED PADS WHERE $Z_1=600$ OHMS,
 $Z_2=150$ OHMS AND LOSS IS 20 DB, THEN,

FOR THE H CONFIGURATION:

INPUT SERIES RESISTORS, S1A AND S1B, ARE 275.758 OHMS
OUTPUT SERIES RESISTORS, S2A AND S2B, ARE 46.2121 OHMS
SHUNT RESISTOR, P, IS 60.6061 OHMS.

FOR THE SQUARE CONFIGURATION:

INPUT SHUNT RESISTOR, P1, IS 973.771 OHMS
OUTPUT SHUNT RESISTOR, P2, IS 163.187 OHMS
SERIES RESISTORS, SA AND SB, ARE 742.5 OHMS.

MINIMUM LOSS IS 11.439 DB.

EXCEPT FOR THE SYMMETRICAL LATTICE PAD, MULTIPLY SERIES
RESISTOR VALUES BY TWO FOR THE UNBALANCED PAD VALUES.

(b)

WHAT IS Z IN, Z OUT AND LOSS? 150,600,20

FOR UNSYMMETRICAL BALANCED PADS WHERE $Z_1=150$ OHMS,
 $Z_2=600$ OHMS AND LOSS IS 20 DB, THEN,

FOR THE H CONFIGURATION:

INPUT SERIES RESISTORS, S1A AND S1B, ARE 46.2121 OHMS
OUTPUT SERIES RESISTORS, S2A AND S2B, ARE 275.758 OHMS
SHUNT RESISTOR, P, IS 60.6061 OHMS.

FOR THE SQUARE CONFIGURATION:

INPUT SHUNT RESISTOR, P1, IS 163.187 OHMS
OUTPUT SHUNT RESISTOR, P2, IS 973.771 OHMS
SERIES RESISTORS, SA AND SB, ARE 742.5 OHMS.

MINIMUM LOSS IS 11.439 DB.

EXCEPT FOR THE SYMMETRICAL LATTICE PAD, MULTIPLY SERIES
RESISTOR VALUES BY TWO FOR THE UNBALANCED PAD VALUES.

square root of a negative number on line 230. This is the reason for lines 130 to 220. They ensure that Z_1-Z_2 is positive (for nonsymmetrical pads) regardless of whether Z_{IN} or Z_{OUT} is the greater. Z_1 is chosen to be the larger of Z_{IN} or Z_{OUT} . These instructions also set up

the mechanics for correct print-out of resistor values for either condition as called for in lines 440, 450, 510 and 520.

Since Z_1 must be greater than Z_2 , K represents either a voltage or a current ratio. It is the voltage ratio for $Z_1:Z_2$ when Z_1 is the

Table 3. Samples of PAD program results (continued)

(c)
WHAT IS Z IN, Z OUT AND LOSS? 600,600,6
FOR BALANCED SYMMETRICAL PADS OF 600 OHMS AND 6 DB LOSS:
H PAD SERIES RESISTORS, S, ARE 99.6837 OHMS, THE SHUNT RESISTOR, P, 803.173 OHMS.
SQUARE PAD SERIES RESISTORS, S, ARE 224.111 OHMS, SHUNT RESISTORS, P, ARE 1805.71 OHMS.
RESISTORS FOR LATTICE PAD ARE, X OR Y, 1805.71 AND, Y OR X, 199.367 OHMS.
BRIDGED H SERIES RESISTORS, S, ARE 298.579 OHMS, THE SHUNT RESISTOR, P, IS 602.856 OHMS. THIS PAD USES 300 OHM FIXED RESISTORS FOR ALL VALUES OF LOSS.
EXCEPT FOR THE SYMMETRICAL LATTICE PAD, MULTIPLY SERIES RESISTOR VALUES BY TWO FOR THE UNBALANCED PAD VALUES.

input; it is the current ratio for $Z_2:Z_1$ when Z_2 is the input.

As an example, refer to the solution $Z_{IN} = 600$ ohms, $Z_{OUT} = 150$ ohms and $L = 20$ dB (Table 3a). K , as computed on line 260, is 20—the voltage ratio for $Z_{IN}:Z_{OUT}$. The corresponding current ratio is $20:(150/600)$ or 5.

Next refer to the solution where Z_{IN} and Z_{OUT} have their values reversed (Table 3b). Line 260 still computes K as 20, but it is the current ratio $IN:OUT$. The voltage ratio is 5.

A third example is shown in Table 3c where the computer has been requested to provide a selection of 6 dB loss pads with both input and output impedances equal to 600 ohms.

Note that the computer uses natural logs, making it necessary to convert to common logs. Rounding operations were omitted to keep the program short. The user can round to any required degree. ■■

Reference:

1. International Telephone and Telegraph Corporation, *Reference Data for Radio Engineers*, 14th ed, New York, 1956, pp. 247-262.
2. American Telephone and Telegraph Company, *Principles of Electricity Applied to Telephone and Telegraph Work*, Graybar Electric Company, New York, 1961, pp. 166-175.

ELECTRONIC DESIGN is interested in receiving manuscripts from readers who have worked out BASIC or other programs for widely used networks, such as filters, compensating circuits, etc. Please include in your article:

1. Diagrams of the networks.
2. Basic mathematical equations (with a short derivation or reference).
3. Short discussion of the program (correlating program lines with mathematical equations).
4. Flow chart of the program.

Test your retention

Here are questions based on the main points of this article. Their purpose is to help you make sure you have not overlooked any important ideas. You'll find the answers in the article.

1. What does K represent in the pad design equations?
2. Why is it necessary to set Z_1 equal to the larger of Z_{IN} or Z_{OUT} ?
3. How are the equations for the lattice derived?

Now, you can make your pressure transducer system faster and at lower cost...

All you add is power & readout

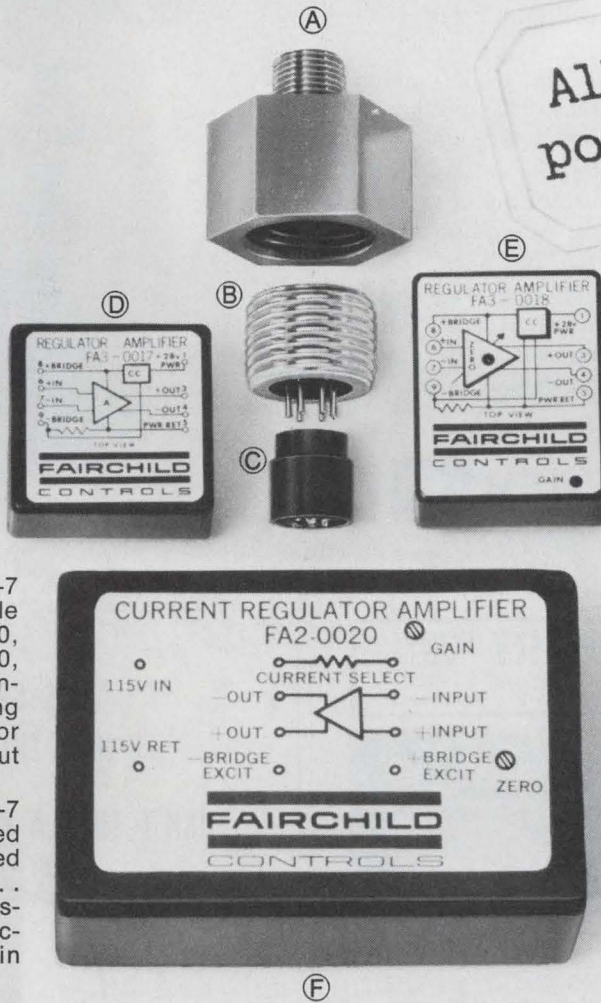

Matched, interfaced, ready for quick interconnection... here's everything you need for the heart of your pressure transducer system: transducer, pressure fitting, amplifier/regulator, even the pin connector. All you need to add is power and readout.

B FPT-7 Pressure Transducer

The miniature solid-state FPT-7 pressure transducer is available in six pressure ranges (0-20, 0-100, 0-500, 0-1000, 0-2000, and 0-3000 PSIG). Features include: integrated-circuit sensing element; $\pm 0.5\%$ F.S. static error band; 100 mV min. F.S. output and high frequency response.

A C Pressure Fitting The FPT-7 pressure transducer is delivered already mounted in a threaded ($\frac{1}{8}$ -27 NPTF) pressure fitting... attaches to your liquid or gaseous pressure source. For electrical connections, slip-on pin

connectors are available. Special fittings are offered for vacuum, underwater, rough-use and military applications.

D E F Choice of Three Regulator/Amplifiers All three are matched to the FPT-7 transducer. FA3-0017 and FA3-0018 are for 28 VDC and FA2-0020 is for AC 115V, 60Hz. All three provide 5 mA constant current transducer drive, accept back the transducer signal and provide an output to the readout with a gain of 50 @ 1mA minimum. Models FA3-0018 and FA2-0020 have ZERO and GAIN adjust $\pm 20\%$ of setting.

Get Off To a Faster Start

The time you save making your own system is only part of it. Sometimes it takes longer to order the parts than it does to put them together. To cut order time and red tape, use the order blank below.

* 50 Hz available

ORDER NOW BLANK Fairchild Controls, Transducer Plant, 423 National Avenue, Mountain View, California U.S.A. 94040

Qty.	Item	Description	Price Each	Total Price	(Please print)
_____	B1	FPT-7 Pressure Transducer 0-20 PSIG	\$168.00	_____	Name
_____	B2	FPT-7 Pressure Transducer 0-100 PSIG	140.00	_____	Company
_____	B3	FPT-7 Pressure Transducer 0-500 PSIG	120.00	_____	Address
_____	B4	FPT-7 Pressure Transducer 0-1000 PSIG	120.00	_____	
_____	B5	FPT-7 Pressure Transducer 0-2000 PSIG	120.00	_____	
_____	B6	FPT-7 Pressure Transducer 0-3000 PSIG	120.00	_____	
_____	C	FPT-7 6 Pin Connector	2.50	_____	
_____	A	FPT-7 Pressure Fitting $\frac{1}{8}$ -27 NPTF, brass	5.00	_____	
_____	D	FA3-0017 dc Regulator/Amplifier	65.00	_____	
_____	E	FA3-0018 dc Regulator/Amplifier (with ZERO & GAIN adjust)	95.00	_____	SHIP TO:
_____	F	FA2-0020 AC Regulator/Amplifier (with ZERO & GAIN adjust)	150.00	_____	Name
_____		Socket Mount for D above	2.75	_____	Company
_____		Socket mount for E and F above (Two required for F)	4.00	_____	Address
		Total	_____	_____	City

Delivery: Stock to 4 weeks. Terms: Net 30 days. Prices FOB Mountain View, California. Prices apply in the United States and Canada and are subject to change without notice. U.S. funds.

FAIRCHILD
CONTROLS

City

State

Zip

small wonder.

Where else can you find gold-plated contacts in an economical ultraminiature pushbutton?

These tiny new pushbuttons pack a lot of value into a mighty small package. They're the first ultraminiature devices offering Cutler-Hammer quality for computer, office machine and instrument applications. Cost is ultraminiature, too.

Exclusive gold-plated contacts and wiping action make them ideal for dry circuits. Since .040" overtravel is standard, they make fine ultraminiature limit switches.

Available from stock in single-pole only, with NO or NC circuits, with red or black operator buttons. Ten colors of decorator button caps and a protective boot seal are also available.

Rating at 125 VAC (Resistive); 1/2 amp, NO and 1/4 amp NC. Contact Resistance: 10 Milliohms max., initial. Life expectancy 50,000 minimum operations at rated load.

Call your Cutler-Hammer Sales Office or Stocking Distributor.

CUTLER-HAMMER 
SPECIALTY PRODUCTS DIVISION, Milwaukee, Wis. 53201

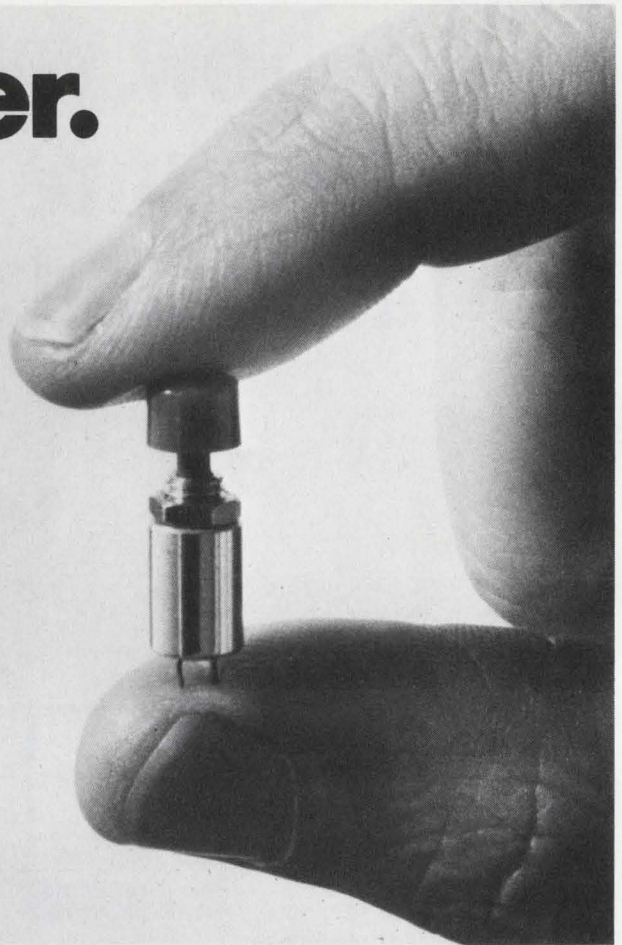

INFORMATION RETRIEVAL NUMBER 36

MAIL ORDER INDUSTRIAL MART UNUSUAL VALUES

Products available by mail. Money-back guarantee. Order by Number. Send check, m.o. or open account to rated firms. \$10. minimum order.



Encapsulated Liquid Crystals

Amazing new development—appear like liquids but have orderly molecular structures similar to solids. Solutions contained in tiny (20-30 microns) capsules coated onto sides of six 6" x 12" Mylar sheets with 6 diff. temp. ranges. Surface changes color according to temp. -cover 66° to 120°F (19°-49°C). Use for precise measurements, find hot spots, structural defects, study radiation, test conductivity, etc. Use indefinitely without mess, contamination. Easily handled. Instruct., color-temp. curves.
Stock No. 71,143DA.....\$10.00 Ppd.
EXPERIMENTERS KIT—4" x 6"
Stock No. 60,756DA.....\$4.00 Ppd.

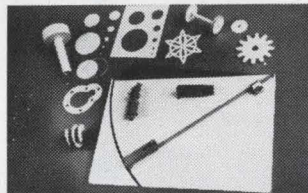

Left-Handed Circle Cutter

Now, cut perfect circles from 3/8" to 24" diam. with new easy to use, precision device. Makes professional quality gaskets, washers, wheels, models, toys, decorative art, etc. Cuts rubber, vinyl, cork, balsa, bristol board up to 1/32" thick—more if soft & from both sides. Makes any contour when used free-hand. Perfect for hobbyists, machinists, engineers, architects, designers... indispensable for mock-ups. 2 1/2" long plastic & steel cutter, extension bar & clamp can be assembled for either right or left-hand use.
Stock No. 60,755DA.....\$5.00 Ppd.



Rolamite Demonstrator Kit

Now build an experiment with "the only basic mechanical device discovered in this century." Almost frictionless bearing—compared in significance to the wheel, lever, spring. Fantastically versatile. Can function as pump, brake, switch—almost any size. Operates without lubricants. Countless applications—thousands more from resultant inventions. Incl. demo., 8 bands, 2 rollers, 2 tracks, instructions.
Stock No. 60,762DA.....\$10.00 Ppd.



Giant Free Catalog

Completely new 1969 edition, 148 pages—1000's of Bargains. New items, categories, illustrations. Dozens of electrical and electromagnetic parts, accessories. Enormous selection of Astronomical Telescopes, Microscopes, Binoculars, Magnifiers, Magnets, Lenses, Prisms. Many war surplus items: for hobbyists, experimenters, workshop, factory. Write for catalog "DA."

"IT'S GOOD BUSINESS
TO HIRE THE HANDICAPPED."
ISN'T THAT A GREAT IDEA, SNOOPY?



THE PRESIDENT'S COMMITTEE ON EMPLOYMENT
OF THE HANDICAPPED, WASHINGTON, D. C.

ORDER BY STOCK NUMBER • OPEN ACCOUNT TO RATED FIRMS • MONEY-BACK GUARANTEE
EDMUND SCIENTIFIC CO. 300 EDCORP BUILDING
BARRINGTON, NEW JERSEY 08007

INFORMATION RETRIEVAL NUMBER 37

INFORMATION RETRIEVAL NUMBER 237 ►



TTL/MOS/DTL INTERFACES

Some of our low-voltage MOS integrated circuits couple directly to TTL or DTL logic circuits, some take a resistor or two. Voltage translators and special buffers are not needed because the data-input stages are designed to accept relatively small changes in signal voltages as well as large MOS-style swings.

Interfaces like Figures 1a and 1b do nicely in most applications. Devices with active pullup and pulldown output stages don't even need a current-sinking resistor (Figure 1b). An input pullup resistor can be used on the shift registers (MM506, MM510 and their cousins) in high-performance applications. We've clocked them at twice the normal MOS rate with the Figure 1c interface.

A pullup resistor is required by some of our larger-scale devices, particularly those containing a lot of logic and memory on the same chip. The MM521 read-only memory in Figure 1d is one of these. But considering that the MM521 stores 256 4-bit words and can replace an entire TTL assembly, we think that a few resistors is a small price to pay.

What makes our MOS circuits so compatible? Design improvements based on better MOS processes, of course. The National Semiconductor process lowers the voltage threshold to about 2V, allowing small transitions in the data signals to be handled reliably. TTL and DTL transitions are usually 4V or less, while conventional MOS circuits demand a change of at least 7V. Some look for transitions as great as 18V.

Note, however, that the biases on the shift registers in Figure 1 are positive and negative, a la regular MOS. Although low-voltage elements are used in the input stages, they are designed with ample overdrive to establish proper MOS logic levels for the following stages' storage and switching elements. In fact, any number of our low-voltage MOS circuits can be placed in cascade between two TTL or DTL gates as long as MOS/MOS coupling specifications are met within the string.

You can usually disregard what has been the normal limits on our MOS inputs. Data levels can be as low as $V_{SS}-2.5V$ for an MOS "0" bit and $V_{SS}-4.2V$ for a "1". If V_{SS} , the MOS substrate voltage, is picked off the +5V supply used for TTL V_{CC} , logic levels of 2.5 and 0.4V are acceptable to low-voltage MOS inputs. They'll work even during worst-case $V_{CC} \pm 5\%$ and gate-loading conditions with an input resistor to V_{CC} .

At the output interface, different conditions must be satisfied (they can be calculated with the equations in Table 1). To drive a TTL gate, the MOS output stage must sink 1.6mA of current and allow the signals to go more positive than +2.4V and more negative than +0.4V. Some designs require an external resistor to provide the negative current path, but devices with output stages like the MM510 do not. The latter design has proven itself in numerous applications, so we are using it in all appropriate new products. Either one meets the voltage spec.

Fanout is normally one, but this can often be improved by trade-offs between V_{SS} and V^- . The voltage transitions for the clock signals (ϕ_1 and ϕ_2) will have the same amplitude as specified for our MOS assemblies, but the levels should be shifted to correspond to V_{SS} . During the logic "0" clock intervals, the clock should be within 1.5V of V_{SS} .

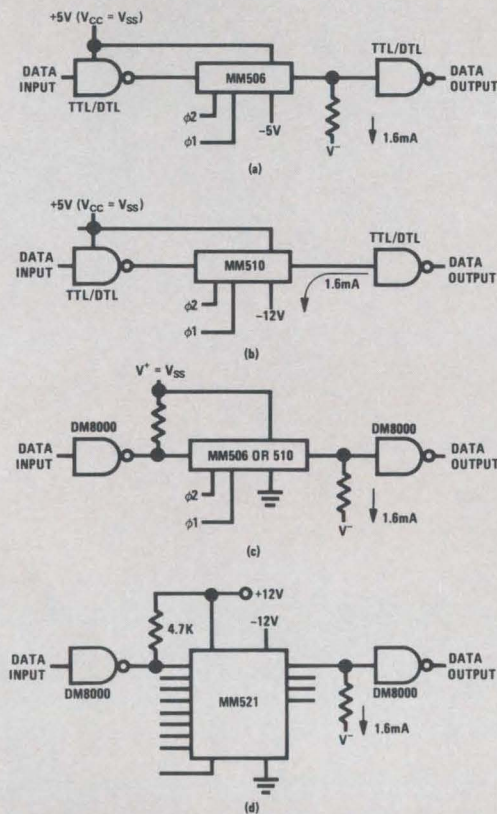

FIGURE 1. Typical TTL/MOS or DTL/MOS Interfaces.

MOS BRIEF 7 TTL/MOS/DTL INTERFACES Write: National Semiconductor Corp., 2975 San Tostito Way, Santa Clara, California 95051

TTL/MOS/DTL interfaces

MOS BRIEF 7

When V_{SS} is the same as V_{CC} , it doesn't make much difference what types of TTL or DTL gates are used as signal sources and receivers. But be sure the gate can withstand its output being pulled up if V_{SS} is higher. That's why we recommend our DM8000 gates in Figures 1c and 1d. Even though its specifications read like a conventional TTL gate's, the DM8000 can be pulled as high as +14V without breakdown (a similar quad 2-input gate circuit, the DM8810, is specified for high breakdown voltages). The DM8000 is protected by a reverse-biased diode in the emitter-follower active-pullup string and a base-to-emitter resistor biases off the output-sinking transistor (see Figure 2). Also, the DM8000 has no trouble sinking the current required for an MOS input at the +0.4V level. It can handle 16 mA.

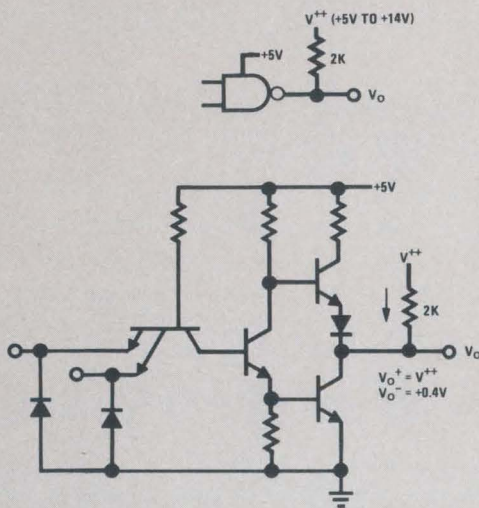

FIGURE 2. DM8000 Output Pullup Technique.

Another handy feature of these DTL or TTL/MOS/TTL interfaces is that there are no logic inversions through the interfaces. Of course, the MOS stages in an application like Figure 3 see each

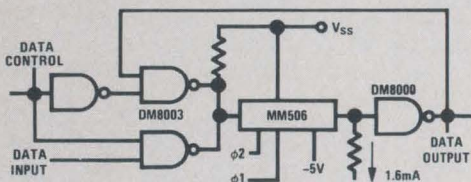

FIGURE 3. Recirculating MOS Delay Line with TTL or DTL Control.

TTL "1" bit as an "0" and vice-versa. But that's of no concern to the rest of the system. Nor need it bother the logician. Furthermore, when there are several MOS circuits between interfaces, TTL data can be taken off the MOS signal connections providing the loads do not severely degrade the MOS logic levels. Don't try this with conventional MOS, though.

Both the 5V and 12V techniques shown reduce interfacing costs to a minimum. Inserting MOS devices into an otherwise TTL or DTL system can lower the cost per bit significantly when the application calls for shift registers, small memories and similar functions. Both methods are equally convenient, since neither requires an additional power-supply connection. Most systems contain 5V and 12V supplies for other purposes. So the choice depends on the voltages that are most compatible with the rest of the system and performance factors such as the operating frequency desired.

Detailed information on low-voltage MOS devices and instructions on clocking and other auxiliary circuits can be found in National Semiconductor literature.

Table 1. Output Conditions

In MOS logic "0" state:

$$\frac{V_{SS} - 2.4V}{Z_o} \geq \frac{2.4V - V^-}{R_o}$$

In MOS logic "1" state:

$$I_1 \leq \frac{0.4V - V^-}{R_o}$$

Definitions:

- I_1 = Current through R_o at $V_o = +0.4V$ (1.6 mA)
- R_o = Output resistor (internal or external)
- Z_o = MOS output impedance
- V^- = Supply sinking negative current
- V_{SS} = Most positive voltage
- V_{DD} = MOS drain voltage

National Semiconductor Corporation

2975 San Ysidro Way, Santa Clara, California 95051
(408) 245-4320/TWX (910) 339-9240



Find a great job in the privacy of your own home.

If you're an engineer, scientist, computer professional or accountant our computer will get the jobs to you without your getting out to look for them. And our computerized file lets you choose from over 16,000 positions, developed by our 56 nationwide affiliated placement agencies.

Just fill out this form at home and send it to us along with your latest resume. Naturally there's never any fee with NMR. And we only release your identity if we have your OK. Why no one even has to know you're looking.

NMR Computer Input Form

Return this with a copy of your resume if you have one.

For Office Use Only

--	--	--	--	--	--

Electronic Design, Aug.

Name _____ Date _____

Address _____ City _____ State _____ Zip _____

Home Phone _____ Business Phone _____
(include area code) (if ok to use)

Position Desired:

Geographical Preference:

I will consider opportunities in the: Northeast Mid Atlantic Any location I prefer: Metropolitan area I will NOT relocate
 Midwest South Southwest Calif. Northwest Medium town Rural area

Availability:

Actively seeking
Date available _____

Just shopping

Identity Release:

My identity may be released to:

All but present employer
 No employer

Education

Degrees _____ Major field _____ Year Earned _____ College or University _____

Present or Most Recent Position

Employer _____ City/State _____

From _____ Title _____ Duties & Accomplishments _____

To _____

Previous Position

Employer _____ City/State _____

From _____ Title _____ Duties & Accomplishments _____

To _____

Previous Position

Employer _____ City/State _____

From _____ Title _____ Duties & Accomplishments _____

To _____

General Information

(Summarize your overall qualifications and experience in your field. List any pertinent information not included above.)

Current Annual Base Salary _____ Total Years of Experience _____ U.S. Citizen Yes No Level of Security Clearance: _____ Presently Employed Yes No

National Manpower Register, 635 Madison Avenue, New York, N.Y. 10022



INFORMATION RETRIEVAL NUMBER 901

Wichers

Managerial sensitivity training works, 'alumni' say, as they rate Leadership Workshop program a month after 'graduation day.'

Richard L. Turmail, Management & Careers Editor,

Second of two articles

How do you feel about the sensitivity training program you completed?

"I had a ball."

"I feel indignant about it."

"We worked like hell."

"I didn't know I was such a bastard!"

"I have more confidence now."

"Wait till you get there."

As this sampling of comments suggests, a wide range of opinion about management sensitivity training programs exists among former participants. The remarks above are by "graduates" of one of those programs, called "Leadership Workshop." It is a two-phase program for supervisors, managers and executives, designed by Leadership Development Associates (LDA) of Westwood, N.J., and conducted by two industrial psychologists, Kenneth H. Recknagel, president of LDA, and Jerry Judd, senior associate. The two phases of the program are called "Self-Development" and "Management Interaction."

Four weeks ago I participated in the Self-Development phase with eight other managers. I was assigned to a workshop at secluded Mount Hope Farm, Williamstown, Mass. For five days, without interruptions, we saw ourselves as others see us as we assessed our own behavior, examined our boss's written assessment of us and, finally, assessed the behavior of one another. On the last day of the workshop we were guided by our instructor to formulate a plan for self-improvement on the job.

Only as good as the follow-up

The purpose of a program like this, according to LDA, is to secure a constructive appraisal of the individual's leadership skills and the impact his behavior and attitudes have on others, so that he can become more effective on the job. But for the program to be completely effective, especially for those who have a number of behavioral adjustments to make, what follows the

workshop assumes paramount importance.

The follow-up recommended by LDA calls for the workshop grad and his boss to confer immediately to discuss his training experiences. It's recommended that the boss do a good job of listening to his employe, as well as openly sharing his own feelings, opinions and suggestions. Only through the boss's efforts to identify his man's improvement goals, and to discuss his plans with him, LDA says, can his experiences be converted into long-term improvements. Only then can he help his employe work out a realistic plan for personal development and career advancement.

What our survey says

To determine the effectiveness of the LDA approach, I recently asked the eight managers who were in my workshop four weeks ago how they rated the effectiveness of the program today. My survey turned up the following points of interest:

- The program gave six of the participants insights into behavioral blind spots that they had. The other two participants said the opinion they held of their having "negative" behavior was verified at the program.

- At the conclusion of the workshop, five participants were "enthusiastic" about the program; two were "satisfied;" one was "satisfied and confused." One month later, six are "enthusiastic" about the program; one is "satisfied;" one is "very enthusiastic."

- Seven members of the group said that the program had helped to make them more effective on the job. One said it was too early to tell. Those who believed they were more effective at work said it was because they had been able to improve personal communication with superiors, peers and subordinates—mainly because they're

(Continued on p. 102)

The LDA graduate, with an assist from his boss, should give himself an objective look to see if he can change any negative behavior that could jeopardize his future on the job.

CAREER
REFLECTIONS



Feedback from the 'graduates'...

Feedback Sheet & Analysis		Frank (Research Engineer)	Charles (Shop Foreman)	Ray (Personnel)
Opinions at conclusion of program	Examine feedback you have received (boss-group).	eye-opening; stunned for a week by negative feedback	not surprised; need more education	my defensive barriers aren't as good as I thought
	Select the critical attitudes cited that you accept as belonging to you.	non-aggressive, uncommitted, not critical enough	non-participatory, stubborn	self-centered, superiority image
	When were you aware of these attitudes? What sparks behavior?	at program lack of self confidence	at program quiet among strangers	after marriage need to be accepted and recognized
	What could you do to adjust this attitude?	experiment vs. practice; help from wife & boss	learn that others are important	put the needs of others first
	How do you feel about the program? enthusiastic—satisfactory—confused	enthusiastic	satisfied	enthusiastic
	In what ways did you find the course helpful to you?	opened my eyes to personal problems	helped me communicate—don't let lack of education stand in way	meaningful introspection was accomplished
	Identify any features of the program which got in the way of your learning?	prior warped anticipation	none	none of a serious nature
	Would you recommend this course to your company, associates or friends?	yes	yes	yes
Current opinions of program	How do you feel about the LDA program now?	enthusiastic	enthusiastic	satisfied
	Has LDA training helped you be more effective on the job?	yes; I have implemented changes in behavior—am now more critical of subordinates; now getting better results	yes; communications with peers and subordinates have improved	too early to tell
	Has the program been harmful to you in any way?	no	no	no
	Would you recommend the program to our readership?	yes	yes	yes
	What was the outcome of the conference with your boss after the program?	much better understanding between us—knowing why I impressed him the way I did makes me understand his reactions	have not talked to him in detail	we jointly recommended the program for our company

Arthur (Systems Analyst)	Sid (Accountant)	Jim (Chief Engineer)	Lon (Packaging Engineer)	Paul (Research Physicist)
verified my fears about my negative attitudes	shed light on behavioral blind spots	shed light on blind spots, some surprises	accurate	paradox between what I thought and what I learned
defensive, vague	narrow-minded	ruthless, conscious of youth	lack confidence, not critical enough	nauseatingly precise
at program self-centered	at program don't know	at program youth in high position	knew them not confident	at program personality conflicts
take advice; think of audience	have to think about it	listen to others	take speaking and writing courses	people-oriented file to keep current
enthusiastic	enthusiastic	enthusiastic	satisfied	satisfied and confused
exposure to others; feedback highlighted previous blind spots	a reassessment of my standards and values is required	exposure to behavior patterns that could have affected my career adversely	verified understanding of myself; brought other attitudes to my attention	threw light into behavioral blind spots
none	lack of communication on my part got in the way of my learning	long hours at times produced tired-type boredom	instructor should keep group more on course	too much BS tolerated; should have been cut off more often
yes	yes	yes—with reservations; would not recommend for emotionally unstable person	yes	yes—with reservations; would not recommend for emotionally unstable person
enthusiastic	enthusiastic	enthusiastic	enthusiastic	very enthusiastic
yes; have improved communications wjth peers and superiors	yes; have decided not to leave job—am working out misunderstanding with boss	yes; I am more tolerant of the opinions of others now that I know I was ignoring peoples' ideas	yes; I've picked up more confidence, because I found out I lacked it at the program	yes; I'm more sensitive to needs of others
no	no	no	no	no
yes	yes	yes	yes	yes—with reservations; would not recommend for emotionally unstable person
better understanding between us because I try to communicate better	my boss is going to take the program	better understanding between us—got to know boss better	better relationship	went on long business trip together

Personnel man critiques the LDA program

The following report of the strengths and weaknesses of the "Leadership Workshop" program conducted by Leadership Development Associates of Westwood, N.J., was prepared by Ray, a personnel recruiter. He submitted the findings to his company two weeks after he had participated in the training program.

Strengths

■ *High degree of professionalism*—There are many amateurs in the sensitivity game, and some of them do a great deal of harm. LDA is run by two experienced people, Kenneth Recknagel and Jerry Judd. They can add much insight to our understanding of our company's management personnel.

■ *Greater personal awareness*—This was the strongest asset of the program. Although no one in the development group gained a great deal of new knowledge about himself, he did become more aware of how his behavior affects others in both a positive and negative way. From this experience, he can adjust his behavior enough to effect a more positive attitude and response in relating to others.

■ *A complete, semi-structured program*—The objectives of the week were reasonable and obtainable. I was able to see progress towards results in a relatively short period of time. I had the feeling that an invisible hand was guiding the ship but that the group members always had options to change the course to suit their own particular needs.

■ *Constructive criticism*—An attitude of helpfulness to the individual prevailed throughout the week, mainly due to the subtle guidance and influence of the instructor. This atmosphere helped each person to be frank and open and not to fear the others in the group.

■ *Effectiveness of group identity*—I became

much more aware of the power to achieve positive results by way of group motivation and participation. This development group approach gives a person more confidence in using the team approach when he learns to effect "cohesiveness." The individual learns not to fear the sharing of ideas and opinions. Once he experiences group interaction that projects identity and support, he will be more receptive to suggestions from groups he may supervise. This approach could build morale in our company.

Weaknesses

■ *A lack of direction and control*—It seemed at times that not enough professional control was exercised, that the group dominated the direction and effectiveness, not always to its own good. However, this did not seriously impede the group's progress.

■ *Clarification of course objectives needed*—Companies sent people to the program for a variety of reasons. Perhaps course objectives should be more thoroughly spelled out. At this point I'm not certain of my reasons for suggesting who should attend, but some clear-cut objectives should be reached as to what we would hope each person would gain from attending.

■ *More time for needed goal-setting*—This is a very important aspect of the week, but not enough time is devoted to it. This could be a major part of the man's follow-up on the job.

If more time is allotted for career planning, then, generally speaking, the week is well worth the cost and time, especially for persons who have spent little time in introspection and self-study.

now more aware of how they're coming across after being assessed at the program.

■ Seven group members reported that a better understanding existed between themselves and their boss. (One man has not yet talked to his boss about the program.) The basic reason for the improved relationships, the members said, was their efforts to turn negative attitudes that were uncovered at the workshop into positive ones. One man's boss is going to participate in the workshop himself; another boss took a 20,000-mile business trip with his employe, in part to help establish a better working relationship with him.

■ None of the participants thought the program was harmful to himself. All recommended

its use in industry, with two having the same reservation—that of not recommending it for any person who is emotionally unstable and who might be harmed by too much negative feedback. Two participants also thought that people who know themselves well, and communicate well, would not really benefit too much from the program.

My fellow LDA alumni—six of them engineers—have been open-minded and extremely accurate in their assessment of themselves. On the last day of the workshop, our instructor told us that as a group our hallmark was "conscientiousness." That attribute, the expert guidance of our instructor and the LDA approach made our training week a beneficial one for all concerned. ■■

RELAYS

NEW MIL-R-6106

- One-Inch Cube
- 4PDT-10 Amps
- 28VDC-115VAC
- All Welded

IT'S BABCOCK'S BR30

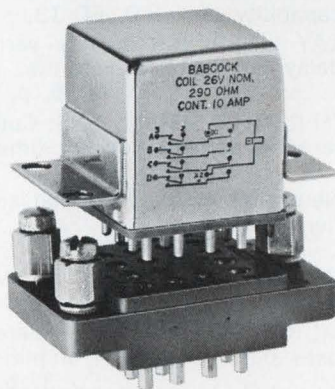

Babcock's new Model BR30 is a miniature, all-welded, 4PDT relay . . . designed specifically to meet the requirements of MIL-R-6106 (MS-27400)—and to be completely interchangeable with other models of this type. Characterized by reliable op-

eration in environmental extremes, this new relay is the first developed by Babcock to meet the needs of airframe applications. Performance is outstanding . . . to 200g's shock, 30g's vibration, over a temperature range of -70°C to $+125^{\circ}\text{C}$, for a minimum of 100,000 operations. All-welded construction, inside and out, assures a contaminant-free unit. Plug-in and solder-hook versions are offered; qualified relay sockets also available.

The Model BR30 is a new relay for new applications . . . and it carries the same mark of proven Babcock dependability. Your assurance that it's better because it's Babcock.

The Babcock Model BR30 is a brand new MIL-R-6106 relay . . . featuring a new symmetrical magnetic circuit. Utilizing two permanent magnets, this system provides a positive holding force, undisturbed by shock and vibration extremes . . . and

dependable switching action throughout the life of the relay.

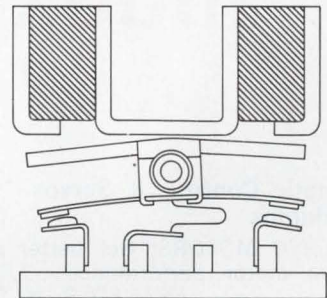

Coil design has also undergone some innovation. AC versions have been fabricated such that coil frequency is operational from 60 Hz to 400Hz, without degradation of ratings.

SPECIFICATIONS

Contact Rating (@ 28VDC, 115/208VAC 400Hz)-----	Resistive: 10amps. Inductive: 8amps.
Overload-----	D.C. 40amps. A.C. 60amps.
Rupture-----	D.C. 50amps. A.C. 80amps.
Coil Voltages-----	6, 12 and 28VDC, 115VAC
Shock-----	200g's (6ms.)
Vibration-----	30g's, 70-3000Hz
Operation Temp.-----	-70°C to $+125^{\circ}\text{C}$
Pull-In Power-----	600mw
Operate/Release Time-----	15ms, max.
Bounce Time-----	1ms, max.
Life-----	100,000 operation, min.

Get complete information on the new Model BR30 . . . contact Babcock Electronics Corp., Relays Division, Subsidiary of Esterline Corp., 3501 Harbor Blvd., Costa Mesa, Calif. 92626. CALL COLLECT (714) 540-1234 or TWX 910-595-1517.

Challenging opportunities for relay-switch engineers.



ELECTRONIC DESIGN

semiannual

index of articles

The articles in the various sections of this index are grouped under key words that indicate their general topics. Articles are listed more than once if they have to do with more than one general topic.

Automatic Controls & Servos 54 columns

- DC SERVO MOTORS: Get better dc servo motor performance. ART, ED 8, p. 88
- DIGITAL CONTROLLERS: Sectionalize your digital controller. ART, ED 1, p. 82
- RF DESIGN: Build stable rf servo loops. ART, ED 6, p. 216
- Keep your rf power level constant. ART, ED 5, p. 60

Avionics 12 columns

- AIR FORCE COMPUTER uses LSI arrays. NEWS, ED 8, p. 22
- BLIND-LANDING SYSTEM sold — after 14 years. NEWS, ED 4, p. 21
- IC CIRCUITS emerging for military avionics. IEEE, ED 6, p. U110
- FIGHTER PLANES: F-15A contenders cut from 4 to 3 companies. NEWS, ED 2, p. 22
- LANDING AIDS: Airlines seek visual enhancement systems. NEWS, ED 12, p. 21
- RADAR BEACON monitors 128 planes at a time. NEWS, ED 1, p. 32
- SUPERSONIC TRANSPORT: Seeks SST support. NEWS, ED 1, p. 22
- The Soviet hops off to a fast SST lead. NEWS, ED 2, p. 21

Circuits 276 columns

- A/D CONVERSION: Fast a/d converter provides parallel-digital output. IFD, ED 9, p. 74
- AMPLIFIERS: Inexpensive circuit boosts op amp output current. IFD, ED 5, p. 92
- Low-noise, gain-stable amplifier

- uses only five components. IFD, ED 6, p. 250
- BANDPASS FILTER has independent gain and selectivity controls. IFD, ED 4, p. 126
- BIAS CIRCUITS: Design bias circuits with nomographs. ART, ED 9, p. 66
- BISTABLE CIRCUIT: Reliable bistable circuit uses only 4 inexpensive components. IFD, ED 2, p. 76
- BROADBAND COMPENSATION: Network provides broadband input-capacity compensation. IFD, ED 5, p. 94
- COMPARATORS: $A > B$ or $B \geq A$ comparator uses adder carry logic. IFD, ED 13, p. 92
- CONSTANT-CURRENT source is stable and inexpensive. IFD, ED 6, p. 254
- CONTACT BOUNCE: Simple circuit eliminates switch contact bounce. IFD, ED 2, p. 82
- CONVERTERS: Circuit converts two analog quantities to frequency or period. IFD, ED 6, p. 258
- Technique simplifies strobing of BCD-to-decimal converters. IFD, ED 13, p. 93
- COUNTERS AND DIVIDERS: Build versatile counters with D-type flip-flops. IFD, ED 13, p. 87

- Divide by 3 or 4. . . or 2, 3 or 4. . . all with little hardware. IFD, ED 13, p. 85
- Up/down counter uses minimum interconnect wiring. IFD, ED 13, p. 86
- CURRENT REGULATOR: Efficient current regulator uses IC differential amplifier. IFD, ED 6, p. 270
- CURRENT SOURCE: Simple and inexpensive current source has $\pm 0.1\%$ regulation. IFD, ED 8, p. 106
- CROWBAR CIRCUITS: Power supply crowbar can be adjusted precisely. IFD, ED 12, p. 122
- DC LIMITER regulates voltage to high-current, low-voltage circuits. IFD, ED 10, p. 136
- DC VOLTAGE TRANSLATOR has wide capability. IFD, ED 13, p. 93
- DELAY LINES: ICs provide variable delay for digital waveforms. IFD, ED 6, p. 274
- DIFFERENTIAL AMPLIFIERS: Cut differential-amplifier design time. ART, ED 10, p. 114
- Neutralize your differential amplifier with diodes. IFD, ED 10, p. 132
- DUAL-AMPLIFIER chip is MOS-bipolar IC. PF, ED 2, p. 105
- DUAL OP AMP: Signal-level detector uses dual operational amplifier. IFD, ED 3, p. 78
- ELECTRONIC TUNING: Series control technique cuts tuning power requirements. IFD, ED 12, p. 122
- EMITTER FOLLOWERS: Get emitter-follower action without input/output level shift. IFD, ED 11, p. 102
- FEEDBACK TECHNIQUE dynamically resonates tuned circuit. IFD, ED 2, p. 76
- FETs: Select the right FET. ART, ED 6, p. 194
- FILTER RIPPLE: TV-camera vertical

Departments Key

- | | |
|------|-------------------|
| ART | Technical Article |
| EDIT | Editorial |
| IFD | Idea for Design |
| PF | Product Feature |
| SR | Special Report |

sweep produced by filter ripple... IFD, ED 3, p. 72

FLASHER: SCR relaxation flasher has long life, low power drain... IFD, ED 5, p. 96

INPUT IMPEDANCE: Simple technique measures op amp input impedance... IFD, ED 6, p. 262

J-FET AND GATE provide delay followed by reset signal... IFD, ED 8, p. 104

LAMP DRIVER: Circuit powers neon lamps from low-voltage sources... IFD, ED 10, p. 136

LAMP SEQUENCING: SCRs provide mutually exclusive lamp-sequencing... IFD, ED 2, p. 84

LEVEL CONVERTER: Positive-to-negative logic level converter uses simple IC... IFD, ED 7, p. 90

LINE DRIVER: Compact line driver has high speed and high fan-out... IFD, ED 13, p. 91

LINE EQUALIZER uses active RC network... IFD, ED 3, p. 74

LOAD CURRENT CONTROL: Parallel-connected zener diodes answer load-current problems... IFD, ED 4, p. 128

MICROWAVE SWITCHING: Don't waste drive power... ART, ED 13, p. 106

MILLIWATT AC REGULATOR uses low-cost components... IFD, ED 2, p. 82

MULTICHANNEL CRYSTAL OSCILLATOR can be digitally programmed... IFD, ED 13, p. 94

MULTIVIBRATORS: Constant-frequency multivibrator has variable duty cycle... IFD, ED 11, p. 104

Get the best one-shot for your money... ART, ED 4, p. 96

Get wide-range or VCO capability from the basic astable multi... IFD, ED 6, p. 272

Photo-FETs make multivibrator respond to incident light... IFD, ED 6, p. 279

Voltage-controlled monostable uses IC comparator... IFD, ED 6, p. 250

Unusual astable multivibrator generates unusual waveforms... IFD, ED 1, p. 128

NOTCH NETWORKS: Design notch networks the easy way... ART, ED 6, p. 210

OP AMPS: Stabilize your op amp experimentally... ART, ED 9, p. 50

Simplify op-amp parameter tests... ART, ED 11, p. 80

OSCILLATOR: IC op amp simplifies design of crystal-controlled oscillator... IFD, ED 1, p. 124

Oscillator circuit measures small capacitance changes... IFD, ED 8, p. 102

PEAK-SENSING CIRCUIT measures a-m modulation directly... IFD, ED 6, p. 268

PHASE DETECTOR: High-gain detector circuit uses no transformers... IFD, ED 11, p. 102

PHASE SHIFTER: 360° video phase shifter uses no transformers... IFD, ED 6, p. 254

POWER SUPPLY FILTERS: Go graphic with capacitive input filters... ART, ED 12, p. 106

PRIORITY ENCODER: Ripple-through priority encoder is simple and inexpensive... IFD, ED 6, p. 278

PROTECTION: Low-cost circuit can protect a boardful of high cost ICs... IFD, ED 10, p. 138

Over-voltage protection circuit can prevent instrument damage... IFD, ED 11, p. 110

PULSE DIFFERENTIATOR has very narrow output... IFD, ED 2, p. 84

PULSE SHAPING OR GENERATION: Astable multivibrator is fast and reliable... IFD, ED 13, p. 83

Circuit generates linear ramp and short duty cycle pulses... IFD, ED 10, p. 134

Keyed multivibrator produces ac output with no dc level shift... IFD, ED 13, p. 84

Schmitt trigger self-adjusts to provide symmetric output... IFD, ED 13, p. 82

Switch closure produces a fixed-duration output pulse... IFD, ED 3, p. 72

Standard TTLs yield one-shot that is variable two ways... IFD, ED 6, p. 262

TTL clock pulse generator uses only one capacitor... IFD, ED 13, p. 84

RAMP GENERATOR: Circuit generates linear ramp and short duty cycle pulses... IFD, ED 10, p. 134

RF AMPLIFIERS: Design and match rf amplifiers... ART, ED 10, p. 106

SELF-SWITCHING STAGES: Self-switching of active devices improves performance... IFD, ED 2, p. 78

SHUNT REGULATOR: Circuit provides protection for shunt-type voltage regulator... IFD, ED 6, p. 268

SQUARE-WAVE GENERATORS: 2-MHz square-wave generator uses two TTL gates... IFD, ED 12, p. 126

SQUARE WAVES: Simple circuit 'tags' beginning and end of square-wave signals... IFD, ED 8, p. 100

STAIRCASE-WAVE GENERATOR uses integrated circuits... IFD, ED 8, p. 100

SWITCHES: Two wires transmit and identify remote switch closures... IFD, ED 5, p. 98

SWITCHING AND CONTROL: Circuit extracts single pulses from clock of pulse train... IFD, ED 13, p. 79

Get repetitive switch closures from inexpensive multivibrator... IFD, ED 13, p. 80

IC voltage switch is digitally activated... IFD, ED 13, p. 81

Modified one-shot has pulse-width range >100:1

... IFD, ED 13, p. 80

One-shot stays triggered until end of pulse train... IFD, ED 13, p. 79

Simplify turn-on initialization of digital systems... IFD, ED 13, p. 78

180-Hz synchronous switch drives two loads alternately... IFD, ED 9, p. 76

TEST CIRCUIT: Checks heaters for shorts while protecting fuses... IFD, ED 6, p. 266

THRESHOLD SENSORS: Sense signal levels with a tunnel diode... ART, ED 3, p. 48

TIMING: Artificial delay line is inexpensive and small... IFD, ED 13, p. 89

Simple oscillator can be keyed precisely... IFD, ED 13, p. 89

Standard MOS NOR gate serves as 100-kHz clock... IFD, ED 13, p. 90

One-shot has independent input and output pulse widths... IFD, ED 13, p. 88

TIMING CIRCUIT has many uses; like windshield wiper control... IFD, ED 8, p. 100

TRAP FILTERS: Specify your trap filter the easy way... ART, ED 9, p. 58

TRIGGER CIRCUITS: Complementary "Schmitt" trigger has zero output-offset voltage... IFD, ED 3, p. 80

Triggered sawtooth generator has constant amplitude... IFD, ED 4, p. 128

TRIGGER PULSES: Circuit provides IC trigger pulses on contact closure... IFD, ED 1, p. 126

TTL GATES: Linearize your TTL gates—then build useful circuits with them... IFD, ED 5, p. 88

VOLTAGE REGULATORS: Choose regulator op amps with care... ART, ED 13, p. 98

VOLTAGE VARIABLE CAPACITORS: Two VVCs are often better than one if they're back-to-back... IFD, ED 10, p. 130

TRIANGULAR WAVEFORM GENERATOR uses complementary transistors... IFD, ED 11, p. 106

VACUUM PENCIL: Ball-point pen converts to a vacuum pencil for IC handling... IFD, ED 6, p. 264

ZERO CROSSING: Circuit detects zero crossings of full-wave rectified ac... IFD, ED 6, p. 260

ZEROS CATCHER senses presence of logical ZERO inputs... IFD, ED 13, p. 91

Circuit Theory and Analysis
243 columns

AMPLIFIERS: Build broadband rf power amplifiers... ART, ED 2, p. 50

Design wideband uhf power amplifiers... ART, ED 11, p. 72

FETs: FET detector rectifies extremely small signals. IFD, ED 7, p. 86
 Op amp FET input circuitry ups bandwidth and speed. PF, ED 7, p. 128
 Try this linear FET model with ECAP. ART, ED 8, p. 82

FERRITE BEADS: Don't experiment with ferrite beads . . . design with them. ART, ED 12, p. 100

LOG DIODES can simplify design. ART ED 12, p. 58

LOSS CALCULATIONS, Simplify your loss calculations. ART, ED 8, p. 94

MOS REGISTERS: Shrink delay line costs with MOS—ART, ED 5, p. 50

NETWORK ANALYSIS: Speed network analysis with topology. ART, ED 7, p. 56

NOISE PROBLEMS: Stop noise problems before they start. ART, ED 1, p. 90

ONE-SHOT: Get the facts on one-shot design. ART, ED 2, p. 70

OP AMPS: Stabilize your op amp experimentally. ART, ED 9, p. 50

PHASELOCK LOOPS: Build a better frequency comparator. ART, ED 3, p. 54

PHOTODEVICES: Photodevices have you in the dark? ART, ED 3, p. 60

PULSE GENERATOR: Single SCR forms a simple, dual-polarity pulse generator. IFD, ED 1, p. 124

RADIATION EFFECTS: Will radiation wreck your IC design? ART, ED 4, p. 78

RESISTIVE SUMMING NETWORK: Generalized analysis simplifies resistor summing network design. IFD, ED 6, p. 276

RF DESIGN: Build stable rf servo loops. ART, ED 6, p. 216
 Keep your rf power level constant. ART, ED 5, p. 60

SCRs: There are many ways to fire an SCR. ART, ED 6, p. 234
 Use—don't abuse—the SCR. ART, ED 5, p. 76

SWITCHING CIRCUITS: Tackle your switching circuit designs. ART, ED 7, p. 70

WORD GENERATOR: Build a programmable word generator. ART, ED 2, p. 62

Civil Systems 30 columns

CITIES: Cities call on engineers to help them. IEEE, ED 6, p. U84
 Technology providing aid to troubled cities. IEEE, ED 6, p. U113

RADAR BEACON monitors 128 planes at a time. NEWS, ED 1, p. 32

SEISMIC MONITORING: A growing role for 'earth-shaking' electronics. NEWS, ED 2, p. 37

URBAN TRANSPORTATION: Cities seeking ways to 'fly' on the ground. SR, ED 1, p. 68

Communications 88 columns

ACOUSTIC COUPLER: Build your own acoustic coupler. ART, ED 5, p. 68

APOLLO 8 electronics systems are go, go, go. NEWS, ED 2, p. 30

COMMUNICATIONS PROBLEMS: Many problems confront data engineers. SR, ED 9, p. C14

DATA SYSTEMS emerging fast from infancy. SR, ED 9, p. C4

DIGITAL TRANSMISSION: Why digital transmission? SR, ED 9, p. C6
 ICs simplify solutions in data transmission. IEEE, ED 6, p. U100

FEDERAL AGENCIES: Task Force urges new communications 'look'. NEWS, ED 1, p. 21

GLOBAL NETWORK: The 99.9% effective communications system. SR, ED 9, p. C28

PHASELOCK LOOPS: Build a better frequency comparator. ART, ED 3, p. 54

RF LOG DETECTORS: Two-stage rf log detectors cover 40-MHz video band. PF, ED 5, p. 104

SATELLITES: Defense satellite communications pressed. NEWS, ED 7, p. 21
 Military moving to cure communications "fluke". NEWS, ED 13, p. 21
 Russians will attend Intelsat meeting in U.S. NEWS, ED 4, p. 21

TIME DIVISION MULTIPLEX with standard TTL logic gates. IFD, ED 7, p. 88

Components 68 columns

AMORPHOUS SEMICONDUCTOR: Zowie? or zilch? NEWS, ED 13, p. 25

CAPACITOR designs aim for IC compatibility. NEWS, ED 12, p. 32
 Diodes improve 'de-polarization' of polarized capacitors. IFD, ED 11, p. 104

CERMET TRIMMERS: Low-cost trimmer pots are industrial cermets. PF, ED 10, p. 150

COMPONENT FIRMS urged to expand markets. NEWS, ED 11, p. 22

CONNECTORS: Make simple connectors from transistor sockets. IFD, ED 4, p. 130

FERRITE BEADS: Don't experiment with ferrite beads. . . design with them. ART, ED 12, p. 100

HIGH-PERFORMANCE FILTERS and delay lines reflect true state-of-the-art advances. PF, ED 13, p. 156

HYBRID CAPACITORS: Hybrid microstrip chips are low-loss capacitors. PF, ED 2, p. 116

ISOLATORS: Solid-state isolators couple optically. PF, ED 4, p. 152

MICROMINIATURE LAMPS have 0.05-in. di. PF, ED 4, p. 162

PLATED WIRE: Now—plated wire challenges cores. PF, ED 4, p. 136

POWER FILM RESISTORS circle out heat effects. PF, ED 12, p. 141

RADIATION-RESISTANT ICs are a growing market. NEWS, ED 6, p. 21

SCR relaxation flasher has long life, low power drain. IFD, ED 5, p. 96
 There are many ways to fire an SCR. ART, ED 6, p. 234
 Use—don't abuse—the SCR. ART, ED 5, p. 76

STEPPING MOTOR: High-power stepper boosts speed, torque. PF, ED 1, p. 162

UNDERSEA LAB: Designing for the explosive undersea depths. NEWS, ED 2, p. 25

Computer-Aided Design 73 columns

FET MODEL: Try this linear FET model with ECAP. ART, ED 8, p. 82

FILTERS: Get something extra in filter design. ART, ED 13, p. 114

GRAPHIC DISPLAY: Add graphic display to your computer. ART, ED 7, p. 64

MICROWAVE ICs: Computer design spurs microwave IC growth. NEWS, ED 13, p. 21

QUIKTRAN PROGRAMS: Design and match rf amplifiers. ART, ED 10, p. 106

TRANSFORM SOLUTIONS: Speed inverse Laplace transform solutions. ART, ED 6, p. 240

TRAP FILTERS: Specify your trap filter the easy way. ART, ED 9, p. 58

Computers and Data Processing 230 columns

ACOUSTIC COUPLER: Build your own acoustic coupler. ART, ED 5, p. 68

A/D CONVERSION TECHNIQUES: Automatic offset correction can boost a/d converter performance considerably. SR, ED 1, p. 104
 Some applications require unique conversion techniques or special hardware. SR, ED 1, p. 97
 Time-sharing saves hardware, but may result in lower over-all performance. SR, ED 1, p. 108

AIR FORCE COMPUTER uses LSI arrays. NEWS, ED 8, p. 22

CDC-7600: Making the world's fastest computer faster. NEWS, ED 1, p. 30

COAST GUARD RADAR: 'Bargain' electronics for the Coast Guard. NEWS, ED 1, p. 36

COMMUNICATIONS EQUIPMENT: Where the action is: Expansion in

3 areas... IEEE, ED 6, p. U102
 IBM gets into the telephone business... NEWS, ED 10, p. 21
COMMUNICATION PROBLEMS: Many problems confront data engineers... SR, ED 9, p. C14
COMPUTER CONFERENCE: Spring Joint Computer Conference Special Section... SR, ED 9, p. C1
COMPUTER NETWORK: A national computer network called feasible... NEWS ED 11, p. 21
COMPUTER TERMINAL displays graphics... PF, ED 2, p. 122
CONTROL CENTER: Computer to help run World Trade Center... NEWS, ED 11, p. 22
DATA SYSTEMS emerging fast from infancy... SR, ED 9, p. C4
DIGITAL COMPUTER: Small fast digital computer commands 72 instructions... PF-SR, ED 9, p. C40
DIGITAL TRANSMISSION: Why digital transmission? SR, ED 9, p. C6
ELECTRONIC CALCULATOR reduces size via LSI... PF, ED 8, p. 118
ENVIRONMENTAL ELECTRONICS: The friendly grey computer... NEWS, ED 6, p. 52
GLOBAL NETWORK: The 99.9% effective communications system... SR, ED 9, p. C28
GRAPHICS: The future in design by computer... NEWS, ED 6, p. 36
HOLOGRAPHIC DATA STORAGE: IBM tests holographic data storage... NEWS, ED 13, p. 52
IC CALCULATOR: Desk top IC calculator performs in milliseconds... IEEE, PF, ED 6, p. U152
INTERACTIVE COMPUTING: An hour's work with an interactive computing system... NEWS, ED 3, p. 32
 Man-computer 'Partnerships' explored... NEWS, ED 3, p. 25
 People and computers are getting together... NEWS, ED 1, p. 40
KEYBOARD RECORDER: Typewriter-to-tape system prepares computer data... PF, ED 7, p. 120
LARGE COMPUTERS: RCA decides to enter giant-computer field... NEWS, ED 6, p. 22
LAW SUITS: Computer industry girds for IBM-CDC 'battle'... NEWS, ED 1, p. 21
 IBM is sued again on trust-law charges... NEWS, ED 2, p. 21
LOGIC POWER SUPPLY drives 500 gates... IEEE, PF, ED 6, p. U174
LOGIC TEST SYSTEM: Computerized test setup checks any logic system... PF, ED 6, p. 290
LSI COMPUTER: Autonetics introduces small LSI computer... NEWS, ED 1, p. 21
MEMORIES: Now—plated wire challenges cores... PF, ED 4, p. 136
METER READING: Computer 'reads' utility meters 100 miles away... NEWS, ED 7, p. 22
MICROFILM SYSTEM: Computer microfilm system records computer data... PF-SR, ED 9, p. C42

MOS CALCULATOR: First U.S.-made LSI-MOS calculator introduced... NEWS, ED 10, p. 22
MOS REGISTERS: Shrink delay line costs with MOS... ART, ED 5, p. 50
PACKAGED LOGIC: Computer service turns logic into packages... NEWS, ED 4, p. 42
PARCEL POST: Computer unit will offer self-service parcel post... NEWS, ED 9, p. 22
PRICING: IBM's competitors await new software pricing... NEWS, ED 13, p. 22
PRIORITY ENCODER: Ripple-through priority encoder is simple and inexpensive... IFD, ED 6, p. 278
PROGRAMS: Bargain prices for used computer programs... NEWS, ED 2, p. 22
READ-ONLY MEMORIES: Slash ROM sizes with equivalent functions... ART, ED 4, p. 66
SOFTWARE: Honeywell takes aim at software services... NEWS, ED 4, p. 22
TERMINALS: Low-cost computer terminal tapes up to 10 characters/s... PF, ED 11 p. 114
WATER CONTROL: Computers to help run California water system... NEWS, ED 13, p. 22

Consumer Electronics
34 columns

COMPONENT FIRMS urged to expand markets... NEWS, ED 11, p. 22
EDUCATION: Classroom electronics still in groping stage... SR, ED 1, p. 64
FLASHER: SCR relaxation flasher has long life, low power drain... IFD, ED 5, p. 96
IGNITION SYSTEMS: Resonant charging technique simplifies ignition systems... IFD, ED 7, p. 82
SWIMMING POOLS: Electronics helps monitor swimming pool... NEWS, ED 7, p. 42
TIMING CIRCUIT has many uses; like windshield wiper control... IFD, ED 8, p. 100
TRANSISTORIZED TV: TV market swinging to solid-state designs... NEWS, ED 11, p. 22
TV CAMERA vertical sweep produced by filter ripple... IFD, ED 3, p. 72
URBAN TRANSPORTATION: Cities seeking ways to 'fly' on the ground... SR, ED 1, p. 68

Displays
21 columns

AIRCRAFT LANDING AIDS: Airlines seek visual enhancement systems... NEWS, ED 12, p. 21
AIR DEFENSE DISPLAY does more... NEWS, ED 5, p. 36
BUIC III: Air Force Takes over backup unit for Sage... NEWS, ED 3, p. 22

COMPUTER TERMINAL displays graphics... PF, ED 2, p. 122
DIGITAL PANEL METERS: Low-cost compact DPM programs from rear... PF, ED 12, p. 144
NEW CRT operates in bright sunlight... NEWS, ED 12, p. 22
RADAR SYSTEMS: Reduce radar display clutter... ART, ED 6, p. 204
SOLID-STATE: IC-compatible solid-state readout module puts light-emitting diodes in segmented array... PF, ED 13, p. 138

Editorials
26 columns

A fresh breeze of iconoclasm blows into the Pentagon... EDIT, ED 11, p. 69
 A plea for the human touch in information retrieval... EDIT, ED 1, p. 79
 Computers, like engineers, need to be managed... EDIT, ED 8, p. 45
 Death of an aquanaut poses touchy questions... EDIT, ED 6, p. 79
 End of the conflict of purpose in technological education... EDIT, ED 7, p. 53
 How broad is your concept of the engineer's job? EDIT, ED 9, p. 47
 It's the alumni's turn to demonstrate... EDIT, ED 12, p. 47
 Learn to manage yourself before trying it on others... EDIT, ED 13, p. 61
 Smart engineering, the European way... EDIT, ED 10, p. 71
 Take a tip from an old slogan: "The customer is always right"... EDIT, ED 2, p. 47
 Technology and politics: Better rapport needed... EDIT, ED 4, p. 63
 Technology may yet save this maddening world... EDIT, ED 5, p. 47
 Turnover is a fact of life: It's here to stay... EDIT, ED 3, p. 45

General Industry
119 columns

COLLINS-HONEYWELL MERGER is under negotiation... NEWS, ED 9, p. 22
COMPONENT FIRMS urged to expand markets... NEWS, ED 11, p. 22
COMPUTERS: IBM gets into the telephone business... NEWS, ED 10, p. 21
DEFENSE DEPT: A voice for electronics in the Defense Dept?... NEWS, ED 2, p. 21
FEDERAL BUDGET: U.S. 1970 budget raises spending for electronics... NEWS, ED 3, p. 21
FLAT-SCREEN TELEVISION: Two more contenders... NEWS, ED 8, p. 21
IC MARKET: Executive sees upswing in consumer IC market... NEWS, ED 3, p. 21
IC PROGRAM: Major IC program underway at GE?

NEWS, ED 4, p. 22

IEEE SHOW: It's another dazzling show, with the accent on peace... IEEE, ED 6, p. U83

Touring the Exhibit Area... IEEE, ED 6, p. U138

IMPORTS growing faster than exports, EIA finds... NEWS, ED 7, p. 21

LARGE COMPUTERS: RCA decides to enter giant-computer field... NEWS, ED 6, p. 22

LAW SUITS: IBM is used again on trust-law charges... NEWS, ED 2, p. 21

MARKETS: EIA seeks new markets to counter defense cuts... NEWS, ED 13, p. 22

MOS: A bigger market for a better MOS... SR, ED 8, p. 51

Decisions, decisions, for MOS users... SR, ED 8, p. 71

SALES FORECAST: Electronic sales inch ahead—but hesitantly... NEWS, ED 1, p. 25

SOFTWARE: Honeywell takes aim at software, services... NEWS, ED 4, p. 22

SUPERSONIC TRANSPORT: The Soviet hops off to a fast SST lead... NEWS, ED 2, p. 21

TRANSISTORIZED TV: TV market swinging to solid-state designs... NEWS, ED 11, p. 22

U.S. 1970 BUDGET is Nixon's problem now... NEWS, ED 4, p. 52

Industrial Electronics 66 columns

A/D CONVERSION TECHNIQUES: Automatic offset correction can boost a/d converter performance considerably... SR, ED 1, p. 104

Some applications require unique conversion techniques or special hardware... SR, ED 1, p. 97

Time-sharing saves hardware, but may result in lower over-all performance... SR, ED 1, p. 108

COMPUTER 'reads' utility meters 100 miles away... NEWS, ED 7, p. 22

DC SERVO MOTORS: Get better dc servo motor performance... ART, ED 8, p. 88

HOLOGRAPHIC INTERFEROMETRY: Finally: A practical application for holography... NEWS, ED 4, p. 25

LAW SUITS: Computer industry girds for IBM-CDC 'battle'... NEWS, ED 1, p. 21

STEPPING MOTOR: High-power stepper boosts speed, torque... PF, ED 1, p. 162

International Electronics 16 columns

CANADIAN electronics in force at Chicago show... NEWS, ED 1, p. 22

COMMUNICATIONS SATELLITES: Russians will attend Intelsat meeting in U.S... NEWS, ED 4, p. 21

COMPONENT FIRMS urged to expand markets... NEWS, ED 11, p. 22

COMPUTER FIRMS: Europe seeks to beef up its computer firms... NEWS, ED 5, p. 22

DIGITAL VOLTMETER: Talking digital voltmeter developed in France... NEWS, ED 9, p. 21

EUROPEAN TECHNOLOGY is closing IC 'gap'... NEWS, ED 9, p. 25

LSI CHIPS: LSI on view in Paris at components show... NEWS, ED 8, p. 21

TELECOMMUNICATIONS: Task Force urges new communications 'look'... NEWS, ED 1, p. 21

Lasers 122 columns

FIBER LASERS: The happy merger of fiber optics and lasers... NEWS, ED 13, p. 36

HIGH POWER: Ten-trillion-watt laser developed by Sandia... NEWS, ED 7, p. 44

HOLOGRAPHY: Data to 3-D pictures... NEWS, ED 9, p. 22

Finally: a practical application for holography... NEWS, ED 4, p. 25

Holographic movies and TV?... SR, ED 11, p. 54

IBM tests holographic data storage... NEWS, ED 13, p. 52

Overcoming nature's stumbling blocks... SR, ED 11, p. 49

The magic of holography... SR, ED 11, p. 44

The promise of dense data storage... SR, ED 11, p. 59

The reality and the illusion... SR, ED 11, p. 43

IC MANUFACTURING: Laser method slashes cost of custom arrays... NEWS, ED 3, p. 34

LASER-ACOUSTIC LINE reserves time functions... NEWS, ED 12, p. 28

LASER PULSES compressed to 0.4 ps... NEWS, ED 2, p. 36

LASER TUBES: Prealigned He-Ne laser tubes hold position when replaced... PF, ED 7, p. 114

LUNAR EXPLORATION: Laser to help explore earthmoon riddles... NEWS, ED 11, p. 22

MULTI-COLOR: Nine-color laser built... NEWS, ED 7, p. 22

PULSE-VOLTAGE MEASURE: Laser system measures high-voltage pulses... NEWS, ED 8, p. 34

Management and Careers 133 columns

COMMUNICATION: Don't argue, discuss... ART, ED 7, p. 76

CREATIVE PROCESS: Don't wait for brainstorm... ART, ED 4, p. 102

Manage creative engineers creatively... ART, ED 5, p. 82

Yes, you can develop your creativity... ART, ED 3, p. 66

FINANCIAL REPORTS: How to in-

vestigate a company... ART, ED 12, p. 112

HIRING: Hire the bright engineers... ART, ED 11, p. 96

IEEE PAPERS (INDEX): The timetable for technical papers... IEEE, ED 6, p. U116

REFRESHER COURSES: Here's a personal view of updating courses... IEEE, ED 6, p. U93

School bells for the smart engineers... IEEE, ED 6, p. U90

SUMMER COURSES: Looking for a summer study session?... ART, ED 10, p. 120

TRAINING COURSES: Management training of engineers... ART, ED 1, p. 114

TRAINING GAMES: Play your way to better decisions... ART, ED 13, p. 124

Materials 92 columns

AMORPHOUS SEMICONDUCTORS: Ovshinsky displays futuristic thin-film device... NEWS, ED 12, p. 30

Amorphous semiconductor: Zowie? or zilch?... NEWS, ED 13, p. 25

INSULATING MATERIALS: An ELECTRONIC DESIGN Special Report... SR, ED 12, p. 65

Ceramics, ceramoplastics and glasses... SR, ED 12, p. 76

Elastomers... SR, ED 12, p. 93

Smart designers keep pace with insulating materials... SR, ED 12, p. 66

Thermoplastics... SR, ED 12, p. 82

Thermosetting plastics... SR, ED 12, p. 69

MAGNETIC MATERIAL: New magnetic material promises powerful TWTs... NEWS, ED 6, p. 22

MICROWAVE IC MATERIALS: Wanted: better materials for microwave ICs... NEWS, ED 11, p. 30

POLYCONDUCTORS: Insulator-to-conductor discovery reported... NEWS, ED 11, p. 21

RADIATION peril spurs search for 'defenses'... IEEE, ED 6, p. U105

Medical Electronics 25 columns

THE ARTIFICIAL HEART: Problems, problems... NEWS, ED 11, p. 34

BIO-ENGINEERING: Be an EE, not an MD, surgeon tells engineers... NEWS, ED 5, p. 21

BLIND READERS: New machine for blind reads English out loud... NEWS, ED 2, p. 22

DIAGNOSIS AND TREATMENT: Even unseen symptoms yield to electronics... IEEE, ED 6, p. U106

Medical electronics: Infant with promise... SR, ED 1, p. 60

ELECTRONIC AIDS for the overburdened MD... NEWS, ED 8, p. 30

READING AIDS brighten outlook for the blind... NEWS, ED 5, p. 30

ULTRASONICS can detect heart-rejection signals. . . . NEWS, ED 7, p. 22

Microelectronics 255 columns

AIR FORCE computer uses LSI arrays. . . . NEWS, ED 8, p. 22

AMPLIFIERS: Inexpensive circuit boosts op amp output current. . . . IFD, ED 5, p. 92

CONTACT BOUNCE: Simple circuit eliminates switch contact bounce. . . . IFD, ED 2, p. 82

CTL INTEGRATED CIRCUITS: Complementary-transistor logic circuits chip away speed ceilings, slash costs. . . . PF, ED 7, p. 112

DELAY LINES: ICs provide variable delay for digital waveforms. . . . IFD, ED 6, p. 274

DUAL AMPLIFIER chip is MOS-bipolar IC. . . . PF, ED 2, p. 105

EUROPEAN TECHNOLOGY is closing IC 'gap'. . . . NEWS, ED 9, p. 25

FILMS, memories, LSI: A time to take stock. . . . IEEE, ED 6, p. U108

HYBRID CAPACITORS: Hybrid microstrip chips are low-loss capacitors. . . . PF, ED 2, p. 116

IC APPLICATIONS abound at solid-state show. . . . NEWS, ED 6, p. 25

IC MANUFACTURING: Laser method slashes cost of design arrays. . . . NEWS, ED 3, p. 34

IC MEMORIES: In IC memories, the trend is to quicker cycle times. . . . NEWS, ED 6, p. 25

IC PROGRAM: Major IC program underway at GE? . . . NEWS, ED 4, p. 22

IC TRANSMISSION LINE said to top microstrip. . . . NEWS, ED 11, p. 21

INTEGRATED CIRCUITS invade the power field. . . . NEWS, ED 6, p. 30

LEVEL CONVERTER: Positive-to-negative logic level converter uses simple IC. . . . IFD, ED 7, p. 90

LSI CHIPS: Fairchild's Dr. Hogan speaks out some plans. . . . NEWS, ED 8, p. 21

LSI on view in Paris at components show. . . . NEWS, ED 8, p. 21

LSI COMPUTER: Autonetics introduces small LSI computer. . . . NEWS, ED 1, p. 21

MICROWAVE IC MATERIALS: Wanted: better materials for microwave ICs. . . . NEWS, ED 11, p. 30

MOS: A bigger market for a better MOS. . . . SR, ED 8, p. 51

An ELECTRONIC DESIGN Special Report: MOS on the Upswing. . . . SR, ED 8, p. 49

Decisions, decisions, for MOS users. . . . SR, ED 8, p. 71

ELECTRONIC DESIGN MOS Integrated Circuit Directory. . . . SR, ED 10, p. 75

First U.S.-made LSI-MOS calculator introduced. . . . NEWS, ED 10, p. 22

MOS application notes and litera-

ture. . . . SR, ED 8, p. 77

MOS at work: The good and the bad. . . . SR, ED 8, p. 57

MOS capability directory. . . . SR, ED 8, p. 76

MOS future hinges on processing. . . . SR, ED 8, p. 65

MOS memory chip stores 256 words. . . . PF, ED 1, p. 146

Shrink delay line costs with MOS. . . . ART, ED 5, p. 50

MSI COUNTERS: MSI 4-bit counters operate at 15 MHz. . . . PF, ED 3, p. 92

OP AMPS: Researchers pressing for faster operational amplifiers. . . . NEWS, ED 6, p. 28

OSCILLATOR: IC op amp simplifies design of crystal-controlled oscillator. . . . IFD, ED 1, p. 124

PHASE DETECTOR: Build a direct-reading phase detector with ICs. . . . IFD, ED 4, p. 124

PHOTOTRANSISTORS: Molded phototransistors break price barrier. . . . PF, ED 6, p. 304

PLASTIC ICs: Will the military accept plastic ICs? . . . NEWS, ED 4, p. 38

PULSE GENERATORS: Standard TTLs yield one-shot that is variable two ways. . . . IFD, ED 6, p. 262

RADIATION EFFECTS: Will radiation wreck your IC design? . . . ART, ED 4, p. 78

Radiation-hardened ICs are off-the-shelf commercial devices. . . . IEEE, PF, ED 6, p. U148

Radiation-resistant ICs are a growing market. . . . NEWS, ED 6, p. 21

READ-ONLY MEMORIES: Slash ROM sizes with equivalent functions. . . . ART, ED 4, p. 66

STAIRCASE-WAVE GENERATOR uses integrated circuits. . . . IFD, ED 8, p. 100

TIME DIVISION MULTIPLEX with standard TTL logic gates. . . . IFD, ED 7, p. 88

TRIGGER PULSES: Circuit provides IC trigger pulses on contact closure. . . . IFD, ED 1, p. 126

TTL GATES: Linearize your TTL gates—then build useful circuits with them. . . . IFD, ED 5, p. 88

WORD GENERATOR: Build a programmable word generator. . . . ART, ED 2, p. 62

ZENER DIODES: IC differential amplifiers yield matched zener pairs. . . . IFD, ED 9, p. 80

Microwaves 71 columns

COAST GUARD RADAR: 'Bargain' electronics for the Coast Guard. . . . NEWS, ED 1, p. 36

COMPUTER DESIGN spurs microwave IC growth. . . . NEWS, ED 13, p. 21

IC TRANSMISSION LINE said to top microstrip. . . . NEWS, ED 11, p. 21

KOREA WAR GAMES: 'Portable war' electronics gets first Pacific Test.

. . . . SR, NEWS, ED 10, p. 34

MILITARY AVIONICS: IC circuits emerging for military avionics. . . . IEEE, ED 6, p. U110

RADAR BEACON monitors 128 planes at a time. . . . NEWS, ED 1, p. 32

SWITCHING: Don't waste drive power. . . . ART, ED 13, p. 106

X-BAND SWEEPERS are going solid state. . . . PF, ED 9, p. 86

YIG ECHO effect promises new devices. . . . NEWS, ED 1, p. 34

Military Electronics 71 columns

ABM DEBATE: Scientists choose sides in ABM debate. . . . NEWS, ED 11, p. 25

AIR DEFENSE DISPLAY does more. . . . NEWS, ED 5, p. 36

BUIC III: Air Force takes over backup unit for Sage. . . . NEWS, ED 3, p. 22

COMMUNICATIONS: Defense satellite communications pressed. . . . NEWS, ED 7, p. 21

CONTRACTS: F-15A contenders cut from 4 to 3 companies. . . . NEWS, ED 2, p. 22

F-14 contract worth billions to Grumman. . . . NEWS, ED 3, p. 22

DEFENSE DEPT: A voice for electronics in the Defense Dept.? . . . NEWS, ED 2, p. 21

DIRECTION FINDER: Instant DF aid for combat pilots in trouble. . . . NEWS, ED 9, p. 32

GAS ALARM: Nerve gas alarm developed for Army. . . . NEWS, ED 7, p. 42

INSTANT AIRPORTS: Light air-traffic tower turns strip into airport. . . . NEWS, ED 4, p. 22

LSI COMPUTER: Autonetics introduces small LSI computer. . . . NEWS, ED 1, p. 21

MILITARY AVIONICS: IC circuits-emerging for military avionics. . . . IEEE, ED 6, p. U110

MINE DETECTION: Riderless jeep makes mine detection safer. . . . NEWS, ED 9, p. 22

MOBILE RADAR: Army gets multi-display anti-aircraft radar. . . . NEWS, ED 6, p. 48

MOTHBALL ELECTRONICS: For 'Dual-Based' Defense: Mothball and fast-haul electronics needed. . . . NEWS, ED 9, p. 34

NAVY BUILDUP: 5-year buildup forecast in electronics for Navy. . . . NEWS, ED 4, p. 21

NAVY FLEET: Navy reports it faces obsolescence crisis. . . . NEWS, ED 8, p. 22

NIGHT VISION AIDS: \$2 billion spending seen for night-vision aids. . . . NEWS, ED 9, p. 22

PLASTIC ICs: Will the military accept plastic ICs? . . . NEWS, ED 4, p. 38

SAFEGUARD: Sentinel to 'Safeguard' Minuteman missile sites. . . . NEWS, ED 7, p. 21

SATELLITE COMMUNICATIONS: Defense Department pushes satellite communications NEWS, ED 12, p. 21
 Military moving to cure communications "fluke" NEWS, ED 13, p. 21
SENTINEL: Showdown on Sentinel is due this month NEWS, ED 5, p. 21
STUBBING REPORT: Accusations rocking the aerospace industry NEWS, ED 5, p. 25
TESTING: Eastern Test Range getting ready for MIRV NEWS, ED 10, p. 21

Missiles
11 columns

ABM DEBATE: Scientists choose sides in ABM debate NEWS, ED 11, p. 25
SAFEGUARD: Sentinel to 'Safeguard' Minuteman missile sites NEWS, ED 7, p. 21
SENTINEL: Showdown on Sentinel is due this month NEWS, ED 5, p. 21
TESTING: Eastern Test Range getting ready for MIRV NEWS, ED 10, p. 21

Navigation and Guidance
9 columns

BLIND-LANDING SYSTEM sold—after 14 years NEWS, ED 4, p. 21
DIRECTION FINDER: Instant DF aid for combat pilots in trouble NEWS, ED 9, p. 32
LSI COMPUTER: Autonetics introduces small LSI computer NEWS, ED 1, p. 21
STRAP-DOWN GUIDANCE system passes test NEWS, ED 10, p. 30

Oceanology
24 columns

COMPUTERS: Oceanographic ships need better computers NEWS, ED 12, p. 22
DEEP-SEA SEARCH VEHICLE being designed for Navy NEWS, ED 13, p. 21
EXPLORATION: Rich, untapped oceans beckon prospectors SR, ED 1, p. 56
PROPOSED AGENCY: U.S. urged to set up oceanographic agency NEWS, ED 3, p. 22
UNDERSEA LAB: Designing for the explosive undersea depths NEWS, ED 2, p. 25
WEATHER: Sea study is seeking better clues to weather NEWS, ED 10, p. 21

Optoelectronics
81 columns

FIBER LASERS: The happy merger

of fiber optics and lasers NEWS, ED 13, p. 36
HOLOGRAPHY: Holographic movies and TV? SR, ED 11, p. 54
 Holography: The reality and the illusion SR, ED 11, p. 43
IBM tests holographic data storage NEWS, ED 13, p. 52
 Overcoming nature's stumbling blocks SR, ED 11, p. 49
 The magic of holography SR, ED 11, p. 44
 The promise of dense data storage SR, ED 11, p. 59
IR SCANNER a success, but RCA abandons it NEWS, ED 8, p. 22
ISOLATORS: Solid-state isolators couple optically PF, ED 4, p. 152
LIGHT-EMITTING DIODE triples radiant power PF, ED 8, p. 128
NEW CRT operates in bright sunlight NEWS, ED 12, p. 22
PHOTODEVICES have you in the dark? ART, ED 3, p. 60

Packaging and Cooling
32 columns

APERTURE COUPLING enhances filter selectivity IFD, ED 3, p. 76
CONNECTORS: Make simple connectors from transistor sockets IFD, ED 4, p. 130
CRYOGENERATOR: Here's how to cool it NEWS, ED 13, p. 54
LASER TUBES: Prealigned He-Ne laser tubes hold position when replaced PF, ED 7, p. 114
PACKAGED LOGIC: Computer service turns logic into packages NEWS, ED 4, p. 42
PLASTIC ICs: Will the military accept plastic ICs? NEWS, ED 4, p. 38
SELECT AIR MOVERS without guesswork ART, ED 11, p. 90

Power Sources
12 columns

CHOOSING POWER SUPPLIES: Avoid unnecessary heat in picking power supplies IFD, ED 1, p. 130
IGNITION SYSTEMS: Resonant charging technique simplifies ignition systems IFD, ED 7, p. 82
POWER SUPPLY FILTERS: Go graphic with capacitive input filters ART, ED 12, p. 106

Research and Development
112 columns

BLIND READERS: New machine for blind reads English out loud NEWS, ED 2, p. 22
COSTS: U.S. advised to check non-profit R & D costs NEWS, ED 5, p. 22
DEFENSE R&D spurs protest and antiprotect NEWS, ED 6, p. 21

EMERGING TECHNOLOGIES SR, ED 1, p. 54
 Technology, as the engineers see it IEEE, ED 6, p. U98
INTERACTIVE COMPUTING: Man-Computer 'Partnerships' explored NEWS, ED 3, p. 25
LASER RADAR: Laser pulses compressed to 0.4 ps NEWS, ED 2, p. 36
NIGHT VISION AIDS: \$2 billion spending seen for night-vision aids NEWS, ED 9, p. 22
OCEANS: Rich, untapped oceans beckon prospectors SR, ED 1, p. 56
OP AMPS: Researchers pressing for faster operational amplifiers NEWS, ED 6, p. 28
POLYCONDUCTORS: Insulator-to-conductor discovery reported NEWS, ED 11, p. 21
UNDERSEA LAB: Designing for the explosive undersea depths NEWS, ED 2, p. 25
U.S. BUDGET: 1970 U.S. budget is Nixon's problem now NEWS, ED 4, p. 52
YIG ECHO effect promises new devices NEWS, ED 1, p. 34

Semiconductors
64 columns

AMORPHOUS SEMICONDUCTORS: Ovshinsky displays futuristic thin-film device NEWS, ED 12, p. 30
 Amorphous semiconductors: Zowie? or zilch? NEWS, ED 13, p. 25
EUROPEAN TECHNOLOGY is closing IC 'gap' NEWS, ED 9, p. 25
LIGHT-EMITTING DIODE triples radiant power PF, ED 8, p. 128
LOG DIODES can simplify design ART, ED 2, p. 58
MOSFET PARAMETERS: Measure MOSFET parameters with ease ART, ED 4, p. 86
PHOTODEVICES have you in the dark? ART, ED 3, p. 60
PHOTOTRANSISTORS: Molded phototransistors break price barrier PF, ED 6, p. 304
P-I-N DIODE: Vhf p-i-n diode is rf resistor PF, ED 3, p. 100
RADIATION peril spurs search for 'defenses' IEEE, ED 6, p. U105
TRANSISTOR-LIKE DEVICE has fused-in power NEWS, ED 9, p. 21

Sonar and Ultrasonics
5 columns

GUNN DEVICE generates ultrasonic waves NEWS, ED 6, p. 22
HEART MEASUREMENTS: Ultrasonics can detect heart-rejection signals NEWS, ED 7, p. 22
MEDICAL ELECTRONICS: Even unseen symptoms yield to electronics IEEE, ED 6, p. U106

Space

71 columns

- APOLLO: Apollo 8 electronics systems are go, go, go. . . . NEWS, ED 2, p. 30
- APOLLO lunar module was tested to the nth degree. . . . NEWS, ED 3, p. 36
- Just a step away from a landing on the moon. . . . NEWS, ED 7, p. 34
- COMMUNICATIONS SATELLITES: Russians will attend Intelsat meeting in U.S. . . . NEWS, ED 4, p. 21
- EARTH RESOURCES: 'Big eye' in the sky: Sensors to monitor earth. . . . NEWS, ED 7, p. 25
- NASA urged to speed earth resources work. . . . NEWS, ED 5, p. 21
- EXPLORER 1: 11 years old. . . . NEWS, ED 5, p. 22
- HEALTH PERILS: 30-day astronaut flight to study space perils. . . . NEWS, ED 11, p. 32
- ION ENGINES may keep satellites on station. . . . NEWS, ED 7, p. 44
- JUPITER FLIGHT: Hop to Jupiter: Takeoff, 1972; Arrival, 1974. . . . NEWS, ED 10, p. 25
- LASERS to help explore earth-moon riddles. . . . NEWS, ED 11, p. 22
- LUNAR EXPLORATION: How and why men explore the moon. . . . NEWS, ED 8, p. 25
- MARINER: Electronic failures in Mariners discounted. . . . NEWS, ED 10, p. 22
- MEDICAL ELECTRONICS: Electronic aids for the overburdened MD. . . . NEWS, ED 8, p. 30
- SATELLITE: Defense Department pushes satellite communications. . . . NEWS, ED 12, p. 21
- Defense satellite communications pressed. . . . NEWS, ED 7, p. 21
- SATELLITES: Military moving to cure communications "flake". . . . NEWS, ED 13, p. 21
- Satellite communications for AF command planes. . . . NEWS, ED 9, p. 21
- Satellite designs offer more than one function. . . . IEEE, ED 6, p. U98
- STRAP-DOWN GUIDANCE system passes test. . . . NEWS, ED 10, p. 30
- VIKING: NASA seeks Viking bids. . . . NEWS, ED 7, p. 22
- WEATHER-DATA SYSTEM: Wide-angle antenna uses circular polarization. . . . NEWS, ED 11, p. 28

System Design

84 columns

- A/D CONVERSION TECHNIQUES: Automatic offset correction can boost a/d converter performance considerably. . . . SR, ED 1, p. 104
- Some applications require unique conversion techniques or special hardware. . . . SR, ED 1, p. 97
- Time sharing saves hardware, but may result in lower over-all performance. . . . SR, ED 1, p. 108
- COMMUNICATIONS EQUIPMENT: Where the action is: Expansion in

- 3 areas. . . . IEEE, ED 6, p. U102
- DIGITAL CONTROLLERS: Sectionalize your digital controller. . . . ART, ED 1, p. 82
- MICROFILM SYSTEM: Computer microfilm system records computer data. . . . PF-SR, ED 9, p. C42
- PHASELOCK LOOPS: Build a better frequency comparator. . . . ART, ED 3, p. 54
- RADAR SYSTEMS: Reduce radar display clutter. . . . ART, ED 6, p. 204
- RADIATION EFFECTS: Will radiation wreck your IC design? ART, ED 4, p. 78
- RESISTIVE SUMMING NETWORKS: Generalized analysis simplifies resistor summing network design. . . . IFD, ED 6, p. 276
- WEATHER-DATA SYSTEM: Wide-angle antenna uses circular polarization. . . . NEWS, ED 11, p. 28

Test Equipment and Measuring

131 columns

- APOLLO LUNAR MODULE was tested to the nth degree. . . . NEWS, ED 3, p. 36
- COMPUTING COUNTER: Versatile computing counter performs real-time calculations on measurements. . . . PF, ED 2, p. 92
- CONVERTERS: Circuit converts two analog quantities to frequency or period. . . . IFD, ED 6, p. 258
- COUNTERS: Presettable up/down counter is simple and inexpensive. . . . IFD, ED 5, p. 88
- Pushbutton counters have 3 by 5-in. face. . . . PF, ED 5, p. 118
- Up/down counters clock at 30 MHz. . . . PF, ED 5, p. 108
- CURVE TRACER: Do-it-yourself curve tracer checks diodes in laboratory. . . . IFD, ED 6, p. 256
- DIGITAL MULTIMETER: LSI on view in Paris at components show. . . . NEWS, ED 8, p. 21
- DIGITAL PANEL METER costs only \$100. . . . PF, ED 13, p. 150
- Low-cost compact DPM programs from rear. . . . PF, ED 12, p. 144
- DIGITAL VOLTMETER: Talking digital voltmeter developed in France. . . . NEWS, ED 9, p. 21
- Low-ohm 5-digit voltmeters respond fast and accurately. . . . PF, ED 13, p. 148
- FM PULSES: Measure the sweep linearity of fm pulses. . . . ART, ED 6, p. 228
- *FUNCTION GENERATOR spans 5-MHz range. . . . PF, ED 1, p. 134
- HOLOGRAPHIC INTERFEROMETRY: Finally: A practical application for holography. . . . NEWS, ED 4, p. 25
- IMAGING SYSTEM: New imaging system turns sound to color. . . . NEWS, ED 6, p. 21
- INPUT IMPEDANCE: Simple technique measures op amp input impedance. . . . IFD, ED 6, p. 262
- IR SCANNER a success, but RCA abandons it. . . . NEWS, ED 8, p. 22

- LASER SYSTEM measures high-voltage pulses. . . . NEWS, ED 8, p. 34
- LOGIC PULSE INDICATOR detects 50-ns widths. . . . PF, ED 11, p. 148
- LOGIC TEST SYSTEM: Computerized test setup checks any logic system. . . . PF, ED 6, p. 290
- LSI TESTING: Fairchild's Dr. Hogan spells out some plans. . . . NEWS, ED 8, p. 21
- MAGNETIC MEASUREMENTS: Low-cost meter uses Hall effect for magnetic measurements. . . . IFD, ED 5, p. 92
- MAGNETOMETER-LOCATOR: Greek city found by new magnetometer. . . . NEWS, ED 1, p. 22
- MOSFET PARAMETERS: Measure MOSFET parameters with ease. . . . ART, ED 4, p. 86
- OP AMP TESTING: Simplify op-amp parameter tests. . . . ART, ED 11, p. 80
- OSCILLOSCOPE: Solid-state covers dc to 25 MHz. . . . IEE, PF, ED 6, p. U144
- A grease pencil marks oscilloscope photographs. . . . IFD, ED 6, p. 252
- PEAK-SENSING CIRCUIT measures a-m modulation directly. . . . IFD, ED 6, p. 268
- PHASE DETECTOR: Build a direct-reading phase detector with ICs. . . . IFD, ED 4, p. 124
- POCKET PULSER: reps to 1 MHz— PF, ED 3, p. 103
- Q MEASUREMENT: Measure resonator loaded Q with frequency measurement. . . . IFD, ED 7, p. 86
- RF CURRENT PROBE is immune to interfering magnetic fields. . . . IFD, ED 12, p. 128
- SEISMIC MONITORING: A growing role for 'earth-shaking' electronics. . . . NEWS, ED 2, p. 37
- SIGNAL GENERATOR: Multiple-function generator sweeps and synthesizes. . . . IEEE, PF, ED 6, p. U140
- Two instruments stress performance. . . . IEEE, PF, ED 6, p. U141
- SLIDE RULE: Use your slide rule as a quick dB calculator and a wire table. . . . IFD, ED 4, p. 130
- SPECTRUM ANALYZER: Calibrated spectrum analyzer operates on internal battery. . . . PF, ED 8, p. 112
- TEST CIRCUIT: Circuit checks heaters for shorts while protecting fuses. . . . IFD, ED 6, p. 266
- TIME-CODE GENERATORS use ICs to cut costs. . . . IFD, ED 8, p. 116
- TRANSIENT GENERATOR speeds noise immunity measurements. . . . IFD, ED 7, p. 84
- UNDERSEA LAB: Designing for the explosive undersea depths. . . . NEWS, ED 2, p. 25
- VOLTMETER-COMPARATOR: NBS offers wideband rf voltmeter comparator. . . . NEWS, ED 6, p. 48
- X-BAND SWEEPERS are going solid state. . . . PF, ED 9, p. 86
- ZERO CROSSING: Circuit detects zero crossings of full-wave rectified ac. . . . IFD, ED 6, p. 260

Pulse widths up to 10 seconds provided by hybrid one-shot

Real-time process and manufacturing control requires time delays in excess of those encountered in data processing and computation. The lack on the market of integrated circuits that can provide one-shot operation with stable pulse widths on the order of one second and a high duty cycle can often pose a problem in this respect.

One highly satisfactory solution (Fig. 1) uses a unijunction transistor timing circuit buffered by RTL ICs.

In the circuit, grounding of point A by a negative-going pulse produces a positive pulse at the output of gate G1, provided that the J-K flip-flop is in its reset condition ("1" output LOW). Gate G2 acts as an OR gate and applies the pulse to the trigger input of the flip-flop, toggling it. This makes the "0" output of the flip-flop LOW, cutting off transistor Q1. A low collector resistance is used with Q1 to provide positive switching.

The emitter lead of the unijunction transistor Q2 had been clamped to ground by Q1, through the 1N914 diode. With Q1 cut off, capacitor C1 charges at a rate across C1, R1 and R2. When the voltage across C1 reaches the peak-point emitter voltage of Q2, the unijunction fires, discharging C1 through its bases and generating a sharp positive pulse across resistor R3. This pulse is capacitively coupled to OR-gate G2, resetting the J-K flip-flop.

The feedback from the "1" output of the flip-flop to gate G1 prevents a second pulse applied to point A from turning the flip-flop off while timing is in progress.

Resistor R4, inserted between base 2 of the unijunction transistor and the power supply, improves the pulse-width stability of the circuit to within 1% over the temperature range of 0° to 50°C.

In actual tests, pulse-width variation of 0.2% was observed over the temperature range of 15°C to 35°C. The pulse width is described by the equation ($T = R \ln(1/1 - \eta)$), where η is the intrinsic standoff ratio of the unijunction

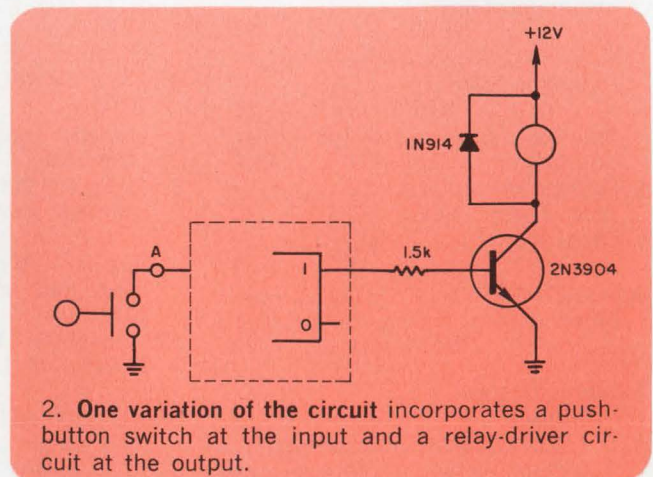
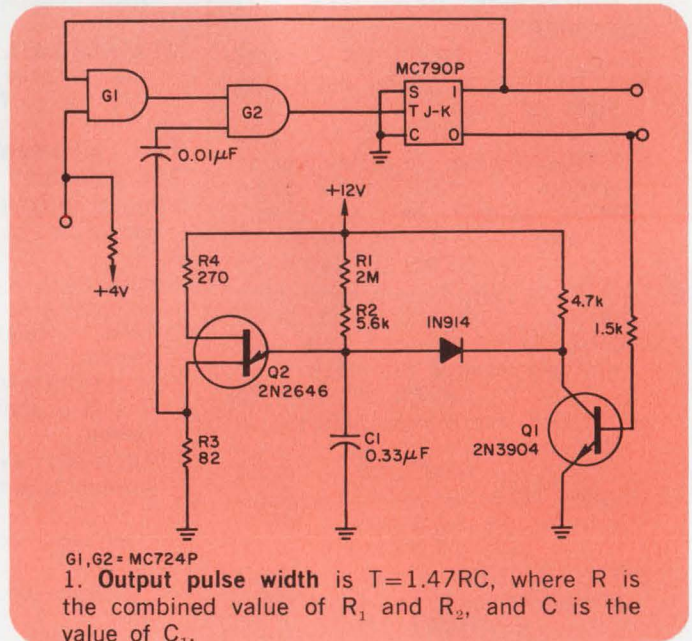

transistor. For the 2N2646, with an average η of 0.65, the equation simplifies to $T = 1.47RC$.

The duty cycle of the circuit is very high and is limited only by the discharge period of capacitor C1 through the unijunction transistor. This

400 Hz RCA Triacs— ready to take over!

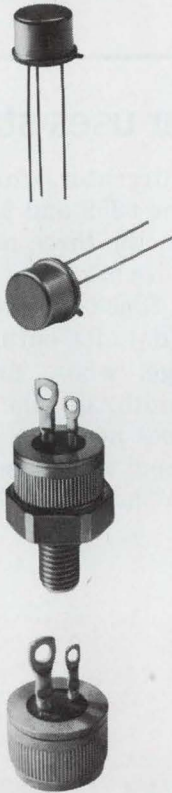

**120-V line operation and
200- and 400-V repetitive peak
off-stage blocking voltages**

Up in the air about 400 Hz controls? Would you like to forget electro-mechanical relays or switches for such aircraft applications as lighting controls for cabins and running lights; heater controls; motor controls; hydraulic valve controls? RCA has the answer: new 400 Hz triacs ready for your evaluation and inclusion in your circuit designs. Look at the tabulation of units you can work with—at RMS currents from 0.5 A to 40 A and repetitive peak off-state blocking voltages of 200 V and 400 V—all designed for 400-Hz operation and available in two and three-lead modified TO-5, press-fit and stud type packages.

Ask your local RCA Representative or your RCA Distributor for details. For preliminary technical data sheets to aid in your evaluation of these units for airborne controls applications, write RCA Electronic Components, Commercial Engineering, Section RG8-1, Harrison, N. J. 07029.

MAXIMUM RATINGS

0.5 A I_{rms}—In 3-lead modified TO-5			TA7615	400 V	press-fit
TA7654	200 V	10 mA I_{gt}	TA7616	200 V	stud
TA7655	400 V	10 mA I_{gt}	TA7617	400 V	stud
TA7656	200 V	25 mA I_{gt}	15 A I_{rms}—press-fit or stud		
TA7657	400 V	25 mA I_{gt}	TA7618	200 V	press-fit
2.5 A I_{rms}—2-lead modified TO-5			TA7619	400 V	press-fit
TA7671	200 V	25 mA I_{gt}	TA7620	200 V	stud
TA7672	400 V	25 mA I_{gt}	TA7621	400 V	stud
6 A I_{rms}—press-fit or stud			25 A I_{rms}—press-fit or stud		
TA7642	200 V	press-fit	TA7646	200 V	press-fit
TA7643	400 V	press-fit	TA7647	400 V	press-fit
TA7644	200 V	stud	TA7648	200 V	stud
TA7645	400 V	stud	TA7649	400 V	stud
10 A I_{rms}—press-fit or stud			40 A I_{rms}—press-fit or stud		
TA7614	200 V	press-fit	TA7650	200 V	press-fit
			TA7651	400 V	press-fit
			TA7652	200 V	stud
			TA7653	400 V	stud

RCA Thyristors

period depends on the magnitude of C_1 , and varies from 3 μs for 0.01 μF , to 6 μs for 0.1 and 12 μs for 1 μF . The one-second one-shot shown in the diagram has a reset time of 10 μs .

Minor modifications can adapt the circuit to a variety of uses. For example, adding a pushbut-

ton from point A to ground and a relay driver circuit at the output of Q1 makes it an ideal timer for the photographic darkroom (Fig. 2).

A. J. Krygeris, Project Engineer, Gilmore Industries, Inc., Cleveland, Ohio 44122

VOTE FOR 311

Pulse-width to pulse-height converter uses standard blocks

A novel pulse-width to pulse-height converter can be built for the most part with standard blocks, as shown in (a).

In the diagram, the first 3064 wide-band differential operational amplifier acts as a comparator, or "squaring amplifier," whose output (E_1) is a train of flat-topped pulses in synchronism with the input pulses. The leading edge of the E_1 pulse triggers a timing pulse, E_2 (see waveforms on b). The coincidence of the E_1 and E_2 pulses then initiates the "integrate" mode for the three-mode

integrator, which consists of the 3064 op amp and the 9859 and 9580 solid-state switches. Essentially, the three modes are integrate, hold and reset (discharge).

Since the integrator input is a constant (+15 Vdc), its output is a negative-going ramp voltage, whose final value is proportional to the width of the input signal pulse. When E_1 goes negative, following the trailing edge of the input signal pulse, the integrator mode changes to "hold." At the same time, the timing pulse, E_3 ,

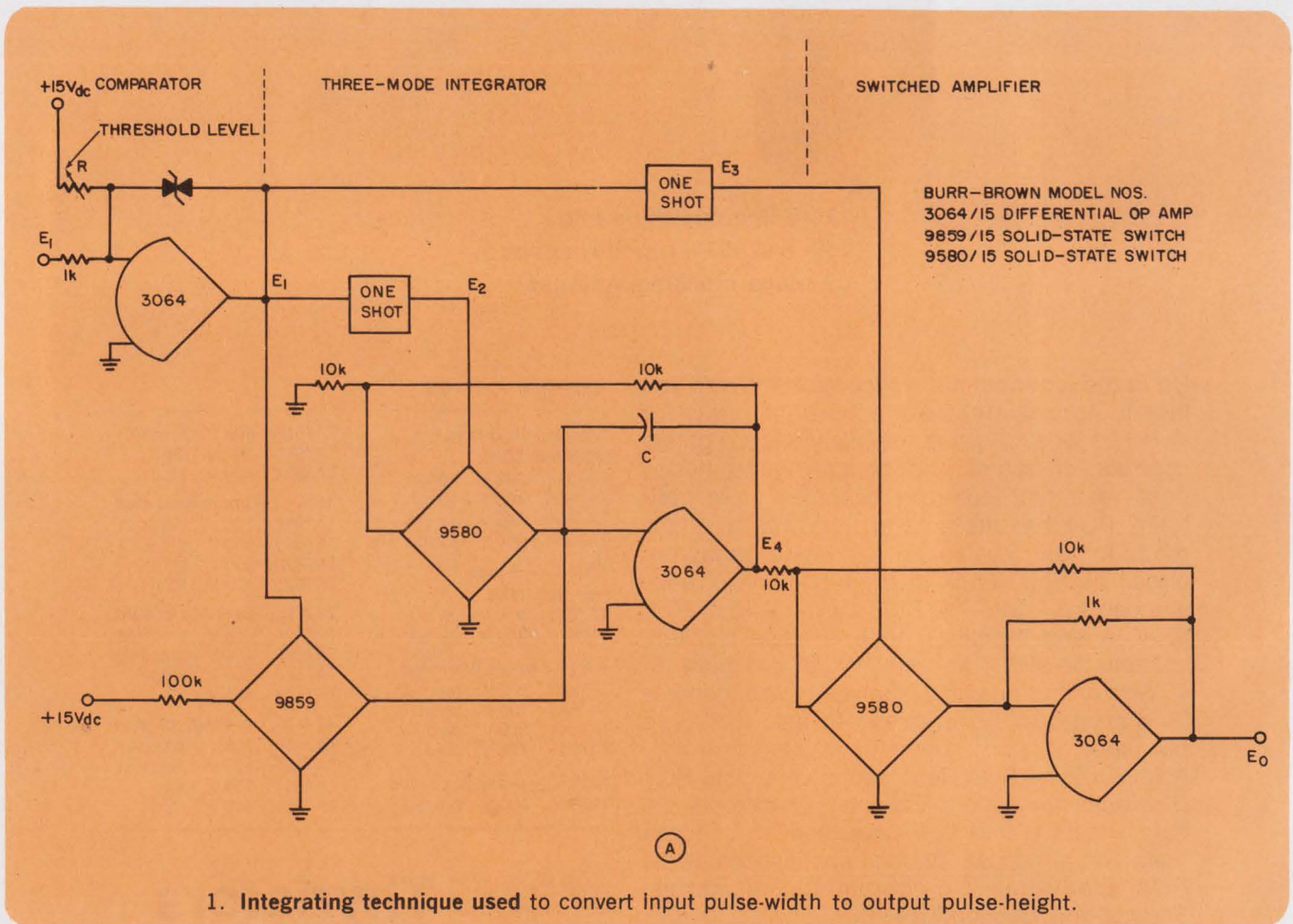

TRW METALLIZED POLYCARBONATE CAPACITORS



... small enough to fit!

TRW 50-volt Metallized Polycarbonate Capacitors are made to squeeze into tight places. Imagine 10 microfarads measuring .547" x 1¼" long... the smallest wound capacitor on the market!

Short on size and long on reliability, the X463UW series meets all requirements of MIL-C-27287.
VOLTAGE—50V, 100V, 200V, 400V
CAPACITANCE—.001 through 10 mfd
TOLERANCE—available to $\pm 1\%$.

For data, write TRW Capacitor Div., Ogallala, Neb. Phone (308) 284-3611. TWX 910-620-0321.

TRW®

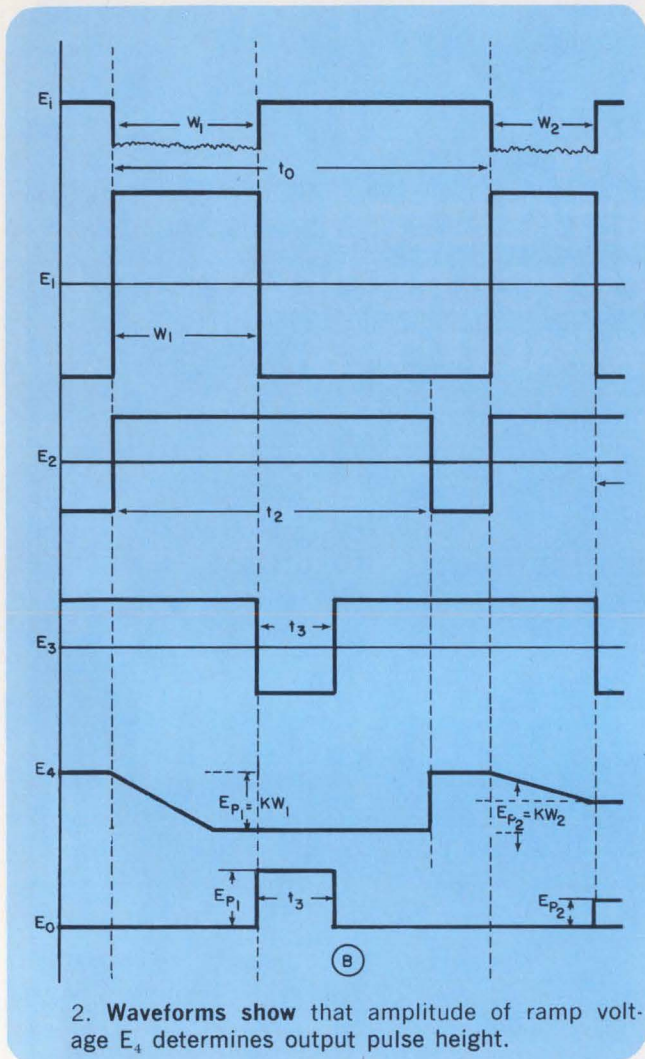

is triggered by E_1 . This timing pulse (E_3) turns on the 9580 switched amplifier, gating the pulse-height to the output. The width of the E_3 pulse determines the width of the output pulse.

The duration of the E_2 pulse must be great enough to overlap both the input signal pulse (worst case) and the E_3 pulse. Thus,

$$t_3 > W_1 (\text{max}) + t_2.$$

Pulse repetition rate ($1/t_0$) is limited by the set of conditions:

$$W_1 (\text{max}) + t_3 < t_2 < t_0 (\text{min})$$

Gene Tobey, Product Marketing Engineer, Burr-Brown Research Corp., Tucson, Ariz.

VOTE FOR 312

Soldering-iron tip plus hole equals miniature solder pot

With little effort, a soldering-iron tip can be converted into a compact, portable solder pot.

To make this handy aid, cut the pointed end off a soldering-iron tip and drill a 1/4- or 5/16-in. hole in one side, as shown in (A), taking care

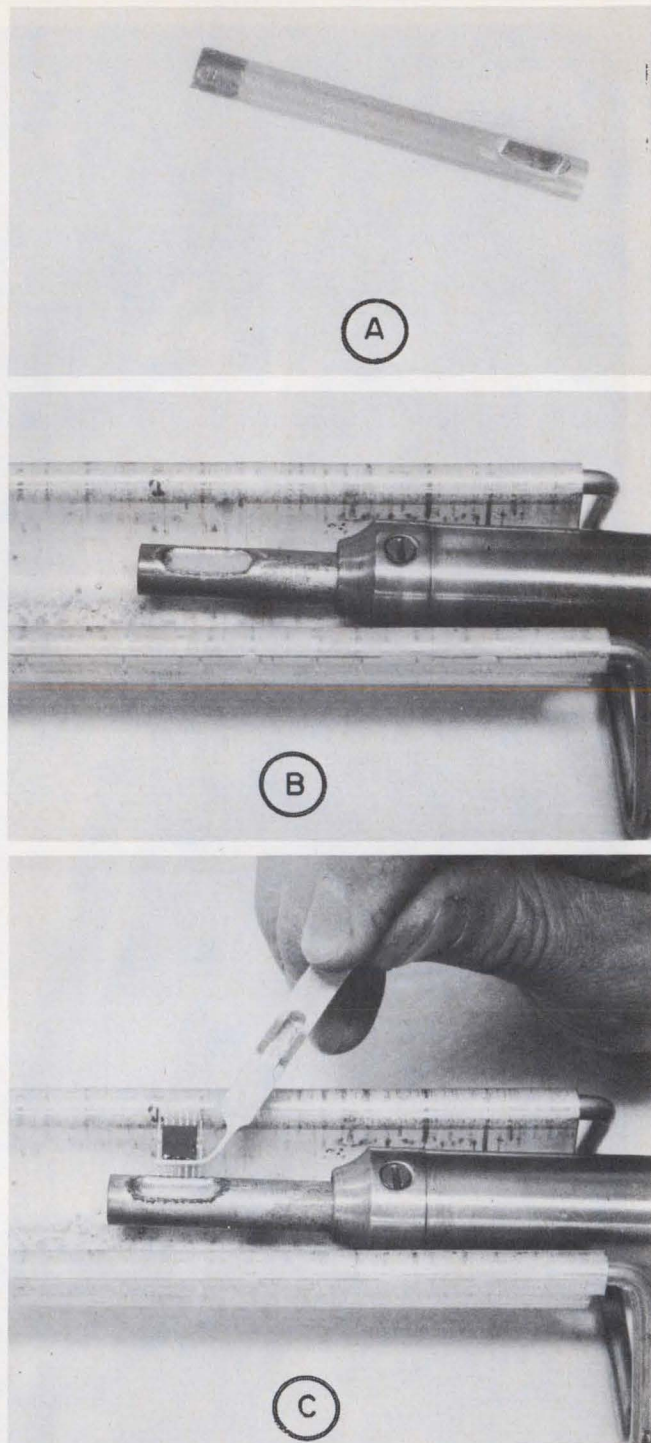

A drilled hole converts a soldering-iron tip (A) into a handy solder pot when the tip is inserted in the iron (B). An elongated hole makes it possible to tin components, such as IC flatpacks (C).

that the hole does not go through the tip. With the drilled tip in place in the soldering iron (B), position the iron so that the hole is vertical. Heat up the iron, fill the well with solder, and you're ready to go. With the hole elongated, as shown, component tinning is possible (C).

Milton F. Dickfoss, Electronic Process Engineer, Grumman Aircraft Engineering Corp., Bethpage, N.Y.

VOTE FOR 313

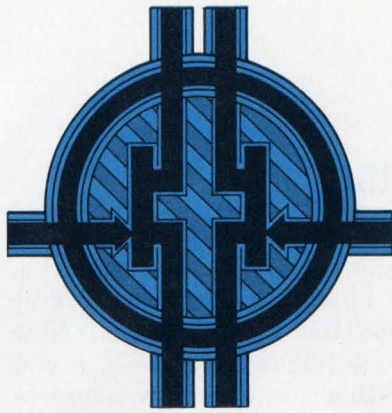

2 NEW DUAL FETs for electrometers and low noise diff amps

Electrometers The low gate current of the U248A series makes them ideally suited for this application. In the circuit shown, input current is typically less than 0.1 picoamp (10^{-13} amp). By operating at lower gate-drain voltages, lower gate input currents may be achieved; the only restriction is that $V_{DG} > V_p$. On special order, we'll select low V_p devices for you.

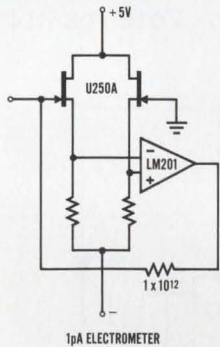

Characteristic	Symbol	Min	Max	Conditions
Gate Current	I_G		1 pA	$I_D = 30 \mu A$ $V_{DG} = 10V$
Transconductance	g_{fs}	50 μmho	150 μmho	
Offset Voltage	$ V_{GS1} - V_{GS2} $		5 mV*	
Differential Voltage Drift	$\Delta V_{GS1} - V_{GS2} / \Delta T$		5 $\mu V / ^\circ C$ *	
Breakdown Voltage	BV_{GSS}	-40V		

* The U248A-U251 series presents a range of devices with offset voltages from 5 mV and drift from 5 $\mu V / ^\circ C$.

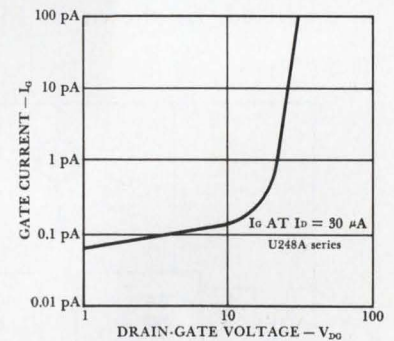

Low Level Differential Amplifiers The 2N5515 series gives you low noise and high common mode rejection. Short circuit input noise voltage is less than $10 nV / \sqrt{Hz}$; common mode rejection ratio (CMRR) is greater than 100 dB. Differential voltage drifts are available from 5 $\mu V / ^\circ C$.

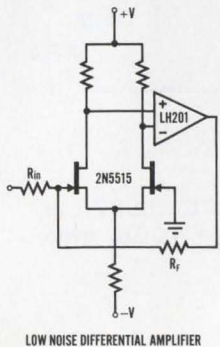

Characteristic	Symbol	Min	Max	Conditions
Common Mode Rejection Ratio	CMRR	100 dB		$I_D = 200 \mu A$ $V_{DG} = 10V \text{ to } 20V$
Short Circuit Input Noise Voltage	\bar{e}_n		15 nV / \sqrt{Hz} @ 10 Hz (2N5520-24)	$I_D = 200 \mu A$ $V_{DG} = 20V$
Gate Current	I_G		100 pA	
Transconductance	g_{fs}	500	1000 μmho	
Offset Voltage	$ V_{GS1} - V_{GS2} $		5 mV*	
Differential Voltage Drift	$\Delta V_{GS1} - V_{GS2} / \Delta T$		5 $\mu V / ^\circ C$ *	
Breakdown Voltage	BV_{GSS}	-40V		$I_G = 1 \mu A$

* The 2N5515-2N5524 series presents a range of devices with offset voltages from 5 mV and drift from 5 $\mu V / ^\circ C$.

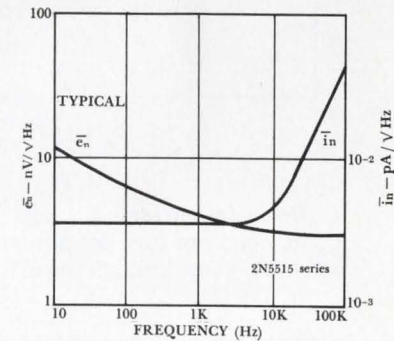

These are just *two* ways of using *two* series of Siliconix duals. We also have a general purpose series and a high frequency series; If you're involved in any type of design problem requiring duals, just give us a call. We'll deliver the service as well as the goods. That's *applications* power!

Our new address ...

... in Europe Siliconix Ltd.
Siliconix House
Sketty Park
Saunders Way
Swansea, U.K.



Siliconix incorporated

2201 Laurelwood Road • Santa Clara, Calif. 95054
Telephone (408) 246-8905 • TWX: 910-338-0227

Circuit prevents single phasing of SCR-driven motors

Most SCR-controlled motors cannot have continuous power applied to them without single phasing. This is due to the fact that the inductance of the motor winding causes the motor current to lag the motor voltage.

The circuit in Fig. 1 illustrates the problem. Assume *SCR1* is conducting during the negative half cycle of V_L . Now, if continuous power is being applied, *SCR2*'s trigger pulse, V_{G2} , will occur when V_L goes through zero on its way into the positive half cycle. However, at this point I_M is not equal to zero, so *SCR1* will not have turned off. This keeps a reverse bias across *SCR2*, preventing it from turning on. Thus, V_M will not be applied during the positive half cycle, and the motor will single phase.

Now consider what happens when the circuit is modified, as shown in Fig. 2. Again, assume

SCR1 and *CR1* are conducting. *CR2* and R_2 allow C_2 to charge up to the negative peak of V_M . When V_M begins its upward slope, *CR2* reverse biases and C_2 retains the negative peak. Now when *SCR2* receives its trigger pulse, V_{G2} , it can turn on, since its cathode is at a low negative voltage. R_2 must be small enough to provide the minimum turn-on holding current required by *SCR2*.

When I_M finally goes to zero at some point in the positive half cycle, *SCR1* will turn off, *CR2* will apply V_L to V_M , which will continue on uninterrupted.

R_1 , C_1 , and *CR1* perform the identical function at the end of the positive half cycle.

Ronald J. Surprenant, Scientist, LTV Research Center, Anaheim, Calif.

VOTE FOR 314

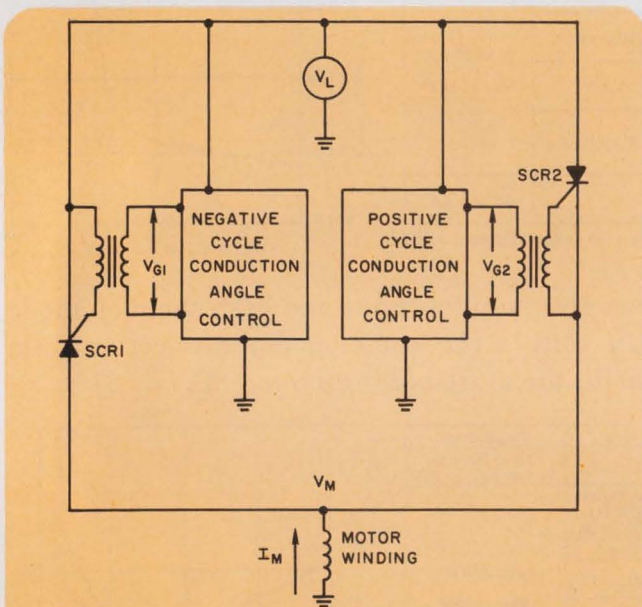

1. Because current I_M lags applied voltage V_L , *SCR1* does not turn off and allow *SCR2* to turn on when V_L goes through zero.

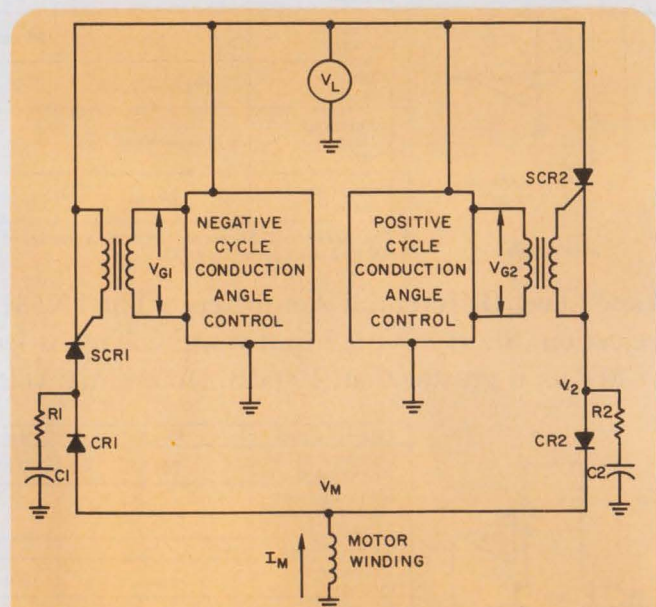

2. With the addition of *CR2*, R_2 and C_2 , *SCR2* can turn on when it receives its trigger pulse, even though *SCR1* has not yet turned off.

VOTE! Go through all Idea-for-Design entries, select the best, and circle the appropriate number on the Reader-Service-Card.

SEND US YOUR IDEAS FOR DESIGN. You may win a grand total of \$1050 (cash)! Here's how. Submit your IFD describing a new or important circuit or design technique, the clever use of a new component or test equipment, packaging tips, cost-saving ideas to our Ideas-for-Design editor. You will receive \$20 for each accepted idea, \$30 more if it is voted best-of-issue by our readers. The best-of-issue winners become eligible for the Idea Of the Year award of \$1000.

IFD Winner for April 12, 1969

R. Kleeman, Design Engineer, Zellweger Ltd., Uster, Switzerland. His Idea "Timing circuit has many uses; like windshield-wiper control" has been voted the Most Valuable of Issue Award.

Vote for the Best Idea in this Issue.



**We make our frequency components too good
rather than merely good enough.
Because sometime, somewhere, it might make a difference.**

**Motorola's dependable,
precision frequency components
are now available.**

Many of our frequency components are used in emergency communications equipment. That's one reason why we will not compromise our insistence on quality.

And now, for the first time in 30 years, you and other designers and OEM manufacturers can take advantage of Motorola's experience and large production capa-

bilities for frequency components: crystals, filters, oscillators, tone modules, and resonant reeds.

You can choose from an extensive line of off-the-shelf precision components. Or we'll gladly design and produce your devices on a custom basis. If you need it, you'll get application assistance. And all components are made under clean room conditions.

Whatever application you have

in mind for our frequency components, you can count on one thing. All are designed with the same precision, the same quality, the same dependability. Because we won't settle for second best.

And neither should you.

Send for Bulletin TIC-3401. Write Component Products Dept., Motorola Communications & Electronics, Inc., 4501 W. Augusta Blvd., Chicago, Illinois 60651.



MOTOROLA TOTAL COMMUNICATIONS

PARA-METRIC D.C. POWER.



ever hear of it before?

Chances are you haven't because it's new. Brand new. Wanlass has incorporated the patented Paraformer™ principle in a series of D.C. power supplies with several remarkable features — the most outstanding of which is a noise and spike response time of 0 (Zero). Operating as a preregulator, the Paraformer™ portion provides ¼% regulation to the basic D.C. unit, as well as more than 100 db filtering to 1 MHz. Input voltages below 60 VAC and above 150 merely turn-off the device, while anything in between has no effect whatsoever on the D.C. output. Transient suppression is complete.

SPECIFICATIONS	
Noise and Response Time	Zero (Input/Output)*
Noise Attenuation and Normal Mode Rejection	100 db to 1 MHz*
Line Regulation	±0.001
Response Time	5 μsecs
Ripple	250 μV

*Available on no other existing power supply.

We call our new units the Series PDC. They come with ratings to 40 volts and 5 amps. Prices, off-the-shelf, start at \$375.

For details on Parametric D.C. power, write:

WANLASS INSTRUMENTS 

a division of **WANLASS ELECTRIC COMPANY**

A SUBSIDIARY OF **AMBAC INDUSTRIES INC.**

1540 EAST EDINGER AVENUE • SANTA ANA, CALIFORNIA 92707
CALL TOLL FREE: 800-854-3258 OR FROM CALIFORNIA CALL (714) 545-8467 • TWX: 910-595-1526

INFORMATION RETRIEVAL NUMBER 43

SOLID STATE ELECTRONIC TIMERS

Complete line
now available
from
one source



Ready now are: six models—five in the Delay Timer and one in the Interval categories. You have a choice of portable, plug-in or dial adjustable, panel mounting types. Request Bulletin 308.

**INDUSTRIAL
TIMER
CORPORATION** 
U.S. Highway 287, Parsippany, N.J.

Subsidiary of the Singer Company
INFORMATION RETRIEVAL NUMBER 44

Fluorocarbon Moldings Better Than Machined Parts!



**FREE
BROCHURE**

When tolerances are critical, parts machined from rod stock can be uneconomical. That's the time for a B & W quotation. B & W specializes in precision, intricate injection moldings to your specs. Materials include CTFE, Kel F, FEP, Kynar, Halon and others. We design and build all tooling.

Send part or print for fast, airmail quotation.
"World's largest custom Fluorocarbon molder"

**BOOKER AND
WALLESTAD DIV.**

1202 So. 5th St., Hopkins, Minn. 55343
Area 612/938-7671

Subsidiary of Thermotech Industries, Inc.

DEPT. ED



BW

INFORMATION RETRIEVAL NUMBER 45

ELECTRONIC DESIGN 16, August 2, 1969

Products

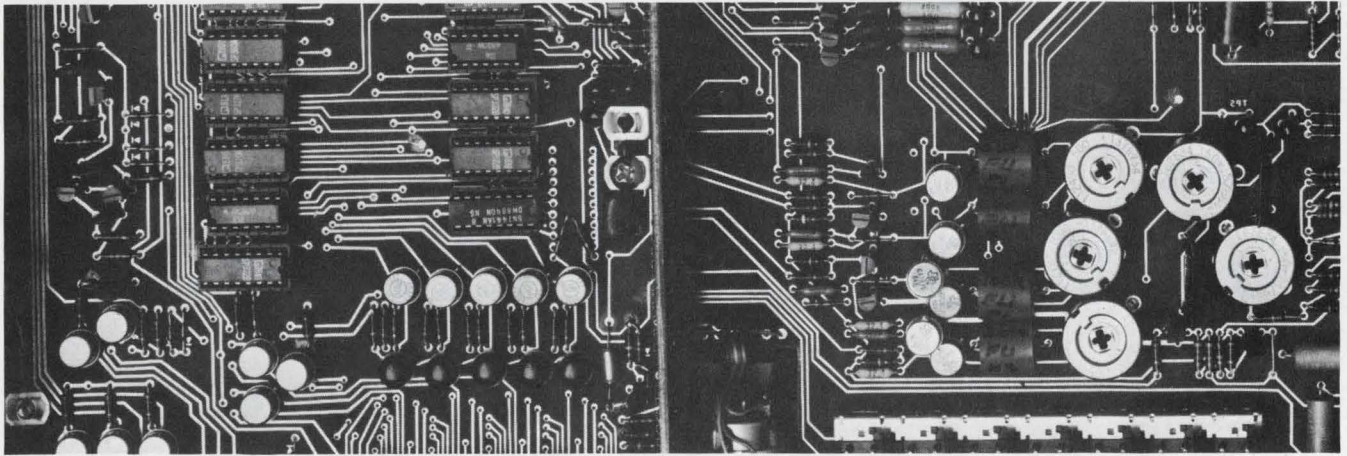

Two precision digital voltmeters halve their price tags and the number of components

through a recirculating-remainder a/d conversion technique, p. 122.



Monolithic dc comparator gives discrete-like performance, p. 131.

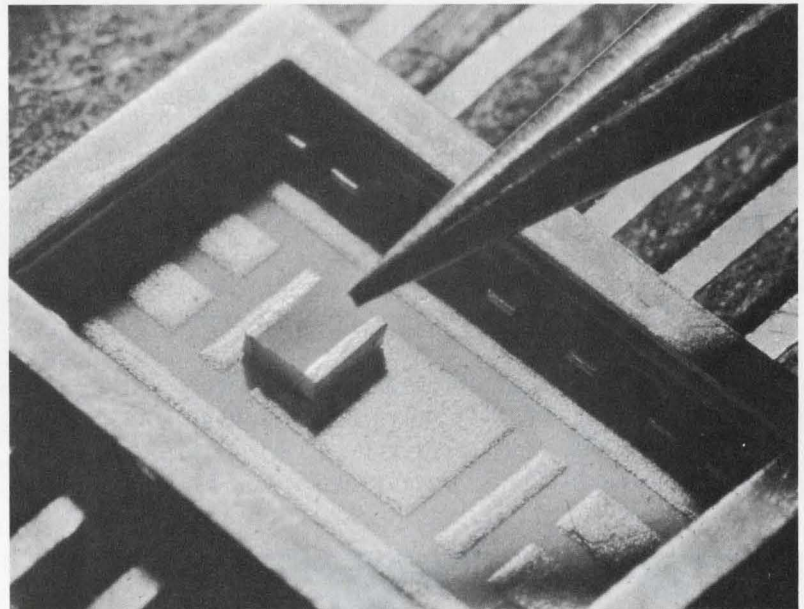

IC-compatible ceramic chip capacitors, only 15 mils thick, cover values from 15 pF to 0.01 μ F, p. 126.

Also in this section:

Four-channel logic circuit analyzer challenges oscilloscopes, p. 124.
Fiber-optic readouts feature LED or incandescent light sources, p. 128.
Compact lightweight power supplies for ICs pack 100-W punch, p. 128D.
Evaluation Samples, p. 139 . . . **Design Aids**, p. 140 . . . **Annual Reports**, p. 140
Application Notes, p. 141 . . . **New Literature**, p. 142

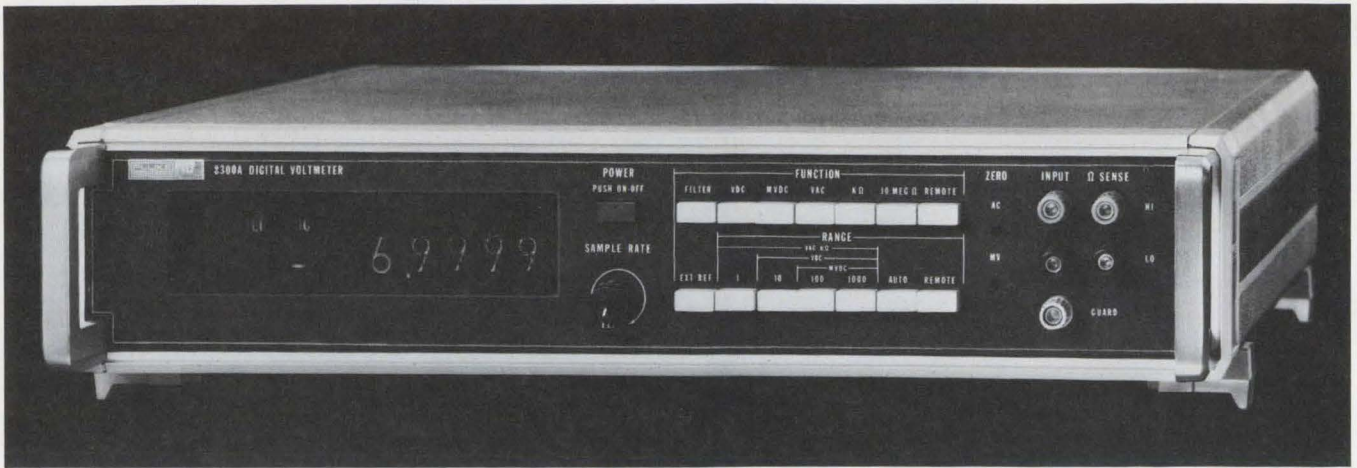

Economy voltmeter and multimeter uphold performance with fewer parts

John Fluke Manufacturing Co., Inc., P.O. Box 7428, Seattle, Wash. Phone: (206) 774-2211. P&A: \$695 to \$1295; 6 to 8 weeks.

Using a recirculating-remainder analog-to-digital conversion technique, two new digital instruments half the number of components needed, thus dropping their price tags by 50%. The new instrument family includes a digital multimeter and a digital voltmeter.

The a/d conversion technique, which is a variation of successive approximation, is based on storage capacitors, a single BCD counter and a resistive ladder network to serially determine and display all digits.

Model 8100A is a portable digital multimeter that sells for only \$695. It measures ac and dc voltage in four ranges to 1000 V, and resistance in five ranges to 10 MΩ. Its accuracy is $\pm 0.05\%$.



Reflecting streamlined styling, a new portable 4-1/2-digit multimeter, which costs only \$695, can run for eight hours from its optional battery supply.

of reading, ± 1 digit. There are four full digits, plus a "1" for 20% overranging.

All functions on the 8100A are pushbutton selectable and polarity indication is automatic. Total power consumption is 10 W; total operation time is eight hours with an optional battery pack.

The new digital multimeter boasts a full-scale resolution of 0.01%; this represents 100 μ V for voltage measurements, 0.1 μ A for current measurements and 0.1 Ω for resistance measurements. With a filter, normal-mode rejection is over 50 dB at 60 Hz.

Model 8300A, a 0.01% digital voltmeter, features total built-in systems capability for only \$1295. The basic unit measures dc voltage in three ranges, from 0 to 1000 V. Ac voltage measurement is over four ranges up to 1100 V. This new voltmeter reads out in five full digits, plus a "1" for 20% overranging.

Able to be remotely programmed, the 8300A has serial or parallel outputs that are compatible with both DTL and TTL circuits. There are also built-in timing signals, ready indicators and flags.

Other features include a total reading time of 25 ms, requiring only 9 ms to sample the input. This allows 40 readings per second, including scanner settling time.

Serial-by-character data output and four-terminal bipolar ratio measurements are also possible with the 8300A digital voltmeter. Resistance capabilities include four-terminal ohms measurements and 50-ms measurements to 10 MΩ.

Both the 8100A digital multimeter and the 8300A digital voltmeter use ICs throughout.

MINIATURE MEGOHM RESISTORS

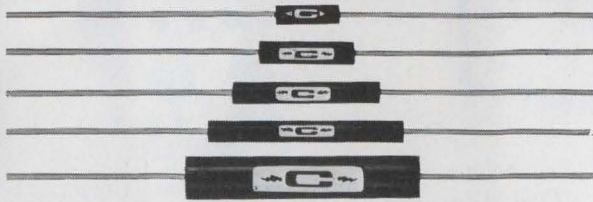

T.C. Absolute: 80 PPM/°C*
T.C. Tracking: to 5 PPM/°C on special order.

Applications include high voltage dividers, high resistance networks, precision RC timing circuits, etc. We specialize in network sets with matched characteristics. Facilities available to perform Hi Rel screening.

Model No.	Watt- age	Max. Voltage	Dielect. Str'gth	Resistance		Dimensions		
				Min.	Max.	Length	Dia.	Lead Dia.
MH 651	.5	600	750	500 K	5 meg.	.313 ±.020	.094 ±.006	.025 ±.002
MH 661	.6	1000	2000	1 meg.	10 meg.	.500 ±.030	.114 ±.010	.025 ±.002
MH 681	.8	1500	2000	1 meg.	15 meg.	.750 ±.030	.114 ±.010	.025 ±.002
MH 713	1.0	2000	2000	1 meg.	20 meg.	1.000 ±.030	.114 ±.010	.025 ±.002
Type MH with special internal shielding, designed to eliminate degradation due to corona								
MH 711	1.0	2000	2000	1 meg.	20 meg.	1.200 ±.040	.220 ±.015	.025 ±.002

*Temperature Coefficient: 80 ppm/°C referenced to 25°C, Δ R taken at -15°C and +105°C. Maximum operating temperature: 175°C. Resistance Tolerance: ±1% (tolerances to .2% on special order). Insulation Resistance: 100 megohms, minimum. Overvoltage: 1.5 times working voltage for 5 seconds, R shift .8% max. Thermal Shock: MIL-STD-202, method 107, cond. C, R shift .5% max. Moisture Resistance: MIL-STD-202, method 106, R shift .8% max. Loadlife: 1000 hours at rated power, R shift .8% max. Encapsulation: Molded Silicone. Leadwire: Gold Plated Dumet 1½" long ±¼".

MICRONOX™ Resistance Films

Micronox resistance films are produced exclusively by Caddock Electronics. They are composed of complex oxides fired in air at temperatures above 1400°F. The resulting films are relatively insensitive to high ambient temperatures and thermal shock. Films show negligible effect from moisture.

This totally new approach to precision resistors and networks opens new design possibilities because of the wide resistance range, precise temperature characteristics, and high temperature and power capability. Temperature coefficient can be accurately reproduced (within ±10 ppm/°C of curve if required). The typical curve shown below will vary slightly with resistivity of the film and configuration of the substrate.

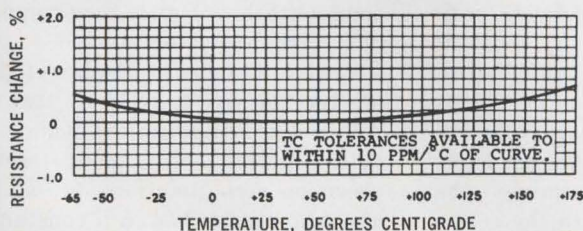

CADDOCK ELECTRONICS

3127 Chicago Avenue, Riverside, California 92507 • (714) 683-5361

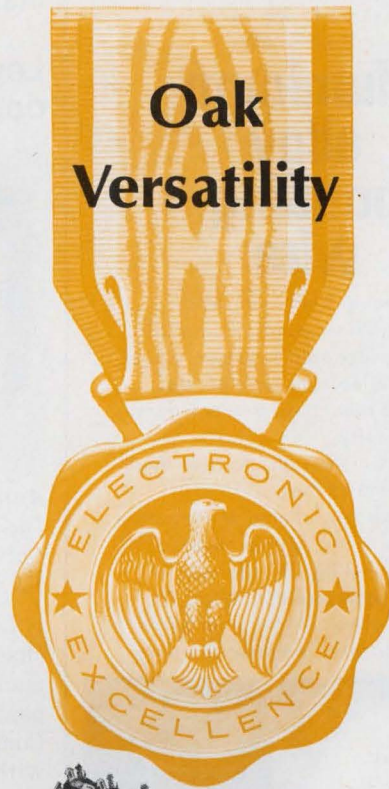

Ultra Compact Rotary Switch 1/2" does a man-sized job

Rugged rotary outperforms its nearest competitors by the widest of margins, gives you man-sized performance at a bargain price. Don't believe it? Compare:

FEATURES	OAK 1/2" SWITCH	BRAND "A" SWITCH	BRAND "B" SWITCH
Double-wiping contacts	Yes	No	No
½" Diameter	Yes	Yes	Yes
Multiple Decks	Yes	No	Yes
P. C. Capability	Yes	Yes	Yes
Tri-Ball Detent	Yes	No	No
Adjustable Stops	Yes	No	No
Designed to Meet Mil-S-3786/19	Yes	No	No
Available through Electronic Distributors	Yes	No	No
COMPARE!	OAK LOWEST in Cost	Cost is 60% HIGHER	Cost is 140% HIGHER

GET OAK QUALITY PLUS THE LOWEST PRICE IN THE INDUSTRY

For full details on the sub-miniature switch that does more, write today for Bulletin SP-299.

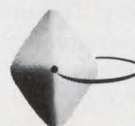

OAK MANUFACTURING CO.
 A Division of OAK ELECTRO/NETICS CORP
 Crystal Lake, Illinois 60014
 Phone: 815-459-5000 TWX: 910-634-3353

Sigmund Cohn Corp.
Offers Fine Sizes
in High Quality

Aluminum alloy bonding wire

In producing Aluminum Alloy Bonding Wires our staff carefully checks every step to assure you of sound, reliable, uniform bonds...

- The wire must have the maximum homogeneity
 - It is drawn through the best available diamond dies
 - After complete diameter-reduction the wire is thoroughly cleaned.
 - Final annealing (if required) is fully temperature-controlled for uniform physical characteristics.
- Write for latest engineering data.

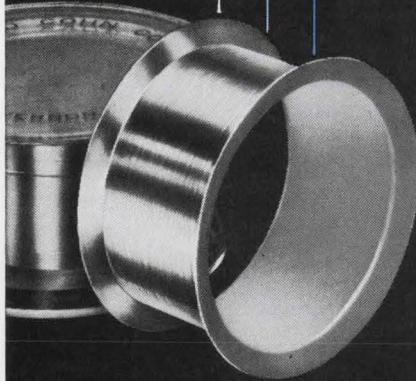
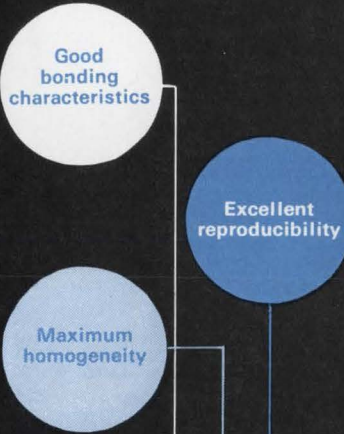

SIGMUND COHN CORP.

121 So. Columbus Ave.
Mt. Vernon, N.Y. 10553
914-664-5300



Since 1901

INSTRUMENTATION

Logic circuit analyzer does scope-like job



Automated Control Technology Inc., 3452 Kenneth Dr., Palo Alto, Calif. Phone: (415) 328-6080. P&A: \$325; 2 to 6 wks.

Logic Scope is a new four-channel instrument that displays many functions that were formerly possible only with an oscilloscope. Combining solid-state circuitry with visual indicators, the unit can display static and dynamic logic levels, and detect and identify pulses as narrow as 50 ns at repetition rates up to 10 MHz, regardless of duty cycle or risetimes and falltimes.

CIRCLE NO. 251

Automatic counters go out to 500 MHz

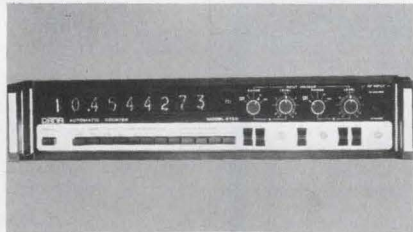

Dana Laboratories, Inc., High Frequency Div., 2401 Campus Drive, Irvine, Calif. Phone: (714) 833-1234. Price: from \$1495.

With fully automatic operation, series 8100 counters provide optimum accuracy and a constant eight-digit resolution at all frequencies from 0.05 to 500 MHz. Full measurement accuracy is obtained through IC computer logic, which optimally determines the ratio of the unknown to the reference frequency. Awkward period-to-frequency calculations are eliminated. Rf sensitivity is typically 500 μ V.

CIRCLE NO. 252

Three-inch scope sells for \$99



Leadler Instrument Corp., 24-20 Jackson Ave., Long Island City, N.Y. Phone: (213) 729-7411. P&A: \$99; stock.

Developed for field use, as well as multichannel monitoring applications, a new \$99 oscilloscope with a 3-in. screen has a narrow 4-in. chassis that allows many scopes to be placed side by side for maximum density. With a bandwidth of 1 MHz, model LBO-31M can be used for applications into the video region.

CIRCLE NO. 253

Digital IC tester displays parameters



CGS Units, Inc., 73 Saginaw Drive, Rochester, N.Y. Phone: (716) 244-2080. Price: \$2500.

Combining several testing functions with low cost, a new compact microcircuit tester includes features like numerical display of parameters and programmed testing. Additional highlights include a determination of fanout ratios, precision step functions for accurate measurements and a constantly monitored power drain. A single pre-programmed front-panel matrix card sets up the system for a specific microcircuit.

CIRCLE NO. 254

Peak-reading DVM tracks and reads

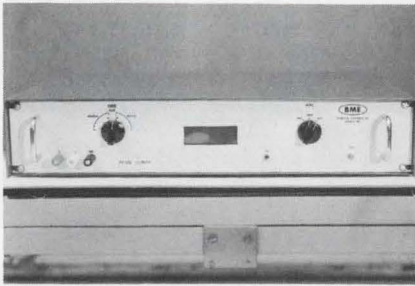

Bio-Medical Electronics, Inc., sub. of ILC Industries, Inc., 653 Lofstrand Lane, Rockville, Md. Phone: (301) 762-8373. P&A: from \$945; 30 days.

Satisfying broad range of instrumentation requirements, the PV 122 peak-reading digital voltmeter has three modes of operation: minimum, maximum and track. The track mode provides continuous tracking of the input signal, while the maximum (or minimum) mode permits automatic readout and display of the peak (or valley) value.

CIRCLE NO. 255

Audio/lab scope goes to 200 kHz



Kenwood Electronics, Inc., 3700 S. Broadway Place, Los Angeles, Calif. Phone: (213) 232-7217. Price: \$200.

With a frequency response of -3 dB or less from 3 Hz to 200 kHz, a new low-cost solid-state audio/lab scope provides vertical and horizontal amplifier sensitivities of 25 mV pk-pk per cm at front-panel inputs. Model KC-6060 has a four-step sweep generator that covers the frequency range from 10 Hz to 100 kHz. It consumes 25 W from any standard ac line source of 110/120 V at 50/60 Hz.

CIRCLE NO. 256

Telemetry



L and S band FM Signal Generator

PROGRAMMABLE (REMOTE) OPERATION

Carrier Frequency: Programmable within band by 3 decade (BCD) contact closures or logic levels

IRIG Channel: Programmable by contact closures, 21 lines

RF Attenuation: Fixed steps programmable by contact closure, 9 lines

MODEL 1522 new FM signal Generator for the telemetry L and S bands uses phase-lock techniques to provide

- superior stability and accuracy
- digital control of RF frequency
- set up for remote operation of BCD programmability.

RF FREQUENCY

Settability: 100 KHz, digital control

Accuracy: $\pm .002\%$, calibrated after one half hour warm-up.

Stability: Drift plus incidental FM less than ± 2 KHz pk for 1 minute, less than ± 5.0 KHz pk for 10 minutes, less than ± 15 KHz for one hour. (Residual FM: < 1.5 KHz on L Band; < 2.0 KHz on S Band)

RF OUTPUT

Range: 0 dbm to -120 dbm

Calibration accuracy: Overall ± 1 db over band

Levelling: < 1.5 db pk-pk across each band

Spurious: All in-band spurious signals more than 50 db below the calibrated output level

Harmonically related > 20 db below calibrated output

MODULATION

Peak FM deviation: ± 3 MHz (from < 10 KHz)

Frequency response: ± 1 db; DC to 750 KHz
 ± 1.5 db; to 1.0 MHz
 $+2, -3$ db; to 2.0 MHz

Frequency linearity: 1% of straight line for all deviations up to ± 1.0 MHz at modulating frequencies from DC to at least 1.0 MHz

TO STRAIGHT LINE	DEVIATION		MODULATING FREQUENCY
L Band:			
$< 0.5\%$ @	$\pm .5$ MHz	and	.5 MHz
$< 1.0\%$ @	± 1 MHz	and	1 MHz
$< 7.0\%$ @	± 3 MHz	and	2 MHz
S Band:			
$< .03\%$ @	$\pm .5$ MHz	and	.5 MHz
$< 0.7\%$ @	± 1 MHz	and	1 MHz
$< 4.0\%$ @	± 3 MHz	and	2 MHz

CALIBRATED DEVIATION MONITOR

Range: DC to 3 MHz in five ranges. Full scale 30 KHz, 100 KHz, 300 KHz, 1.0 MHz, and 3.0 MHz.

Accuracy: $\pm 5\%$ of full scale, for all modulating frequencies from 5 Hz to 500 KHz

KAY ELECTRIC COMPANY

MAPLE AVENUE, PINE BROOK, NEW JERSEY 07058 / PHONE (201) 227-2000

1st RATE 2nd SOURCE

DUAL 15 VDC



\$49⁰⁰*

OP-AMP POWER SUPPLY

Computer Products' new PM 502 power supply exhibits superior performance to and is a direct physical and electrical replacement for "Brand A's" Model 902. Contains two transformers to prevent interaction. Output impedance shows a 10-to-1 advantage, line/load regulation 5-to-1. The PM 502 is pin-compatible with other major power supplies. Operates directly from 115VAC, ± 10 VAC, 50 to 400 Hz; 230VAC also available.

We don't mind being a second source, when we can offer a better product at less cost. PM 502 is the newest member of a large family: PM 526 dual 12V
PM 528 dual 18V
PM 541 dual 24V

Other dual power supplies available . . . write for detailed specifications!

PM 502 SPECIFICATIONS

Input Voltage	115VAC ± 10 VAC, 50-400Hz
Output Voltage	± 15 to 15.3VDC
Output Current	0 to 100 MA each
Line-Load Reg. Each	$\pm 0.02\%$
Temp. Coeff.	0.01%/°C typical
Ripple/Noise	0.5mV RMS max.
Output Z @ 10KHz	0.2 ohms
Temp. Range	0° to 71°C
Case Size	3.5"x2.5"x1.25" plus pins

UNIT PRICES

1-3, \$59; 4-9, \$55; *10-29, \$49

SHIPMENT: 1 to 5 DAYS ARO

Computer Products, Inc.
P.O. Box 23849
Ft. Lauderdale, Fla. 33307
Phone 305/565-9565



COMPUTER
PRODUCTS™

FORT LAUDERDALE

COMPONENTS

Ceramic 15-mil chips mate directly with ICs

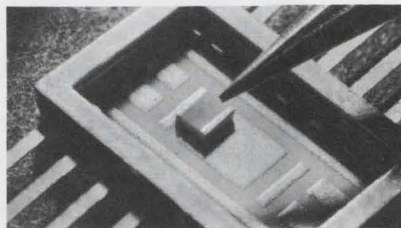

Varadyne, Inc. 1805 Colorado Ave.,
Santa Monica, Calif. Phone: (213)
394-0271. P&A: 50¢ to \$2.50; stock
to 4 wks.

Featuring direct compatibility with integrated circuits, a new line of ceramic chip capacitors have a monolithic construction with a maximum total thickness of only 15 mils. This means that the new capacitors can be mounted adjacent to integrated circuit chips in standard IC packages.

They are ideally suited for applications requiring circuit optimization, where it is desired to improve IC temperature performance and operating speeds. Other uses include filtering, bypass, coupling and isolation.

Both NPO and BX types are available with working voltage ratings of 50 Vdcw. They offer very high values of capacitance and Q factor, in addition to outstanding reliability and stability.

There are five possible chip sizes. The smallest of these measures 50 by 50 by 15 mil for capacitances from 15 to 47 pF for the NPO types, and 100 to 1800 pF for the BX types. The largest size is 120 by 95 by 15 mils for capacitances of 69 to 270 pF for the NPO types and 100 pF to 0.01 μ F for the BX types.

Over the temperature range of -55 to $+125^\circ\text{C}$, the NPO chips experience a capacitance change of less than $0\% \pm 20$ ppm/°C. For the same temperature range, the BX devices hold capacitance changes to $\pm 15\%$.

Q factor is greater than 5000 at 1 MHz for the NPO units. Standard capacitance tolerances are ± 5 , ± 10 and $\pm 20\%$; tolerances of ± 1 and $\pm 2\%$ can be ordered for NPO types.

A line of IC-compatible chip resistors is also available.

CIRCLE NO. 257

Uhf/vhf LC circuits tune electronically

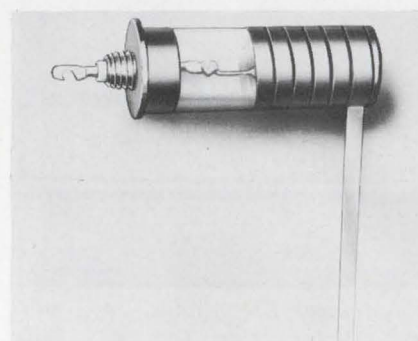

MSI Electronics Inc., 34-32 57th
St., Woodside, N.Y. Phone: (212)
672-6500. P&A: \$24.50; 2 wks.

Integrating a high-ratio high-Q varactor tuning diode within a glass metalized inductor, a new compact electronically tunable LC circuit is now available for use in uhf/vhf oscillator, detector and filter applications. Eight models cover the frequency range of 25 to 465 MHz. Typical unloaded Q is 90 at 100 MHz, increasing with increasing voltage to 140 at 150 MHz.

CIRCLE NO. 258

Film resistors get DIP look

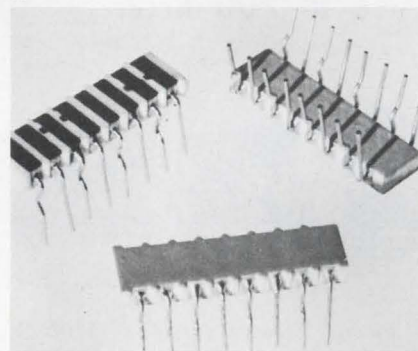

CTS Corp., div. of Berne, Inc., 406
Parr Rd., Berne, Ind. Phone: (219)
589-3111. P&A: 55¢ typical; 4 to
6 wks.

Increasing packaging flexibility, simplifying automatic insertions, and reducing assembly costs, series 760 dual-in-line cermet resistor networks contain up to 15 resistors per module with an infinite number of passive circuit combinations. The units, which come with 14 or 16 leads, can also be supplied as complete hybrid circuits.

CIRCLE NO. 259

PC transformers cover audio needs

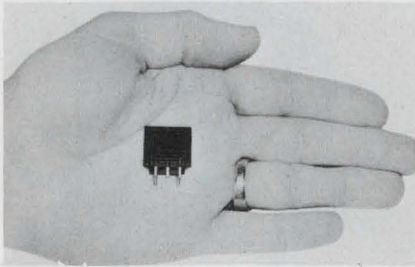

Essex International, Inc., Controls Div., Stancor Products, 3501 W. Addison St., Chicago, Ill. Phone: (312) 539-2000. P&A: \$4.80 to \$6.60; stock.

Designed for various audio applications, series TAPC PC-board transistor transformers include input, interstage and output units. Those in the 150-mW group have an approximate weight of 0.5 oz and measure 13/16 by 13/16 by 3/4 in. The 300-mW units weigh approximately 1 oz and are 7/8 by 1-1/16 by 15/16 in.

CIRCLE NO. 260

Audio transformer matches power ICs

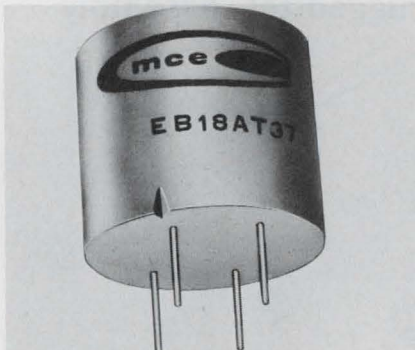

Magnetic Circuit Elements Inc., Del Monte Research Park, 2455A Garden Rd., Monterey, Calif. Phone: (408) 373-0456. P&A: \$3.15; 6 wks.

A new IC audio output transformer is specifically designed to provide isolation and impedance matching for popular power integrated circuits with outputs of 0.5 to 1 W. The unit is available for both single-ended and push-pull circuits. It is encapsulated for plug-in mounting on a standard 0.1-in. grid.

CIRCLE NO. 261



Simpson's new 2725.

Compare it with the electronic counter you were going to buy:

SPECIFICATIONS	SIMPSON 2725	YOUR COMPARISON
Wide frequency range?	YES. 5 Hz to 20 MHz.	
Measures frequency ratios?	YES. 1 to 1.99999 x 10 ⁵ .	
Measures time periods?	YES. 300 μ seconds to 0.2 second.	
Measures time intervals?	YES. 300 μ seconds to 1.99999 x 10 ⁵ seconds.	
Totalizes?	YES. 0 to 1.99999 x 10 ⁵ counts.	
Crystal controlled time bases?	YES. 6 xtal-controlled bases, switch selected.	
Self-test circuitry?	YES. Front panel switch tests logic circuitry.	
Dependable solid state design?	YES. Integrated circuits.	
Number of full time digits	5. Plus automatic overrange indication.	
Accuracy	±0.01% ±1 digit	
Price	\$525. complete with probe and operator's manual.	\$

4-digit Model 2724 also available: \$450.

GET "OFF-THE-SHELF" DELIVERY OF THE NEW SIMPSON DIGITAL ELECTRONIC COUNTERS AT DISTRIBUTORS STOCKING SIMPSON INSTRUMENTATION PRODUCTS

Simpson

ELECTRIC COMPANY



5200 W. Kinzie Street, Chicago, Illinois 60644 • Phone (312) 379-1121
Export Dept: 400 W. Madison Street, Chicago, Illinois 60606. Cable Simelco
IN CANADA: Bach-Simpson Ltd., London, Ontario • **IN INDIA:** Ruttonsha-Simpson Private Ltd., International House, Bombay-Agra Road, Vikhroli, Bombay

INFORMATION RETRIEVAL NUMBER 52

VECO THERMISTORS FOR MIL. APPLICATIONS



...the strength and sensitivity of an ant

Ever see an ant move masses larger than itself? Or the speed it responds with at the slightest sound?

Strength and sensitivity exactly like our line of thermistor disks and rods for military or industrial use. Each is manufactured to meet, or even exceed, the requirements of MIL-T-23648.

Rugged insulated design... high reliability... and precise accuracy... makes them especially suitable

for applications of temperature measurement and control, such as transistor circuitry, within a range of -55°C to $+125^{\circ}\text{C}$.

Whether your application is military or industrial, there is a VECO thermistor engineered for your requirements.

VECO **VICTORY
ENGINEERING
CORPORATION**
VICTORY ROAD, SPRINGFIELD,
NEW JERSEY 07081
(201) 379-5900 • TWX 710-983-4430

INFORMATION RETRIEVAL NUMBER 53

COMPONENTS

Fiber-optic readouts use LEDs or lamps

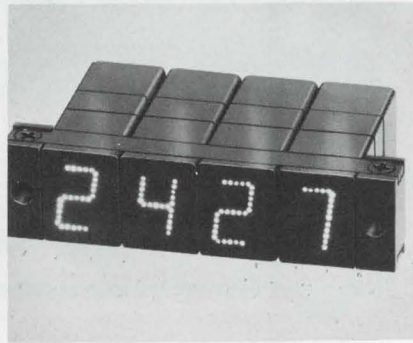

Master Specialties Co., 1640 Monrovia, Costa Mesa, Calif. Phone: (714) 642-2427.

Available with either solid-state (light-emitting diodes) or incandescent light sources, series 900 fiber-optic readouts feature high light intensity, low-power operation and extended life. Because of the efficiency of fiber optics, a brightness of 1000 foot-lamberts may be obtained using only low-power incandescent lamps. The new readouts generate dot-pattern characters.

CIRCLE NO. 262

DIP reed relay doubles terminals

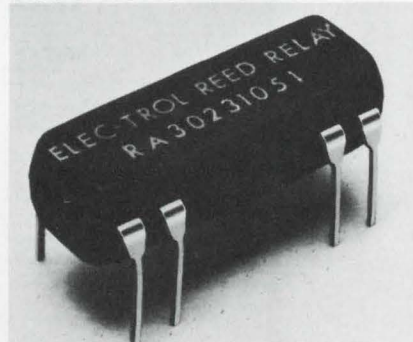

Elec-trol, Inc., 21018 Soledad Canyon Rd., P.O. Box 1, Saugus, Calif. Phone: (805) 252-8330. Availability: stock to 6 wks.

Intended for use with standard DIP and flatpack ICs, a new dual-in-line reed relay features dual terminals for all inputs and outputs. It meets military environmental specifications over the temperature range of -55 to $+85^{\circ}\text{C}$. The unit can operate directly from IC circuitry since it draws only 10 mA from 5-V logic.

CIRCLE NO. 263

Fixed delay lines come in TO-5 cans

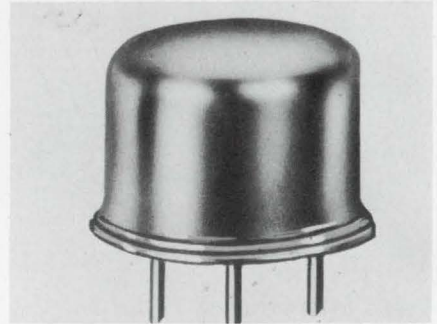

Control Electronics Co., 153 Florida St., Farmingdale, N.Y. Phone: (516) 694-0125. Availability: 2 wks.

A new series of fixed delay lines comes packaged in standard TO-5 cases for use on the same PC boards as plug-in TO-5 transistors. Series F-TO-5 includes delay times ranging from 0.01 to 0.16 μs with risetimes from 0.15 to 0.23 μs . There are 14 various models with impedances of either 200 or 500 Ω . Their temperature coefficient is less than 100 ppm/ $^{\circ}\text{C}$.

CIRCLE NO. 264

Sensitive thermistor ruggedizes assembly

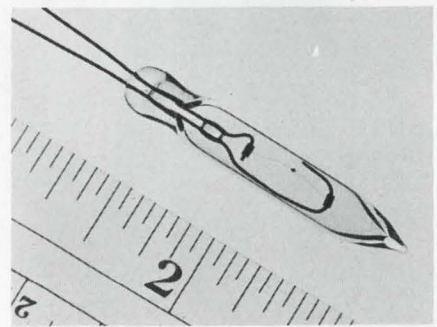

Fenwal Electronics Inc., div. of Walter Kidde & Co., Inc., 63 Fountain St., Framingham, Mass. Phone: (617) 875-1351.

Featuring high reliability and high resistance against shock and vibration, a new ruggedized bead thermistor is packaged in an evacuated glass bulb. This hermetically sealed thermistor assembly is relatively unaffected by ambient temperature changes, but extremely sensitive to power level changes. Nominal resistance rating is 100 k Ω at 25°C .

CIRCLE NO. 265



Amphenol has added **fixed contact, high density, encapsulated contact and power**

NOW AMPHENOL GIVES YOU A COMPLETE LINE of pin and socket connectors. We've added four new families to our original Poke-Home® and hard dielectric standards — fixed contact, high density, encapsulated contact and power/coax. And they'll intermate with the ones you're buying now.

EXPECT TWO BIG DIFFERENCES FROM AMPHENOL—availability and down-to-earth prices. We'll meet *your* delivery schedule and *match* prices with anyone.

SEND FOR A FREE WALL CHART showing all six families with a wide variety of pin configurations, contact types and dielectrics. Return the card in this ad or write Amphenol Industrial Division, 1830 S. 54th Ave., Chicago, Illinois 60650.

***Fixed Contact**—Fixed solder contacts with 2-piece glass-filled nylon insulator. **High Density**—Removable crimp Poke-Home® contacts with glass-filled nylon insulator. **Encapsulated Contact**—Removable crimp or solder Poke-Home® contacts with encapsulating nylon insulator. **Power/Coax**—Removable crimp or solder Poke-Home® contacts for either power or coax with glass-filled nylon insulator. **Original Poke-Home®**—Removable crimp or solder Poke-Home® contacts with nylon insulator. **Hard Dielectric**—Removable crimp or solder Poke-Home® contacts with diallyl phthalate insulator.

IC power supplies trim size and weight

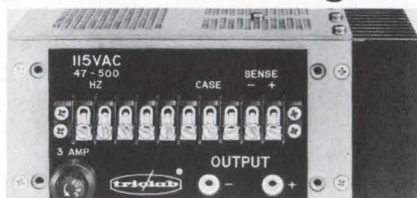

Trio Laboratories, Inc., 80 Dupont St., Plainview, N.Y. Phone: (516) 681-0400. P&A: \$400; stock.

Originally designed for use in military aircraft, a new series of power supplies for integrated circuits delivers from 100 to 120 W (depending on voltage level) in a package that is only one-third the volume and one-quarter the weight of conventional units. Series SP600 power supplies use switching regulators to achieve very high efficiencies in a compact package, while holding maximum noise and ripple to 50 mV pk-pk, including all spikes.

Of particular importance to computer people, the new supplies allow full-load operation for a minimum of 30 ms after the loss of ac input. This means that computer users can have enough time to stop all memory programming and avoid loss of stored data during any power failure.

The new supplies also offer automatic overload recovery, short-circuit protection, a built-in overvoltage crowbar, external sensing capability, and full-output-power operation to 71°C without heat sinking. Input rfi is well below that required by MIL-I-6181 and MIL-I-16910. Line and load regulation is less than 0.5%, and temperature coefficient is 0.02%/°C.

Supplied in a package that can be mounted in three different ways, the new units weigh only 6 lb and measure 3-1/4 by 6-1/2 by 7-1/2 in. Both single-output and dual-output supplies are available with efficiencies ranging from 60 to 90%.

Models SP601 through SP606 have nominal dc output voltages from 5 to 30 V, with currents ranging from 20 to 4 A, respectively. Models SP611 through SP614 provide voltages of ±7 to ±22 V and currents of 8 to 2-1/2 A.

CIRCLE NO. 266

Video amplifier slews at 450 V/μs

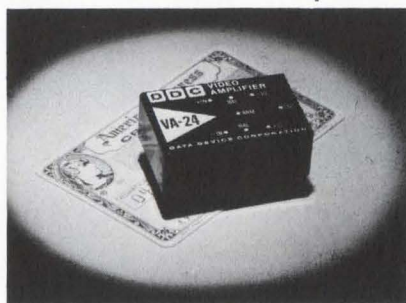

Data Device Corp., 100 Tec St., Hicksville, N.Y. Phone: (516) 433-5330. P&A: \$145; stock to three weeks.

With a slewing rate of 450 V/μs, a new differential FET video amplifier features a stable 6-dB/octave rolloff and a useful gain-bandwidth product of 50 MHz minimum. Model VA-24 has an output capability of ±30 mA at ±10 V. Minimum frequency for full output is 5 MHz, and open-loop dc voltage gain is 96 dB at rated load. Input bias current is 30 pA; voltage drift is 20 μV/°C.

CIRCLE NO. 267

FET-input amplifier has 100-dB CMRR

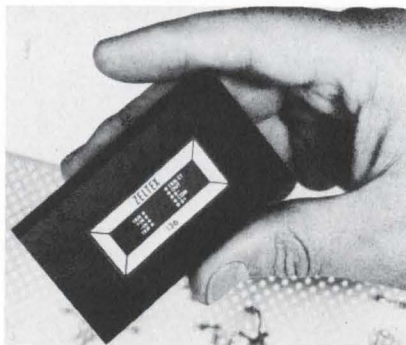

Zeltex, Inc., sub. of Redcor Corp., 1000 Chalomar Rd., Concord, Calif. Phone: (415) 686-6660. P&A: \$125; stock.

Model 136 FET-input differential operational amplifier guarantees a minimum common-mode rejection ratio (CMRR) of 100 dB over a common-mode voltage range of ±100 V minimum. The unit also features short-circuit-proof circuitry and -6-dB/octave frequency compensation. Initial offset voltage is only 0.5 mV without external components.

CIRCLE NO. 268

Hybrid ladders switch in 380 ns

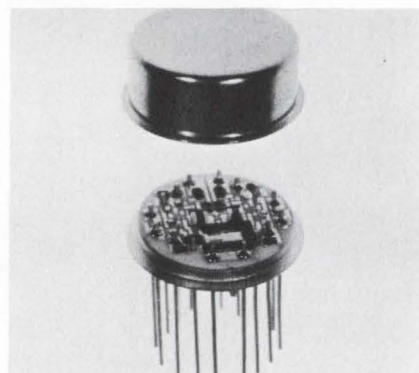

Mepco Inc., Columbia Rd., Morristown, N.J. Phone: (201) 539-2000.

Miniaturized to fit two switches into a hermetically sealed TO-8 can, a new precision ladder switch offers typical operating speeds of only 380 ns. These hybrid circuits can provide a switching accuracy of one-half the least significant bit without external switch compensation in the ladder network. They are available with high or low ladder currents, positive or negative reference voltages, and various input logic levels.

CIRCLE NO. 269

Computer-grade op amp slews at 30 V/μs min

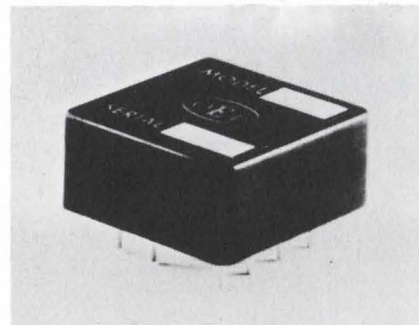

Optical Electronics Inc., P.O. Box 1140, Tucson, Ariz. Phone: (602) 624-8358. P&A: \$125; stock.

Providing computer-grade dc performance, a new operational amplifier features a minimum slew rate of ±30 V/μs. Minimum open-loop gain is 140 dB for model 9487 and maximum full-output frequency is 500 kHz. It has a maximum bias current of 30 nA and a minimum common-mode input rejection of 100 dB.

CIRCLE NO. 270

Four-phase sequencer interfaces MOS TTL

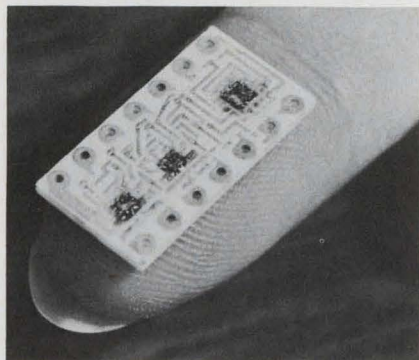

Cermetek, Inc., 660 National Ave., Mountain View, Calif. Phone: (415) 969-9433. Availability: stock.

Developed as a peripheral circuit to help solve MOS interface problems, a new four-phase sequencer can be used to generate multi-phase clock systems. All inputs and outputs of model CH1060 conform to standard TTL specifications. A single unit provides four sequential output clock drives and two slow phases; set input allows three-phase operation.

CIRCLE NO. 271

Time-delay module is programmable



Flight Systems, Inc., P.O. Box 25, Mechanicsburg, Pa. Phone: (717) 697-0333. Price: \$19.50 to \$24.75.

Either voltage or resistance programmable, a new solid-state time-delay module will interface with almost any type of logic or voltage signal. It is available in delay ranges from 500 ms to 5 minutes; higher delays up to 100 minutes are available on special order. At the end of the delay period, the module puts out 5 V dc of regulated voltage.

CIRCLE NO. 272



Chassis-Trak Slides ... where it really counts!

See you at
the WesCon
Booth 3005

Hard, cold-rolled steel makes Chassis-Trak Slides extra strong and cadmium-plating gives them protection against corrosion. Poxylube 75 dry-film lubricant continues to give smooth slide operation even after years of use . . . no matter what climate, what conditions.

Chassis-Trak Slides are instantly removable and interchangeable for in-

spection or emergency replacement when it really counts. Three basic slide designs—tilt, non-tilt, and tilt-detent—support up to 1,000 lbs., and permit thorough flexibility of use and application.

These are just some of the reasons Chassis-Trak is specified for military applications throughout the world . . . where it really counts. Why don't you find out why!

A package for every Major Missile Project from . . .
525 South Webster Ave., Indianapolis, Indiana



INFORMATION RETRIEVAL NUMBER 54

ENVELOPE DELAY AND LOSS MEASUREMENTS FROM 200 Hz TO 600 kHz

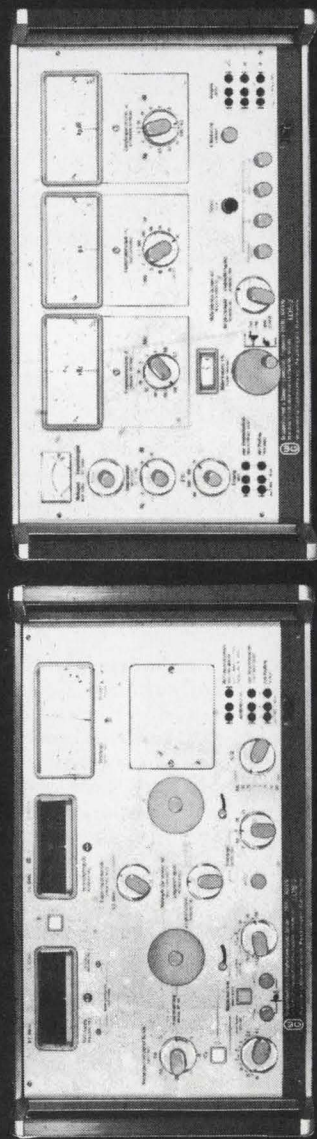

There are other less accurate, less versatile and less expensive design approaches than the one we chose for an instrument to measure envelope delay and attenuation distortion. Our philosophy is to produce only the finest measuring instruments current technology allows. Our objectives are precision measurements with confidence.

The principle we adopted for the LD-2 involves transmitting the reference frequency **through the unknown**, thereby providing an automatic and continuous phase control of the receiver. This eliminates a major source of potential error in systems that depend on the phase stability of an uncontrolled reference oscillator in the receiver for their accuracy. The approach is sophisticated and costly, but the result is versatility, accuracy, dependability and an instrument in which we take pride.



Wandel & Goltermann

West Germany/represented in U.S.A. by
W & G INSTRUMENTS, INC. 6 Great Meadow Lane,
Hanover, N. J. 07936 • Telephone: (201) 887-8700

10

ICs & SEMICONDUCTORS

Digital/linear ICs get beam leads

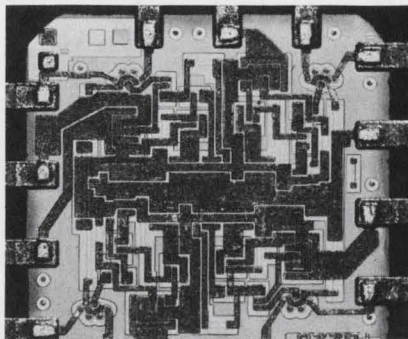

Raytheon Co., Components Div., Semiconductor Operation, 350 Ellis St., Mountain View, Calif. Phone: (415) 968-9211. Price: \$1.25 to \$7.10.

A new line of beam-lead chips is now available that includes both linear and digital integrated circuits as well as transistors and diodes. Military-grade units operate over the temperature range of -55 to $+125^{\circ}\text{C}$, while commercial-grade units perform from 0 to 75°C .

CIRCLE NO. 293

Military zeners dissipate 5 W

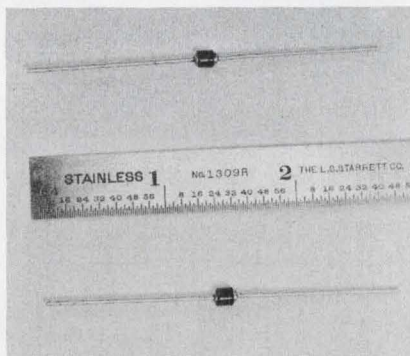

Microsemiconductor Corp., 11250 Playa Court, Culver City, Calif. Phone: (213) 391-8271. P&A: \$3.55 or \$4.55; stock to 2 wks.

A new line of glass 5-W axial-lead JAN and JAN TX zener diodes, types 1N4954 through 1N4969, meet the requirements of MIL-S-19500E/356A and MIL STD-701. Voltage ratings range from 6.8 to 30 V. The devices have a 0.14-in. maximum diameter and a 0.23-in. maximum length.

CIRCLE NO. 294

◀ INFORMATION RETRIEVAL NUMBER 55

Phototransistors join LED family

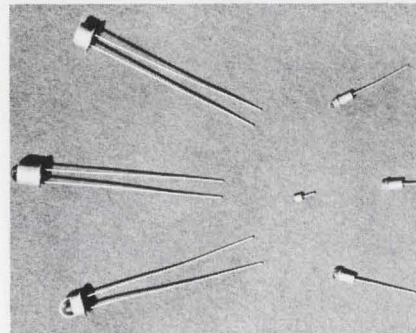

Electro-Nuclear Labs., Inc., 115 Independence Drive, Menlo Park, Calif. Phone: (415) 322-8451. P&A: from 52¢; stock to 30 days.

A complete line of npn planar high-gain industrial silicon phototransistors and companion continuous or pulsed gallium-arsenide light-emitting diodes is now available. The phototransistors assure minimum crosstalk when used in a high-density array; the new LEDs allow selection of highly directional or divergent beams.

CIRCLE NO. 296

Avalanche rectifiers withstand 10 kV

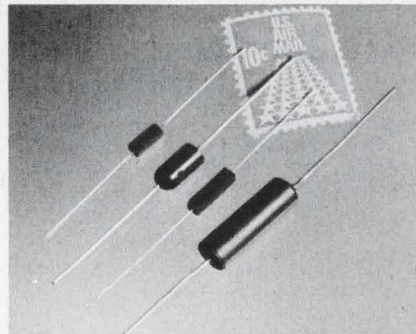

Atlantic Semiconductor, div. of Aerological Research, 905 Mattison Ave., Asbury Park, N. J. Phone: (201) 775-1827.

Able to carry continuous currents of 100 or 200 mA, a new series of avalanche silicon rectifiers can handle voltages as high as 2000 to 10,000 V. They are available with recovery times as fast as 300 ns. These high-voltage medium-current devices are designed for both commercial and industrial applications.

CIRCLE NO. 297

Monolithic comparator works like a hybrid

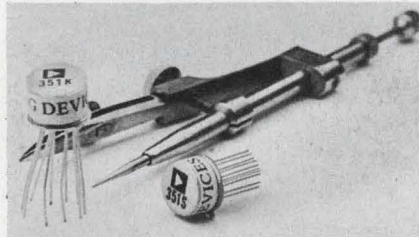

Analog Devices, Inc., 221 Fifth St., Cambridge, Mass. Phone: (617) 492-6000. P&A: \$11.70; stock.

Model 351 differential dc comparator is a monolithic device designed for accurate sensing and measuring applications that have previously required discrete-component units. Capable of resolution in the fractional millivolt and sub-microamp regions, the new comparator will handle 0.1-M Ω signal sources. It also eliminates the need for an auxiliary preamplifier, output booster, protection circuit, and special power supply regulator frequently required with earlier IC types.

CIRCLE NO. 273

Flatpack IC op amps slim to 175-mil dia



Mini-Systems, Inc., P.O. Box 429, N. Attleboro, Mass. Phone: (617) 695-0206. P&A: \$9.50; stock.

Containing type 201 and 741 operational amplifier chips, a new series of miniature flatpacks reduce by over 60% the space required for similar devices packaged in standard TO-91 packages. Tiny-Pak IC op amps are hermetically sealed units with a 175-mil diameter and 0.5-in. lead spacings. They permit efficient conventional handling, testing and insertion techniques.

CIRCLE NO. 274

Npn photodetector senses to near-IR

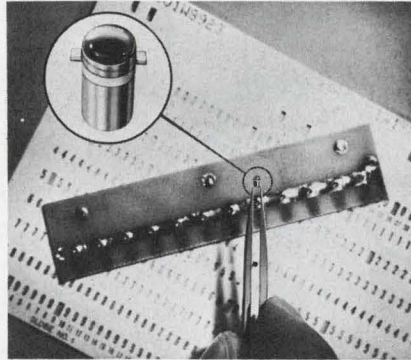

Motorola Semiconductor Products Inc., P.O. Box 20924, Phoenix, Ariz. Phone: (602) 273-6900. P&A: \$6; stock.

Useful as a fast optical switch, a new npn silicon photodetector offers high radiation sensitivity throughout the visible and near-infrared spectral ranges. Type MRD600 features a minimum collector-emitter radiation sensitivity of 0.04 mA/mW/cm², which corresponds to a minimum light current of 0.8 mA at a radiation flux density of 20 mW/cm².

CIRCLE NO. 275

Phototransistor array separates elements

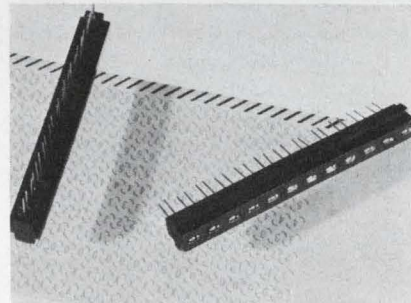

Fairchild Semiconductor, 313 Fairchild Drive, Mountain View, Calif. Phone: (415) 962-3563. Price: \$30.

Housed in a 3-in.-long 24-lead plastic package, a new array of 12 npn phototransistors allows individual access to the emitter and collector of each sensing element. Each detector performs with switching times of approximately 3 μ s and requires no additional stage of gain. The FPA710 array consists of 40 by 40 mil chips aligned at 0.25-in. intervals.

CIRCLE NO. 276

INFORMATION RETRIEVAL NUMBER 56 ▶

ELFIN
2.99 *

think digital

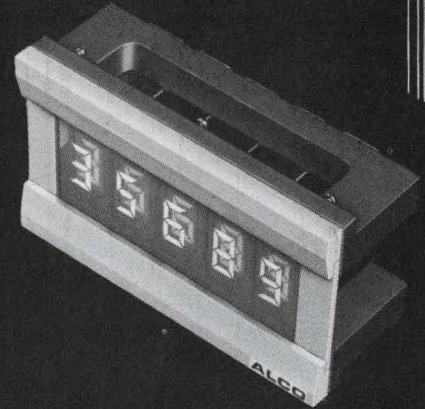
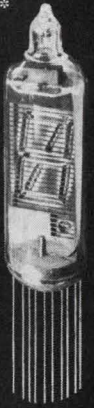

MS-4000
3.85 *

Think ELFIN—the new single plane, segmented neon readout indicator that provides brighter displays and wider viewing. Only 0.41" dia. ELFIN display 0-9, + and -, some alpha symbols and decimal.

The MS-4000 Series has new readouts added to include numeric and symbol indications. Each model is a miniature enclosed readout with the flat single-plane viewing, and uses 100,000 hr. #683 T-1 subminiature lamps. Plug-in feature expedites replacement. Photograph above shows five MS-4000 readouts used with a module mounting and bezel kit.

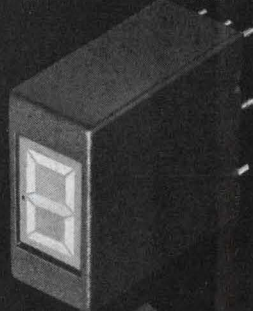

MS-250
4.97 *

ALCO's RK numeric and symbol readouts have a unique in-line design to provide clear displays without focusing problems. The precision machined 1-piece aluminum case also serves as a heat sink.

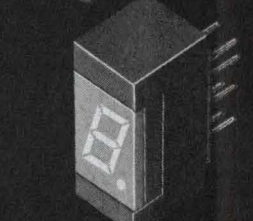

MS
4.97 *

The MS Mosaic numeric segmented indicators are available in 2 sizes and use either 6, 14 or 24V lamps for flexibility in design.

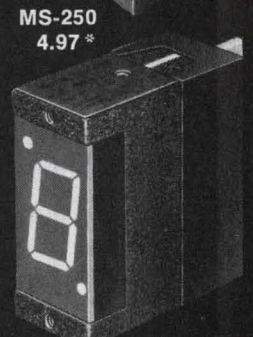

MSM-5A
4.97 *

SEND FOR
ALCO—NUMERIC
CATALOG

* 1000 Lot Prices
See us at WESCON 5120

ALCO

ELECTRONIC PRODUCTS, INC.

RCL SWITCH INFORMATION CENTER

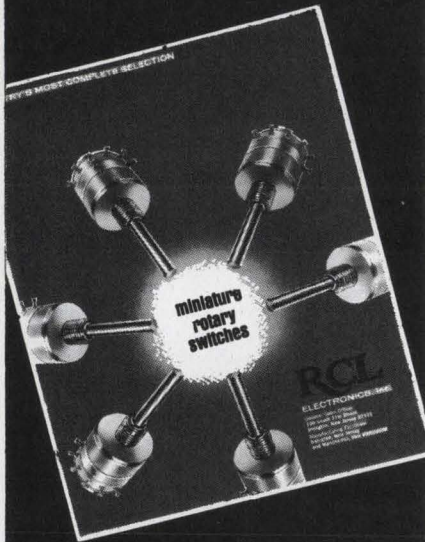

AN EASY-TO-READ
NEWLY EXPANDED
TECHNICAL CATALOG OF
INDUSTRY'S MOST
COMPLETE SELECTION
OF
**MINIATURE
ROTARY
SWITCHES**

WRITE FOR YOUR FREE COPY

RCL

General Sales Office
RCL ELECTRONICS, INC.
700 South 21st Street
Irvington, New Jersey 07111

INFORMATION RETRIEVAL NUMBER 57

ICs & SEMICONDUCTORS

Hybrid clock driver powers 15 flip-flops

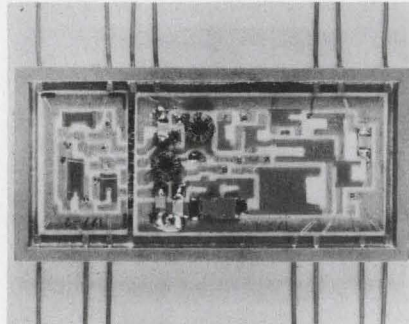

*Sylvania Electric Products Inc.,
Hybrid Microelectronics Operation,
100 First Ave., Waltham, Mass.
P&A: \$78; 4 wks.*

Model MS301 20-MHz film hybrid clock driver can drive up to 15 transistor-transistor-logic flip-flops. The new device has multiple ground leads, internally connected bypass capacitors, and a pin arrangement that permits convenient mounting near the flip flops to be driven. The all-metal hermetically sealed module is compatible with flatpacks and dual-in-line packages.

CIRCLE NO. 277

TTL digital circuits dissipate 1 mW/gate

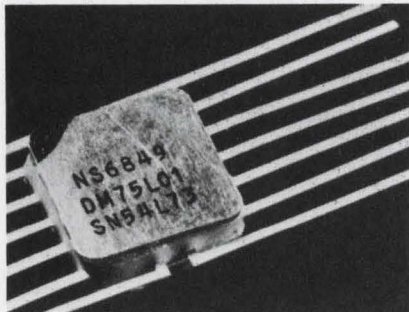

*National Semiconductor Corp., 2950
San Ysidro Way, Santa Clara,
Calif. Phone: (408) 245-4320.
P&A: \$4.50 to \$17; stock.*

Requiring only 1 mW per gate, a new line of low-power TTL integrated circuits are manufactured utilizing a monometallic interconnect system and aluminum metallization and wires. Series DM75L/DM85L devices are supplied in a 1/4 by 1/4-in. flatpack. Included are multi-input gates and dual flip-flops.

CIRCLE NO. 278

Hybrid IC ladder matches 4 switches

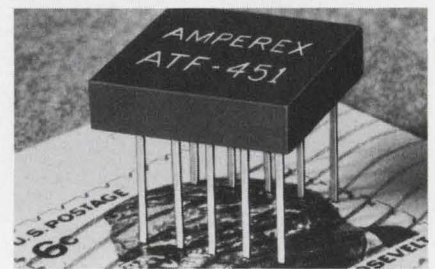

*Amperex Electronic Corp., Micro-
circuits Div., Cranston, R. I. Price:
\$9.*

Intended for use in binary and BCD coded voltage summing ladders with up to 14 bits, a new quad d/a ladder switch is said to represent the smallest set of four matched switches ever offered in a single hybrid integrated circuit. Fully compatible with standard DTL and TTL circuits, model ATF-451 has an on-resistance of only $4 \pm 1 \Omega$ and a maximum offset voltage of 1 mV.

CIRCLE NO. 279

Monolithic regulator removes voltage limit

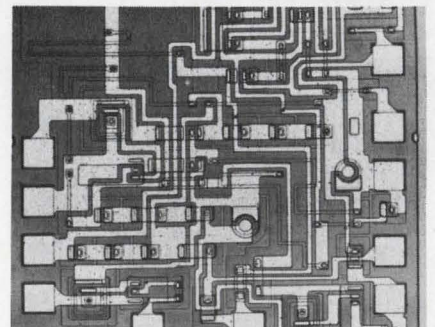

*Motorola Semiconductor Products
Inc., P.O. Box 20924, Phoenix,
Ariz.. Phone: (602) 273-6900.
P&A: \$24.50; stock.*

Capable of kilovolt operation, a new monolithic voltage/current regulator is designed to control an external power transistor and will operate at any voltage or current level that the power transistor can handle. In addition, performance is on the level of laboratory-type supplies. Model MC 1566L features voltage and/or current adjustable to zero, remote sensing and remote programming.

CIRCLE NO. 280

DATA PROCESSING

Analog coupler records digitally

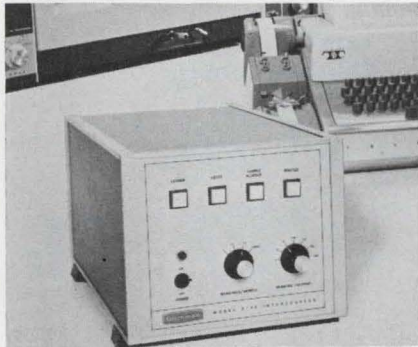

Beckman Instruments, Inc., Electronic Instruments Div., 2400 Harbor Blvd., Fullerton, Calif. Phone: (714) 871-4848.

Designed for use with industrial process monitors or analytical instruments with a single-channel analog output, a new compact data acquisition system converts analog data to a digital record. The output of model 3108 analog-to-teleprinter coupler can be a printed record produced on a standard teletypewriter, or a perforated paper tape.

CIRCLE NO. 281

Aerospace computer weighs only 9 lb

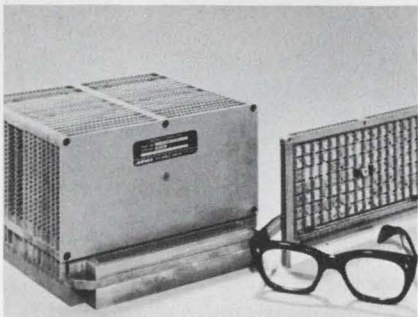

AMBAC Industries, Arma Div., Roosevelt Field, Garden City, N.Y. Phone: (516) 742-2000.

Suited for real-time aerospace applications, a new parallel general-purpose computer is a military miniaturized system weighing less than nine pounds. Model 1808 is an 18-bit word computer with 56 instructions. It features a multi-layer board configuration and TTL medium-scale integrated circuits.

CIRCLE NO. 282

Accurate a/d converter works 8 bits at 1 MHz



Inter-Computer Electronics, Inc., 1213 Walnut St., Lansdale, Pa. Phone: (215) 855-0922.

Combining rapid conversion rates with minimum sample-and-hold aperture times, Model IAD-1850 analog-to-digital converter converts analog signals to an eight-bit digital word at speeds up to 1 MHz. Total conversion time is 1 μ s, including sample-and-hold for an eight-bit resolution. Over-all accuracy is $\pm 0.2\%$ of full scale for signal bandwidths of 500 kHz or less.

CIRCLE NO. 283

Photo-optical memory stores billions of bits



Foto-Mem, Inc., 2 Mercer Rd., Natick, Mass. Phone: (617) 655-4600.

Said to be an industry first, a new photo-optical random-access mass memory with a multi-billion bit capacity can be used to replace and/or supplement magnetic-tape, disc or drum units. Used separately or combined into one system, the FM 390 offers several advantages over magnetic storage: a 100-to-1 reduction or greater in material cost, a storage space reduction of 150-to-1 or greater, and a 50-ms access time.

CIRCLE NO. 284

INFORMATION RETRIEVAL NUMBER 58 ▶

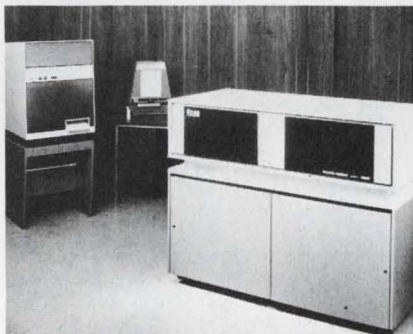
designer's keyboard

SB-033 — INTERLOCK
SB-034 — MOMENTARY

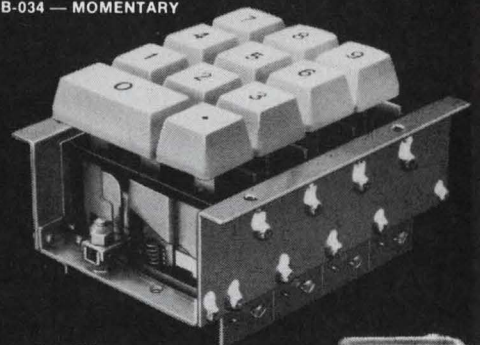

28.50 User Net

The ALCO modular idea is a simple concept for the design engineer to create his own custom push button layouts from "stock" switch modules and assemblies.

The basic modules allow use of up to twelve (shown at right) switches per section. A designer may stack any number of these switch sections in a group by themselves or in conjunction with the ALCO mating 12-segment keyboard assemblies (shown above).

Highly efficient, single pole "normally open" reed switches are used throughout, thus assuring reliability and extremely long life expectancy.

For design-service assistance and price quotations, call (Area 617) 686-3887.

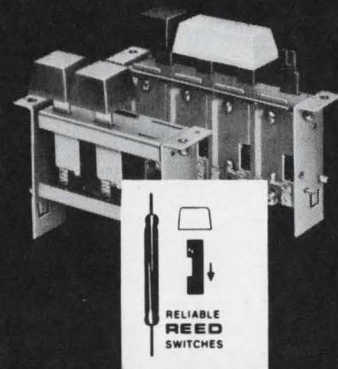

Available as Momentary and Interlock

See us at WESCON 5120

ALCO

ELECTRONIC PRODUCTS, INC.

Lawrence, Massachusetts 01843

NEW! POWERTEC GR* POWER SUPPLIES

PRICED FROM
\$29⁰⁰



* Guaranteed Reliability

PRICE & QUALITY OPTIMIZED

New low cost family of units for applications with IC's, other digital logic, OP amps and low voltage analog circuits.

Only MIL and computer grade components are used in this versatile family. Calculated reliability per MIL-HDBK-217A exceeds 150,000 hours.

Output voltages are available from 3.6 to 36VDC with $\pm 0.1\%$ regulation in a variety of types including fully adjustable units.

Input: 115VAC 47-440 Hz

Typical Outputs: 0 to 36V at .25A
5.0V at 2.5A
 $\pm 15.0V$ at .5A

The Powertec GR Series is currently available from stock. Detailed specifications and prices are available upon request.

CUSTOM POWER SYSTEMS

Powertec's experts are capable of solving your most difficult power conversion requirements.

POWERTEC DIVISION

9168 DeSoto Ave., Chatsworth, Calif. 91311
Phone (213) 882-0004



INFORMATION RETRIEVAL NUMBER 59

DATA PROCESSING

Fast microfilm system records computer data

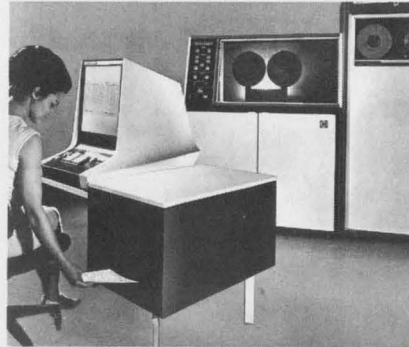

Burroughs Corp., Business Machines Group, Detroit, Mich. Phone: (313) 875-2260. P&A: \$85,000 to \$125,000; fall, 1969.

Designated BCOM (Burroughs Computer Output-to-Microfilm), a new electronic system can record computer output on microfilm up to 40 times faster than a line printer can record the same information on paper. BCOM can microfilm computer-generated records at up to 96,000 characters per second.

CIRCLE NO. 285

CRT graphics terminal links medium computers



Adage, Inc., 1079 Commonwealth Ave., Boston, Mass. Phone: (617) 783-1100. P&A: \$40,000; 4 months.

Intended for use as a dependent graphics extension to medium-sized computers, model AGT/5 graphics terminal contains its own 30-bit 4k core processor for image processing, display control, and communications formatting. The operator's console houses a large, 21-inch, high-resolution CRT with light pen and controls. Coupling to the host computer may be done either directly or via telephone lines.

CIRCLE NO. 286

Printing calculator doubles as computer



SCM Corp., Smith-Corona Marchant Div., 299 Park Ave., New York City. Phone: (212) 752-2700. Price: \$2495.

An electronic printing calculator with separate mathematical function registers for routine calculations can also be programmed and used as a desktop computer. Multiplication and division calculations can be performed on the Cogito 1016PR in one sequential chain, without the necessity of re-entering factors or subtotals.

CIRCLE NO. 287

Receiving teleprinter accepts full pages



Codamite Corp., 11822 Western Ave., Stanton, Calif. Phone: (714) 894-3535.

Featuring integrated circuit electronics, a new full-page receive-only teleprinter is available for serial ASCII or Baudot codes at speeds up to 15 characters per second. Model 771 greatly simplifies its mechanical system by using digital stepper motors for type font and hammer indexing. With a ribbon option, printing is on ordinary paper, teleprinter rolls or dittomaster.

CIRCLE NO. 288

Cable systems plug in and out

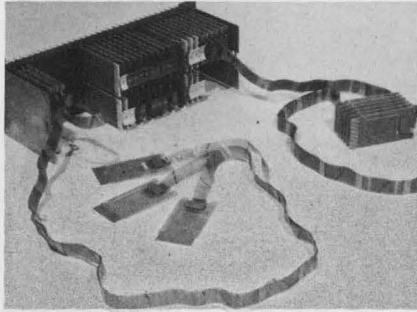

Aci Inc., 206 Industrial Center, Princeton, N.J. Price: \$1/ft, \$22.50/card.

Single-layer and multi-layer transmission-line cable systems for most popular small and desk-top digital computers can now be ordered to desired length with PC cards terminated to both ends, ready to plug-in and mate to existing connectors. Signaflo cables use a non-metallic isolation material that maintains low layer-to-layer cross-talk. The velocity of propagation is 1.55 ns per foot.

CIRCLE NO. 289

Circuit evaluation kit includes dual supply

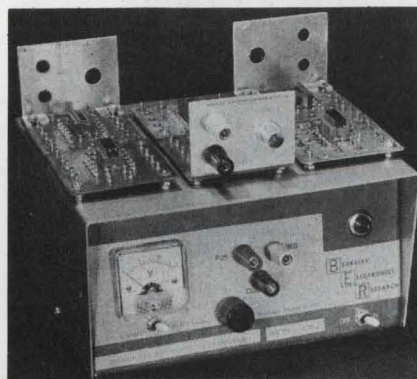

Berkeley Electronics Research, 281 Alvarado, Berkeley, Calif. Phone: (415) 841-240. P&A: \$249; 3 wks.

Called Cerkit, a new circuit evaluation kit bridges the gap between the initial idea or circuit sketch and the finalized design etched on a printed circuit board. It features a dual regulated power supply and can accept all integrated circuits including those with 24 and 36 pins. There are also numbered pins, a ground plane and extra terminals for tie points.

CIRCLE NO. 290

IC breadboard prints-on leads

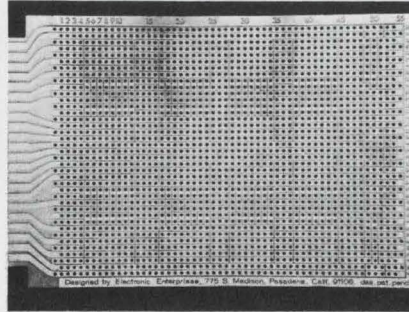

Electronic Enterprises (designer), Micro-Etch (manufacturer), 775 S. Madison, Pasadena, Calif. Phone: (213) 798-0511. Price: \$6.95.

Instead of patchcords or wire, a new IC breadboard utilizes hundreds of built-in printed leads. These permit a near-infinite variety of circuits to be constructed with only a soldering iron and a few through-board connections. It has a capacity of 10 assorted ICs, both TO-5 cans and DIPs, plus diodes, resistors, capacitors, and transistors.

CIRCLE NO. 291

Low-profile boards through-mount DIPs

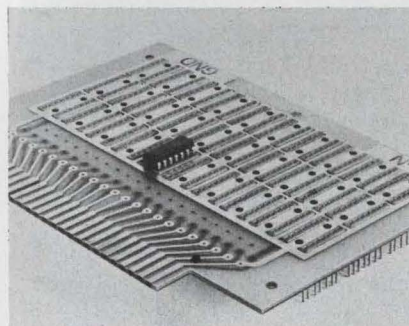

Robinson-Nugent, Inc., 800 E. 8th St., New Albany, Ind. Phone: (812) 945-0211.

New high-density DIP socket boards allow dual-in-line socket bodies to be mounted through, rather than on, the PC board. This technique allows the economy and flexibility of a socket assembly without an increase in over-all height. Slots are punched through the etched double-sided board; socket bodies are mounted from the bottom and riveted through the board.

CIRCLE NO. 292

your best move



The world's first ultra-miniature 1/2" rotary switch with the invaluable feature of an adjustable stop. The MRA Series is available as 1, 2, 3, or 4 poles on a single deck with a maximum of 10 or 12 positions. You can choose the universal 1/8" diameter shaft, or a switch with its own specially mated knob. Ideal for installations where size and space limitations are a factor. Conservatively rated at 500 mA @ 125 VAC.

The MSRE waterproof rotary switch series is similar to the MRA Series, but built to meet the highest reliability standards required under any environmental condition.



LOCKING TOGGLE

World's first totally miniature toggle switches capable of being locked to safeguard against accidents. Full line available in 1-2-3-4 poles. 6 amps @ 125-VAC.

SLIDE SWITCH

The world's best mini-slide switch with a compact 1/2" case and new anti-tease design. Available in one and two pole, double throw models; 2 amps @ 120 VAC.



See us at WESCON 5120

ALCO

ELECTRONIC PRODUCTS, INC.

Lawrence, Massachusetts 01843

Wedge-Action*

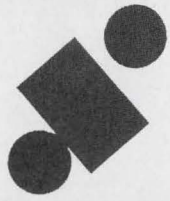

Relays

Hermetically-sealed, electromagnetic relays that provide high performance and reliability under the most difficult operating conditions in dry-circuit to 2 amp applications.

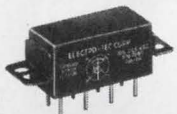

2 PDT
MARK II, SERIES 500
MIL-R-5757/9



6 PDT 4 PDT
(1" x 1")
MARK II, SERIES 300
(6 PDT).
SERIES 350 (4 PDT).
MIL-R-5757/1 and
MIL-R-5757/7



6 PDT
MARK II, SERIES 085
(-55°C to +85°C)
SERIES 100
(-65°C to +125°C),
SERIES 200
(-65°C to +200°C).
MIL-R-5757/1.



4 PDT, 10 AMP
MARK X, SERIES 600-02
MSFC-339/22A

*Wedge-Action



The moving contacts are mounted between two stationary contacts. On actuation, they drive into the stationary contacts, creating high pressures and low contact resistance at all current levels. In addition, wedge-action contact wipe provides self-cleaning of the precious-metal contacts.

*Patented

For complete data write Relay Sales and Engineering Office, P. O. Box 667, Ormond Beach, Fla. 32074, Phone 904-677-1771, TWX 810-857-0305.

Electro-Tec Corp.

A DIVISION OF KDI CORPORATION **(KDI)**

INFORMATION RETRIEVAL NUMBER 61

MICROWAVES & LASERS

Power transistors perform in GHz area

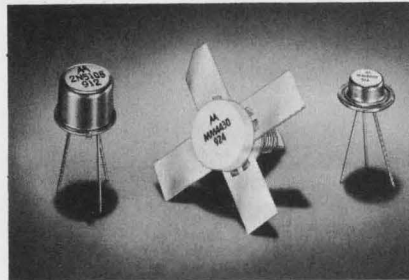

Motorola Semiconductor Products Inc., P.O. Box 20924, Phoenix, Ariz. Phone: (602) 273-6900. Price: \$7.10 to \$19.

Characterized for both oscillator and amplifier service, two new series of power transistors are capable of operating at frequencies in the gigahertz region. The prime device in the oscillator series, model MM 8008, can develop a minimum power of 300 mW at 2 GHz. The prime amplifier, model MM4430, can deliver 2.5 W with 6-dB gain at 1 GHz. Another unit, type 2N5108, puts out 1 W with 5-dB gain at 1 GHz.

CIRCLE NO. 340

Low-noise transistor gains 7 dB in S band

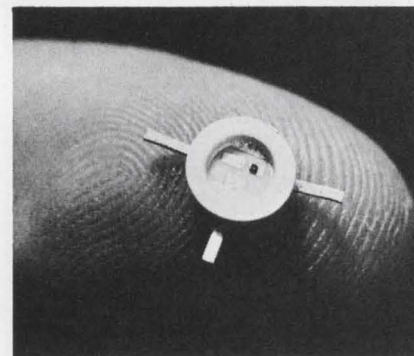

Fairchild Semiconductor, 313 Fairchild Drive, Mountain View, Calif. Phone: (415) 962-3563. Price: \$90.

A new S-band small-signal transistor features a maximum noise figure of 5 dB and a minimum power gain of 7 dB at the same bias conditions. Model MT2500 is an npn device that allows the circuit designer to optimize total small-signal performance with input impedance values that satisfy both low-noise and high-gain conditions.

CIRCLE NO. 341

MIC amplifiers span octave bands

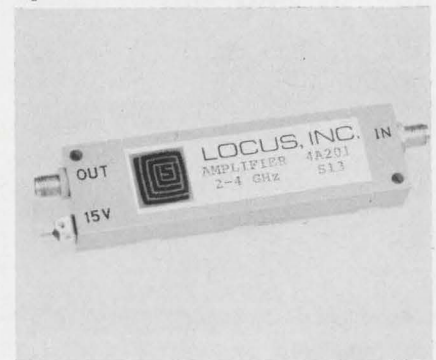

Locus, Inc., P.O. Box 740, 906 W. College Ave., State College, Pa. Phone: (814) 237-0301.

Using hybrid thin-film microwave integrated-circuit techniques, a new series of rf amplifiers achieves bandwidths from 25 MHz to several octaves over the frequency range of 500 to 4500 MHz. Series 4A solid-state S-band devices attain gains of 25 dB, while holding noise figure between 3 and 12 dB. Their output power is as high as +30 dBm.

CIRCLE NO. 342

Programmed attenuator responds in 40 ms max

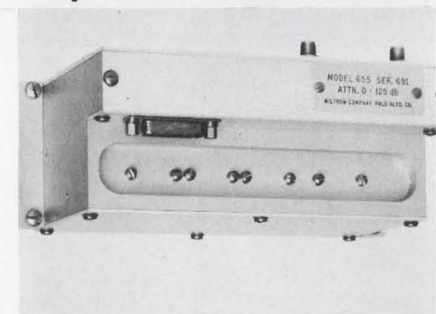

Wiltron Co., 930 E. Meadow Drive, Palo Alto, Calif. Phone: (415) 321-7428. Price: \$1000 to \$2000.

Designed for use in automated test systems covering the frequency range of dc to 1250 MHz, a new programmable attenuator can go from one setting to any other setting in 40 ms maximum. Attenuation is 125 dB maximum in 1-dB steps. Model 655 can be operator controlled by means of conveniently located pushbuttons, or computer controlled with automatic test sequencing.

CIRCLE NO. 343

MIC octave couplers span 1 to 12.4 GHz



Microphase Corp., 35 River Rd., Cos Cob, Conn. Phone: (203) 661-6277. P&A: \$150 to \$225; 30 to 60 days.

Series 3000 microwave integrated circuit couplers cover the frequency range from 1 to 12.4 GHz in octave bands, with coupling values from 8.34 ± 0.5 dB to 25 ± 1 dB. These thin-film devices have a low VSWR and 20-dB isolation. Their package size is 1.5 by 1.25 by 0.375 in. and weight is less than 1 oz.

CIRCLE NO. 344

Varactor diodes keep cutoff high

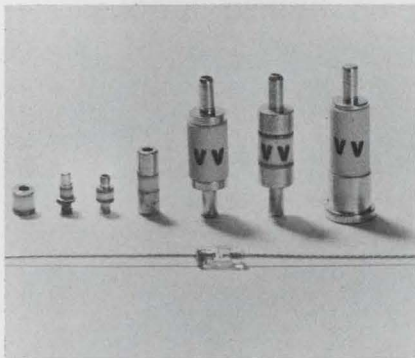

Varadyne, Inc., 1805 Colorado Ave., Santa Monica, Calif. Phone: (213) 394-0271. Availability: 30 days.

Two new microwave varactor diodes are now available. Model VV-410, a silicon diffused junction device with a high Q and low breakdown voltage, has a cutoff frequency of 90 GHz at 0-V bias. Model VV-420 is an epitaxial silicon diffused junction type with a cutoff frequency of 150 GHz at -6 V bias and a breakdown voltage of 6 to 120 V.

CIRCLE NO. 345

Tunable MIC oscillator puts out 30-mW power



Avantek, Inc., 2981 Copper Rd., Santa Clara, Calif. Phone: (408) 739-6170. P&A: \$1850; 30 days.

Rugged, fully shielded and hermetically sealed, a new electronically tunable frequency source delivers a minimum output of 30 mW into a 50-Ω load and 2 to 4 GHz. Model AV-7200M is an all-solid-state, integrated-circuit and transistor oscillator than can be tuned across S band by a YIG resonator that drives two amplifier stages when driven from a current source.

CIRCLE NO. 346

Rf bandpass filters tune over one octave



Telonic Engineering Co., P.O. Box 277, Laguna Beach, Calif. Phone: (714) 494-9401.

Incorporating a varactor circuit, a new line of miniature bandpass filters can be voltage-tuned to shift their passband over a one-octave frequency range. Standard series TVF units cover the frequency range of 225 to 400 MHz, while special versions can go from 50 to 500 MHz. Response is typically the Chebyshev type.

CIRCLE NO. 347

SCHAUER

1%

tolerance

1 WATT ZENERS ARE A REAL BUY!

ANY voltage from 2.0 to 16.0 at the industry's **LOWEST PRICES!**

Quantity	Price each
1-99	\$1.07
100-499	.97
500-999	.91
1000-4999	.86
5000 up	.82

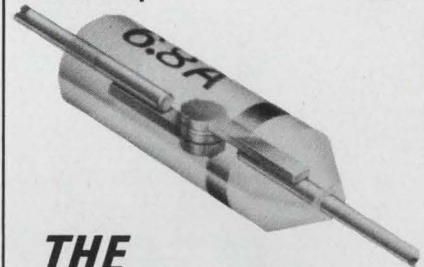

THE HI-RELIABLE!

No fragile nail heads.

Silicon junction aligned between two, parallel, offset tantalum heat sinks . . . great lead tension strength.

All welded and brazed assembly.

High pressure molded package.

Gold plated nickel-clad copper leads.

Write or phone for Form 68-4 for complete rating data and other tolerance prices.

Semiconductor Division

SCHAUER MANUFACTURING CORP. 4511 Alpine Avenue
Cincinnati, O. 45242
Ph. (513) 791-3030

INFORMATION RETRIEVAL NUMBER 62

ATTENUATE & MODULATE, 250 MHz- 12.4 GHz for \$550!

Model E-150 shown 1/2 size



For less than half the cost elsewhere, the Alfred Model E-150 PIN Modulator provides electronically controllable attenuation in one unit over a broad frequency range with wide dynamic range and low SWR at all attenuation levels.

The E-150 replaces four single band units for maximum economy and flexibility. To provide control and power signals for one or two PIN modulator units, Alfred offers the Model E-150P PIN Controller. Using the E-150P, attenuation and modulation can be varied continuously. The PIN Controller provides both local and remote operation. Price of the E-150 is \$550; the E-150P, \$175.

For more information, call your Alfred sales engineer or write Alfred Electronics, 3176 Porter Drive, Palo Alto, California 94304. Phone: 415-326-6496. TWX: 910-373-1765.

ALFRED ELECTRONICS

INFORMATION RETRIEVAL NUMBER 63

PRODUCTION

Light pencil iron heats instantly



Wall Manufacturing Co., Kinston, N. C. Phone: (919) 527-4186.

Using a dual-element heater controlled by a thermal time-delay relay, a new 3-oz soldering pencil provides instant heat without a transformer. When a switch on the handle is depressed, a high-wattage element brings the tip temperature up to operating heat in seconds. The relay then cuts in a lower-wattage element that maintains the proper soldering heat. Model IDL operates at 40 W.

CIRCLE NO. 348

Compact controller contains computer



PECO Corp., 111 Ortega Ave., Mountain View, Calif. Phone: (415) 967-5738.

In less space than a desk phone occupies, a new variable-rate control system includes an inexpensive computer that automatically speeds up or slows down the flow of products, parts or components on any production line to the desired rate, from 240 to 4000 items per minute. The unit can handle both metallic and nonmetallic objects. It remains stable over an input voltage range of 90 to 130 V.

CIRCLE NO. 349

Automatic cleaner decontaminates wafers

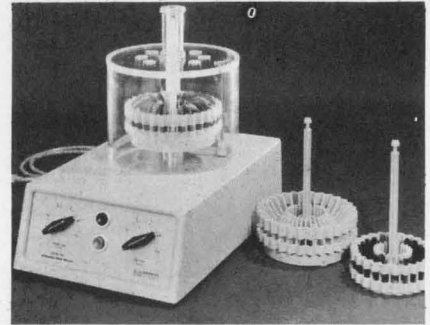

Macronetics, Inc., Semiconductor Tool Div., 220 California Ave., Palo Alto, Calif. Phone: (415) 321-0780. P&A: from \$880; stock.

Designed to serve the semiconductor production field, model 900-A automatic wafer cleaner removes contamination between successive steps in wafer processing. Loaded wafer baskets are placed on the turntable within the vented transparent housing. They are automatically timed through a de-ionized-water spray and spin cycles under nitrogen blanketing and dry nitrogen blowoff.

CIRCLE NO. 350

Automatic system seals hybrid stacks



Time Research Laboratories, Inc., Pennington, N.J.

Combining infrared heating and ultrasonic energy, a new system can simultaneously solder multiple substrates that are stacked in TO-5 or TO-8 cans. This hybrid stack sealing system provides an integral bond between the pins and the land area. Model 240S automatically cycles through the sealing operation in approximately 1-1/2 minutes.

CIRCLE NO. 351

Evaluation Samples

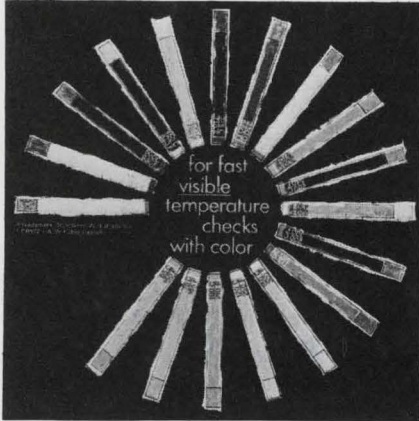

Temperature crayons

Able to visibly indicate temperature readings on any heated surface, Thermochrom crayons can be used as an economical method of checking heated surfaces without the need for expensive and complex instrumentation. Eighteen different crayons cover the temperature range from 150 to 1240°F. Each color range is distinctive and readily visible even from a distance. Free samples are available to a qualified engineer to meet his specific temperature needs. W. H. Brady Co., Metal-Chem Division.

CIRCLE NO. 352

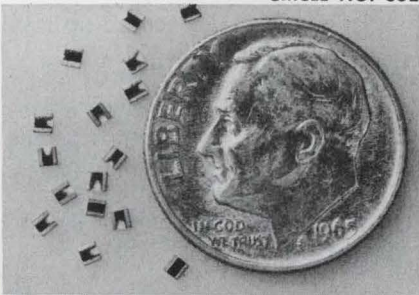

Chip resistors

A new thick-film microchip resistor is a leadless device measuring only 0.05 by 0.05 by 0.013 in. Resistance values up to 5 MΩ are available in a very small area (50 mils square). The total range of values is from 10 Ω to 5 MΩ with standard tolerances of 10, 5 or 1%. Chips are available with gold, platinum-gold, or palladium-silver electrode bands, allowing the use of either solder attachment or familiar bonding techniques. Evaluation samples are available free. Lek Trol, Inc.

CIRCLE NO. 353

REPLACE AN SWR METER, SLOTTED LINE, POWER METER, RATIONOMETER, ATTENUATOR AND OSCILLOSCOPE. MEASURES RETURN LOSS, VSWR, GAIN, INSERTION LOSS, FREQUENCY RESPONSE, ABSOLUTE POWER, AND LOCATES FAULTS, TOO!

**HARD TO BELIEVE?
FOR ONLY \$1990,
ABSOLUTELY INCREDIBLE.**

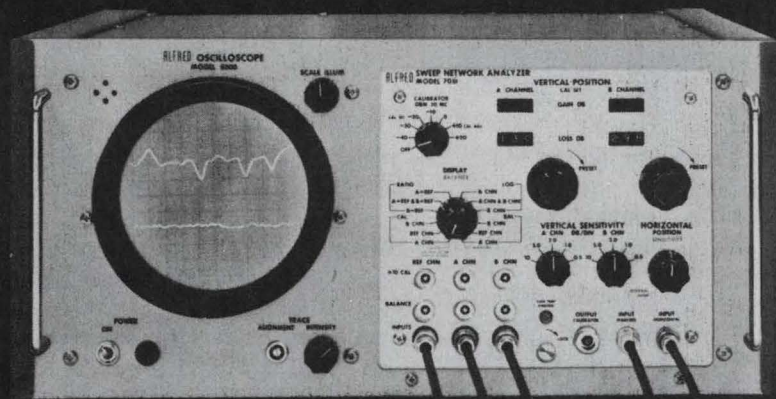

Here's a powerful measuring tool, the Alfred Sweep Network Analyzer, to simplify virtually all of your microwave test and measurement problems.

Measure over a 60 db dynamic range with direct-db or dbm/digital readout. Measure fast with accuracy. Measure return loss and insertion loss or gain simultaneously at fast sweep speeds for oscilloscope display.

Find faults. Detailed information on testing microwave transmission system and other applications as well as complete specifications available on request. Simply call your Alfred field sales engineer or write us at 3176 Porter Drive, Palo Alto, California 94304. Phone: 415-326-6496. TWX: 910-373-1765

ALFRED ELECTRONICS

INFORMATION RETRIEVAL NUMBER 64

Isolation was the only thing preventing a high-frequency Reed Switch Matrix Until now.

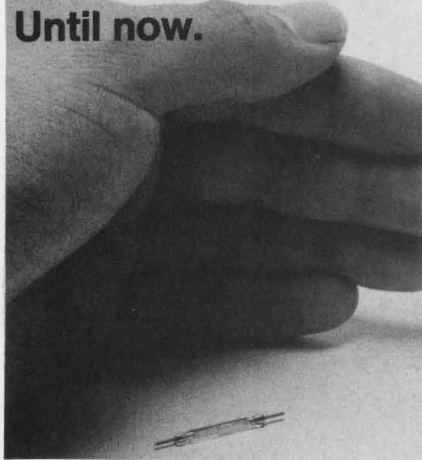

The Cunningham Reed Switch Matrix reduces high-frequency crosstalk and interference to a new low. Unique "sandwich" design seals, shields and separates matrix-mounted reed switches from their controls.

Offers:

- **Excellent signal characteristics:** 50-ohm distributed. Broadband handling with top isolation. Low thermal noise.
- **100% Random access:** Any number or combination of crosspoints can be set, any place, any direction without affecting other crosspoints.
- **Computer compatibility:** Can be directly addressed by all computers using +5 volt logic. No added interfacing needed.
- **Proven reliability:** Up to 100 million operations.
- **Easy inspection and maintenance:** Control and signal sections can be separated for easy access.
- **Applications:** Interconnecting video channels; broadband data switching; test systems for nanosecond digital pulses; telemetry equipment for multiple data channels; antenna switching; medical data monitoring.

Write or call for Data Sheet No. 603, Cunningham Corporation, 10 Carriage St., Honeoye Falls, New York 14472. Phone: (716) 624-2000.

Cunningham Corporation

SUBSIDIARY OF GLEASON WORKS
INFORMATION RETRIEVAL NUMBER 65

Design Aids

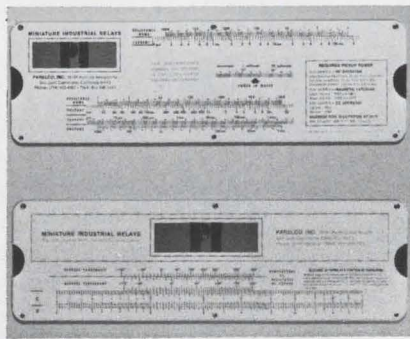

Relay slide rule

To aid circuit designers in determining relay coil characteristics like pull-in power, coil resistance and pull-in voltage (or current), a slide rule type of relay parameter calculator provides fast answers. This calculator clears up all questions on coil specifications quickly and easily. It is available to qualified circuit designers who use relays at no charge. Parelco, Inc.

CIRCLE NO. 354

Magnetic pickups

Designed as a helpful device for choosing the correct magnetic pickup for speed measuring applications, an easy-to-use selection chart lists the important parameters to be determined for each application. Mounting thread size and length, the type of electrical connection, voltage output range, and operating temperatures for each magnetic pickup are easily and quickly located. Special characteristics of various pickups are also shown. Airpax Electronics Inc.

CIRCLE NO. 355

Decibel tables

Relating voltage ratio and power ratio to their corresponding value in decibels (dB), a new set of tables also shows the dB equivalent of per cent deviation for both voltage and power. Basic definitions and equations for determining dB and dBm are included. Pacific Measurements Inc.

CIRCLE NO. 356

Annual Reports

Learn how to read annual reports in "How to investigate a company." For a copy, circle no. 474.

Annual Reports

DPA, Inc., 2636 Farrington St., Dallas, Texas: computer leasing, time sharing, software, data-processing equipment servicing; net revenues, \$14,009,006; net earnings, \$1,255,070; assets, \$2,736,349.

CIRCLE NO. 357

LM Ericsson Telephone Co., Mid-sommarkransen, Stockholm 32, Sweden; 100 Park Ave., New York, N.Y.: worldwide telephone services; net sales, \$487,637,000; net income, \$26,520,000; assets \$483,663,000.

CIRCLE NO. 358

Instrument Systems Corp., 770 Park Ave., New York, N.Y.: components, plastic containers, consumer and automotive products; net sales, \$85,047,000; net earnings, \$4,529,000; assets, \$40,459,000.

CIRCLE NO. 359

LTV Electrosystems, Inc., P.O. Box 6030, Dallas, Texas: airborne data systems, communications services and systems, instruments, components; net sales, \$209,052,000; net income, \$3,639,000; assets, \$93,556,000.

CIRCLE NO. 360

Sherwin-Williams Co., 101 Prospect Ave., N. W., Cleveland, Ohio: paints and related products, industrial aerosols, chemicals, metal containers; net sales, \$452,526,660; net income \$18,989,863; assets, \$199,510,710; liabilities, \$41,467,386.

CIRCLE NO. 361

University Computing Co., 1300 Frito-Lay Tower, Dallas, Texas: data processing, computer leasing, communications; operating revenues, \$57,103,000; net income, \$8,485,000; assets, \$230,191,000.

CIRCLE NO. 362

Application Notes

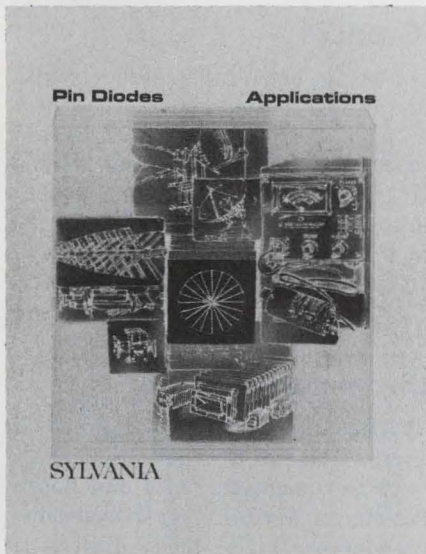

P-i-n diodes

Applications for microwave p-i-n diodes are described in a 12-page brochure. Discussed is their use as switches, limiters, phase shifters, voltage-controlled attenuators, linear modulators, and harmonic generators. Sylvania Electronic Components.

CIRCLE NO. 363

Short-term stability

Reviewing the specification and measurement of short-term stability, a 25-page technical paper covers the area where short-term stability is needed, reviews the theory of frequency modulation, and discusses the measurement of short-term stability. As examples, the paper cites pulse doppler radar, and satellite and deep-space tracking and communications. Microwave/Systems Inc.

CIRCLE NO. 364

Contact resistance

Containing illustrations and diagrams, an eight-page booklet describes a system designed to rapidly measure contact resistance. The system has four principle functions: a critical pre-adjusted voltage sensor, two stable timing devices, an inhibitor; and a coded binary counter. Cherry Electrical Products Corp.

CIRCLE NO. 365

Percussive welding

"Use of Percussive Welding in Electronics" is a four-page article reprint that describes how metals without mutual solubility can be joined by use of percussive welding. These materials include those with widely different melting points and compositions. Reviewed is the mechanical system required for percussive welding, the basic electrical circuitry used, and the close control over welding parameters required to achieve satisfactory results. General Electric Co., Lamp Metals & Components Dept.

CIRCLE NO. 366

Panel design

"Sandwich Construction" is the title of a 10-page bulletin that is a practical design guide on panel enclosures. Included are formulae for determining the correct paneling construction to give optimum protection, design advantages, mechanical and physical properties, and examples of unusual applications. Brooks & Perkins.

CIRCLE NO. 367

Surge protectors

Gas-filled surge voltage protectors are the subject of a six-page brochure that covers the characteristics of both button- and power-type units. Discussed are dc and surge striking voltages, voltage transient conditions, ac and surge discharge currents, and extinguishing voltages. Siemens America Inc., Telecommunications Div.

CIRCLE NO. 368

Block polymers

Technical reprints in a 24-page booklet investigate the mechanical behavior of block polymers containing two terminal styrene sequences. The properties of random and block copolymers of butadiene and styrene and three sequence styrene-butadiene-styrene block polymers are covered. Instron Corp.

CIRCLE NO. 369

ECCOAMP ELECTRICALLY CONDUCTIVE ADHESIVES & COATINGS



New four page folder describes materials from 0.0001 to 100 ohm-cm. Adhesive pastes to replace hot solder, thin liquids, silver lacquer in aerosol spray, lossy coatings, etc.

INFORMATION RETRIEVAL NUMBER 191

THERMAL CONDUCTIVE DIELECTRICS



Electrically insulating, thermally conductive . . . for bonding, encapsulating, coating or sealing heat sinks, components or cryogenic devices where rapid heat transfer is desired. New four-page folder describes materials and applications.

INFORMATION RETRIEVAL NUMBER 192

NEW BOOKLET DESCRIBES SURFACE COATINGS FOR ELECTRONICS



ECCOCOAT® Surface Coatings include transparents for PC boards and components; dip-coats for transformers and coils; easy-mix and one-part systems for automatic production; and a wide range of special properties such as 500°F capability; resistivities to 10¹⁴ ohms/sq. Several chemical types. Send for copy.

INFORMATION RETRIEVAL NUMBER 193

Emerson & Cuming, Inc.



CANTON, MASS.
GARDENA, CALIF.
NORTHBROOK, ILL.
Sales Offices
in Principal Cities

EMERSON & CUMING EUROPE N.V., Oevel, Belgium

**NEED LOW COST
HIGH RELIABILITY
IN THE TERMINAL OUTPUT
OF YOUR DATA PROCESSING
SYSTEM?**



Model 1900 Series Numeric Printer
Serial/Parallel Entry Data Printer can add, subtract, totalize and/or print automatically by remote control. Speeds up to 2 lines per second. Up to 10 digits per line.

For details ask for S-113R data sheet



The Model 7000 Numeric Printer
features integrated circuitry and mechanical design simplicity.

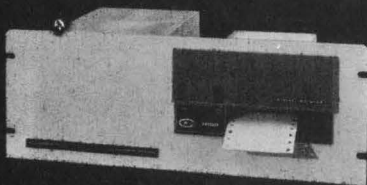

- Up to 10 lines per second
- Up to 20 columns of data
- Basic Model \$1850.00

Evaluate the Model 7000 for your printer application.

For details ask for S-165 R2 data sheet.

CLARY CORPORATION

PRECISION INSTRUMENTS
DIVISION

320 West Clary Ave.
San Gabriel, California

91776
(213) 287-6111
Telex 674604

**New
Literature**



Zeners and rectifiers

A new 40-page catalog covers a line of controlled avalanche fused-in-glass rectifiers, zener diodes, and MIL-type devices. Included is detailed applications information on temperature and lead-length derating (recovery time measurements, lead material, mounting method, and surge rating capabilities. Unित्रode Corp.

CIRCLE NO. 370

High-power hybrids

A two-color four-page illustrated brochure describes a diversified line of high-power hybrids that combine thick films with semiconductors to form microcircuits having unusually high power capabilities. The methods used to manufacture these multi-device assemblies are also shown. Silicon Transistor Corp.

CIRCLE NO. 371

Recording system

The operating characteristics of a scan/recording system are presented in a new eight-page bulletin. The system's moisture gage, scanning beam, and control console are also described. General Electric Co.

CIRCLE NO. 372

Transistor sockets

Both fabricated and molded transistor sockets are featured in a new eight-page catalog. It includes technical illustrations, specifications, materials and test data, as well as ordering information. Robinson-Nugent, Inc.

CIRCLE NO. 373

IC prices

Listing both integrated circuits and discrete semiconductors, a new 23-page OEM price list cites the product part number along with a brief capsule description. Prices are shown for both small-quantity and large-quantity orders. Texas Instruments.

CIRCLE NO. 374

Digital power

"Digitally Controlled Power" is a new 22-page brochure that deals with the characteristics and applications of digitally controlled power sources. These basic digital-to-analog converters (followed by power amplifiers) qualify for use as power supplies or waveform generators in computer-controlled and other automatic systems. Their inputs are isolated from their outputs, and they have circuitry for internal digital storage, programmable overcurrent protection, and digital feedback to the controller. Hewlett-Packard Co.

CIRCLE NO. 375

Counter talk

Counters, synthesizers and capacitors are discussed in the latest issue of "Metricist." The publication points out that the problem of when to choose a plug-in counter really boils down to whether the need is for many test stations or just a few. The capacitor discussions deals with the manner in which these components depart from ideal behavior. Monsanto Electronic Instruments.

CIRCLE NO. 376

Integrated circuits

A new 86-page illustrated catalog describes several families of integrated circuits. Typical characteristics as well as logics and schematics are given for Raytheon's 200 and 930 series of DTL circuits, the Ray I, II, III series of TTL circuits, and complex and linear circuits. Raytheon Co.

CIRCLE NO. 377

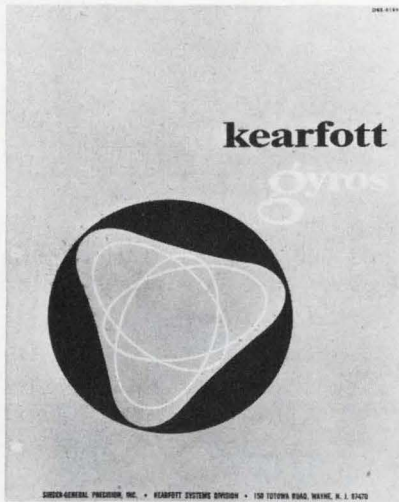

Gyro catalog

Describing a wide variety of gyroscopic instruments, a revised 24-page brochure gives detailed information on miniature floated rate integrating gyros, high-torquing-damping compensated and uncompensated gyros, and vertical, directional, control-moment, fluid-filled rate, and platform stabilization gyros. Replete with pictures, drawings, diagrams, curves, tabulations and descriptive text, the new brochure includes gyro types used in many space programs. Singer-General Precision Inc., Kearfott Div.

CIRCLE NO. 378

Taut-band meters

An eight-page catalog details a complete line of taut-band voltmeters, ammeters, milliammeters microammeters with sizes ranging from 2-1/2 to 4-1/2 inches. Hoyt Electrical Instrument Works, Inc.

CIRCLE NO. 379

Computer control system

A new 12-page bulletin describes an inexpensive supervisory digital computer control system. The illustrated publication lists possible system applications, explains the supervisory programming system, and summarizes features of the system's hardware and software. Foxboro Co.

CIRCLE NO. 380

NEW BUY YOUR EMI FILTERS DIRECT FROM THIS FILTER GUIDE!

✓ SPECTRUM OFFERS 30 dB WHERE FORMERLY YOU COULD BUY ONLY 5 dB

✓ ALL QUALITY FILTERS... REALISTICALLY PRICED

✓ SPECTRUM FILTERS ARE AVAILABLE FOR IMMEDIATE DELIVERY

CURRENT RATING (AMPS)	VOLTAGE RATING @ 125°C	INSERTION LOSS				SPECTRUM PART NO. (USE WHEN ORDERING)	PARTS SHOWN ACTUAL SIZE	PRICE* 1-49 (EACH)
		30kHz	1MHz	10MHz	100MHz			
NEW 10	100	-	-	5	42	51-712-001		2.90
NEW 10	100	-	10	30	50	51-712-003		5.60
NEW 10	200	-	-	5	45	51-714-004		1.60
NEW 10	100	-	12	30	50	51-714-007		4.90
10	500	-	-	5	45	51-719-001		2.40
15	50	15	44	60	70	51-717-001		7.25
15	50	15	44	60	70	51-343-003		8.65
NEW 10	50	20	60	70	70	51-301-030		12.80
25	500	-	-	10	55	51-702-003		1.32
25	750	-	-	10	50	51-715-001		2.50

DOUBLE VOLTAGE RATING @ 85°C.

SEND ORDER DIRECT TO OUR FAIRVIEW PLANT...

OR CALL JOHN LANE 814/474-5593

QUANTITY PRICE BREAKS QUOTED ON REQUEST

*PRICES INCLUDE ALL HARDWARE

SPECTRUM CONTROL INC. 152 EAST MAIN ST. • FAIRVIEW, PENNSYLVANIA 16415

VISIT SPECTRUM'S EXHIBIT AT WESCON - Booth 4707



We're in the business of extending man's senses.

Watch inbound traffic from outer space.
Talk safely in bits and pieces for 5,000 miles.
Scan the ocean bottom for an exact fix.
Tune in the fleet with two million watts of RF power.
Control joint forces from an electronic command post
20,000 feet above the action.

Whatever the mission, no matter how impossible, how big, or how soon it's needed, LTV Electrosystems produces.

We can turn a mission concept into sophisticated hardware faster, better, at lower cost than just about anyone.

Our technological spectrum ranges from re-entry physics installations and international communications nets to high-reliability components. We have 15 production facilities countrywide and some of the best scientific and engineering minds anywhere.

Our mission: Extending man's senses.

What's yours?

See the opposite page for a listing of current professional opportunities at LTV Electrosystems.

LTV ELECTROSYSTEMS, INC.

PO BOX 6030, DALLAS, TEXAS 75222

A quality company of Ling-Temco-Vought, Inc. **LTV**

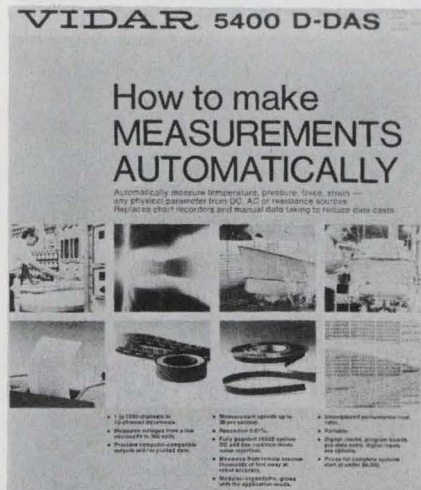

Data acquisition

A 16-page booklet discusses the importance of data acquisition in various disciplines and the advantages of automatic data handling over chart-recorder/visual/manual methods. Annual costs with multi-channel pen recorders are compared with the costs of automatic measurement methods. Vidar Corp.

CIRCLE NO. 381

Electroplating guide

Revised and updated, a six-page guide to precious metal electroplating processes for engineering applications now covers some 55 processes. Listed and described are over two dozen gold processes, several high-speed golds, other precious metal processes (including silver, rhodium and platinum) and a selection of strikes, pre-plates and immersion golds. Operating and deposit characteristics, military specifications and suggested applications are also given. Sel-Rex Corp.

CIRCLE NO. 382

Circular connectors

Besides drawings with dimensions in millimeters as well as inches and complete performance specifications, a new 52-page guide to miniature circular connectors contains an illustrated reference index and a handy glossary of terms. Two enlarged lines of connectors conforming to MIL-C-26482 and MIL-C-26500 are included. Elco Corp.

CIRCLE NO. 383

Counter roundup

In an easy-to-read table format, an updated electronic counter selection guide compares all Hewlett-Packard counters, giving model numbers, descriptions, frequency ranges, numbers of digits, measurement functions, input characteristics, time base stabilities, gate times, digital outputs, remotely controllable functions, and prices. Also listed are plug-ins for those counters that accept them, and complementary equipment. Hewlett Packard Co.

CIRCLE NO. 384

Test chambers

Thermal cycling and shock test equipment is the subject of a 12-page brochure. Fully illustrated, the brochure gives detailed performance and operating data on units that have been designed for both military and in-house testing. Blue M Engineering Co., A Div. of Blue M Electric Co.

CIRCLE NO. 385

Switch catalog

A complete line of precision-made switches is described in a new 12-page pocket-size selector guide. There are photographs, cut-away illustrations, brief descriptions and specifications for 75 different switches, including snap-action, contact, and thumbwheel rotary units. Cherry Electrical Products Corp.

CIRCLE NO. 386

EE refreshers

Offering a stimulus to career boosting, a 48-page illustrated catalog describes 17 electrical engineering programs, refresher courses for graduate engineers and practical electrical courses. Among the areas covered are electrical engineering, electrical technology, electrical drafting and electrical contracting. A special section is devoted to graduate engineers desiring to update their knowledge in preparation for professional engineering examinations. International Correspondence Schools.

CIRCLE NO. 387

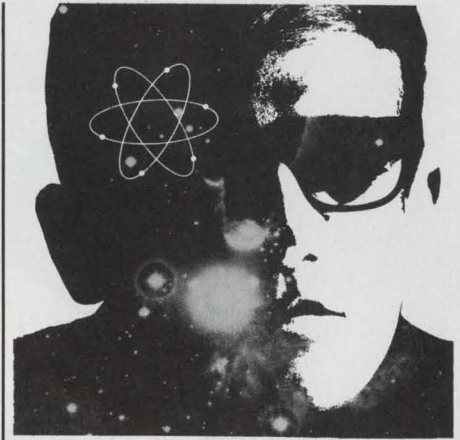

A new bulletin of professional opportunities at LTV Electrosystems.

Greenville Division

(Systems for strategic and tactical surveillance, reconnaissance, detection; tracking; command and control; airborne lighting systems; artificial intelligence; tactical warfare.)

- Digital Systems Analysts
- Digital Circuits Designers
- Electro-Optics Systems Analysts
- RF Systems Analysts
- RF Circuits Designers
- Scientific Programmers
- Business Programmers

Facilities — Greenville, Texas; Greenville, South Carolina; Roswell, New Mexico

Garland Division

(Long-range digital communications; fluid mechanical systems for aircraft, missiles, spacecraft; high-precision antennas; guidance and navigation systems; space systems.)

- RF Circuits Designers
- RF Systems Analysts
- Digital Circuits Designers
- Digital Systems Analysts
- Antenna Design Engineers
- Scientific Programmers

Facilities — Garland and Arlington, Texas

Continental Electronics

(This subsidiary company builds super-power RF transmitters for radio communications, broadcasting, re-entry physics radars, radio astronomy, nuclear accelerators.)

- Transmitter Design Engineers
- RF Circuit Designers
- RF Systems Engineers

Facilities — Dallas, Texas; Waltham, Massachusetts

Memcor Division

(Portable and stationary TACAN systems, tactical radio systems, nuclear controls, resistance products.)

- Project Engineers (TACAN Systems)
- Electronic Design Engineers
- Instrumentation Engineers
- Mechanical Engineers
- Digital Systems Engineers

Facilities — Huntington, Indiana; Salt Lake City, Utah

Please call or write: Bill Hickey, Supervisor of Professional Placement, LTV Electrosystems, Inc., P. O. Box 6118, Dallas, Texas 75222, Telephone (214) 276-7111. An equal opportunity employer.

LTV Electrosystems: extending man's senses.

INFORMATION RETRIEVAL NUMBER 903

Radar signal processing engineers:

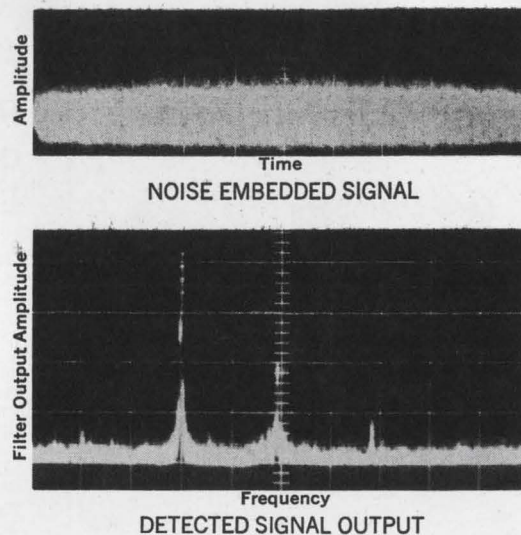

Our expansion can be your opportunity.

Today at Hughes, we're developing digital radar signal processors for a variety of important airborne applications. An engineering model of one of these processors has been developed for real-time operation. It uses the Cooley Tukey, or fast Fourier transform algorithm, to form a bank of 512 narrowband doppler filters, together with their associated detectors and threshold circuits. The scope photographs show a processor input signal 12 db

below wideband input noise, and the resulting processor output signal 15 db above rms noise in one digital filter output.

Several programs are now starting to carry this technique and others further toward operational radar systems.

It's a rapidly expanding field. And Hughes wants to grow with it. That's why qualified engineers and scientists are needed now. Particularly those with digital circuit design experience, signal processing analysis and

subsystem design experience, and microelectronic circuit applications background.

Interested? Please airmail resume today to:

Mr. Robert A. Martin
Head of Employment
Hughes Aerospace Divisions
Dept. 62
11940 W. Jefferson Blvd.
Culver City, Calif. 90230

An equal-opportunity employer
— M & F

U.S. citizenship is required



Free Career Inquiry Service

Absolutely Confidential

Respond to the career opportunities advertised in this issue. Fill out and send us this handy resume. **Electronic Design** will do the rest – neatly typed copies of this form will be mailed to the companies of your choice, indicated by the circled Career Inquiry Numbers at the bottom of this page.

16

Name				Home Phone	
Home Address (Street)			City	State	ZIP Code
Age	U.S. Citizen <input type="checkbox"/> Yes <input type="checkbox"/> No		Security Clearance		
Prime Experience			Secondary Experience		
Desired Salary			Availability Date		
Employment History – present and previous employers					
Company					
City, State					
Dates		to		to	
Title					
Specialty					
Education – indicate major if degree is not self-explanatory					
Degree					
College					
City, State					
Dates		to		to	
Additional Training – non-degree, industry, military, etc.					
Professional Societies					
Published Articles					

Career Inquiry Numbers:

900 901 902 903 904 905 906 907 908 909
 910 911 912 913 914 915 916 917 918 919 925

ELECTRONIC DESIGN
 850 Third Avenue
 New York, New York 10022

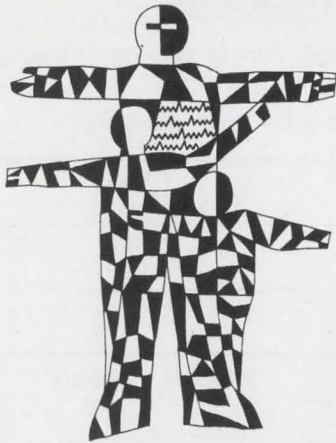

ELECTRO-OPTICS ENGINEERS

Comprehensive knowledge of detectors, optics and scanning techniques. Design of near, intermediate and long-wave IR systems with experience in effects of launch environments on sensor systems. □ For more information please write Mr. H. W. Bissell, Professional Placement Manager, P.O. Box 504, Sunnyvale, California 94088. An equal opportunity employer.

LOCKHEED
MISSILES & SPACE COMPANY
A GROUP DIVISION OF LOCKHEED AIRCRAFT CORPORATION

INFORMATION RETRIEVAL NUMBER 904

Electronic Design

ELECTRONIC DESIGN's function is:

- To aid progress in the electronics manufacturing industry by promoting good design.
- To give the electronic design engineer concepts and ideas that make his job easier and more productive.
- To provide a central source of timely electronics information.
- To promote two-way communication between manufacturer and engineer.

Want a subscription? ELECTRONIC DESIGN is sent free to qualified engineers and engineering managers doing design work, supervising design or setting standards in the United States and Western Europe. For a free subscription, use the postfree application form inside the back cover. If none is included, write to us direct for an application form.

If you do not qualify, you may take out a paid subscription for \$25 a year in the U.S.A., \$35 a year elsewhere. Single copies are \$1.50 each.

If you change your address, send us an old mailing label and your new address; there is generally a prepaid postcard for this inside the back cover. You will have to requalify to continue receiving ELECTRONIC DESIGN free.

The accuracy policy of ELECTRONIC DESIGN is:

- To make reasonable efforts to ensure the accuracy of editorial matter.
- To publish prompt corrections whenever inaccuracies are brought to our attention. Corrections appear at the end of the Letters column.
- To refuse any advertisement deemed to be misleading or fraudulent.

Microfilm copies are available of complete volumes of ELECTRONIC DESIGN at \$19.00 per volume, beginning with Volume 9, 1961. Work is now in process to complete the microfilm edition of Volumes 1-8. Reprints of individual articles may be obtained for \$2.00 each, prepaid (\$.50 for each additional copy of the same article) no matter how long the article. For further details and to place orders, contact the Customer Services Department, University Microfilms, 300 North Zeeb Road, Ann Arbor, Michigan 48106; telephone (313) 761-4700.

Want to contact us? If you have any comments or wish to submit a manuscript or article outline, address your correspondence to:

Howard Bierman, Editor,
ELECTRONIC DESIGN,
850 Third Avenue,
New York, N.Y. 10022.

SAVE ON EVERYTHING IN ELECTRONICS!



Stereo hi-fi • Tape recorders & tape • Electronic & hobby kits • CB 2-way radios • Radios • Shortwave • Phonographs • Amateur gear • Automotive electronics • Tools & hardware • Tubes, transistors, parts, batteries, books and more! . . .

FREE 552-PAGE ALLIED 1970 CATALOG

Right off the press and crammed with values—our biggest catalog ever! Huge selections, low prices, fast service. Mail coupon below for your free copy. Hurry, while they last!

ALLIED RADIO, Dept. 606 Please
P.O. Box 4398, Chicago, Ill. 60680 Print

NAME First Middle Last

STREET ADDRESS or ROUTE & BOX NO.

CITY

STATE ZIP

INFORMATION RETRIEVAL NUMBER 68

YOUR HEART FUND FIGHTS

HEART ATTACK
STROKE
HIGH BLOOD PRESSURE
INBORN HEART DEFECTS

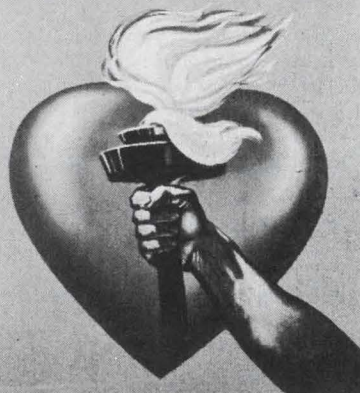

Advertising Sales Staff

New York 10022

Edward F. Clancy
Sales Service Manager
Robert W. Gascoigne
Thomas P. Barth
Samuel M. Deitch
Byron K. Adams
850 Third Avenue
(212) Plaza 1-5530
TWX: 710-581-2874

Philadelphia 19066

William C. Repetto
P. O. Box 206
Merion Station, Pa.
(215) MA-3-5888

Boston 01945

Richard Parker
48 Commercial Wharf
Boston, Mass. 02110
(617) 742-0252

Chicago 60611

Thomas P. Kavooras
Berry Conner, Jr.
200 East Ontario
(312) 337-0588

Cleveland

Thomas P. Kavooras
(Chicago)
(312) 337-0588
(call collect)

Los Angeles 90303

Stanley I. Ehrenclou
John V. Quillman
W. James Bischof
2930 Imperial Highway
Inglewood, Calif.
(213) 757-0183

San Francisco 94022

Arthur R. Shields, Jr.
175 San Antonio Rd., S 243
Los Altos, Calif.
(415) 941-3084

London W. 1

For United Kingdom & Holland
Brayton C. Nichols
44 Conduit Street
Tel: REGent 4714

Verviers, Belgium

For Continental Europe
Andre Jamar
1, Rue Mallar, 1
(087) 253.83 Telex 41563

Tokyo

Yoshiro Takemura
IPS Group Ltd.
Box 36, Ohsaki Post Office
Phone (504) 1485
Cable Joshplans, Tokyo



Advertisements of booklets, brochures, catalogs and data sheets. To order use Reader-Service Card.
(Advertisement)

Terminal Block Selector

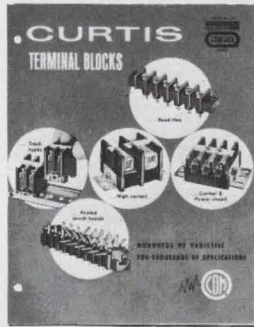

A new 24-page, completely illustrated catalog contains photos, descriptions, ratings, engineering drawings, and prices of the complete line of Curtis terminal blocks. Included are printed circuit, insulated feed-thru, quick disconnect, track type, and high current terminal blocks. Handy selection chart quickly locates the perfect block for your particular requirements. Send today for your free copy. See us at WESCON - Booth 4911

Curtis Development & Mfg. Co.

3236 North 33rd Street
Milwaukee, Wisconsin 53216

174

Free — New Alvin Template Catalog



A must for every electronic engineer and draftsman! The comprehensive 36 page Alvin catalog clearly illustrates and describes over 400 templates for practically every use. This template catalog is categorized in sections and shows the templates used for each field, ie, electrical and electronic symbol templates, mechanical engineering templates and many others. Alvin's precision made, time-saving templates cover completely the needs of draftsmen and engineers in all categories. Send for free catalog now.

ALVIN & CO., INC.

611 Palisado Avenue
Windsor, Connecticut 06095

175

Bus Bars For Noise Reduction

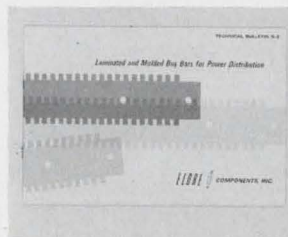

A 16 page Technical Bulletin is now available, describing a new concept in power or signal distribution. Basic mechanical and electrical design principles, along with descriptive pictures and diagrams, are included in this bulletin. These compact buses can replace bulky cable harnesses and repetitive wiring for computer or modular application. This method of construction satisfies the demanding requirements of low inductance and resistance of high speed, solid state systems, while controlling electrical noises.

Send For Free Sample

Eldre Components, Inc.

1239 University Avenue
Rochester, New York 14607

176

The first plug-in curve tracer costs 1/3 less!

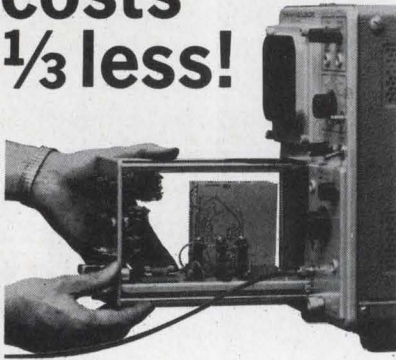

With U-Tech's plug-in and console units, any X-Y oscilloscope becomes a curve tracer displaying the dynamic characteristics of both NPN and PNP transistors, N Channel and P Channel junctions, FET's, MOS-FET's, bipolars, unijunctions, diodes, tunnel diodes and SCR's. You have curve tracer capabilities, without buying a complete curve tracer unit. In so doing you pay up to:

1/3 less!

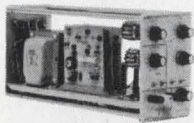

U-Tech plug-in **MODEL 681**: \$655.00*. For use with Tektronix 560 Series Oscilloscopes.

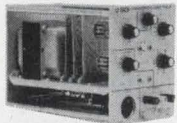

U-Tech plug-in **MODEL 682**: \$675.00*. For use with Tektronix 530, 540, 550, 580 Series Oscilloscopes.



U-Tech console **MODEL 683**: \$685.00*. For use with any X-Y Oscilloscope.

Ask your distributor about these U-Tech curve tracer units or order direct from:

U-TECH

A DIVISION OF INDUSTRIAL PHYSICS AND ELECTRONICS COMPANY
4190 SOUTH STATE STREET
SALT LAKE CITY, UTAH 84107
(801) 262-2663

*Prices apply to purchase and shipments within U.S.A. fob Salt Lake City, Utah

INFORMATION RETRIEVAL NUMBER 69

Advertisers' Index

Advertiser	Page	Advertiser	Page
Airtronics Incorporated, Power Tec Division	134	Kay Electric Company	125
Alco Electronic Products, Inc.	131, 133, 135	McCoy Electronics Company	17
Alfred Electronics	138, 139	MicroSwitch, A Division of Honeywell	16
Allen-Bradley Co.	33, 35	Molex Products Company	66
Allied Radio	148	Motorola Communications & Electronics, Inc.	119
Alvin & Co.	149	Motorola Semiconductor Products, Inc.	12, 13
Amphenol, The Bunker-Ramo Corporation	128 A-B-C	National Semiconductor Corporation	96 A-B
Babcock Relays, Division of Babcock Electronics Corporation	103	Nytronics, Inc.	31
Beckman Instruments, Inc., Helipot Division	82, 83	Oak Manufacturing Co.	123
Bell & Howell	14	Ogden Technology Labs, Inc.	43
Booker and Wallestad	120	Power/Mate Corp.	16 A—P
Bourns, Inc.	41	RCA Electronic Components and Devices	9, 113, Cover IV
Burrhoughs Corporation	20	RCL Electronics, Inc.	132
Bourns, Inc.	41	Raytheon Semiconductor	4, 5
Caddock Electronics	123	Schauer Manufacturing Corp.	137
Chassis-Trak Inc.	129	Signetics Corporation	27
Clary Corporation, Precision Instruments Division	142	Siliconix Incorporated	117
Clevite Corporation, Brush Instruments Division	50	Simpson Electric Company	127
Clifton, Division of Litton Industries	46	Spectrum Control, Inc.	143
Cohn Corp., Sigmund	124	Sprague Electric Company	18
Computer Labs	8	Stackpole Components Company	7
Computer Products	126	Sylvania Electric Products, Inc.	15
Corning Glass Works, Electronic Products Division	36, 37	Systron-Donner Corporation	2
Cunningham, Subsidiary of Gleason Works	140	TRW, Inc., Capacitor Division	115
Curtis Development & Mfg. Co.	149	Texas Instruments Incorporated, Components Group	39
Cutler-Hammer, Specialty Products Division	96	U-Tech, A Division of Industrial Physics and Electronics Company	150
Dale Electronics, Inc.	Cover III	Victory Engineering Corporation	128
Datron Inc.	65	W. & G. Instruments, Inc.	130
Edmund Scientific Company	96	Wanlass Electric Company	120
Eimac, A Division of Varian	23	Zeltex, Inc.	6
Elco Corporation	11	Career Advertising	
Eldre Components, Inc.	149	Hughes Aircraft Company, Aerospace Divisions	146
Electro Tec Corp.	136	LTV Electrosystems, Inc.	144, 145
Emerson & Cuming, Inc.	141	Lockheed Missiles & Space Company	148
Fairchild Controls, A Division of Fairchild Camera and Instrument Corporation	95	National Manpower Register	97
General Electric Company, Electronic Components	88, 89	Industrial Timer Corporation	120
General Radio Company	1	Intel Corporation	68, 69, 70, 71
Griffith Plastic Products Company	10	International Contronics Inc.	151
Hewlett-Packard Cover II, 44, 45, 48 A—L,			
Hughes Aircraft Company, Connecting Devices	72		

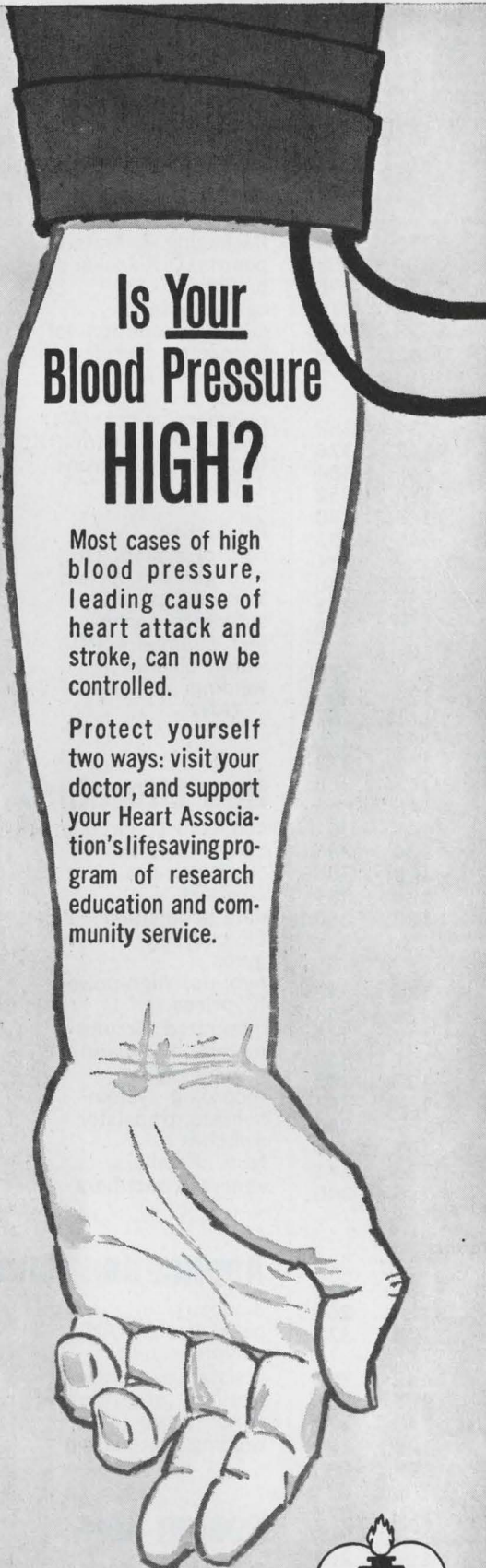

Is Your
Blood Pressure
HIGH?

Most cases of high blood pressure, leading cause of heart attack and stroke, can now be controlled.

Protect yourself two ways: visit your doctor, and support your Heart Association's lifesaving program of research education and community service.

GIVE...
so more will live
HEART FUND



Contributed by the Publisher

USE YOUR LOGIC!

(And there is only one choice)

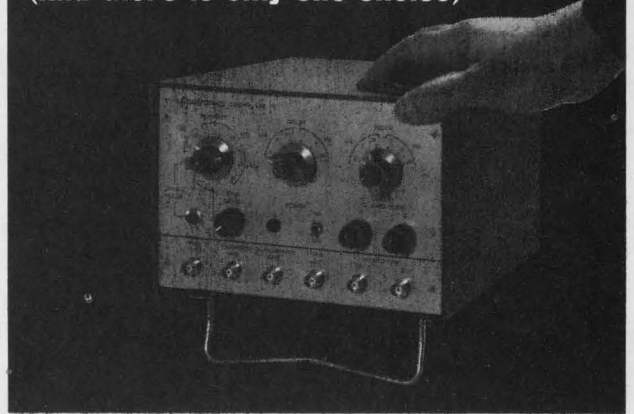

Logically you'd choose this new Contronics Lochpulse™ instrument because it is the **only** logic pulse generator in the world that provides **COMPLEMENTARY** outputs at 10 volts.

Logically you'd want this instrument because it features independent variability on each simultaneous **COMPLEMENTARY** pulse output along with independently variable 2 volt DC offset on each.

Logically you'd like another Contronics Lochpulse™ feature... this new instrument provides a 100% duty cycle at 10 MHz.

Logically you'd be pleased with other features, too. Features like a very clean pulse — free of jitter and ringing; very precise and stable gating circuits; light weight and compact size.

And logically you'd have to be impressed with this instrument's modest price: an illogically low **\$395** (lowest price in the field) yet an instrument that offers greater performance and higher quality workmanship than the most expensive.

So **logically** the easiest way to find out more about the new Contronics Lochpulse™ series CPG-300 Logic Pulse Generators is to check the coupon below and send it along with your name and address to:

International **Contronics Inc.**

1038 W. Evelyn Ave., Sunnyvale, Ca. 94086 (408) 736-7620
3555 Torrance Blvd., Torrance, Ca. 90503 (213) 371-7100

- I've read your ad and I'd like more information on the Lochpulse™ CPG-300 series Logic Pulse Generator.
- Rush _____ new instruments. My purchase order is enclosed. (Specify CPG-300 series; \$395 each.)
- I understand you offer a 10 day free trial. Let's hear about it.

Logically you may want to see us at **WESCON**
... Booths 5603 & 5604

Information Retrieval Service

All products, design aids (DA), application notes (AN), new literature (NL), and reprints (R) in this issue are listed here with Page and Information Retrieval numbers. Reader requests will be promptly processed by computer and mailed to the manufacturer within three days.

Category	Page	IRN	Category	Page	IRN	Category	Page	IRN
Components			regulator, voltage	132	280	Packaging & Materials		
boards, DIP socket	135	292	resistors, chip (ES)	139	353	boards, DIP socket	135	292
breadboard, IC	135	291	semiconductors, optical	130	296	breadboard, IC	135	291
cable systems	135	289	switch, ladder	132	279	cable systems	135	289
capacitors, chip	126	257	thermistor, rugged	128	265	circuit evaluation kit	135	290
comparator, dc	131	273	zeners & rectifiers (NL)	142	370	connector, circular (NL)	145	383
converter, a/d	133	283				electroplating (NL)	145	382
delay lines, TO-5	128	264	Instrumentation			panel design (AN)	141	367
diodes, p-i-n (AN)	141	363	calculator, printing	134	287	polymers, block (AN)	141	369
diodes, zener	130	294	counters (NL)	142	376	sockets, transistor (NL)	142	373
driver, clock	132	277	counters (NL)	145	384	temperature crayons (ES)	139	352
gyros (NL)	143	378	counters, automatic	124	252			
IC prices (NL)	142	374	control system (NL)	143	380	Production		
ICs, beam-lead	130	293	data acquisition (NL)	145	381	control system (NL)	143	380
ICs, TTL	132	278	data acquisition system	133	281	rate control system	138	349
integrated circuits (NL)	142	377	decibel tables (DA)	140	356	soldering pencil	138	348
LC circuits, tunable	126	258	DVM, peak-reading	125	255	substrate sealer	138	351
magnetic pickups (DA)	140	355	gyros (NL)	143	378	test chambers (NL)	145	385
op amps, flatpack	131	274	logic analyzer	124	251	wafer cleaner	138	350
photodetector	131	275	meters, taut-band (NL)	143	379	welding, percussive (AN)	141	366
phototransistor array	131	276	oscilloscope, 3-in.	124	253			
power, digital (NL)	142	375	panel design (AN)	141	367			
readouts, fiber-optic	128	262	power, digital (NL)	142	375			
rectifiers, avalanche	130	297	recording system (NL)	142	372			
regulator, voltage	132	280	resistance, contact (AN)	141	365			
relay, DIP reed	128	263	scope, audio/lab	125	256			
resistance, contact (AN)	141	365	stability	141	364			
resistor networks	126	259	terminal, graphics	134	286			
resistors, chip (ES)	139	353	test chambers (NL)	145	385			
relay slide rule (DA)	140	354	tester, microcircuit	124	254			
semiconductors, optical	130	296	voltmeters, digital	122	250			
surge protectors (AN)	141	368						
switch, ladder	132	279	Microwaves & Lasers					
switches (NL)	145	386	amplifiers, MIC	136	342			
temperature crayons (ES)	139	352	attenuator	136	343			
thermistor, rugged	128	265	couplers, MIC	137	344			
time-delay module	129	272	diodes, p-i-n (AN)	141	363			
transformer, audio	127	261	diodes, varactor	137	345			
transformers, PC	127	260	filters, bandpass	137	347			
zeners & rectifiers (NL)	142	370	oscillator, MIC	137	346			
			stability	141	364			
			transistor, S-band	136	341			
			transistors, power	136	340			
Data Processing								
calculator, printing	134	287	Modules & Subassemblies					
computer, aerospace	132	282	amplifier, video	128D	267			
control system (NL)	143	380	converter, a/d	133	283			
converter, a/d	133	283	delay lines, TO-5	128	264			
data acquisition (NL)	145	381	gyros (NL)	143	378			
data acquisition system	133	281	hybrids, high-power (NL)	142	371			
memory, photo-optic	133	284	LC circuits, tunable	126	258			
microfilm system	134	285	meters, taut-band (NL)	143	379			
recording system (NL)	142	372	op amp	128D	270			
teleprinter, full-page	134	288	op amp, FET	128D	268			
terminal, graphics	134	286	op amps, flatpack	131	274			
			power, digital (NL)	142	375			
ICs & Semiconductors			power supplies	128D	266			
capacitors, chip	126	257	readouts, fiber-optic	128	262			
comparator, dc	131	273	relay, DIP reed	128	263			
diodes, p-i-n (AN)	141	363	relay slide rule (DA)	140	354			
diodes, zener	130	294	resistor networks	126	259			
driver, clock	132	277	sequencer, 4-phase	129	271			
IC prices (NL)	142	374	switches (NL)	145	386			
ICs, beam-lead	130	293	switches, ladder	128D	269			
ICs, TTL	132	278	time-delay module	129	272			
integrated circuits (NL)	142	377	transformer, audio	127	261			
op amps, flatpack	131	274	transformers, PC	127	260			
photodetector	131	275						
phototransistor array	131	276						
rectifiers, avalanche	130	297						

Application Notes

diodes, p-i-n	141	363
panel design (AN)	141	367
polymers, block	141	369
resistance, contact	141	365
stability, short-term	141	364
surge protectors	141	368
welding, percussive	141	366

Design Aids

decibel tables	140	356
magnetic pickups	140	355
relay slide rule	140	354

Evaluation Samples

resistors, chip	139	353
temperature crayons	139	352

General Railway
Signal Company
uses both silicone
and vitreous coated
Dale Resistors



Now...rugged Dale Wirewounds with your choice of coatings!

Coating makes a difference in the performance of industrial power wirewounds. That's why it's easier to call Dale when you're not sure what's best for your application. We make both silicone (HL) and vitreous (VL) coated models. Before coating they're identical. HL models receive multi-layer coatings of a special silicone formulation. This low-temperature process has less effect on resistor windings—and we sell more HL resistors where customers are primarily concerned with maintenance of tolerance and low TC. Our vitreous enamel coating is baked on to provide maximum resistance to moisture and chemical action—and VL sales are highest where these conditions are a factor. Today many companies—like General Railway Signal—make good use of Dale's single-source capability for power resistors. You can, too.

12 Different Silicone (HL) and Vitreous (VL) Models

	HL/VL 3-225 watts, .1 ohm to 1.3 Meg., $\pm 5\%$ tol.*		HLT/VLT 11-225 watts, .1 ohm to 1.1 Meg., $\pm 5\%$ tol.
	HLW/VLW 3-20 watts, .1 ohm to 80K ohms, $\pm 5\%$ tol.*		HLZ 40-375 watts, .13 ohm to 25 ohms, $\pm 10\%$ tol.
	HL/VL Flat 24-95 watts, .1 ohm to 150K ohms, $\pm 5\%$ tol.*	MIL. SPEC. All HL and VL models meet or exceed the requirements of MIL-R-26 and MIL-R-19365C where applicable.	
	HLM/VLM 10-20 watts, .1 ohm to 51K ohms, $\pm 5\%$ tol.	* $\pm 10\%$ below 1 ohm	
	HLA 10-225 watts, 1 ohm to 100K ohms, $\pm 5\%$ tol.		

*For fast price and
delivery information,
phone 402-564-3131.*

DALE ELECTRONICS, INC.

1328 28th Ave., Columbus, Nebr. 68601
In Canada: Dale Electronics Canada, Ltd.

INFORMATION RETRIEVAL NUMBER 233

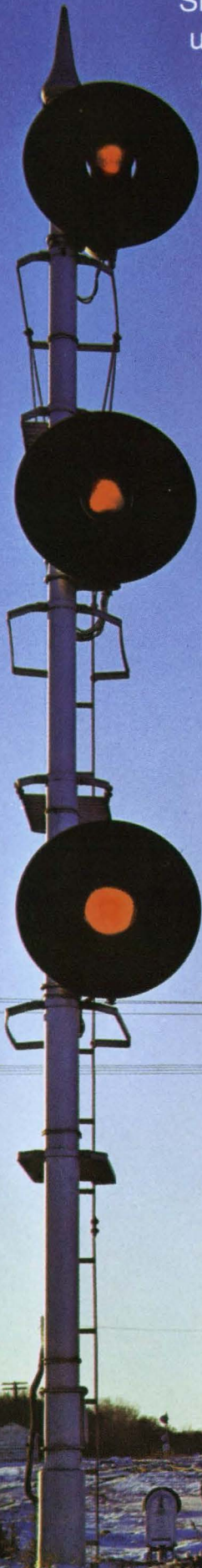



RCA-TA7205
(actual size)

Here—available—is the world's highest power, highest gain, highest efficiency transistor for operation at 2 GHz. In addition to the features above, this silicon n-p-n "overlay" transistor also offers 11-W output with 11.5-dB gain at 1.2 GHz at 60% efficiency.

The package is all new: hermetically-sealed, ceramic-metal, coaxial type that can be used in large signal applications in coaxial, stripline, and lumped-constant circuits.

RCA's multiple-emitter-site "overlay" construction is a feature recently patented.

The RCA-TA7205 is intended for reliable performance in such applications as microwave communications, S-band telemetry, microwave relay link, phased-array radar, distance measuring equipment, and collision avoidance systems.

Ask your local RCA Representative or your RCA Distributor for more detailed information. For technical data, write: RCA Electronic Components, Commercial Engineering, Section PG8-1, Harrison, N.J. 07029.

**5.8-W (typ.) output,
7.6-dB gain,
45% efficiency,
at 2 GHz,
in common-base circuit.
New and now—
RCA-TA7205**

RCA