

Electronic Design 13

VOL. 18 NO.

FOR ENGINEERS AND ENGINEERING MANAGERS

JUNE 21, 1970

Powerhouse in a transistor can beam 15-dB gain and a 1-mW output from 5 to 500 MHz. Up to four amplifiers can be cascaded on a single substrate for 60 dB

of gain without any sacrifice in either bandwidth or noise figure. The new vhf/uhf hybrid can also be supplied in a fully shielded package. Details on page 129.



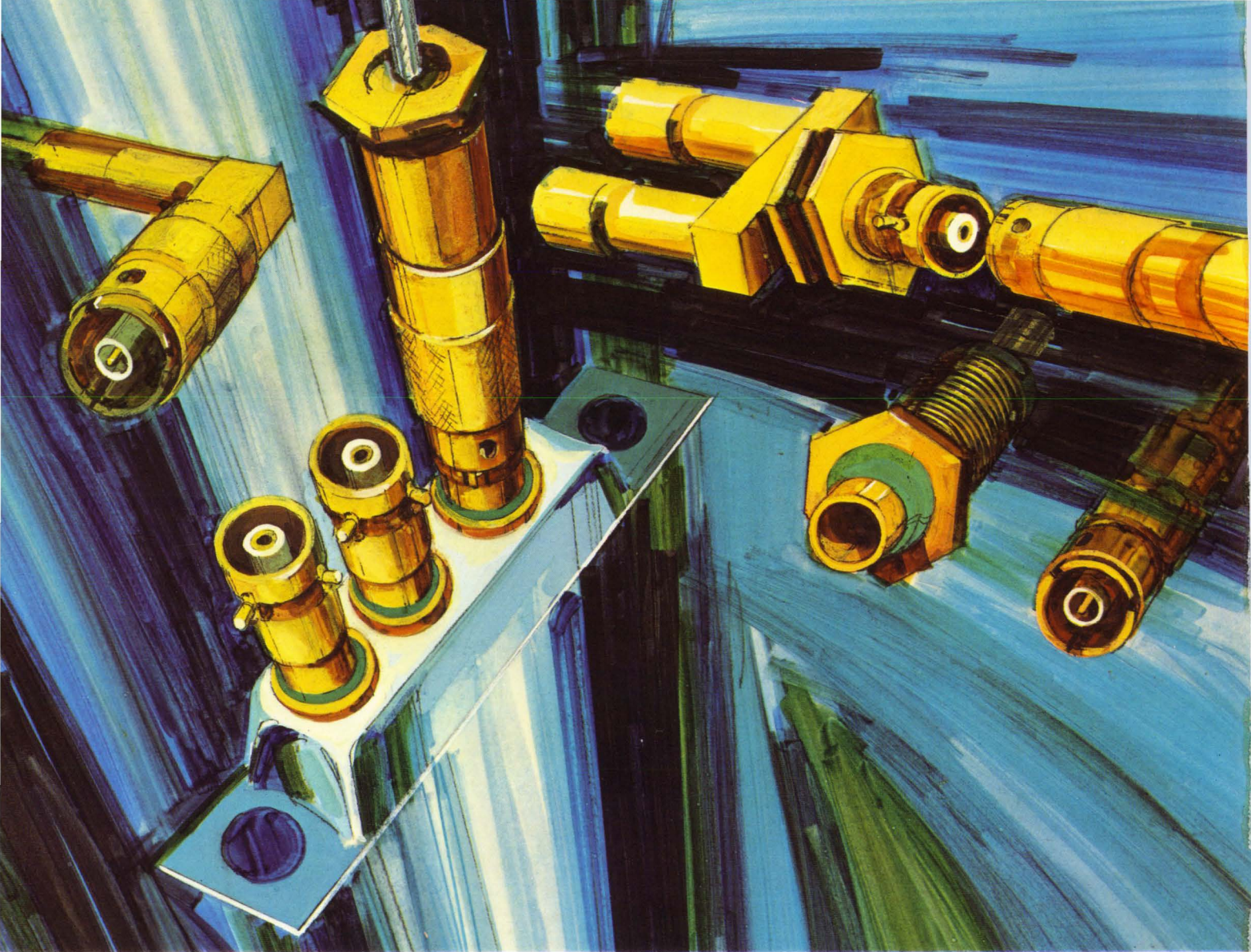

100% electrical continuity...in virtually any environment... CINCH-NULINE'S NU-LOK CONNECTORS

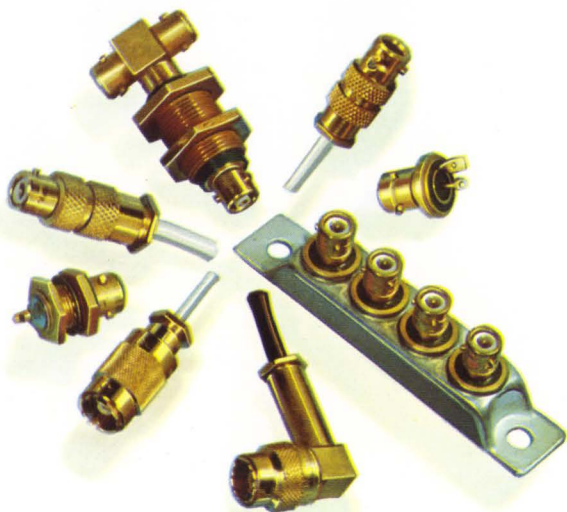

Cinch-Nuline 1200 Series Nu-Lok Connectors are coaxial type units per MIL-C-25516, designed for *critical* electronic applications where failure-proof continuity under adverse conditions is essential.

These Nu-Lok connectors feature positive bayonet locking that withstands more than 3000 Gs vibration... fused glass-to-metal hermetically sealed or gasketed environment resistant construction... and crown type, closed entry contacts for repeated distortion-proof mating.

Nu-Lok "100% reliable" connectors, for either solder or crimp installation, are available in a wide variety of "off-the-shelf" configurations or in special variations to meet your specific requirements. For detailed information on 1200 Series Nu-Lok Connectors, write Cinch-Nuline, a Division of TRW Inc., 1015 South Sixth Street, Minneapolis, Minnesota 55415. CN-7072

CINCH-NULINE

Need A Scope That Remembers?

If you make real-time measurements in the 50 MHz to something for you to remember: Only Hewlett-Packard offers

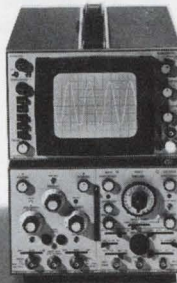

100 MHz frequency range, here's a storage scope with bandwidth

capabilities in these frequencies. In addition to this exclusive capability, Hewlett-Packard offers a scope that remembers sampling displays and spectrum analysis displays. If you want low-frequency, high-sensitivity in a low-cost

scope that you can

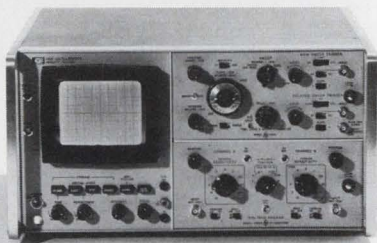

remembers, HP has it, too. In all the HP scopes, at the twist of a knob, vary persistence—an HP exclusive. HP's storage technique allows you

to store gray shades for complete Z-axis information—another HP exclusive. HP storage industry-standard, aluminized, P-31 phosphor; so you get the same brightness, the same resistance, the same writing speed, the same operating life you get with a conventional CRT—another HP exclusive.

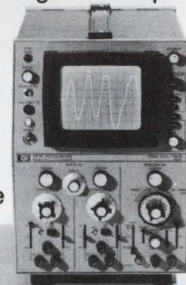

CRT's use burn-

And, HP storage CRT's are the only ones with an internal graticule to eliminate parallax. With an HP storage scope,

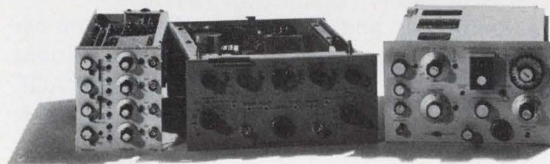

you really get three scopes in one. Use it to store, or to vary

display time, or as a conventional scope. Choose a 180 or 140 series storage oscilloscope with plug-ins which match

your high frequency needs. Choose the low-cost

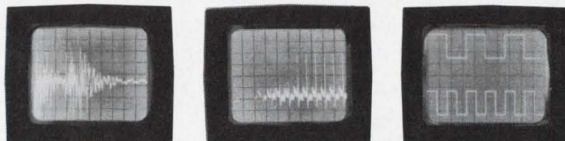

1200 series for

your low-frequency measurements. For application information on HP scopes that remember, contact your local HP field engineer.

080/5

Or, write to Hewlett-Packard, Palo Alto, California 94304.
 Europe: 1217 Meyrin-Geneva, Switzerland.
 Prices: HP 141 Mainframe, \$1395 or \$1500;
 HP 181A Mainframe, \$1850; HP 1200 Series, \$1550 or \$1900.

HEWLETT  **PACKARD**
 OSCILLOSCOPE SYSTEMS

INFORMATION RETRIEVAL NUMBER 2

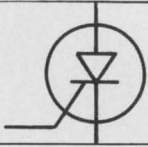

EXPANDED

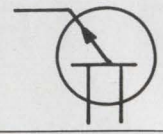

SEMICONDUCTOR TEST CAPABILITY FROM TEKTRONIX



THE TYPE 576 CURVE TRACER—designed to provide maximum performance in the circuit design laboratory, on the production line or in service applications. An **EXPANDED VIEWING AREA** combines a 10 cm x 12 cm graticule with fiber-optic readout of scale factors, step amplitude, and Beta/div or g_m /div. This **SCALE FACTOR READOUT** displays parameters near the CRT for convenient reference during setup, testing and photographic recording. The Collector Supply provides swept or DC voltages to a maximum of 1500 V. A versatile Step Generator allows **CALIBRATED STEP OFFSET** and **PULSED BASE OPERATION** in addition to conventional modes. Vertical **DISPLAY OFFSET** with precise auto positioning control and X10 magnification

provides a calibrated and expanded effective measurement axis to 100 cm. This increased measurement sensitivity at all scale factors even allows **LEAKAGE MEASUREMENTS** to 1 nA/div! **MULTI-FUNCTION SWITCHING** makes test setup fast and easy to understand, providing direct reading power limits, polarity tracking and automatic display positioning. Additional accuracy is derived through provision for **KELVIN SENSING** (for high current tests). Operator convenience is enhanced by **INTERLOCK OPERATOR PROTECTION** and availability of a complete line of device testing adapters.

Type 576 Curve Tracer \$2250
U.S. Sales Price FOB Beaverton, Oregon

Your local Tektronix field engineer will be happy to demonstrate the Type 576 in your application. For additional information, please call him or write Tektronix, Inc., P.O. Box 500, Beaverton, Oregon 97005.



Tektronix, Inc.

committed to progress in waveform measurement

NEWS

- 21 **News Scope**
- 25 **At the International Microwave Symposium:**
New isolator boosts solid-state power
Elliptic-filter design advances in two areas
- 30 **An anticollision system for all planes**
FAA funding is sought for RCA's Secant system, which is cooperative and comes in three versions.
- 32 **Electronic system stops corrosion of metals**
Material is allowed to corrode as a substitute for metals that are subject to electrolytic action.
- 33 **Technology abroad**
- 34 **Worldwide network to predict solar EMI**
- 41 **Washington Report**

TECHNOLOGY

- 68 **Design MOS circuits on a computer.** This handy program overcomes the limitations of conventional graphical techniques.
- 74 **Any code goes with IC decoder/drivers.** Just rearrange some wires, and you can drive display tubes without first converting to BCD.
- 78 **For circular polarization, try a bifilar helix.** This antenna obtains an excellent axial ratio—independent of its beamwidth.
- 82 **Solve op-amp slew-rate requirements** from voltage and frequency specifications. This nomogram provides the answer directly.
- 86 **Think sales engineering is your thing?** What if it isn't? This article may help you to answer two key questions.
- 92 **Ideas for Design**
- 103 **Product Source Directory: Op Amps**

PRODUCTS

- 129 **Microwaves & Lasers:** TO-can amplifiers gain 14 dB from 5 to 500 MHz.
- 133 **Modules & Subassemblies.** FET-input op amps offer 100-fA bias current.
- 137 **ICs & Semiconductors:** Digital TTL ICs feature beam-lead construction.
- 144 Components
- 149 Data Processing
- 154 Instrumentation
- 156 Packaging & Materials
- 157 Tools & Engineering Aids
- 176 Product Index

Departments

- 67 **Editorial:** Sure, it's a down year, but what are you doing about it?
- 13 Designer's Calendar
- 46 Sidelights
- 158 Evaluation Samples
- 159 Design Aids
- 160 Application Notes
- 162 New Literature
- 170 Product Bulletin Board
- 174 Advertisers' Index

Information Retrieval Service Card inside back cover

Cover: Vhf/uhf amplifier made by Avantek, Inc., Santa Clara, Calif.
Photo by Henry Ries.

ELECTRONIC DESIGN is published biweekly by Hayden Publishing Company, Inc., 850 Third Avenue, New York, N.Y. 10022. James S. Mulholland, Jr., President. Printed at Brown Printing Co., Inc., Waseca, Minn. Controlled circulation postage paid at Waseca, Minn., and New York, N.Y. Copyright © 1970, Hayden Publishing Company, Inc. 82,501 copies this issue.

If you need
all the
functions, and
you need them
in a hurry,
you're smart to
do business
with the
big guys.

Nine MSI (More to come.)

	Order Number	Package	Temperature Range	Price 100pc Mix
Counters				
8284A	N8284A	Dip	0°C to + 75°C	\$ 5.85
	S8284A	Dip	-55°C to +125°C	11.70
8285A	N8285A	Dip	0°C to + 75°C	5.85
	S8285A	Dip	-55°C to +125°C	11.70
9310	U6B931059X	Dip	0°C to + 75°C	11.75
	U6B931051X	Dip	-55°C to +125°C	16.00
9316	U6B931659X	Dip	0°C to + 75°C	11.75
	U6B931651X	Dip	-55°C to +125°C	16.00
Demultiplexers				
9301	U6B930159X	Dip	0°C to + 75°C	6.25
	U6B930151X	Dip	-55°C to +125°C	9.35
Multiplexers				
9309	U6B930959X	Dip	0°C to + 75°C	5.30
	U6B930951X	Dip	-55°C to +125°C	7.95
9312	U6B931259X	Dip	0°C to + 75°C	5.30
	U6B931251X	Dip	-55°C to +125°C	7.95
Registers				
9300	U6B930059X	Dip	0°C to + 75°C	6.50
	U6B930051X	Dip	-55°C to +125°C	9.75
Adders				
9304	U6B930459X	Dip	0°C to + 75°C	7.50
	U6B930451X	Dip	-55°C to +125°C	10.25

1. All units listed here are functionally, electrically and pin-for-pin replacement for the original manufacturers' devices.
2. All units, hermetic DIP and TO-5, are subjected to 100% stress test as outlined in MIL STD 883 Test Method T5004.

MSI & Linear Mixing Discounts!

Only Advanced Micro Devices offers quantity discounts on combined orders for complex digital and linear circuits. A minimum of ten pieces of a single device type can be combined for 100 or 1000 piece mixed quantity pricing.

Here's an example:

Qty.	Device	10-99	100pc Mix price	Savings/ Device
10	101A	\$36.00	\$30.00	\$6.00
15	715C	9.55	7.95	1.60
25	723C	3.90	3.25	0.65
25	9310	14.00	11.75	2.25
25	9300	7.80	6.50	1.30

Nobody's bigger than we are.

Nobody has more talent in MSI product definition, circuit development, silicon processing, and testing capability. Nobody.

We don't make everything, though. We don't make jelly beans and 10,000-gate freaks. We make complex monolithic digital circuits. That's our business.

Call us if we can help with technical information or quantity pricing.

To order, call our distributor, Avnet. They're just like us only closer.

Everybody makes them the same, right? Wrong.

Advanced Micro Devices makes only one quality device: Military standard or better.

One quality production means higher yields, commercial prices, less rejects in your plant, better reliability in the field.

One quality production. In-house qualified through documented electrical and mechanical life testing. 100% stress tested to MIL STD 883.

It's about time.

Advanced Micro Devices has perfected the production technology of complex, mainstream digital and linear monolithic circuits.

Advanced Micro Devices, Inc.

(One of the big guys.)

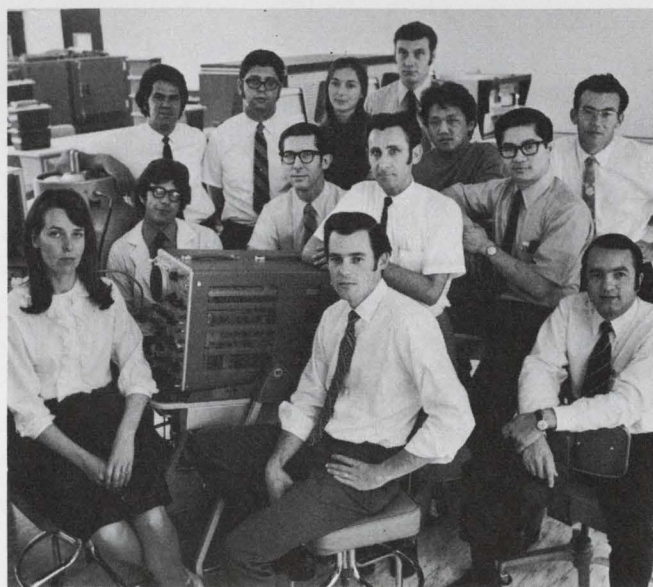

Some of our technical staff:

Left to right: Donna Mellick, John Carey, Sal Spinella, Ken Neves, Ted Hollinger, Cathy Dellor, Gene Conner, Lou DeMille, Stan Wilson, Peter Lee, Tom Wong, Clive Ghest, Sven Simonsen.

To make the lowest-cost arithmetic logic unit with carry lookahead built-in,



Fairchild's new 9340 is the perfect arithmetic logic unit for almost every application. It's a high-speed device that can perform two arithmetic operations (ADD or SUBTRACT) and any of six logic operations on two 4-bit binary words in parallel. To handle 16 bits, just hook up four 9340s.

And nothing else.

The 9340 can ADD two 4-bit words in 28ns and SUBTRACT two 4-bit words in 33ns. The addition of two 16-bit words takes only 42ns.

The new ALU has full internal carry lookahead, and provides either a ripple carry output or carry lookahead outputs. The speed and flexibility of the 9340 make it ideal for other applications like multipliers, dividers and comparators.

Input clamp diodes are used on all inputs to limit high speed termination effects in the 9340. Input/output characteristics provide easy interfacing with all Fairchild DT μ L, TT μ L and MSI families.

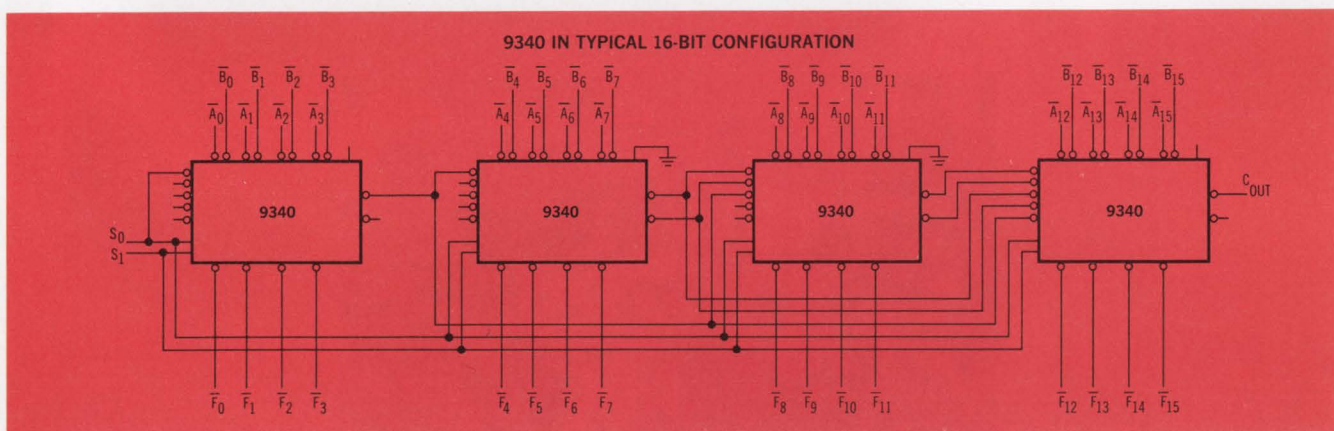

To order the 9340, call your Fairchild Distributor and ask for:

PART NUMBER	PACKAGE	TEMPERATURE RANGE	PRICE		
			(1-24)	(25-99)	(100-999)
U6N934059X	DIP	0°C to + 75°C	\$20.90	\$16.70	\$14.00
U6N934051X	DIP	-55°C to +125°C	41.80	33.40	28.00
U4M934059X	Flat	0°C to + 75°C	23.00	18.40	15.40
U4M934051X	Flat	-55°C to +125°C	46.00	36.80	30.80

you have to get serious about MSI family planning.

We put together a family plan by taking systems apart. All kinds of digital systems. Thousands of them.

First we looked for functional categories. We found them. Time after time, in a clear and recurrent pattern, seven basic categories popped up: Registers. Decoders and demultiplexers. Counters. Multiplexers. Encoders. Operators. Latches.

Inside each of the seven categories, we sifted by application. We wanted to design the minimum number of devices that could do the maximum number of things. That's why, for example, Fairchild MSI registers can be used in storage, in shifting, in counting and in conversion applications. And you'll find this sort of versatility throughout our entire MSI line.

Finally, we studied ancillary logic requirements and packed, wherever possible, our MSI devices with input and output decoding, buffering and complementing functions. That's why Fairchild MSI reduces—in many cases eliminates—the need for additional logic packages.

The Fairchild MSI family plan. A new approach to MSI that's as old as the industrial revolution. It started with functional simplicity, extended through multi-use component parts, and concluded with a sharp reduction in add-ons. Simplicity. Versatility. Compatibility. Available now. In military or industrial temperature ranges. In hermetic DIPs and Flatpaks. From any Fairchild Distributor.

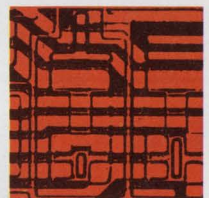

OPERATORS
9304—Dual Full Adder/
Parity Generator
9340—Arithmetic
Logic Unit

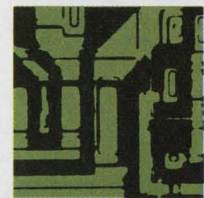

LATCHES
9308—Dual 4-Bit Latch
9314—Quad Latch

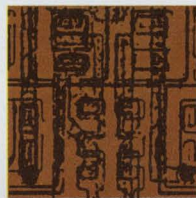

REGISTERS
9300—4-Bit Shift
Register
9328—Dual 8-Bit
Shift Register

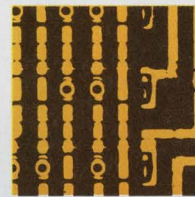

MULTIPLEXERS
9309—Dual 4 Input
Digital
Multiplexer
9312—8-Input Digital
Multiplexer
9322—Quad 2-Input
Digital
Multiplexer

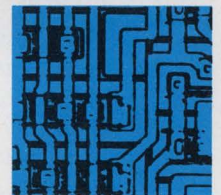

**DECODERS AND
DEMULPLEXERS**
9301—One-Of-Ten
Decoder
9315—One-Of-Ten
Decoder/Driver
9307—Seven-Segment
Decoder
9311—One-Of-16
Decoder
9317—Seven-Segment
Decoder/Driver
9327—Seven-Segment
Decoder/Driver



COUNTERS
9306—Decade Up/
Down Counter
9310—Decade Counter
9316—Hexidecimal
Counter

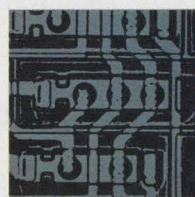

ENCODERS
9318—Priority 8-Input
Encoder

FAIRCHILD
SEMICONDUCTOR

microtopics

High-current Darlington amplifier.

This useful Philco® device has two newsworthy features. One is its 5-ampere capacity (400 μ s pulse, 2% duty cycle); the other is the 40-volt holdoff voltage (collector-to-base test breakdown voltage at output).

These features and a current gain of 2500 put the DP2066 "head and

shoulders" above other Darlington devices on the market. It's particularly suited for applications such as hammer drivers, readouts, minicomputers and peripherals, and military computers.

The high breakdown voltage means you can use the DP2066 to drive re-

lay coils and other inductive loads which generate high starting transients. Input is 1.5 volts . . . compatible with TTL or DTL. Packaged in a special TO-5 case with heavy leads.

CIRCLE 151 ON READER SERVICE CARD

Here's a 256-bit MOS RAM you can get today.

That's what's different about ours . . . we can *really* deliver it off the shelf.

It's a *complete* read-write memory system on a chip: 256-bit storage, read-write control logic, sense amplifier, and chip-select logic . . . with speed and total installed cost comparable to a core memory. And it *needs no peripheral electronics*.

Each bit is a bistable flip-flop that permits nondestructive readout. Bit pattern is 256 1-bit words—expandable to 4096 bits by stacking. Access time? Typically 1 μ s.

CIRCLE 152 ON READER SERVICE CARD

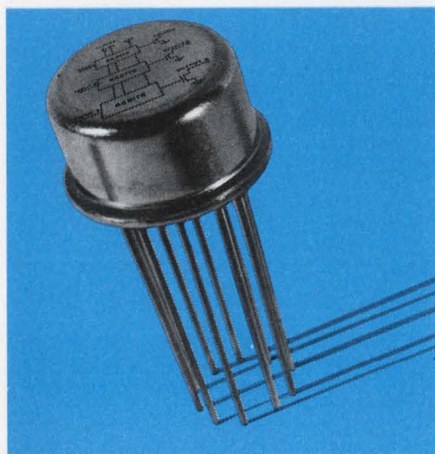
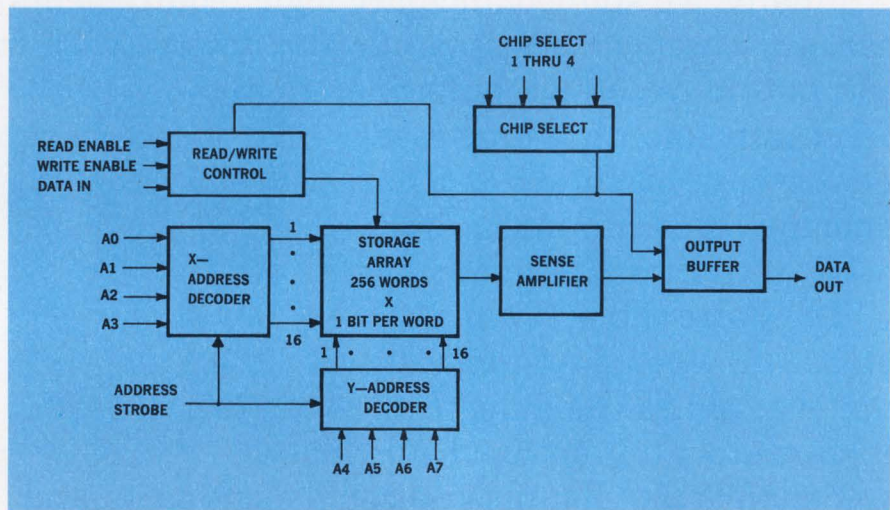

TRIPLE-66 BIT...another MOS shift register from Philco-Ford.

This newest Philco® dynamic shift register is designed to keep your package count down. By using a common power supply, common clock, and common ground, we also minimize the number of wired connections.

This "3-in-1" shift register stores 64 bits of information plus 2 bits of parity on each channel. Shift fre-

quency ranges from 10KHz to 1MHz. Input logic levels are -3 volts for a "0"; -9 volts for a "1." Output capability of each register is 2 ma load current at -3 volts.

Try the pL5R198C for applications like temporary storage, digital rate conversion, precision delays, signal processing correlation.

CIRCLE 153 ON READER SERVICE CARD

Hex converters now being made at Philco-Ford.

These previously hard-to-get circuits are now available from the better idea people. We call them PD9112. So when you need high-level hex converters, call on us. We're your reliable other source. The PD9112 provides an interface to convert from bipolar logic to the higher levels required for MOS devices. Six independent channels.

CIRCLE 154 ON READER SERVICE CARD

Low-leakage MOS clock driver.

The Philco® PH0007 high-speed clock driver is a pin-for-pin equivalent of other standard clock drivers . . . but there are some important differences. For one thing, the PH0007 leakage current is an order of magnitude smaller—only 10 μ amp at logic "1" input voltage. Also, switching times are significantly faster: 30 ns to logic "0" and 70 ns to logic "1" are typical. Maximum values are tight too: 75 and 100 ns respectively.

Other performance advantages include the low standby power of 5 mw, operation to 5MHz, output current capability to 500 ma, and output voltage swings to 30 v. Find out more about how the PH0007 surpasses other drivers in translating TTL or DTL logic levels to MOS levels, and driving high-capacity loads.

CIRCLE 155 ON READER SERVICE CARD

New, high-bit capacity static MOS ROMs.

You can get Philco® 2048-bit static ROMs custom-made for your application in just 6 weeks. For micro-programming, look-up tables, code conversion, control logic . . . you name it.

Select the bit organization that fits your needs: 8-bit, 4-bit, 2-bit, or 1-bit words. Need a large memory? Just stack these ROMs for any bit capacity, in multiples of 2048.

Because the pMS2048C is a static device, output data remains valid as long as an address is present . . . and

the output is compatible with both bipolar and MOS circuits.

Some Philco static ROMs are available off the shelf. The pMS2240C, for example, is a 2240-bit MOS device configured as a character generator. It's preprogrammed and, when addressed by the standard ASCII code, generates 64 alphanumeric display symbols . . . to create all the characters on a conventional teletypewriter. Access time for first-row bits is 1 μ s, 0.7 μ s for successive bits.

CIRCLE 156 ON READER SERVICE CARD

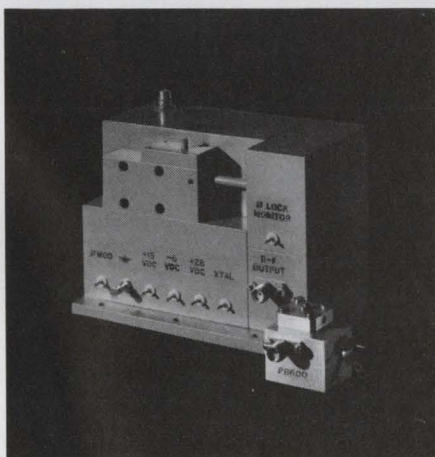
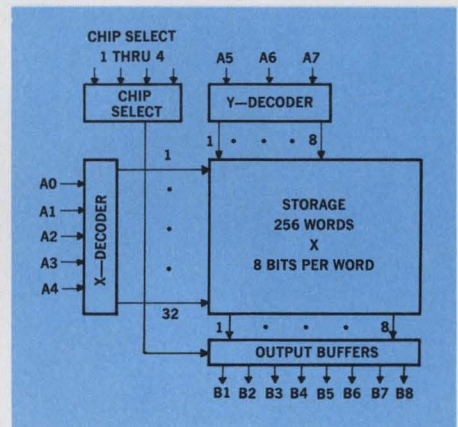

New phase-locked Gunn source.

If you want the advantages of crystal-controlled stability in a Gunn oscillator, draw a bead on our Series P8060. We call it the GunnLoc. And Philco-Ford is the only place you can get it!

The GunnLoc puts out 100 milliwatts in X band. It has low AM and FM noise, and it's free from the spurious outputs associated with multiplier chain sources. And it operates from only 15 volts.

Inside the GunnLoc is our P8600, available separately as a free-running voltage-controlled power source with the best temperature stability on the market: ± 10 ppm/ $^{\circ}$ C. The P8600 can be supplied for C, X or Ku band. Tunable over 5% bandwidth, the P8600 needs an input of only 12 volts dc, and produces up to 250 milliwatts.

CIRCLE 157 ON READER SERVICE CARD

**Reliability is a single-sided frame,
a ball and a cricket room.**

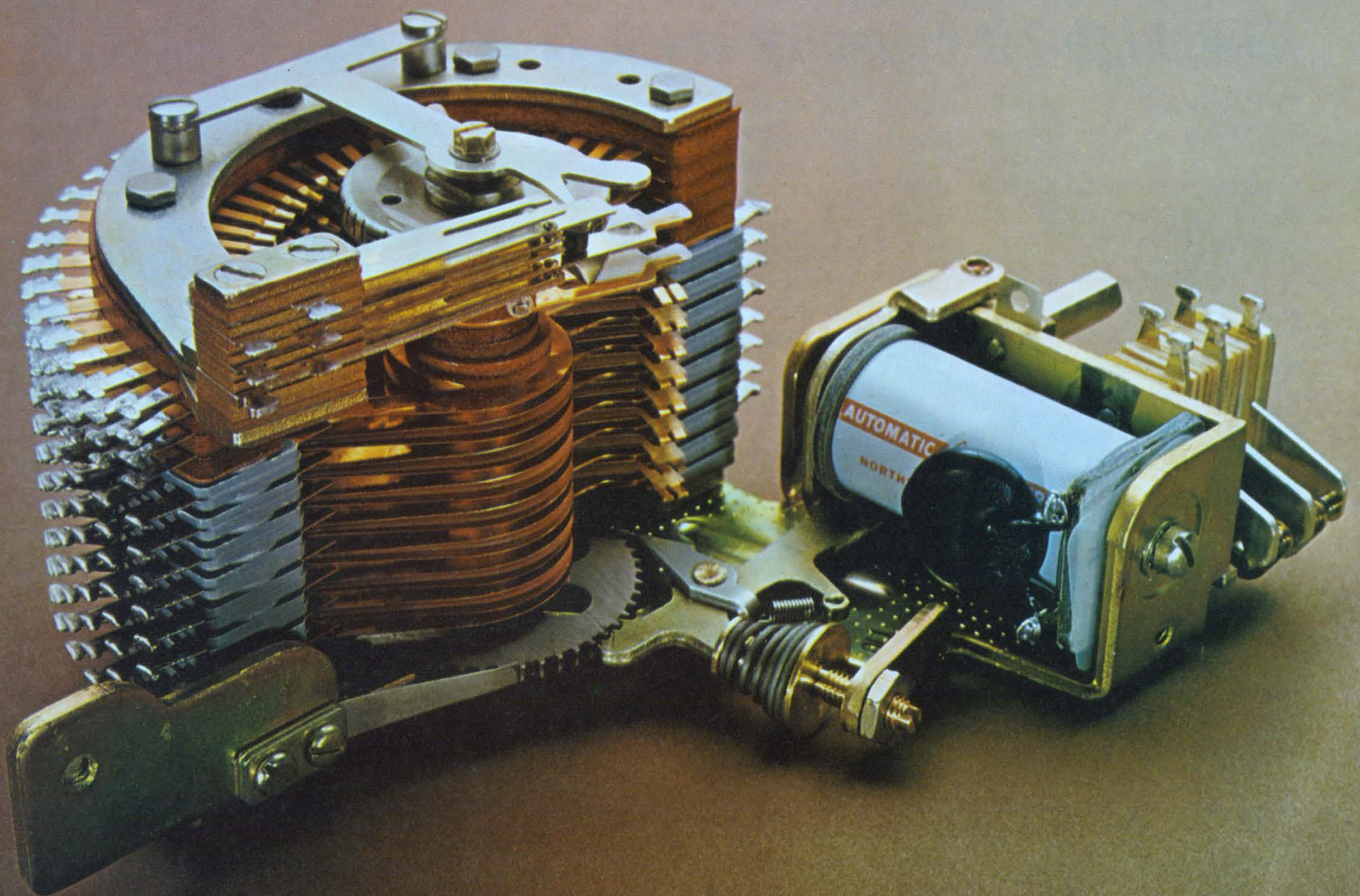

Our Type 45 rotary stepping switch is made to be forgotten. We build them to work hard, fast and long without constant fiddling or adjusting. They've got to be able to work in heat or cold, take bumps and grinds and still click-click along with close-spaced consecutive operations.

We start out really flat To

keep everything on the level we start our assembly with an open-type, one-piece frame. Thick and really flat. Some manufacturers use two thinner frames. But we found that starting with a single thick frame eliminates problems of matching the switch parts. Everything stays in line. And a single-sided frame takes a lot less room—the switch is only as wide as need be.

A lube job that lasts a lifetime The entire wiper assembly rotates on a large-diameter stainless steel shaft around a full-length hub bearing. We lubricate this bearing and seal it during assembly. So throw away the oil can.

Then we supply a pinch that's just right Each pair of wipers is tension-adjusted during assembly. As they click around the bank levels on a flat plane, we want each pair to pinch the contact just the right amount. Too hard a pinch and the contacts will wear out quickly. Too soft a pinch will cause a poor connection. We teach our wipers to pinch just right.

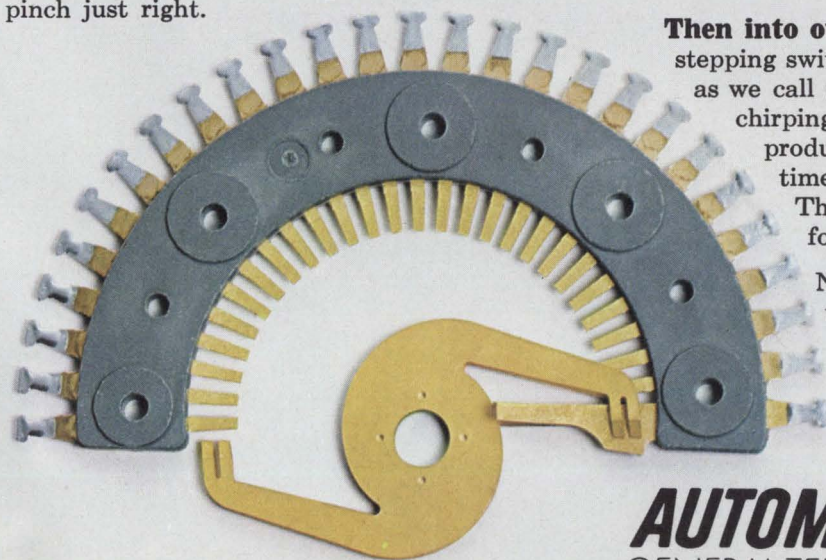

Then comes our big wheel

The entire wiper assembly is turned by the ratchet wheel. It's big and it's strong and it has 52 flat case-hardened teeth. Why flat teeth? So when they mesh with the teeth on the ratchet wheel they mesh tight. No banging, wiggling, or scraping. And as the teeth wear, they just mesh deeper in the grooves.

Ball bearing anchor for good measure

The armature assembly has to be securely fastened to keep it from wiggling up and down, or everything goes out of whack. So we choose a big stainless steel pin and secure it with wide bearings to the armature yoke. To make sure this pin never slips out of the yoke, we drill a hole in both ends. Then we force a steel ball bearing into these holes. This expands the walls of the pin into and against the walls of the armature and the whole assembly is anchored for life. We're the only ones that do it this way. So we're the only ones that offer a lifetime fit.

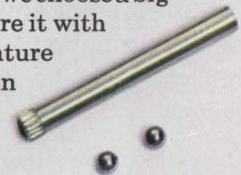

Then into our cricket room

Every single AE stepping switch goes to the run-in test room. Or, as we call it, the cricket room, because of the chirping noise all the switches we're testing produce. Here, every switch is tested 50 times a second for 45,000 operations. Then, and only then, are they ready for delivery to our customers.

Now that we've explained all the little things we do to make our Type 45 reliable, put it through your own tests. Industrial Sales Division, Automatic Electric Company, Northlake, Ill. 60164.

AUTOMATIC ELECTRIC
GENERAL TELEPHONE & ELECTRONICS

BOLD NEW LOOK IN ILLUMINATED SWITCHES!

It not only looks good, the Series 67000 illuminated DW "Multi-Switch"® switch is a glamorous bit of switch packaging. It's compact, low-cost and operates beautifully, too!

Large, square pushbuttons (19/32" sq.), in 6 different colors, provide brilliant (or soft), evenly—diffused lighting over the entire face of the pushbutton. Front relamping. Really, this is a honey!

Versatility? It's a low cost multiple station push-button switch available up to 18

stations in a row, in interlock, all-lock, non-lock and push-lock/ push-release, with up to 4PDT switching per station.

Quality! You're getting the same reliability and performance you're used to in other DW "Multi-Switch"® switches.

You can get optional extras such as barriers, solenoid release, multi-row ganged assemblies, intermixed functions, P.C. terminals. Fact is, there's a Series 67000 DW "Multi-Switch"® switch available for nearly every control panel require-

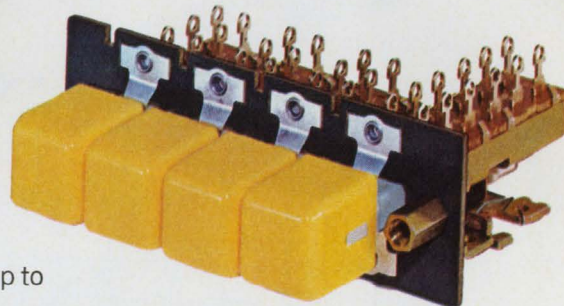

ment, from computers to home entertainment systems.

For additional information contact a Switchcraft Representative or write for Bulletin 208. SWITCHCRAFT, INC. 5555 N. Elston Avenue, Chicago, Illinois 60630.

SWITCHCRAFT
INC.



Designer's Calendar

JULY 1970						
S	M	T	W	T	F	S
			1	2	3	4
5	6	7	8	9	10	11
12	13	14	15	16	17	18
19	20	21	22	23	24	25
26	27	28	29	30	31	

For further information on meetings, use information Retrieval Card.

July 21-23

Conference on Nuclear & Space Radiation Effects (San Diego, Calif.) Sponsor: IEEE. Richard Thatcher, Battelle Memorial Inst., 505 King Ave., Columbus, Ohio 43201.

CIRCLE NO. 430

AUGUST 1970						
S	M	T	W	T	F	S
						1
2	3	4	5	6	7	8
9	10	11	12	13	14	15
16	17	18	19	20	21	22
23	24	25	26	27	28	29
30	31					

Aug. 25-28

Western Electronic Show & Convention (WESCON). Los Angeles. Sponsors: IEEE, WEMA. WESCON Office, 600 Wilshire Blvd., Los Angeles, Calif. 90005.

CIRCLE NO. 431

Aug. 30-Sept. 2

Electronic Materials Technical Conference (New York City). Sponsor: AIME. A. Reisman, IBM Corp., P.O. Box 218, Yorktown Heights, N.Y. 10598.

CIRCLE NO. 432

Sept. 1-3

Association for Computing Machinery Conference (New York City). Sponsor: ACM. ACM 70, 1133 Ave. of the Americas, N.Y., N.Y. 10036.

CIRCLE NO. 433

A Smart Way to Beat Your Power Supply Size Problem

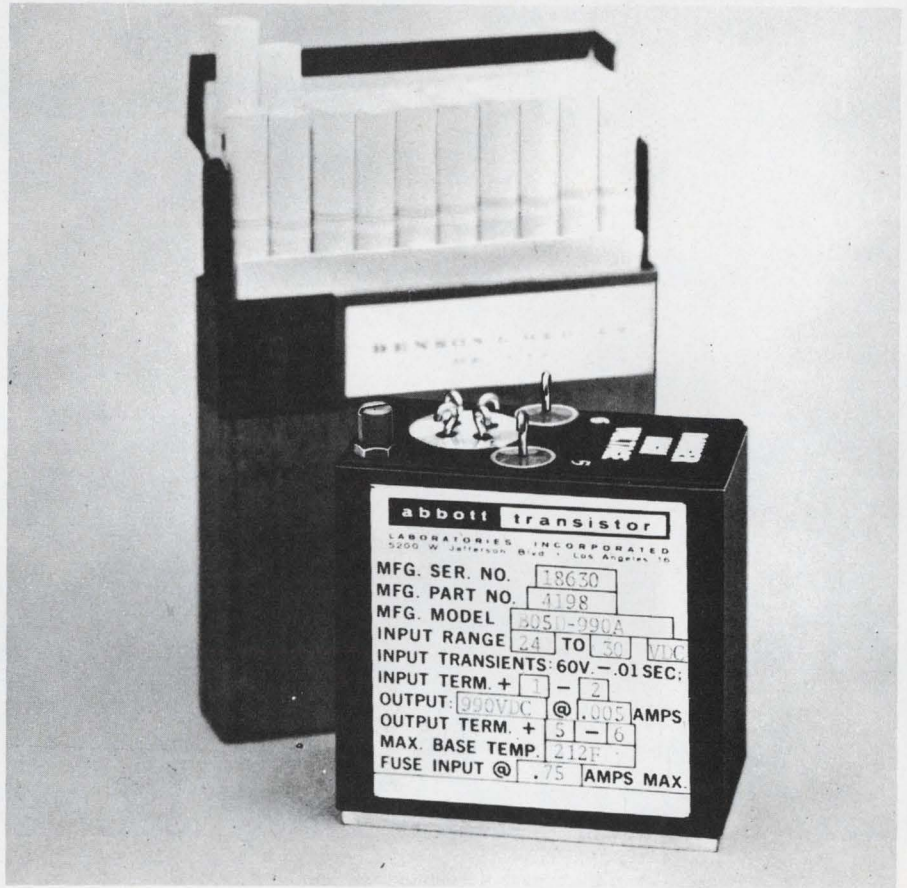

abbott

1½" thin, 2¾" short, yet this converter produces 1000 volts DC, regulated, from a battery input of 28 VDC! It weighs less than 15 ounces. This is only one of our wide variety of many small light weight converters, inverters and power supplies — there are over 3000 models listed in our newest catalog, including size, weight, and prices. If you have a size problem, why not send for an Abbott catalog?

MIL SPEC ENVIRONMENT — All of the power modules listed in our new catalog have been designed to meet the severe environmental conditions required by modern aerospace systems, including MIL-E-5272C and MIL-E-5400. They are hermetically sealed and encapsulated in heavy steel containers. New all silicon units will operate at 100°C.

Please write for your FREE copy of this new catalog or see EEM ELECTRONIC ENGINEERS MASTER Directory, 1834

RELIABLE — Highest quality components are used in Abbott power modules to yield the high MTBF (mean time between failure) as calculated in the MIL-HDBK-217 handbook. Typical power modules have over 100,000 hours MTBF — proving that the quality was built in from the beginning.

WIDE RANGE OF OUTPUTS — Any voltage from 5 volts DC to 10,000 VDC is available by selecting the correct model you need from our catalog with any of a variety of inputs including:

- 60 ϕ to DC, Regulated
- 400 ϕ to DC, Regulated
- 28 VDC to DC, Regulated
- 28 VDC to 400 ϕ , 1 ϕ or 3 ϕ
- 60 ϕ to 400 ϕ , 1 ϕ or 3 ϕ

**TO: Abbott Transistor Labs., Inc., Dept. 57
5200 West Jefferson Blvd.
Los Angeles, California 90016**

Sir:
Please send me your latest catalog on power supply modules:

NAME _____ DEPT. _____
COMPANY _____
ADDRESS _____
CITY & STATE _____

abbott transistor

LABORATORIES, INCORPORATED

**5200 W. Jefferson Blvd./ Los Angeles 90016
(213) WEBster 6-8185 Cable ABTLABS**

INFORMATION RETRIEVAL NUMBER 9



General Electric helps you solve the tough ones

GE has the broadest line of electronic components in the industry. From the tiniest integrated circuits to powerful high performance motors, GE components help you solve your tough problems . . . in design, in performance, in economy. Take a look at these GE problem solvers.

p.s.1 General Electric delivers 19 new epoxy TO-18 transistors for demanding applications. GE's encapsulated devices are performance-proved, reliable. And they cost less than metal-case devices.

The new epoxy transistors include PNP types, PNP/NPN complementary pairs, and low level amplifiers. They offer breakdown voltages as high as 60V with excellent beta linearity and dissipate up to 500 mW. They handle collector currents up to 1 amp. Get spec sheets on GE's new epoxy transistor lineup. Circle number 211.

p.s.2 GE meter relays put accurate dependability into critical new medical systems. A new heartbeat monitor, for instance, uses GE meter relays to indicate the heart beat visually. And they have the added capability to sound an alarm when preset limits are reached.

Either the easy-reading BIG LOOK® or the low profile HORIZON LINE® styles feature solid state control for precise accuracy. Put GE dependability into your critical circuits. Circle 212 for details.

p.s.3 Forget capacitor leakage problems with GE military-type tantalum wet slugs. The special GE design incorporates a double elastomer seal that maintains performance even through the 35 temperature cycles required by MIL-C-3965E. And life tests show a capacitance change of less than 5% in 2000 hours operation.

GE wet slugs come in 4 case sizes for applications up to 125 volts dc; 1.7 to 1200 μ f. GE's 20 years experience is your assurance of dependability. For complete information, circle 213.

p.s.4 GE Microwave Circuit Modules save up to 60% in size and weight for critical communications and radar systems. GE MCM's may be used as oscillators, amplifiers, multipliers, detectors, mixers, integrated isolators and circulators. And they are extremely stable even in adverse environments.

The GE C-2003E, for example, is used in pulsed transponder applications. It operates dependably from -54 to $+125^{\circ}\text{C}$ and withstands vibrations at 15G from 20 to 500 Hz. Frequency stability is $\pm 3\text{MHz}$ with minimum life of 500 hours operation. Get GE's MCM catalog. Circle 214.

p.s.5 New magnetic material gives 6% increase in residual flux density . . . resists demagnetization. GE's new Alnico 8C was developed for applications requiring high resistance to demagnetization plus a higher flux output than other Alnico 8 alloys.

Alnico 8C is the latest development in GE's complete line of Alnico permanent magnets. It's another example of the technical expertise you get when you specify General Electric to solve your magnet problems. For details on the entire GE Alnico family circle 215.

p.s.6 Get more capacitance in less space with GE computer-grade capacitors. These aluminum electrolytic units deliver up to 540,000 μ f at 5 VDC (34,000 μ f at 100 volts) . . . highest capacitance per case size available. They are rated for continuous duty at 65C or at 85C

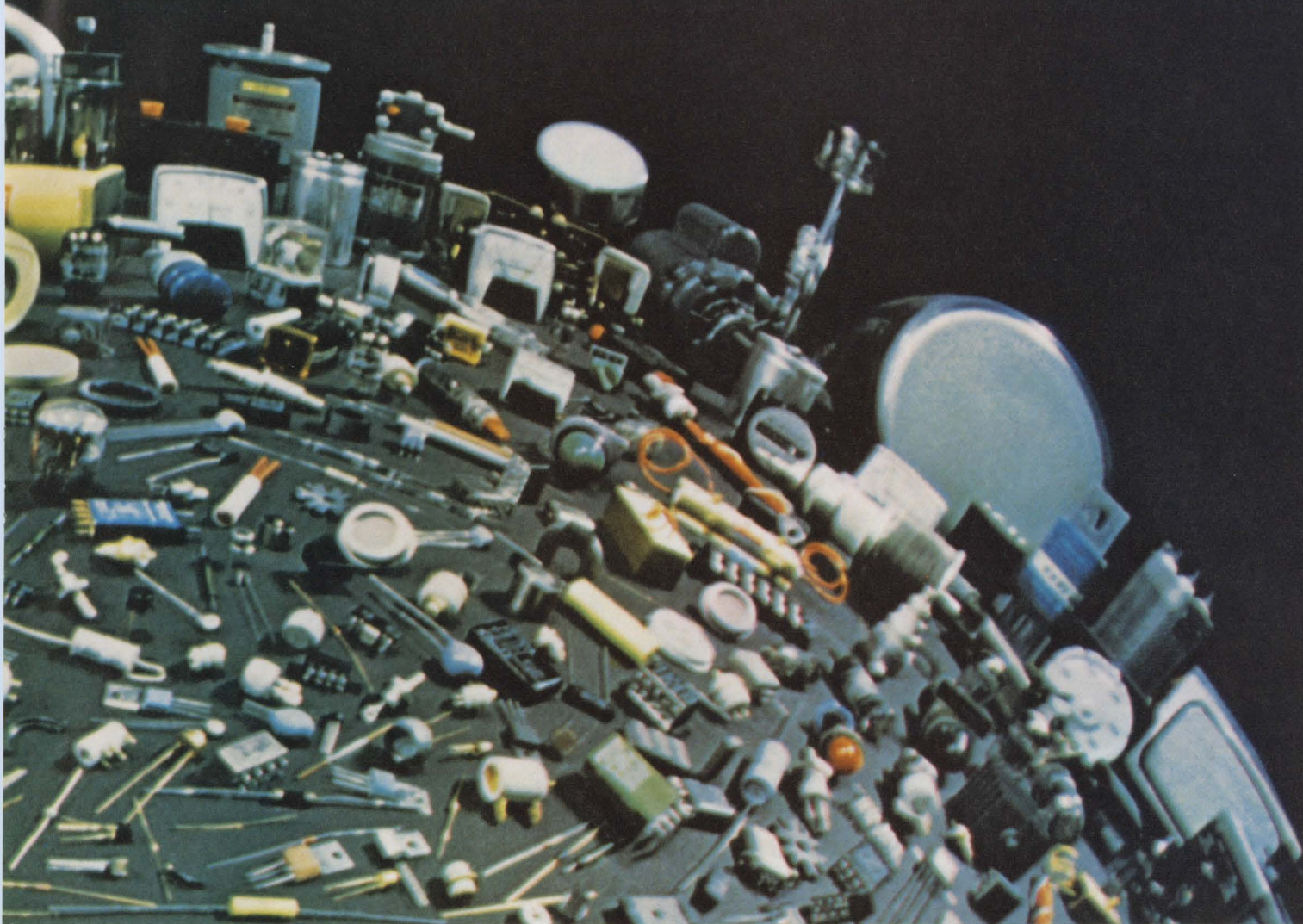

with the broadest line of electronic components

with proper voltage derating.

GE computer grades feature high ripple current capability with low equivalent series resistance. Nine case sizes are available. Circle 216.

p.s.7 Rechargeable GE nickel-cadmium batteries give you longer operating life. Proved GE reliability puts longer battery power into your application at an economical price.

Nominal ratings range from 0.1 amp-hours to 4.0 amp-hours in sealed cells and up to 160 amp-hours in vented types at the one-hour rate. Put dependable GE power in your circuit. Circle reader card number 217.

p.s.8 Programmable UJT lets you control the key parameters with just two resistors. That's right. You control η , R_{BB} , I_p and I_v so that you design your own unijunction as you design the circuit.

Low leakage and peak point currents make GE's D13T programmable UJT a natural for long interval timers. High breakdown voltages, fast trigger pulsing and low voltage operation add versatility. And the plastic TO-98 case helps solve economy problems. Get full details. Circle number 218.

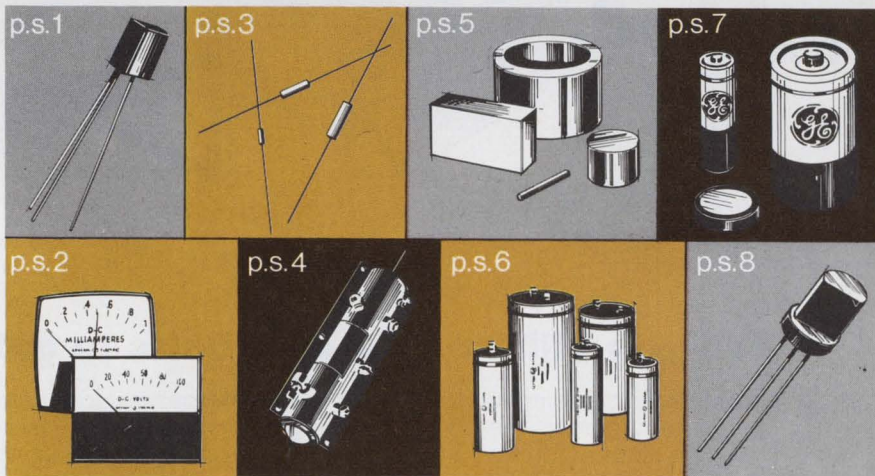

Let General Electric help solve your component problems. Call your nearest Electronic Components Sales Operation Office. Or check with one of the many authorized GE distributors. P.S. Problems? General Electric has solutions.

285-64

GENERAL  ELECTRIC

Grant makes thousands of thingumajigs that slide

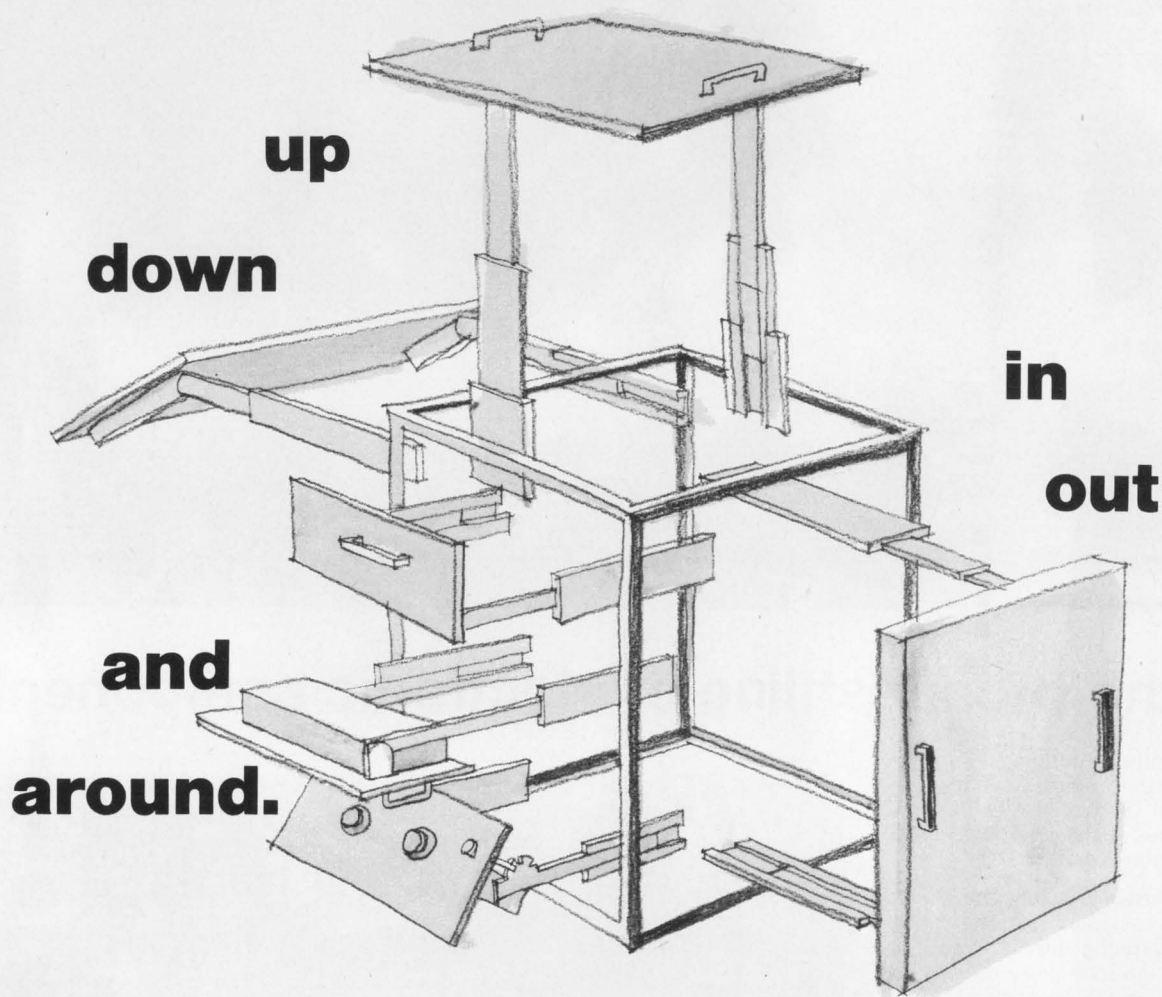

Are you still unscrewing bolts to get inside?

Grant slides come in hundreds of sizes and shapes, to do all sorts of things for all kinds of equipment. They add operating convenience. They increase reliability. And, they save time, money and effort in maintaining and repairing movable components.

To find out how Grant slides can improve both your products and the efficiency of your operation, write for a free copy of our slide catalog. Or, if you prefer, we'll be glad to have one of our engineers drop by and talk over your slide requirements with you. Grant makes more slides than anybody else in the country. But if our large inventory doesn't already contain just the thingumajig you need, we'll invent one to meet your specifications. Get in touch with us today.

GRANT®
WE KEEP THINGS MOVING

GRANT PULLEY & HARDWARE CO., div. of Instrument Systems Corp., 21 High St., West Nyack, N.Y. 10994 / 944 Long Beach Avenue, L.A., Cal. 90021

INFORMATION RETRIEVAL NUMBER 10

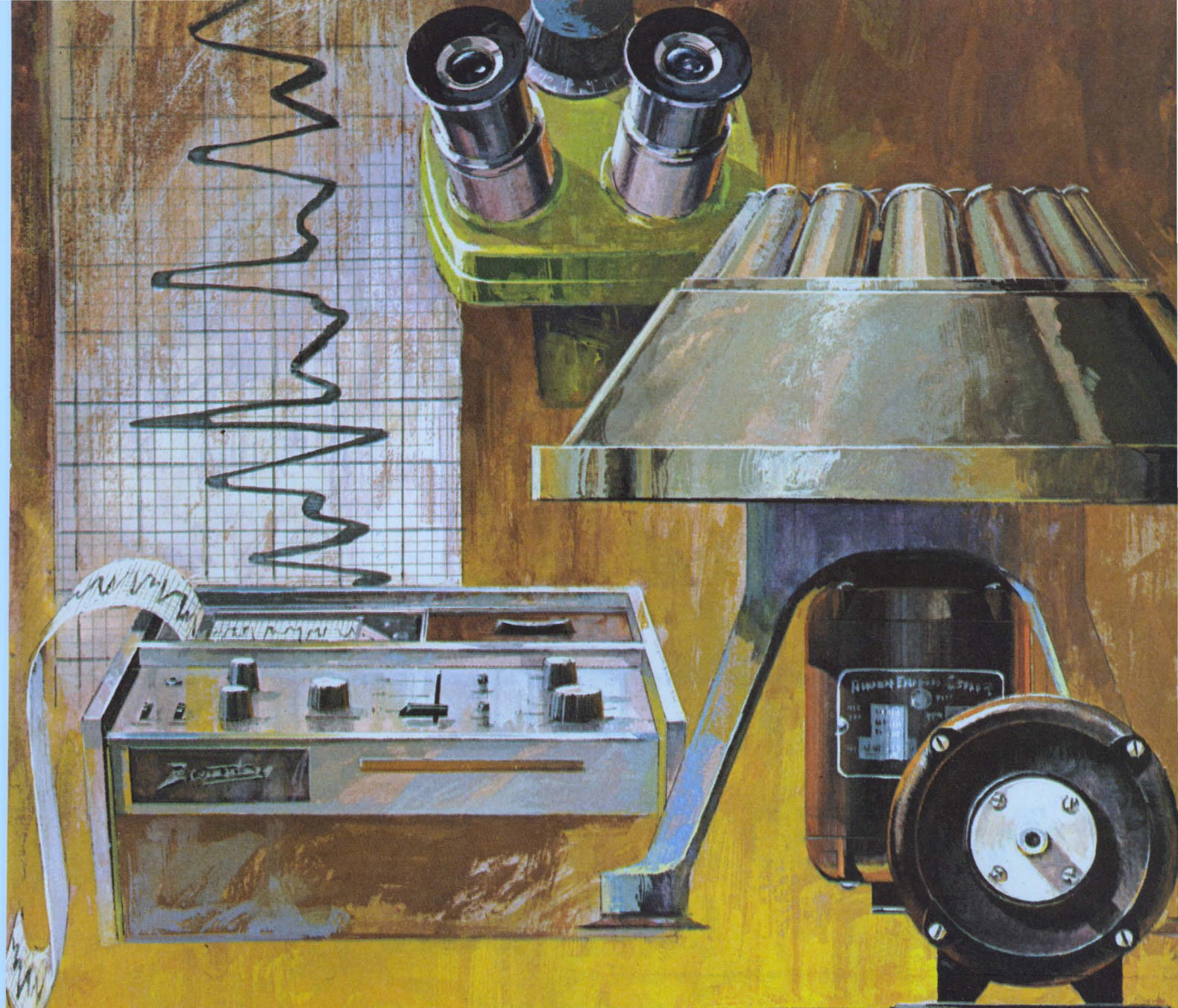

Bodine helps keep medical equipment strong hearted...

Bodine fractional horsepower drives. Small. Quiet. A complete line designed to keep medical equipment and apparatus powered precisely, reliably, for a long, long time. Motors built with all the integrity you've designed into your product—that deliver as specified with fewer callbacks and service problems. If this is the kind of power you're looking for, you'll find no better source.

Over 3,500 standard specifications to choose from. Bodine also builds custom and special fhp motors to design requirements. Our engineers will be happy to help you pinpoint the right one for your specific application need. Mechanical organ, heart recorder, test unit, pumps—whatever your product, specify Bodine fhp drives. The power behind the leading products for some 63 years. Write for bulletin. Bodine Electric Company, 2528 W. Bradley Place, Chicago, Illinois 60618.

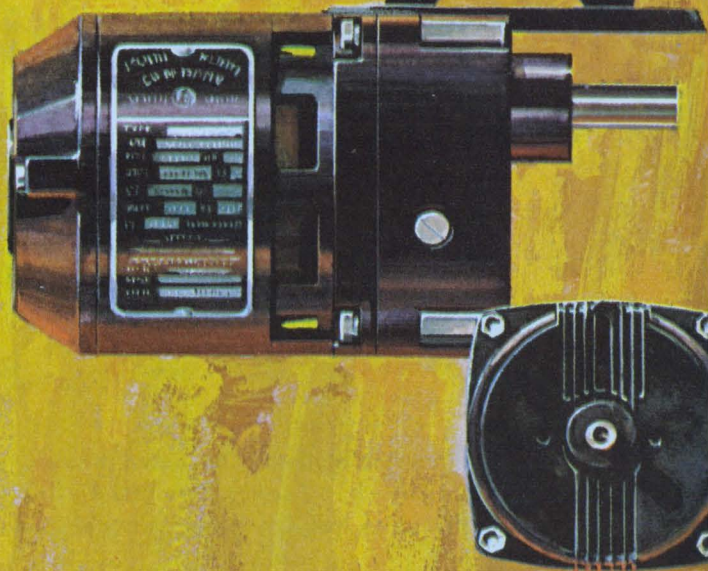

Bodine Motors Wear Out—It Just Takes Longer

BODINE MOTORS/CONTROLS

Ask about Bodine SCR motor speed controls

Now...new, lower capacitance values!

Type 192P PACER[®] FILMITE[®] 'E' CAPACITORS

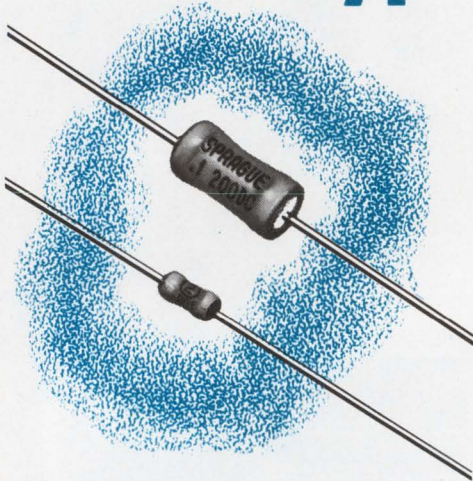

INFORMATION RETRIEVAL NO. 823

- **Low-cost** film capacitors with one-third the size of conventional tubulars
- Eight new low-capacitance values (100 pF thru 390 pF @ 200V) added to broad range of standard ratings
- Special construction—extended foil sections terminated in metal end caps, assuring positive contact with every turn of the electrodes
- End caps are also effective moisture barriers
- Entire assembly protected by special sleeve of high dielectric strength
- Request Engineering Bulletin 2066B

4SC-0105R1

Newly broadened low-cost line!

Type 196D Dipped Solid-Electrolyte Tantalex[®] Capacitors

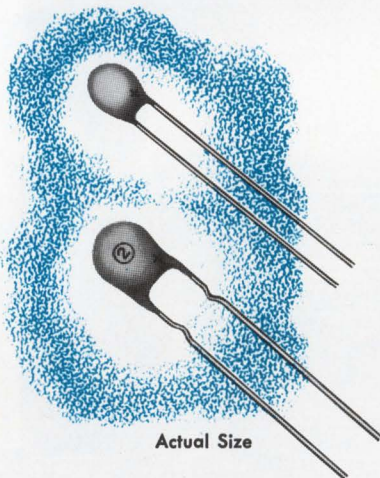

Actual Size

INFORMATION RETRIEVAL NO. 824

- Here's a capacitor design that admirably fills the need for low-cost yet dependable solid tantalum capacitors suitable for printed wiring boards
- Straight leads as well as crimped leads are readily available to meet your manufacturing needs
- Covering a broad range of capacitance values from .1 μ F to 330 μ F, with voltage ratings from 4 to 50 VDC, Type 196D Capacitors are protected by a tough insulating coating which is highly resistant to moisture and mechanical damage
- Request Engineering Bulletin 3545A.

For Engineering Bulletins as noted above, write to:
Technical Literature Service, Sprague Electric Co., 347
Marshall Street, North Adams, Massachusetts 01247.

4SC-9124R1

SPRAGUE[®]
THE MARK OF RELIABILITY

'Sprague' and '®' are registered trademarks of the Sprague Electric Co.

THE BROAD-LINE PRODUCER OF ELECTRONIC PARTS

Highlighting

THE ISSUE

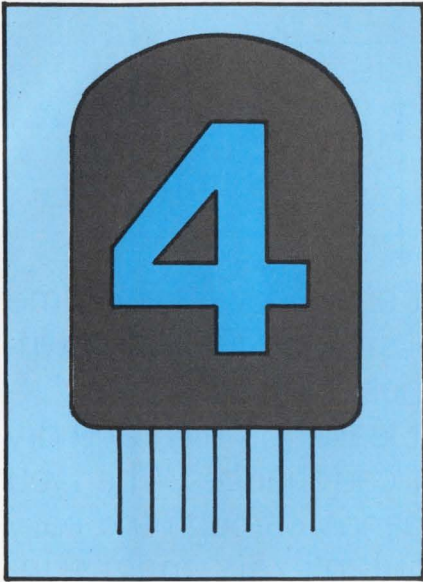

At first glance, it may appear that all the IC decoder/drivers being sold today for gas-filled cold cathode indicator tubes are designed to accept binary-coded decimal (BCD) inputs only. But with a little juggling of wires, these integrated circuits become useful for displaying decimal numbers in practically every popular code.

Page 74

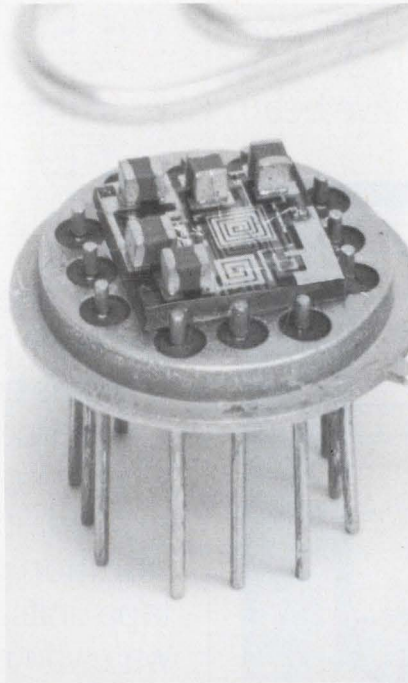

Offering a frequency range of 5 to 500 MHz, the MICamp line of thin-film vhf/uhf amplifiers, in TO-8 transistor cans, features a minimum gain of 9 or 14 dB. In addition, these wideband rf amplifiers can be cascaded to achieve flat gains as high as 56 dB, with good matching between individual units and no sacrifice in bandwidth.

When developing rf amplifiers, equipment designers can now employ the same time and cost-saving techniques that are used at low frequencies when designing with operational amplifiers.

Page 129

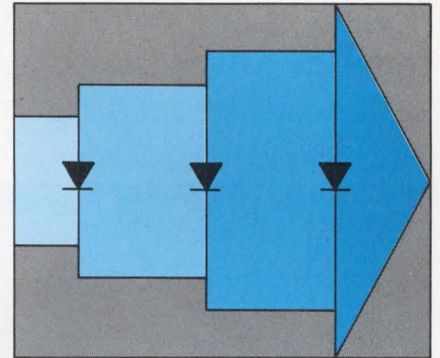

A new distributed-isolator technique for building high-power, solid-state microwave amplifiers was described at the 1970 International Microwave Symposium in Newport Beach, Calif. It provides high power over a broad bandwidth by combining the outputs of many low-power devices in a traveling-wave structure.

Construction of a true elliptic-function filter in waveguide was announced at the same conference, as well as a new, compact TEM (transverse electromagnetic) elliptic-function filter structure.

Page 25

Why Ragen Semiconductor tests C/MOS with a Teradyne J259

When you're testing complementary-MOS devices with two or three hundred transistors on a chip, you'd better be sure of your test equipment. Ragen Semiconductor, an acknowledged leader in C/MOS, has good reason to believe in its computer-operated test system: With thousands of C/MOS IC's tested and shipped, returns have been virtually nil.

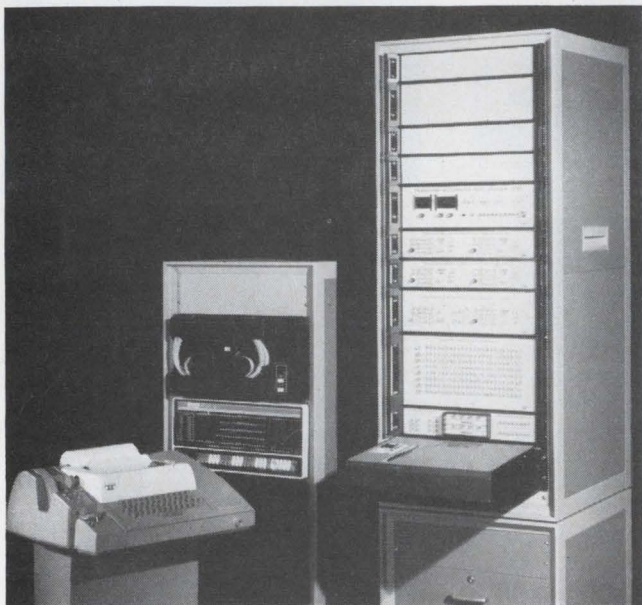

Ragen's test system? A Teradyne J259.

Ask Ragen President Al Medwin what he likes about his J259 and he may tell you that its high-impedance measurement system is perfect for the low-current measurements he has to make. Or he may tell you about the strong software Teradyne supplies with its systems. He may well mention speed because each Ragen device sees 450 parametric tests almost as soon as it's placed in the test socket.

He might also tell you some things the J259 *doesn't* do.

It doesn't force you to stop production once a week for recalibration adjustments.

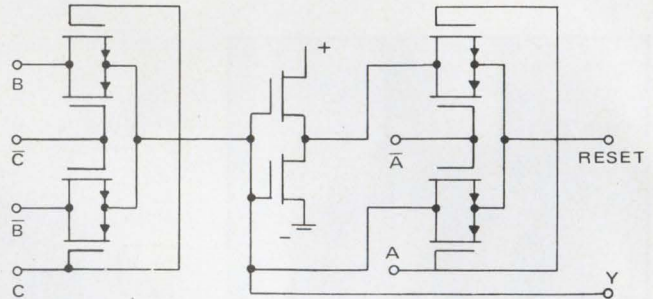

It doesn't break down every time someone insults it. Ragen's J259 downtime has been less than *one percent*.

It doesn't leave you high and dry when your test load changes. When you expand, it expands, through the easy addition of multiplexers, magnetic-tape units, line printers, and all the software you need to go with them.

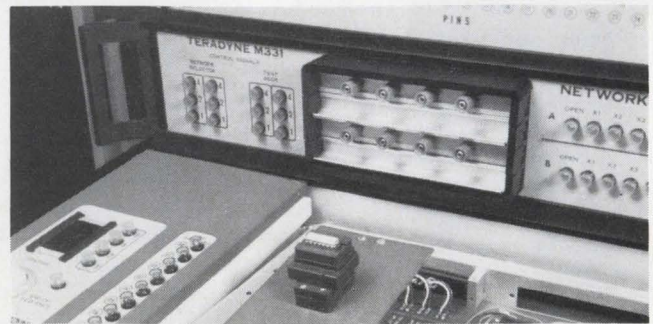

The J259 makes sense to Ragen Semiconductor. If you're in the business of testing circuits — integrated or otherwise — it makes sense to find out more about Teradyne computer-operated test systems. Just use the reader service card or write Teradyne, 183 Essex St., Boston, Mass. 02111.

Teradyne makes sense.

INFORMATION RETRIEVAL NUMBER 14

News Scope

'69 electronics profits up, sales down, survey shows

Electronics led all other industries in the country in increased profits, with a gain of 18.2% over 1968, according to *Fortune* magazine's annual directory of the 500 largest U. S. industrial corporations released last month.

The survey included 88 electronic firms—almost a threefold increase since 1963. This gain represents not only an increased share of business garnered by the giants in the industry but signaled the acquisition of young electronics firms by large conglomerates.

Computers, categorized separately by *Fortune*, placed third in increased profits, with a gain of 17.2%. Profit increases for automobiles amounted to 4.9%; for petroleum refineries, 1.5%.

The highest growth rate in sales of all companies over the past 10 years was registered by Control Data, which just nosed out Xerox by 48.42% to 48.39%.

But electronics in 1969 had its problems, too.

While Ling-Temco-Vought jumped from 25th to 14th position in the *Fortune* 500 rating, it suffered a loss of more than \$38 million.

And Lockheed—through no fault of its electronics division—piled up a \$32.6 million loss. Other money losers were Warwick Electronics and Sanders Associates—in the red \$2.8 million and \$1.9 million, respectively.

In comparing sales performance in '68 with that in '69, the trend is down: 48 electronics companies moved down in terms of sales, 37 moved up, and three stayed the same.

Projections for the rest of this year look grim. (See "Smallest Electronics Advance in Years," ED 1, Jan. 4, 1970, p. 25.) A recent marketing survey conducted by the Electronic Industries Association covering first-quarter consumer electronics show TV sales (including imports) down 21% from last year, auto radio sales down 15%. But increases of 22% and 33% were recorded for home radio and magentic tape recorders. Total unit sales of receiving tubes were down 25.1%—from 71.9 million to 53.9 million units. And corporate profits dropped \$10 billion below the high profit marks of the first two quarters of '69, according to the U. S. Dept. of Commerce.

Company	Rank '69	Rank '68	Rank '63	Sales† '69
GE	4	4	4	8.4
IBM	5	6	18	7.1
ITT	9	11	31	5.4
Western Electric	11	12	9	4.8
Ling-Temco-Vought	14	25	Na*	3.7
Westinghouse	17	17	16	3.5
GT&E	19	21	29	3.2
RCA	21	20	24	3.1
Union Carbide	24	26	Na	2.9
North American Rockwell	30	29	Na	2.6

* Ranking not available
† \$ million

New holographic system foils credit-card frauds

A new holographic method of safeguarding credit cards against fraudulent use—estimated to cost between \$100 million and \$200 million annually—has been developed by Optronics, International, Inc., Chelmsford, Mass. It is accomplished by a coded hologram embedded in one corner of the card. The hologram, about 3/8ths inch in diameter, contains the name, address, signature and account number of the card user; these are stored in a three dimensional image of the

original data.

Because information on decoding regular holographic images is readily available, Optronics International president George Gagliuso points out that it is necessary to further encode the data. The company's system, he claims, is unique and foolproof since the encoding or image-scrambling is done with a statistical random code developed and applied by purely optical means, in contrast to similar systems proposed using computer-generated patterns.

The coded hologram is read by a briefcase-sized unit that is stationed at department stores, hotels or other locations to be protected. The card is inserted in one side of the reader, and the decoded image is viewed on a circular screen using a small, helium-neon c-w laser.

When produced in quantities, the reader is expected to sell for less than \$500. It is claimed that adding the hologram to the film card will add less than 2 cents to present fabrication costs per card.

Display conference sees need for more color

One of the trends we can expect in future electronic displays is the increased use of color. This was the conclusion of experts at last month's Society for Information Display Symposium in New York City.

According to Peter Seats, president of Thomas Electronics, Wayne, N. J., the color CRT technique getting the most attention right now is beam penetration. This involves the use of a double-layered or powdered-phosphor screen where electrons strike the first phosphor to produce green or the second to produce red.

At the present time less than 1% of the 100,000 display terminals produced this year use color, according to Murray L. Kesselman, chief engineer at Rome Air Development Center, Rome, N. Y.

"But," says Fillippo B. Galluppi, president of Venus Scientific Inc., Farmingdale, N. Y., "the use of the beam penetration tube in color displays will be materially enhanced by the availability of switching power-supply hardware recently developed for the industry."

News Scope

CONTINUED

A consensus of the panel discussing displays agreed that 25% of the terminals now in use could benefit from color. This need was highlighted by E. N. Storrs of the Federal Aviation Administration who spoke of the advantages of color-coding information on the consoles used by air traffic controllers.

However, there was no clear agreement on whether matrix displays would take over the functions of CRTs. According to Sol Sherr, chairman of the conference, the justification for going to matrix displays was to get something cheaper. "Not long ago," he said, "alphanumeric CRTs cost \$15,000 to \$20,000; now they sell for \$2000 to \$3000."

Burroughs' experimental 256-character Self-Scan (plasma) display may be the beginning of a move toward matrix displays, but much depends on application.

John W. Klotz, marketing manager for Owens-Illinois, Cleveland, Ohio, was cautious about predicting the future of panel displays, such as the company's Digivue terminal. He was unwilling to predict when that product will be marketed or what the market will be. Observers, however, say that a Digivue pre-production line is being set up now and that units with 4-inch screens will be forthcoming later this year.

New field-programmable ROM slated for debut

Evaluation units of a novel 16-bit field programmable read-only memory (ROM) will be introduced later this summer by Solid State Scientific, Inc., of Montgomeryville, Pa. Several important differences are claimed by the company between this and other recently announced field-programmable ROMs. (See "Read-only 512-bit Memory Programs Electronically," ED 10, May 10, 1970, p. 130.)

The unit will be complementary MOS and fully compatible with

TTL. User programming will be accomplished by driving current through a fuze-type link associated with each bit. However, unlike other field-programmable ROMs, in which the fuzible link (usually Nichrome) vaporizes to form an open circuit, the links in the new memory will merely change from conductive to nonconductive. No vaporizing occurs, with its possible harmful effects, according to Richard Moyer, president and general manager of Solid State Scientific.

Programming current for the memory is the lowest yet reported—5 to 10 mA—with the current supplied by devices on the chip itself.

World stock quotations offered in real time

A real-time global data network put into operation this month offers brokers up-to-the-minute information on 9500 stocks, bonds and commodities traded on the world's major exchanges.

Operated by Ultronic Systems Corp., a division of General Telephone and Electronics Corp., and by Reuters International News Agency, the communications system spans 100,000 miles. A data base covering all of the listed securities and commodities is maintained by Ultronic at a new center in Mount Holly, N. J. The information is updated continually in real time by a Univac computer.

In connection with the opening of the computer center, Ultronic also announced a new CRT terminal, the Videomaster II. Twelve pieces of information on each security or commodity are displayed on a subscriber's Videomaster when he types in an identifying symbol. Among the data: current price, high and low, bid and asked, dividends, earnings and price-to-earnings ratio.

Brokerage offices can use the communication link both to receive ticker information and to transmit buy and sell orders. If the office has its own computer facility and data base, the Ultronic system with the Videomaster terminal can maintain and display the records of individual customers. Provisions can also be made for hard-copy of all transactions.

U. S. sales at Mesucora exceed \$100,000 mark

Thirty-nine U. S. exhibitors at the Mesucora automation show in Paris—primarily instrument and computer manufacturers—sold more than \$100,000 worth of equipment directly from their booths, the U. S. Dept. of Commerce reports. And they project sales over the next year in excess of \$4-million as a result of contacts made at Mesucora. Of this figure, roughly \$2-million will go to computer hardware and software companies.

Bruce Strong, director of business relations for the U. S. exhibits, reports that nine of the U. S. companies were new to the French market and were seeking representatives in France. All were negotiating or had concluded agreements for representation by French companies at the end of the show earlier this month.

Strong notes that over 200 European engineers registered at the U. S. exhibit area—an increase of roughly 20% over attendance at the last Mesucora show in 1967. Mesucora, so named for its exhibits of measuring control, regulation and automation equipment, was attended by an estimated 120,000 engineers and businessmen.

AF air-control network almost ready to travel

Back in 1964, the first equipment to build a 407L tactical air control system that could travel to trouble spots around the world arrived at the Tactical Air Warfare Center at Eglin Air Force Base in Florida. This September the last item is due to arrive.

The 407L is a big, modular, sophisticated electronic network of radars, consoles, computers and communications that can be set up in inflatable shelters in a matter of hours. It provides all the equipment needed to fight an air war.

Production of four more complete 407L systems will soon begin—all to be delivered to the Tactical Air Command by 1972. The five systems will cost \$500-million, most of which will be spent over the next two years. TRW is in charge of systems integration.

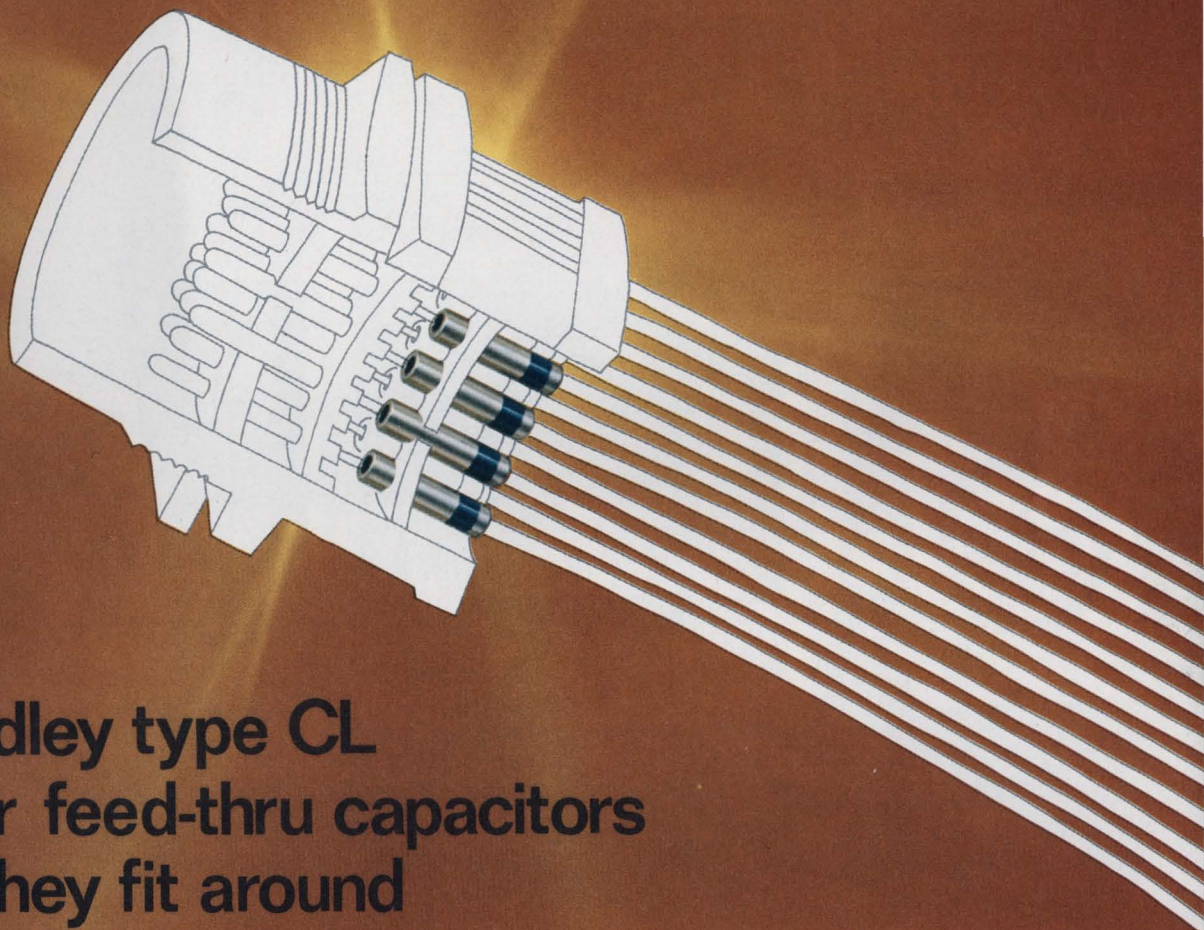

Allen-Bradley type CL multi-layer feed-thru capacitors so small they fit around the head of a pin.

VOLUMETRIC EFFICIENCY. Big words that explain why Allen-Bradley type CL feed-thru capacitors are so small. Our unique multi-layer concept shaves size to a minimum, without affecting performance. It took Allen-Bradley to get filter capacitors down to their fighting weight. Now rolled capacitors are no longer a design alternative.

Concentric layers of proprietary Allen-Bradley ceramic and noble metal electrodes are fired together for unmatched protection against moisture and contamination. Rugged. Non-polar. With lower inductance and far less noise.

Voltages to 200 WVDC. Temperatures to 125°C. Capacities to 1.0 μ F. High dielectric strength and reliability.

Several styles and sizes are available through your appointed A-B industrial electronic distributors. For further information write: Marketing Department, Electronics Division, Allen-Bradley Co., 1201 South Second Street, Milwaukee,

Wisconsin 53204. Export office: 1293 Broad Street, Bloomfield, N.J. 07003 U.S.A. In Canada: Allen-Bradley Canada Ltd., 135 Dundas St., Galt, Ontario.

ALLEN-BRADLEY

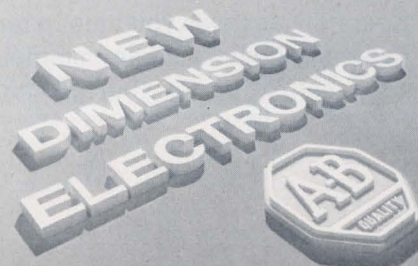

The beauty of this connector...



it saves you a pretty penny.

Sure, Amphenol's new Excellite audio/electronic connector is beautiful. It's strong and light weight, too. Made from the same tough, molded ABS plastic used in pro football helmets and golf club heads. The lustrous nickel plating enhances the look and value of your product.

But where it really sparkles is on the money it saves you. First off, it cost less to buy. The savings from new, lower cost materials is passed on to you. Secondly, it saves you time in termination. Excellite cable connectors come completely assembled, not as a bag of parts. Your production people aren't

burdened with assembly or bothered with parts that don't fit or are missing. We do all that.

The Excellite line provides a full complement of distinctive 3, 4 and 5 contact connectors that are completely interchangeable and intermateable with all latch-lock type audio connectors.

For complete information on Excellite audio/electronic connectors, send for your free copy of Catalog EX-1. Amphenol Industrial Division, The Bunker-Ramo Corporation, 1830 South 54th Avenue, Chicago, Illinois 60650.



AMPHENOL
THE BUNKER-RAMO CORPORATION

At the International Microwave Symposium

New isolator boosts solid-state power

Michael J. Riezenman
Microwaves Editor

A new distributed-isolator technique for building high-power, solid-state microwave amplifiers was described at the 1970 International Microwave Symposium in Newport Beach, Calif. It provides high power over a broad bandwidth by combining the outputs of many low-power devices in a traveling-wave structure.

The main innovation is the use of a distributed isolator in the traveling-wave structure to attenuate the backward scattered wave while permitting the forward traveling wave to propagate with little loss (Fig. 1). This allows stable amplification.

The technique, which is being explored in part under an Army contract, was described by Marion E. Hines, vice president and technical director of the engineering group at Microwave Associates, Burlington, Mass.

The active devices used—negative-resistance diodes, for example—are lightly coupled to the traveling wave. Thus each one only “sees” a fraction of the total energy. In this way very high powers can be generated with low-power devices.

The deliberate mismatch between the active devices and the traveling wave leads to both forward and reverse scattering. It is the function of the isolator to attenuate the backward wave and thus prevent instability (oscillation).

How the isolator works

The distributed isolator exploits a principle of nonreciprocal wave propagation that leads to what Hines calls an edge-guided wave. In his words: “In a microstrip line of significant width, on a ferrite slab magnetized perpendicular to the ground plane, the dominant mode may exhibit an exponential variation of field quantities in the

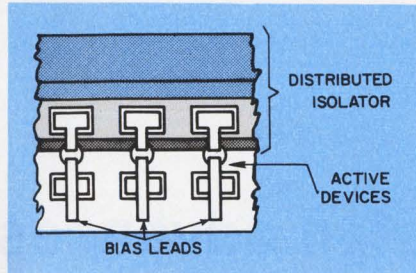

1. The high reverse loss of the distributed isolator attenuates the waves reflected by the active devices, while the low forward loss lets the transmitted waves through.

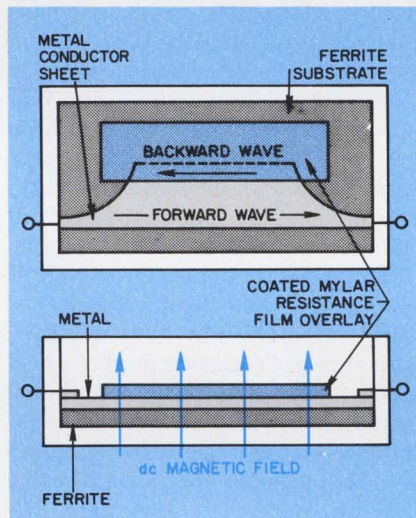

2. The resistive film attenuates the reverse wave which is concentrated on the edge that it overlaps. The taper sections match the wide section to a standard 50-ohm line.

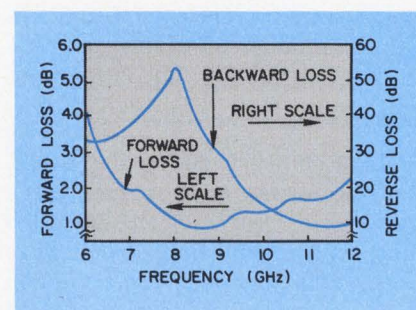

3. Reverse losses in excess of 25 dB and forward losses below 2 dB are obtained over more than 2 GHz with a 1-inch distributed isolator.

direction transverse to the edge.”

In other words, the wave energy is concentrated near one edge of the strip conductor. “The wave is guided by and along the edge,” Hines says.

Reverse waves travel along the opposite edge. Thus if a lossy resistive film is applied to the edge on which the reverse wave is concentrated, reverse loss is obtained (Fig. 2). If the magnetic biasing field is reversed, the edges are then reversed for each direction of wave propagation.

In his experimental work, Hines built a circuit like that of Fig. 2 on a ferrite substrate $0.5 \times 1.0 \times 0.025$ inches. Its forward and reverse losses, as functions of frequency are shown in Fig. 3.

When combined with three Impatt diodes (as in Fig. 1), the circuit provides about 4 dB of gain from 8.5 GHz to 9.5 GHz at an input power level of 500 mW. With only 10 mW input, the bandwidth shrinks considerably, but the gain goes up to about 16 dB. The reverse loss is between 25 and 30 dB from about 8.3 to 9.7 GHz, independent of power level.

‘Continuous diode’ suggested

“Ideally,” Hines points out, “a ‘continuous diode’ would be most desirable, but a closely spaced sequence of small diodes is quite suitable.”

An example of the sort of continuous diode to which Hines refers is the traveling-wave Impatt diode described by T. A. Midford and H. C. Bowers.¹ According to Dr. Midford, senior staff engineer at Hughes Aircraft Co.’s Electron Dynamics Div., Torrance, Calif., a major problem with the traveling-wave diode is stabilization. He thinks that a combination of the distributed diode and the distributed isolator is, therefore, a very promising idea.

In present work with discrete diodes, however, Midford is using

(symposium, continued)

a periodically loaded line structure. This structure, which consists of a series of coupled cavities in a waveguide, behaves as a bandpass filter. A negative-resistance diode is placed in each cavity. By properly adjusting the cavity coupling and the source and load impedances, Midford explains, one can make the backward wave very small

without resorting to the use of a distributed isolator.

In his experimental work thus far, which is being done for the Air Force, Midford has obtained about 1 W of output power at X-band. He had bandwidths of about 10% (1 GHz) and gain of from 5 to 10 dB.

Both Hines and Midford's research efforts are in rather early stages. Substantially better results are certain to come, they believe.

While Hines doesn't believe that his new approach is going to permit the replacement of microwave tubes by solid-state devices in the multi-kilowatt power leagues, he does feel that cw power levels of 10 to 20 W and pulse levels of 50 to 200 W can reasonably be expected. ■■

Reference:

1. T. A. Midford and H. C. Bowers, "A Two-Port IMPATT Diode Traveling Wave Amplifier," *Proc. IEEE*, Oct. 1968, pp 1724-1725.

Elliptic-filter design advances in two areas

David N. Kaye
West Coast Editor

Construction of a true elliptic-function filter in waveguide was announced at the International Microwave Symposium.

A new, compact TEM (transverse electromagnetic) elliptic-function microwave filter structure was also described at the conference.

Interest in elliptic-function filters was high. This is because they yield low midband loss, very high

selectivity and known out-of-band response in a compact package.

Dr. Albert E. Williams, a research scientist at Comsat Laboratories in Clarksburg, Md., reported the waveguide achievement. He built a four-cavity bandpass structure, centered at 3.98 GHz, with a 24-MHz, 0.05-dB bandwidth. The passband ripple was 0.05 dB. Williams reported that "an insertion loss of 0.2 dB compares favorably with the 0.24 dB minimum theoretical value of attenuation which could be expected for a four-rectangular-cavity Chebyshev filter having the same bandwidth."

Synthesis of the filter requires four directly coupled circular waveguide cavities, with additional coupling provided between the first and the last cavities (Fig. 1). Electric field polarization in consecutive cavities must be such that the circular H_{111} mode polarization in cavity $n+1$ is orthogonal to the circular H_{111} mode polarization in cavity n , where $n=1, 3, 5 \dots$. Each pair of cavities has a screw for coupling adjustment. Adjacent pairs of cavities are iris-coupled. This structure lends itself to filters of any number of cavity pairs.

been the desire to minimize size and midband insertion loss while increasing the slope of the skirt response, to gain additional selectivity with fewer resonators than are required by more conventional filter functions. The tradeoff that the filter designer must make when designing elliptic function filters is that of reduced out-of-band rejection. However, on the plus side, the out-of-band rejection is known and can be easily calculated.

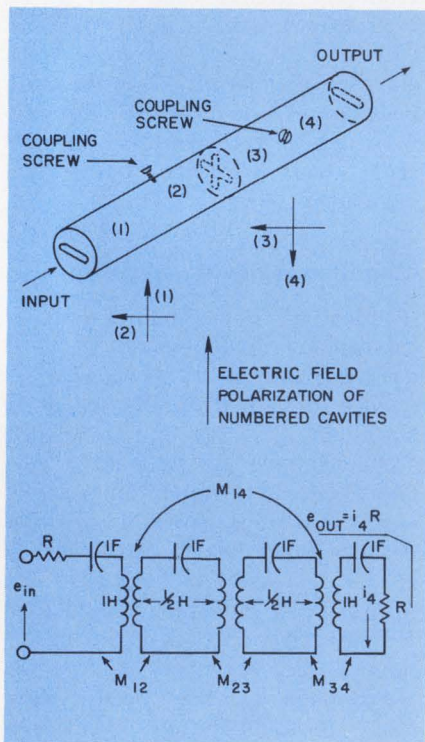

1. Waveguide elliptic-function filter structure has two pairs of screw-coupled cavities that are iris-coupled to each other. The equivalent circuit shows mutual coupling of the input and output cavities.

Many shapes possible

TEM elliptic-function filter structures can take many shapes. They have been built in strip line, slab line and coaxial line. They have used quarter-wave transmission line resonators, helical resonators and dielectric resonators, as well as other types of structures.

In each case the incentive for investigating new structures has

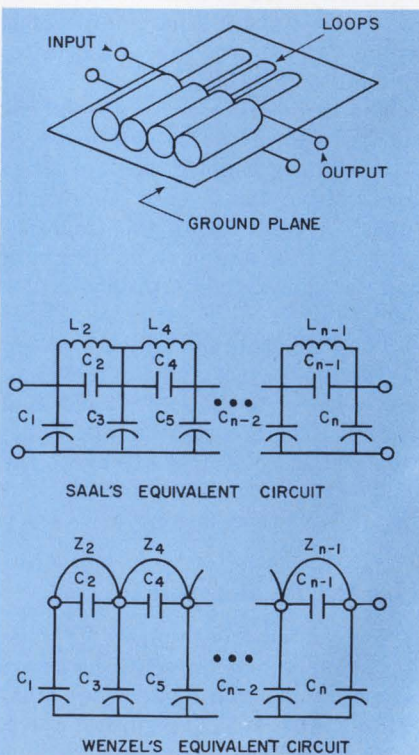

2. Coupled bars and wire loops between a pair of ground planes are the main elements of this compact elliptic-function filter design by R. Wenzel. The equivalent circuit is similar to the classic version by R. Saal.

**TI's quiet
revolution in
optoelectronics**

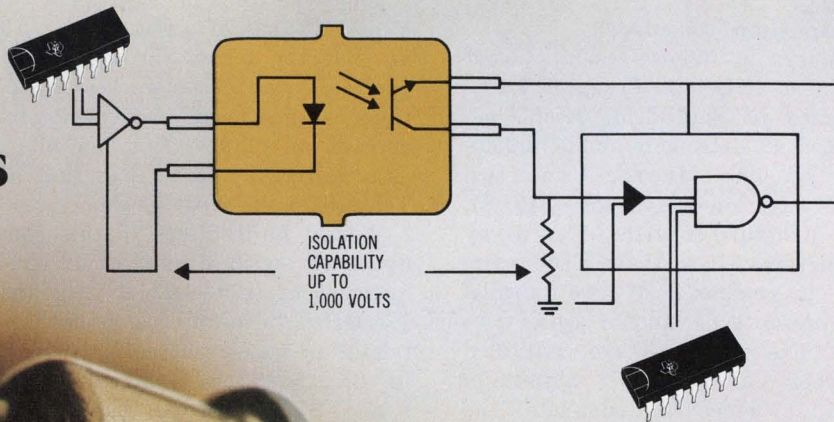

Optically-coupled isolators deliver four interface freedoms.

Freedom from noise.

Electrical isolation of the input diode and output transistor eliminates ground loops and noise signal transmission.

Freedom from voltage isolation problems.

Input/output isolation of up to 1000 volts allows for the simple interface of different voltage levels and suppresses high voltage transients.

Freedom from the cost and design problems of interfacing.

TI optically-coupled isolators (OCIs) handle the job alone. You don't need complex circuits to pass noise-free signals between input

terminals and computers and along transmission lines.

Plus, you get these important advantages over relays and pulse transformers: Response from dc to 100 kHz. High shock and vibration immunity. Bounceless action. Speeds to 5 μ sec. Wide operating temperature range. Longer life.

Freedom from space limitations.

In a tight spot? TI OCIs fit into high density situations with ease. The twin TO-18 metal can measures just 0.206" x 0.220" diameter.



And, performance is improved, too.

A more efficient emitter guaran-

tees you a 1.6 mA output for a 15 mA input. Enough to drive logic gates without additional components. Example: the TIL 107 and TIL 108 OCIs guarantee direct DTL/TTL compatibility. You cut space, weight, power and overall system costs.

Both are available now at new lower prices: TIL 107—\$6; TIL 108—\$10 (100-999). Call your TI sales office or authorized TI distributor for fast delivery.

For a data sheet, write Texas Instruments Incorporated, PO Box 5012, MS 308, Dallas, Texas 75222. Or circle number 193.



TEXAS INSTRUMENTS
INCORPORATED

NEWS

(symposium, continued)

Robert J. Wenzel, senior staff engineer at Bendix Research Laboratories in Southfield, Mich., described an extremely small realization of an elliptic-function microwave low-pass filter (Fig. 2). The structure consists of an array of microwave c-sections. Each c-section is composed of two parallel aluminum rods and a thin wire loop. The c-sections are contained between a pair of aluminum ground planes to complete the structure.

The c-section is equivalent to a pi network of capacitors, with an inductor across the middle capacitor. A ladder network of c-sections is the classic equivalent circuit of an elliptic function filter, as conceived by R. Saal in 1961 at Telefunken in West Germany.

Wenzel built filters in this configuration with design cutoff frequencies of 0.75 GHz, 1 GHz and 1.5 GHz. "Minimum stopband attenuation was greater than 50 dB in all cases," he reported. "Passband VSWR was less than 1.50:1, and dissipation loss was less than

0.20 dB—and typically less than 0.15 dB."

Wenzel noted that this physical structure had remarkable resistance to variations in temperature, shock and vibration. In addition, he pointed out, "the scalability of the design should make it very attractive for achieving a wide range of cutoff frequencies with a limited number of standard parts."

Wenzel's filters each occupied a volume of about 0.5 cubic inches. He noted that they could have been made even smaller with an optimum design. ■■

Display converts for radar or computer use

Rome Air Development Center, Rome, N. Y., has acquired a display device with a difference: this one can be used as a radar scope or a computer terminal. Modular construction is the secret that allows conversion as the application demands. (See News Scope, ED 12, June 7, 1970, p. 22.)

The display was built by the Government Electronics Div. of Motorola, Inc., Scottsdale, Ariz., under contract to the Air Force, but it was designed for tri-service use. Its official designation is Tactical Modular Display AN/USA-26(v)2

or Tacmod for short.

As a radar PPI (plan position indicator) scope it can display target velocity vectors, range and elevation. Bearing information can be obtained from a cursor and sweep whose origins can be offset in X and Y directions.

In the data-management mode, Tacmod operates with a computer to display alphanumeric text or vector-generated graphics. The alphanumerics can be arrayed in 35 lines of 64 characters or as text packets attached to a graphic display.

A 16-inch CRT provides the visual output. Circuit cards containing ICs are mounted around the tube. The entire device occupies

less than a 20-inch cube. The unit's weight is under 100 pounds and power consumption, which depends on the mode of use, ranges up to 400 W.

Solid-state components and careful design provide high reliability—a mean time between failures in excess of 1000 hours. The modular approach to the design allows Tacmod to be changed from one mode to another by replacing circuit cards and front panel components. This reconfiguration is not intended as a field operation, but it can easily be accomplished at a support base.

However, Motorola does not expect units to be interchanged between modes as a standard procedure. Rather, the modular design allows the same production line to produce displays for different applications from the same basic components. Repair and spare-parts stocking are also facilitated by the design.

While Tacmod was designed for the military services, George Walling, manager of product development for Motorola, made it clear that his company foresees nonmilitary applications for the device. He said, "We are actively trying to interest the FAA in Tacmod for use in civilian air traffic control. It is ideal for that application and it is in existence, fully proven and qualified to MIL specs."

The price for Tacmod ranges from \$30,000 to \$50,000 depending on the mode or application. ■■

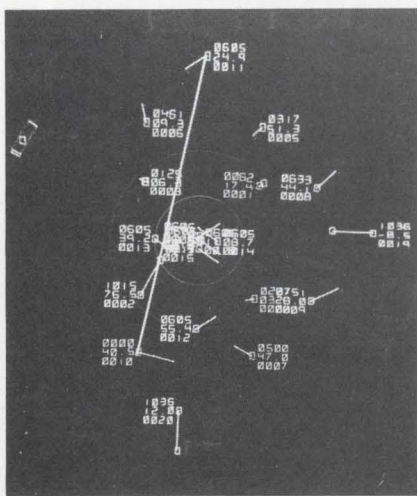

Tacmod displays vector velocity by the line length and direction at each target. The packet of numerics indicates the altitude and identity of each target. The superimposed targets at the center of this simulated display can be separated by changing the range scale.

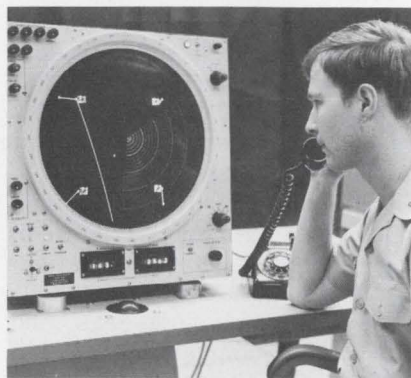

In its radar mode, Tacmod shows the range and bearing of the cursor located at the upper left target on the dials below the CRT. The offset switch in the lower left moves the cursor in X and Y, while the knob at the lower right moves it in range and azimuth.

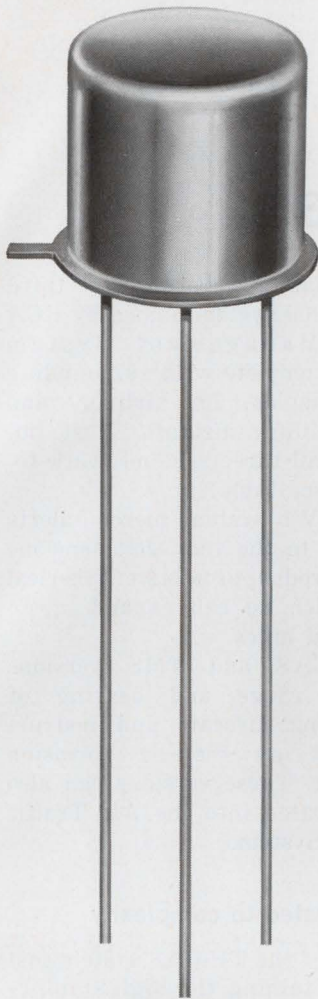

24¢

INDUSTRIAL SCR's



**Only last month
you couldn't touch
an SCR in a
metal package
for anywhere near
the price of plastic**

ID 100 Series

Anode current rating 500mA @ 100°C Case.
Voltage ratings to 200V.
200µa max gate trigger current.
Peak On-Voltage 1.7V max @ 1 Amp.
TO-18 can with 0.5" leads.

(SSPI Product Group)

Now you can

ID 200 Series

Anode current rating 1.6A @ 70°C Case.
Voltage ratings to 200V.
200µa max gate trigger current.
Peak On-Voltage 2.2V max @ 4 Amps.
TO-5 can with 0.5" leads.

(SSPI Product Group)

■ Sensing types start at 24c each in 100K lots. Comparably low prices on control types and smaller quantities.

■ Typical Unitorde quality . . . from the people who introduced the first lead-mounted SCR's 12 years and millions of SCR's ago.

■ Electrically equivalent to most widely used plastic devices.

■ Used for lamp or relay driving, sensors, pulse-generators, timing circuits, motor controls, and process controllers.

IN STOCK READY TO DELIVER NOW • SEND FOR YOUR FREE SAMPLES AND COMPLETE SPECS

For Fast Action call Pete Jenner collect . . . today!

A PRODUCT OF THE WIDE RANGING SEMICONDUCTOR TECHNOLOGY OF

UNITRODE

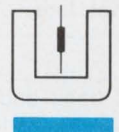

580 Pleasant St., Watertown, Massachusetts 02172 • (617) 926-0404

INFORMATION RETRIEVAL NUMBER 18

An anticollision system for all planes

Jim McDermott
East Coast Editor

A unique anticollision system for aircraft—Secant, by RCA—promises to give the current contender for adoption by the Air Transport Association a run for the money. The top contender at present is the Time-Frequency Collision Avoidance System (TF-CAS), which has already been test flown by the association. About all that the new system has in common with it is that both are cooperative. But Secant is simpler in design and has lower stability and power requirements.

Secant—for Separation Control of Aircraft by Nonsynchronous Techniques—is completed in the preliminary design phase by RCA

at Moorestown, N.J. The company is at present preparing a proposal requesting the Federal Aviation Administration's support in the development of operational testing of a complete system.

Fundamentally, all Secant-equipped aircraft within range of one another exchange random sequences of 100 1- μ s pulses in the 1592.5-to-1622.5 MHz band. By comparing the signals received against those sent, the system indicates when a collision threatens.

There are three versions of the system, varying in complexity. The first is a \$500-\$1000 pilot-warning indicator (PWI) for small, single-engine aircraft. The second is a more complex \$30,000 collision-avoidance system (CAS) for larger general aviation and small

commercial transports. The third is a \$50,000 system named by RCA Traffic Management System (TMS), complete with surrounding traffic display, for airliners and large military aircraft. Most important, all three systems work together (see table).

The PWI system merely alerts the pilot to the fact that someone has entered a protective spherical zone which he can expand up to 5 nautical miles.

The CAS and TMS versions measure range and bearing of threatening aircraft and instruct the pilot on the best evasion maneuver. These versions can also be integrated into the Air Traffic Control System.

Costs related to complexity

Much of the TF-CAS system cost lies in obtaining the high stability of a common national system time base that requires synchronization of all participating aircraft within 0.1 μ s and to a frequency precision of 1 part in 10^8 .

In contrast, the Secant system has a frequency stability of only one part in 10^6 , which is relatively easy to obtain in design. And power requirements are nominal: 2 W peak for the low-cost version and 4 W peak for the higher-cost systems, plus an 8-W air-to-ground data link. But most important, Secant interrogates other cooperative aircraft with a 100-bit string of randomly generated, 1 μ s bursts of an rf carrier. Each burst occurs within a 1-ms time slot and the full 100-bit string takes 0.1 second. With this system, there is neither modulation nor pulse-to-pulse phase coherence, thus substantially simplifying design requirements.

Also important, the system is designed so that the 100 1- μ s returns from an interrogated aircraft (intruder) carry data—a 100-bit, random-access message. This always contains the intruder aircraft serial number and its Secant class—that is, PWI, CAS,

Characteristics of the three Secant systems

Parameters	Proximity warning indicator (PWI)	Collision avoidance system (CAS)	Traffic monitoring system (TMS)
Users	Small general aviation	Large general aviation; small commercial	Airliners; high performance military
Warning range	Adjustable to 5 nautical miles	43 sec	To suit conditions
Protection features	Detection within shield radius (up to 5 nautical miles)	Detection; direction; range, range rate	Detection; direction; range; range rate; traffic situation display
System interaction	All systems can see and be seen by each other		
Digital data links	Party line; sends only. No "hot line"	Party line and "hot line" to Air Traffic Control Center	
Data transmitted air-to-air	Intruder's serial No. plus PWI, CAS or TMS; altitude optional Own aircraft: Serial No., 'PWI	Intruder's serial No., equipment class (CAS or TMS); altitude difference; vertical rate; turn indications; wake number; other options Own aircraft: Serial No.; CAS or TMS; turn indicator; wake number; altitude; vertical rate; other options	
Air-to-ground hot line	None	Own aircraft: Serial No.; assigned ATC No.; communication frequency; altitude Intruder: Serial No.; altitude difference.	
Rf band and power (MHz)	1592.5 - 1606.0 (2W)	1592.5 - 1606 (2W) 1607 - 1608 Hot Line (8 W) 1609 - 1622.5 (4 W)	

or TMS—that are displayed in the interrogating aircraft. Other message options are available.

Random signals are used

The key to the Secant system is its random, binary signal structure in which two types of interrogating signals, or “probes” are sent out—a “P” and “Q” which correspond respectively to the heads and tails of an electronic coin.

Every aircraft carries its own electronic coin-tossing circuit. This is a noisy diode that generates Poisson-spaced shots.

The basic time unit of the Secant system is a 1-ms “slot,” and each aircraft has its own random slots. Somewhere, within each slot, the electronic coin sends out a P or Q. Its position in the slot is purely random. Also important, the Ps and Qs are sent in “frames” of 100 1- μ s bursts of rf carriers, at a P or Q frequency.

As the receiver in the intruder’s plane receives the random string of 100 probes, it retransmits each type of probe exactly as received—P for P and Q for Q. Along with the 100 retransmissions, the intruder adds the 100-bit message. The polarity of each message bit is determined from the frequency at which it is transmitted.

To find which replies represent a potential collision, the basic 1-ms period of the interrogating aircraft is divided into 1000 1- μ s cells or bins into which are entered the successive estimates of the binary value of an incoming bit. Each cell represents 500 feet of range.

In an operating cycle, 100 interrogation pulses are sent out during the first 100 ms of a 0.1-second frame, and the Secant processor then searches the bins for replies. At the range bin closest to the interrogating plane that contains a number of hits exceeding a given threshold (which discriminates against fruit and noise), a tracking circuit takes over to follow the target for 0.5 second, determining from the track the range-closing rate and time-to-collision.

If the latter is less than 43 seconds, an alert is signaled to the pilot, and the target is checked again for both time-to-collision and altitude. ■■

LINEAR AMPLIFICATION OF LOW LEVEL SIGNALS

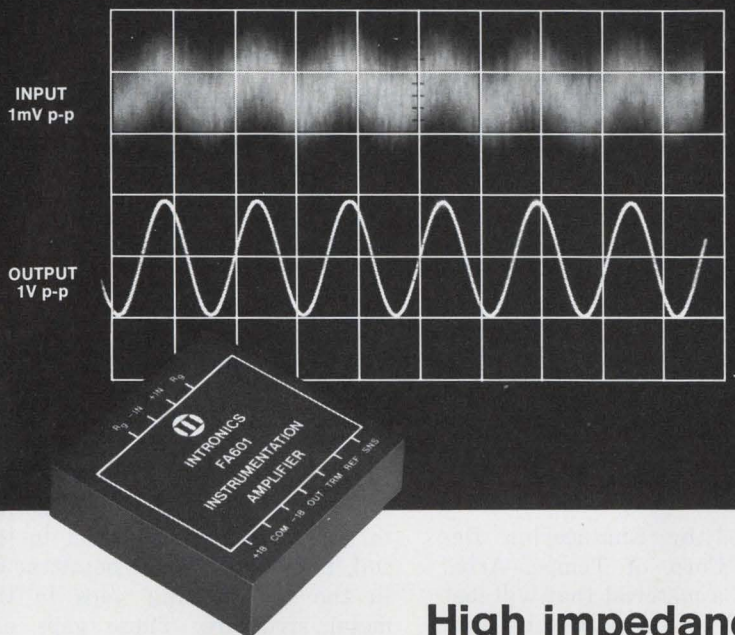

High impedance ($10^{11}\Omega$) FET differential input Adjustable gain of 1 to 1000

Intronics’ model FA601 instrumentation amplifier is the optimum selection for transducer applications requiring precision, small size, and economy. Featuring a FET differential input with a high impedance of $10^{11}\Omega$, the FA601 offers programmable gains of 1 to 1000 independent of the input circuit by means of a single resistor, a low input current of 100 pA, and a large unity gain bandwidth of 1 MHz. Special attention has been made to minimize noise generated by the input stage.

The combination of high input impedance, a high CMRR of 86 dB, and low noise make the FA601 ideally suited to:

- biological probes — thermocouples — strain gages
- current sensing
- servo amplifiers
- multiplexer buffering

The FA601’s modular package, 2 x 2 x .625 inches, and light weight, 2½ oz., allows convenient location near low level signal sources thereby eliminating cable noise and unwanted signals. The unit operates from ± 15 to ± 18 volt supplies and is easily connected to etched circuit boards or plugged into a mating socket. Price (1-9): \$65.

For technical data or applications assistance on model FA601 or Intronics’ broad line of specialized analog products write or call Intronics, 57 Chapel Street, Newton, Mass. 02158, Tel. (617) 332-7350; TWX: 710-335-6835.

* Scope trace demonstrating rejection of common mode noise reproduced from actual Polaroid scope photo.

 **intronics**

Electronic system stops corrosion of metals

Material is allowed to corrode as a substitute for metals that are subject to electrolytic action

David N. Kaye
West Coast Editor

An automatic electronic cathodic protection system that can guard metals from corrosion in any medium but the atmosphere is on the market. The basic principle is that a material, called Duriron, is allowed to corrode as a substitute for the material that must be protected.

Developed by Engineering Development Corp. of Tempe, Ariz., Duriron is a material that will last for several years as a substitute for metals that are placed in contact with electrolytes such as water, acid, soil, gas and oil.

Robert G. Dale, president of Engineered Development, explains, "You make the material that you want to corrode [Duriron] look positive with respect to the material you want to protect. In addition, you make the material that

you want to protect negative with respect to the electrolyte surrounding it."

What is corrosion?

A good example of corrosion, Dale notes, occurs when a pipeline or metal tank is embedded in soil. In this case, the pipe-to-soil potential must be between -0.85 V and -1.5 V. If the pipe were allowed to go positive with respect to the soil, metal ions would be attracted to the soil, leaving gaps in the metal structure. These gaps are corrosion.

Cathodic protection devices have been in use for years. However, they have been expensive, and have not been totally automatic. That is, the devices have not been capable of maintaining the pipe-to-soil potential between its required limits under all conditions.

A pair of SCRs, a pair of diodes,

and some solid-state monitoring circuitry forms the heart of the automatic cathodic protection unit. A power bridge is made up of two diodes and two SCRs. The conduction angle of the SCRs is determined by the control board, which continuously monitors the potential between the pipe (protected structure) and the reference electrode (soil potential). If the pipe-to-soil potential tries to fall too low or rise too high, the control board will immediately increase or decrease, as necessary, the conduction angle of the SCRs. This keeps the pipe-to-soil potential at the required value for protection.

Inexpensive pipeline protection

For use in protecting a pipeline, one protection unit is required approximately every 15 miles. Each unit costs about \$100 to \$150 depending on quantity and use.

But, says Dale, "There is, by all competent sources, information saying that there is anywhere from \$100 million to \$14 billion lost per year because of lack of technology in attacking corrosion loss."

Installation of the automatic cathode protector is a relatively easy matter. Because of its small size—10 by 5-1/2 by 6 inches—the unit will fit almost anywhere. All electrical connections are made to a terminal block in which the wires are held tightly in place by a screw clamp. The only additional installation is that of placing the reference electrode—normally a 1-by-18-inch zinc bar—in the ground near the pipe and connecting a small wire between the reference electrode and the reference terminal of the automatic cathodic protector. For proper operation, the reference electrode must be placed outside the current flow path. If it is placed between the ground bed and the protected structure, current will never reach the pipe and it will be impossible to hold it at the proper potential. ■■

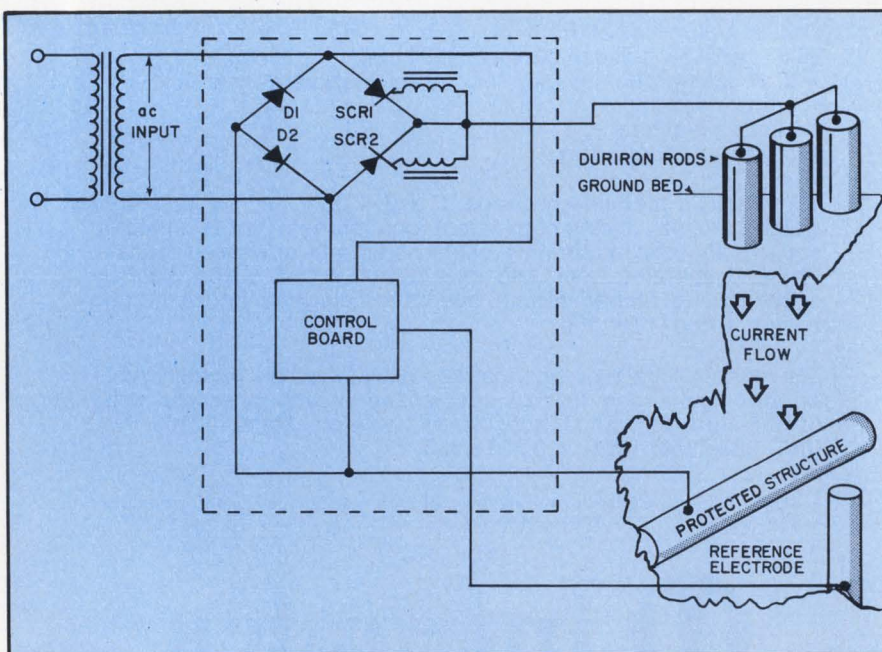

Automatic cathodic protection is accomplished by keeping the protected structure between 0.85 V and 1.5 V negative with respect to the soil. The control board monitors the pipe-to-soil potential and adjusts the conduction angle of the SCRs to maintain constant potential.

SEMICONDUCTOR NEWSBRIEFS

PUBLISHED BY MOTOROLA SEMICONDUCTOR PRODUCTS INC.

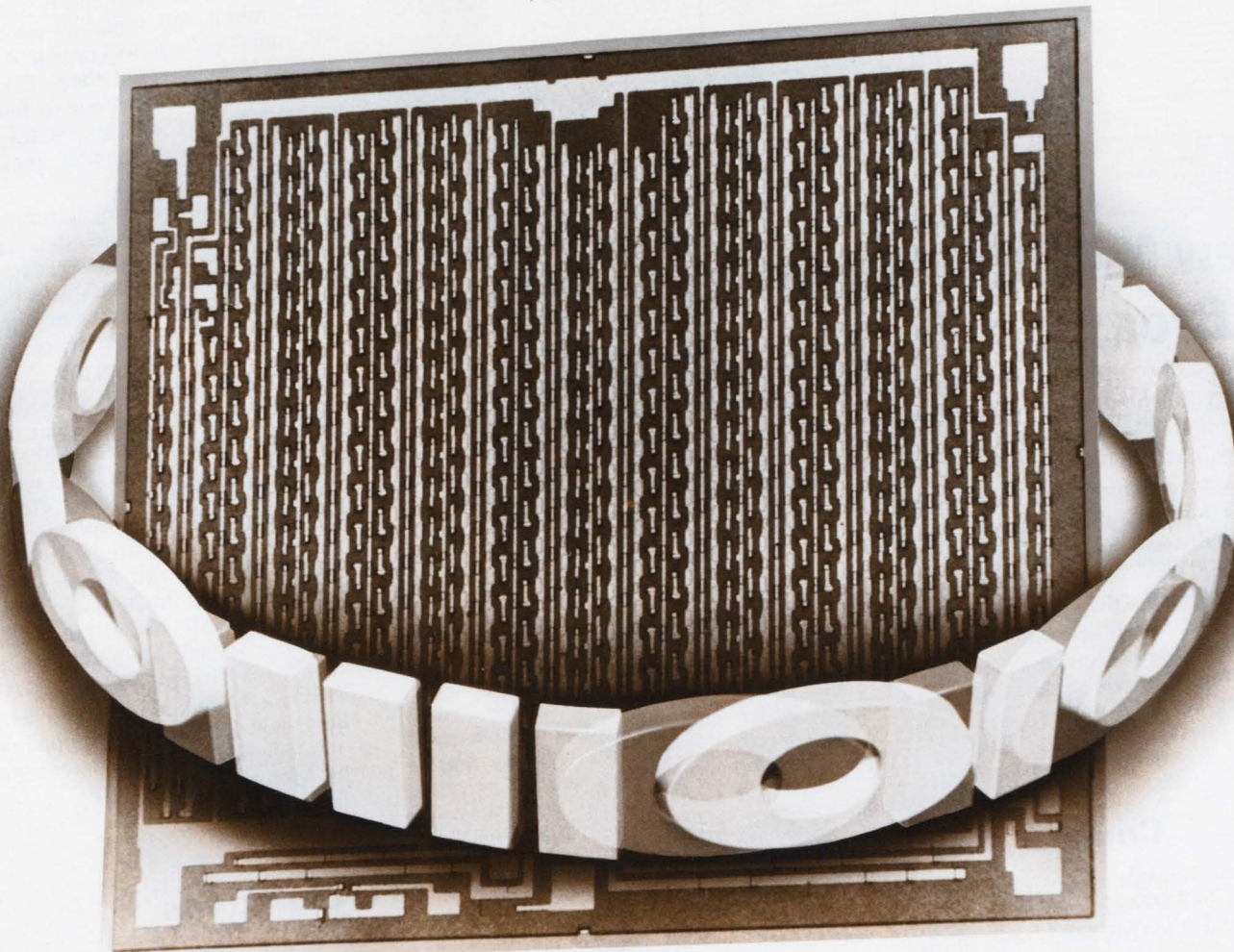

Shift A Bit For Less

Motorola presents MOS at its economical best — the new MC1142G 200-Bit Dynamic Shift Register. Cost conscious designs will benefit by the MC1142G's "under 3¢/bit" price tag (\$5.25 in 1K-up quantities) and even less for volume production requirements.

Constructed with P-channel enhancement mode devices in a single monolithic structure, the MC1142G contains a push-pull buffer for higher drive capa-

bility. The output is delayed 200 bit times from the input.

FEATURES

- 1.0 mW/Bit Power Dissipation @ 1.0 MHz
- 10 kHz to 1.0 MHz Operating Frequency Range
- Diode Protection on All Inputs
- Output Interfaces Directly With MDTL and MTTL

For details circle 221

- Specified for Single or Cascade Applications

The MC1142G is recommended for delay line memories and sequential digital applications, utilizing a two-phase clock for minimum power dissipation.

Check your local distributor today for "off-the-shelf" evaluation devices which are supplied in a compact low-profile, 8-leaded metal can. You'll find it costs less to shift a bit with Motorola's MC1142G.



SELECTION OF ONE-OF-THIRTY-TWO BITS PARALLEL IN - SERIAL OUT

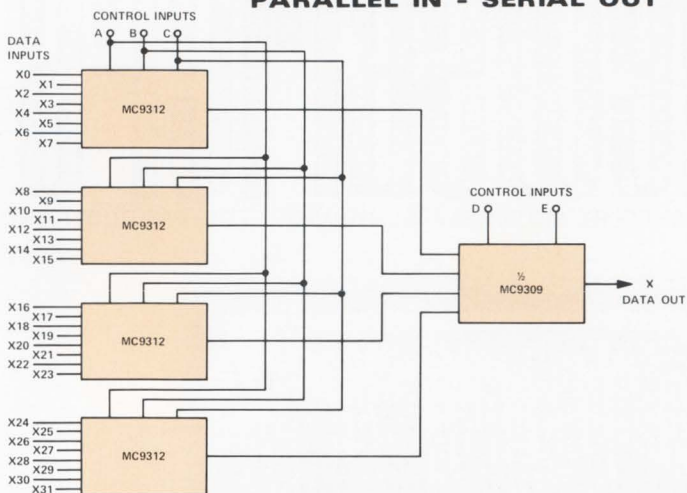

E	D	C	B	A	X
0	0	0	0	0	X0
0	0	0	0	1	X1
0	0	0	1	0	X2
0	0	0	1	1	X3
0	0	1	0	0	X4
0	0	1	0	1	X5
0	0	1	1	0	X6
0	0	1	1	1	X7
0	1	0	0	0	X8
0	1	0	0	1	X9
0	1	0	1	0	X10
0	1	0	1	1	X11

1	0	1	0	0	X20
1	0	1	0	1	X21
1	0	1	1	0	X22
1	0	1	1	1	X23
1	1	0	0	0	X24
1	1	0	0	1	X25
1	1	0	1	0	X26
1	1	0	1	1	X27
1	1	1	0	0	X28
1	1	1	0	1	X29
1	1	1	1	0	X30
1	1	1	1	1	X31

New MC9300/8300 "Compatibles" Broaden DTL/TTL Capabilities

Four new MC9300/8300 series complex functions are ready to serve as basic building blocks for systems utilizing any TTL family or DTL. The new devices are completely TTL/DTL compatible and are direct replacements (electrically and functionally) for older 9300/8300 devices.

As system building blocks, the new devices are really versatile. The MC9300/8300 4-bit universal shift register, for example, provides the shift right, shift left, serial-to-serial, parallel-to-

parallel, serial-to-parallel, and parallel-to-serial functions. And it also comes with a master reset input that sets all outputs to the logic "0" state (regardless of other input states), a parallel enable input, and J and K inputs providing full input logic capability for serial data entry.

Particularly useful for arithmetic operations (addition, subtraction, multiplication) as well as parity generation and checking, the MC9304/8304 dual full adder contains two independent, high-speed, binary full adders, and

provides complementary SUM outputs. Adder one has a CARRY output while adder two has a CARRY output plus both active high and active low inputs. This input choice offers greater flexibility and helps minimize system package count.

The MC9309/8309 dual 4-channel data selector is particularly useful for data routing and sampling applications and may be used to convert 4 bits of parallel data to serial data. The device selects data present on one of four input lines, according to logic states of the control inputs, and routes that information to the output.

Another data routing natural is the MC9312/8312 8-channel data selector which is useful for routing data from one of eight sources, such as a bank of memories, when the memory address is presented to the select inputs.

The MC9300, 9304, 9309 and 9312 (full temperature range versions) are available in the ceramic dual in-line package (L suffix). The MC8300, 8304, 8309 and 8312 (0 to +75°C devices) are supplied in both ceramic dual in-line and plastic dual in-line (P suffix) packages. 100-up prices are: MC9300L - \$13.00; MC8300L - \$6.50; MC8300P - \$5.05; MC9304L - \$15.00; MC8304L - \$7.50; MC8304P - \$5.80; MC9309L - \$10.60; MC8309L - \$5.30; MC8309P - \$4.10; MC9312L - \$10.60; MC8312L - \$5.30; MC8312P - \$4.10.

These new DTL/TTL "compatibles" are immediately available from your nearby Motorola distributor.

For details circle 222

Counter And Shift Register Join 54/74 TTL Functions

Two new versatile complex functions — the MC5492/7492 divide-by-twelve counter and the MC5495/7495 4-bit universal shift register — have been added to Motorola's expanding 54/74 TTL line.

The MC5492/7492 is designed to provide a variety of counting moduli with no external gating. Comprised of a divide-by-two section and a divide-by-six section, the sections can be used independently, or can be connected to perform the divide-by-twelve function. The device is especially useful in any application requiring a division by 12, 6, or 3 such as time or measurement recorders.

The MC5495/7495 can be used in many part reducing, performance im-

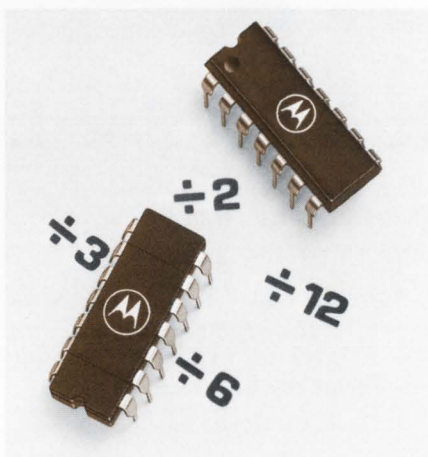

The MC5492/7492 provides four divide-by functions in one package.

For details circle 223

proving applications. The device performs as a right-shift/left-shift register, or as a parallel in/parallel out, parallel in/serial out, serial in/parallel out, serial in/serial out storage register, depending on the logic level present at the mode control input. Other applications include use as a divide-by-N counter, a programmable frequency divider, a programmable burst generator, and a 4-bit full adder and subtractor.

The devices are available in ceramic dual in-line packages (suffix L) for use over the full temperature range and both ceramic and plastic (suffix P) dual in-line packages for 0 to +75°C applications. Check your local distributor for "off-the-shelf" units. Prices (100-up) MC7492 - \$4.15; MC7495P - \$4.85.



MOS Dual Static Shift Registers Twice As Fast

Forced to build your low-power system's static registers with bipolar flip-flops because available MOS can't keep up with the system clock?

Two new MOS devices from Motorola might just be the answer — they run at 2.0 MHz, twice the usual speed of a MOS static shift register.

Both the MC1160G dual 100-bit and the MC1161G dual 50-bit registers share these outstanding features:

- Independent input/output lines for both devices in a package — plus the specs permit independent or cascade operation.
- Buffered outputs directly drive TTL.
- Common power supply and clock lines to both devices in a package.
- Diode protection on all inputs.

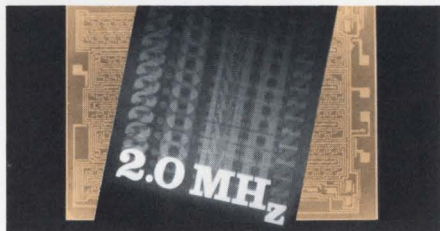

With features like these, the two registers are ideal used for delay lines or circulating data storage. And their dc operation holds your data without needing constant refreshment.

The MC1160G and MC1161G both come in a 10-pin metal can off-the-shelf for \$17.50 and \$9.00, respectively — 100-up.

For details circle 224

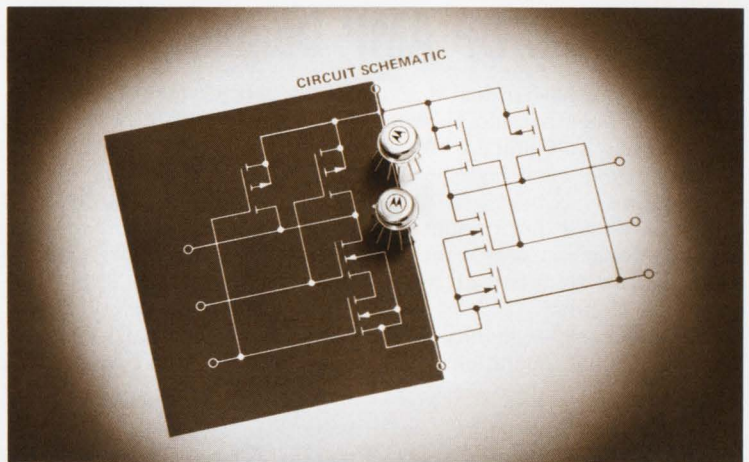

The MC2597, a typical MCMOS device, balances a miserly power consumption against a fearless 4.5 V noise immunity.

MCMOS "Power Saver" Circuits Make Debut

When your circuit requirements call for minimum power dissipation, high noise immunity, and operation over a wide variation of power supply voltages; you have a ready solution in Motorola's Complementary MOS.

Two newly available MCMOS circuits, MC2597G and MC2598G, exhibit quiescent power dissipations of 100 nW, noise immunity of 4.5V @ $V_{DD} = 10$ Vdc, and will operate over power supply ranges of 5.0 to 15 Vdc. The MC2597G is a dual 2-input NAND gate and the MC2598G is a type D flip-flop with Direct Set and Direct Reset inputs, plus complementary outputs. As such, the MC2598G can be used as a one-bit shift register element, or as a type T flip-flop for counter and toggle applications.

For details circle 225

Both devices are packaged in a compact, low profile, 10-leaded metal can. Obtain evaluation samples from your distributor at low, low 100-up prices of \$1.50 for the MC2597G and \$2.50 for MC2598G devices.

More MCMOS coming!

Shortly you'll be able to apply these additional "power savers" — the MC2501L Quad 2-input NOR gate, MC2502L Dual 4-input NOR gate, and the MC2503L Dual Type D flip-flop. All three devices feature low power dissipation (100 nW type), will operate over input voltages from 4.5V to 20 Vdc, and offer high fanouts (>50). Check with your local Motorola representative for pricing and delivery.

MTTL Complex Function Line Gains Nine New Members

Introducing nine new "cost cutting" complex functions for greater design flexibility. Leading off is the MC4002 dual data distributor, a very useful device for routing digital data from a single location to one of several registers or locations for further processing.

Where versatility is a prime consideration check the MC4023 4-Bit universal counter. It's a natural for use in frequency synthesizers, digital displays and A/D converters! You can connect the MC4023 to divide by any number between 2 and 12 (except 7 and 11). Other counters are limited in counting — so consider the MC4023's counting capa-

bility of 2, 3, 4, 5, 6, 8, 9, 10, or 12, a definite advantage — especially at 30 MHz! For additional utility, reset inputs are provided on each of the four flip-flops in the counter to allow direct setting of the Q outputs to zero any time during the counting cycle.

The MC4026/27 full adders are designed for standard serial and ripple-carry parallel adder systems while the MC4028/29/30/31 are a family of fast adders for parallel look-ahead carry adder applications where high-speed addition is required. And it's simple to build 8-stage look-ahead carry systems when you combine the fast

adders with Motorola's new MC4032 carry decoder.

TYPE NO.	FUNCTION	PRICES (100-UP)
MC4002P	Dual Data Distributor	\$ 7.05
MC4023P	4-Bit Universal Counter	5.20
MC4026F, L, P	Full Adder	4.05(F, L) / 3.45(P)
MC4326F, L		6.60
MC4027F, L, P	Full Adder	3.35(F, L) / 2.85(P)
MC4327F, L		5.10
MC4028F, L, P	Dependent-Carry Fast Adder	4.60(F, L) / 3.90(P)
MC4328F, L		7.60
MC4029F, L, P	Dependent-Carry Fast Adder	3.80(F, L) / 3.25(P)
MC4329F, L		5.80
MC4030F, L, P	Independent-Carry Fast Adder	4.60(F, L) / 3.90(P)
MC4330F, L		7.60
MC4031F, L, P	Independent-Carry Fast Adder	3.80(F, L) / 3.25(P)
MC4331F, L		5.80
MC4032F, L, P	Carry Decoder	3.20(F, L) / 2.70(P)
MC4332F, L		\$ 4.90

MC4000 Series (0 TO +75°C) F Suffix = Ceramic Flat Pack
MC4300 Series (-55 TO +125°C) L Suffix = Ceramic Dual In-Line Pkg.
P Suffix = Plastic Dual In-Line Pkg.

For details circle 226



Dual OP AMP Doubles Savings In Both Space And Cost

Suppose you have a dual design challenge . . . one that incorporates *both* limited space and limited budget — in addition to the usual high performance specifications.

Sounds almost insurmountable, particularly when you also want to utilize the standard benefits of monolithic integrated circuits!

Not any more — thanks to the new MC1558G dual operational amplifier.

Here, essentially, are two industry-standard MC1741 op amps on one chip and in one hermetic package. Yet, the cost for this dual is very little more than the cost of one MC1741.

In addition to these space-saving, money-saving virtues, the MC1558 also offers all of the high-performance benefits of the MC1741:

- Internal frequency compensation.
- Short circuit protection.

- Wide common-mode and differential voltage ranges.
- Low power consumption.
- No latch up problems.

The MC1558 and MC1458 are both available from distributor stock in the 8-pin (TO-99) metal package. 100-up pricing is:

MC1458G — \$4.00
MC1558G — \$5.00

For details circle 227

There's Only One Truly Flexible IC Regulator For Lab Power Supplies

If you need a laboratory power supply (and, who doesn't) think about this:

There's only ONE monolithic IC voltage regulator that offers a constant current source!

There's only ONE IC regulator where voltage is adjustable to zero (or, up to hundreds of volts)!

There's only ONE that provides automatic cross-over from voltage to current regulation! (See illustration).

For sheer versatility, the MC1566 is one of the most outstanding developments since the op amp. You can, for example, use the MC1566 in circuits for measuring a wide variety of circuit parameters, to perform remote sensing, or in a number of other applications.

As a power supply regulator, the MC1566 provides complete control over both voltage and current. With the MC1566 in charge, your power supply changes from constant voltage to constant current smoothly, automatically and almost instantly. And, the crossover point is pre-determined and program-

Voltage regulation of 0.01% is standard duty for the MC1566 lab quality regulator.

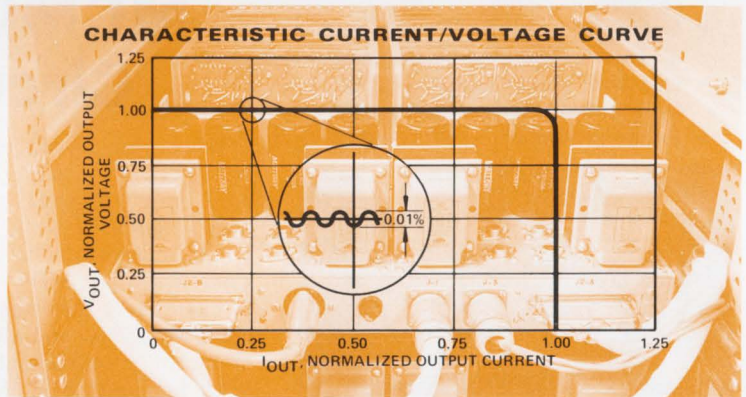

mable. In short using the MC1566, it's possible to regulate voltage from zero up to a value limited only by the breakdown voltage of the series-pass transistor at the power supply output.

As a result, you can use just one IC for all of your regulation jobs from millivolt levels to hundreds-of-volts!

Some of the outstanding specs of the MC1566 and its 0 to 75°C mate,

MC1466 are:

- Excellent Line Voltage Regulation - 0.01% +1.0 mV
- Excellent Load Voltage Regulation - 0.01% +1.0 mV
- Excellent Current Regulation - 0.01% +1.0 mV
- Short Circuit Protection

Both types are available now in the 14-pin dual in-line ceramic package.

For details circle 228

Latest MECL II Quad Latch Eliminates Display Tube Flickering

The MC1070/1270 quad latch features both clocked inputs and gated

outputs. Its applications include use as a buffer register for temporary storage

of binary information between arithmetic processing units. A complete data sheet gives information outlining a storage technique using the quad latch to eliminate display tube flickering when working at input counting rates above the response time of the display device.

The MC1070 (0 to 75°C version) is packaged in both flat pack (F suffix) and 14-lead plastic dual in-line cases (P suffix). MC1270 is supplied in a 14-lead ceramic dual in-line package (suffix L). 100-up prices are: MC1070F — \$9.50; MC1070P — \$6.50; MC1270L — \$7.70. Your local distributor has evaluation units "on the shelf."

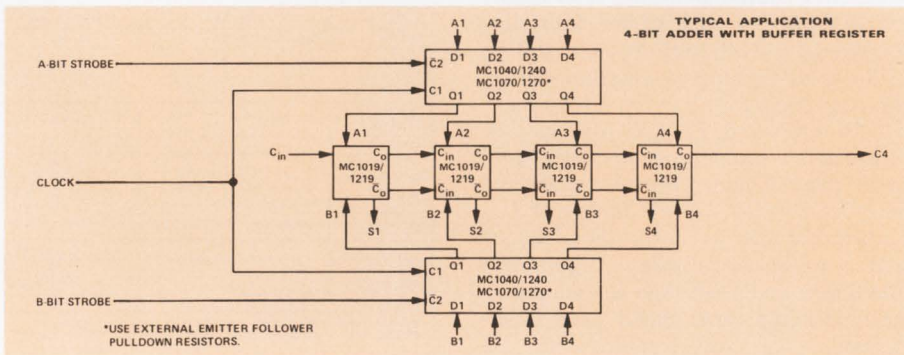

For details circle 229



Control Full-Wave Power To 6000W With MAC35/36 Triacs

The new MAC35/36 triac team of "huskies" are straining in their traces, ready to pull a full, 25 amperes (rms) load in your demanding industrial/military control job. If it's economical, stepless 60 cycle power control in motors, heaters, welding gear or switching systems you need, these rugged types will easily handle 6,000 watts (240 V) in your circuits plus provide other advantages in ac designs, like symmetrical gating and holding.

The tough performers in this team were bred specially for their task. Just look at their pedigree: a low 1.5 V (max) on-state voltage at 35 A, uniform characteristics through all-diffused junctions, 225 A peak one-cycle surge current protection, and 4 mA (max) peak blocking current at V_{DRM} .

Turn-on time is a scant 1.0 μ s, too, assuring efficient switching in all uses.

Even when cost is the prime consideration, the MAC35 series ensures optimum balance between price and continuous control performance — prices start as low as \$1.70, 100-up!

Evaluation units of the 1/2" flangeless pressfit and 9/16" stud types are available from your distributor. Send for information on your triac "husky" today and we'll mail an Application Note, AN466, "Circuit Applications For the Triac" and a data sheet that gives both average and rms current derating curves.

Series	Package	V_{DRM} Range V	$I_{T(RMS)}$ A	I_{GT} (typ) mA	I_H (typ) mA
MAC35-1 to 7	Pressfit	25 to 500	25	20	10
MAC36-1 to 7	Stud				

For details circle 230

New Plastic High Voltage Hot-Carrier Diodes Are Versatile, Rugged, And Inexpensive

MBD501 and MBD701, two new Motorola high-voltage silicon hot-carrier detector and switching diodes, offer designers outstanding qualifications as RF detectors in video and radar applications, and as ultra high-speed switches in digital logic applications.

All the typical cost advantages of Motorola's high volume plastic production capability are here, too. Low initial prices half those of competitive glass units for production run quantities, match manufacturing cost savings made possible by the package benefits. The

TO-92 configuration is ideal for use in printed circuit board applications and

UNIQUE DOUBLE GUARD RINGS ASSURE MBD501/701'S HIGH BREAKDOWN VOLTAGE

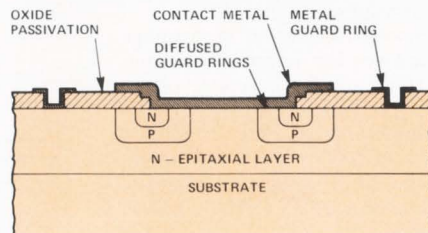

For details circle 232

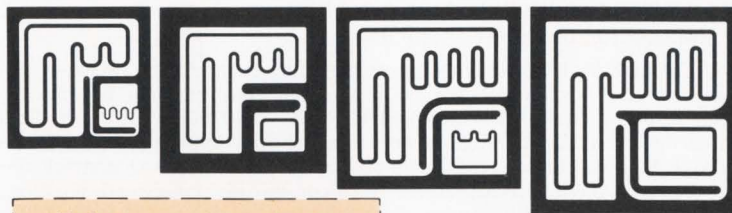

Fabricated with Motorola's Epi-base mesa process, the new MJ-900/1000 power Darlington's save circuits components.

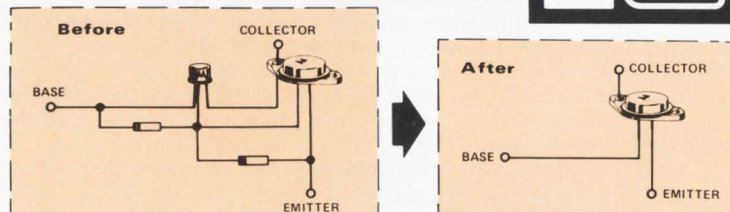

Power Darlington's Revolutionize Today's World Of Silicon Power!

Now you can up op amp power, innovate with I/C's, obtain 1,000 dc gain and compress your costs with the new, "world-of-tomorrow," 5 A silicon power Darlington transistors!

First of their kind available in the industry, the MJ900/1000 series promise to revolutionize conventional, silicon power circuits requiring separate, "one-for-one," driver and output transistors and associated emitter-base resistors.

Your power operational amplifiers, for example, such as relay or solenoid drivers, power supply regulators, servo amplifiers and series pass regulators can now be designed around one, discrete device containing driver, output and resistors — all on one chip in one TO-3 power package. You can drive the new Darlington's with power levels derived

from integrated circuit logic gates and go from milliamperes to amperes directly, compatibly, easily.

You can cut your costs substantially by having only one device to install and heat sink. Reliability too is heightened, because of the lessening of component needs and variations.

And, with both NPN and PNP types available, you can build positive and negative-based systems. Or you can use them in complementary symmetry applications.

In addition to the new MJ900/1000 metal series, Thermopad plastic types will soon be introduced offering the designer even further economies.

Introduce your circuits to today's world of silicon power Darlington systems . . . write for complete data!

Power Darlington		I_C A (Cont)	$V_{CE0(US)}$ A	I_{FE} @ I_C (min)	P_D W	I_{CBO} @ V_{CB} mA	SOA	Price 100 Up	
PNP	NPN							PNP	NPN
MJ900	MJ1000	5	60	1,000 @ 3A	90	0.2 @ 60V	3A @ 30V	\$2.90	\$2.50
MJ901	MJ1001	5	80		90			\$3.30	\$2.90

For details circle 231

lends ease to automatic insertion procedures.

The ruggedness of Motorola's void-free plastic package perfectly complements the reliable wire-bond construction of these devices to eliminate the fragility of "C" bend, "S" bend, and point contact diodes.

Key specs include low capacitance — 1.0 pF (max) @ $V_R = 20$ V — and extremely low minority carrier lifetime of 100 ps (max) @ $I_F = 5.0$ mA. $V_{(BR)}$ is 50 V for the MBD501 and 70 V for the MBD701.



NEW PRODUCT BRIEFS

HIGH POWER, P-I-N SWITCHING DIODES

— Enhance Phased Array Radar Designs

The high peak and average power handling capability of two new Motorola high-voltage P-I-N diodes provides a potential boost in range for phased array radar systems. These MPN3208 and MPN3209 800/900 Volt P-I-N diodes are primarily intended for high-power phase-shifter applications at frequencies through S-band, but are readily adaptable to other RF power control jobs, too.

Because these devices utilize a silicon-dioxide passivated junction, they exhibit excellent stability and a very low reverse leakage of only 100 nA @ $V_R = 500$ V. Thermal resistance is also low at just 4.0°C/W (max).

Their low forward series resistance of 0.4Ω (max) @ $I_F = 150$ nA is a significant factor in securing minimal circuit losses. Both the MPN3208 and the MPN3209 are packaged in a stud-based ceramic pill case designed to mount readily in the standard 8/32 tapped hole.

These state-of-the-art P-I-N diodes are available off-the-shelf today.

For a data sheet circle 233

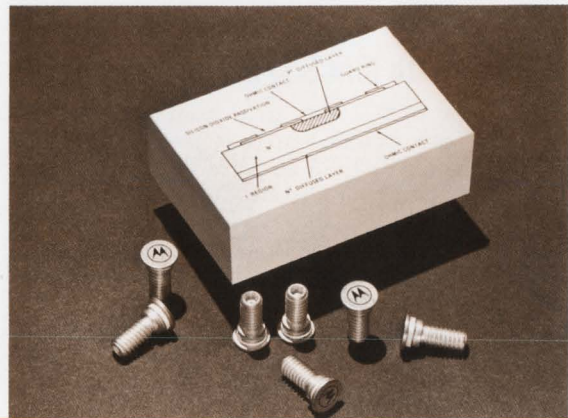

PLASTIC SILICON NPN CORE DRIVER

— Gives Dollars Switching Performance For Pennies Admission

Availability of Motorola's new 2N5845 NPN Silicon Annular transistor is news, good news, for designers with core driver or medium-current switching applications. Here is a device with just about everything. 40V (min) BV_{CEO} @ 10 mA — high f_T — low saturation voltage — fast switching — rugged package — and a low, low cost indicated by the 1000-up price tag of only 44¢.

All this spells real value, and there's more. Even though the 2N2845 is supplied in the plastic TO-92 package, the chip is mounted on a copper lead frame that ups the total device dissipation to a full 500 mW @ $T_A = 25^\circ\text{C}$. And, lead-forming to either the TO-18 or the TO-5 configuration is available, too.

When we say fast switching, we're talking about 40 ns t_{on} and 60 ns t_{off} at $V_{CC} = 40$ V and $I_C = 500$ mA. $V_{CE(sat)}$ is 0.6V (max) @ $I_C = 500$ mA and the current-gain — bandwidth product is 200 MHz (min) @ 50 mA. The warehouse has been stocked with ample quantities to assure excellent delivery.

For a data sheet circle 234

SWITCHING CHARACTERISTICS

Time	Maximum Value	Conditions
Turn-On Time	40 ns	} $V_{CC} = 40$ Vdc, $I_C = 500$ mAdc $I_{B1} = 50$ mAdc
Delay Time	17 ns	
Rise Time	28 ns	
Turn-Off Time	60 ns	} $V_{CC} = 40$ Vdc, $I_C = 500$ mAdc $I_{B1} = I_{B2} = 50$ mAdc
Storage Time	40 ns	
Fall Time	30 ns	

THREE NEW MHTL "NOISE REJECTORS"

— Ease Design of Industrial Environment Circuitry

Three new off-the-shelf members of Motorola's High Threshold Logic family, the MC679 dual lamp/relay driver, and the MC677 and MC678 hex inverters are ready to shrug off up to 6 V of electrical noise for designers of high-noise environment equipment.

The output transistors of the MC679 can operate 28 volt lamps or supply up to 150 mA. It's a natural for driving register clock lines, capacitive loads, or discrete components.

Strobe inputs allow one MC677 to replace 1½ quad two-input NAND gate packages in many applications.

Its lack of output resistors permits the MC678 to drive low-current lamps, interface with discrete components or implement the "Implied AND" (wired-collector) function with minimum power dissipation.

In 1-k up quantities: MC677L/MC677P — \$1.95/1.33; MC678L/678P/ — \$1.87/1.27; MC679L/MC679P — \$2.36/1.75.

For a data sheet circle 235

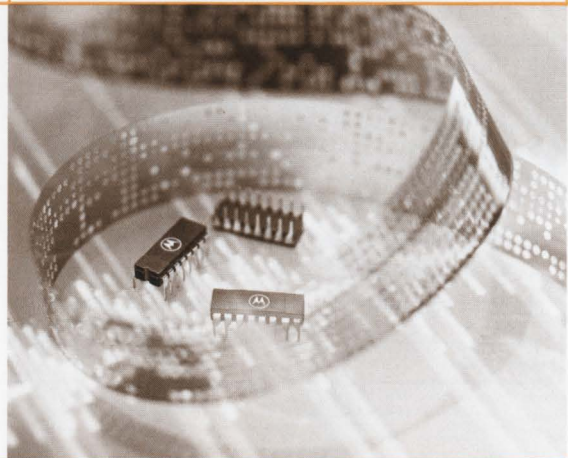

NEW PROGRAMMABLE UJT DEVICES

— Let You Tailor Their Specs For Your Circuits

Simply by varying the external resistors, you can "program" your own UJT specs into sensing, pulsing, timing, thyristor triggering and oscillator circuits with the new MPU131-133 series of plastic Unibloc UJT's.

R_{BB} , η , I_V and I_P device characteristics can be varied by changing resistor values making the part ideal for multi-socket, high volume applications.

The MPU131 series is also ideal for battery-powered and other low-voltage circuits. And, base 2 of the unijunctions may be used as a low-impedance output.

Featuring high pulse output voltage of 15 V (typ) and low on-state voltage of only 1.5 V (max) the new programmable unijunction transistors (PUT) use an all-Annular fabrication thus affording long-term stability, reliability and low-leakage. Gate-to-anode leakage current is, in fact, a 5 nA maximum!

The MPU131-133 units are numbers 18, 19 and 20 in Motorola's complete UJT line and numbers 7, 8, and 9 offered in the ever-popular Unibloc plastic package. All are economical and all are available now!

For a data sheet circle 236

CIRCUIT SYMBOL



PROGRAMMABLE UNIUNION

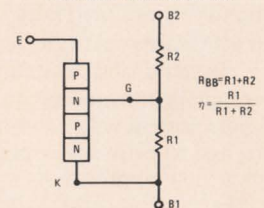

EQUIVALENT CIRCUIT WITH EXTERNAL "PROGRAM" RESISTORS R1 AND R2

PUT Series	I_P @ 10 V μ A (max)		I_V @ 10 V mA (typ)		V_O @ 20 V V (max)	I_{GAD} @ 40 V nA (max)
	1 M Ω	10 K Ω	1 M Ω	10 K Ω		
MPU 131	2	5	20	270	15	5
MPU 132	0.3	2.0	20	270	15	5
MPS 133	0.15	1.0	20	270	15	5



NEW LITERATURE BRIEFS

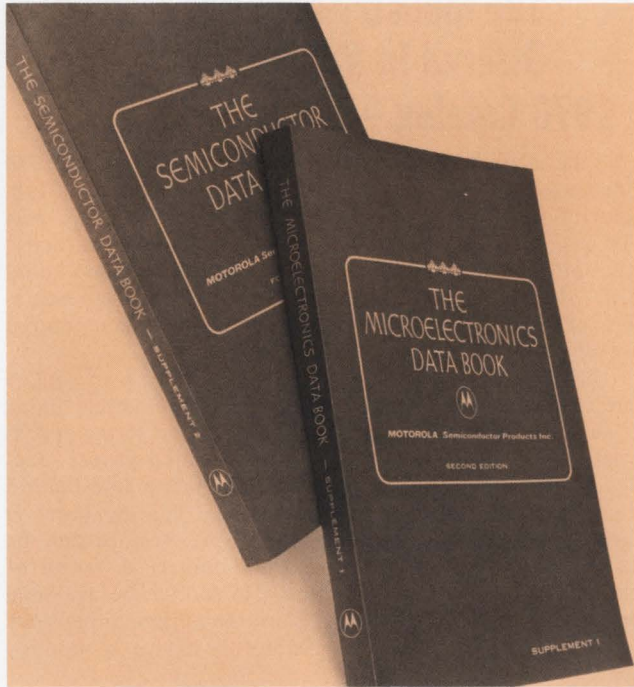

Supplements Ready For The Semiconductor And The Microelectronics Data Books

Supplement 2 to the 4th edition of the Semiconductor Data Book and the first supplement to the 2nd edition of the Microelectronics Data Book are fresh off the press and ready to bring your data book set completely up to date. If you're a data book owner and have subscribed to the updating service of either book you'll automatically receive your supplement for that book, or books. If you are not a book owner and would like to obtain either or both of the data books use the handy coupon. You may also order an updating subscription for either or both books (you receive the first two supplements to the corresponding book) or one or more of the supplements.

Use special coupon in this issue to order

New Master Selection Guide And Price List Available



The June/July, 1970 edition of the Motorola Master Selection Guide and Price List is ready. Compiled to make it easy for you to keep your files up to date, the new publication conveniently combines in one publication all the selector guides and price lists for every product line offered by Motorola.

The more than 100 pages in this edition cover all 17 major semiconductor categories and include a quick reference to new devices and price changes plus policies and ordering information — all in addition to the current prices of over 14,000 Motorola semiconductor devices.

For a copy circle 237



Please PRINT clearly (To expedite your literature we may have to use this as a return mailing address)

NAME _____ TITLE _____

COMPANY NAME _____

DIVISION _____ DEPARTMENT _____

COMPANY ADDRESS (Street or P. O. Box) _____

CITY _____ STATE _____ ZIP CODE _____

SEMICONDUCTOR NEWSBRIEFS

Please circle the Reader Service number of item(s) you are interested in receiving from NEWSBRIEFS No. 9-70:

E.D.						
221	222	223	224	225	226	227
228	229	230	231	232	233	234
235	236	237				

List Application Notes you wish to receive below (by number):

Do you wish a Motorola Representative to contact you?

VISIT PHONE . . . Phone No. _____ Area Code _____

NOTICE: Requests for literature on items described in this publication cannot be honored after October 1, 1970.

QUANTITY

COUPON

Semiconductor Data Book (4th edition)	Microelectronics Data Book (2nd edition)	
		Single copy @ \$4.95 ea. . . \$ _____
		2-24 copies @ \$3.50 ea. . . \$ _____
		25 or more copies @ \$3.30 ea. \$ _____
		Updating subscription @ \$2.00 ea. . . . \$ _____
		Supplement #1 @ \$1.00 ea. \$ _____
		Supplement #2 @ \$1.00 ea. \$ _____
		Total \$ _____

Fill in your name and address on the other side of this coupon. Tear along perforated lines and enclose in envelope with proper remittance.

Tear Along Perforated Line and Drop in Mail (No Postage Required)

FOLD HERE

FIRST CLASS
Permit No. 2565
PHOENIX
ARIZONA

BUSINESS REPLY MAIL

No postage stamp necessary if mailed in the United States

POSTAGE WILL BE PAID BY

Semiconductor NEWSBRIEFS No. 9-70
Motorola Semiconductor Products Inc.
P. O. Box 20924
Phoenix, Arizona 85036

FOLD HERE

For Fast Action!

... on delivery of literature for items described in this publication — fill out this coupon, fold as indicated and drop in the mail.

(NO POSTAGE IS REQUIRED)

Seal Here

(Please use tape — do not staple)

ORDER COUPON

Be sure to fill out **both** sides of this coupon, tear along perforated edge, and mail in envelope with check, money-order, or purchase-order (*) to:

Motorola Semiconductor Products Inc.
P. O. Box 20924
Phoenix, Arizona 85036

Note: (*)P.O.'s for less than \$20.00 cannot be accepted. Make checks or money-orders payable to: Motorola Inc.

NAME _____ TITLE _____

COMPANY _____

ADDRESS _____

CITY _____ STATE _____ ZIP CODE _____

NEW LITERATURE BRIEFS

The Industry's Fullest Line Offered In Motorola's New 1970 Catalog — Over 14,000 Items

Like a gracefully arching rainbow, the Motorola 1970 Condensed Catalog covers the solid-state world with a full, colorful spectrum of Motorola semiconductors. The new 104 page book bulges with the major electrical characteristics of nearly 14,500 items, altogether 20 pages and about 2,400 devices greater than the 1969 version. Representatives of nearly every kind of solid state device manufactured are offered.

To make it simpler to use, the new catalog is organized into three sections: Section I is an alpha-numerical index of device type numbers providing quick access to the appropriate table and page numbers in the catalog proper. Section II, the main listing, divides all components into natural categories and tabulates major electrical specifications so that easy component comparison or preselection can be made. Section III presents an alpha-numerical listing of military type semiconductors and also soon-to-be available devices. In addition to these sections, the outline dimensions for all packages in which any Motorola device is supplied are shown.

Highlights of additions to the new edition:

- New zener diode families, including low voltage avalanche zener regulator diodes and 500 mW Unibloc silicon-oxide passivated zener regulator diodes.
- Hot carrier power rectifier — 50 amperes.
- Silicon bidirectional triacs up to 25 amperes.
- Programmable unijunction transistor family.
- Silicon unidirectional and bidirectional switch family.
- New microwave devices including P-I-N switching diodes and hot-carrier diodes.
- Six new PNP silicon RF power transistors.
- New optoelectronic devices including a light-emitting diode.
- New family of dielectrically isolated MDTL integrated circuits.
- Nine additions to the MOS integrated circuit line including MCMOS devices.
- 31 new MTTL complex functions.
- 75 new linear integrated circuits featuring state-of-the-art introductions such as the MC1596, balanced modulator/demodulator, the MC1536 high voltage, internally compensated operational amplifier, the MC1566 laboratory specification voltage regulator, the MC1546 four-channel plated wire sense amplifier plus the industry's only four quadrant multiplier, the MC1595. For a copy see your franchised Motorola distributor.

Motorola Semiconductor Products Inc., P. O. Box 20924, Phoenix, Arizona 85036



The circuitry shown external to Motorola products is for illustrative purposes only, and Motorola does not assume any responsibility for its use or warrant its performance or that it is free from patent infringement.

MECL, MHTL, MTTL, MCMOS, Unibloc and EpiBase used in this publication are trademarks of Motorola Inc. Annular semiconductors are patented by Motorola Incorporated.

NOTE: If Motorola's Literature Request Coupon is missing, use magazine's standard Reader Service Card.



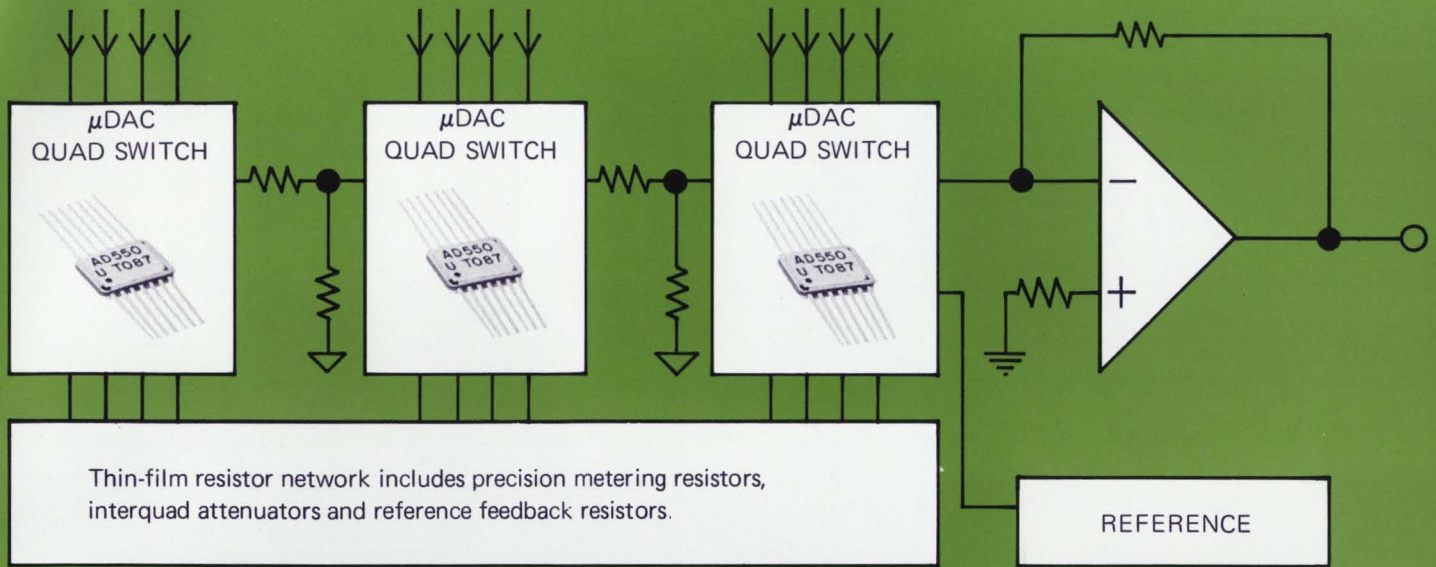

μDAC...The World's First Monolithic IC D/A Converter With 12 Bit ($\pm 1/2$ LSB) Accuracy

- Monolithic IC Construction
- .01% Accuracy with No Trimming
- Monotonic From -55 to $+125^{\circ}\text{C}$ with $5\text{ppm}/^{\circ}\text{C}$
- Small Size... Hermetic Flatpack or DIP
- High Reliability... Meets Mil-Std 883
- 5,000 Units In Stock For Immediate Delivery

Input buffers provide DTL, TTL compatibility

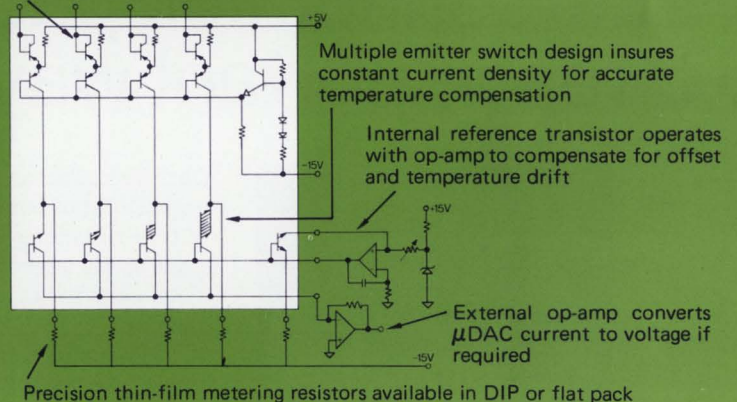

Analog Devices has applied the advantages of monolithic IC design to high accuracy D/A converters. The obvious advantages include high reliability, small size, low power consumption, wide temperature range operation and lower production costs. A more subtle but very important benefit of monolithic design is that multiple emitter switch design insures uniform current density which also contributes to the improved accuracy of the μDAC. Furthermore, a temperature compensating transistor is included on the chip with the bit current switching transistors. As a consequence, temperature drift effects are compensated leaving only $5\text{ppm}/^{\circ}\text{C}$ error (actually better than discretres).

The μDAC is comprised of 4 weighted current switches (and the compensating transistor) driven by logic input buffers compatible with all popular DTL or TTL logic. With the addition of current metering resistors, each μDAC becomes a 4 bit D/A converter. Three such μDAC's may be interconnected by means of simple 16:1 attenuator networks to form a 12 bit converter.

Complementary precision thin-film resistor networks, also available from Analog Devices, include precise metering resistors, reference resistor, gain setting resistor and the 16:1 attenuators. These resistor networks are packaged in

hermetic DIP or flatpacks identical to μDAC packages and reduce construction of 12 bit converters to the simplest possible assembly techniques. μDAC switches and resistors will also be available soon in plastic DIP's for low cost industrial applications.

The μDAC components can be readily assembled on your own PC card to build D/A and A/D converters. No trimming or adjustments are required to obtain up to 12 bit linearity and accuracy. Alternatively you can buy assembled and tested converters using μDAC components directly from Analog Devices.

Send for a free new 20 page applications manual giving specifications and theory of operation. The booklet also describes actual circuits and parts lists for implementing D/A's and A/D's using μDAC components. Write Analog Devices, Inc., 221 Fifth Street, Cambridge, Massachusetts 02142 or call Dick Ferrero collect on our HOT LINE — (617) 969-3661.



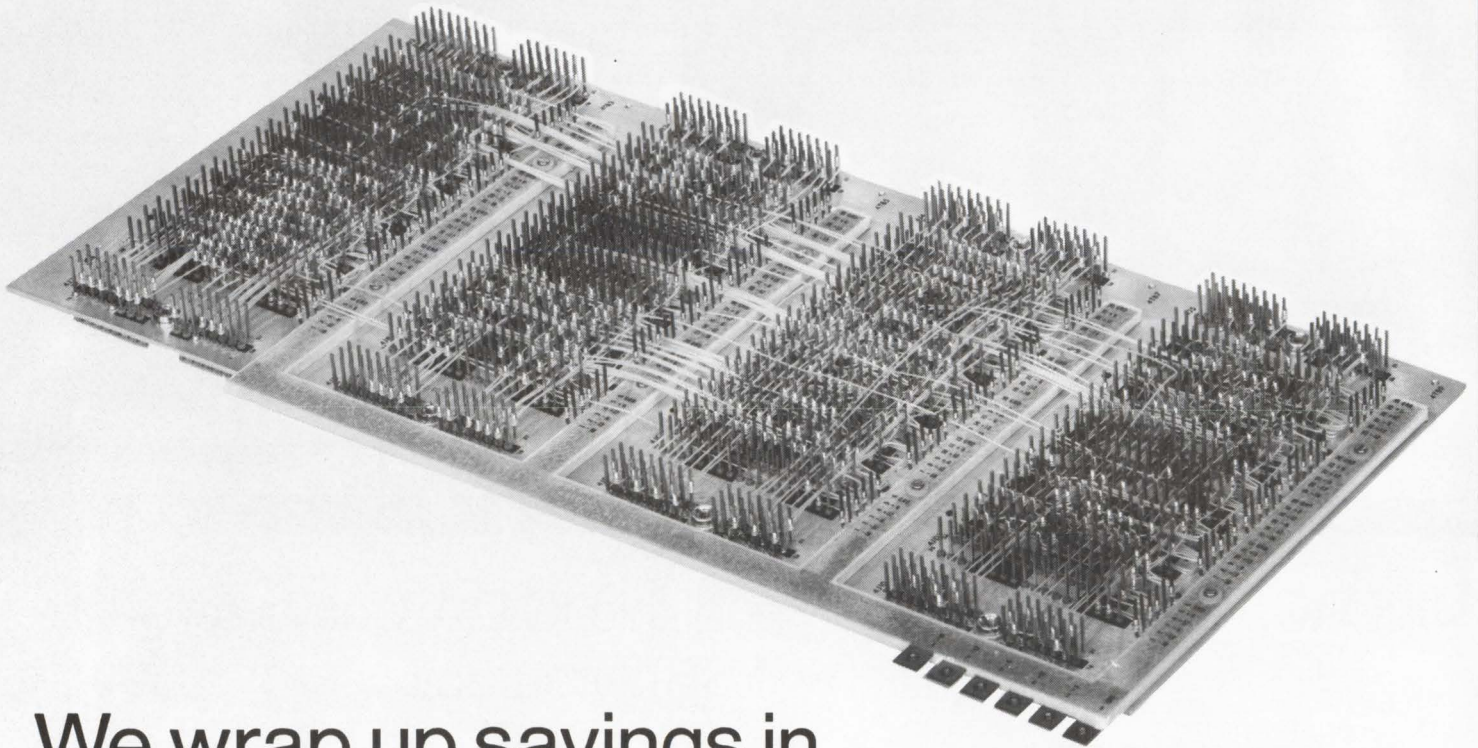

We wrap up savings in interconnection packages three important ways.

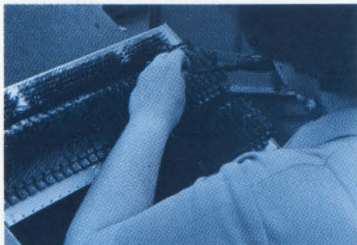

Hand wrapping



Semi-automatic machine wrapping



Fully automatic Gardner Denver machine wrapping

Our "Total Packaging Service" has helped a lot of our customers save a lot of time and money. And it's helped make us the largest manufacturer of metal plate back panel interconnection systems.

It's complete interconnection system packaging from design to wire wrap termination.

We deliver in six weeks.

That's it in a nutshell. Now, here's how it works:

You can call us in on the design stage. We'll sit down with you and help design a p.c. board or frame or metal plate back panel system to do exactly what you want it to do. With our experience we can save you problems. And problems cost money.

Next come the connectors. We have all you're likely to require; several hundred thousands of them. All standard. Maybe they used to be special, but now they're standard. You save again. For square or offset grids. On .100", .125", .150", or .200" centers. Or non-standard configurations if you need them.

And, finally, your wire termin-

ations. (You could send us your back panels and your wire list even this late in the game and we could still save you enough money to make it worth your while.)

You have three choices here: hand wrapping, semi-automatic machine wrapping, or fully automatic Gardner Denver machine wrapping. We handle the computer programming for the automatic and semi-automatic wire wrapping so you get not only accuracy, but minimum wire lengths and densities, too. You save again.

Add it up: three important ways you can save on your back panel interconnection systems. And we haven't even mentioned the remote possibility (perish the thought) of something not being quite right with the final package. Single source responsibility can save you all kinds of time and money.

For the rest of the details, call our Interconnections Manager, Jim Scaminaci, at (213) 675-3311, Ext. 235. Collect. Or write Elco Corporation, Willow Grove, Pennsylvania. 19090.

(215) 639-7000.

TWX 510-665-5573



ELCO Interconnection Systems

INFORMATION RETRIEVAL NUMBER 131

Technology Abroad

British automating Army weather data

Since the accuracy of artillery fire depends on determining rapidly the prevailing weather conditions, the British Army will soon be equipped with a new automated meteorological system.

Developed by GEC-Elliot Space and Weapon Systems, Ltd., with the Plessey Electronics Group as major subcontractor, the system produces instant weather messages by processing data automatically from a balloon-carried radiosonde and tracking radar. The data is fed into a Marconi-Elliot 920 B computer, which calculates the required meteorological information in less than two minutes. Current manual calculations take about an hour to complete.

U. S. Center in Frankfurt to show clean-air devices

Air pollution isn't only an American problem. West Germany's Federal Pure Air Law requires industrial installations to conform to established air-quality standards.

To help American manufacturers garner a share of an estimated \$100-million spent annually by German industry on air-pollution-control equipment, the U. S. Dept. of Commerce will sponsor an exhibition of industrial air-treatment equipment and instrumentation at the U. S. Trade Center in Frankfurt, Nov. 9-13.

Business-machine trade soars to new heights

U. S. foreign trade in business machines in 1969 reached new highs of \$1.1-billion in exports and \$375-

million in imports, the U. S. Dept. of Commerce reports. Exports were up 37% over the \$835-million of 1968, and imports were up 45% over the \$259-million for the same year. Electronic computers and parts accounted for the largest segment of exports—64%, for a total of \$728-million. Major customers included West Germany, Britain, Canada, Japan and France.

U. S. Post Office buys Japanese mail handler

A high-speed automatic letter-handling machine that U. S. Postmaster General Winton M. Blount noticed at the United Postal Union Conference in Japan last year has been purchased for use in the U. S. Post Office's current modernization program.

Developed by Tokyo Shibaura Electric Co., Ltd. (Toshiba), the \$200,000 letter handler incorporates a photo-electric scanner and computer recognition logic. It is said to be able to cull and stack up to 23,000 pieces of mail an hour automatically by thickness and size. The machine is also able to detect and face-cancel stamps.

Giant Swedish antenna to relay telephone calls

A large ground station with a paraboloid antenna nearly 100 feet in diameter will be erected at Tanum, West Sweden. Scheduled for completion toward the end of 1971, it will be used to relay telephone calls between Scandinavia and North America via Intelsat. The station is expected to handle 60 simultaneous telephone calls and will transmit and receive color and black-and-white television programs.

If you can't stand the heat ...

stay out
of the
kitchen!



Here are components that stand the heat . . . and the cold (-55°C to $+125^{\circ}\text{C}$) without voltage degrading. The dissipation curve is as flat as a pancake . . . and the other specs are out of this world. Maybe your recipe calls for

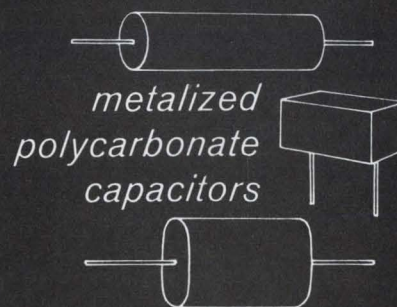

Try Standard's PC2-E (Rectangular Epoxy) and PC2-W (Wrap and Fill).

Send for Catalog and complete details.

Standard
CONDENSER CORPORATION
Dept. ED-6
1065 West Addison Street
Chicago, Illinois 60613 • (312) 327-5440
INFORMATION RETRIEVAL NUMBER 20

Worldwide network to predict solar EMI

John F. Mason
Military-Aerospace Editor

Users of radios, radar, navigation units and other electronic devices have known for a long time that solar activity has a direct effect on the ionosphere, which in turn degrades the performance of their equipment. High-frequency radio transmission fades and even disappears, and radar targets become less distinct due to electro-magnetic noise. Signals from the latest and most sophisticated navigation and communications satellites, regardless of frequency, suffer just like older equipment from the same solar complaint.

To understand, predict, and possibly circumvent some of these troublesome and often crippling

effects, an elaborate worldwide network of sensors and data-processing equipment has been built and will go into operation this month.

Developed by the Air Force Cambridge Research Laboratories' Space Physics Laboratory at Hanscom Field, Mass., the network consists of 50 ground-based stations (optical and radio observatories). These are equipped with radio receivers, called riometers, that measure galactic noise in the ionosphere; ionosondes; neutron monitors; and magnetometers. Also, data from the Vela satellites will be fed into the system, keeping it up to date on the radiation level in space.

Located throughout the world, the ground stations will transmit their data by teletype to a com-

plex of four Univac 1108 computers at the Air Force Global Weather Central at Offutt Air Force Base in Omaha, Neb.

The data will consist of measurements of a variety of solar activity, solar emissions, and solar-induced geomagnetic and ionospheric changes in the earth's environment. The computers will process the data as a basis for forecasting changes that affect Air Force communications, navigation and surveillance systems.

The second time around

Cambridge tried once before to develop a service of this kind, but it didn't work. Solar-geophysical data extending back to 1955 was gathered from scientists from all over the world. Details of solar flares, sunspots, 9.1-cm radio brightness temperatures, 10.7-cm solar radio flux, geomagnetic indexes and shortwave radio fade-outs were carefully assembled, checked for errors, collated and statistically analyzed.

Unfortunately, the results were nearly useless because of the large number of errors, inconsistencies, different reporting standards and variations in instrument calibration.

The current program, however, will be different. At the very beginning, the Air Weather Service and Laboratory initiated a parallel program to establish uniform observing and reporting procedures, and they designed new and carefully calibrated observing equipment that would provide standardized information.

The solar-geophysical data base for the system being put into operation this month is "the most consistent and error-free ever generated," says a spokesman for the laboratory.

Computer programs for accepting the incoming data, for processing it and for forecasting parameters were developed by the Cambridge Laboratories. ■■

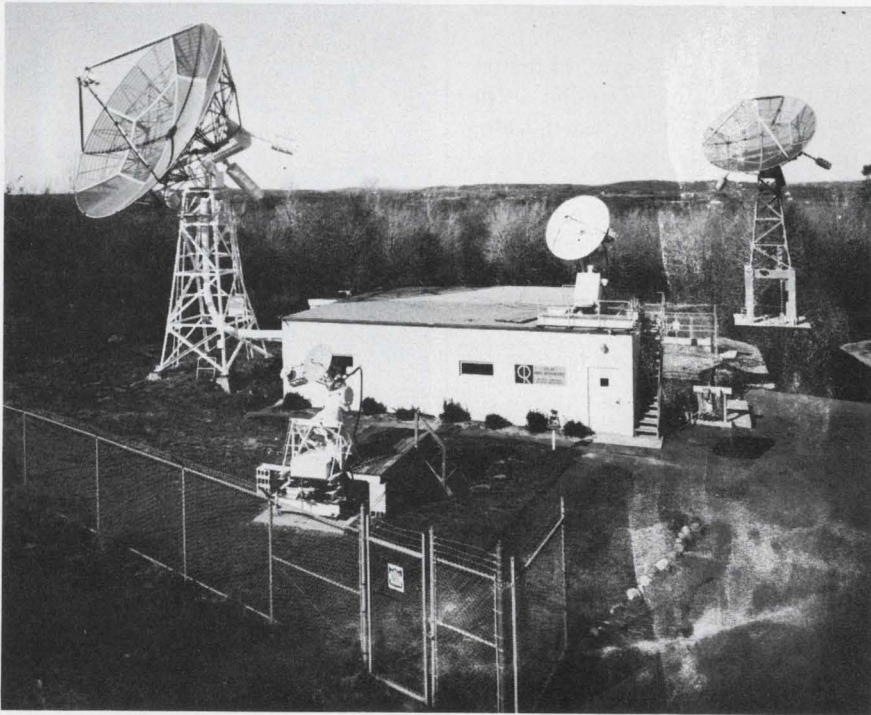

Solar activity is monitored in different frequencies by these five antennas at the Air Force Cambridge Laboratories' solar radio observatory near Ipswich, Mass. From left to right: the 28-foot antenna receives solar emissions at 606 MHz and 1415 MHz; the 1-foot antenna in the foreground attached to its 3-foot companion on the right receives at 35,000 MHz; the 3-foot dish is tuned in at 15,400 MHz; the 8-foot antenna on the observatory roof receives at 2695 MHz, 8800 MHz and 4995 MHz; the 28-foot dish at the right of the building receives at 245 MHz.

ELECTROMECHANICAL
PRODUCTS
DALE

Take control with



Ready to ship now... Improved low cost STEPPING RELAYS

Under \$6.00 in quantities of 2,000. Unidirectional/bidirectional plate and wafer types. Improved design with field replaceable components and auxiliary switching. Meet wide range of communication, surveillance, testing, and coin-operated machine applications. Double pole models to 6 steps. Single pole models to 13 steps. Exclusive selectable stop allows users of plate model to adjust steps as needed. For 6, 12, 24, 117 volts AC/DC.

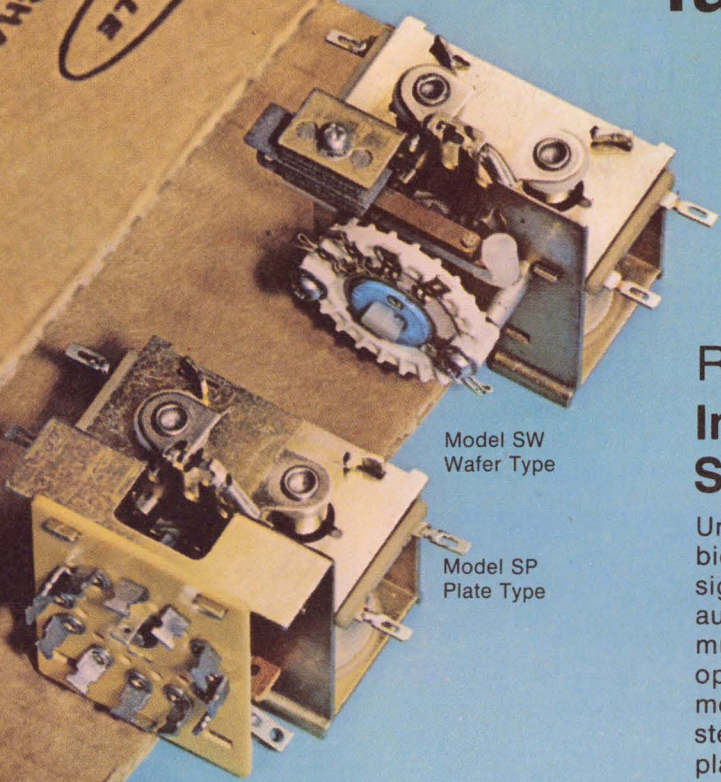

Model SW
Wafer Type

Model SP
Plate Type

**Reversible AC
Hysteresis
Synchronous
Motors**

Gearhead Motors
... available with
magnetic clutch

**Motorized
Potentiometer
Kits** for operating
1, 3, 10-turn pots,
rotary switches,
variable capacitors,
cams, timers,
tuners.

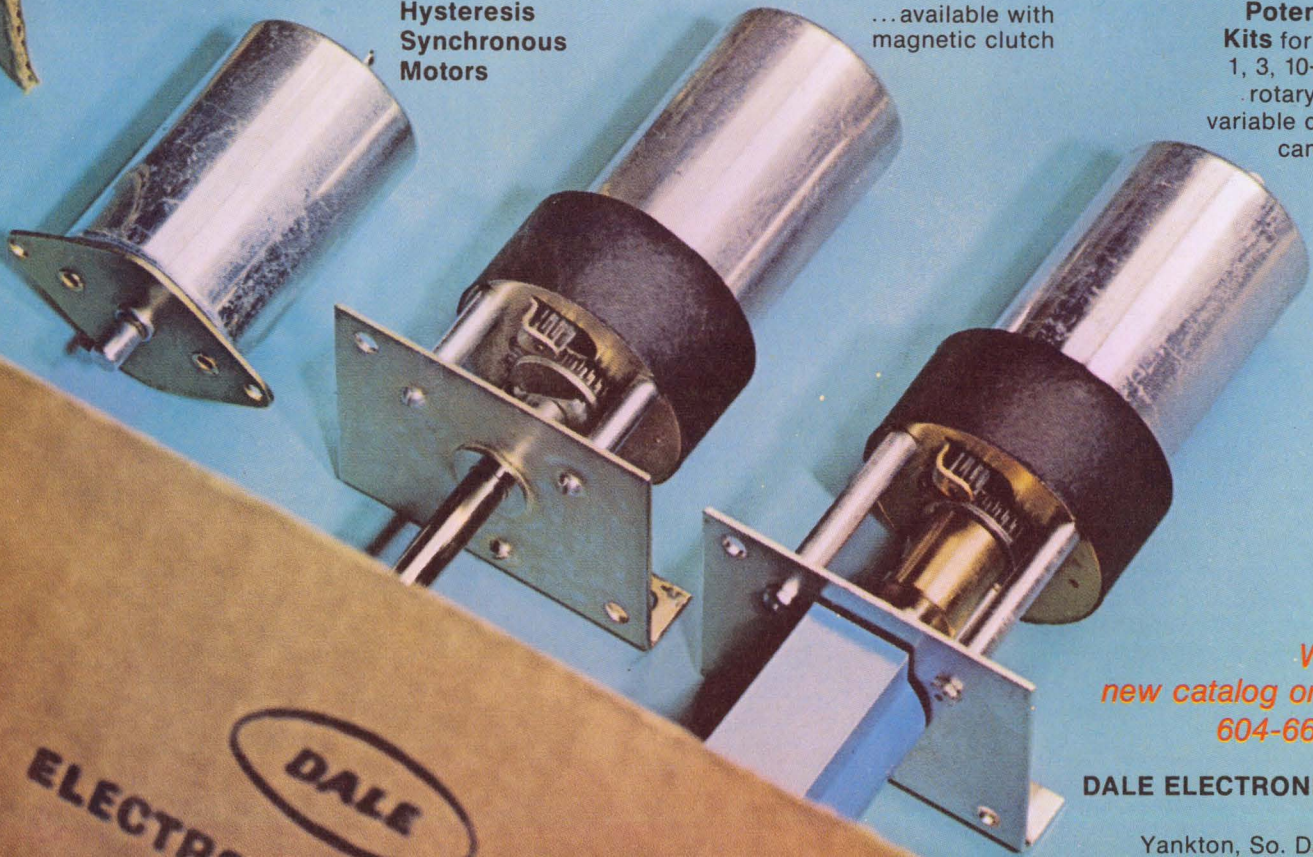

*Write for
new catalog or phone
604-665-9301*

DALE ELECTRONICS, INC.

Box 180

Yankton, So. Dak. 57078

In Canada: Dale Electronics Canada, Ltd.
A subsidiary of The Lionel Corporation

ELECTROMECHANICAL
PRODUCTS
DALE



What happened to the model 19?

You're looking at some of the Teletype® basics used in building a data communications system. Printer, keyboard, tape sending and receiving combinations in a variety of speed capabilities. Teletype's modular design concept gives you the opportunity to extract the best terminal combination for system

needs today, and refine, add to, subtract and adapt as system modifications are called for. Just as important as the basics, are some of the things not obvious in the photos below. The logic devices, options and accessories that add almost limitless possibilities for making things happen exactly as

your system requires. We have some solid state logic devices that provide precise control of data traffic. That enable your computer to automatically poll data from a number of terminals and feed each terminal with processed data. There are error detection, correction and signal regeneration options to

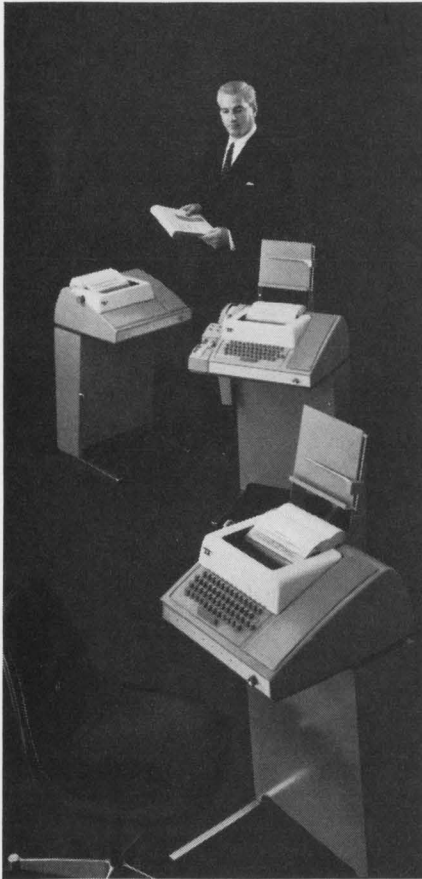

model 33 series: An extremely economical 100 wpm terminal line. Has 4-row keyboard, uses 8-level ASCII code. The most widely used terminal in time-sharing systems today.



model 35 series: A rugged, heavy-duty line of 100 wpm terminals. Uses ASCII. Units in foreground are self-contained paper tape punch and paper tape reader.

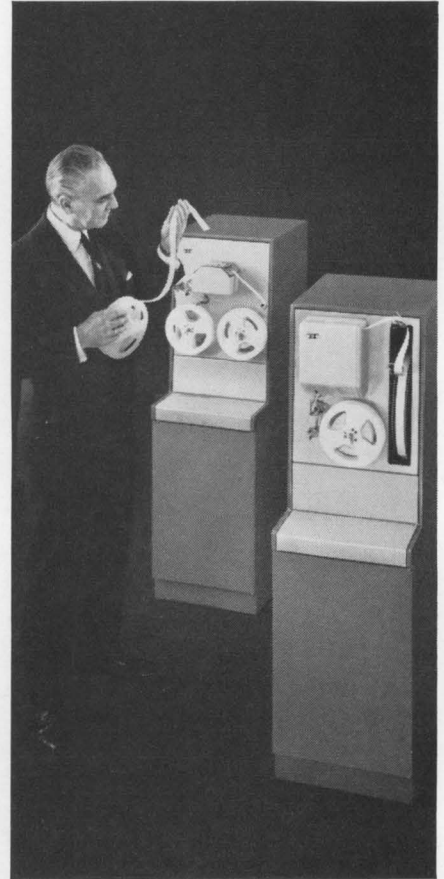

Telespeed™ equipment: A line of high-speed tape-to-tape terminals capable of sending and receiving at speeds of 750, 1050 (shown above), or 1200 words per minute.

DATA COMMUNICATIONS

equipment for on-line, real-time processing

keep data flowing faultlessly. Options such as pin-feed platens and form feed controls that make it possible to fill multiple copy business forms on-line. And many, many more. What did happen to the model 19? Believe it or not, there are still some of these old, die-hard terminals around. And that's

another advantage your data communications dollar buys when you specify Teletype equipment. It lasts. Moves data reliably, economically, for a long time. On a price/performance basis, Teletype equipment is in a class by itself.

Teletype data communications equipment is available in send-receive capabilities of up to 2400 words per minute. If you would like specific information about any of the equipment described here, write: Teletype Corporation, Dept. 89-17, 5555 Touhy Ave., Skokie, Ill. 60076.



model 37 series: One of the most versatile heavy-duty terminal lines going. Generates all 128 characters of ASCII. Operates at 150 wpm. Prints in upper and lower case.

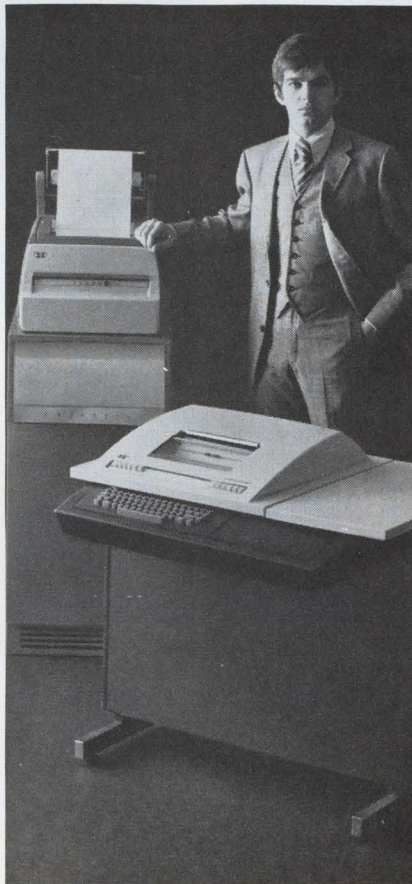

Inktronic® data terminals: A unique electronic, solid state terminal. Prints up to 1200 wpm. Forms characters through electrostatic deflection (no typebox). ASCII compatible.

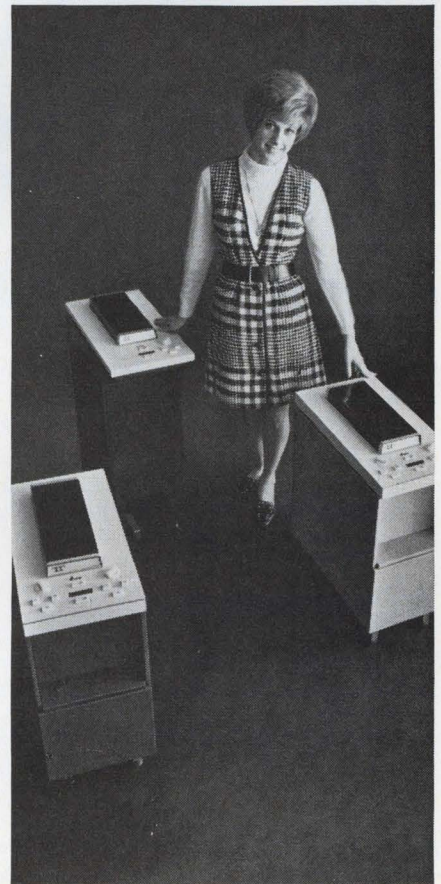

magnetic tape data terminals: Use compact reusable tape cartridges. Operate on-line at up to 2400 wpm, and connect "locally" to lower speed Teletype terminals using ASCII code.

Teletype is a trademark registered in the U.S. Pat. Office

machines that make data move



INFORMATION RETRIEVAL NUMBER 22

Tips on cooling off hot semiconductors

See how other circuit designers use IERC heat sinks/dissipators to hold junction temperatures below rated maximums, improve circuit performance and reliability

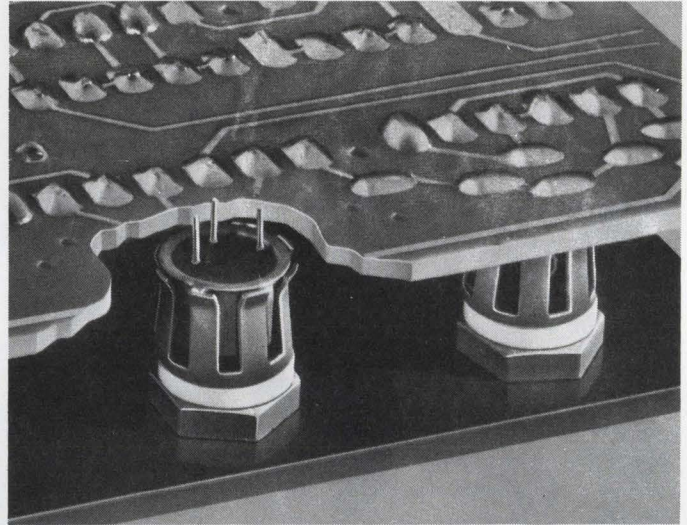
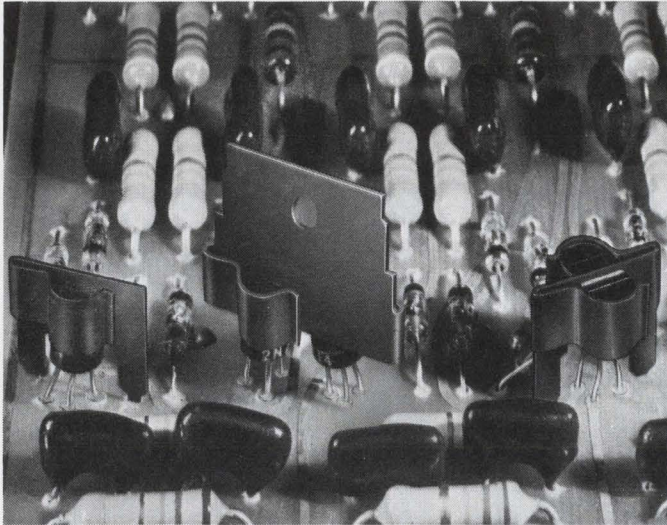

RO97's, RO97A's, X20's (D-Style) and other lead mounted, low power "plastic" transistors can be operated at up to 65% more power with IERC dissipators. They cost only pennies, provide excellent retention in severe environments, reduce failures from solder heat during assembly. 5 different styles; both single and dual models.

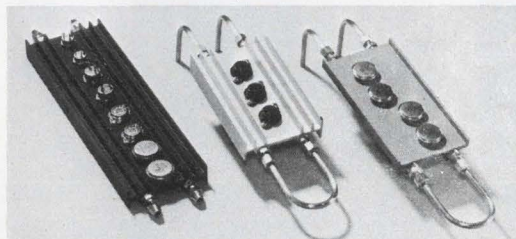

Replace elaborate forced air cooling systems for power devices. IERC fluid cooled systems provide up to 1,000 watts of dissipation in less than 45 cu. in. Parallel or series flow; open or closed loop systems. All standard mounting hole patterns; specials, too. Lengths from 6" to 3' standard.

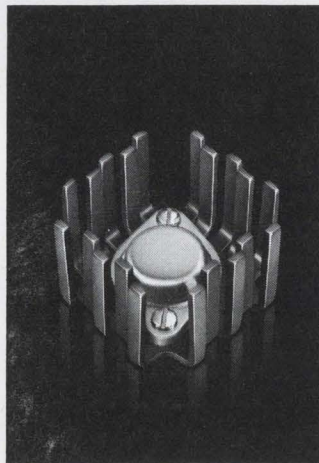

TO3's, TO66's, TO15's and other case-mounted devices can be operated with many times more power when mounted in UP's. In still air, the staggered fingers dissipate by radiation and convection. In forced air, turbulence moves the air around each finger. Efficient in any direction. Outperforms extrusions dramatically.

For low capacitance between transistor and chassis, use IERC Thermal Links with BeO washers. BeO has the thermal conductivity of aluminum, yet cuts capacitance up to 2/3rds. Excellent dissipators and retainers. Each size fits a complete JEDEC case diameter range for TO5's and TO18's. Dual and quad models also.

Is yours a special heat problem? Talk to the thermal specialists at IERC. They have the problem solving experience to come up with a practical, low cost solution.



Free 4-page Short Form Catalog. Complete ordering and pricing information on the world's broadest line of heat sinks/dissipators and retainers for lead and case mounted semiconductors.

Heat Sinks/Dissipators



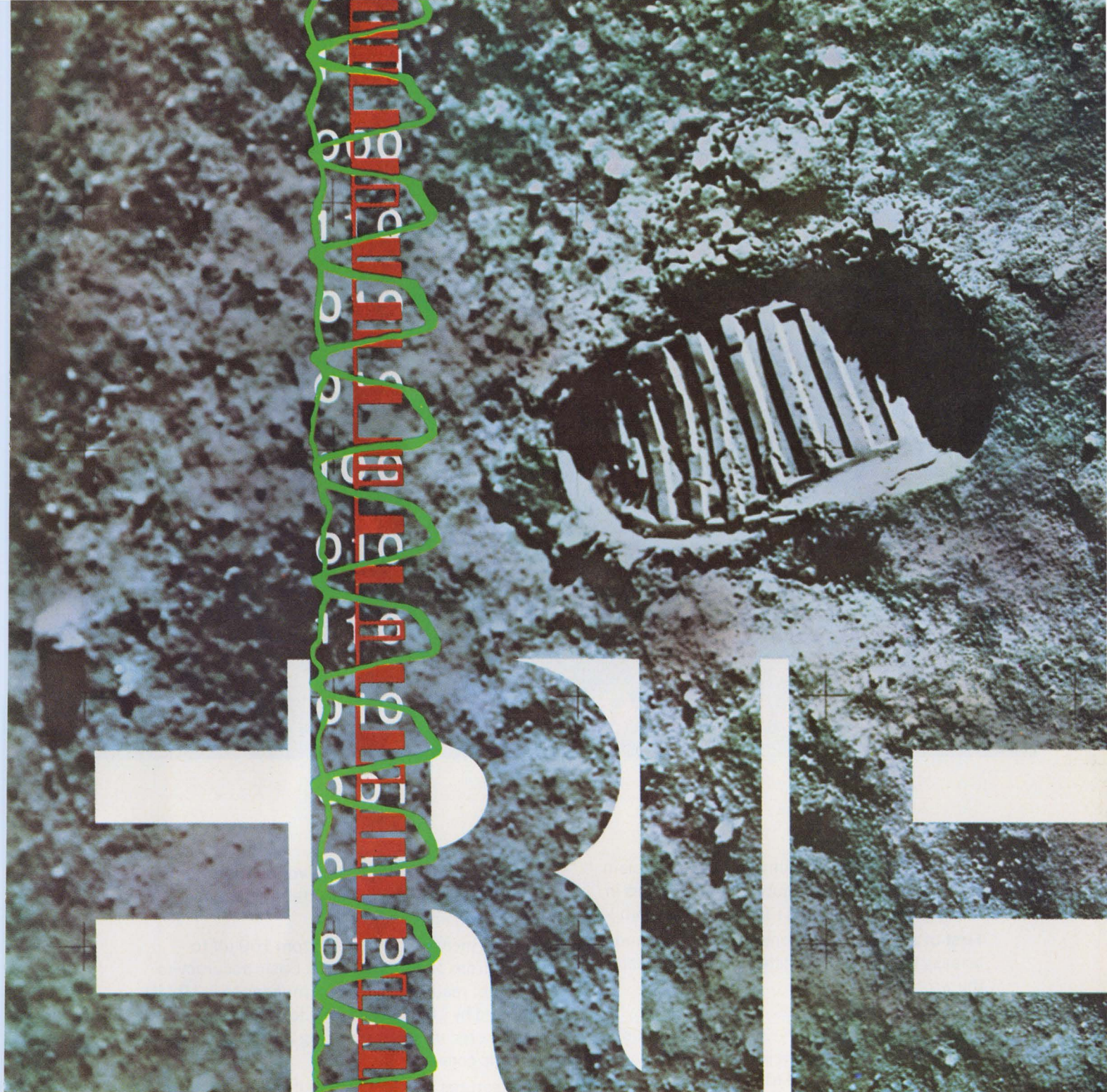

When you can't afford a "wrong number"...

Symbolic representation of the TV, voice, ranging data and biomedical telemetry signals from the moon. Photograph courtesy of NASA.

bring ERIE in early.

Where are they? How are they? What do they see... and say? NASA and the world want to know. And, the only way to find out is over the special Motorola S-band equipment on both the Command and Lunar Modules. Once the Apollo Astronauts are over 30,000 miles out, it's their *only* communications link with Earth. It simply can't fail. That's why Motorola called on ERIE TECHNOLOGICAL to develop the EMI filters and Monobloc capacitors that would help this equipment perform flawlessly on every Apollo mission since Motorola has been involved. Proof, once again, that it pays to bring ERIE in early.

ERIE TECHNOLOGICAL PRODUCTS, INC.
644 West 12th Street, Erie, Pennsylvania 16512
(814) 453-5611

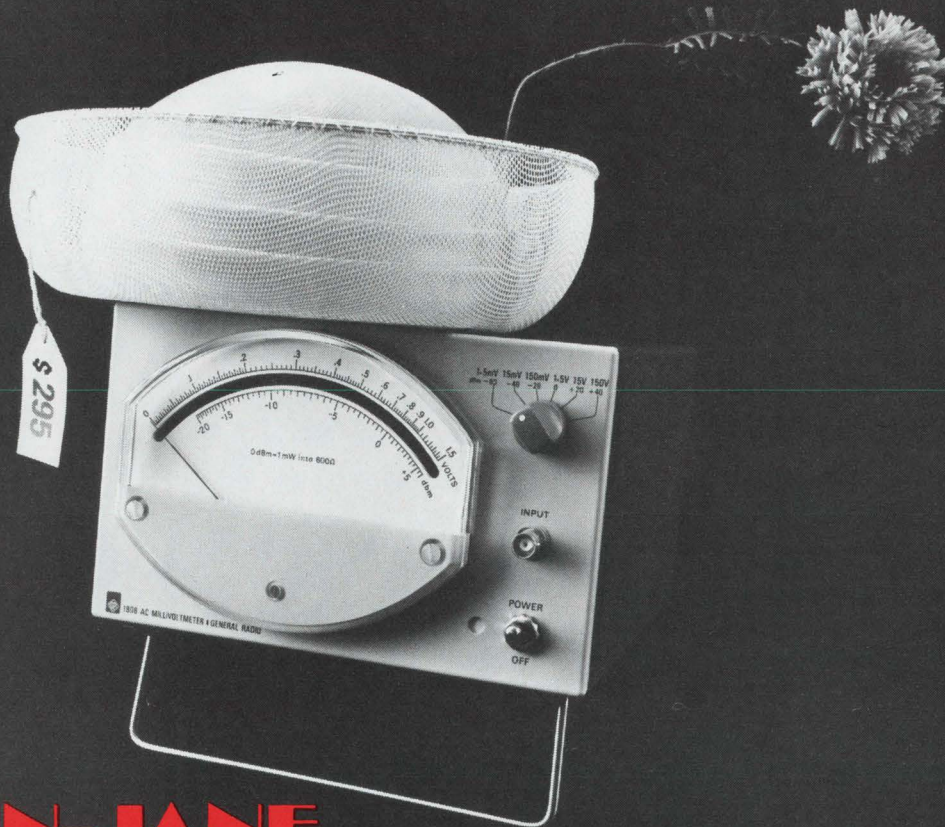

THE PLAIN-JANE MILLIVOLTMETER.

The new GR 1808 AC Millivoltmeter is so plain it's almost ugly. The beauty of the 1808 lies in the engineered features that give it the plain look. First of all, there's only one voltage scale and it's as easy to read as a yardstick. You can't read the wrong scale!

Look at the range switch — only six positions! Most voltmeters have twelve ranges and panels so cluttered they look like they belong in an SST, not on the bench. That's because most voltmeters have only a 3:1 meter range. The GR 1808 has a 10:1 range which halves the amount of range switching and means faster, easier, error-free readings for you. The meter is big, too — 6 inches of scale as compared to the usual 4½-inch varieties.

A point about stability — line-voltage variations cause absolutely no meter jitter or change of reading on any range.

Voltage measuring range is from 100 μ V to 150 V from 10 Hz to 10 MHz. Basic accuracy is $\pm 1\%$ of reading, and input impedance is 10 M Ω shunted by 10 pF. A floating dc output is available for recording or for using the GR 1808 as an ac to dc converter for DVM's.

The features may be fancy, but there's nothing fancy about the price; only \$295 in U.S.A.

For complete information, write General Radio, West Concord, Mass. 01781; Telephone (617) 369-4400.

In Europe: Postfach 124, CH 8034, Zurich, Switzerland.

GENERAL RADIO



Washington Report

DON BYRNE, WASHINGTON BUREAU

Navy fights to save money on DD-963 contract

The Navy is battling mightily to convince the Pentagon and Congress to let it save money on a \$2.6-billion fleet of new destroyers, which will be highly automated and rely heavily on electronics. The novel aspect of the situation is that the House approved the money for the DD-963 series of ships, some 30 in all—but added a rider stating that the work must be done in at least two yards. The Navy wants one yard, saying that it will be cheaper and more efficient. Bidders are the Bath Iron Works in Maine and the Litton Industries Yard in Pascagoula, Miss.

Some 4000 jobs and 99 months of assured work are at stake in the biggest shipbuilding contract the Navy has ever let. Sen. Margaret Chase Smith (R-Me) has been actively campaigning for the contract to be awarded to Bath and thus finds herself pitted against Sen. John Stennis (D-Miss.), chairman of the Senate Armed Services Committee on which she serves. In addition, Rep. William Colmer (D-Miss.), head of the powerful House Rules Committee, has shown a lively interest in the contract since the Litton yard is in his district.

The dual-yard provision was included in an appropriation bill last year but was dropped in a subsequent House-Senate conference. When the new appropriations bill came up again this year the House passed it, and said that they would not press the provision, whether the Senate takes it out or leaves it in. The contract is an unusual one in that the selected yard, or yards, will design the ships rather than follow a Navy design, as has been done in the past.

DOD telecommunications post gets push by Packard

The long discussed Office of Assistant Secretary of Defense for Telecommunications got a big push recently when Deputy Defense Secretary David Packard issued a memorandum and accompanying directive to the various Pentagon elements that will be affected. He said arrangements for the new office should be completed by the end of this month. He described its functions and how DOD communications management would be concentrated in it.

At the same time the name of Louis A. Derosa, former vice president of Philco-Ford, is being kicked around as being the head of the new office. He has been serving as a consultant to DOD for about two months and had been in the communications industry in various executive capacities since 1942.

Government tells Lockheed to seek private help

The Government doesn't have the answer to Lockheed's financial problems as yet and has advised the aerospace firm that it should seek help in the private sector through loans or mergers. In March, Lockheed told the Pentagon that it would have to halt work on four of its major contracts unless it received \$600-million over the next three years in interim financing. The House has already approved a military money bill contain-

ing \$200-million for Lockheed "contingencies," and the measure is now before the Senate.

Deputy Defense Secretary David Packard told the Senate Armed Services Committee, "I recognize the necessity to segregate Lockheed's commercial from Government business, and I am convinced that no resolution can be achieved short of bankruptcy and reorganization . . . without help from the private sector." He added that, even with the "most favorable resolution" of Government contract problems that he could consider, Lockheed would find itself short of cash unless it got private help. He added that Lockheed is currently investigating the possibilities of loans and/or mergers and should have explored all possibilities in a month or two.

AWACS possible victim of economy

Administration cost trimming has put the Air Force's AWACS (Airborne Warning and Control System) on a back burner for six months or perhaps a year. The Air Force still wants the program very badly, but it is wary of a gut fight at this time to obtain the \$2.1 billion it would need to implement it.

Basically, the program consists of a fleet of about 40 Boeing 707s or McDonnell Douglas DC-8s modified to include a massive radome and electronic gear including an onboard computerized data processor. Contracts were originally to have been let late in May, but the Air Force merely said that it was returning bids to the contractors. Westinghouse and Hughes Tool are in the running as prime radar bidders.

House committee test crime detector in school

An electronic scanner that detects metal of pistol size or larger is the heart of Friskem, an anti-aircraft highjacking device manufactured by Infnetics, Inc., of Wilmington, Del. Recently the system had an unusual workout when it was tested in a Washington, D. C., junior high school. The subject was combating crime in the schools; hearings were held in a schoolroom; and the audience was composed mostly of schoolchildren. Chairman Rep. Claude Pepper (D-Fla.) of the House Select Committee on Crime, which held the hearings, claimed that 20 per cent of those entering the room during the tests had pieces of metal as big as a pistol or larger on their persons.

AT&T announces phase-out of Apollo's Bellcom

The American Telephone & Telegraph Co. has announced it will phase out Bellcom, Inc., a subsidiary owned by it and Western Electric, which has been engaged exclusively in the Apollo manned space flight program. No other Government contracts of the Bell System, such as the Safeguard antiballistic missile system, will be affected.

"It's primary mission accomplished, Bellcom, Inc., will phase out its work for the National Aeronautics and Space Administration by the end of 1972," an AT&T statement said, adding that the company would become a part of Bell Telephone Laboratories at some future time.

Bellcom was formed by the Bell System in March, 1962, in response to a request from NASA for assistance in the nation's effort to land a man on the moon and return him safely.

Quality business machines and equipment deserve the best in toggle switches. Cutler-Hammer's.

Whether it's the switch for a printout machine at the bank or the bank of switches at a recording studio, when you specify Cutler-Hammer toggle switches you can bank on the performance.

Top-quality equipment—from commercial-grade appliances to computers—deserves the finest in switches. The finest quality. And the finest in design flexibility, distinctive appearance, and performance.

You get all this from Cutler-Hammer in the broadest line of toggle switches available.

AC-rated. AC/DC. Low energy.

Dry-circuit capability, or up to 25 amps. One, two, and four poles. The greatest selection of ratings, terminations, hardware, toggle shapes, materials, and colors. You name it. We have thousands of varieties ready for delivery—and we'll build one more to your specifications if you don't find what you want in stock.

So, for the next piece of quality equipment you design, specify Number 1. Cutler-Hammer toggle switches. The performers you can bank on. Call your C-H Sales Office or Stocking Distributor. Or write for full-line catalog LD-110-217.



Quality switches for quality products. See your C-H Distributor for immediate service.

CUTLER-HAMMER 
SPECIALTY PRODUCTS DIVISION, Milwaukee, Wis. 53201

INFORMATION RETRIEVAL NUMBER 26

Bank on them.

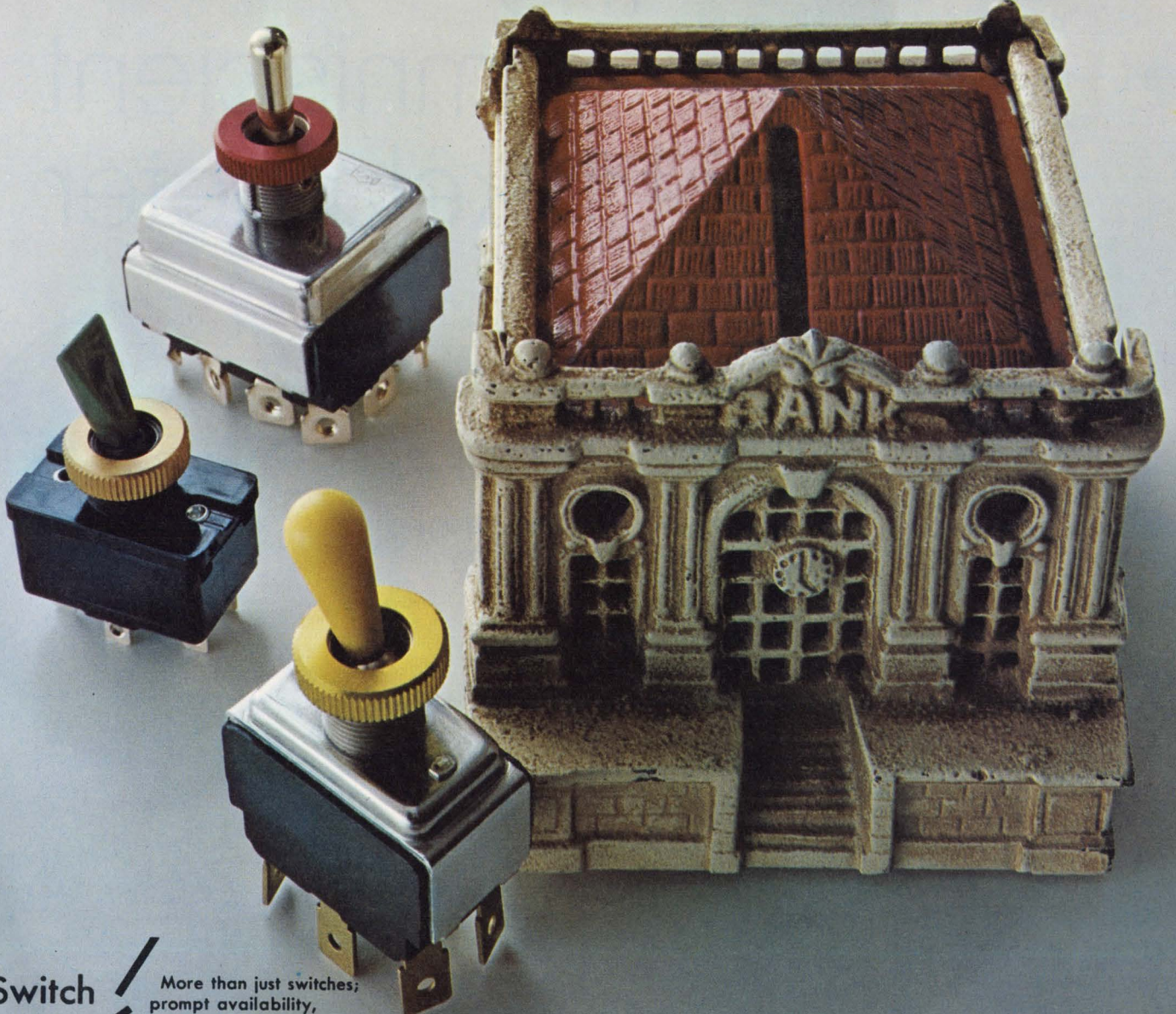

Switch
to No.1

More than just switches;
prompt availability,
field help, innovation,
quality assurance, too.

The new HP 3480 A/B Digital Voltmeter is more than a digital voltmeter. It's an advance in the state-of-the-art. It's the omniscient triskelameter that sees all the values you are measuring. It's really a measuring instrument that is ideally suited for bench *and* systems applications.

The HP 3480 A/B is the first DVM capable of making 1000 correct dc or ohms readings per second. It takes the 3480 less than 1 ms to respond to a full scale input and digitize the input signal.

The HP 3480 A/B is the first 4-digit multifunction DVM having an ac converter that is true rms responding to eliminate large errors caused by harmonic distortion or noise and extends your measurement capability to include

the rms value of non-sinusoidal wave forms. The 3480 A/B has a 100 mV range and covers from 1 Hz to 1 MHz and will measure *ac plus dc*.

The HP 3480 A/B DVM is ideal as a bench instrument. No other instrument — single purpose or multiple function — equals the 3480 A/B. Top performance in measuring dc, three-terminal dc ratio, true rms ac, ac-plus-dc in one measurement, and ohms is assured by the accuracy designed into the instrument.

You get four-digit readout plus 50% overranging which results in greater

resolution and less range change. The high dc input resistance ($> 10^{10} \Omega$ on the lower three ranges) reduces the possibility of loading errors.

True rms ac conversion makes the 3480 A/B immune to large errors caused by small amounts of harmonic distortion and expands the range of precision ac measurements to non-sinusoidal wave forms.

The wide bandwidth (1 Hz to 1 MHz) and the capability of making ac-plus-dc measurements gives the 3480 A/B a broader range of applications not available before. And, the high ac and dc sensitivity (100.00 mV full scale) reduces the need for preamplification.

HEWLETT  PACKARD

never before has there
been a DVM so ideally suited
for bench and systems use as

the omniscient triskelameter



The HP 3480 A/B DVM is ideal as a systems instrument. Up to this time, DVM's have been the slowest part of a measurement system. Now, the system doesn't have to wait for the DVM. The HP 3480 A/B DVM can make up to 1000 dc and ohms readings per second. You can save automatic test time and increase production—or you can appreciably reduce computer idle time.

The 3480 A/B is fully guarded to improve common-mode rejection. There is a switchable 3-position input filter to give you the optimum trade-off between

noise rejection and speed. The 3480 A/B is fully programmable including range, function and filter position.

With the optional isolated BCD and isolated remote control you can reduce errors created by ground loops, improve your common-mode rejection even more, and make floating measurements into a guarded system.

Modest prices, too! All the capability packed into the 3480 A/B is not expensive. Prices range from \$1150 for one range of dc to \$3375 for multi-function ac, dc, ohms capabilities with isolated BCD and isolated remote control.

For the best in bench and systems DVM's, get the omniscient triskelometer—the new HP 3480 A/B DVM. Ask your local HP field engineer for full particulars, or write to Hewlett-Packard, Palo Alto, California 94304. Europe: 1217 Meyrin—Geneva, Switzerland.



090/9

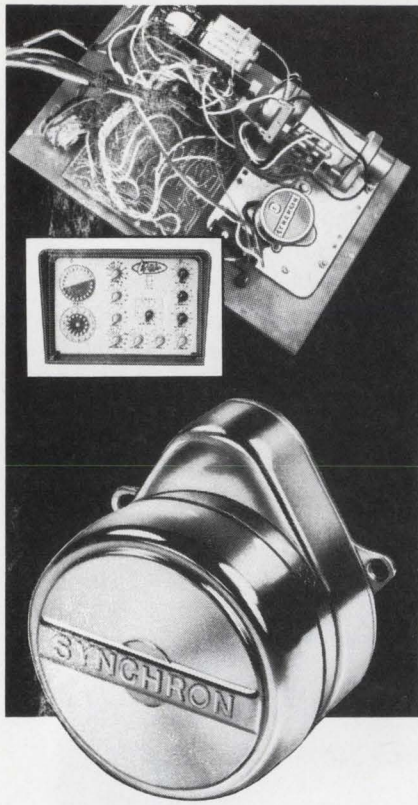

HOW SYNCHRON® MOTORS control this specialized TIME-DELAY RELAY

In this special design timer a Hansen SYNCHRON Motor drives the cam-type sequence timer for an electronic time-delay relay. When power is applied, SYNCHRON runs through the first three sequences; starts the time-delay relay, then stops. Relay performs a panel-adjustable delay period of 180-240 seconds, then returns power to the motor to complete the sequence. Special applications are easy to design, using SYNCHRON Motors. How about yours? Call or write Hansen, or your SYNCHRON representative, for brochure and all the facts.

SYNCHRON timing and control motors; 168 different speeds. Right, left or reversible rotations. 8, 20 or 30 oz.-in. torques; 220, 110 or 24 volts; 60, 50 or 25 cycles.

HANSEN

Manufacturing Co., Inc., Princeton, Ind. 47570

HANSEN REPRESENTATIVES: CAREY & ASSOCIATES, Houston and Dallas, Texas; R. S. HOPKINS CO., Sherman Oaks, Calif.; MELCHIOR ASSOCIATES, INC., San Carlos, Calif.; THE FROMM CO., Elmwood Park, Ill.; JOHN ORR ASSOCIATES, Grand Rapids, Mich.; H. C. JOHNSON AGENCY, INC., Rochester, N.Y.; WINSLOW ELECTRIC CO., Essex, Conn., Villanova, Pa., and New York, N.Y.

EXPORT DEPARTMENT: 2200 Shames Drive, Westbury, N.Y. 11590

INFORMATION RETRIEVAL NUMBER 28

SIDELIGHTS

Awards and their winners

Here they are—the winners of ELECTRONIC DESIGN's 1970 Top Ten contest, in which readers picked from the year's first issue the 10 ads they thought most likely to be remembered:

First prize—a trip to Europe for two: Sherman Bennett, EDO Commercial Corp., Melville, N. Y.

Second and third prizes—color TVs: Don Cordell, University of California, Los Angeles, and John M. Jansen, Burroughs Corp., Pasadena, Calif.

Fourth and fifth prizes—stereo receivers: D. W. Veder, Cohu Electronics, San Diego, Calif., and Paul C. Bunnell, Teledyne Ryan, San Diego.

The remaining seven prizes—Bulova Accutron watches—went, in the following order, to: Leo Zaretski, Control Data Corp., La Jolla, Calif.; Louis E. Frenzel, Jr., National Radio Institute, Washington, D. C.; Francis J. Welsh, NASA Manned Space Center, Houston, Tex.; Lee S. Apple, General Electric Co., Philadelphia; David Rosenquist, Bendix Corp., North Hollywood, Calif.; Warren E. White, Lawrence Radiation Lab, Livermore, Calif.; and D. G. Greenly, HRB Singer Inc., State College, Pa.

And in this corner--

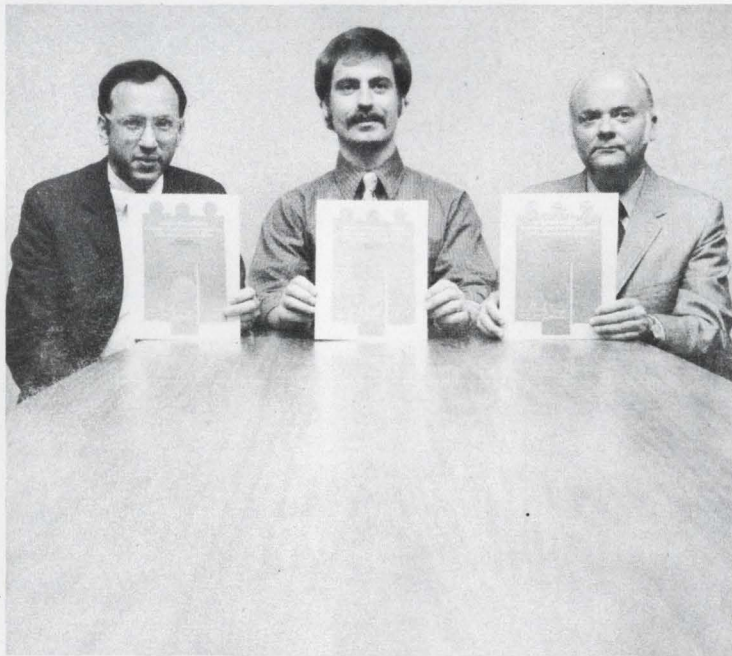

Art Director Cliff Gardiner, flanked by News Editor Jack Kessler, left, and Military-Aerospace Editor John Mason, hold up two awards of excellence and an award of distinctive merit given to ELECTRONIC DESIGN by the Society of Publication Designers. The awards were for a cover (ED 25, Dec. 6, 1969), illustrating Kessler's story on display components; a cover by Art Sudduth, free-lance artist, for ED 6, March 15, 1969; and Mason's photo for his story on electronics in Korea (ED 10, May 10, 1969).



**Leave my power supply system alone!
You can get your own in only 9 days from Acopian.**

"I tried struggling through that old power supply system catalog. It was like a jigsaw puzzle, hunting for the pieces I needed for my new power system. There had to be a better way.

"Then I remembered the Acopian hotline. I called it. I told them the DC voltages and currents I wanted. Discussed panel size. Meters. Switches. And other accessories.

"They gave me a firm price. Right on the phone. It was a lot less than I expected. I had our buyer phone in the P.O. And Acopian designed,

built, tested and shipped it in nine days. Completely wired.

"So go order your own Acopian power system . . . It's easy!"

**HOW TO ORDER
ACOPIAN POWER SYSTEMS**

- Call Acopian collect
- Tell us the outputs and accessories you need
- Get a firm price
- Shipment of completely wired system will be made in 9 days.

For immediate service, call the Acopian hotline: (215) 258-5441. For literature, write Acopian Corp., Easton, Pa. 18042. And remember, Acopian also offers 82,000 different DC power modules, every one shipped with this tag . . .



1,000,000 pf

(1.0 μ f)

... initial quantities available for immediate delivery from distributors and factory

NOW! Vitramon, Inc., originator of the monolithic capacitor, has QPL to MIL-C-11015/19 on CK06 Capacitors from 1200pf to 1,000,000pf (1.0 μ f).

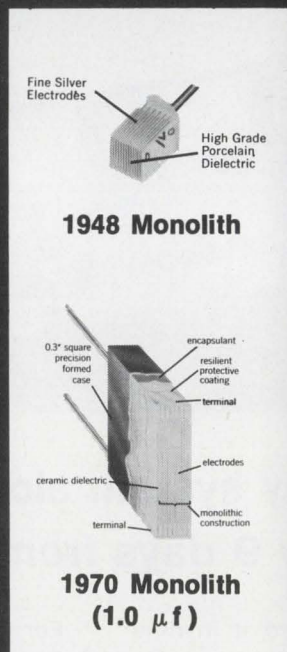

- Our encapsulation process insures utmost capability to withstand extreme environmental conditions
- "VK" commercial equivalents also available
- For complete technical information and name of your local stocking Distributor CALL THESE TOLL FREE NUMBERS DURING BUSINESS HOURS —

Special Connecticut Number: (800) 972-9976
From any other state in U.S.A.: (800) 243-9870

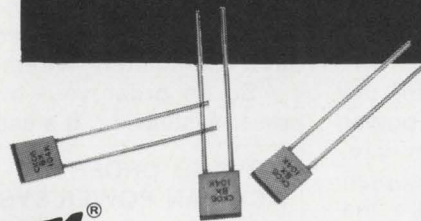

Vitramon[®]

VITRAMON, INCORPORATED
BOX 544
BRIDGEPORT, CONNECTICUT 06601

INFORMATION RETRIEVAL NUMBER 30

FOR LEACH CORPORATION REGIONAL INSERT, CIRCLE 247 ►

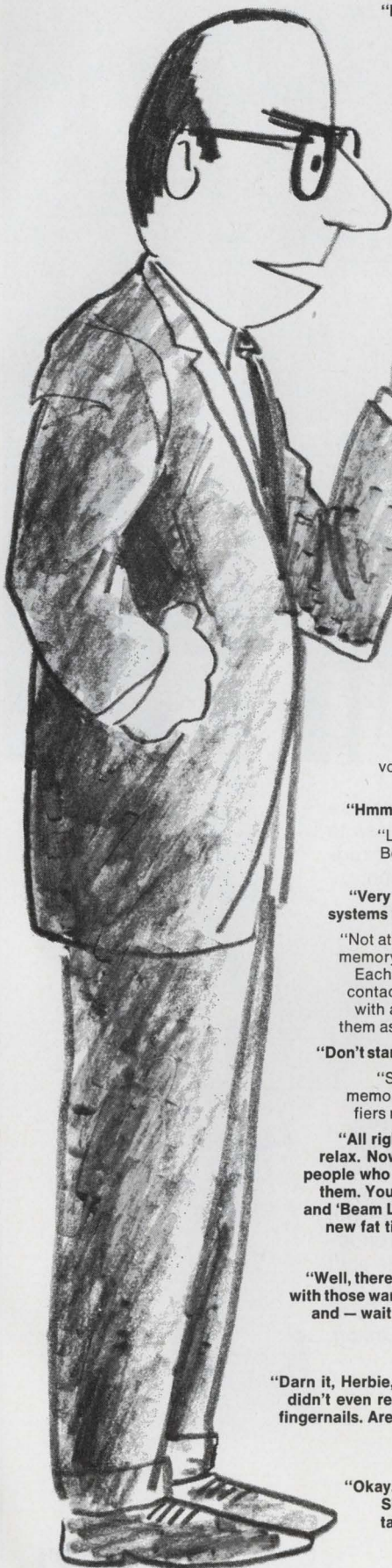

"I don't want my mind jangled, boggled or bugged with another fairy tale about semiconductor memories."

"If you're busy, perhaps I can see you later?"

"Not if I see you first. You semiconductor guys are all alike. Always yelling about multi-million bit capacity and speeds like forty nanoseconds. And you throw in fancy terms like 'glassivation.'"

"Well, yes, but our..."

"Please stop cracking your knuckles. Anyway, I can always stop you semiconductor memory people by asking about cost. You guys must think all of us equipment manufacturers are non-profit corporations."

"No, we really have a very nominal..."

"Do you have to twitch like that all the time? Look, as far as I'm concerned, I don't need those multi-million bit storage capacities, I don't need those fast-as-light speeds — and I certainly don't need the added costs. On your way out ask my secretary to bring me some fresh coffee."

"Sir, We're modestly talking about our line of RAM systems in the modest size range of 1024 bits to 9216 bits. And we modestly claim access and cycle times in the 200 nanosecond range."

"Well, at least that puts you in our ballpark. But then there'd still be complete system redesign because of your AC operation and — your dandruff is messing up my desk blotter."

"Beg pardon, sir. But our systems are a TTL type of design with a single DC clock control. The inputs and outputs are specified at the same current and voltage levels as TTL/DTL logic. And because they operate from plus and minus five volt power supplies, they eliminate the need for additional power sources."

"Hmmm. How about power consumption?"

"Less than twenty percent of comparable core systems. Because of our unique cell design, power consumption in a 1024 x 8 system is 645 microwatts per bit."

"Very interesting. But I suppose these are complicated systems that have to be custom tailored to..."

"Not at all, sir. Each system is based on the same standard memory module and the same standard support module. Each is supplied on a printed circuit card with a sixty-contact plug-in connector. You can build larger systems with appropriate interconnections. We like to think of them as the Systems That Behave Like Components!"

"Don't start getting cute with me."

"Sorry. Got carried away. Anyway, each system contains a memory address register, decoding, and the read/write amplifiers needed for complete memory system functions, and..."

"All right. Get your foot out of my wastebasket and relax. Now, who are you guys anyway? I know all the people who build ferrite core memories. I'm comfy with them. You guys run in here yelling things like 'Flip Chip' and 'Beam Lead' and 'MOS.' And you all wear those new fat ties. Can you deliver?"

"Come on, Melvin. Let's quit kidding. Don't you know me?"

"Well, there is something familiar about you, yes. But with those war surplus goggles and the long sideburns, and — wait a minute. You can't be..."

"Of course. I'm Herbie. Your friendly sales engineer from Electronic Memories."

"Darn it, Herbie, you shouldn't disguise yourself like this. I didn't even recognize you without ferrite cores under your fingernails. Are you guys making semiconductor memories?"

"In a way. Semiconductor Electronic Memories, Inc. — SEMI for short — is our affiliate company."

"Okay. Now that explains why your pitch sounds so practical. Show me those data sheets again. And, Herbie, take your elbow out of my ashtay."

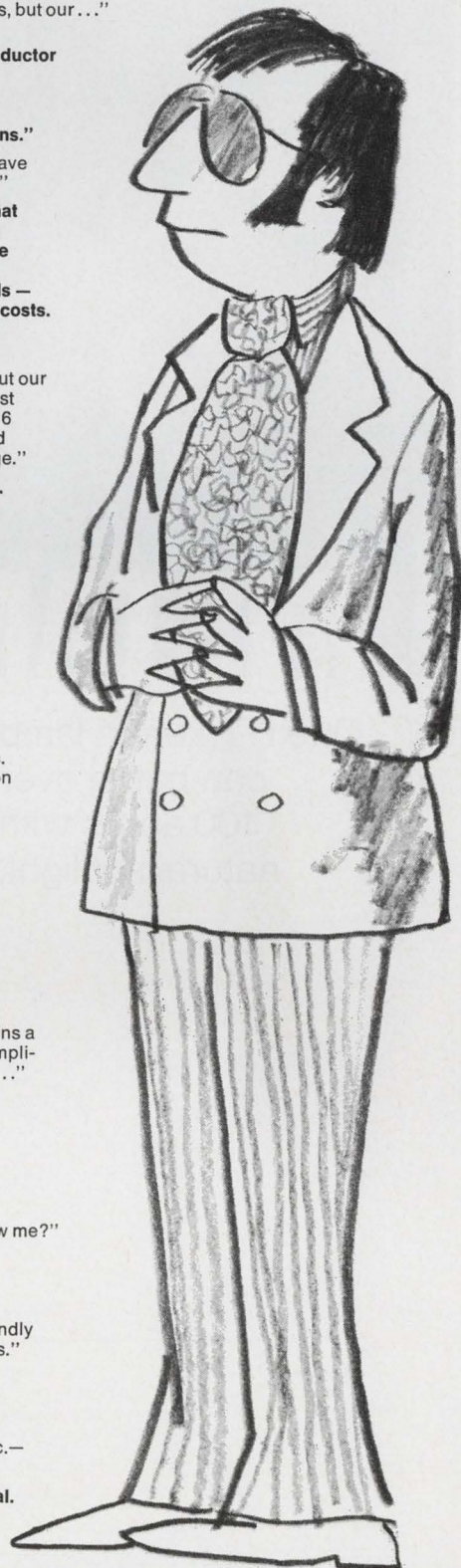

SEMI semiconductor electronic memories, inc.
an affiliate of Electronic Memories & Magnetics Corporation
3883 No. 28th Ave., Phoenix, Ariz. 85017. Phone (602) 263-0202

Write for our complete data on the new RAM series. Or call your local EM sales office. Before you forget.



INSTANT NOON!

One ITT xenon lamp
can bathe over
100 acres with
natural sunlight.

Here from ITT is a small, lightweight source of high-intensity light, remarkably close to the spectrum of natural daylight, and rugged enough to be mounted on a cannon.

We have xenon lamps that deliver over 800,000 lumens... for brightening ballfields or battlefields. We have smaller versions for use with standard theatre projectors that throw a much sharper and brighter picture than the obsolescent carbon-arc, and without the uncomfortable heat and hazard.

Made with the same techniques used for the fabrication and testing of high-quality vacuum and gas tubes, our xenon lamps contain almost none of the impurities that cause envelope blackening with age. As a result, there is no gradual reduction in light output, and no perceptible shift in color quality. ITT Electron Tube Division, International Telephone and Telegraph Corporation, P.O. Box 100, Easton, Pa. 18042.



ELECTRON TUBE DIVISION **ITT**



MIDNIGHT

It's brighter
than you think!

Even on the darkest night, an ITT image intensifier can deliver a clear view of important nocturnal events. Some of these devices provide luminous gains to over 35,000. Diameters range from 25 mm, to 40 mm, to 80 mm. Our 144 mm intensifier will see more than a gaggle of owls. Available in one, two, or three-stage configurations with your choice of phosphor and input window. For multi-stage units, integral voltage-divider power supplies may be optioned.

If you are putting together a night surveillance package, we can provide a wide range of highly efficient eyes . . . eyes that never blink . . . retinas that see red everywhere . . . all spectral sensitivities.

Our engineering services can also accommodate your *unique* requirements with customized designs. ITT Electron Tube Division, International Telephone and Telegraph Corporation, P.O. Box 100, Easton, Pa. 18042.



ELECTRON TUBE DIVISION **ITT**

Two simple facts make this diode the best current-controlled resistor you can buy.

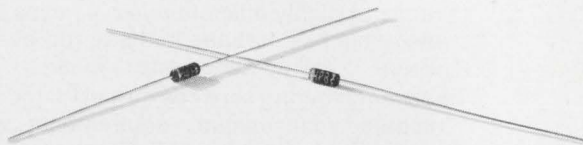

Performance. HP's PIN diode offers better cross-modulation and second order distortion performance than FETs or other conventional techniques. Our current-controlled resistors have an effective minority carrier lifetime of $1.3 \mu\text{s}$ with extremely low distortion over the 1 MHz to 1 GHz range. They also have tight resistance tracking between units, and the RF resistance limits are fully specified.

Price. You get all this for 99¢ each in 10,000 lots, the lowest priced PIN diode anywhere! Even lower costs in larger quantities. Which now moves true high performance within the price range of low-frequency designers.

Before you design your next equipment with current-controlled attenuators, constant-impedance AGC,

levelling and switching circuits, talk to us about specs and prices and immediate delivery on the 5082-3080 PIN diodes.

HEWLETT  PACKARD
SOLID STATE DEVICES

01009



Our MD 200 is the finest MOS/LSI tester available!

"We have the capability of conducting on-wafer tests, both digital functional and parameter, at speeds to 2MHz . . . prior to packaging. The MD200 is able to do this because the analysis is done at the probe head, not in a computer 30-50 feet away. With as many as 16 stations of 64 probe pins controlled by a single computer, we've had to automate everything . . . including mechanical functions such as probe down sensing, off-wafer detection and inking; making our MD200 the fastest fully-automated system available.

"To simplify programming, and significantly reduce test time, we've created TOIL (Test-Oriented, Interactive Language). Included in TOIL are all the necessary parameter and functional tests to evaluate both the logic and the circuits on the wafer. Most importantly, programming is reduced to a series of questions and answers.

Therefore, minimal training of personnel is required.

"Macrodata's MD200 has the capability of performing a detailed analysis of your complete MOS/LSI design and production cycle . . . based on factual test results. Additionally, we've included a complete complement of test aids . . . test generation programs, and yield evaluation mapping programs, to reduce total test and evaluation time.

"The MD200 is available now. We'll be delighted to demonstrate it for you. Or write for our 16 page brochure describing Macrodata's MD200 Diagnostic Test System in detail."

Dr. William C. W. Mow
President
Macrodata Company

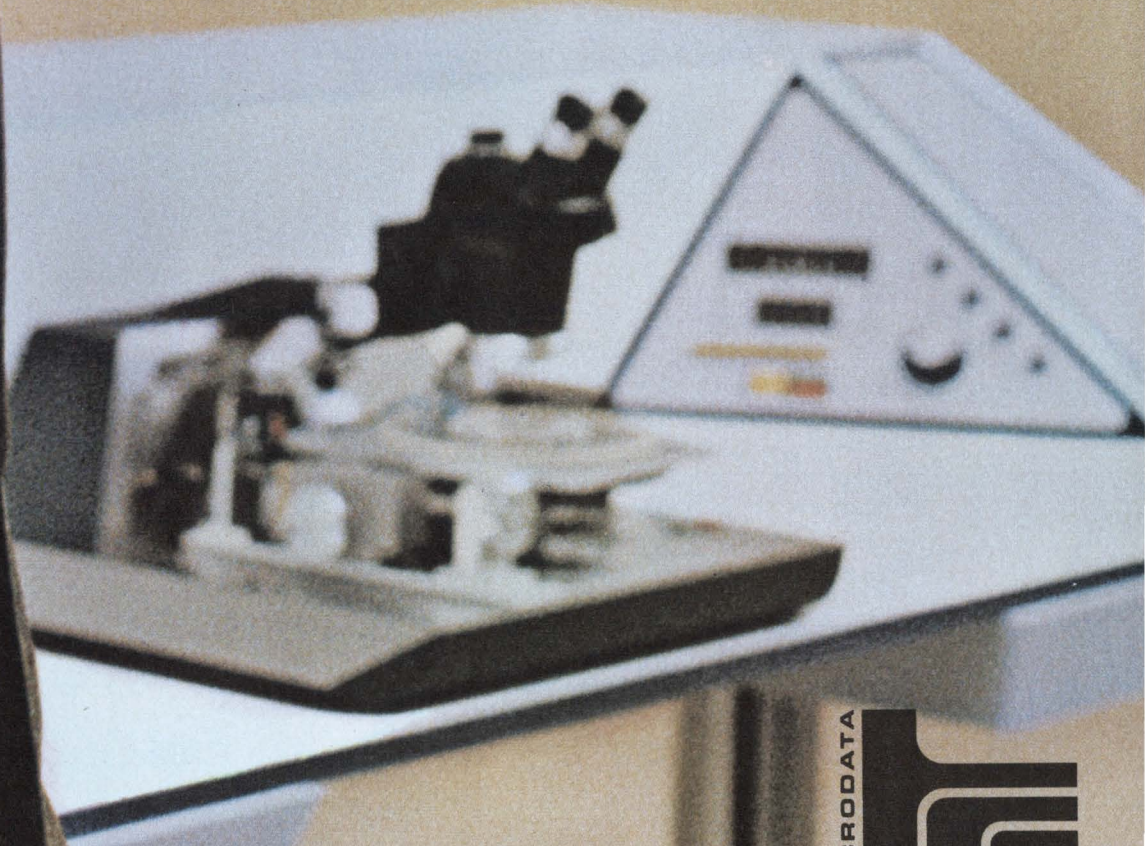

Macrodata Company Test Systems Division
20440 Corisco Street, Chatsworth, California 91311



There are important reasons why users of rectifier stacks buy from Tung-Sol®

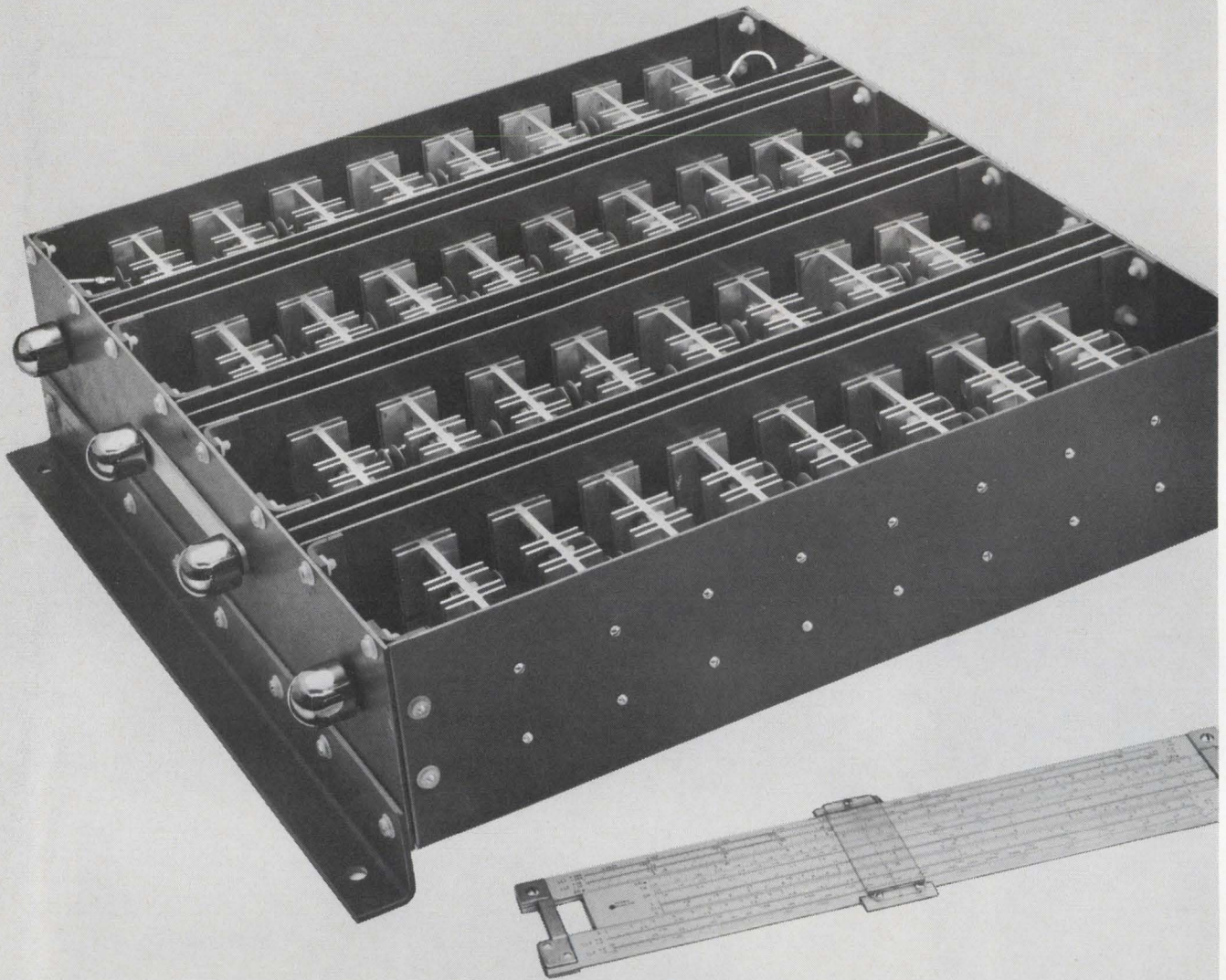

Have you had to make space and mounting concessions... more than you'd like to? Are you re-evaluating your rectifier stack requirements? Then you may want to hear more about what Tung-Sol has to say.

Tung-Sol modular stack construction combines precise ratings in packages that conserve space, minimize weight... and does it at low cost.

Even if you build your own stacks, we are certain that we can demonstrate worth-while savings in labor, materials and testing. Our guarantee eliminates your reject expense and deliveries can be scheduled to reduce your inventory and storage costs.

One of our most important services is free. Describe your rectifier stack requirements and we'll give you a completely detailed proposal — no charge.

Most of our customers started by taking us up on this offer.

TUNG-SOL DIVISION / Wagner Electric Corporation

630 W. Mt. Pleasant Avenue, Livingston, N.J. 07039
TWX: 710-994-4865 / Phone: (201) 992-1100; (212) 732-5426

Trademark TUNG-SOL Reg. U. S. Pat. Off. and Marcas Registradas

The new Fluke 893A will retire lots of good old Fluke voltmeters.

They won't be the only ones to go!

All kinds of differential voltmeters are likely to find quick retirement when you check out the new solid state Fluke Model 893A AC/DC Differential Voltmeter. Here's a low cost differential voltmeter with infinite resistance at null to 1100 volts, dc accuracy of 0.01%, ac accuracy of 0.05%, and integral battery pack operation.

Available in both half and full rack models, price is \$1045 for either. Battery operation can be added at any time for only \$100. Grounded recorder output is available for \$50 more.

Ranges are 1, 10, 100, and 1000 volts ac and dc with 10% overranging. Resolution is 1 ppm of range. Reference regulation is the best available. Reference stability is 15 ppm/hr.

Using the instrument in the battery mode assures portability and complete isolation from the effects of power line interference. In the ac mode, the useful frequency range is 5 Hz to 100 KHz with a 1 mv accuracy. In the TVM mode, input resistance is 100 megohms, so you get the same advantages of low source loading as with older vacuum tube differentials.

Other user features include large, in-line readout with 360° rotation of voltage dials, virtual immunity to damage by accidental overload, and automatic decimal switching with range.

Ready to make the change?

We'd like to help. Your friendly Fluke sales engineer (listed in EEM and EBG) has all the facts as well as demo equipment. Call him or contact us directly if it's more convenient.

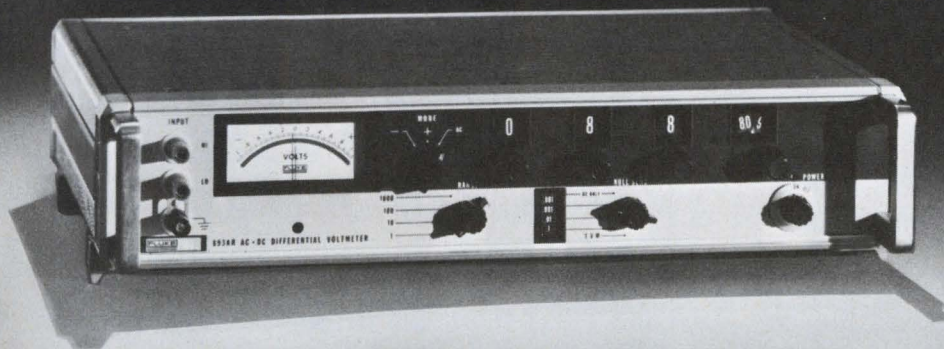

Fluke, Box 7428, Seattle, Washington 98133. Phone: (206) 774-2211.
TWX: 910-449-2950.

In Europe, address Fluke Nederland (N.V.), P. O. Box 5063, Tilburg, Holland.
Telex: 884-50237. In the U.K., address Fluke International Corp., Garnett Close,
Watford, WD2 4TT, England, Phone: Watford 27769. Telex: 934533.



Operational Amplifiers with Matchless Performance

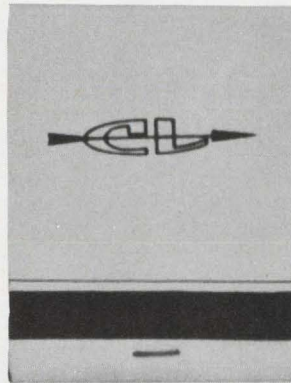

If settling time is important, specify FS-125

The Model FS-125 is designed for fast settling (**maximum 80 ns to 0.1% final value**) on step function signals but does not sacrifice low drift operation. It can be calibrated with dc and remain within 0.1% up to 12 MHz. This makes it an ideal choice for sample-and-holds, A/D's, D/A's, comparators, and similar "time domain" applications.

If gain bandwidth is important, specify OA-125

The Model OA-125 has a 6 dB/octave roll-off which gives it the widest bandwidth of any unconditionally stable amplifier available. **No compensating networks are required.** This makes it an ideal choice for active filters, video amplifiers, and similar "frequency domain" applications.

	FS-125	OA-125	
INPUT: Single ended	✓	✓	
VOLTAGE GAIN (Open loop)	100,000	100,000	
INPUT IMPEDANCE	10	5	K ohms
INPUT OFFSET VOLTAGE	3.5	3.0	mV
SLEW RATE	250	180	V/us
SMALL SIGNAL BANDWIDTH (Gain=1)	30	100	MHz
RISETIME (Gain=1)	15	17	ns
OUTPUT VOLTAGE (100-ohm load)	+2.4 -2.2	+2.4 -2.2	volts
SUPPLY REQUIREMENTS: ±15V ±3%	✓	✓	
PRICE (small lot)	\$97.00	\$135.00	

Analog Multiplexers / Analog-to-Digital Converters / Digital-to-Analog Converters / Operational Amplifiers

COMPUTER LABS
for tomorrow's technology today

1109 South Chapman St. / Greensboro, N. C. 27403 / (919) 292-6427 / TWX 510 922-7954

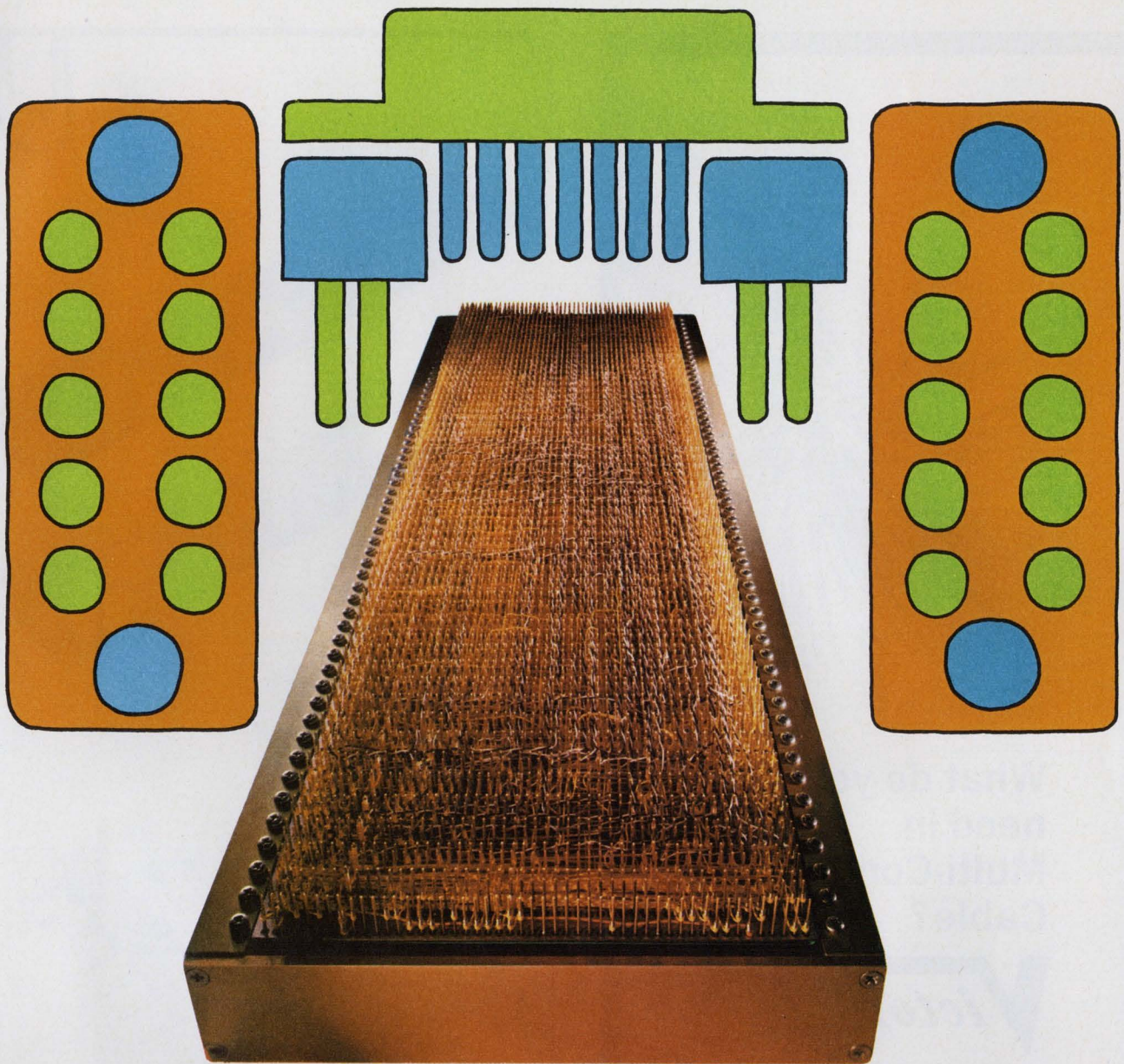

Winchester Electronics

— their obsession with precision is solving tomorrow's problems today.

Problems—like connectors requiring post true positioning to within a mere .020 of an inch—won't stump Winchester Electronics. They've been making AccurFrame® as close to perfection as modern wire terminating machines demand.

And this fact proves the point: Of the various types of wire terminating connectors, only the HW Series by Winchester Electronics, positioned in AccurFrame,

consistently meets the contact true position tolerances required by automatic wire terminating machines.

Now, if that doesn't say something for Winchester Electronics' AccurFrame, perhaps you have a connector requirement that does. Want to take us up on it? Write or call Winchester Electronics, Main Street and Hillside Avenue, Oakville, Conn. 06779.



**WINCHESTER
ELECTRONICS**

DIVISION OF LITTON INDUSTRIES



INFORMATION RETRIEVAL NUMBER 39

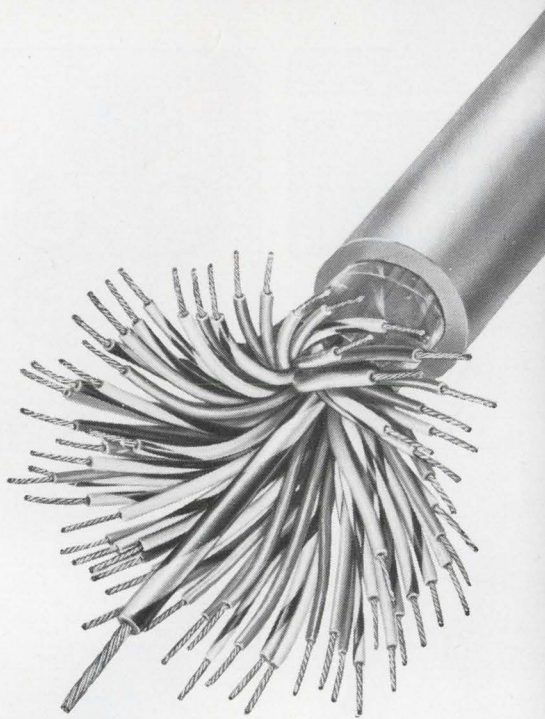

**What do you
need in
Multi-Conductor
Cable?**

Victor

will make it.

Get exactly what you need in multi-conductor cable. We'll design and produce multi-conductor cable to meet just about any individual requirement.

We have the plant, the equipment, the personnel and the know-how to solve your particular problem.

Victor
Electric Wire & Cable Corp.
WEST WARWICK, RHODE ISLAND

INFORMATION RETRIEVAL NUMBER 40

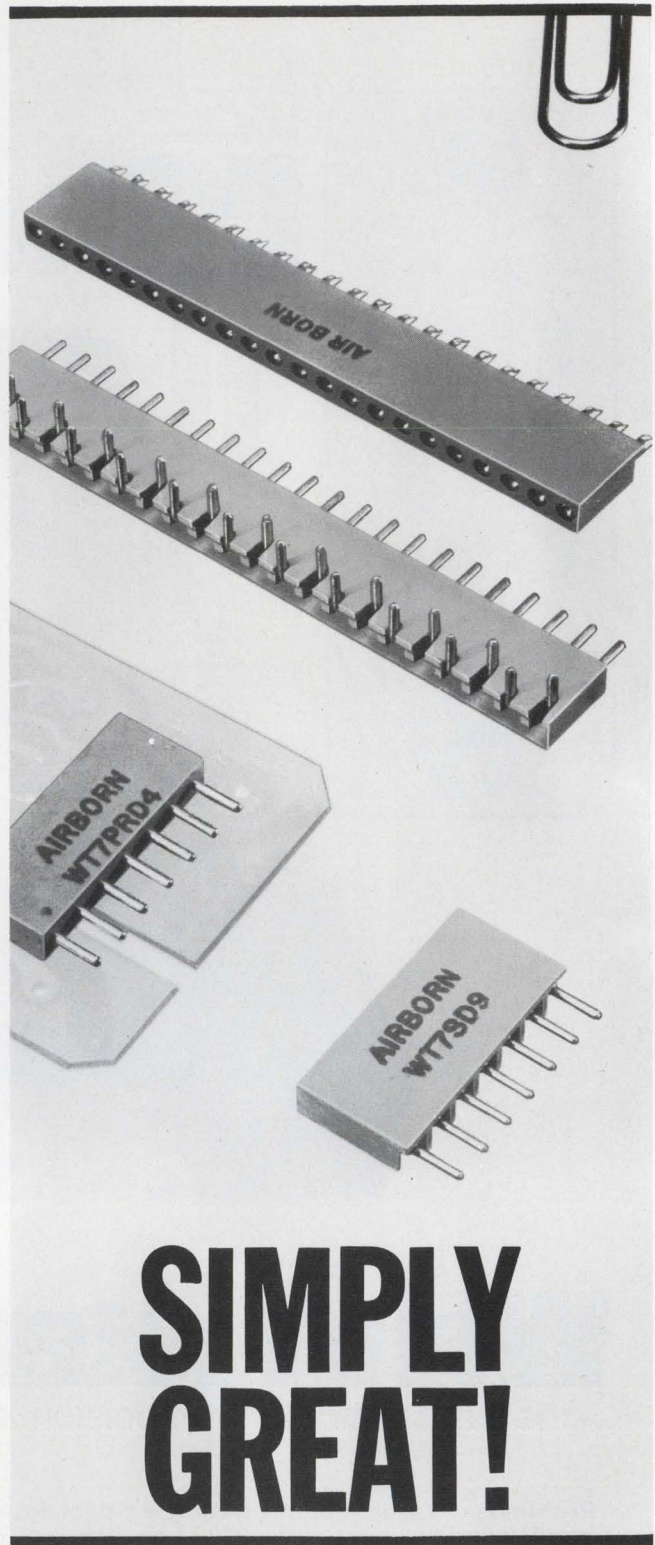

**SIMPLY
GREAT!**

Their simple design is what makes them so GREAT! AirBorn's new WT connector series features rugged, right-angle or straight through contacts .030 dia. for printed circuit or subminiature applications.

Available in 22 sizes — 1 through 22.

For literature, call 214-357-0274 or write 2618 Manana Drive, Dallas, Texas 75220.

AirBorn, Inc.

INFORMATION RETRIEVAL NUMBER 41

SPERRY HAS A COUPLE OF LASER SURPRISES:

**LOWER CURRENT AT
LOWER PRICES.**

**THE HIGHEST
POWER DENSITY
AVAILABLE.**



GAAs LASER DIODES

New, smaller, stud-mounted single diodes, and higher-power arrays in dual and radial configurations. All are manufactured with the new low threshold process and emit at 9,000 Å. Send for data sheet—Electro-Optics, Sperry Gyroscope Division, Great Neck, N.Y. 11020; Telephone (516) 574-2598.

PERFORMANCE CHARACTERISTICS

MODEL #	PEAK POWER WATTS	PEAK CURRENT AMPS.	SOURCE SIZE MILS
003-SC*	3	10	3
008-SC	8	25	6
013-SC	13	40	9
023-SC	23	75	15
040-DC	40	75	15 x 15
100-RC	100	40	45 DIAM.
150-RC	150	75	55 DIAM.
200-RC	200	75	55 DIAM.
500-FC*	500	75	—
1,000-FC*	1,000	75	—

* Available in late summer, 1970

SPERRY
GYROSCOPE DIVISION
ELECTRO-OPTICS

 **SPERRY RAND**



Their "T"... \$850

Suddenly, "Model T's" are in again... the solid-state Invertron "T" Series, brand new AC Power Sources for the '70's.

Latest of the new T's is Model 101T ... a 100 VA unit providing 0 to 135 volts RMS over a 45 Hz to 10 KHz range.

That means you no longer have to over-buy ... *don't have to pay for 200 VA* when you'll never need more than 100 VA. An overload circuit protects against either

excessive load current or poor load power factor, with *automatic reset* when overload is removed. Available plug-in oscillators cover about every situation known, and units can be stacked for 2 ϕ and 3 ϕ power. **Why buy more power than you need, when the 101T does the job for just \$495?**

3511 Midway Drive, San Diego, California 92110. Phone (714) 224-3241.

CALIFORNIA INSTRUMENTS COMPANY

behlman
division

a division of
AIKEN INDUSTRIES, INC

Our "T"... \$495

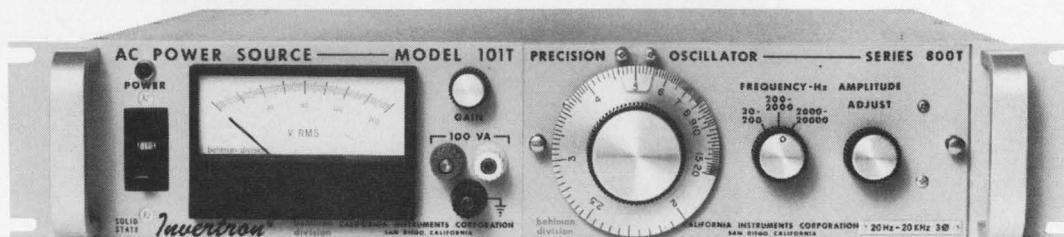

(The rest of our Model T's? All the way to 10 KVA ...
1 ϕ , 2 ϕ or 3 ϕ ... frequency stabilities to 0.0001%.
You can have any color as long as it's CALICO gray!)

SOLID STATE Invertron®

Booths 225-226 

THE WORLD OF ENCLOSURES



EMCOR
BY PROFESSIONALS
FOR PROFESSIONALS

satisfy your enclosure needs with EMCOR

Fitting your design into an EMCOR Enclosure is easy. You can select from hundreds of models and a wide choice of colors and configurations to meet your design and packaging needs . . . exactly. With our capabilities, we can guarantee that you get the enclosure that best solves your problems. ■ And when your design goes into production, EMCOR's manufacturing ability can match your schedules to give you maximum flexibility and economy. ■ So why not explore our world?

Ingersoll Products 1221 W. 120th St., Chicago, Ill. 60643 DIVISION OF BORG-WARNER CORPORATION



INFORMATION RETRIEVAL NUMBER 44

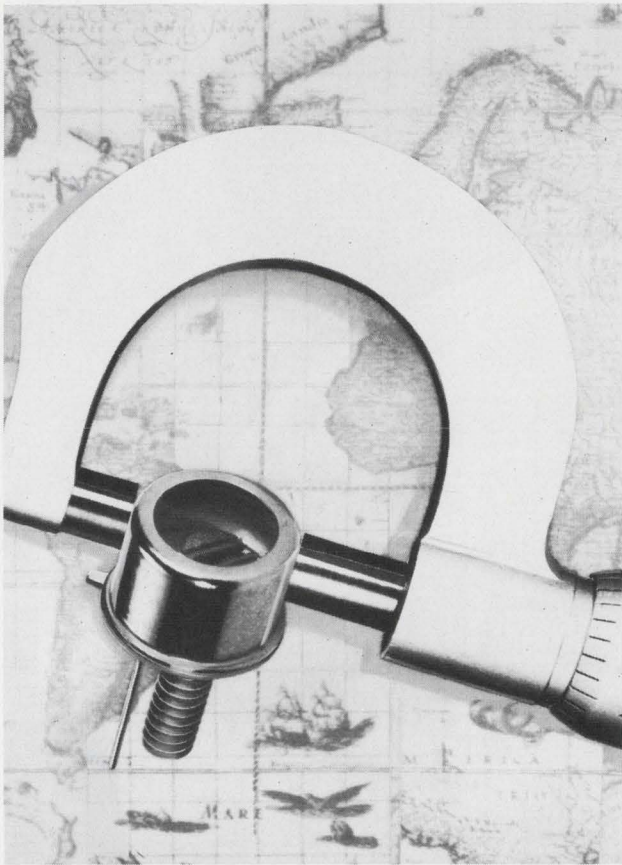

A PRECISION-MINDED WORLD BUYS LDL's GaAs DIODES

Our basic product is low cost, single-element, plastic-encased gallium arsenide injection lasers. Units are available which incorporate homostructure material or the recently developed heterostructure.

Our standard product is designed for room temperature pulsed operation—custom units for cryogenic operation are also available. Other special designs include high efficiency devices with reflective coatings and units enclosed in hermetically sealed packages.

Whether your requirement is for low cost standard products or for a custom design, a call to LDL brings you a top quality answer to your problem—on the run! **For Application Information Call (201) 549-7700**

- GaAs Bulk Crystal
- GaAs Epitaxial Wafers
- Single Element Laser Diodes
- Laser Diode Arrays
- Laser Diode Pulsers and Supplies
- GaAs Systems

LASER  **DIODE**
LABORATORIES, INC.
205 Forrest Street, Metuchen, New Jersey 08840
A Subsidiary of The United Corporation

INFORMATION RETRIEVAL NUMBER 45

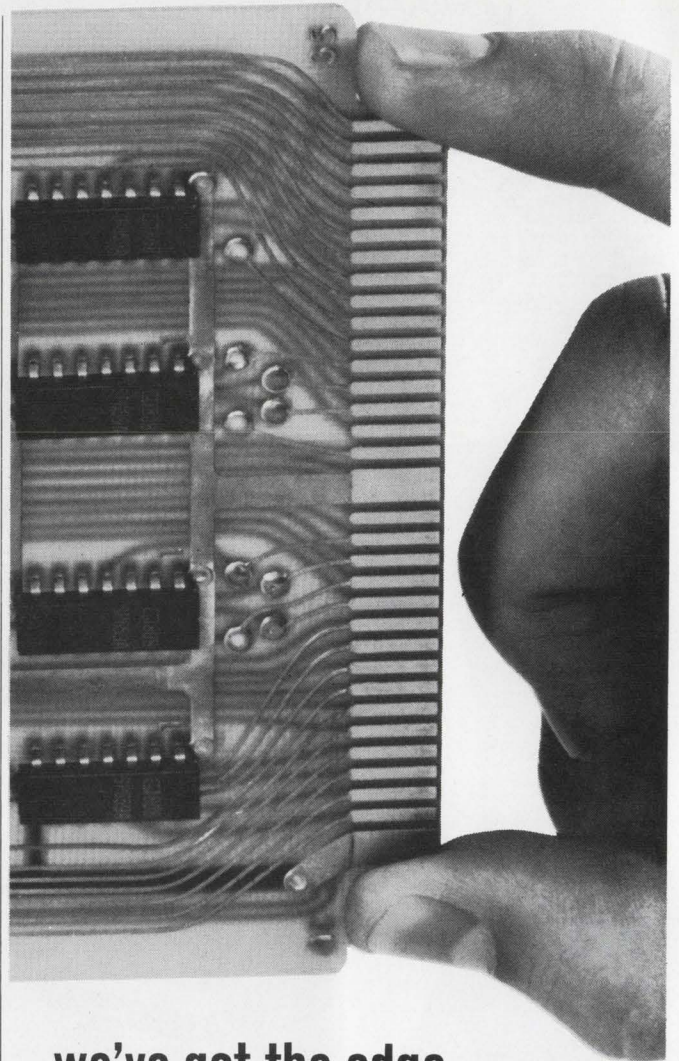

we've got the edge on our logic competition

And it starts with the 70 connection edge of all our logic assemblies. Our design brings more digital functions to the outside world, puts more functions on a card. And the trend toward more complex functions and large scale integration won't obsolete our design—in fact, we're helping make it possible.

Get an edge on your competition, choose from the industry's widest range of logic assemblies—DTL for moderate speeds, TTL for high frequencies, and MSI for low cost through better packaging.

In the Cambion line, you'll find all the logic cards you'd expect to need plus those one-of-a-kind required to complete your system without having to develop the card yourself. You'll also find all the necessary accessories, connectors, card drawers and files and power supplies. In fact, you can start your system design at any level and gain a competitive edge with Cambion logic assemblies and accessories. We've got a manual full of them we'll be glad to send you. Just send us your name. Do it today. Cambridge Thermionic Corporation, 445 Concord Avenue, Cambridge, Mass. 02138.

Standardize on

CAMBION[®]
The Guaranteed Logic Assemblies

INFORMATION RETRIEVAL NUMBER 46

ELECTRONIC DESIGN 13, June 21, 1970



You can increase product yield today... ask about the performance of the SPC-16 industrial automation computer.

SPC-16 gives you big computing power, accuracy, reliability and programming simplicity . . . It's specially designed to work in industrial environments.

You can reduce your operating costs, increase the yield of better quality products . . . you can get your products to the market faster. And you can serve more markets with new levels of reliability.

And the SPC-16 is supported by expert consultation, systems engineering, programming and customer training services.

If you make, move, test or count, SPC-16 is your automation worker . . . ask about its performance today.

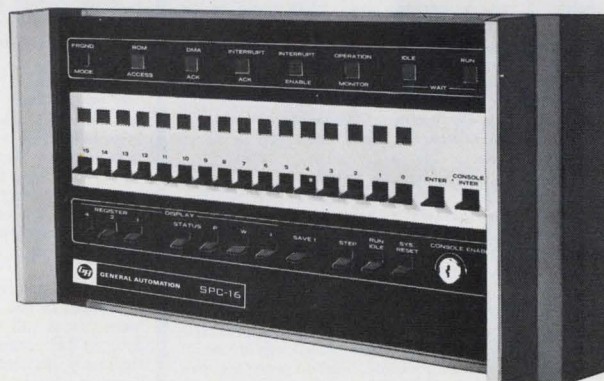

Ask about other low-cost computers in the GA family. The SPC-12 for less than \$5000. System 18/30 for under \$20,000.



GENERAL AUTOMATION, INC.

1402 East Chestnut, Santa Ana, California 92701
(714) 835-4804 TWX (910) 595-1780

CALIFORNIA
Los Altos, (415) 941-5966
Orange, (714) 633-0680

TEXAS
Dallas, (214) 358-0271
Houston, (713) 774-8716

ILLINOIS
Des Plaines, (312) 298-4650
(California G.A. Corp.)

OHIO
Cleveland, (216) 351-2275

GEORGIA
Atlanta, (404) 261-6203

PENNSYLVANIA
King of Prussia, (215) 265-6525

MARYLAND
Silver Spring, (301) 587-7090

CONNECTICUT
Stamford, (203) 325-3883

MASSACHUSETTS
Waltham, (617) 899-6170

INTERNATIONAL
BELGIUM
G.A.I. 24 Blvd. de l'Empereur
Brussels, 13 78 03

ENGLAND
G.A. Ltd. Wren House
Portsmouth Road, Esher, Surrey
Esher 65764

GERMANY
ERA-Elektronische Rechenanlagen
51 Aachen, Postfach 465
Werk: Verlautenheide
Lindenweg 23
02405-4444

G.A. GmbH
6200 Wiesbaden
Frauenlobstr. 9
06121-83073

INFORMATION RETRIEVAL NUMBER 47

The message of the 70s is . . .

CHANGE OR DIE!

Starting now - for \$25 - Innovation will help you stay alert to the message of the 1970s

Innovation is a magazine. It's a year and a half old.

Innovation is addressed to managers — to those men who run the organizations which keep our society functioning — the companies, government agencies, universities, associations, institutes, all of them.

Innovation is addressed particularly to those managers who realize they are living in revolutionary times, and . . .

Innovation believes that technology — advanced, fast-changing technology — is central to our times. It is for readers who share that belief.

Innovation every issue will expose you to a unique picture of what is happening to your working environment. You will read about the most powerful of the new management techniques. You will encounter the best thinking on how to make things happen in your new ever-changing environment.

Let's be specific. Here is a sampling of material which is in the works right now.

— Every manager has a magical promise dangled in front of him these days. The **Management Information System** is supposed to provide some sort of mechanized computer-based arrangement to put the information about his business at his fingertips, to analyze it maybe, perhaps even make some of his decisions. It's a tempting prospect. But there are lots of different approaches, and Prof. Richard Mason of UCLA is lining them up for us. Each one of them, he finds, commits you to specific assumptions about the kind of managing you intend to do; the wrong assumptions could bed your whole organization in concrete. Don't make a move until you've heard what Mason has to say.

— Safest approach may be to grow your Management Information system from within, step by step. Vice President Tom McGrath of **Avon Products** has consented to tell our readers how he did just that, the traps he almost fell into, the escapes he managed.

— One significant fact about the **auto industry** is that, for excellent reasons, it is just about the slowest-changing, most momentum-bound industry anywhere and the one least accustomed to outside pressure. Another fact is that air pollution has made it one of the first industries to collide head-on with the new demands of the 1970s. Innovation editors have been exploring the resultant mis-mash of political infighting, good engineering, self-righteous rhetoric, cost adjustments, and hurt feelings. Your own organization, whatever it is, is all but certain to encounter some similar clash. Our article will prescribe no morals — but you'll easily read the application to your own situation.

— Arthur Barber is a man who has had to think a lot about the world-wide impact of technology: he headed the arms control section of the Defense Department and is president of the Institute for Political Planning. One of the things he sees ahead is the emergence of a new kind of corporate organization he calls **transnational**, forced by its own tech-

nology to break free of any national home, dealing, almost as an equal, with all national governments. He develops his idea in a forthcoming article.

— The growth of Fairchild Semiconductor is one of the spectacular stories of the 1950s and 1960s. It was **Robert Noyce**, most people say, who set the technical patterns for Fairchild. Now Noyce and Gordon Moore have started a new semiconductor company, Intel, and most people think he's aiming to repeat the story. But this time he is making the effort in a different world, the world of the 1970s. INNOVATION editors are finding out how that will change his style, his approach. In their article you'll learn something about the emerging management style of a new decade.

— We all agree we've got to stop polluting the environment. So what's the problem? A symposium of scientists eager to apply their knowledge tell Innovation they found government agencies unready to tackle new responsibilities. That's one difficulty. In another article, another scientist tells of finding industries that rush enthusiastically ahead doing more harm than good — because they don't understand the science behind pollution.

— Why on earth should it take ten years, sometimes, to get a technical idea into practical use? The originator of one truly brilliant device in one of the country's outstanding labs is working on an article about the unbelievable sequence of events that have tied up years, literally, in **getting onto the market**.

— A working forecaster is doing an article which will evaluate current practices in the fashionable art of **technological forecasting**. Great for the military, he says. All right elsewhere if you don't take it too seriously.

— Just what is this business of **systems thinking** that people keep talking about? A man who does it for a living is readying one of the few clear descriptions around — and suggests that it just might work in more fields than the military and the utilities.

— As one new technology after another creates a new industry, each one seems to show its own growth pattern. In the **computer time-sharing** business, unlike some high technologies, it begins to look as if you have to be at least a little bit big to survive.

These are subjects important to any alert manager. **Innovation** is not a collection of tidbits, and each of these pieces will come to you as a major article — about a half dozen articles per issue. Each will be vigorously illustrated, often in full color.

Some of our articles are written by our large and experienced staff of editors. More often, an article emerges from long, close collaboration between an editor and a distinguished author — a working executive, perhaps, a student of business or a social scientist, a public figure. In either case the article has been edited to make the reading of it a pleasant as well as a useful experience.

Professional art directors rate **Innovation** among the handsomest magazines published in America. So that articles can run without interruption or interference, **Innovation** carries no advertising.

Fill out the coupon below or write to The Innovation Group and subscribe today — before it's too late — to **Innovation**.

Is **Innovation** a new magazine?

How come I haven't seen it around?
Who is behind it, anyway?

Innovation has been in publication for more than a year, but until now it has been circulated only to members of The Innovation Group, a limited organization made up primarily of executives directly concerned with the management of technological operations or heavily technical companies. The Group was created early in 1969 by Technology Communication, Inc. (publishers of **Innovation**) to conduct a program of professional education for managers concerned with technology. Besides **Innovation** the total Program includes Workshop/Conferences of Group members, management seminars conducted by authors of **Innovation** articles, publication and distribution of books, preparation of multimedia educational packages to be used in corporate management development, and other activities.

The program was formulated with the help of a distinguished Board of Advisors, consisting of: Warren G. Bennis, vice president, State University of N. Y. at Buffalo; Emilio Daddario, chairman, House Subcommittee on Science, Research and Development; Eugene G. Fubini, consultant to NASA, formerly vice president, IBM Corp., past Assistant Secretary of Defense and Deputy Director of Defense Research and Engineering; C. Lester Hogan, president, Fairchild Camera and Instrument Corp.; J. Herbert Hollomon, president, University of Oklahoma, formerly Assistant Secretary for Science and Technology, Department of Commerce; Warren Kraemer, president, Warren Kraemer Associates, Inc. management consultants; Donald G. Marquis, Sloan School of Management, MIT, director of Project on Research and Technology; Emmanuel G. Mesthene, Director, Harvard Program on Technology and Society; Jack Morton, vice president, Bell Telephone Laboratories; E. C. Williams, chief scientist, British Ministry of Technology.

A few weeks ago the Board of Advisors came to the conclusion that such material is so important that it should not be limited to members of The Innovation Group. **This is particularly the case, the Board felt, in a time of business stress, when the most effective possible management is of special importance to all companies.**

COUPON Special Introductory Rate

You're on!

enter my subscription to **Innovation** for the coming year (10 issues) at the special introductory rate of \$25 (regular rate \$35). I understand that I may cancel any time I have second thoughts and receive a pro rata refund.

Signature
 Payment enclosed Bill company Bill me

The Innovation Group
Suite 425
265 Madison Avenue
New York, N. Y. 10016

name _____

position/title _____

company name _____ division _____

company address _____ street or p.o. box _____

city _____ state _____ zip _____

check here if you want **Innovation** mailed to your home address below.

street or p.o. box _____

city _____ state _____ zip _____

INFORMATION RETRIEVAL NUMBER 135

FOR ACDC ELECTRONICS
REGIONAL INSERT, CIRCLE 248 ▶

The best power supply
for driving 5 volt IC's
is one specifically designed
for driving 5 volt IC's.

We make it.
We call it our
5 volt IC series.

(Catchy, isn't it?)

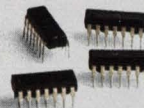

When you're designing a power supply to operate only at 5 volts, there are a lot of things you can do to make it better than "general purpose" power supplies.

You can start with size, and design a 2.0 amp unit that weighs a scant 4 pounds and measures only 5.0" x 2.5" x 4.38". (Incidentally, a 5" height dimension is standard on all IC series power supplies — 2 through 100 amps — making them all rack mountable.)

You can tackle performance and price next and offer 0.05% regulation and 71°C operation as standard and still offer a 2 amp unit for as little as \$89.00. Then, of course, you can build them by the hundreds to make them available for immediate delivery . . . anywhere.

Our new IC series is available from 2 amps to 100 amps with optional overvoltage protection in all ratings. Get one tomorrow . . . or ten . . . or a hundred. They're on the shelf.

acdc electronics inc.

Oceanside Industrial Center, Oceanside, California 92054, (714) 757-1880

IC 5V Power Supply Module for IC's / Specifications

Oceanside Industrial Center, Oceanside, California 92054, (714) 757-1880

acdc electronics, inc.

Nominal Output Voltage (VDC)	Output Voltage Range (VDC)	Maximum Current Rating (Amps)	Maximum Dimensions (inches)			Weight approx. (lbs.)	Case Size	Model (Add — 1 for Overvoltage Protection)	Price
			H	W	L				
5	4.75 to 5.25	2.0 @ 71°C 2.5 @ 55°C 2.7 @ 40°C	5.0	2.5	4.38	4	J1	IC5N2.7	98.00 Add \$20 for overvoltage protection
5	4.75 to 5.25	6.2 @ 71°C 8.0 @ 55°C 9.5 @ 40°C	5.0	5.0	5.0	7.5	L1	IC5N9.5	134.00 Add \$30 for overvoltage protection
5	4.75 to 5.25	9.2 @ 71°C 11.5 @ 55°C 13.5 @ 40°C	5.0	5.0	7.5	11	N1	IC5N13.5	186.00 Add \$30 for overvoltage protection
5	4.75 to 5.25	16.5 @ 71°C 21.5 @ 55°C 25.0 @ 40°C	5.0	5.0	11.0	19	P1	IC5N25	258.00 Add \$30 for overvoltage protection
5	4.75 to 5.75	50 @ 71°C 60 @ 55°C 70 @ 40°C	5.25	19.00	14.00	52	S1	IC5N70	529.00 Add \$60 for overvoltage protection
5	4.75 to 5.25	75 @ 71°C 90 @ 55°C 100 @ 40°C	5.25	19.00	21.00	83	S2	IC5N100	835.00 Add \$85 for overvoltage protection

Input	105-125VAC, 47-63Hz (usable also to 400Hz — consult acdc for derating). All models of 20A and greater are provided with a 105-125/210-250VAC input.
Output	Voltage range shown in table is continuously variable between limits by externally accessible screwdriver adjustment of multiturn pot. Output is floating — either positive or negative terminal may be grounded. Current: zero to full load as shown in tables.
Regulation	0.05% for line changes of 10%. 0.05% for NL to FL changes.
Ripple	2mV RMS and 20mV P-P max.
Stability	Typical 10mV for eight hour period after initial warmup.
Transient Response	Output voltage returns to within regulation limits within 50μsec in response to a 50% step change in load current.
Remote Sensing	Terminals are provided to maintain regulation at the load, compensating for the DC voltage drop in the load cable.
Remote Voltage Adjustment	Terminals are provided to adjust the output voltage by means of a remote variable resistor.
Ambient Temperature	Operating: Full rated output at operating temperatures of 0° to 71°C without forced air or heatsinking. Storage: —55°C to +85°C.
Mil Specs	The listed catalog models are constructed with the highest quality components and have MTBF ratings in the neighborhood of 50,000 hours per MIL-HDBK-217. acdc will also build supplies to meet specific MIL specs such as MIL-E-4158A, MIL-E-16400, MIL-T-21200, and meet environmental requirements such as MIL-E-5400, MIL-

	E-5272, MIL-E-4970, and RFI specs MIL-I-26600 and MIL-I-6181. acdc's own environmental laboratory is able to perform qualification testing when required and is used extensively to prove out designs. In order to provide the most efficient design, customer inquiries are invited, outlining exact specifications and environmental conditions required for the end product.
Weight	See table.
Mounting	Unit can be mounted in any position on either one of two sides. Mounting faces have threaded mounting holes.
Dimensions	H-W-L dimensions for individual models are given in the table.
Overload Protection	All models are inherently protected against overload and short circuits of any duration. No fuses or reset buttons are used — automatic recovery is electronically accomplished.
Overvoltage Protection (Optional)	Any model can be furnished with overvoltage protection which "crowbars" the output in the event of a rise in the output voltage of 10% or 2 volts (whichever is greater).
Connector	Barrier strip termination.
Construction	Modules are constructed of heavy gage aluminum with integral extruded heatsinks; color is black. Removable covers of perforated steel have a light gold enamel finish. Regulating circuitry is mounted on a PC board.
Output Impedance	DC — 1KHz 0.001 R _L or 0.005 ohm max. 1-100KHz 0.005 R _L or 0.3 ohm max (whichever is greater). R _L = rated load.
Temperature Coefficient	1mV/°C max.

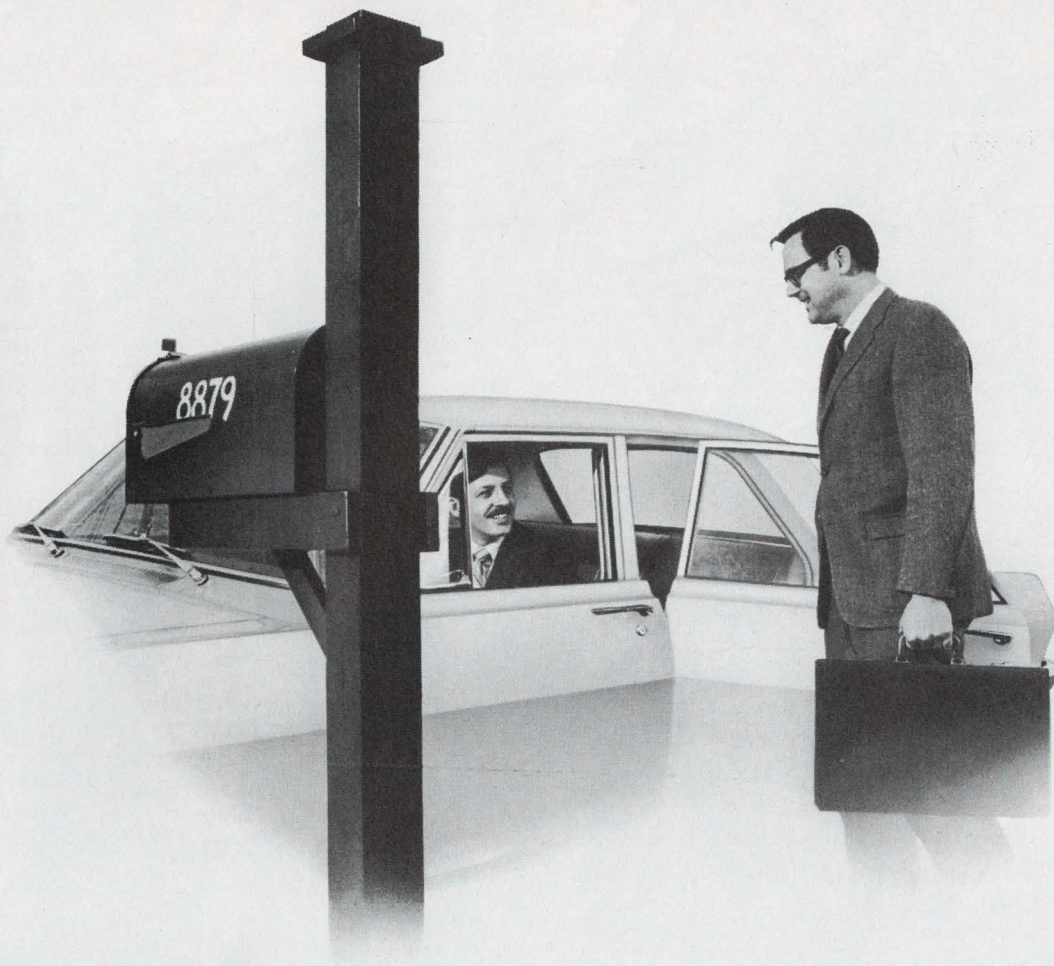

Are you sure you're at the right address?

We believe career advancement may depend as much on being in the right place at the right time as it does on ability. If you agree, then now (while there is lots of summertime for making a move) you should look into what is happening at NCR.

NCR is now the second largest company in the world in the computer systems business — supplying hardware and software answers for a whole world full of expanding markets. But the more answers we work out, the more questions we stir up.

That's why we are still growing rapidly. Why we need more engineers, of all degrees. More physicists, too. And software people. That's why NCR could be the right place — and *now* the right time — for you to advance your career.

In many positions you would be handling significantly more responsibility than you do now, because our employees advance as fast as they are able to assume additional duties.

Unless you are absolutely sure you're at the right address, tell us about your background and career objectives.

Write:

**T. F. Wade, Executive and Professional Placement
The National Cash Register Company, Dept. ED-6
Dayton, Ohio 45409**

We are an Equal Opportunity Employer M/F



INFORMATION RETRIEVAL NUMBER 901

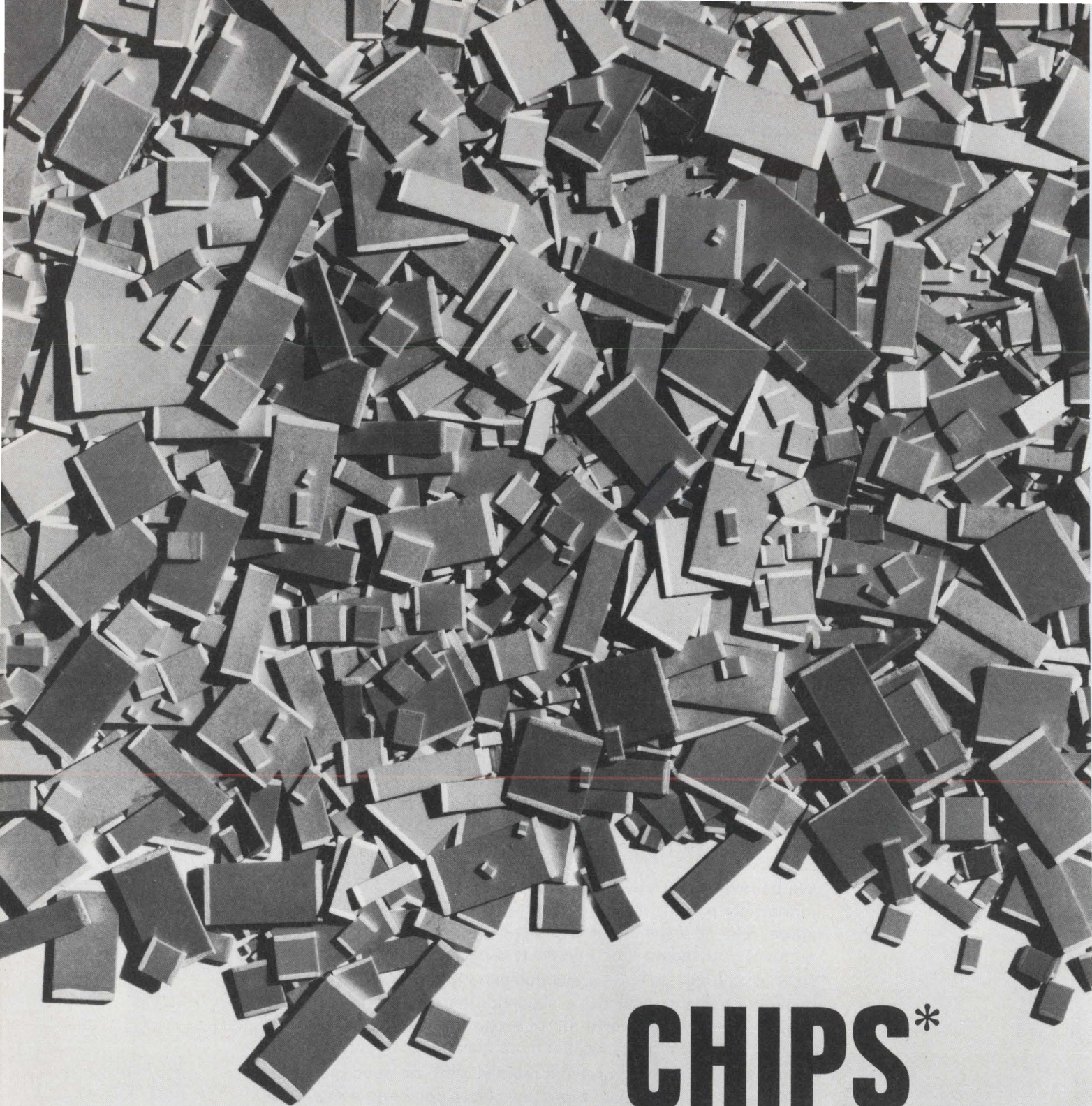

CHIPS*

***USCC CERAMOLITHIC® CHIP CAPACITORS FOR ANY HYBRID CIRCUIT DESIGN PROBLEM**

SPECIFICATIONS: Capacitance range: 10pF to 3.3Mfd. Voltage ratings: 50, 100 and 200 WVdc. Dielectrics: W and NPO. Sizes: start with .050" X .050" X .040". End terminations: noble metal and special combinations. Meets all applicable requirements of MIL-C-11015 and MIL-C-39014.



U.S. Capacitor Corporation, 2151 No. Lincoln St., Burbank, Calif. 91504, Phone (213) 843-4222 • TWX: 910-498-2222

CERAMIC CHIP CAPACITORS, MINIATURE CERAMIC CAPACITORS, EMI/RFI FILTERS

Publisher

Hugh R. Roome

Editors

New York Office
850 Third Ave.
New York, N.Y., 10022
(212) 751-5530

Editor: Frank Egan
Managing Editor: Ralph Dobriner
Managing Editor: Raymond D. Speer
Microelectronics, Steven A. Erenburg
Computers, Milton J. Lowenstein
Circuits, Don Mennie
Microwaves, Michael J. Riezenman
Management, Richard L. Turmail
News, John N. Kessler
Military-Aerospace, John F. Mason
New Products, Roger Allan
New Products, Lucinda Mattera
Directory Manager, Greg Guercio
Copy, Marion Allen

Field Offices

Massachusetts

Jim McDermott
P.O. Box 272
Easthampton, Mass. 01027
(413) 527-3632

San Francisco

Elizabeth de Atley
2051 Wellesley St. (Suite D)
Palo Alto, Calif. 94306
(415) 321-7348

Los Angeles

David Kaye
2930 Imperial Highway
Inglewood, Calif. 90303
(213) 757-0183

Washington

Don Byrne
1425 N St. NW
Washington, D.C. 20005
(202) 667-6568

Editorial Production

Dollie S. Viebig
Richard D. Grissom

Art

Art Director, Clifford M. Gardiner
Assistant, William Kelly
Rita Jendrzewski
JoJo Miskimmon

Production

Manager, Thomas V. Sedita
Helen De Polo
Kathleen McConkey
Leslie Stein

Circulation

Manager, Nancy L. Merritt

Information Retrieval

Genate Piccinetti

EDITORIAL



Sure, it's a down year, but what are you doing about it?

*When the going gets tough,
the tough get going.*

This slogan, which hung on the dressing-room wall of the Green Bay Packers during the days of Vince Lombardi, is apropos in industry today. It's been a rough year economically, with many electronics companies particularly hard hit. Not only are sales down in most quarters, but inflationary pressures have caused business expenses to skyrocket. As a result, profits for many companies are going to be thin—or nonexistent.

In times like these, working engineers and company management are faced not only with crucial responsibilities but also opportunities. The opportunities may not normally be considered when business is good.

As an example, companies now have the incentive to streamline any of their operations that may have grown awkward or inefficient. It's a sad but true fact that good times often mask undesirable features in an operation. And this mask is rapidly stripped away when business turns down.

This opportunity for streamlining exists in the engineering department, too. Are things being done in a certain way just because they've always been done that way? Are scheduling and cost analysis integral parts of the engineering effort? Are purchases made strictly from a cost/performance standpoint?

In many cases thoughtful answers to basic questions like these can lead to considerable savings—in some instances enough to determine a company's survival. And it is the responsibility of all in the engineering department, individually and collectively, to pose such cost-saving questions.

Company managements have responsibility for preserving the integrity of the balance sheet. But this does not justify using the layoff technique as the first line of attack against a business downturn. Personnel cutbacks should go into effect only after all other streamlining efforts have failed to cut costs enough—unless, of course, the company is blatantly overstaffed.

Designers are becoming more and more aware of companies that treat engineers as migrant workers—readily available for the harvest, but easily expendable during the off season. Someday these companies may find themselves in a land of plenty, with few good harvesters.

FRANK EGAN

Design MOS circuits on a computer.

This handy program overcomes the limitations of conventional graphical design techniques.

Computer-aided design of transistor circuits of all types has received much attention recently, and MOS integrated-circuit design is a natural application. The program discussed here is less sophisticated and more limited in its use than some packages in use today. For example, it gives dc or steady-state solutions only, and every circuit must be broken into two-transistor sets for analysis.

However, this program does offer some distinct advantages because of its small size and specialized use. For instance, it requires only a small inexpensive computer (the program was written on a Digital Equipment Co. PDP-8L with 4K words of memory). Input/output is extremely easy if Digital Equipment's FOCAL language is used. English statements are used on a teletypewriter keyboard to control the program and input data, and the program is run essentially in real time.

MOS circuit design in the past relied heavily on graphical solutions or actual measurements made on prototype units. Even today, most of the large analysis packages do not have proven models for MOS transistors. The physical properties of MOS are such that most common circuit configurations lead to transcendental functions with no closed-form solution for current or voltages. The objective sought in this case was to write a small program to solve these equations in the most useful or generalized form.

Circuits operate in three regions

The MOS transistor cannot be described mathematically by one set of continuous equations. Three possible modes of operation are possible. These are shown as regions in the V-I curves of Fig. 1. Each region is described by a unique set of equations, relating electrical properties to physical properties.

Region I—the triode region

$$I_{DS} = \beta(Z/L) [(V_{GS} - (V_{TH} + K_1(\sqrt{2\phi_s + V_s} - \sqrt{2\phi_s}))) V_{DS} - V_{DS}^2/2]$$

The conditions for operation in this region are:

$$|V_{GS}| > |V_{TH} + K_1(\sqrt{2\phi_s + V_s} - \sqrt{2\phi_s})|$$

$$|V_{GD}| > |V_{TH} + K_1(\sqrt{2\phi_s + V_D} - \sqrt{2\phi_s})|$$

where

$\beta = E_{OX} \mu_s / T_{OX}$ channel conductance constant

Z/L = channel aspect ratio, width/length

V_{TH} = threshold voltage or turn on potential

K_1 = substrate bias factor

ϕ_s = substrate Fermi potential

Region II—the saturated region

$$I_{DS} + (\beta/2)(Z/L) [V_{GS} - (V_{TH} + K_1(\sqrt{2\phi_s + V_s} - \sqrt{2\phi_s}))]^2$$

The conditions for operation in this region are:

$$|V_{GS}| > |V_{TH} + K_1(\sqrt{2\phi_s + V_s} - \sqrt{2\phi_s})|$$

$$|V_{GD}| < |V_{TH} + K_1(\sqrt{2\phi_s + V_D} - \sqrt{2\phi_s})|$$

Region III—cutoff

$$I_{DS} = 0$$

The conditions for operation in this region are:

$$|V_{GS}| < |V_{TH} + K_1(\sqrt{2\phi_s + V_s} - \sqrt{2\phi_s})|$$

$$|V_{GD}| < |V_{TH} + K_1(\sqrt{2\phi_s + V_D} - \sqrt{2\phi_s})|$$

Some assumptions made when using the program are these: The effective channel length is not a function of source and drain voltages; the substrate terminal of each transistor is common and connected to ground potential; and both tran-

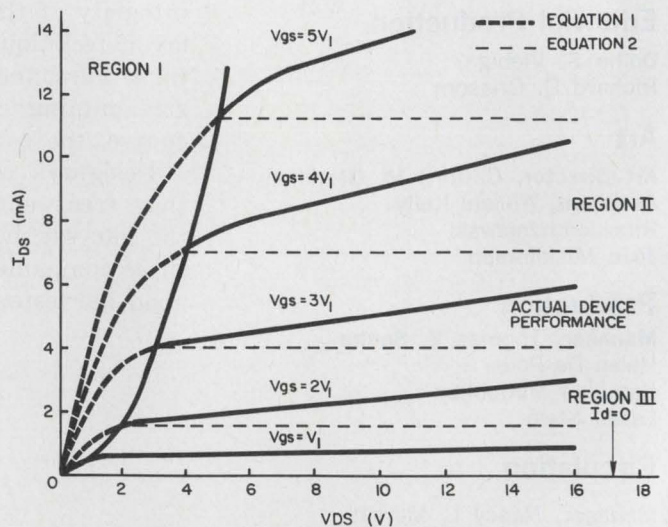

1. The volt-ampere curves of a device are the starting point of the analysis. The dotted lines are approximations to the actual response.

Jim Kubinec, Manager, Memory Circuit Design, Computer Microtechnology, Inc., Sunnyvale, Calif.

sistors in the analysis have the same physical properties at the interface between the silicon and the silicon dioxide. This is valid for integrated circuits since all transistors in the circuit are fabricated simultaneously.

Analyze series transistors

There are two types of MOS transistors, analogous to npn and pnp conventional transistors. The program and analysis are valid for both types if the proper polarity voltages and constants are used.

One MOS circuit configuration appears to be the most common and the most difficult to analyze. It is two MOS transistors in series, with each conducting the same drain-to-source current. Even circuits with many transistors can be broken into groups of these series combinations.

Steady-state analysis of this series combination for drain-to-source current and the node voltage at the node between the two devices covers most of MOS circuit needs. Figure 2 serves several purposes: It shows graphically what happens when two MOS transistors are connected in series; it shows what is meant by the steady-state operating point; and it also is an example of the conventional graphical method of solution used in MOS circuit analysis and design. This method, though, is time-consuming and inaccurate.

The two transistor curves shown in Fig. 2 are monotonic, with one increasing and one decreasing. It can be demonstrated that this is always true. In addition, trivial cases where both curves are zero-valued can occur. The program must also consider these.

The program flow chart is shown in Fig. 3a, and it is listed in Fig. 3b. The program assumes

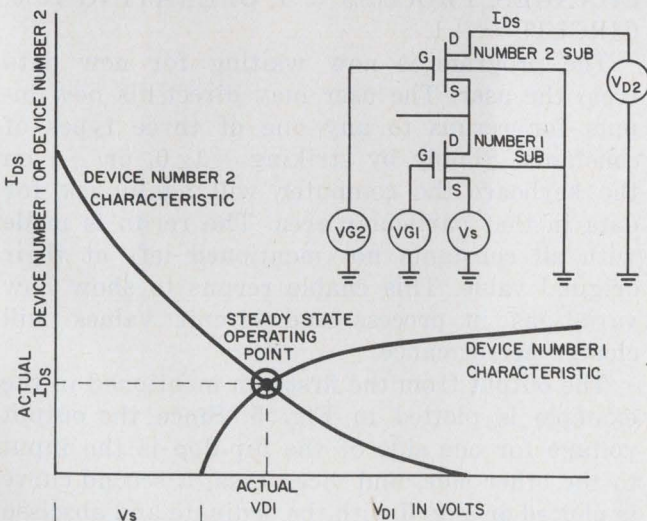

2. Two devices operating in series make up the basic configuration. The curve of one device is superimposed on the other to obtain the operating point.

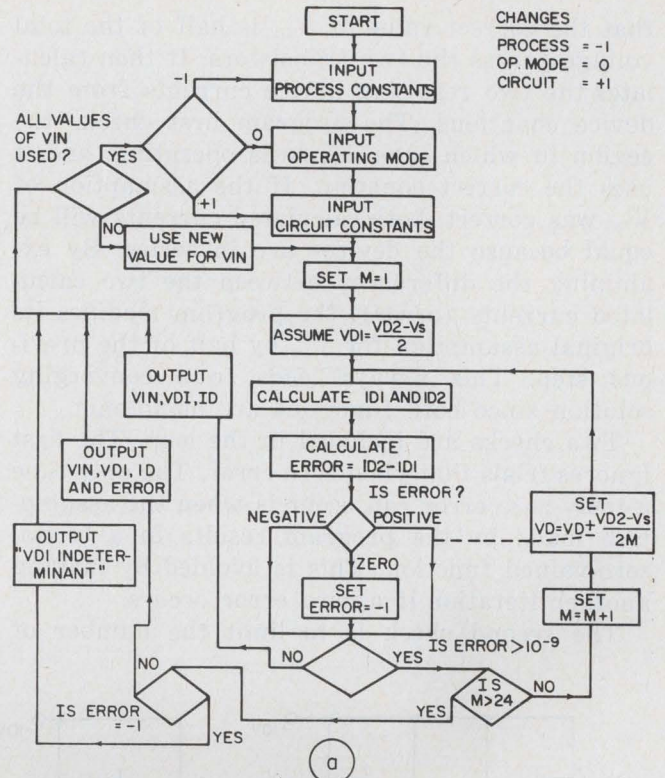

```

C FOCAL 8/68
01.10 TYPE !"MOS D.C. ANALYSIS
01.20 TYPE !"PROCESS CONSTANT"
01.21 ASK !"CHANNEL CONDUCTANCE CONSTANT=? AMPS/VOLTS+2" B
01.22 ASK !"THRESHOLD VOLTAGE=? VOLTS" VT
01.23 ASK !"SUBSTRATE BIAS FACTOR K1=?"K1
01.30 TYPE !"OPERATING MODE"
01.31 ASK !"MOST NEGATIVE VALUE OF VIN=? VOLTS" S1
01.32 ASK !"STEP SIZE=? VOLTS" S2
01.33 ASK !"MOST POSITIVE VALUE OF VIN=? VOLTS" S3
01.40 TYPE !"CIRCUIT CONSTANT"
01.41 ASK !"Z/L DEVICE #1=?" Z1
01.42 ASK !"Z/L DEVICE #2=?" Z2
01.43 ASK !"V DRAIN #2=? VOLTS" VS
01.44 ASK !"V GATE #2=? VOLTS" VG
01.45 ASK !"V SOURCE #1=? VOLTS" VR
01.50 FOR VI=S1,S2,S3;DO 2
01.60 TYPE !!!"CHANGES,PROCESS=-1,OPERATING MODE=0,CIRCUIT=+1"
01.61 ASK R
01.70 IF (R)1.20,1.30,1.40
02.10 SET VD=((VS+VR)/2); SET M=1
02.11 SET VB=VT-K1*<FSQ(0.6-VS)-0.774597>; SET VQ=(VI-VR)
02.12 IF (VQ-VB)2.14,2.13,2.13
02.13 SET I1=0; GOTO 2.20
02.14 IF (VD-VR-VQ+VB)2.15,2.16,2.16
02.15 SET I1=(B/2)*Z1*(VQ-VB)+2; GOTO 2.20
02.16 SET I1=B*Z1*((VQ-VB)*(VD-VR)-(VD-VR)+2/2)
02.20 SET VA=VT-K1*<FSQ(0.6-VS)-0.774597>
02.21 SET VE=VT-K1*<FSQ(0.6-VD)-0.774597>
02.22 IF (VG-VE-VD)2.24,2.23,2.23
02.23 SET I2=0; GOTO 2.40
02.24 IF (VS-VG+VA)2.25,2.26,2.26
02.25 SET I2=(B/2)*Z2*(VG-VE-VD)+2; GOTO 2.40
02.26 SET I2=B*Z2*((VG-VE-VD)*(VS-VD)-(VS-VD)+2)/2)
02.30 GOTO 2.40
02.40 SET ER=(I2-I1); IF (ER)2.42,2.41,2.42
02.41 SET ER=(-1)
02.42 IF ((FABS(ER))-1E-9)2.50,2.50,2.43
02.43 IF (M-24)2.44,2.46,2.46
02.44 SET M=M+1
02.45 SET VD=VD+(FSGN(ER))*((VS-VR)/(2+M)); GOTO 2.11
02.46 IF (ER+0.5)2.61,2.50,7.50
02.50 TYPE %5.03,"VIN"VI,"VOLTS " ,"VD1"VD,"VOLTS "
02.51 TYPE %6.02,"ID"(I1*1E+6),"UA "
02.53 IF (M-24)2.60; TYPE %6.02,"ER"(ER*1E+9),"NA"
02.60 RETURN
02.61 TYPE %5.03,"VIN"VI,"VOLTS"
02.62 TYPE " DEV.#1 & DEV.#2 CUT-OFF,VD1 INDETERMINANT"
02.63 RETURN

```

3. The flow chart of the program can be adapted to any programming language (a). The actual program as written in FOCAL is given in (b).

that the correct value of V_{D1} is half of the total voltage across the two transistors. It then calculates the two resulting device currents from the device equations. The program first checks the region in which each device is operating, and it uses the correct equation. If the assumption of V_{D1} was correct, both calculated currents will be equal because the devices are in series. By examining the differences between the two calculated currents (error), the program modifies its original assumption for V_{D1} by half of the previous step. This always leads to a converging solution since both functions are monotonic.

Two checks are included in the loop. The first ignores trials that yield zero error. The only time a truly zero error can occur is when the assumption made by the program results in a trivial zero-valued function. This is avoided by making another iteration if a zero error occurs.

The second check is to limit the number of

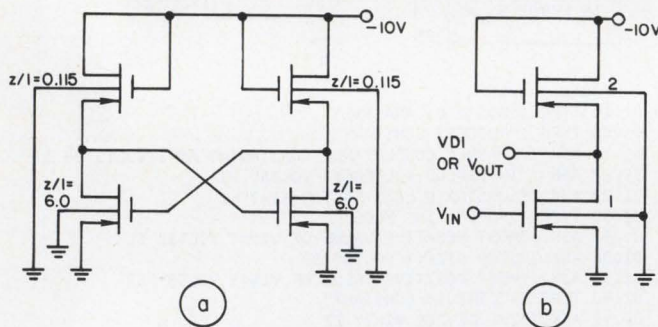

4. The MOS flip-flop uses four transistors (a). Half of this circuit, two transistors in series, is used for the design program (b).

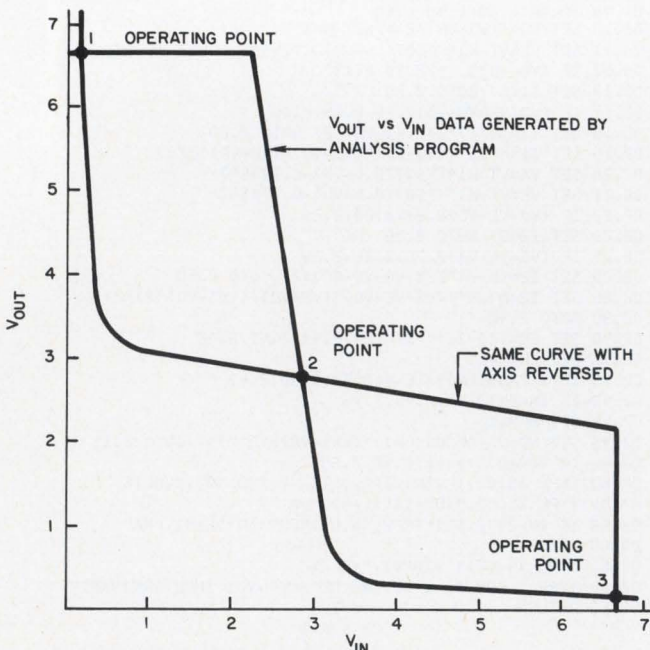

5. Input/output curves for the MOS circuit of Fig. 4b determine the operating point. Note that the two curves are the same but plotted on inverted axes.

iterative loops performed in the solution of any node voltage. This saves time by terminating the loop, once the step size of each successive modification is smaller than the least significant digit of the variables used in the calculations. The loop normally terminates itself by reducing the error term to less than 1.0 nA. At this point the program types out the voltage and current solutions. If the iterative loop is terminated by virtue of exceeding the maximum number of iterations allowed, the voltages and currents found at that point are typed out along with the error term. This indicates the cause of termination.

Program is conversational

The use of the program can be illustrated by using the simple MOS transistor flip-flop shown in Fig. 4a. The flip-flop is made up of the two identical inverter stages shown in Fig. 4b.

Once the program has been loaded into the computer the following information is requested:

```

CHANNEL CONDUCTANCE CONSTANT = ?
AMPS/VOLTS^2
THRESHOLD VOLTAGE = ? VOLTS
SUBSTRATE BIAS FACTOR K1 = ?
MOST NEGATIVE VALUE OF VIN = ?
VOLTS
Z/L DEVICE #1 = ?
Z/L DEVICE #2 = ?
V DRAIN DEVICE #2 = ? VOLTS
V GATE DEVICE #2 = ? VOLTS
V SOURCE DEVICE #1 = ? VOLTS

```

The terminal now lists all the V_{D1} voltages and drain currents for each rerun with different values of V_{in} as follows: $V_{in} = 10.000$ V, $V_{D1} = -0.073$ V, $I_D = 15.34 \mu A$, $V_{in} = 9.800$ V, $V_{D1} = -0.075$ V, $I_D = 15.33 \mu A$, etc., until the entire set of values for all V_{in} are listed. At this point the computer asks:

```

CHANGES, PROCESS = 1, OPERATING = 0,
CIRCUIT = +1.

```

The program is now waiting for new data from the user. The user may direct his new inputs for reruns to any one of three types of constants. Simply by striking -1, 0, or +1 on the keyboard the computer will again ask for data in that particular area. The rerun is made with all constants not mentioned left at their original value. This enable reruns to show how variations in process and circuit values will change performance.

The output from the first run mentioned in the example is plotted in Fig. 5. Since the output voltage for one side of the flip-flop is the input to the other side, and vice versa, a second curve is plotted on Fig. 5 with the ordinate and abscissa reversed. This leads to three operating points and to a current drain of $15.07 \mu A$, a result that agrees well with actual measurements. ■

WHY WAIT FOR MICA?

KEMET® Flat-Kap capacitors with Parylene are smaller, more stable, offer better performance...and they're available now!

Is the long lead time on mica from India holding up shipments of capacitors for your production line? And do the thick slittings that are necessary with this natural product force you to use a large, high voltage capacitor that will only see nine volts in your circuit? Well, your waiting and wasting days are all over now.

KEMET Flat-Kap capacitors are smaller because Parylene is a very thin, ultra-pure plastic film that can be deposited on high purity aluminum foil. They're more stable because of vacuum impregnation of a solid dielectric. And, they're available now, when you need them, because all the raw materials used are produced here in the United States.

Performance? Just make a quick comparison of an $0.01\mu F \pm 1\%$ mica capacitor with a Parylene Film Flat-Kap.



ACTUAL SIZE

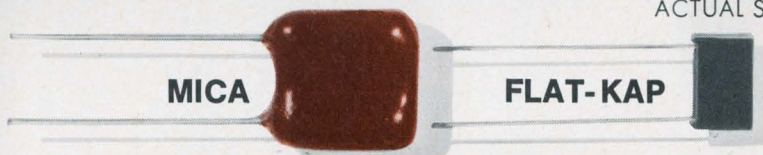

MICA

FLAT-KAP

Size (Max. Dimension)
Volume
T.C. ppm/°C
Stability (typical long-term)
D.F.
IR
Cure Material
Specification

.830 x .920 x .450
0.34 in³
0 to + 70
0.1%
0.2%
100,000 Meg.
Dipped Phenolic
MIL-C-5

.310 x .515 x .140
.022 in³
0 ± 50
0.2%
0.3%
100,000 Meg.
Molded Epoxy
MIL-C-5514

So why wait for mica when Flat-Kaps are now available in capacitance ranges from 0.001 to $0.22\mu F$ at 50 V DC, with radial or axial leads for easy replacement on your substrate? See your local Union Carbide Representative for complete information.

COMPONENTS DEPARTMENT

P.O. Box 5928, Greenville, South Carolina 29606. Tel.: (803) 963-7421 TWX: 810-287-2536



THE DISCOVERY COMPANY

Immediate delivery,

That's a pretty strong statement coming from Sylvania, but with 7400N TTL we can prove it.

In fact, we have your first order ready and waiting for you at your local participating distributor. And it won't cost you a cent.

We will give you a "starter set" of 10 circuits absolutely free. Just fill out coupon at right indicating the types and quantities you want and take it to your distributor. He'll hand over up to 10

circuits.

Of course, we realize that 10 circuits may not be enough to build the system you want. But our distributor will be only too happy to sell you the additional circuits. And you'll be getting reliable Cerdip packages at plastic prices.

Along with these circuits, you get Sylvania's guarantee* of hermeticity (1×10^{-7} cc/sec, 2% AQL), tapered lead construction that makes for easy socket inser-

That's why you need 9th-sourcing

Participating Sylvania Distributors:

ALABAMA: HUNTSVILLE Gulf Electronics Corp., 3804 Sixth Avenue, West, (205) 837-6101. Radio Electric Service Co., 825B Wheeler Avenue, (205) 539-5156. **ARIZONA:** PHOENIX Moltronics, Inc., 2746 W. Palm Lane, (602) 272-7951. Sterling Electronics, 1930 N. 22nd Ave., P.O. Box 6658, (602) 258-4531. **CALIFORNIA:** GARDENA Santa Monica-Bell Electronics Corp., 306 E. Alondra Blvd., (213) 321-5802. HOLLYWOOD Hollywood Radio & Electronics, Inc., 5250 Hollywood Blvd., (213) 466-3181. INGLEWOOD Newark Electronics Co., 4747 W. Century Blvd., (213) 674-8440. MENLO PARK Bell Electronics Corp., 1070 O'Brien Drive, (415) 323-9431. MOUNTAIN VIEW Elmar Electronics, 2288 Charleston Road, (415) 961-3611. NEWPORT BEACH Intermark Electronics, 4301 Birch Street, (213) 537-4664. NORTH HOLLYWOOD Richey Electronics, 5505 Riverton Avenue, (213) 877-2651. REDWOOD CITY Cramer Electronics, 695 Veterans Blvd., (415) 365-4000. SAN DIEGO Milo of California, Inc., 2060 India Street, (714) 232-8951. **COLORADO:** DENVER Newark-Denver Electric Supply, 2170 So. Grape Street, (303) 757-3351. **FLORIDA:** MIAMI Gulf Electronics Corp., P.O. Box 48-194, (305) 887-6541. ORLANDO Hammond Electronics, Inc., 911 W. Central Blvd., P.O. Box 3671, (305) 241-6601. **GEORGIA:** ATLANTA Specialty Distributing Co., 763 Juniper St., N.E., P.O. Box 6326, (404) 873-2521. Jackson Electronics Co., 1135 Chattahoochee Ave., N.W. P.O. Box 19837, (404) 355-2223. **ILLINOIS:** CHICAGO Allied Electronics, 111 No. Campbell Ave., P.O. Box 4716, (312) 829-9100. Newark Electronics Corp., 500 No. Pulaski Road, (312) 638-4411. **INDIANA:** INDIANAPOLIS Graham Electronics Supply Co., 122 S. Senate Avenue, (317) 634-8486 & (317) 634-5571. **IOWA:** CEDAR RAPIDS Deeco, Inc., 2500 16th Avenue S.W., (319) 365-7551. **KANSAS:** KANSAS CITY Hall-Mark Electronics, 2707 West 43rd, (913) 236-4343. **MAINE:** PORTLAND DeMambro Radio Supply Co., 73 Preble Street, (207) 773-4733. **MARYLAND:** BALTIMORE Pytronics Industries, Inc., 2035 Worcester, (301) 539-6525. Pioneer Washington Elec. Inc., Division of Pioneer Standard, 1037 Taft Street, (301) 427-3300. TOWSON Radio Electric Service, 1026 Cromwell Bridge Road 21204, (301) 823-0070. **MASSACHUSETTS:** BOSTON DeMambro Radio Supply Co., 1095 Commonwealth Avenue, (617) 254-9000. DEDHAM Gerber Electronics Co., 852 Providence Highway, US

believe it or not.

tion, and the high reliability that comes with Cerdip packaging.

We say that Sylvania's 7400N TTL is the best buy in the industry. Fill in the coupon and find out exactly what we mean.

Today.

Sylvania Electronics Components, Semiconductor Division, Woburn, Mass. 01801.

SYLVANIA
GENERAL TELEPHONE & ELECTRONICS
INFORMATION RETRIEVAL NUMBER 52
in 7400N TTL.

GOOD FOR 10 FREE ICs.

Please give me the 10 Sylvania 7400N TTL circuits I have indicated below, absolutely free.

Quantity	Type	Quantity	Type
___	SG7400N Quad 2 NAND gate	___	SG7451N Dual AND-OR inverter
___	SG7402N Quad 2 NOR gate	___	SG7453N 4 x 2 AND-OR-invert gate with expander
___	SG7410N Triple 3 NAND gate	___	SG7454N Single AND-OR-inverter
___	SG7420N Dual 4 NAND gate	___	SG7460N Dual 4-input expander
___	SG7430N Single 8 NAND gate	___	SF7472N Master/slave J-K flip-flop
___	SG7440N Dual 4 buffer gate	___	SF7473N Dual master/slave J-K flip-flop
___	SG7450N Dual 2 x 2 AND-OR-invert gate with expander inputs	___	SF7474N Dual "D" flip-flop

Name _____ Title _____
Company _____ Address _____
City _____ State _____ Zip _____ Phone _____

Redeemable only at participating distributors listed below. Offer expires July 15, 1970.

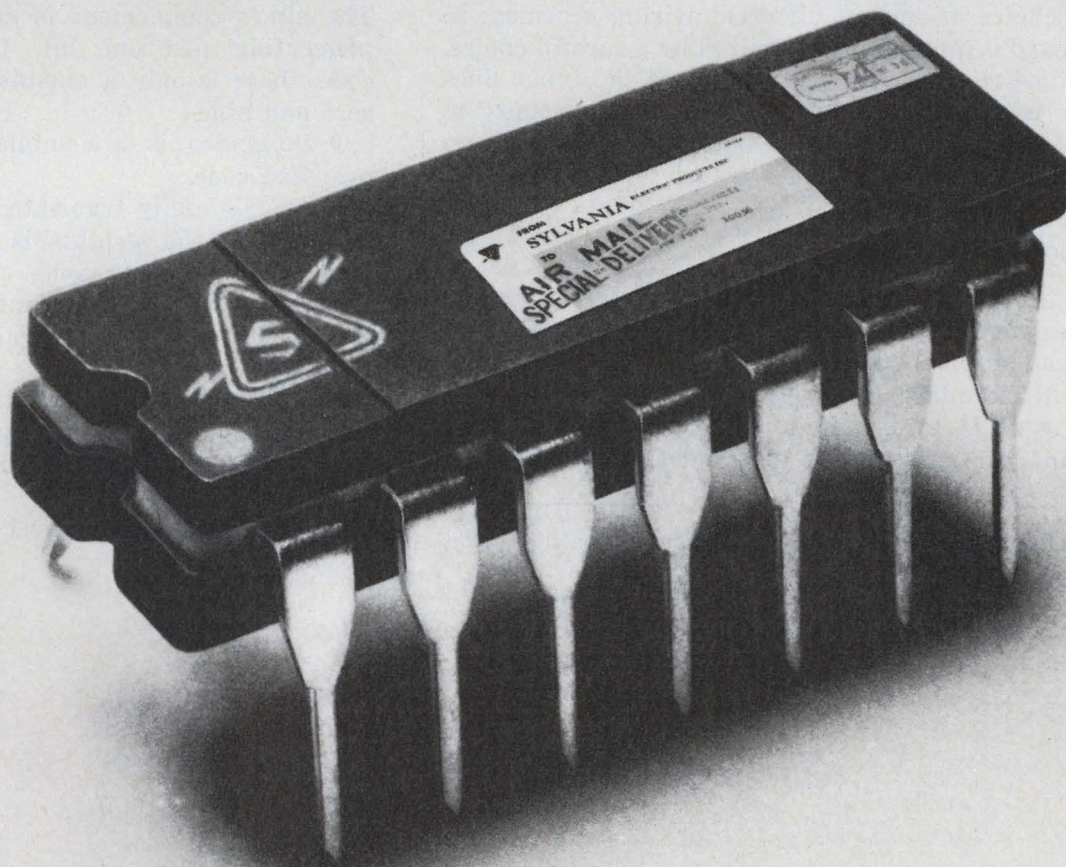

*These integrated circuits are guaranteed to substantially conform to Sylvania's applicable specifications and be delivered free of defects in materials and workmanship. If they are defective in such respects, at Sylvania's election, Sylvania will either repair, replace or grant a credit at invoice prices if defective integrated circuits are returned to the factory pre-paid within one year after shipment. THESE GUARANTEES ARE IN LIEU OF ALL OTHER GUARANTEES EXPRESSED OR IMPLIED. Sylvania shall not be liable for special or consequential damages of any nature.

Rt. #1, (617) 329-2400. WATERTOWN Sterling Electronics Corp., 51 Spring Street, (617) 891-8700. MICHIGAN: ROMULUS Harvey Radio, 36312 Ecorse Road, (313) 729-5500. MINNESOTA: MINNEAPOLIS Stark Electronics Supply Co., 112 Third Avenue North, (612) 332-1325. MISSOURI: UNIVERSITY CITY Olive Industrial Electronics Inc., 6662 Olive Street Road 63130, (314) 863-7800. NEW JERSEY: PERTH AMBOY Sterling/Atlas Electronics, Inc., 774 Pfeiffer Blvd., (201) 442-8000. NEW MEXICO: ALBUQUERQUE Kierulff Electronics, 6405 Acoma Road, S.E., (505) 247-1055. Sterling Electronics, Inc., 1712 Lomas Blvd., N.E., Box 1793, (505) 247-2486. NEW YORK: BUFFALO Genesee Radio, Inc., 2550 Delaware Avenue, (716) 873-9661. Summit Distributors, 916 Main Street, (716) 884-3450. LONG ISLAND CITY H. L. Dalis, 35-35 24th Street, (212) 361-1100. NEW HYDE PARK Boro Electronics, Inc., 86 Denton Avenue, (516) 747-1900. NEW YORK CITY Milo Electronics Corp., 325 Hudson Street, (212) 924-5000. State Labs, 215 Park Avenue South, (212) 677-8400. Terminal-Hudson, Inc., 236 West 17th Street, (212) 243-5200. PLAINVIEW A. C. I. Electronics Corp., 28 South Mall 11803, (516) 293-6630. VESTAL Federal Electronics, Inc., Vestal Highway, P.O. Box 1206, (607) 748-8211. NORTH CAROLINA: WINSTON-SALEM Kirkman Electronics, Inc., 901 Second St., Drawer K, Salem Stn., (919) 724-0541. OHIO: CLEVELAND Pioneer-Standard Electronics, Inc., 5403 Prospect Avenue, (216) 432-0010. Winteradio Electronic Supply Corp., 1468 West 25th Street, (216) 621-9383. DAYTON Srepco Div. of Pioneer Standard, 314 Leo Street, (513) 224-3871. OKLAHOMA: TULSA Radio, Inc., 1000 S. Main Street, (918) 587-9124. PENNSYLVANIA: PHILADELPHIA Almo Electronics, Div. of Sterling Electric Corp., Roosevelt Blvd. at Blue Grass Road, (215) 676-6000. MONTGOMERYVILLE Pyttronic Industries, Inc., Building 2—Stump Road, (215) 643-2850. TEXAS: DALLAS Wholesale Electronics, Inc., 2809 Ross Avenue, (214) 824-3001. FORT WORTH Wholesale Electronic Supply, 550 South Freeway, (817) 336-0461. HOUSTON Sterling Electronics, Inc., 4201 Southwest Freeway, (713) 225-1321. UTAH: SALT LAKE CITY Kimball Electronics, 350 Pierpont Avenue, (801) 328-2075. WASHINGTON: SEATTLE Washington Electronics, Inc., 2217 Third Avenue, (206) 682-4380 & (206) 682-8981.

Any code goes with IC decoder/drivers.

Just rearrange some wires, and you can drive display tubes directly without first converting to BCD.

At first glance, it may appear that all the IC decoder/drivers being sold today for gas-filled cold cathode indicator tubes are designed to accept binary-coded decimal (BCD) inputs only. But with a little juggling of wires, these integrated circuits become useful for displaying decimal numbers in practically every popular code.

In some cases the change involves merely swapping the input wires around and taking the outputs from different pins. Most codes allow a choice of several different wiring schemes; so board layout can be optimized by a careful choice. Some require that one or two of the input lines be complemented, but this is a small penalty to pay compared with the cost of a decoder built up from gates and discrete transistors.

Pick the best code

A review of the various codes will help the designer exploit their special advantages with decimal displays. Here are codes that can be used with standard BCD decoders:

- *BCD*, by far the most popular, is the simple binary representation of the decimal number.

Robert Leonard Nelson Jr., Engineer/Scientist, Tracor, Inc., Austin, Tex.

- *XS3*, meaning "excess three," is the binary value plus three. The nine's complement can be taken by logically complementing each bit. Also, when two XS3 numbers are added in a binary adder, a carry occurs if the sum is greater than nine.

- *Gray* is used in encoders, because only one bit changes at a time in going from number to number.

- *XS3-Gray* combines the features of both. The nine's complement is easily taken by complementing just one bit. Unlike simple Gray code, there is only a one-bit difference between zero and nine.

- *Biquinary* is a combination base-two and base-five code.

- *2421* is easily translated to and from BCD. The sum of the weights is nine, which can be handy in D-A conversion.

- *2421 (Aiken)* rearranges the weight-two bits to obtain the same complementing feature as XS3.

- *4221 (Berkeley)*, another rearrangement, lends itself to displays using neon lamps, which may now be replaced by Nixies without changing codes.

Here are ways to connect decoder/drivers for these codes:

A standard IC BCD/Decimal decoder/driver is represented by the gray block with input (A,B,C,D,) and output (0-9) terminals as indicated. Two ways of connecting a BCD input are shown to the left of the decoder. The input to the far left is the standard one while the other has the B and C inputs reversed. The corresponding outputs are shown to the right of the decoder. The BCD-coded inputs and their decimal equivalent for the digits 0 through 9 are shown on the far right.

Input		BCD/Decimal Decoder	BCD		Output				Dec
					D	C	B	A	
		0	0	0	0	0	0	0	0
A	A	1	1	1	0	0	0	1	1
		2	2	4	0	0	1	0	2
B	C	3	3	5	0	0	1	1	3
		4	4	2	0	1	0	0	4
C	B	5	5	3	0	1	0	1	5
		6	6	6	0	1	1	0	6
D	D	7	7	7	0	1	1	1	7
		8	8	8	1	0	0	0	8
		9	9	9	1	0	0	1	9

XS3-Gray

Input		Output	D	C	B	A	Dec
	A	0	0	0	1	0	0
	B	1	0	1	1	0	1
D D	C	2	0	1	1	1	2
A \bar{B}	D	3	0	1	0	1	3
\bar{B} A		4	0	1	0	0	4
\bar{C} \bar{C}		5	1	1	0	0	5
		6	1	1	0	1	6
		7	1	1	1	1	7
		8	1	1	1	0	8
		9	1	0	1	0	9

Gray

Input		Output	D	C	B	A	Dec
	A	0	0	0	0	0	0
	B	1	0	0	0	1	1
A A	C	2	0	0	1	1	2
B \bar{C}	D	3	0	0	1	0	3
\bar{C} B		4	0	1	1	0	4
D D		5	0	1	1	1	5
		6	0	1	0	1	6
		7	0	1	0	0	7
		8	1	1	0	0	8
		9	1	1	0	1	9

2421

Input		Output	D	C	B	A	Dec
	A	0	0	0	0	0	0
	B	1	0	0	0	1	1
A A	C	2	0	0	1	0	2
\bar{B} \bar{C}	D	3	0	0	1	1	3
\bar{C} \bar{B}		4	0	1	0	0	4
D D		5	0	1	0	1	5
		6	0	1	1	0	6
		7	0	1	1	1	7
		8	1	1	1	0	8
		9	1	1	1	1	9

Biquinary

Input		Output	D	C	B	A	Dec
	A	0	0	0	0	0	0
	B	1	0	0	0	1	1
D D	C	2	0	0	1	0	2
A B	D	3	0	0	1	1	3
B A		4	0	1	0	0	4
C C		5	0	1	0	1	5
		6	1	0	0	0	6
		7	1	0	1	0	7
		8	1	0	1	1	8
		9	1	1	0	0	9

Any BCD decoder will decode these codes. The various input arrangements are at the left of the IC, and the corresponding outputs at the right. The IC input/

output terminals are labeled according to their normal BCD connection. Typical decoders are TI SN7441A, Fairchild 9960 and Signetics 8T01.

XS3

Input		Output	D	C	B	A	Dec
	A	0	0	0	1	1	0
	B	1	0	1	0	0	1
A D	C	2	0	1	0	1	2
B B	D	3	0	1	1	0	3
C A		4	0	1	1	1	4
D C		5	1	0	0	0	5
		6	1	0	0	1	6
		7	1	0	1	0	7
		8	1	0	1	1	8
		9	1	1	0	0	9

2421 (Aiken)

Input		Output	D	C	B	A	Dec
	A	0	0	0	0	0	0
	B	1	0	0	0	1	1
A D	C	2	0	0	1	0	2
C B	D	3	0	0	1	1	3
D A		4	0	1	0	0	4
B C		5	0	1	0	1	5
		6	1	1	0	0	6
		7	1	1	0	1	7
		8	1	1	1	0	8
		9	1	1	1	1	9

XS3-Gray

Input		Output	D	C	B	A	Dec
	A	0	0	0	1	0	0
	B	1	0	1	1	0	1
D	C	2	0	1	1	1	2
C	D	3	0	1	0	1	3
A		4	0	1	0	0	4
B		5	1	1	0	0	5
		6	1	1	0	1	6
		7	1	1	1	1	7
		8	1	1	1	0	8
		9	1	0	1	0	9

4221 (Berkeley)

Input		Output	D	C	B	A	Dec
	A	0	0	0	0	0	0
	B	1	0	0	0	1	1
A	C	2	0	0	1	0	2
D	D	3	0	0	1	1	3
C		4	0	1	1	0	4
B		5	0	1	1	1	5
		6	1	1	0	0	6
		7	1	1	0	1	7
		8	1	1	1	0	8
		9	1	1	1	1	9

Only a decoder with an over-range feature will decode these codes. Instead of the usual "nonsense" outputs for BCD inputs of greater than nine, the output is

the units digit of the input decimal value. The National DM8840 has this additional feature. Additional input arrangements are possible for the XS3 and 2421.

National does it

and

and

and

Every time someone improves on one of our monolithic linear circuits, it turns out to be us.

Specs on commercial versions are unbelievable. Write for data.

National Semiconductor Corporation, 2900 Semiconductor Drive, Santa Clara, California 95051.

Phone (408) 732-5000,

TWX 910-339-9240,

Telex 346-353.

again

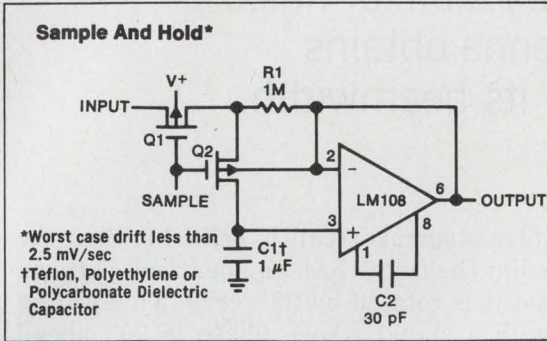

LM108 Op Amp

From the inventor of the super-gain transistor—the ultimate Op Amp. Maximum bias current 3nA; max. offset current 400pA over -55°C to $+125^{\circ}\text{C}$ temperature range. Max. offset voltage of 0.5mV and $5\mu\text{V}/^{\circ}\text{C}$ drift also available. Operates from $\pm 2\text{V}$ to $\pm 20\text{V}$ supplies, drawing only 300nA. Useful in high impedance circuits or in analog memories.

\$60.00 in hundred up quantities.
\$10.00 for the commercial LM308.

again

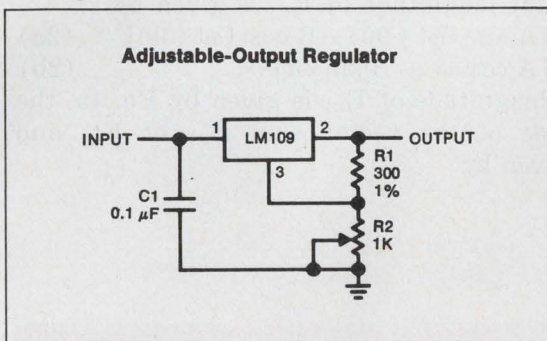

LM109 Regulator

Simple as one, two, three. Just hook the input to the unregulated supply, the output to the load and the ground to ground. This 3 lead device gives output currents over 1A. And thermal overload protection makes it virtually blow-out proof. Prime function is a 5V on-card regulator for digital logic, but it can be adjusted for higher voltages.

\$20.00 for TO-5, 200mA, \$25.00 for TO-3, 1A. Prices for commercial parts \$5.50 and \$6.50. Hundred up prices.

again

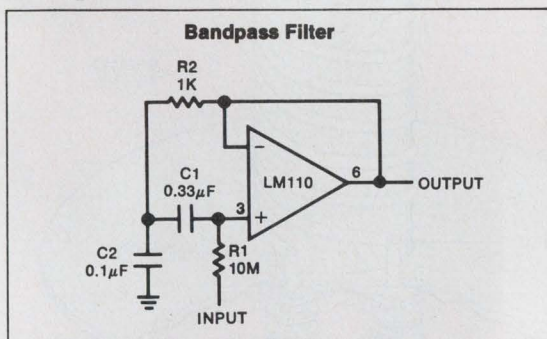

LM110 Follower

Uses super-gain transistors to get 20MHz bandwidth and $30\text{V}/\mu\text{s}$ slew in a follower with 10nA maximum bias current. Plug in replacement for most popular Op Amps in follower applications. Ideal as fast, high impedance buffer or inactive filters.

\$10.00 in hundred up quantities.
Commercial LM310 \$3.25.

again

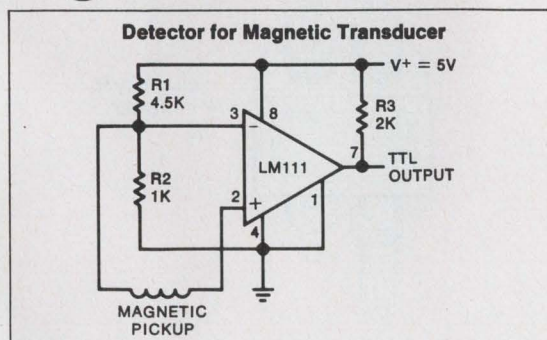

LM111 Voltage Comparator

First truly universal IC comparator. Works with $\pm 15\text{V}$ Op Amp supplies or even a single 5V logic supply. Output will drive RTL, DTL, TTL or MOS logic. It will handle lamps or relays up to 50V at 50mA. Max. bias current of 100nA and off-set current of 20nA are decades lower than previous IC's. Plugs into 710 socket.

At \$12.00 in hundred quantities, it's beyond comparison. LM310 commercial part \$3.25.

National/Linear

For circular polarization, try a bifilar helix.

By combining two offset helices, this antenna obtains an excellent axial ratio — independent of its beamwidth.

Because of its design simplicity and its excellent electrical characteristics over a wide bandwidth, the axial-mode helix has found wide use as a circularly polarized antenna. But there's a major pitfall that can keep a designer from getting maximum performance: The axial ratio of the antenna's polarization ellipse and the beamwidth of its E and H radiation patterns are determined by the same physical parameters.¹

In applications requiring a good axial ratio and a large beamwidth—a feed for a parabolic reflector, for example—the designer faces a dilemma. He can improve the axial ratio by increasing the number of turns in the helix, but this will narrow the beamwidth.

The problem is easily solved by winding two identical helices around a common axis. The resulting bifilar structure has an excellent axial ratio that is independent of the physical parameters of its constituent helices. The designer is thus free to select these parameters to provide the desired beamwidth.

Feed the elements in quadrature

The bifilar quadrature helix consists of two identical helical elements sharing a common axis. The starting point of one element is rotated about the axis 90° from the starting point of the other (Fig. 1). These starting points, or inputs, are fed in quadrature.

To see how the bifilar structure works, let's assume that each of the helical elements is designed to produce the beamwidth that we want but that it has an axial ratio of 3 dB (Fig. 2). A and B are the two orthogonal linear electric fields that generate the rotating vector E_R . The magnitude and the angular position of E_R are given by

$$|E_R| = [A^2 \sin^2 \omega t + B^2 \cos^2 \omega t]^{1/2} \quad (1a)$$

and

$$\text{Ang}(E_R) = \theta = \text{arc tan } [A \sin \omega t / B \cos \omega t]. \quad (1b)$$

If Fig. 2 represents one of the simple helices

in the bifilar structure (call it helix 1), then the second helix (helix 2) has an identical pattern, except that it is rotated by 90° (Fig. 3). Feeding helix 2 with a signal whose phase is 90° ahead of helix 1 compensates for the spatial offset and ensures that the angle of E_{R1} is the same as the angle of E_{R2} as a function of time.

Since the magnitude of E_{R2} is given by

$$|E_{R2}| = [A^2 \sin^2(\omega t + 90) + B^2 \cos^2(\omega t + 90)]^{1/2} \quad (2a)$$

$$= [A^2 \cos^2 \omega t + B^2 \sin^2 \omega t]^{1/2}, \quad (2b)$$

and the magnitude of E_{R1} is given by Eq. 1a, the magnitude of the vector sum E_{RT} of E_{R1} and E_{R2} is given by

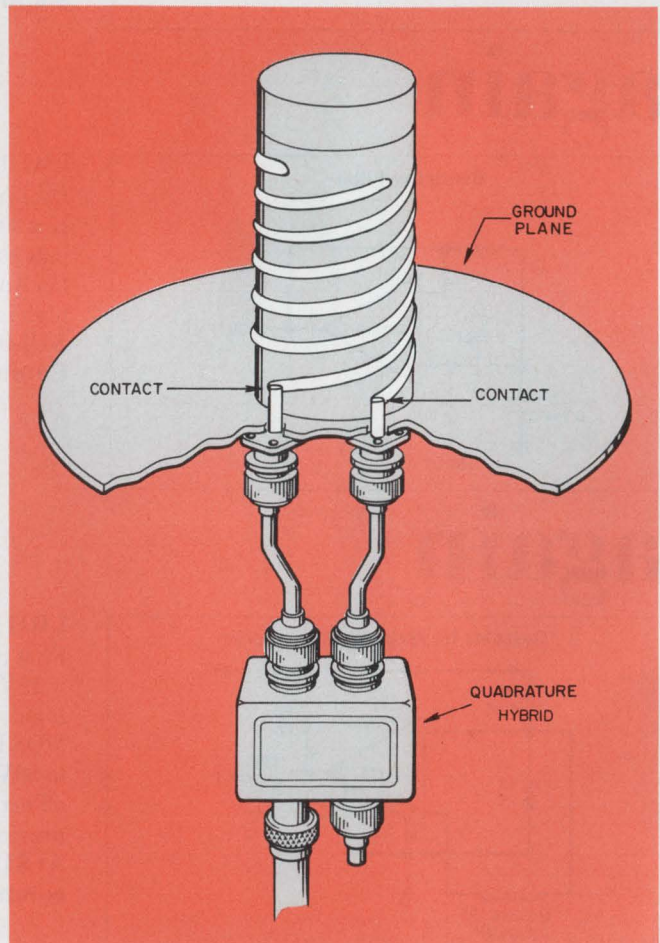

1. A bifilar quadrature helix: The constituent helices must be identical to obtain a perfect axial ratio.

A. S. Henderson, Senior Engineer, Radiation, Inc., Melbourne, Fla.

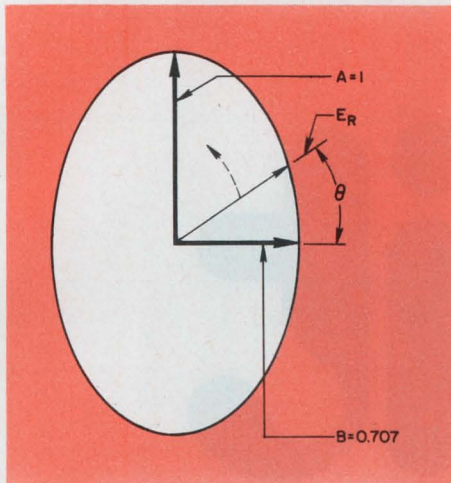

2. A single-element axial ratio of 3 dB is shown by this polarization ellipse. ($10 \log_{10} (A/B)^2 = 3 \text{ dB.}$)

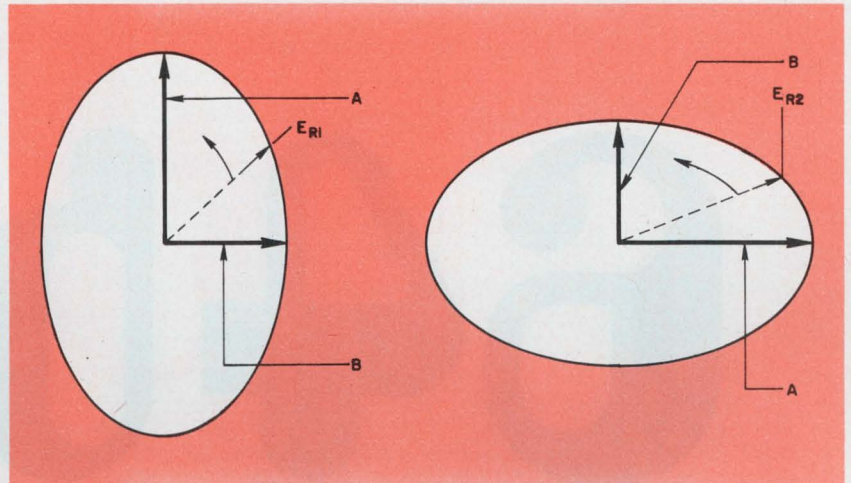

3. Perfect circular polarization is obtained when these two 3-dB ellipses are combined. The vector sum of E_{R1} and E_{R2} is a radius of constant length $(A + B)$ rotating at a constant angular velocity (ω) .

$$\begin{aligned} E_{RT} &= [(A \sin \omega t + B \sin \omega t)^2 \\ &\quad + (A \cos \omega t + B \cos \omega t)^2]^{1/2} \\ &= [(A+B)^2 (\sin^2 \omega t + \cos^2 \omega t)]^{1/2} \\ &= A+B = \text{const.} \end{aligned}$$

Thus the polarization ellipse of the bifilar quadrature helix has an axial ratio of 0 dB—that is, it is a circle.

It is obvious that the bifilar quadrature helix offers considerable freedom from the problems that normally beset the designer. In fact, it appears that any helix will work no matter how crudely made. While this is largely true, the designer should bear in mind that the two helix elements in the bifilar quadrature design must be constructed with precision so that the polarization ellipses they generate are nearly identical.

Another factor affecting the axial ratio of the bifilar quadrature helix is the quadrature hybrid coupler. A good-quality hybrid that gives a 3-dB power split and 90° phase shift within reasonably close tolerances must be chosen to ensure good performance.

Although the bifilar helix shown is an ordinary axial-mode helix, any of the more exotic designs—such as the conical helix, helices of varying pitch angle, etc.—can be used in the bifilar configuration.

In our experimental work, an S-band antenna was constructed. It had an axial ratio of 0.5 dB or less across a 26% bandwidth, and a 3-dB beamwidth of 60° . ■■

Reference:

1. Kraus, John D., *Antennas*, McGraw-Hill, New York, 1950.

Test Your Retention

Here are questions based on the main points of this article. Their purpose is to help you make sure you have not overlooked any important ideas. You'll find the answers in the article.

1. Why must the bifilar helix be fed from a quadrature hybrid?
2. How do the pitch and the diameter of the constituent helices affect the axial ratio of the bifilar helix?
3. Why is it necessary to make the two constituent helices as nearly identical to each other as possible?

64bit

You can fulfill your scratchpad requirements from stock with the best 64 bit bipolar read/write memory in the industry. Your system worst case noise immunity is no longer limited by one device. This unit provides a full TTL fan-out of 10, @ 0.4 V, for complete TTL compatibility and full noise immunity. Why take anything less! You can achieve better clock rates with the 12 nsec typical minimum write pulse width. You can build larger memory systems without buffers using TTL gates because of the low 1.2 ma input current. Why buy anything less!

Your high speed scratchpad and buffer memory requirements will be best satisfied with the CM2100 memory. You will have superior performance because these units have the best combination of specifications available.

Computer Microtechnology Inc. continues to bring you advanced products for your memory systems. The CM2100 memory is an example of this with its expansion capability through chip select input and wired-OR outputs. Check the specs.

CM2100 64 BIT BIPOLAR READ/WRITE MEMORY

Organization 16 words by 4 bits

Read Access Time 40 nsec typ,
60 nsec max

Min Write Pulse Width . 12 nsec typ,
25 nsec max

Compatibility DTL and TTL

Packaging 16 lead dual-in-line

Price \$40.00, 1-24

Delivery Stock

Order yours today! They're in stock!



Computer Microtechnology, Inc

CM AREA OFFICES

Plant	East	West
610 Pastoria Sunnyvale, Calif. (408) 736-0300	10 Dale Street Waltham, Mass. 02154 (617) 891-0002	1627 Pontius Avenue Los Angeles, Calif. 90025 (213) 478-1285

INFORMATION RETRIEVAL NUMBER 54

ELECTRONIC DESIGN 13, June 21, 1970

If you only see this

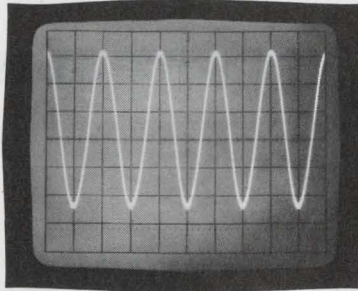

Conventional scope display of 5 MHz signal appears undistorted →

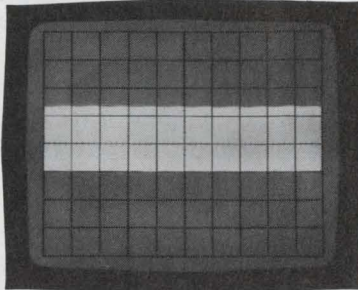

Conventional scope display barely shows 10 kHz AM of 30 MHz carrier →

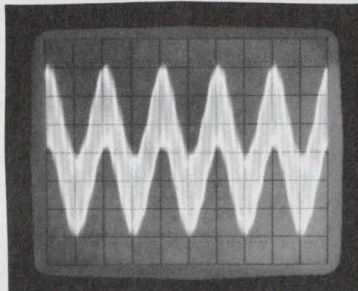

Conventional scope display merely shows "fuzzy" sine wave →

look what you're missing.

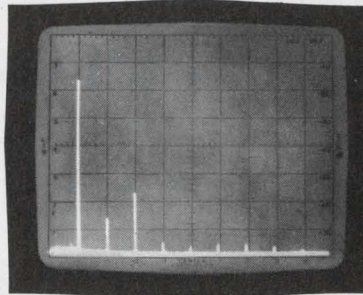

but spectrum analyzer display shows 2nd harmonic 50dB down and 3rd at -40 dB.

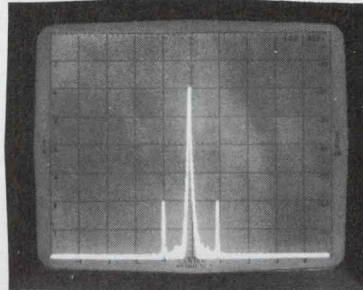

but spectrum analyzer shows sidebands 40 dB down; i.e., 2% AM.

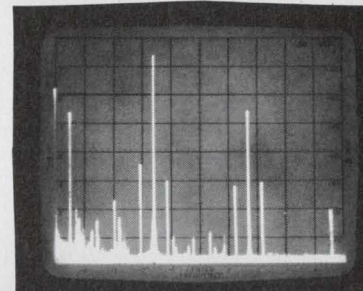

but spectrum analyzer identifies parasitic oscillations.



You're missing the wealth of information you need for *complete* signal analysis.

There's only one lab tool that fully characterizes oscillators, mixers, modulators, amplifiers, filters and systems, both in design and test stages. This tool is an HP spectrum analyzer, the oscilloscope that operates in the frequency domain.

One of the analyzers covers the 1 kHz to 110 MHz range; the other goes from 500 kHz to 1250 MHz. Because frequency response is flat, each provides absolute amplitude calibration — and you can read out in dBm or volts (down to < -120 dBm or $0.1 \mu V$). The > 70 dB distortion-free dynamic range permits you to measure signals with very wide amplitude differences. You can sweep the entire frequency range, then reduce the scan to zoom in for a closeup of any portion down to .0002% of the initial sweep. Selectable bandwidths provide resolution as high as 50 Hz in the 110 MHz instrument and 300 Hz in the 1250 MHz unit.

So why struggle with half the picture in circuit design? The 8553B 110 MHz

RF section costs \$2100; the 8554L 1250 MHz RF section \$3300. Use either of them with the 8552A IIF unit (\$2050) and a 141T Variable Persistence Display for high resolution (\$1700) and you have all the frequency information you need for the complete story in circuit design. Ask your HP field engineer for an applications brochure on this universal lab tool for circuit design and measurement. Or write to Hewlett-Packard, Palo Alto, California 94304; Europe: 1217 Meyrin-Geneva, Switzerland.

04006

HEWLETT  PACKARD
SIGNAL ANALYZERS

INFORMATION RETRIEVAL NUMBER 55

Solve op-amp slew-rate requirements

from voltage and frequency specifications.

This nomogram provides the answer directly.

The limiting specification in the use of an op amp for large-signal operation is the slew rate. Applications that require a large sine-wave output are usually specified in terms of voltage output required at the required frequency while the slew rate is specified in volts per microsecond ($V/\mu s$). The nomogram below will determine the

op-amp slew rate necessary when the output voltage swing and frequency are known. The nomogram is based on a sine-wave output and is derived from the relationship

$$\text{slew rate} = (de/dt)_{\text{max}} = \omega E_{\text{max}}$$

where $e = E_{\text{max}} \sin \omega t$.

As an example consider a 709 op amp, which typically has a slew rate of $0.3 V/\mu s$. If the desired maximum output is 10 V, zero to peak, then the maximum frequency is 4.7 kHz. ■■

Thomas Carmody, Engineer, PRD Electronics, Inc., Syosset, N. Y.

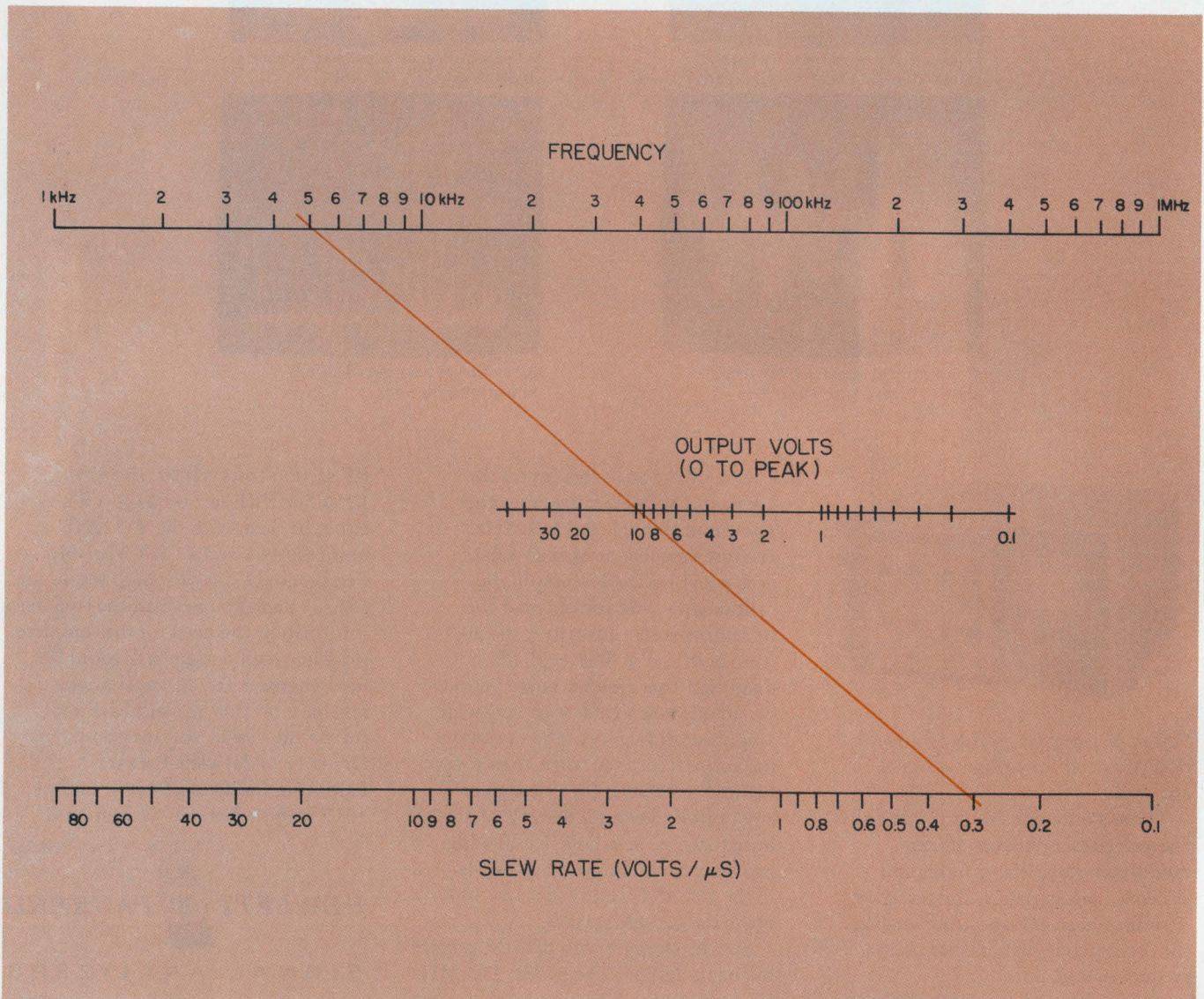

You can't beat the price/performance

(of this 0°-75°C Op Amp family)

RA-2525 High Slew Rate = ± 120 V/ μ s

Input Offset Voltage = 5 mV
Voltage Gain = 15,000 V/V
Large Signal Bandwidth = 1.6 MHz
Input Impedance = 80 Megohms
Gain Bandwidth = 25 MHz ($A_v = 1$)

\$14.00*

RA-2605 Input Resistance = 300 Megohms

Input Bias Current = 15 nA
Voltage Gain = 150,000 V/V
Slew Rate = 7 V/ μ s
Fully Compensated
Short Circuit Protected

\$10.70*

RA-2911 Low Input Noise = 1μ V rms

Power Dissipation = 52 mW
Slew Rate = 5 V/ μ s
Gain Bandwidth = 7 MHz ($A_v = 1$)
Fully Compensated

\$3.50*

* 100 unit price

Now you can get what you've always wanted in an Op Amp... MIL spec performance at a commercial price. For more information on these exceptional IC's, call your nearest Radiation sales engineer. He'll help you *pick the best IC for the job.*

Lexington, Massachusetts (617) 862-1055
Norwalk, Connecticut (203) 853-3646
Frederick, Maryland (301) 662-5400
Oaklawn, Illinois (312) 423-6010
Dallas, Texas (214) 231-9031
Albuquerque, New Mexico (505) 268-3549
Palo Alto, California (415) 321-2280
Long Beach, California (213) 426-7687
P. O. Box 37, Melbourne, Florida 32901 (305) 727-5430

EXPORT SALES, DAGE CORPORATION, STAMFORD, CONNECTICUT

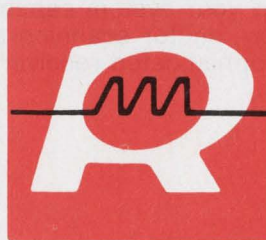

**RADIATION
INCORPORATED**

SUBSIDIARY OF HARRIS-INTERTYPE CORPORATION
MICROELECTRONICS DIVISION

INFORMATION RETRIEVAL NUMBER 56

Plan-It-Yourself Kits for MICROWAVE RECEIVING SYSTEMS

Choose from:

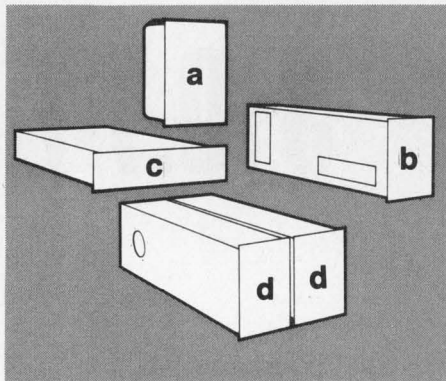
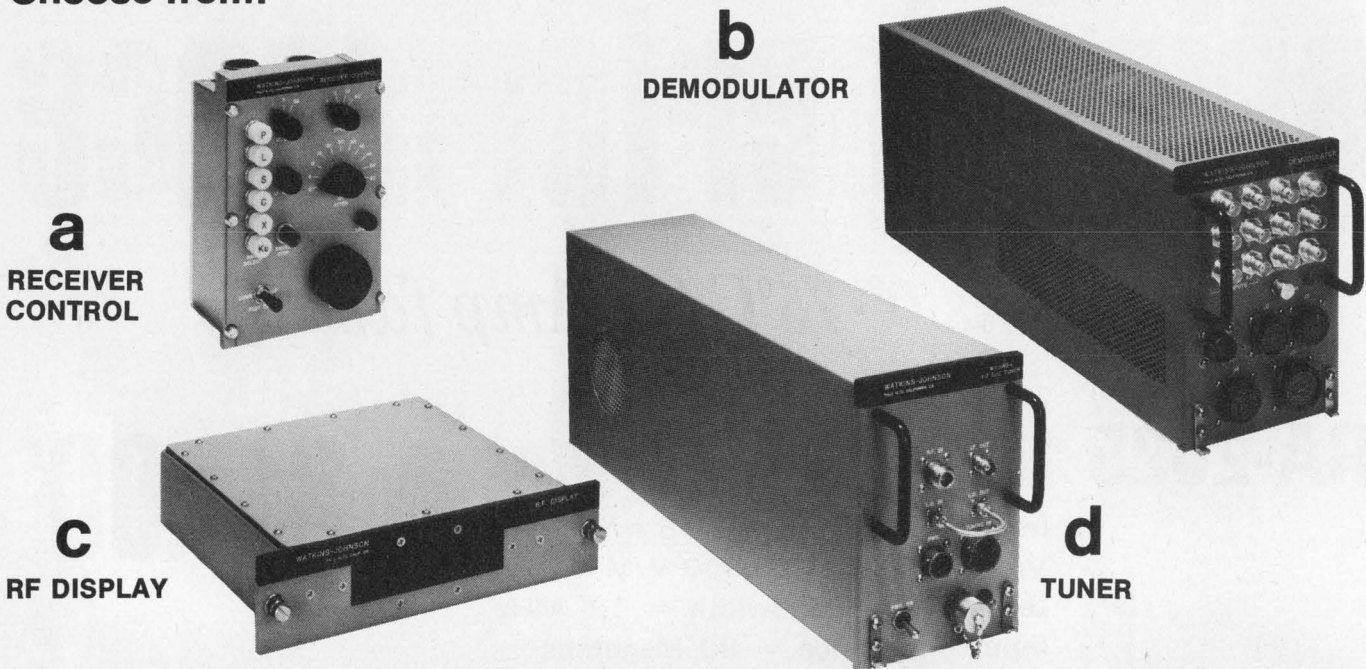

1-4 GHz

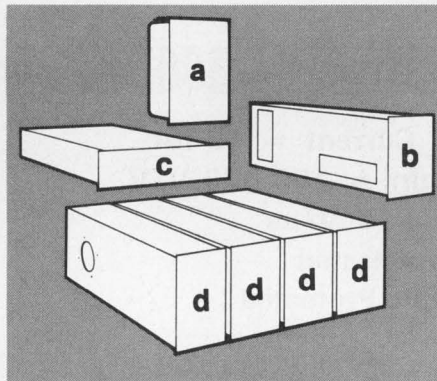

1-12 GHz

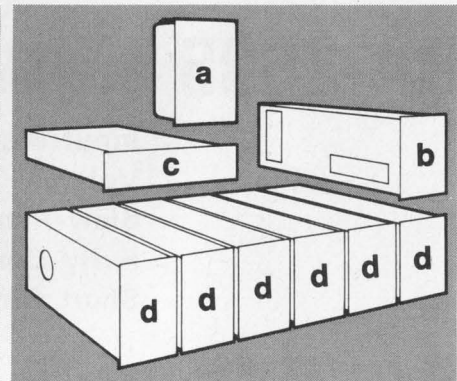

0.5-18 GHz

Now you can specify exactly what you need, and get exactly what you specify. It's easy with the WJ-1140 Modular Microwave Receiving System.

The basic system consists of a control unit, a demodulator, a frequency display and any of six separate tuner modules, each covering one of the standard octave bands in the 0.5 to 18 GHz frequency range.

You select the frequency coverage you want, then take only the equipment you need to build a customized acquisition and analysis receiver capability. When your frequency requirements change, simply change tuners.

And if you decide to expand your system capability, a number of options, including modules for display, sector scanning and computer control, are available to meet the most sophisticated receiver requirements.

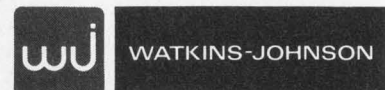

3333 HILLVIEW AVE., STANFORD INDUSTRIAL PARK, PALO ALTO, CALIF. 94304 • (415) 326-8830

INFORMATION RETRIEVAL NUMBER 57

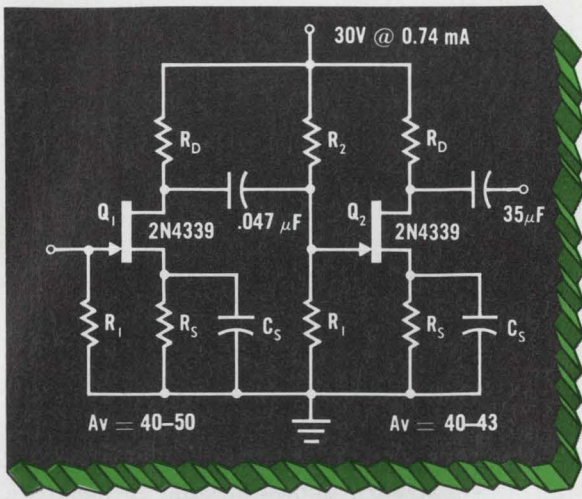

FET AMPLIFIERS SIMPLIFIED

Using the new "full data" sheets from Siliconix you can develop a circuit design like the one above without calculations! An amplifier design chart, for example, gives component values, required supply current, maximum output level and gain limits for a range of supply voltages.

Here's a portion of the chart from the 2N4338-41 series general purpose FET:

	V_{DD}	R_S	R_1	R_2	C_S	I_{DD}	R_D	e_o Max	A_v
Q ₁	30	1800	1M	∞	40 μ F	0.42 mA	51K	4.5V	40-50
Q ₂	30	9100	1M	13M	35 μ F	0.32 mA	43K	5.0V	40-43

Siliconix assumes no responsibility for circuits shown, nor does it represent or warrant that they do not infringe any patents.

In addition you get a full set of performance curves with data on noise, gate current, output conductance and, most important, limiting transfer and transconductance curves showing temperature effects. Now biasing, gain calculation and circuit design are as easy as reading!

Be sure you're on our list for these "full design" data sheets. Write or call the nearest office.

New York: Sy Levine (516) 796-4680
New England: Al La Croix (617) 762-8114
Ft. Worth/Dallas: Charlie Williams (214) 231-8151
St. Louis: Jim Spicer (314) 291-3616
Minneapolis: Ed Koelfgen (612) 920-4483
Southern California: Dave Ferran (213) 420-1307
Northern California: Chuck Brush (408) 246-8000



Siliconix incorporated

2201 Laurelwood Road • Santa Clara • California 95054
 Telephone (408) 246-8000 Extension 201 • TWX: 910-338-0227
 In Europe: Siliconix Limited, Saunders Way, Sketty, Swansea, Great Britain

Think sales engineering is your thing?

What if it isn't? This may help you to answer two key questions: Are you the type? What do you want to be doing in five years?

Although nearly a quarter of a million persons in the U. S. have invested time and tuition to become electronics engineers, thousands of them desert their profession every year to go into sales. For some, the step represents rewards, both in terms of earnings and personal satisfaction; to others, it is the beginning of a frustrating career with a limited future.

If you've been considering such a giant step, you should know that a sales career, like an iceberg, is never what it appears. Most of the details are below the surface.

Before making a decision in favor of selling, find out what you're getting into:

- Why some engineers go into sales.
- What a professional salesman is.
- What paths successful sales engineers have taken.
- What company officials look for in a salesman and the chief reasons many engineers fail as sales professionals.

Why engineers forsake engineering

What makes selling such an attractive career to some engineers?

Some of them are attracted to the money. According to Engineers Joint Council, the average salary range for electronics engineers in 1969 was from \$10,000 to \$18,000 per year. These engineers hear about the guy that used to work in the lab with them: he now makes \$34,000—and he wasn't even a good engineer.

Others switch to sales because they feel they can't keep up with the changes in technology.

Still others make the change because they want to be their own boss, and a salesman is pretty much on his own most of the time.

And, of course, excessive layoffs help convince some engineers to consider other careers—sales among them.

In any case, many engineers go into selling for the wrong reasons. Perhaps the biggest mis-

take they make is in not understanding what is expected of them as a salesman and objectively appraising their own talents. Sales aspirants certainly wouldn't apply for a job in chemistry unless they had an understanding of what a chemist is, but they apply for a selling job without any knowledge of what a professional salesman is. So what is he?

Profile of a professional salesman

The professional salesman is in the business of communicating with people. To get the job done, he is going to need:

Technical Skills: He must have the basic technical skills, either through formal education or experience, to learn enough about the product to sell it. A basic knowledge of accounting, for example, might be required to sell business machines. Most engineers have the qualified skills.

Empathy: Can he put himself in the customer's shoes? This is empathy, and a salesman without it never knows if he is convincing or alienating his client. All too often engineers lack empathy; they are too logical and count on their technical knowledge to win the order.

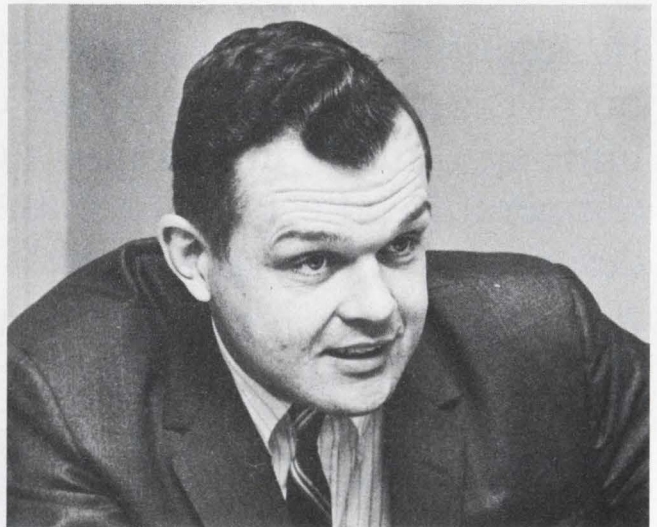

KELLIHER: "A series of vocational evaluation tests I took indicated that I was suited for sales."

Frank J. Burge, Vice President Marketing, Data Technology Corp., Palo Alto, Calif.

When I was a sales manager I made several calls with a bright engineer turned salesman. On the surface he had all the apparent skills needed to be a successful salesman, but he was consistently the man with the poorest sales record.

On one call, it was obvious to me that the prospect actually preferred a competitor. But our engineer turned salesman didn't even sense he was about to lose an order nor why. He lacked empathy.

It is almost impossible to develop empathy. Do you have it?

Winner's Attitude: The Mets found it, Vince Lombardi almost invented it, and you've seen it in every sales pro. It's the ego drive that refuses to accept defeat. The professional uses his empathy to identify and clarify objections. His winner's attitude drives him to do what is necessary to overcome the objections and close the order. It may mean that he has to persuade the factory to give him extra support, or that he has to spend long hours rewriting his proposal. Whatever it is he does it because he has confidence in his own ability to close the sale.

This pro feeds on his success and gets stronger after every order. He is driven even harder by his failures. The engineer turned salesman without the winner's attitude is usually shattered by a loss; several losses in a row can destroy him.

Do you have a winner's attitude?

Engineering a road to sales

Because some engineers have the technical skills, and the intangibles empathy and winner's attitude, they make good in sales. Let's take a look at a few actual success stories.

Frank Kelliher; age 34; vice president, Scientific Devices Northeast; BSEE—Rensselaer Polytechnic Institute.

After a tour of duty in the Navy, Kelliher worked as a test-equipment design engineer for a major semiconductor manufacturer. He was eventually put in charge of the test-equipment department, with responsibility for the design and selection of all production test equipment.

Then he was offered the opportunity to go into sales with a manufacturer of test equipment for semiconductors as their East Coast sales engineer supporting reps from North Carolina to Canada.

Before he accepted the job, he checked his aptitude by taking a series of vocational evaluation tests at the University of New Hampshire (where he was working on his engineering master's degree). The results indicated that he was suited for sales. Kelliher admitted that at first he had to swallow his pride since the thought of the transition from professional engineer to

"peddler" was a difficult emotional step to take. Now he considers himself a sales professional.

In looking back, Kelliher says that the biggest benefit from his early days in selling was that, because he was on his own, he had to learn to manage himself. He made his own schedule, set his own objectives, and had to measure his own performance on a daily basis. That was a big step, and Kelliher feels that it's the best lesson to be learned when making the transition from the lab to the field.

Frank J. Burge; age 35; vice president marketing; Data Components Group, Data Technology Corp.; BSEE—University of Notre Dame.

After graduation, Burge went into a computer training program with one of the large East Coast computer companies. After a tour of duty in the Coast Guard, he joined a midwest communications company and worked on the Air Force 465L computer-controlled communications system. In 1960, he moved to California and, at age 25, started his career in sales because he felt he could make more money with his "people" skills than with his technical skills. He sold high-speed data-acquisition and telemetry systems. In 1963, he was the top salesman for the company.

According to Burge, he had wanted to be a salesman as early as 1958, but when he tried to transfer into sales with the computer company, he flunked the aptitude tests. "They asked me if I wanted to be a professional golfer, a butcher, or a policeman. I said, 'Why not? I guess I could be happy doing those things if I had to.' Instead I should have said, 'No, I want to be a salesman.' Anyway, I didn't make it into sales in '58."

Burge felt the greatest thrill came when he

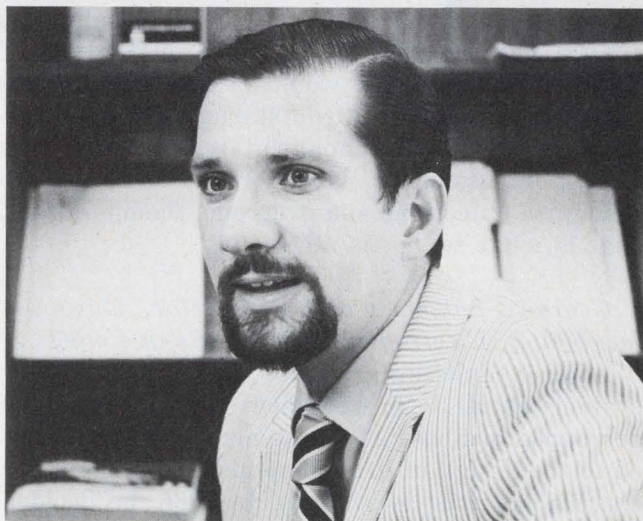

BURGE: "I felt I could make more money with my 'people' skills than with my technical skills."

was given accounts that no one had ever been able to sell before. It was intended as a good training ground, but Burge brought in about \$2.1 million from these accounts in the next 18 months.

"It was like a game. All I did was listen, frankly admit when I didn't know the answer, and try to figure out what this guy really wanted to own. In every case, the prospect had different reasons for wanting to own our equipment. My competitors were selling data-acquisition systems, while I was selling accuracy or ease of maintenance or whatever benefit that was most important to the customer."

Ron Johnson, age 25; sales engineer; Electronic Marketing Specialists; BSEE—Healds Engineering College.

Johnson joined Data Technology as a junior engineer working in the Digital Data Group, and within two years he was project engineer on special logic systems. He decided to make sales a career because he was getting bored in engineering, and it seemed as if the sales and marketing people were having all the fun. When Data Technology went to a direct sales force in California for its line of logic cards and computer-aided design and packaging services, Ron went into sales. When the company went back to reps, he became a salesman for a rep firm.

Ron recalls that in his first sales call he was scared to death. To make matters worse, he hardly had introduced himself when he was given the brush-off: "Sorry, I don't need any of that stuff."

He lost a great deal of confidence but went out and tried again. After five calls that day, he found two prospects that would at least listen to his presentation. Before long more prospects were listening, and some were even turning into customers. Although Ron has been in sales less than a year he advises, "If you are thinking of a career in selling, I would recommend a sales training course before you start. Without an understanding of the fundamentals, a tough job is almost impossible. It is important to be able to recognize objections and overcome them—in fact, that is what selling is all about."

George Shukov; age 31; director, European marketing, Electroglass; BSEE—Fenn College.

After completing graduate studies in computer systems at MIT, Shukov spent four years in the aerospace business as a systems engineer assigned to the design of ground-support equipment for checkout of missile systems. In 1966, he decided on a career in sales, mostly because he was shooting for a tour of duty in Europe and felt that sales was the easiest way to get there. George was born in Europe and speaks fluent German,

French, Russian, and Hungarian.

His first assignment was in Los Angeles, working for a systems house selling to the aerospace companies in Los Angeles and San Diego. His first year in sales was a successful one. Shukov says of his technical abilities: "I understood not only the product line I was selling, but also the customer's application. I could show him how he could solve his problem."

After a year in Los Angeles, the company decided to open up an office in Chicago, and Shukov claims he was selected because he was a bachelor. "A bachelor wouldn't mind spending his life on an airplane, and that is what I did for 18 months. (His bride of one year is an ex-stewardess). At the end of 18 months, he increased sales by \$1,300,000 and developed the company's largest single account.

Looking back, Shukov says his biggest step came when he called on the top management of one of the major computer companies to negotiate a corporate agreement that included this company's plants throughout the world.

"Until then I had been selling primarily to technical people, but here was the top dog who didn't know or even care about test speed and accuracy. This was an entirely different sell, and quite frankly at first I was scared. After that experience, I felt equally at home with a project engineer or the president of a large company. In fact, I think some engineers turned salesmen spend too much time with the technical types and not enough time with the management people who are making the policy."

What the sales bosses say

Any description of what it takes to succeed in sales engineering is not complete, of course, unless it includes comments from representative members of sales management. What, then, do the men who do the hiring and firing of salesmen have to say about the ingredients needed to succeed?

Bernie Marren, director U. S. sales at Fairchild Semiconductor says: "As products become more technical we dip into the engineering ranks for our salesmen. After all, a customer really wants a problem solved. Our biggest hiring problem relates to our inability to measure *drive*. We can test and interview for intelligence, technical skills, personality and, to some extent, empathy, but we have been unable to find a way to positively identify if the guy is a self-starter. To be a sales professional, *drive* is essential.

Marren went on: "We have started a program trying to identify what it is that makes salesmen successful. We are testing the top performers, the average performers, and the marginal performers with the hope that it will permit us to

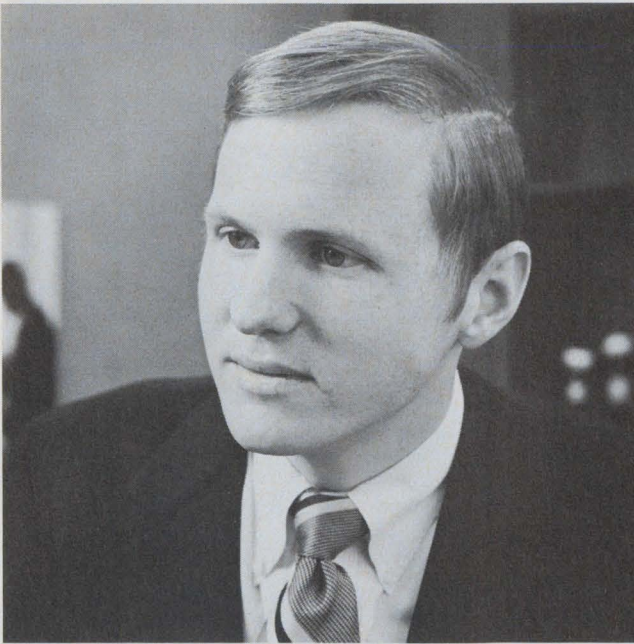

JOHNSON: "I decided to make sales a career because I was getting bored with engineering."

do a better job of selection. We have had cases of outstanding performers in product marketing who have been sent into sales and were failures. When we brought them back to marketing, they were again top performers. We do know that the supertechnical guys sometime lack empathy and end up selling down to the customer. The customer wants a problem solver, not a dictator.

"There is another type of salesman," he said, "who usually ends up doing a mediocre or poor job, and that is the guy who decided he has to put in two years in sales as part of his career plan. This chap is much like the draftee who goes through the motions for his tour of duty. It all gets back to motivation, or drive—and for the short-timer the motivation doesn't seem to be there."

David Pivan, president of Pivan Engineering (manufacturer's representatives) says: "We specialize in application selling, (i.e. a minicomputer system in a process control environment). This type of selling requires the sales engineer to have expertise in the utilization of the product. Potential sales candidates are engineers with three to five years in engineering and, of course, men that can develop the other essential sales skills.

"We look for men," says Pivan "who are inquisitive, have imagination, broad interests, and want a lot of things. We have found that the guy that wants an airplane or a boat usually has the drive it takes to earn them. The fellows that are satisfied with what they have usually don't have the drive.

"We have seen a number of engineers fail when they go into sales because they really don't like people the way they thought they did. It's

one thing to be friendly, but still another to spend every hour of every day selling people, and, in some cases, working with people who are not enthusiastically supporting you. Selling involves people, and unless you are genuinely comfortable in a constant environment with people you are probably making a mistake by getting into sales."

Peary Nelson, vice president/marketing, of Semiconductor Specialist (distributor), says: "Although we are a distributor, we hire engineers and senior technicians for our outside sales force. We give every candidate an intelligence test and look for three things in our interviews."

These qualities are, he explained:

1. *Sales Personality*: How well does the applicant sell himself? More importantly, has he already sold himself to himself? In the interview, we do a pretty thorough job of asking questions, and some of them are tough to answer. How well does he stand up under this sort of inquisition?

2. *Technical Skills*: We evaluate a candidate's college grades and technical proficiency during his work history. We also test all candidates to verify their technical competence.

3. *Diligence*: This is a tough quality to identify, but we need people who are willing to work hard. A good insight comes from chatting with former associates and employees.

"In our experience," said Nelson, "some engineers fail to make it in sales simply because they didn't understand the role of the salesman when they started. Some never learn to qualify an account to find the real decision makers or identify the dominant buying motives. Others never learn to manage their time or assign priorities. They spend too much time on the unimportant things and completely neglect the job that means the most to their success. Usually they spend too much time calling on friends and not enough time with the guy that gives them a bad time but represents a lot of business."

Is selling really your thing?

A sales career can be interesting, even exciting, but it can also be frustrating. Before you jump into selling, take the time to learn more about the profession. Talk to the salesmen and sales managers and find out what will be expected of you. Try to determine if you've really got the drive needed to carry through. Be sure to evaluate your own abilities—not only your technical skills, but your "people" skills. Remember that a good salesman likes people.

But keep in mind that the worst mistake of your engineering career would be for you to leave the profession you've trained so hard and long for, only to discover too late that the world of the salesman, is for you, uninhabitable. ■■

Buckbee-Mears took a 60-year-old technique and created parts for a rocket engine chamber.

Pratt & Whitney Aircraft is mighty happy we did.

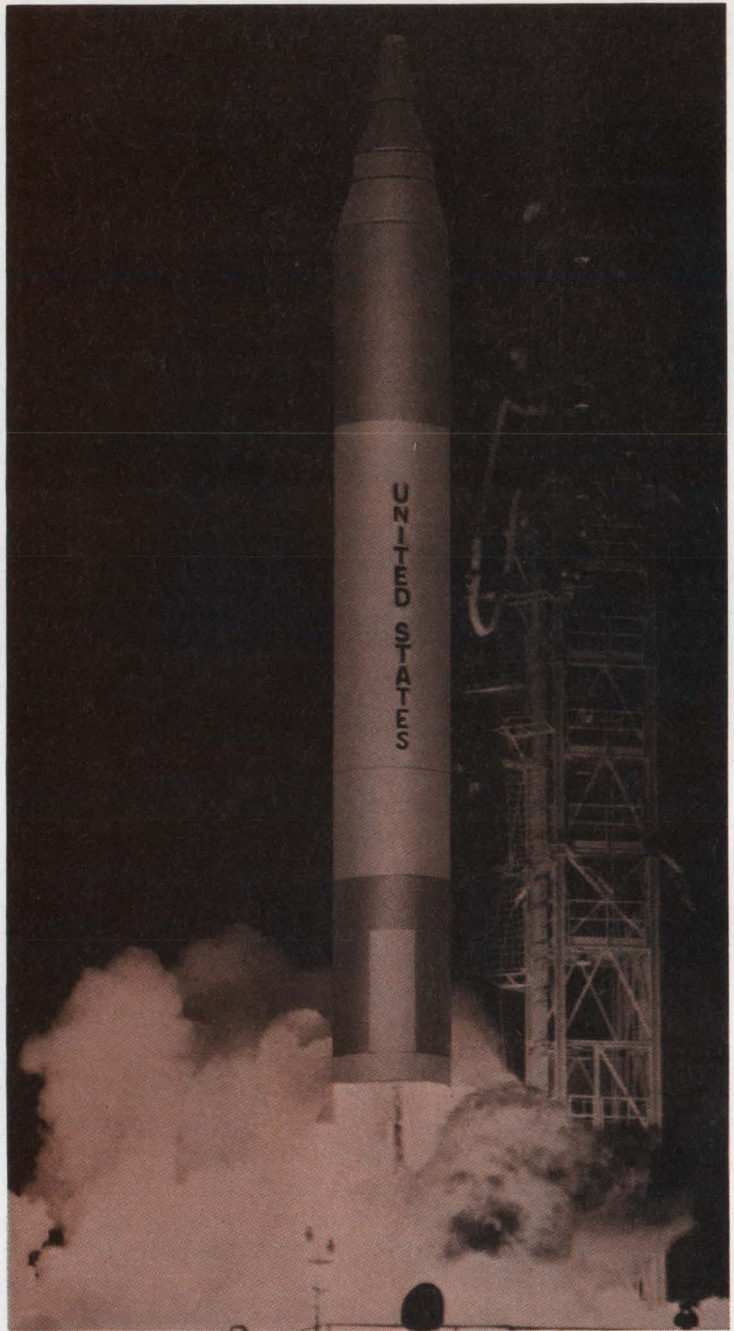

The original technique was photoengraving. But it took Buckbee-Mears ingenuity to refine it for etching passages in a Pratt & Whitney Aircraft advanced rocket engine thrust chamber. The movement of fuel through the passages also serves as a coolant.

Today we call the process chemical machining. Buckbee-Mears can chemically machine on metal any design that can be drawn in a line. In the case of Pratt & Whitney Aircraft, the design was precisely machined on duplicate pieces of metal and then joined to create the thrust chamber for a propellant.

Buckbee-Mears offers chemical machining to very close tolerances. Depth of the etch can be up to one half the

width of the groove. Tolerance on groove width is $\pm 10\%$ of the depth of etch.

Because chemical machining is such a versatile technique, the applications are many. You might be able to use it for weight removal, grooves for guiding wires for automatic core loading, print out devices, or etching channels in a surface.

At Buckbee-Mears, your special problems or needs are given personal attention. That's why Buckbee-Mears is the world leader in photomechanical reproduction. If you have a problem that might be solved by precision chemical machining, call or write Bill Amundson, industrial sales manager in St. Paul. The number is 612-227-6371.

PRECISION METAL AND GLASS ETCHING • ELECTROFORMING • AUTOMATED DESIGN
bmc BUCKBEE-MEARS COMPANY
SAINT PAUL, MINNESOTA 55101

INFORMATION RETRIEVAL NUMBER 58



We took Honeywell's 2206 Visicorder to Pike's Peak!

Where do you need to take one? To prove that our incomparable 2206 Visicorder goes anywhere, we connected it to something just as incomparable... a pair of Hart Javelin skis instrumented with STATHAM transducers. And skied Pike's Peak.

Because our oscillograph records up to 12 channels simultaneously, as well as two event channels, we were able to record several parameters incurred while skiing (see actual record below). Which means that no matter how unusual your oscillograph needs, our 2206 Visicorder can meet them. Wherever they happen to be.



Use it on a test bench. Mounted in an automobile. Or boat. Wherever portability's important! It's light-tight (with integral take-up) and records at frequencies from 0 to 13kHz. On 150 watts. Which means you can use an ordinary vehicle electrical system or separate batteries as your power source.

And the 2206 Visicorder uses a mercury vapor lamp for true ultraviolet recording. So, you get high writing speeds — over 40,000 in/sec. Better trace density. And more permanent records, with no chemical processing necessary. Plus, an optional signal conditioning amplifier package that fastens right to the Visicorder!

You don't have to take the 2206 Visicorder to Pike's Peak to get peak performance. You pick the place. Pick up the 2206 Visicorder. And see for yourself.

For more information, call or write Lloyd Moyer, (303) 771-4700, MS 222, Honeywell, Test Instruments Division, P. O. Box 5227, Denver, Colorado 80217.

Honeywell

Honeywell engineers sell solutions

HOONEYWELL INTERNATIONAL

Sales and Service offices in all principal cities of the world. Manufacturing in Australia, Canada, Finland, France, Germany, Japan, Mexico, Netherlands, Spain, Taiwan, U.K. and U.S.A.

BASIC program designs bias circuits

This program solves the circuit equations for a stabilized, self-biased transistor operating as a class A amplifier under small-signal conditions.^{1,2,3}

The factors considered are:

- Type of transistor (silicon or germanium).
- The manufacturer's specified spread of current gain, beta or h_{fe} , at the operating point for the transistor used.
- The variation of beta with temperature. For this, a typical measured variation was approximated with an analytic function.
- The variation of collector leakage current I_{cbo} with temperature. Again typical curves were approximated with analytic functions.
- The variation of base-to-emitter voltage drop V_{be} with temperature. Under normal conditions, V_{be} at 25°C is about 0.2 V for germanium and 0.7 V for silicon with temperature dependence of -2.5 mV per degree C.
- The variation of circuit element values due to tolerances.

The generalized circuit contains three resistors and two batteries. This is later converted by Thevenin's theorem into a more practical circuit using four resistors and a single battery. The method of solution involves writing the circuit equations at both temperature extremes and

solving simultaneously for the values of the bias battery and base resistor, with the assumption that $I_{cbo} = 0$ at the low temperature extreme.

Input quantities required are:

- Minimum and maximum temperatures (degrees C).
- Minimum and maximum beta at 25°C.

```

70 PRINT "FOR SILICON TRANSISTOR, ENTER 1, FOR GERMANIUM, ENTER 0:"
80 INPUT S
90 PRINT "ENTER MIN. & MAX. DESIGN TEMPERATURES, MIN. & MAX. BETA"
100 INPUT T1,T2,H1,H2
110 PRINT "ENTER SUPPLY VOLTAGE, EMITTER RESISTOR, RES. TOLERANCE IN %"
120 INPUT V0,R4,P
130 PRINT "ENTER V(CE), I(CBO) IN MA, MIN. AND MAX. I(E) IN MA"
140 INPUT V1,I0,I1,I2
150 LET I1=I1*(1+.03*P)
160 LET I2=I2*(1-.03*P)
170 LET H1=H1*.865*EXP(.00575*T1)
180 LET T3=T2-25
190 LET H2=H2*(.865*EXP(.00575*T2)-(S-1)*(-.00895-.00565*T3+.00048*T3^2))
200 IF S=1 THEN 220
210 LET I0=I0*EXP(.075*T3)
220 LET R3=2000*(V0-V1)/(I1+I2)-R4
230 LET R6=((I2-I1)*R4+2.5*(T2-T1))/(I0+I1/(H1+1)-I2/(H2+1))
240 IF R6>0 THEN 270
250 PRINT "I(E) RANGE TOO NARROW"
260 STOP
270 LET V6=I1*.001*(R6/(H1+1)+R4)+.2+.5*S-.0025*(T1-25)
280 PRINT
290 PRINT "BIAS VOLTAGE=";V6;"VOLTS"
300 PRINT "BIAS RESISTOR=";R6;"OHMS"
310 PRINT
320 PRINT "FOR STABILIZED BIAS CIRCUIT:"
330 PRINT "R(B-VCC)=";V0*R6/V6
340 PRINT "R(B-GND)=";V0*R6/(V0-V6)
350 PRINT "R(COLL.)=";R3
360 PRINT "R(EMITTER)=";R4
370 END
    
```

1. Stabilized transistor bias networks can be designed using this program written in BASIC.

RUN
BIAS

FOR SILICON TRANSISTOR, ENTER 1, FOR GERMANIUM, ENTER 070
ENTER MIN. & MAX. DESIGN TEMPERATURES, MIN. & MAX. BETA
7-30,60,50,150
ENTER SUPPLY VOLTAGE, EMITTER RESISTOR, RES. TOLERANCE IN %
710,2000,5
ENTER V(CE), I(CBO) IN MA, MIN. AND MAX. I(E) IN MA
75.,002,.78,1.18

BIAS VOLTAGE= 2.35223 VOLTS
BIAS RESISTOR= 9202.79 OHMS

FOR STABILIZED BIAS CIRCUIT:
R(B-VCC)= 39123.6
R(B-GND)= 12033.3
R(COLL.)= 3263.16
R(EMITTER)= 2000

(a)

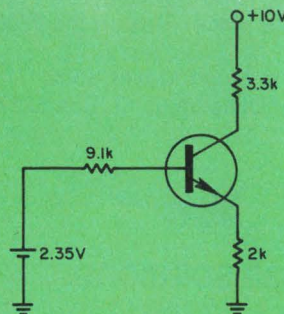

(b)

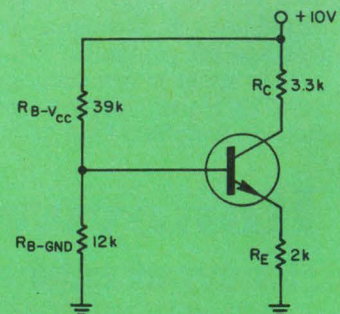

(c)

2. A typical bias network design is performed in (a), and the resulting bias current is shown in (b).

After suitable manipulation by the program, the practical circuit of (c) results.

SUDDENLY ALL OTHER VOLTAGE REGULATORS ARE SECOND BEST.

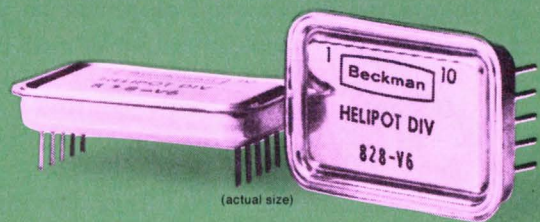

HERE'S WHY:

- $\pm 0.01\%$ line & load regulation
- $\pm 0.5\%$ preset output voltage
- Short-circuit proof
- MIL-STD-883 hermetic package
- \$40 (1-9 quantity)
- Model 828 (plus) and Model 838 (minus) from stock
- Many other outstanding features; contact your local Helipot representative.

Beckman®

HELIPOT DIVISION

FULLERTON, CALIFORNIA • 92634

INTERNATIONAL SUBSIDIARIES: AMSTERDAM; CAPE TOWN; GENEVA; GLENROTHES,
SCOTLAND; LONDON; MEXICO CITY; MUNICH; PARIS; STOCKHOLM; TOKYO; VIENNA

- Supply (collector) voltage V_{CC} .
- Emitter resistor in ohms.
- Component tolerance in per cent.
- Quiescent operating point, specified by V_{ce} and allowable minimum and maximum I_e in milliamperes.
- Collector leakage current I_{cbo} in milliamperes at 25°C.

The program computes the required values of the base resistor and bias battery for the two-battery circuit, and of all four resistors.

References

1. *General Electric Transistor Manual*, 7th Edition, General Electric Co., N. Y., 1964.
2. Golden, M. G., "Design Bias Circuits with Nomographs," *Electronic Design*, ED 9, April 26, 1969, pp. 66-71.
3. Brown, W. L., and Perrine, D. E., "Don't Guess at Bias Circuit Design," *Electronic Design*, ED 10, May 9, 1968, pp. 80-86.

Charles H. Popenoe, *Physicist, U. S. Dept. of Commerce, National Bureau of Standards, Washington, D.C.*

VOTE FOR 311

Dual-channel i-f strip tracks without gain matching

The two i-f channels of a dual-channel receiver are often required to amplitude-track within a close tolerance over large dynamic ranges. A method of doing this without gain-matching the two channels is to compare their detected outputs in a differential amplifier. The resulting signal is used to operate a voltage-controlled attenuator (VCA) in the channel without automatic gain control (agc), thus holding any amplitude unbalance between the two channels to a very low level.

The required differential amplifier gain may be calculated as follows:

$$A_V = \Delta V_c / (V_{D2} - V_{D1})$$

where: A_V = required voltage gain, ΔV_c = open loop control voltage necessary on the VCA to bring its outputs within the specified tolerances and V_{D1} , V_{D2} = closed loop detector output voltages with the required amplitude match.

An integrator can be connected between the VCA and the differential amplifier so the circuit can work with either pulses or cw. As long as an amplitude difference between the two channels exists, the integrator will continue charging. When the two channels are balanced, the integrator holds the correct VCA control voltage for channel balance, since the integrator input signal is now zero.

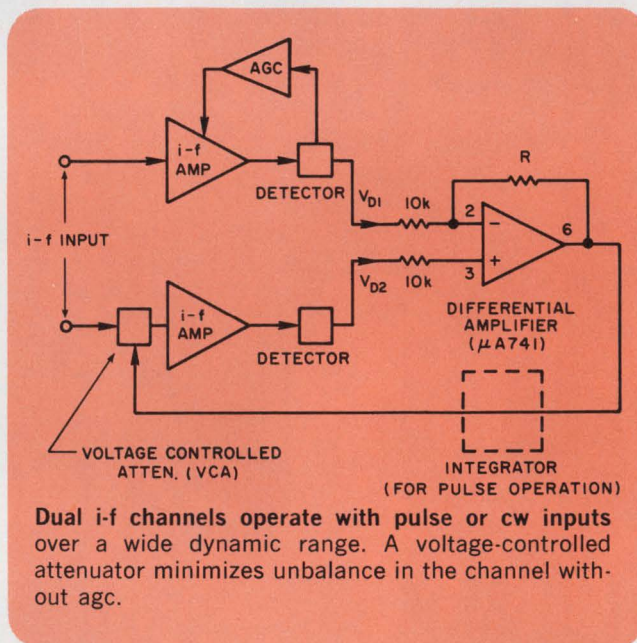

Dual i-f channels operate with pulse or cw inputs over a wide dynamic range. A voltage-controlled attenuator minimizes unbalance in the channel without agc.

This circuit has been used to control two channels within ±1 dB over a 65 dB agc range.

W. T. Weaver, *Specialist, LTV Electrosystems, Greenville, Tex.*

VOTE FOR 312

Transformer temperature found from winding resistance

Have you ever wondered just how hot your power transformer really gets inside, where it counts? Here's a technique for evaluating transformer internal winding temperature quickly and accurately.

The resistance of copper wire varies linearly with temperature according to the well known equation

$$R_{T1}/R_{T2} = 1 + \alpha_{T2} (T1-T2)$$

Where R_{T1} is the resistance of the wire at tem-

NEW AUTO-POLARITY FET V-O-M SPEEDS TESTING

You've probably imagined the convenience and time-saving you'd enjoy if you could just clip one of the V-O-M leads to ground or to the chassis, and have your meter always read upscale regardless of the polarity of any other terminal you touched.

No need to imagine it any more . . . you can see it and try it right now at your Triplet distributor. Called the Triplet Model 602, it's probably the most convenient V-O-M ever built. Its convenience goes well beyond the auto-polarity feature, though . . . to AC and DC measurements from 10 mV to 1000 V in 8 ranges at 11 megohms DC and 10 megohms AC input resistance . . . AC and DC from 0.02 to 1000 mA in 4 ranges . . . resistances from 0.2 ohms to 1000 megohms in 6 ranges. And with an accuracy of 3% on voltage measurements, and a rugged suspension-type meter movement, the Model 602 has what it takes to make your job easier.

This great new V-O-M is only **\$100** suggested USA user net. For more information, or for a free, no-obligation demonstration, call your local Triplet distributor or your Triplet sales representative. Triplet Corporation, Bluffton, Ohio 45817.

TRIPLET

The World's most complete line of V-O-M's . . . choose the one that's just right for you.

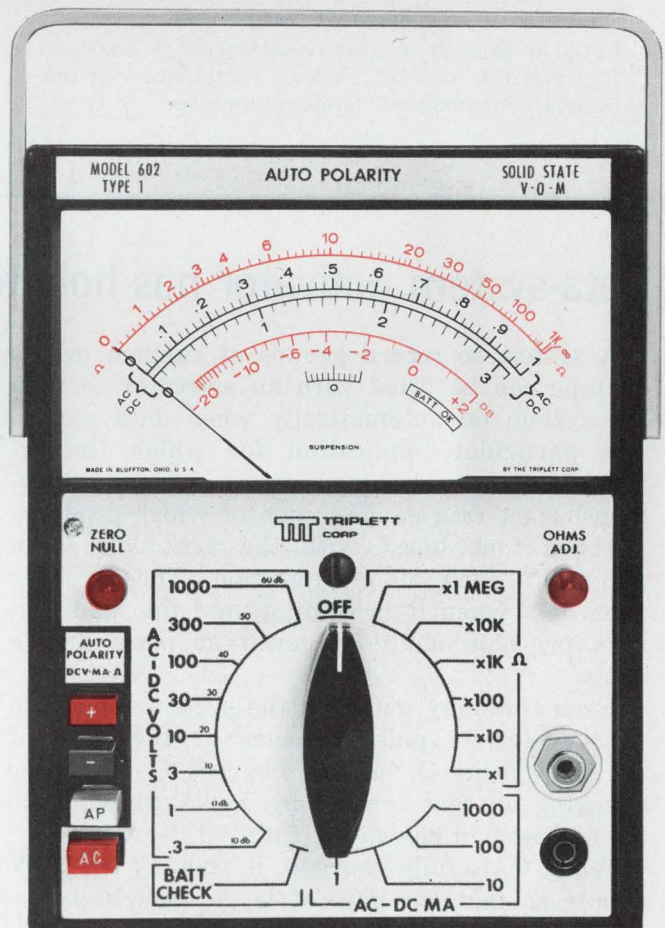

1. Auto Polarity . . . convenient and time-saving; creates memory and suppressed scale.
2. High sensitivity (.3V AC and DC) at constant 11 megohms input resistance.
3. Simplified scale with only 2 arcs for 24 AC/DC ranges.

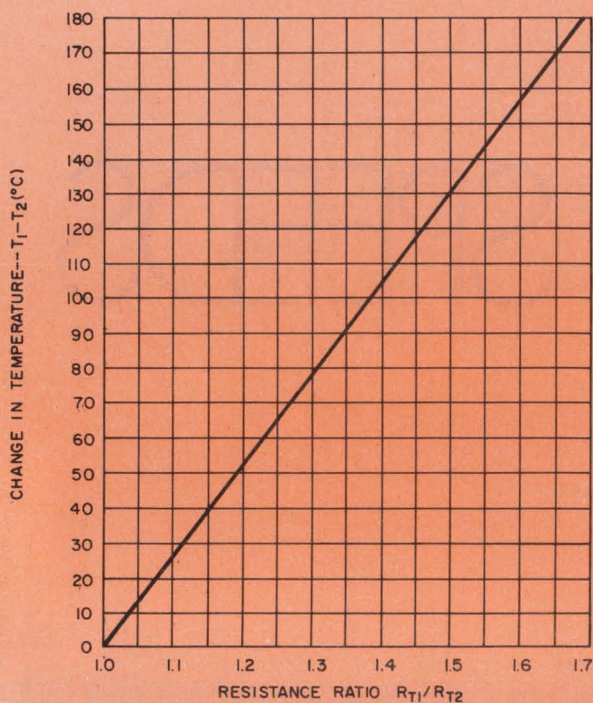

Ratio of primary winding resistances at no load, R_{T2} , and full load, R_{T1} , allows computation of the transformer's internal temperature rise.

perature T_1 , R_{T2} is the resistance of the wire at temperature T_2 and α_{T2} is the temperature coefficient of the wire at temperature T_2 . For a typical transformer wire, $\alpha_{T2} = 0.00382$ when the temperature is 20 degrees centigrade. The graph shown is the equation plotted for this value of α_{T2} .

To find the temperature rise internal to the transformer, first measure the primary winding resistance, R_{T2} , at room temperature. Then run the transformer under the desired load conditions for several hours to stabilize temperature. Quickly disconnect the transformer and again measure the resistance, R_{T1} . Compute the ratio R_{T1}/R_{T2} and find the temperature rise from the graph. This curve should be accurate within $\pm 2^\circ\text{C}$ for most transformers, but if more precision is desired, the unenergized transformer can be heated to a series of predetermined temperatures while the winding resistances are measured for each increment. A custom curve similar to the figure shown can then be easily made.

Seymour N. Rubin, Senior Engineer, Systron-Donner, Datapulse Division, Culver City, Calif.

VOTE FOR 313

Data-system activator has hold feature

A system to record groups of random events on tape can be fitted with an activator to turn the system on automatically when data occurs. The particular application for which the arrangement was designed was a system of tipping-bucket rain gauges, each of which produces a coded tone burst with the arrival of each hundredth inch of precipitation. The recorder runs only when it is raining, and the hold feature prevents shutdown even at mere drizzle rates.

Each time any gauge in the system reports, a +12-V 200-ms pulse appears at the base of Q_1 . This turns Q_1 on and charges C_1 , with the charging current limited by R_1 . A pulse of 20 ms or less will charge C_1 fully.

When C_1 is fully charged, it "bucks" the 12-V supply so that the gate of Q_2 is brought below pinchoff, and Q_3 becomes forward-biased, turning the system on. A relay was used as a simple expedient to switch both 12 V dc and 115 V ac. Each succeeding time data occurs, C_1 is charged fully so that the hold time always extends from the last data occurrence.

Selectable timing resistances permit adjustment to various data rates. The resistance-time relationship is very close to

$$R = (0.0212 \text{ M}\Omega/\text{s}) T$$

for the particular capacitor and FET used. Q_1

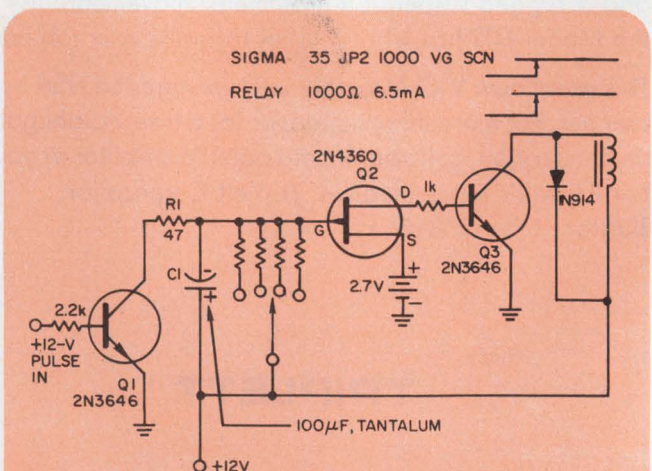

C_1 becomes fully charged each time an input pulse is received, so that Q_3 is forward-biased by FET Q_2 .

CELANESE NYLON IS MADE IN A TOTALLY CONTINUOUS PROCESS. THAT'S ADVANTAGE NO. 1.

Whiteness. We make Celanese nylon in a continuous, patented process—so it has a shorter heat history. That's why it's whiter in the pellet. Whiter in your products. And it's whiter through successive regrinds.

It's one advantage that Buchanan Electrical Products Corporation gets by using Celanese nylon for terminal blocks, connectors—some 30 other electrical parts.

Other reasons for using Celanese nylon include high



dielectric properties, which allow thinner walls, more compact units. Great mechanical strength and toughness. Resilience, for parts that have to snap-fit. Hold. Celanese nylon is self-extin-

guishing. And it has U/L rating on electrical properties of 105°C.

In fact, Celanese nylon has all the best properties you expect in nylon. Without the yellow. Write for a copy of our brochure on electrical applications of Celanese nylon. Also a U/L Yellow Card. Celanese Plastics Company, Dept. N-500, 1090 Lousons Rd., Union, New Jersey 07083.



Celanese Plastics Company is a division of Celanese Corporation. Canadian Affiliate: Chemcell Resources, Ltd. Export: Amcel Co., Inc., and Pan Amcel Co., Inc., 522 Fifth Ave., New York 10036.

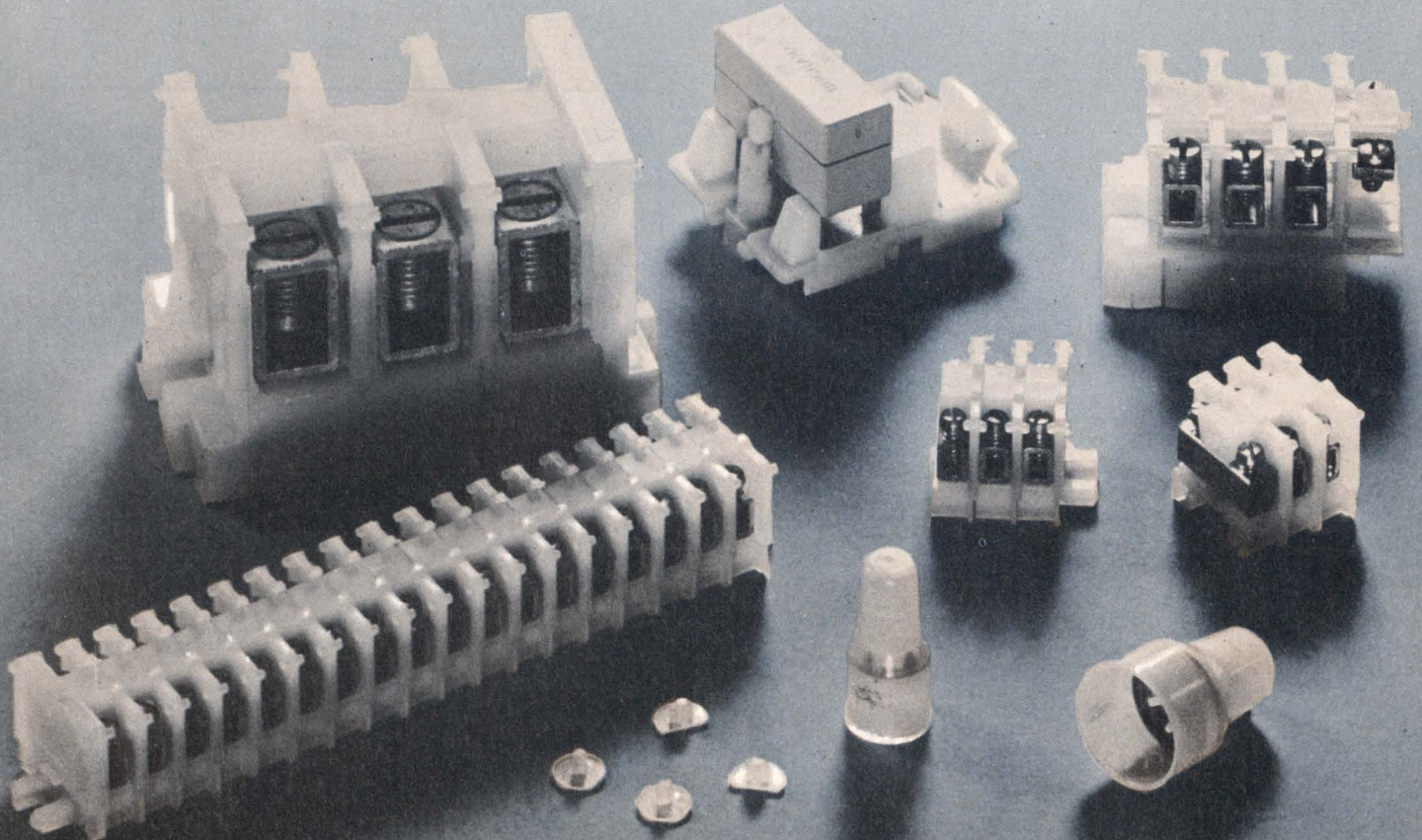

leakage is nearly equal to discharge leakage, so that 100 MΩ nominal holds for just over 1 hour 19 minutes, still in good agreement with the formula.

Current drain on standby is negligible from both the ±12-V supply and the two mercury bias cells (2.7-V supply). However, hold time is

an inverse function of supply voltage, so that for accurate timing, operation from a regulated supply is essential.

Julian M. Pike, Scientist, National Center for Atmospheric Research, Boulder, Colo.

VOTE FOR 314

Exclusive-OR gate doubles VCM output frequency

In some designs it is necessary to generate frequencies beyond the capability of existing system components. For example, in a phase-locked-loop digital frequency synthesizer, the maximum obtainable frequency from a voltage-controlled multivibrator (VCM) can be doubled by taking advantage of the "mixing" characteristics of an exclusive-OR gate (a).

For square waves, it can be shown that if two

different frequencies are applied to separate inputs of a two-input exclusive-OR gate, the resulting output contains the sum and difference frequencies but lacks the input frequencies. If the two inputs are the same frequency but separated in phase by 90°, the output of the gate is a square wave of twice the input frequency.

Waveform relationships are shown in the timing diagram. The required 90° phase shift is obtained by connecting the phase detector (normally part of a phase-locked loop) in the VCM loop as shown. The phase detector must be capable of handling square waves. In this system the detector was implemented digitally (b).

Ron Treadway, Design Engineer, Motorola Semiconductor Products, Phoenix, Ariz.

VOTE FOR 315

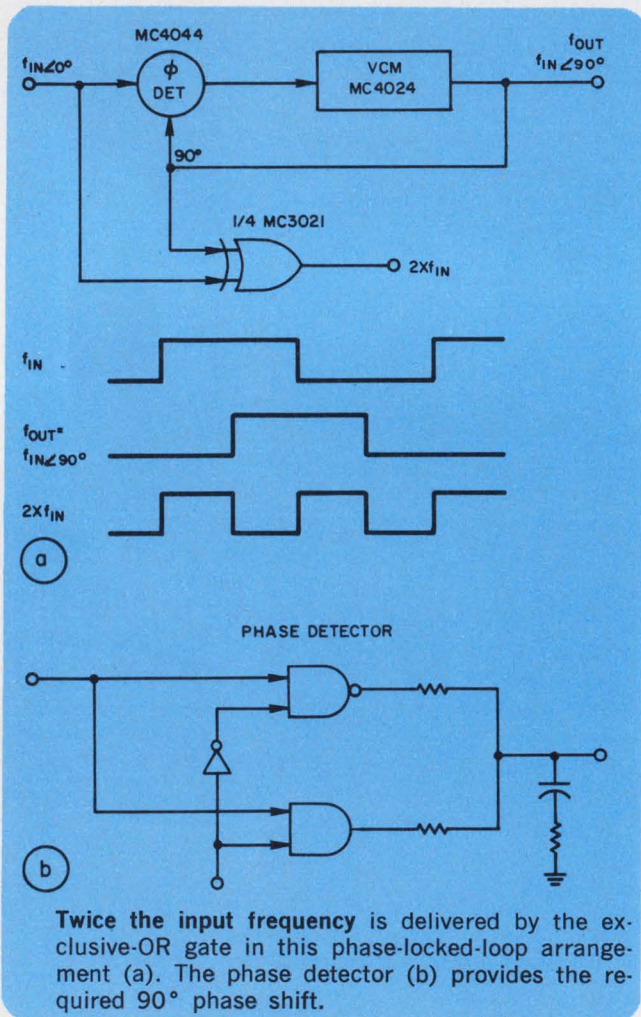

VOTE! Go through all Idea-for-Design entries, select the best, and circle the appropriate number on the Reader-Service-Card.

SEND US YOUR IDEAS FOR DESIGN. You may win a grand total of \$1050 (cash)! Here's how. Submit your IFD describing a new or important circuit or design technique, the clever use of a new component or test equipment, packaging tips, cost-saving ideas to our Ideas-for-Design editor. You will receive \$20 for each accepted idea, \$30 more if it is voted best-of-issue by our readers. The best-of-issue winners become eligible for the Idea Of the Year award of \$1000.

IFD Winner for February 15, 1970

Robin J. Larson and Gerald A. Dunn, Design Engineers, Department of Defense, Laurel, Md. Their Idea "Improved Sawtooth Generator Has Grounded Reference Point" has been voted the Most Valuable of Issue Award.

Vote for the Best Idea in this Issue.

Meet the DIP Trimmer *Family*

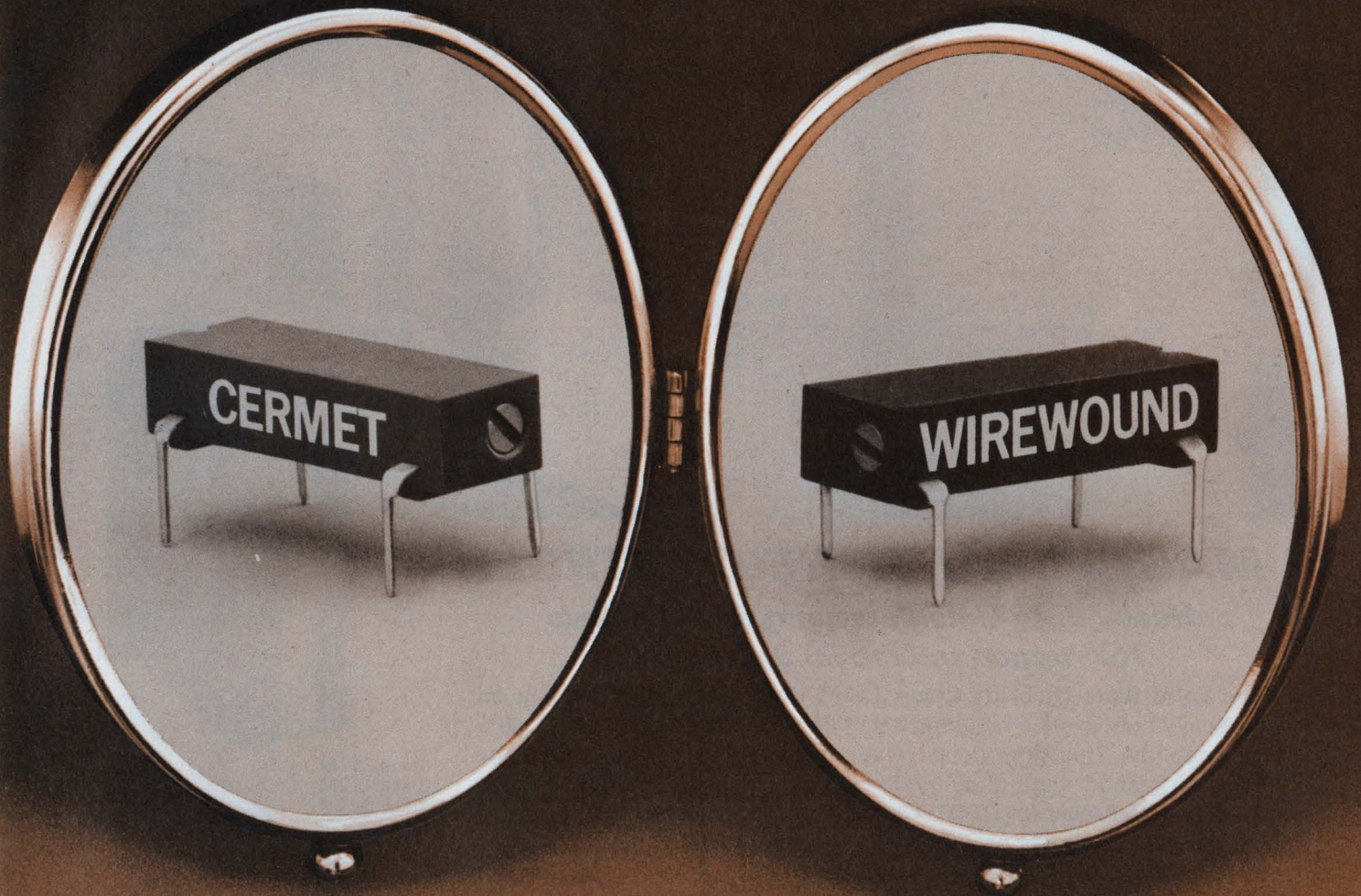

#30-1

Cermet TC typically < 100 ppm... 50 ppm available

TRW technology now provides the first *twin* offering of dual in-line potentiometers. A *cermet* trimmer has added infinite resolution, resistances of 10 ohms thru 1 megohm, and extra reliability to the picture. Teamed with the low cost and tight tolerance features of the original DIP *wirewound*, IRC Metal Glaze

(cermet) completes this *first family*.

Utilizing the TRW proved "I/C" package, both types are shipped in magazines, ready for completely automatic inspection tests and PC-board insertion.

Both cermet and wirewound DIP's are available from your TRW Distributor. For technical

details contact IRC Division of TRW INC., 2801 72nd Street, North, St. Petersburg, Florida 33733. Phone: (813) 347-2181. TWX: 810-863-0357

TRW®

INFORMATION RETRIEVAL NUMBER 63

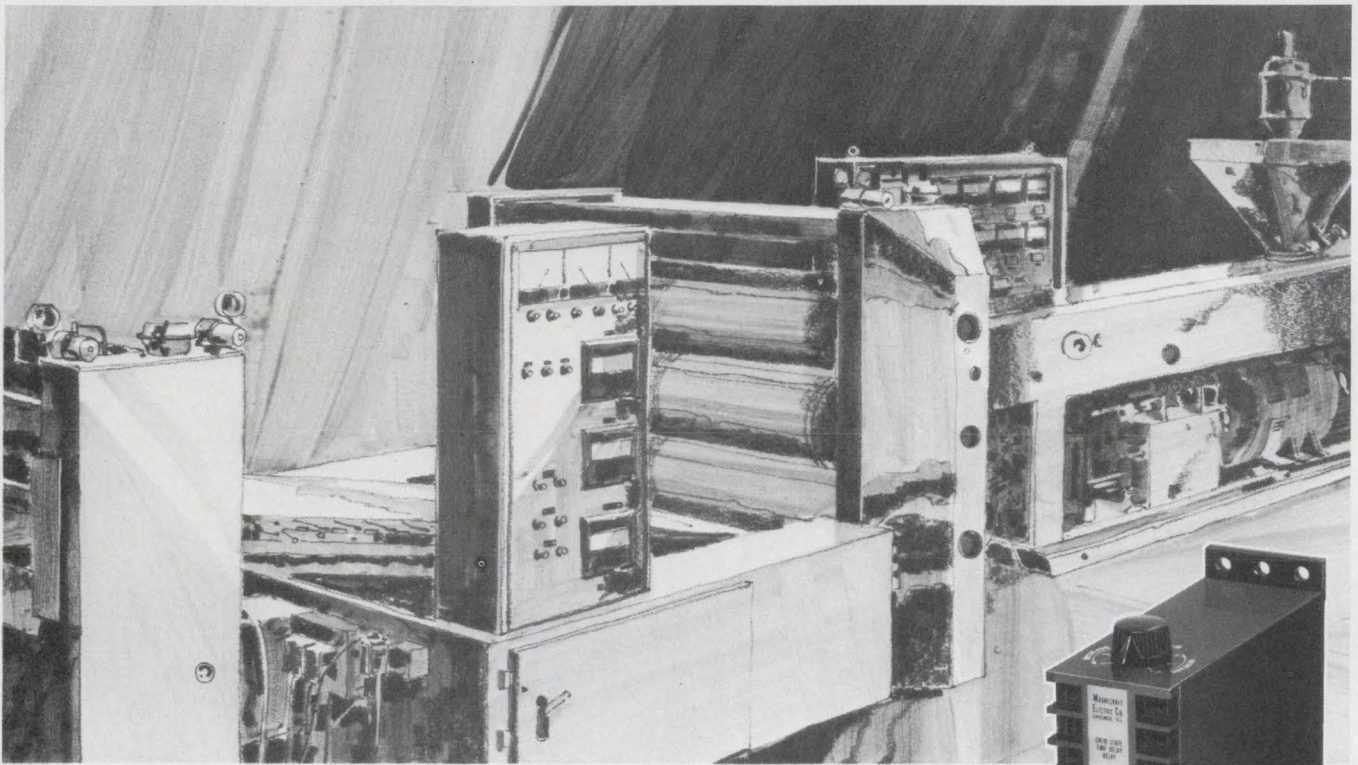

MAGNECRAFT THE CONTROLLER

**Heavy duty time delay and power relays
for rugged industrial applications**

The Solid State (hybrid) Class 211M time delay relay is designed for heavy duty service requiring accurate time delay control with $\pm 5\%$ repeatability. This time delay relay makes use of hybrid technology combining solid state circuitry for the timing function with an electromechanical relay for DPDT 10 ampere output switching. This highly reliable relay operates on AC or DC, has an adjustable delay for either operate time or release time. The surface mounted molded plastic enclosure incorporates screw terminals. In stock for immediate delivery, this new relay costs less than \$29.00 in single quantities.

The Electromechanical Class 112M time delay relay comes in a package similar to the 211M. However, it utilizes a highly reliable precision air dashpot for the timing function, and an electromechanical relay for the 10 amp DPDT output switch. The designer will quickly recognize the inherent quality and simplicity in the design. Also in stock for immediate delivery, this time delay relay costs less than \$29.00 in single quantities.

The Class 99 is ideal for heavy duty industrial power relay applications. Occupies less than $2\frac{1}{2}'' \times 2\frac{1}{2}'' \times 2\frac{1}{8}''$ of space. Yet, it's capable of switching 115 volts at up to 50 amps. Available with a "Magnetic-Blowout" for greater arc suppression and increased DC switching. Class 99 power relays can be supplied with contact combinations from SPST to DPDT at ratings up to 50 amps and in Underwriters Laboratories Listings. In stock for immediate delivery and priced as low as \$5.66 in single quantities.

For your source of 512 different stock relays, write for Magnecraft's Catalog No. 271.

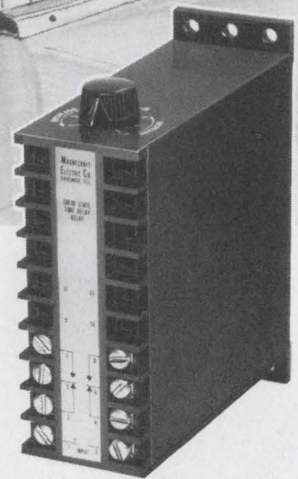

Class 211M
Class 112M
Time Delay
Relay

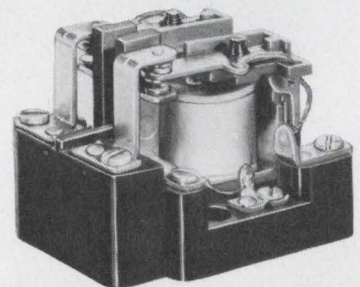

Class 99 Heavy
Duty Power Relay



Magnecraft[®] ELECTRIC CO.

5575 NORTH LYNCH AVENUE • CHICAGO, ILLINOIS 60630 • 312 282-5500 • TWX-910-221-5221

INFORMATION RETRIEVAL NUMBER 64

Under-drafting.

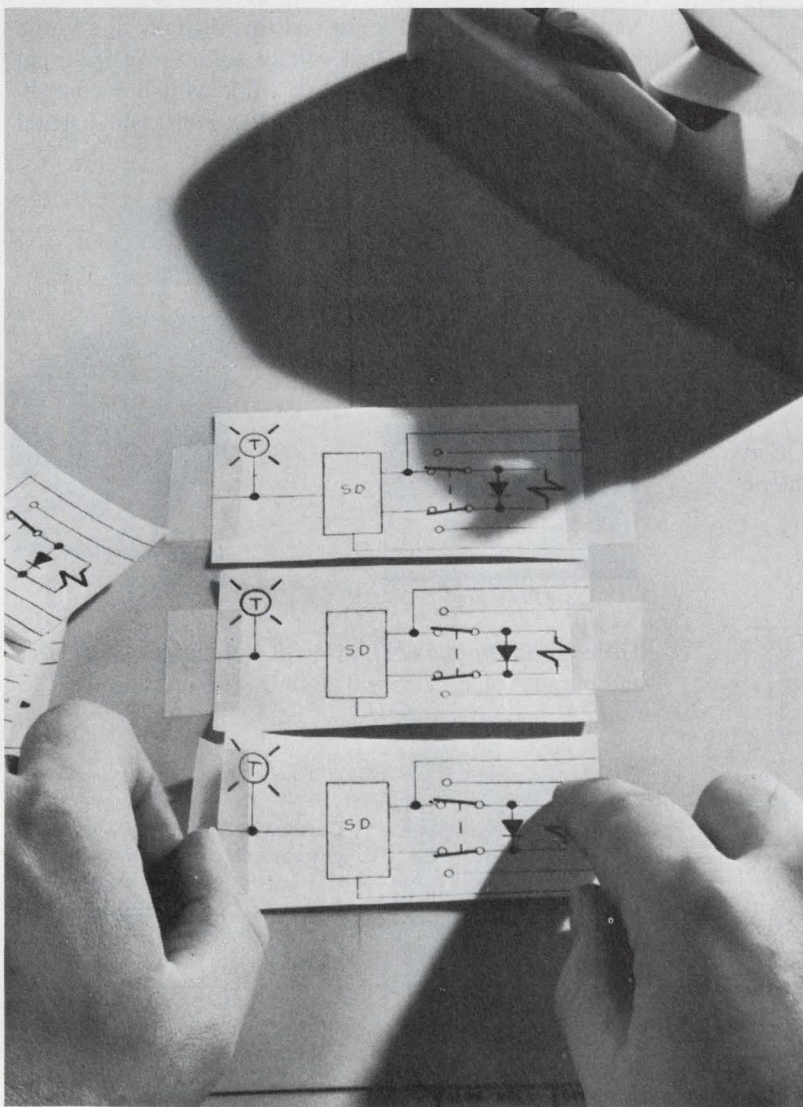

**Draw less.
Let photography
handle your repeat
drafting chores.**

If you're retracing design elements that are repeated again and again in a drawing, you're overdrafting. Same thing applies if you're retracing a design that's part of another drawing.

Save time. Underdraft with KODAGRAPH Films and Papers for a welcome change. Let them do the repetitive work—photographically.

Talk it over with your local Kodak Technical Service Representative. Or write Eastman Kodak Company, Business Systems Markets Division, Department DP759, Rochester, New York 14650.
**DRAWING REPRODUCTION
SYSTEMS BY KODAK**

Kodak

when is a power supply not just a power supply?

This is Kepco's JQE 100-10MHS Power Supply. It looks and is built much like the many hundreds of similar power supplies made by power supply companies. It will produce an adjustable voltage 0-100V, with a 10-turn front panel control—will drive loads up to 10 amperes and is backed by a 5-year warranty.

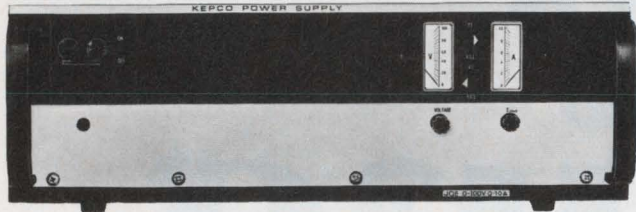

That's where the resemblance to the product of other power supply companies stops. The JQE 100-10MHS is made by Kepco, the power CONTROL company.

This means that you can manipulate its output to suit your purposes. You can use it as a 1 kW, d-c power amplifier and use as much of its 500,000 volts per volt d-c gain as you please. With that suffix "HS," the JQE will allow you to modulate its output with signals of your choice up to about 300 Hz for full 100V peak-to-peak swing. For 10V p-p modulation, you've got a 3 kHz bandwidth.

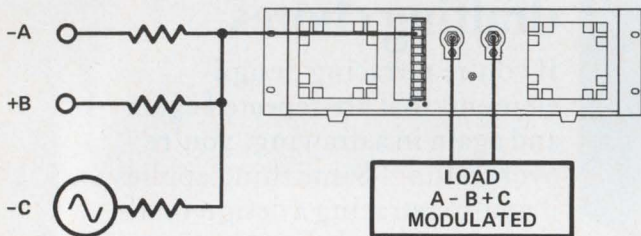

Would you like to sum several signals? Connect the JQE as a summing amplifier and use it to perform arithmetic operations.

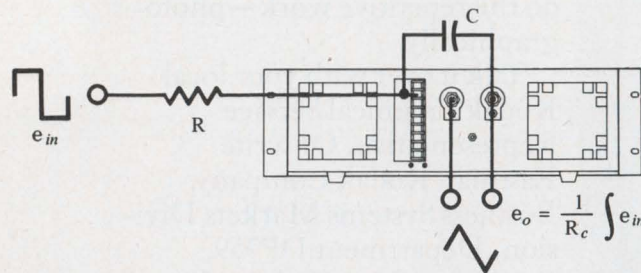

With a capacitor connected to its convenient feedback terminals, your JQE makes a dandy integrator.

KEPCO®

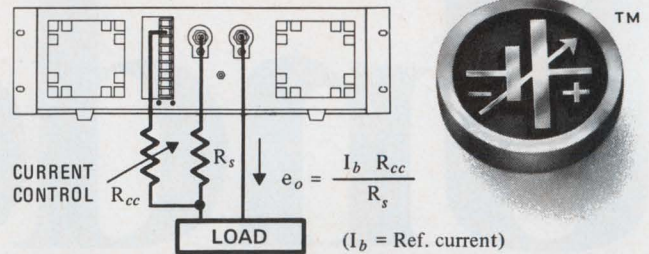

Bring feedback from a current sensor and it will regulate current.

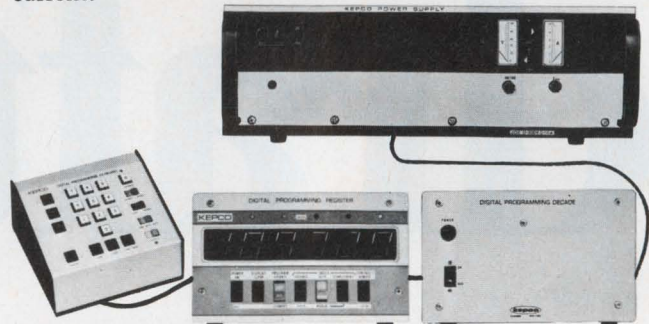

Vary its feedback and input resistors digitally and you'll have a computer-controlled voltage source. We make an excellent digital programmer to work with our controllable power supplies (the Kepco DPD, DPR, DPK Digital Programming System).

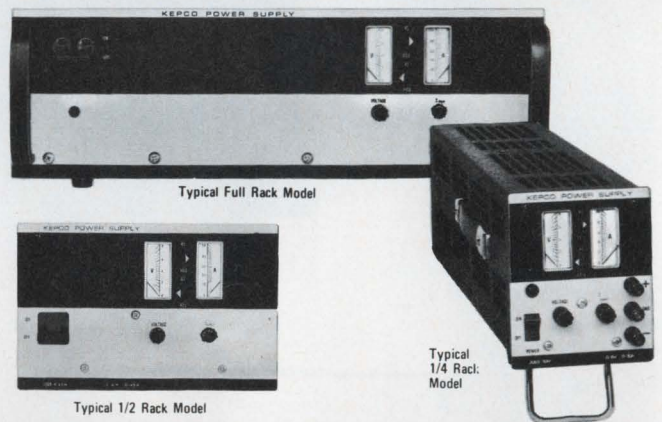

There are thirty-one (31) different JQE models in all sizes and output voltages from 0-6 to 0-150 volts up to 1125 watts . . . modules, too.



Our new Catalog B-703 is just off the press with details on the JQE and other fine Kepco power controllers. We would like to send you a copy.

Write Dept. DL-05

Operational Amplifiers

This Product Source Directory covers Operational Amplifiers.

Units covered are separated into three categories: discrete, monolithic and hybrid op amps.

Discrete and hybrid op amps are listed in ascending order of unity-gain bandwidth. Monolithic op amps are listed in alphabetical order by manufacturer's name. Differential monolithic op amps are marked with a star in the notes column. The following abbreviations apply to all operational amplifiers listed:

- Blt-in—Built-in
- DIL—Dual-In-Line
- DIP—Dual-In-Line Plastic
- EP—Epoxy
- FP—Flat Pack
- ina—information not available
- MC—Metal Can
- n/a—not applicable
- req—request
- SPCL—Special Package

Manufacturers are identified by abbreviation. The complete name of each manufacturer can be found in the Master Cross Index on pg. 104.

Master Cross Index

Abbrev.	Company	Information Retrieval No.
ADI	Analog Devices Inc. 221 Fifth St. Cambridge, Mass. 02142 (617) 492-6000	441
Alle	Allegr-Tech Inc. 141 River Rd. Nutley, N.J. 07110 (201) 661-2220	442
Amp	Amperex Electronic Corp. Slatersville, R.I. 02876 (401) 762-9000	443
BB	Burr-Brown Research Corp. International Airport Industrial Park Tucson, Ariz. 85706 (602) 294-1431	444
B&H	Bell & Howell Co. Control Products Division 706 Bostwick Ave. Bridgeport, Conn. 06605 (203) 368-6751	445
CL	Computer Labs 1109 S. Chapman St. Greensboro, N.C. 27403 (919) 292-6427	446
DDC	Data Devices Corp. 100 Tech St. Hicksville, N.Y. 11801 (516) 433-5330	447
DEC	Digital Equipment Corp. 146 Main St. Maynard, Mass. 01754 (617) 897-5111	448
DM	Dynamic Measurements Corp. 108 Summer St. Arlington, Mass. 02174 (617) 648-3610	449
FC	Fairchild Controls Div. Modular Products 423 National Ave. Mountain View, Calif. 94040 (415) 962-3833	450
GE	General Electric Co. Electronic Components Electronics Park Syracuse, N.Y. 13201 (315) 456-7597	451
GI	General Instrument Corp. Semiconductor Products Group P.O. Box 600 Hicksville, N.Y. 11802 (516) 733-3000	452
GPS	GPS Instrument Co., Inc. 14 Burr St. Framingham, Mass. 01701 (617) 875-0607	453
INT	Intronics Inc. 57 Chapel St. Newton, Mass. 02158 (617) 332-7350	454
ITT	ITT Semiconductor 3301 Electronics Way West Palm Beach, Fla. 33407 (305) 842-2411	455
Kear	Kearfott Div. Singer-General Precision 1150 McBride Ave. Little Falls, N.J. 07424 (201) 256-4000	456
KEI	Keithley Instruments Inc. 28775 Aurora Rd. Cleveland, Ohio 44139 (216) 248-0400	457

Abbrev.	Company	Information Retrieval No.
Kepeco	Kepeco Inc. 131-38 Sanford Ave. Flushing, N.Y. 11352 (212) 461-7000	458
Knap	Knapton Associates Inc. 11 Mulberry St. Nashua, N.H. 03060 (603) 889-1151	459
MEC	Melcor Electronics Corp. 1750 New Highway Farmingdale, N.Y. 11735 (516) 694-5570	460
MOTO	Motorola Semiconductor Products Inc. 5005 E. McDowell Rd. Phoenix, Ariz. 85008 (602) 273-6900	461
NAT	National Semiconductor Corp. 2975 San Ysidro Way Santa Clara, Calif. 95051 (408) 245-4320	462
OEI	Optical Electronics Inc. P.O. Box 11140 Tucson, Ariz. 85706 (602) 624-8358	463
OPA	Opamp Labs 172 S. Alta Vista Blvd Los Angeles, Calif. 90036 (213) 934-3566	464
PARC	Princeton Applied Research Corp. P.O. Box 565 Princeton, N.J. 08540 (609) 924-6835	465
QC	Qualidyne Corp. 3699 Tahoe Way Santa Clara, Calif. 95051 (408) 738-0120	466
RAD	Radiation Inc. Microelectronics Div. P.O. Box 37 Melbourne, Fla. 32901 (305) 727-4000	467
RAY	Raytheon Co. Semiconductor Operation 350 Ellis St. Mountain View, Calif. 94040 (415) 968-9211	468
RCA	RCA Electronic Components & Devices Harrison, N.J. 07029 (201) 485-3900	469
SIG	Signetics Corp. 811 E. Arques Ave. Sunnyvale, Calif. 94086 (408) 739-7700	470
SPRA	Sprague Electric Co. 481 Marshall St. North Adams, Mass. 01247 (413) 664-4411	471
SSEC	Solid State Electronics Corp. 15321 Rayan St. Sepulveda, Calif. 91343 (213) 894-2271	472
TPN	Teledyne Philbrick/Nexus Research 17 Allied Drive at Rte 128 Dedham, Mass. 02026 (617) 329-1600	473
Zelt	Zeltex Inc. 1000 Chalomar Rd. Concord, Calif. 94520 (415) 686-6660	474

Bell & Howell Makes The Best Hybrid Operational Amplifiers

All the physical features, parameters and characteristics that are vital to the packaging and performance of op amps in your circuitry are built into Bell & Howell hybrid op amps. Every model is engineered for optimal balance between performance, size and cost — and offer these major features:

- Offset, trimmed, No Pot Required
- Choice of Bipolar or FET input
- Small, Compact Size (0.6" x 0.6" x 0.25") Epoxy & TO-8
- Hermetically & Plastic Packaged
- MIL & Commercial Temperature Range
- Input and Output Fully Protected
- Frequency Compensated
- Temperature Cycled for User Stability
- 100% Electrical Test Critical Parameters
- Test Documentation Available

		SPECIFICATIONS: MEDIUM GRADE PRODUCT					
		20-007	20-247	20-107	20-008	20-248	20-108
Voltage offset	max.	.2mv	.2mv	.2mv	1mv	1mv	1mv
Thermal rate	max.	5 μ V/°C	5 μ V/°C	5 μ V/°C	25 μ V/°C	25 μ V/°C	25 μ V/°C
Input bias current	max.	150na	100na	150na	5pa	5pa	5pa
Common mode rejection	typ.	100db	100db	100db	80db	80db	80db
Open Loop Gain (at 10 kHz)	min.	2,000v/v	2,000v/v	2,000v/v	1,500v/v	1,500v/v	1,500v/v
Output current	min.	\pm 5ma	\pm 5ma	\pm 5ma	\pm 5ma	\pm 5ma	\pm 5ma
Price (in quantities of 100)		\$16.00	\$24.00	\$16.00	\$29.00	\$51.00	\$29.00

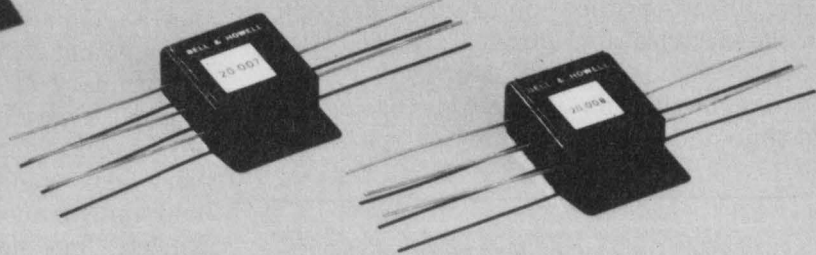
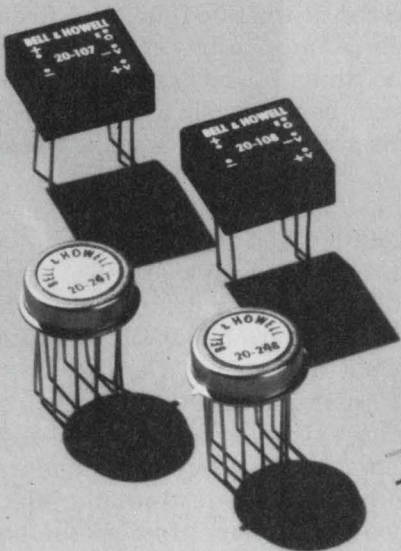

CONTROL PRODUCTS DIVISION

706 Bostwick Ave., Bridgeport, Conn. 06605 (203) 368-6751

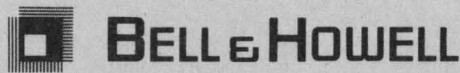

Select the right op amp for the job

Discrete, hybrid and monolithic are three ways in which operational amplifiers may be categorized.

- **Discrete:** These are units made with discrete active elements or mixtures of discretely and ICs (monolithic chips). The active elements are not handled in chip form, and soldering is the predominant means of interconnection.

- **Hybrid:** Related more closely to discretely than to ICs, they are units made with thick or thin film resistors and discrete or IC active elements in chip form. They are packaged in standard TO series cans, DIPs, or in a variety of proprietary packages.

- **Monolithic:** These are chips packaged in standard TO series cans, DIPs, flat packs. They are also available as chips for hybrid assembly.

The chart on the right compares the advantages and disadvantages of the various types of operational amplifiers. Naturally, one may expect specific overlaps or occasional outstanding deviants.

Which op amp?

It doesn't matter which type is used, as long as the type chosen will do the required job at the lowest over-all cost. So the choice, like so many engineering choices, really boils down to defining as completely as possible the required job and the ingredients of over-all cost.

Job requirements break down into two categories: those relating to the project in a business sense (i.e., military vs commercial, one-shot vs original-equipment manufacturing design), and those affecting the engineering decision, based on the electrical and physical nature of the job.

If you are buying on a one-time basis, you will save time and probably money by specifying

and purchasing an off-the-shelf unit that will do the whole job with a minimum of selections and special adjustments.

If it's an OEM job, with a large amount of follow-on, it pays to spend a good deal of engineering to find the cheapest monolithic IC that will do the whole job reliably, with a minimum of selection and special adjustment.

If the critical spec is minimum in size, you will almost always prefer an IC or hybrid unit, unless the IC unit requires a lot of outside components to do the job satisfactorily.

For smallest size, nothing compares with op amps in chip form. However, yields of chips to the end product bring the cost back up, and extra components for compensation may bring the size up. Also, the extra handling outside the semiconductor plant may adversely affect reliability.

When sophisticated specifications are required and the projected total usage for the next few years is less than 1000 units, don't eliminate discretely; if it's not greater than 10,000, a special design (discrete, hybrid, or *possibly* IC) may be considered. If it's in the hundreds of thousands, every penny saved is worth \$1000, and it doesn't take many such pennies to buy a state-of-the-art IC design. One thing about state-of-the-art IC designs, however: be pretty sure that your design is final, or needs a minimum of mask "tweaking." The penalty for changes in ICs is loss of time, and there is an additional cost penalty every time a change is made.

Standard ICs are broadly specified for the greatest possible yield. In order to obtain better specs from a given IC, it is necessary to be selective. Although not often done (at this writing) by primary IC manufacturers, who thrive for the most part on extremely large volume, there are several companies that buy the standards in very large volume, perform testing and selection, and apply a modest markup. Most of the better-known "module houses" can make such units available at competitive prices. ■■

Daniel H. Sheingold, Director of Marketing, Analog Devices, Inc., Cambridge, Mass.

Table. Comparative features of op amps

	Advantages	Disadvantages
Monolithic IC	<p>Small size Potentially very low in cost Improved reliability (because of minimum numbers of interconnections) Excellent matching of transistor parameters on chip Hermetic seal and MIL temperature ranges available Design tricks usable that are impracticable with discretes,</p>	<p>Cost of using may be high if special yields or additional circuitry is necessary to attain a given performance level Lower performance than available state-of-the-art discretes or hybrid designs using combinations of ICs and other components Second-sourcing an absolute necessity for protection against delivery failures resulting from temporary (but catastrophic) low yields Long lead time for new designs Inflexibility of new designs</p>
Hybrid	<p>Small size Improved circuit performance over ICs for state-of-the-art requirements Hermetic seals and MIL temperature ranges available Improved reliability because of reduced number of discrete elements and interconnections (vs discretes) Can evolve into IC designs as portions of circuit are integrated and simplified More flexible than monolithics</p>	<p>More costly than monolithics because of labor content; may cost more than discretes because of yield problems Substrate size may limit complexity of circuitry; hence state-of-the-art performance not as good as discretes Longer lead time than discretes Complex circuit packages larger than monolithics</p>
Discrete	<p>Short lead time from design to assembly of working pilot units Flexibility of circuitry and components Widest performance range in standard units Lowest cost for state-of-the-art performance in short runs Wide range of specs available at reasonable cost Best for short and medium runs, breadboards, and prototypes Longest life histories for established designs</p>	<p>Largest size and heaviest weight Most interconnections Higher price "floor" in very large quantity Too costly where needs are simple Not acceptable for many military programs, even if environmental and other specs are met</p>

The Great Debate:

Custom Power Supplies vs. Standard

Custom power supplies offer you precise performance, precise interface and high efficiency. Added up, that means total guaranteed *system* reliability with discs, drums, logic, displays, etc. for computers, printers, data terminals and all the other peripherals we've designed supplies for. It can also mean special size, weight and integrated shape, to fit within the available space.

Custom supplies mean a lower price, too, compared to off-the-shelf modular units, and you can have features like automatic sequencing, AC failure sensing, reverse temperature compensation, and under and over-voltage sensing, among others, that are not available with the "standard" supplies. With Hi-G's in-house hybrid I.C. regulators, transformers and plug-in Printed Circuit Boards providing "standardized circuits", we've beaten the high-cost, long-lead-time prototype battle as well. Let us apply our Systems-Application approach for you. It'll provide you with a "prototype" in 1/3 the time at 1/4 normal costs.

The irrefutable evidence leads to an "aye" vote for Hi-G Custom Power Supplies. But on the other hand: when the demand is widespread for Hi-G Custom Power Supplies, they become "the standard." All those in favor . . . return the attached coupon.



Hi-G Incorporated
Electronic Products Division
Spring St. & Route 75
Windsor Locks, Conn. 06096



OP-AMP Supply
Dual + and - 15 VDC.
Regulation $\pm 0.02\%$
2 MV Stability -55°C to
 $+85^{\circ}\text{C}$.

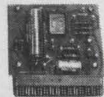

Plug-in Card Regulation
Outputs from 5V to 25V at up
to 2 Amp. Regulation 0.5%
to 0.01%.

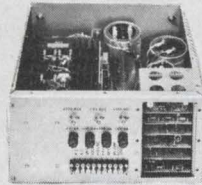

Multi-Output Supply
Independent regulator for
each output. Sequencing and
control circuits on plug-in cards.



Logic/Lamp Supply
5VDC or 6VDC Slot Supply,
with built-in Crowbar. Set
for lamp loads.

Custom Specification Guide

Applications Information

NAME _____ TITLE _____

COMPANY _____

ADDRESS _____

CITY _____ STATE _____ ZIP _____

APPLICATION _____



INFORMATION RETRIEVAL NUMBER 68

Mfr	Device Number	Notes	Differential Input Impedance Typical (ohms)	Differential Output Impedance Typical (ohms)	Output Voltage Swing/Load Resistance Maximum (Volts/ohms)	Input Offset Voltage (mV)	Dc Voltage Gain	Unity Gain Bandwidth (MHz)	Common Mode Input Voltage Maximum (Volts)	Common Mode Rejection Ratio (Decibels)	Supply Voltages (Volts)		Operating Temperature Range (°C)	Package Type	Price per Unit
											+	-			
FC	ADC-8/10	j	250k	n/a	±10/3.3k	f	86	n/a	±10	n/a	15	15	-25 to +85	EP	28
FC	ACB-10/12	l	2M	10	±10/100	50	90	n/a	±20	n/a	15	15	-40 to +100	EP	30
DDC	F5-21	p	350k	n/a	±10/1k	f	10k	ina	n/a	n/a	15	15	0 to +70	module	75
DDC	F5-23	p	350k	n/a	±10/330	f	40k	ina	n/a	n/a	15	15	-25 to +75	module	125
All e	AT-OA-1	a	300k	300k	±12	l	88dB	ina	±15	90	22	22	55 to 125	ina	req
BB	3339/27	vt	10 ⁹	n/a	±10/2k	f	100	0.001	±25	100	15	15	-25 to +85	EP	65
BB	3338/27	vt	10 ⁹	n/a	±10/2k	f	100	0.001	±25	100	15	15	-25 to +85	EP	95
BB	3337/27	vt	3x10 ¹¹	n/a	±10/2k	f	100	0.001	n/a	n/a	15	15	-25 to +85	EP	65
BB	3336/27	vt	3x10 ¹¹	n/a	±10/2k	f	100	0.001	n/a	n/a	15	15	-25 to +85	EP	95
ADI	310/311	i	3x10 ¹¹	n/a	±10/2k	f	100k	0.002	±25	100	15	15	10 to 70	MC, EP	75
BB	3230/12C	y	10 ¹¹	n/a	±1-15/100k	±4	90	0.05	±1-15	75	15	15	-25 to +85	EP	29
BB	3229/12C	y	10 ¹¹	n/a	±1-15/100k	±2	90	0.05	±1-15	75	15	15	-25 to +85	EP	49
KEI	50200	(8)	10 ¹²	n/a	±10/1k	f	15k	0.1	±10	60	15	15	0 to 50	MC	250
ADI	153J	h	1M	n/a	±1/1k	n/a	50k	0.15	±1	74	2.7	2.7	10 to 60	MC, EP	40
Knap	756	(9)	1M	0.01	±15/30	f	2.5x10 ⁶	0.25	±10	86	15	15	0 to 60	module	99
Kear	C70372005	(2)	100k	50	±18.5/50	5	n/a	0.4	±18.5	60	28	28	-55 to +85	EP	req
BB	1514/25	e	0.5	n/a	±10/0.5k	±0.5	100	0.5	±10	80	15	15	-25 to +85	MC	95
BB	3001-15	e	1M	n/a	±4/5k	±1	96	0.5	±4	80	6	6	-25 to +85	MC	45
BB	3002/15	e	10 ¹¹	n/a	±4/5k	±1	90	0.5	±4	60	6	6	-25 to +85	EP	55
GPS	702	d	100G	100	±11	2	150k	0.5	n/a	n/a	15	15	-25 to +85	EP	35
MEC	1617		1M	1k	10/3k	s	30k	0.5	±10	80	15	15	-25 to +85	MC	25
MEC	1779		1M	500	2-10/1-2.5k	s	75-140k	0.5	±2-10	80	4.5	4.5	-25 to +85	MC	35
Kear	C70372004	(2)	40k	50	±17.5/50	7	n/a	0.75	n/a	n/a	24	24	-55 to +85	EP	req
BB	1557/15		10 ¹¹	n/a	±10/5k	±2	90	0.8	±10	60	15	15	-25 to +85	EP	39
ADI	180K	hq	2M	n/a	±10/4k	0.1	300k	1	±10	100	15	15	10 to 60	MC, EP	95
ADI	180J	q	2M	n/a	±10/4k	0.25	300k	1	±10	100	15	15	10 to 60	MC, EP	75
BB	1901/19	e	0.5M	n/a	±10/5k	±0.5	100	1	±10	80	15	15	-25 to +85	MC	65
BB	1902/19	e	0.5M	n/a	±10/1.5k	±0.5	90	1	±10	80	15	15	-25 to +85	MC	55
BB	1903/19	e	0.5M	n/a	±10/0.2k	±0.5	90	1	±10	80	15	15	-25 to +85	MC	95
BB	3114/12C	qx	10 ¹¹	n/a	±10/5k	±1	90	1	±10	60	15	15	-25 to +85	EP	55
BB	1752/17		10 ¹¹	n/a	±10/5k	±2	90	1	±10	60	15	15	-25 to +85	EP	85
BB	3129/15	qx	10 ¹¹	n/a	±10/0.5k	±1	100	1	±10	60	15	15	-25 to +85	EP	95
BB	1556/15	qx	10 ¹¹	n/a	±10/0.5k	±1	90	1	±10	60	15	15	-25 to +85	EP	85
BB	3241/12C	qx	10 ¹¹	n/a	±10/5k	±1	90	1	±10	60	15	15	-25 to +85	EP	65
BB	3310/12C	it	10 ¹¹	n/a	±10/1k	s	106	1	±10	100	15	15	-25 to +85	EP	55
BB	3311/12C	i	10 ¹¹	n/a	±10/1k	s	106	1	±10	100	15	15	-25 to +85	EP	45
BB	3068/17	e	0.5M	n/a	±10/5k	±0.5	94	1	±10	80	15	15	-25 to +85	MC	45
BB	3077/12C	e	0.3M	n/a	±10/5k	s	93	1	±10	80	15	15	-25 to +85	MC	12
BB	3117/12C	e	0.3	n/a	±10/5k	±0.5	93	1	±10	80	15	15	-25 to +85	MC	35
BB	3118/12C	e	0.3M	n/a	±10/5k	±1	93	1	±10	80	15	15	-25 to +85	MC	23
BB	3119/12C	e	0.3M	n/a	±10/5k	±2	93	1	±10	80	15	15	-25 to +85	MC	17
BB	1552/15		10 ¹¹	n/a	±10/0.5k	±1	100	1	±10	60	15	15	-25 to +85	EP	65
GPS	703	d	100G	100	±11	2	200k	1	n/a	n/a	15	15	-25 to +85	EP	100
GPS	603	e	200k	100	±11	2	200k	1	n/a	n/a	15	15	-25 to +85	EP	60
MEC	1573		200k	2k	10/5k	s	10k	1	±5	66	15	15	-25 to +85	MC	15
MEC	1527		250k	1k	100/10k	s	100k	1	±10	80	125	125	-25 to +85	MC	88
MEC	1439		1M	1k	10/5k	s	30k	1	±10	80	15	15	-25 to +85	MC	15
MEC	1861	ds	10 ¹¹	200	10/2k	500	20k	1	±10	69	15	15	-25 to +85	MC	10
BB	3022/15	et	0.5	n/a	±10/5k	±2	104	1.2	±10	80	15	15	-25 to +85	MC	29
BB	3021/15	et	0.5	n/a	±10/5k	±1	104	1.2	±10	80	15	15	-25 to +85	MC	35
BB	3020/15	e	0.5M	n/a	±10/5k	±1	104	1.2	±10	80	15	15	-25 to +85	MC	39
BB	3019/15	e	0.5M	n/a	±10/5	±0.5	104	1.2	±10	80	15	15	-25 to +85	MC	70
BB	3009/15C	e	0.5M	n/a	±10/5k	±3	94	1.2	±10	80	15	15	-25 to +85	MC	19
BB	3008/15C	e	0.5M	n/a	±10/5k	±1	94	1.2	±10	80	15	15	-25 to +85	MC	25
BB	3003/15	e	0.5M	n/a	±10/5k	±0.4	104	1.2	±10	80	15	15	-25 to +85	MC	70
BB	3004/15	e	0.5M	n/a	±10/5k	±0.5	104	1.2	±10	80	15	15	-25 to +85	MC	60
BB	3005/15	e	0.5M	n/a	±10/5k	±1	104	1.2	±10	80	15	15	-25 to +85	MC	44
BB	3006/15	e	0.5M	n/a	±10/5k	±1.5	104	1.2	±10	80	15	15	-25 to +85	MC	39
BB	3007/15C	e	0.5M	n/a	±10/5k	±0.5	94	1.2	±10	80	15	15	-25 to +85	MC	35
BB	1506/15	e	0.5M	n/a	±10/5k	±0.5	104	1.2	±10	80	15	15	-25 to +85	MC	50
MEC	1841	d	10 ¹¹	1k	10/2k	ina	300k	1.5	±10	74	15	15	0 to 85	MC	55
MEC	1895	d	10 ¹¹	1k	10/2k	500	300k	1.5	±10	94	15	15	0 to 85	MC	60
MEC	1616		200k	300	10/1k	s	100k	1.5	±10	86	15	15	-25 to +85	MC	20
ADI	118K	h	1M	n/a	±10/2k	±5	250k	1.5	±10	86	15	15	10 to 60	MC, EP	21
ADI	118A	h	1M	n/a	±10/2k	±5	250k	1.5	±10	86	15	15	-25 to 85	MC, EP	11
ADI	165A	h	1M	n/a	±20/4k	s	500k	1.5	±20	86	24	24	-25 to +85	MC, EP	24
ADI	119A	hj	1M	n/a	±10/500	5	500k	1.5	±10	86	15	15	-25 to +85	MC, EP	24
BB	3044/15	e	0.5	n/a	2-28/5k	±0.5	110	2	2-28	100	6	32	-25 to +85	MC	75
GPS	601	e	100k	100	±11	2	100k	2	n/a	n/a	15	15	-25 to +85	EP	17
MEC	1731		200k	100	10/100	s	50k	2	±4	80	15	15	-25 to +85	MC	30
MEC	1717	(2)(3)	200k	50	11/100	±5	20k	2	±5	80	15	15	-55 to +85	MC	98
BB	3322/14	d	10 ¹¹	n/a	±10/3k	s	106	3	±10	100	15	15	-25 to +85	EP	47
BB	3323/14	dt	10 ¹¹	n/a	±10/3k	s	106	3	±10	100	15	15	-25 to +85	EP	37
BB	3318/14	dt	10 ¹¹	n/a	±10/3k	s	106	3	±10	66	15	15	-25 to +85	EP	25
BB	3317/14	d	10 ¹¹	n/a	±10/3k	s	106	3	±10	66	15	15	-25 to +85	EP	34
DEC	A207	c	100k	n/a	±10	f	15k, 100k	3	±10	10,000	15	15	0 to 60	module	45
ADI	501C	d	10 ¹¹	n/a	±10/2k	1	25k	4	±10	80	15	15	-25 to +85	MC, EP	50
ADI	40K	dh	10 ¹¹	n/a	±10/2k	±2	50k	4	+8, -10	74	15	15	10 to 60	MC, EP	19

TRYGON

the power supply leader...

introduces the **FIRST Triple Output** lab power supply

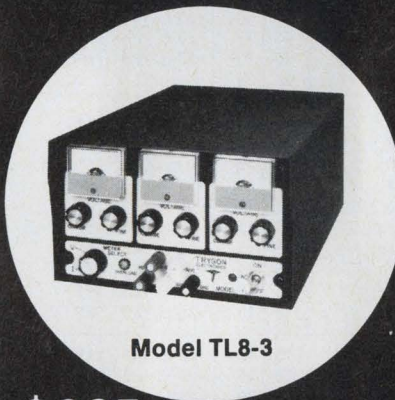

Model TL8-3

\$225

The first 3 in 1 power supply made for general lab use and IC applications.

Outputs are 0 to +8 VDC at 3A; 0 to +32 VDC at 1A and 0 to -32 VDC at 1A. That's \$75 an output. Quite a savings over buying separate supplies to do the job that this ONE can do and Better!

- Overvoltage option available
- Precision Trygon Performance and Reliability

Write for details and get your copy of Trygon's new 1970 Power Supply Handbook

TRYGON POWER SUPPLIES

111 Pleasant Avenue, Roosevelt, New York 11575
 Tel: 516-378-2800 TWX: 510-225-3664
 Trygon GmbH 8 Munchen 60, Haidelweg 20, Germany
 Prices slightly higher in Europe.

PMC BENCH PACS Power Supplies at 1/2 price

High-quality, UniPower Series "C" Lab Supplies are yours for 1/2 price, for a limited time. Usually \$89, you can now buy any one Series "C" Lab Supply for \$44.50 when you purchase one of the other laboratory supply models in the new PMC Bench Pac line.

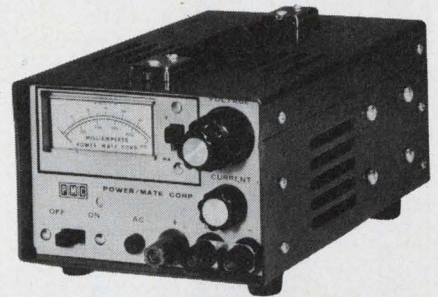

These supplies are based on proven UniPower principles and have the high reliability associated with all PMC products. And, they carry the Power/Mate Corp. five year warranty.

Take advantage of this remarkable 1/2 price value today.†

SERIES	MODEL	DC OUTPUT		CASE SIZE			PRICE
		VOLTS	AMPERES	HEIGHT	WIDTH	DEPTH	
C	BP-8C	0-8	0-1.5	3 3/8	5 3/8	7 1/4	\$ 89.00
	BP-18C	0-18	0-1.0	3 3/8	5 3/8	7 1/4	89.00
	BP-34C	0-34	0-.5	3 3/8	5 3/8	7 1/4	89.00
D	BP-8D	0-8	0-4	3 3/8	6 7/8	7 1/4	129.00
	BP-18D	0-18	0-2.5	3 3/8	6 7/8	7 1/4	129.00
	BP-34D	0-34	0-1.5	3 3/8	6 7/8	7 1/4	118.00
	BP-60D	0-60	0-.750	3 3/8	6 7/8	7 1/4	129.00
E	BP-8E	0-8	0-6.5	5 3/2	5 3/2	9 3/8	210.00
	BP-18E	0-18	0-3.5	5 3/2	5 3/2	9 3/8	210.00
	BP-34E	0-34	0-2.5	5 3/2	5 3/2	9 3/8	210.00
	BP-60E	0-60	0-1.25	5 3/2	5 3/2	9 3/8	219.00
F	BP-8F	0-8	0-9	5 3/2	7 1/2	9 3/8	235.00
	BP-18F	0-18	0-5	5 3/2	7 1/2	9 3/8	235.00
	BP-34F	0-34	0-3.5	5 3/2	7 1/2	9 3/8	235.00
	BP-60F	0-60	0-1.75	5 3/2	7 1/2	9 3/8	244.00
G	BP-8G	0-8	0-12	5 3/2	7 1/2	11 7/8	290.00
	BP-18G	0-18	0-6.5	5 3/2	7 1/2	11 7/8	290.00
	BP-34G	0-34	0-5	5 3/2	7 1/2	11 7/8	290.00
	BP-60G	0-60	0-2.5	5 3/2	7 1/2	11 7/8	299.00
H	BP-8H	0-8	0-15	5 3/2	7 1/2	16 1/2	345.00
	BP-18H	0-18	0-9	5 3/2	7 1/2	16 1/2	345.00
	BP-34H	0-34	0-6.5	5 3/2	7 1/2	16 1/2	345.00
	BP-60H	0-60	0-3.25	5 3/2	7 1/2	16 1/2	359.00

† Offer expires August 31, 1970

SPECIFICATIONS

INPUT: 105-125 Volts, 47-420 cps, single phase.

OUTPUT VOLTAGE AND CURRENT: See Tables.

REGULATION: Less than .01% or 1 millivolt, whichever is greater, for line and load.

RIPPLE: Less than 250 microvolts.

TRANSIENT RESPONSE: +0.3% or ±2 millivolts, whichever is larger for a ±10 volt step change in line voltage.

METERS: Front panel voltmeter and ammeter, accurate to 2% of full scale value.

CONSTANT CURRENT/CONSTANT VOLTAGE: May be preset within the maximum rated levels.

VOLTAGE CONTROL: Continuously variable DC output with coarse and vernier DC OUTPUT ADJUST potentiometers on concentric shafts.

CURRENT CONTROL: Continuously variable current limiting adjustment with single turn potentiometer.

TEMPERATURE COEFFICIENT: Better than 0.01% / °C.

LONG TERM STABILITY: Better than 0.025% for 8 hours.

DUTY: Continuous at ambient temperatures from 0°C to 45°C. Operation above 45°C is allowed provided the output current is derated 20% for every 10°C rise above 45°C.

PARALLELING: Two or more units may be operated in series to provide higher voltage output at rated current.

PROTECTION: Load and power supply protection for any overload condition.

AIRFLOW: All units are convection cooled.

INSPECTION: MIL-Q-9858 Procedures.

Request your FREE Bench Pac brochure (Form 10-70). Write to:



POWER/MATE CORP.

514 South River Street, Hackensack, New Jersey 07601
 Phone (201) 343-6294 / TWX 710-990-5023

Mfr	Device Number	Notes	Differential Input Impedance Typical (ohms)	Differential Output Impedance Typical (ohms)	Output Voltage Swing/Load Resistance Maximum (Volts/ohms)	Input Offset Voltage (mV)	Dc Voltage Gain	Unity Gain Bandwidth (MHz)	Common Mode Input Voltage Maximum (Volts)	Common Mode Rejection Ratio (Decibels)	Supply Voltages (Volts)		Operating Temperature Range (°C)	Package Type	Price per Unit
											+	-			
ADI	40J	d	10 ¹¹	n/a	±10/2k	±2	50k	4	+8, -10	74	15	15	10 to 60	MC, EP	12
ADI	501A	dh	10 ¹¹	n/a	±10/2k	2	25k	4	±10	80	15	15	-25 to +85	MC, EP	30
BB	3312/12C	d	10 ¹¹	n/a	±10/1.5k	s	106	4	±10	100	15	15	-25 to +85	EP	29
BB	3313/12C	dt	10 ¹¹	n/a	±10/1.5k	s	106	4	±10	100	15	15	-25 to +85	EP	22
BB	3307/12C	dt	10 ¹¹	n/a	±10/1.5k	s	106	4	±10	66	15	15	-25 to +85	EP	19
BB	3308/12C	dt	10 ¹¹	n/a	±10/1.5k	s	106	4	±10	66	15	15	-25 to +85	EP	11.90
MEC	1614		100k	1k	10/2k	s	20k	4	±10	80	15	15	-25 to +85	MC	12
ADI	142A	d	10 ¹¹	n/a	±10/500	f	80k	5	±9	66	15	15	-25 to +85	MC, EP	35
ADI	142C	df	10 ¹¹	n/a	±10/500	h	80k	5	±9	66	15	15	-25 to +85	MC, EP	55
ADI	146J	dh	10 ¹¹	n/a	±10/500	0.7	100k	5	+5, -10	80	15	15	10 to 60	MC, EP	57
ADI	146K	dh	10 ¹¹	n/a	±10/500	0.7	100k	5	+5, -10	80	15	15	10 to 60	MC, EP	70
BB	3279/14	pt	10 ¹¹	n/a	±10/25	s	100	5	±10	80	15	15	-25 to +85	EP	37
BB	3278/14	p	10 ¹¹	n/a	±10/25	s	100	5	±10	80	15	15	-25 to +85	EP	47
MEC	1620	l	20k	5	10/100	n/a	0.9	5	n/a	n/a	15	15	-25 to +85	MC	19
MEC	1732	(3)	300k	1k	10/5k	s	50k	5	±10	80	15	15	-55 to +85	MC	110
MEC	1490	l	20k	5	10/50	n/a	0.85	5	n/a	n/a	15	15	-25 to +85	MC	25
MEC	1791	l	10k	5	16/16	n/a	0.85	5	n/a	n/a	25	25	0 to 45	MC	30
MEC	1757		200k	100	20/100	s	50k	5	±8	80	25	25	-25 to +85	MC	42
Kear	C70372003	(2)	40k	50	±18/50	5	n/a	1-5	n/a	n/a	24	24	-55 to +85	EP	req
Kear	C703722002	(2)	40k	50	±11/50	5	n/a	1-6	n/a	n/a	15	15	-55 to +85	EP	req
DEC	A200	c	6M	n/a	±11	f	2x10 ⁶	10	±10	20k	15	15	0 to 60	module	130
DEC	A206	c	10 ¹⁰	n/a	±10	f	100k	10	±10	7000	15	15	0 to 60	module	190
MEC	1673	d	10 ¹³	1k	10/500	s	50k	10	±8	60	15	15	-55 to +85	MC	125
MEC	1619B	d	10 ¹¹	150	10/1k	s	50k	10	±10	74	15	15	-55 to +85	MC	48
MEC	1772	d	10 ¹¹	1k	10/2k	s	20k	10	±10	69	15	15	-25 to +85	MC	25
MEC	1726	q	1M	300	10/500	s	100k	10	±10	80	15	15	-25 to +85	MC	60
MEC	1727	d	10 ¹¹	300	50/2.5k	s	100k	10	±20	74	60	60	-55 to +85	MC	88
MEC	1725	d	10 ¹¹	1k	10/2k	s	40k	10	±10	69	15	15	-25 to +85	MC	35
MEC	1719	d	10 ¹¹	500	5-21/1k	s	100k	10	±5-21	100	10-	10-	-55 to +85	MC	80
MEC	1682	d	10 ¹¹	300	20/2k	s	75k	10	±15	74	25	25	-55 to +85	MC	68
MEC	1894	ds	10 ¹¹	10k	10/2k	500	20k	10	±10	94	15	15	-25 to +85	MC	28
ADI	149C	dh	10 ¹¹	n/a	±10/700	f	100k	15	±9	90	15	15	10 to 60	MC, EP	105
MEC	1672	d	10 ¹¹	300	10/500	s	50k	25	±10	74	15	15	-55 to +85	MC	70
MEC	1787	d(3)s	10 ¹¹	300	10/500	1	50k	25	±10	74	15	15	-55 to +85	MC	105
GPS	704	d	100G	100	±11	2	200k	40	n/a	n/a	15	15	-25 to +85	EP	95
GPS	604	e	200k	100	±11	2	200k	40	n/a	n/a	15	15	-25 to +85	EP	55
BB	3341/15C	w	10 ¹¹	n/a	±10/10	±1	100	50	n/a	n/a	15	15	-25 to +85	EP	69
BB	3342/15C	tw	10 ¹¹	n/a	±10/10	±1	100	50	n/a	n/a	15	15	-25 to +85	EP	59
GPS	706	d	100G	100	±11	2	1M	50	n/a	n/a	15	15	-25 to +85	EP	135
GPS	705	d	100G	100	±11	2	500k	50	n/a	n/a	15	15	-25 to +85	EP	117
GPS	606	e	200k	100	±11	2	1M	50	n/a	n/a	15	15	-25 to +85	EP	95
GPS	605	e	200k	100	±11	2	500k	50	n/a	n/a	15	15	-25 to +85	EP	77
DDC	VA-21	b	350k	n/a	±10/1k	f	40k	80	n/a	n/a	15	15	0 to 70	module	65
DDC	VA-23	b	350k	n/a	±10/200	f	200k	100	n/a	n/a	15	15	-25 to +75	module	125
ADI	120A	p	200k	n/a	±10/400	f	500k	100	n/a	n/a	15	15	-25 to +85	MC, EP	65
ADI	120B	p	200k	n/a	±10/400	f	500k	100	n/a	n/a	15	15	-25 to +85	MC, EP	75

a. Ac, dc, gain, differential input.

b. Inverting Op amp.

c. Single-ended

d. FET input.

e. Bipolar input.

f. Input offset voltage adjustable to zero.

g. Non-inverting chopper amplifier.

h. Input offset voltage drift, models 142C, 45K, 120A, 15μV/°C; model 260J, 0.3μV/°C; models 260K, 233L, 0.1μV/°C; models 118A, 165A, 119A, 40K, ±20μV/°C; models 146J, 149C, ±μV/°C; model 603J/K, 50/15 μV/°C; model 220J, 0.2μV/°C; models 118K, 153J, ±5μV/°C; model 146K, 2 μV/°C; models 233J, 180K, ±0.5 μV/°C; model 501A, 75 μV/°C.

i. Low bias current varactor.

j. Dc comparator.

k. Inverting chopper amplifier, low noise and drift.

l. Current booster.

m. Improved operating temperatures available.

n. Dual op-amp.

p. Fast settling op amp.

q. Low drift op amp.

r. Input offset voltage drift, models 3266/12C, 3268/14, ±5 μV/°C; models 3267/12C, 3269/14, ±20 μV/°C.

s. Balanced pot required.

t. Input offset voltage drift, models 3144/15, 3133/12C, 1 μV/°C; models 3145/15, 3134/12C, 3336/27, 3339/27, 3310/12C, 2μV/°C; models 3357/15, 3358/12C, 3020/15, 5 μV/°C; models 3021/15, 3336/27, 3339/27, 3310/12C, 10 μV/°C; models 3307/12C, 3022/15, 20 μV/°C; models 3337/27, 3338/27, 30 μV/°C; models 3279/14, 3342/15C, 3323/14, 3313/12C, 3318/14, 3308/12C, 3350/03, 50 μV/°C.

u. Also meets MIL-STD-883 temperature range -55 to +125°C.

v. Varactor type.

w. Fast line driver.

x. Input offset voltage drift.

y. Low power drain.

z. Wideband, fast overload recovery type.

(1) Slew rate, V/μs.

(2) Synchro driver.

(3) Burned-in semiconductors, military application.

(4) Comparator.

(5) Plastic.

(6) Ceramic.

(7) Differentiator.

(8) Aerospace.

(9) Servo.

YT19 system cabinet, holds all the equipment shown (except teletypewriter) with room to spare.

CD51 controller-digitizer with programmable gain, controls 1024 channels, 10ns aperture time.

TE33 teletypewriter with paper tape reader and punch. (Includes controller.)

CF16 minicomputer with a 4K x 16-bit memory (expandable to 24K) and four different I/O modes. (Includes software.)

Optionally available: MR50 high-level multiplexer and associated channels (approximately \$2400 extra), if you want to mix high and low level signals. Also 10, 12 or 15-bit D to A converters for closed loop systems, and a variety of other off-the-shelf instruments and options to solve virtually any data acquisition problem.

PE20 peripheral controller for CD51/DM40 combination.

OP50 multiplexer switch card contains 8 switches with screw terminals. Each DM40 accommodates up to 16 such cards. Switch cards with other terminal types also available.

OP59 power supply for up to eight DM40s.

DM40 low-level differential multiplexer accepts up to 128 input signals (optionally expandable to 1024) in the range $\pm 2.5\text{mV}$ to $\pm 10\text{V}$ full scale, at a rate up to 20kHz, and with a CMR of 120db at DC.

All instruments and interfaces will be cabinet mounted and functionally tested together prior to delivery. If you're in a hurry, call (213) 679-4511, ext. 3668 or 3391.

XDS
Xerox Data Systems
El Segundo, California

The last reason you should buy our data acquisition system is the price: \$21,600.

Discrete op amps (differential)

Mfr	Device Number	Notes	Differential Input Impedance Typical (ohms)	Differential Output Impedance Typical (ohms)	Output Voltage Swing/Load Resistance Maximum (Volts/ohms)	Input Offset Voltage (mV)	Dc Voltage Gain	Unity Gain Bandwidth (MHz)	Common Mode Input Voltage Maximum (Volts)	Common Mode Rejection Ratio (Decibels)	Supply Voltages (Volts)		Operating Temperature Range (°C)	Package Type	\$ Price per Unit
											+	-			
OEI	9685	i	500k	3	±10/10	5	30k	0.1	±12	100	15	15	-25 to +70	module	78
OEI	9687		500k	0.3	±10/1k	5	30k	0.1	±12	100	15	15	-25 to +70	module	145
OEI	9686	i	500k	1	±10/3k	5	30k	0.1	±12	100	15	15	-25 to +70	module	97
KEI	300	e	n/a	n/a	±11/1k	f	20k	0.15	n/a	n/a	15	15	0 to 50	MC	200
TPN	SP2A	cj	10G	1k	±11/5k	6	150k	0.15	±300	160	15	15	0 to 60	SPCL	160
FC	ADO-39	dj	10 ¹²	600	±10/10k	±1	95	0.2	±12	65	15	15	-25 to +85	EP	45
TPN	1001	cj	2M	1k	0.25/50	1	200k	0.25	0.25	70	1.9	1.9	-25 to +85	A1	44
OEI	9432	i	500k	2k	±10/1k	5	30k	0.3	±12	100	15	15	-55 to +85	module	89
OEI	9709	djq	10G	200	±10/1k	0.1	10M	0.3	±12	100	15	15	-55 to +85	module	130
Zelt	170	ej	1M	n/a	±1-10	f	10 ⁵	0.3	±1-10	86	4.5	4.5	-25 to +85	module	20
FC	ADO-73	ejq	600k	25	±10/2k	±0.15	126	0.4	±10	108	15	15	-25 to +85	EP	95
FC	ADO-32	dij	10 ¹²	200	±10/2k	±1	95	0.45	±10	95	15	15	-25 to +85	EP	85
DDC	D-41	i	400k	n/a	±125/500	±5	100k	0.5	±19	150	150	150	-55 to +85	module	150
KEI	301	i	10 ¹²	n/a	±11/1k	f	50k	0.5	±11	60	15	15	-25 to +85	MC	185
TPN	1006	cj	100G	1k	±2/1k	0.3	15k	0.6	0.5	66	2.7	2.7	-25 to +85	A1	35
DDC	D-31	i	1M	n/a	±18/120	±5	20k	0.75	±8	70	24	24	-55 to +85	module	95
DDC	D-32	i	400k	n/a	±11/270	±5	25k	0.8	±10	90	15	15	-55 to +100	module	67
DDC	D-33	i	400k	n/a	±11/100	±5	25k	0.8	±10	90	15	15	-55 to +100	module	67
DDC	D-35	i	1M	n/a	±18.5/75	±5	20k	0.8	±18.5	90	28	28	-55 to +85	module	110
DDC	D-11	ej	1M	n/a	±10/500	f	31.6k	0.8	±10	80	15	15	-55 to +85	module	25
TPN	1018	cj	4M	2k	±13/4k	0.1	2M	0.8	±12	100	15	15	-25 to +85	A1	74
TPN	1020	cj	4M	1k	±11/2k	0.5	1M	0.8	±10	100	15	15	-25 to +85	A1	27
FC	ADO-48/ 10 & /12	ej	1M	300	±10/3k	f	86	1	±10	100	15	15	-25 to +85	EP	27
FC	ADO-56/13	ej	250k	4	±10/330	f	95	1	±10	90	15	15	-25 to +85	EP	25
FC	ADO-57/13	ej	1M	4	±10/330	f	95	1	±10	100	15	15	-25 to +85	EP	40
FC	ADO-58/13	ej	500k	275	±20/2k	f	92	1	±10	95	15	15	-25 to +85	EP	40
FC	ADO-26B	dj	10 ¹²	35	±10/2k	±1	100	1	±5	86	15	15	-25 to +85	EP	80
FC	ADO-28B	dj	10 ¹²	35	±10/2k	±1	100	1	±5	86	15	15	-25 to +85	EP	45
FC	ADO-80/ 12 & /13	dj	10 ¹²	700	±10/3k	f	86	1	±10	86	15	15	-55 to +125	EP	50
FC	ADO-82/15	dj	10 ¹²	500	±10/2.5k	±1	86	1	±5	86	15	15	-40 to +100	EP	30
FC	ADO-83/15	dj	10 ¹²	350	±20/3.3k	±1	86	1	±15	86	15	15	-40 to +100	EP	49
ADI	184L	ig	4M	n/a	±10/2k	±0.1	300k	1	±10	100	15	15	10 to 60	MC, EP	75
ADI	184J	im	4M	n/a	±10/2k	±0.25	300k	1	±10	100k	15	15	10 to 60	MC, EP	45
ADI	603J/K	i	10 ¹¹	n/a	±10/2k	f	1-2000	1	±10	80	18	18	10 to 60	MC, EP	54
DDC	D-26	ej	500k	n/a	±20/4k	f	80k	1	±18	100	28	28	-55 to +85	module	60
DDC	D-28	ej	1M	n/a	±10/5k	f	316k	1	±4	100	15	15	-55 to +110	module	80
DDC	D-30B	ej	1M	n/a	±20/330	f	15.8k	1	±15	70	24	24	-55 to +85	module	80
DDC	D-34	i	400k	n/a	±20/70	±5	20k	1	±5	90	24	24	-55 to +100	module	125
DDC	D-2	ej	400k	n/a	±11/2k	f	17.8k	1	±11	100	15	15	-55 to +85	module	9.75
FC	ADO-56/15	ej	250k	4	±10/330	0.5	95	1	±10	90	15	15	-25 to +85	EP	29
FC	ADO-57/15	ej	1M	4	±10/330	0.5	95	1	±10	100	15	15	-25 to +85	EP	44
FC	ADO-58/15	ej	500k	275	±20/2k	0.5	92	1	±10	95	15	15	-25 to +85	EP	44
FC	ADO-27B	dj	10 ¹²	35	±10/2k	±1	100	1	±5	86	15	15	-25 to +85	EP	65
FC	ADO-29B	dj	10 ¹²	35	±10/2k	±1	100	1	±5	86	15	15	-25 to +85	EP	30
FC	ADO-82/13	dj	10 ¹²	500	±10/2.5k	f	86	1	±5	86	15	15	-40 to +100	EP	26
FC	ADO-83/13	dj	10 ¹²	350	±20/3.3k	f	86	1	±15	86	15	15	-40 to +100	EP	45
FC	ADO-84	dj	10 ¹²	100	±10/2k	f	100	1	±5	60	15	15	-25 to +85	EP	11.90
FC	ADO-47/ 10 & /12	ej	250k	300	±10/3k	f	86	1	±10	90	15	15	-25 to +85	EP	14
FC	ADO-45	ej	200k	50	±10/2k	f	95	1	±10	80	15	15	-25 to +85	EP	15
FC	ADI-7/14	dj	10 ¹²	50	±10/2k	f	1000	1	±10	90	15	15	-25 to +85	EP	79
GPS	801	i	100,000M	100	±10	2	100k	1	±10	66	15	15	-25 to +85	EP	17
INT	FA601	i	10 ¹¹	0.5	±11/2k	0	1-1000	1	±10	86	18	18	-25 to +75	EP	65
INT	A101	i	250k	150	±10/2k	2	15k	1	±10	90	15	15	-25 to +85	EP	13.50
Zelt	136	dj	10 ¹¹	n/a	±100/5k	f	10 ⁵	1	±100	100	125	125	0 to 70	module	125
Zelt	134	dj	10 ¹¹	n/a	±10/2.5k	f	5x10 ⁴	1.3	±7	60	15	15	-25 to +85	module	16
TPN	ESL-1	cj	200k	30k	±10/2k	1	120k	1.4	±10	120	15	15	-40 to +85	E-1	35
DDC	D-27	dj	10 ¹¹	n/a	±11/1k	f	100k	1.5	±11	100	15	15	-55 to +125	module	98
TPN	1009	cj	100G	1k	±11/2k	5	100k	1.5	+7, -10	66	15	15	-25 to +85	A1	16
TPN	SQ-5	cj	300k	1.2k	±11/5k	2	20k	1.5	±10	70	15	15	-55 to +100	A-1	11.50
TPN	1005	cj	250k	15k	±22/4k	1	100k	1.5	±20	80	26	26	-25 to +85	A1	24
Zelt	133	dj	10 ¹¹	n/a	±10/2k	f	2x10 ⁵	1.5	±10	86	15	15	-25 to +85	module	27
Zelt	ZEL-1	ej	10 ⁶	n/a	±10/2k	f	5x10 ⁵	1.5	±10	86	15	15	-25 to +85	module	11
TPN	SQ-16	cj	200k	15k	±13/2k	2	250k	1.5	±11	90	15	15	-25 to +85	A-1	23
TPN	USL-1	cj	300k	5k	±11/2k	0.8	200k	1.5	±11	126	15	15	-55 to +100	E-1	75
TPN	Q102	cj	1M	8k	±12/2k	0.2	400k	1.7	±11	85	15	15	-25 to +85	module	30
TPN	PP25A	cj	100G	700	±11/5k	2	150k	1.8	±10	60	15	15	-25 to +85	AS-2	75
DDC	D-5	ej	250k	n/a	±10/2k	f	20k	2	±10	80	15	15	-55 to +85	module	17
FC	ADO-46/ 12 & /13	ej	6M	300	±10/5k	f	90	2	±10	90	15	15	-55 to +125	EP	45
GPS	701	i	100,000M	100	±11	2	100k	2	ina	ina	15	15	-25 to +85	EP	55
GPS	802	i	100,000M	100	±10	2	150k	2	±10	70	15	15	-25 to +85	EP	35
OPA	440KR	i	100k	0.1	±30/8	±100	800	2	±30	80	36	36	-55 to +85	MC	35
OPA	425	i	100k	50	±20/1k	±20	20k	2	±20	80	25	25	-20 to +85	MC	25
TPN	1003	cj	100G	600	±12/500	0.05	3M	2	+7, -10	120	15	15	-25 to +85	E1	95
TPN	1017	cj	200k	25	±11/80	±2	30k	2	±13	90	15	15	-25 to +85	A1	35
TPN	1022	cj	100G	500	±100/5k	±1	3M	2	±100	106	120	120	-25 to +85	G3	95
TPN	1024	cj	1M	500	±12/500	±10	150k	2	±10	86	15	15	-25 to +85	A-1	19
TPN	QFT-5	cj	10G	5k	±11/2k	1	150k	2	+7, -10	60	15	15	-25 to +85	A1	12
TPN	SQ-10A	cj	300k	5k	±11/2k	5	100k	2	±10	86	15	15	-25 to +85	A-1	11

40 Watt UHF

Octave bandwidth ϕ transistor



225-400 MHz...5dB gain...24V.

8-67

TRW introduces a new state-of-the-art line of broadband high power UHF transistors. The JO2001 transistor incorporates hybrid circuit techniques inside the packaged device to reduce the reactive part of the input impedance to nearly zero (hence j-zero). The devices give extremely broadband and reliable performance from simple and consistent matching circuits. Exceptionally low input Q's

allow octave band widths from fixed tuned circuits without costly individual circuit trimming for simplicity and ease of manufacture.

The JO2001 provides a minimum of 40 watts with 5.0 dB gain across the 225-400 MHz band from a 24 volt source. Minimum efficiency is 50%.

Two or more of the devices can be paralleled simply for higher power levels. Delivery is immedi-

ate in production quantities. Order from factory or any TRW distributor.

For complete information and applications assistance, contact TRW Semiconductor Division, 14520 Aviation Blvd., Lawndale, California 90260. Phone (213) 679-4561. TWX 910-325-6206.

TRW

INFORMATION RETRIEVAL NUMBER 72

Discrete op amps (differential)

Mfr	Device Number	Notes	Differential Input Impedance Typical (ohms)	Differential Output Impedance Typical (ohms)	Output Voltage Swing/Load Resistance Maximum (Volts/ohms)	Input Offset Voltage (mV)	Dc Voltage Gain	Unity Gain Bandwidth (MHz)	Common Mode Input Voltage Maximum (Volts)	Common Mode Rejection Ratio (Decibels)	Supply Voltages (Volts)		Operating Temperature Range (°C)	Package Type	\$ Price per Unit
											+	-			
DDC	D-25	di	10 ¹¹	n/a	±10/500	f	31.6k	2.5	±10	86	15	15	-55 to +85	module	85
OEI	9487	jq	100M	300	±10/1k	3	2M	2.5	±12	140	15	15	-25 to +75	module	125
DDC	D-4	dj	10 ¹¹	n/a	±10/2k	f	31.6k	3	±10	80	15	15	-55 to +85	module	14.50
DDC	D-15	dj	10 ¹¹	n/a	±10/2k	f	40k	3	±10	86	15	15	-55 to +85	module	75
DDC	D-17	dj	10 ¹¹	n/a	±10/2k	f	40k	3	±5	106	15	15	-55 to +100	module	85
GPS	803	i	100,000M	100	±10	2	200k	3	±10	80	15	15	-25 to +85	EP	60
OEI	9684	i	2M	3	±10/20	5	50k	3	±12	100	15	15	-55 to +55	module	70
TPN	QFT-2	cj	10G	300	±11/1k	1	200k	3	+7, -10	45	15	15	-25 to +85	module	33
TPN	SA-60A	cj	500k	1k	±60/6k	5	150k	3	±10	86	75	75	-25 to +85	G1	80
TPN	PP85A	cj	330k	2k	±11/5k	3	110k	3	±11	86	15	15	-25 to +85	AS-2	25
TPN	1021	cj	100G	200	±11/500	1	200k	4	±11	120	15	15	-25 to +85	A1	33
TPN	1023	cj	100G	200	±11/500	0.3	200k	4	±11	120	15	15	10 to 60	A-1	59
DDC	D-8	ej	275k	n/a	±11/5k	f	20k	5	±11	97	15	15	-55 to +100	module	27
TPN	1008	cj	100G	100	±11/330	1	100k	5	±11.5	75	15	15	-25 to +85	A1	35
Zelt	135	dj	10 ¹¹	n/a	±10/500	f	2x10 ⁶	5	±10	109	15	15	-25 to +85	module	79
OEI	9245A	dj	10G	300	±10/3k	20	3k	6	±4	90	15	15	-55 to +75	module	83
OEI	9711	dj	10G	1k	±10/100	15	5k	6	±12	50	15	15	-55 to +75	module	88
ADI	45J	djm	10 ¹¹	n/a	±10/500	f	50k	10	+5, -10	74	15	15	10 to 60	MC, EP	38
ADI	45K	dj	10 ¹¹	n/a	±10/500	f	50k	10	+5, -10	74	15	15	10 to 60	MC, EP	48
DM	FST101A	fjp	1M	25	±10/500	±2	10 ⁶	10	±11	96	15	15	-25 to +85	module	58
DM	FST101B	fjp	1M	25	±10/500	±2	10 ⁶	10	±11	96	15	15	-25 to +85	module	63
DM	FST102A	fjp	1M	2k	±11/2k	±2	2.5x10 ⁵	10	±11	96	15	15	-25 to +85	module	45
DM	FST102B	fjp	1M	2k	±11/2k	±2	2.5x10 ⁵	10	±11	96	15	15	-25 to +85	module	49
DM	FST151A	fjp	5x10 ⁵ M	25	±10/500	±5	2.5x10 ⁵	10	±10	92	15	15	-25 to +85	module	65
DM	FST151B	fjp	5x10 ⁵ M	25	±10/500	±5	2.5x10 ⁵	10	±10	92	15	15	-25 to +85	module	78
FC	ADO-60	dj	10 ¹²	10	±10/500	±3	110	10	±10	80	15	15	-25 to +85	EP	55
INT	A149	jp	10 ¹¹	50	±10/660	f	100k	10	±10	15,000	15	15	-25 to +85	EP	65
INT	A510	jp	300k	100	±11/2k	f	100k	10	±10	ina	15	15	-25 to +85	EP	45
OEI	976A	i	3k	1k	±10/3k	10	300	10	±5	70	15	15	-55 to +75	module	47
OEI	9524	dj	10G	100	±10/100	10	10k	10	±8	100	15	15	-25 to +75	module	75
OEI	9694	i	10M	200	±10/100	15	6k	10	±12	90	15	15	-55 to +75	module	57
OEI	9695	i	50M	10	±10/20	7.5	10k	10	±11	90	15	15	-25 to +75	module	98
OEI	9696	jq	100M	10	±10/100	3	10M	10	±12	140	15	15	-55 to +75	module	135
OEI	9710	dj	10G	100	±10/1k	10	100k	10	±10	100	15	15	-55 to +75	module	94
TPN	1016	cj	500k	50	±11/100	1	750k	10	±10	100	15	15	-25 to +85	G1	70
OEI	9688	i	100M	5k	±10/50	15	50k	12	±3	50	15	15	-55 to +75	module	96
OEI	9692	i	10M	50	±4/100	15	10k	12	±6	60	15	15	-25 to +85	module	130
FC	ADO-55/13	ej	1M	6	±10/330	f	95	15	±10	100	15	15	-55 to +125	EP	55
TPN	1011	cj	100G	750	±11/400	±50	500k	15	±10	86	15	15	-25 to +85	A1	42
OEI	9278	jp	10k	3k	±10/300	20	3k	20	±3	50	15	15	-55 to +85	module	57
DDC	FS-22	dj	10 ¹⁰	n/a	±10/1k	f	15.8k	25	±10	ina	15	15	0 to 70	module	95
DDC	FS-24	dj	10 ¹¹	n/a	±10/330	f	20k	25	±10	80	15	15	0 to 70	module	125
OEI	9186B	i	3k	30	±10/2.5k	10	1k	25	±8.5	80	15	15	-55 to +75	module	70
DDC	VA-22	dj	10 ¹⁰	n/a	±10/1k	f	40k	30	n/a	n/a	15	15	0 to 70	module	75
OEI	9728	djip	10G	300	±10/300	10	10k	30	±3	90	15	15	-55 to +75	module	81
GPS	804	i	100,000M	100	±10	2	200k	40	±10	80	15	15	-25 to +85	EP	77
DDC	VA-24	dj	10 ¹¹	n/a	±10/500	f	40k	50	n/a	n/a	15	15	-25 to +75	module	125
GPS	806	i	100,000M	100	±10	2	1M	50	±10	80	15	15	-25 to +85	EP	135
GPS	805	i	100,000M	100	±10	2	500k	50	±10	80	15	15	-25 to +85	EP	117
OEI	9428	jp	3k	1k	±10/300	10	10k	100	±5	90	15	15	-55 to +75	module	76
TPN	PP45U	cj	220k	1.5k	±10/500	±10	150k	100	±10	60	15	15	10 to 60	AS-2	50

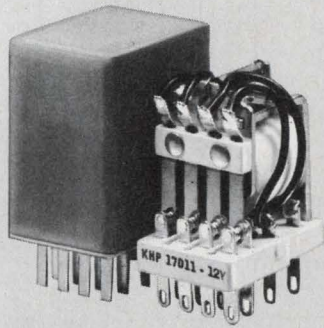

We'll stop adapting our KHP relay when you run out of new applications.

You have a tough relay requirement, right? You need a relay with the reliability of bifurcated contacts. Must have U/L Component recognition. Need .078 taper tab terminals and 400 milli-watts sensitivity. Color coded cases.

No problem. Just call us. We are all tooled and in production. Probably no other manufacturers of our KHP design can say the same.

You see, we've been making this relay longer than anyone because we designed it. We've made it for more different applications than anyone else. That's why we

have more combinations of contact materials, terminals, sockets, and mountings than anyone else.

Available in 2 Form C, 4 Form C or Form Z contact arrangements. Contacts rated 3-amps at 30V DC or 120V AC resistive. Choice of 8 different mountings and 8 contact materials. Coil voltages from 6 to 120 volts.

Complete specifications and ordering information are in our new 194-page Catalog '70. Ask your P&B representative for a copy today. Or write us direct: Potter & Brumfield Division of AMF Incorporated, Princeton, Indiana 47570. Or call 812 385 5251.

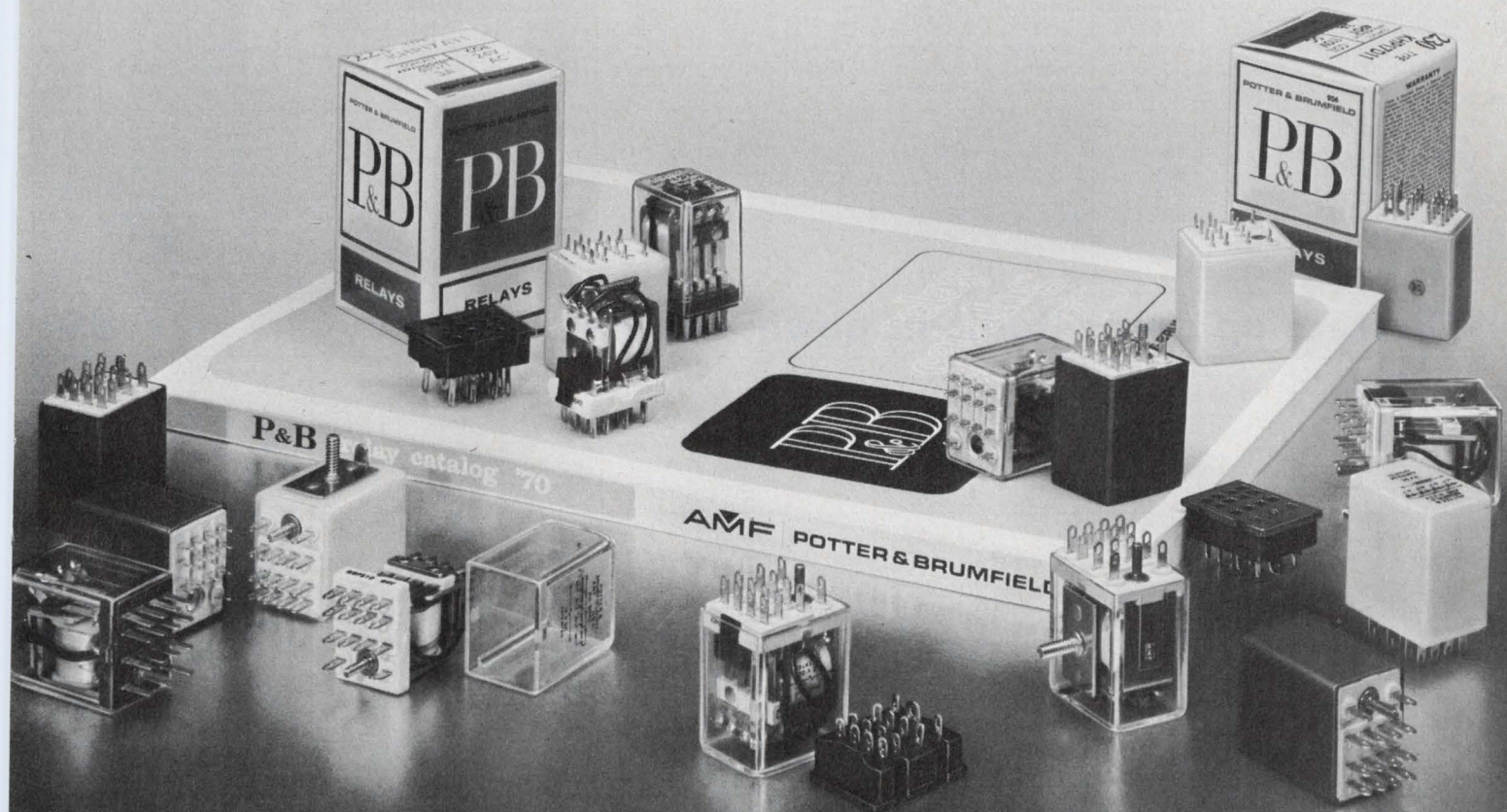

Discrete op amps (chopper-stabilized)

87

Mfr	Device Number	Notes	Differential Input Impedance Typical (ohms)	Differential Output Impedance Typical (ohms)	Output Voltage Swing/Load Resistance Maximum (Volts/ohms)	Input Offset Voltage (mV)	Dc Voltage Gain	Unity Gain Bandwidth (MHz)	Common Mode Input Voltage Maximum (Volts)	Common Mode Rejection Ratio (Decibels)	Supply Voltages (Volts)		Operating Temperature Range (°C)	Package Type	Price per Unit
											+	-			
KEI	302	b	e	n/a	±10/2k	f	12k	n/a	n/a	n/a	15	15	0 to 50	plastic	125
ADI	260K	gh	to 10 ⁹	n/a	±10/2k	0.01	5x10 ⁶	100Hz	±1	89	15	15	10 to 50	MC, EP	74
ADI	260J	gh	to 10 ⁹	n/a	±10/2k	0.025	5x10 ⁶	100Hz	±0.33	89	15	15	10 to 60	MC, EP	59
FC	ACS-11/23		500k	50	±10/2k	±0.025	140	1	±15	n/a	15	15	0 to 60	EP	70
FC	ACS-23/19		800k	100	±20/2k	±0.075	120	1	±50	n/a	15	15	-25 to +85	EP	100
FC	ACS-20/19		800k	100	±10/500	±0.075	120	1	±50	n/a	15	15	-25 to +85	EP	90
FC	ACS-10/23		500k	50	±10/2k	±0.025	140	1	±15	n/a	15	15	0 to 60	EP	59
BB	3271/25	b	0.5M	n/a	±50-100/25k	0.05	14	1	n/a	n/a	15	15	-25 to +85	EP	160
ADI	233L	hkm	n/a	n/a	±10/2k	0.05	4x10 ⁶	1	ina	ina	15	15	10 to 60	MC, EP	85
ADI	233J	hkm	n/a	n/a	±10/2k	0.05	4x10 ⁶	1	n/a	n/a	15	15	10 to 60	MC, EP	51
TPN	1701	c	500k	200	±13/2.4k	0.005	100M	1	n/a	n/a	15	15	-25 to +85	E-5	58
TPN	SP456	c	1.3M	1k	±11/500	0.1	200M	1.5	n/a	n/a	15	15	-25 to +85	SPCL	200
Zelt	148	c	500k	n/a	±10/2k	f	10 ⁸	1.5	n/a	n/a	15	15	-25 to +85	module	64
BB	3292/14	ck	0.5M	n/a	±10/1.5k	0.05	140	3	n/a	n/a	15	15	-25 to +85	EP	59
BB	3291/14	ck	0.5M	n/a	±10/1.5k	0.02	140	3	n/a	n/a	15	15	-25 to +85	EP	89
BB	3356/25	g	1M	n/a	±10/2k	0.1	140	3	n/a	n/a	15	15	-25 to +85	EP	70
BB	3355/25	g	1M	n/a	±10/2k	0.05	140	3	n/a	n/a	15	15	-25 to +85	EP	90
BB	3354/25	g	1M	n/a	±10/2k	0.03	140	3	n/a	n/a	15	15	-25 to +85	EP	110
BB	3293/14	ck	0.5M	n/a	±10/1.5k	0.1	140	3	n/a	n/a	15	15	-25 to +85	EP	49
BB	3164/25	bz	0.5M	n/a	±10/5k	0.02	140	10	n/a	n/a	15	15	-25 to +85	EP	150
BB	3071/25	bz	0.5M	n/a	±10/5k	0.03	140	10	n/a	n/a	15	15	-25 to +85	EP	135
BB	3072/25	bz	0.5M	n/a	±10/5k	0.04	140	10	n/a	n/a	15	15	-25 to +85	EP	120
BB	3010/25	bl	0.5M	ina	±10/5k	0.03	140	10	n/a	n/a	15	15	-25 to +85	EP	120
BB	3011/25	bl	0.5M	n/a	±10/5k	0.04	140	10	n/a	n/a	15	15	-25 to +85	EP	95
BB	1548/25	bl	0.5M	n/a	±20/5k	0.03	140	10	n/a	n/a	15	15	-25 to +85	EP	125
DDC	D-14	be	275k	n/a	±10/2k	f	20k	20	n/a	n/a	15	15	-55 to +85	module	48
TPN	1700		500k	2k	±10/500	0.015	1000M	20	n/a	n/a	15	15	-25 to +85	E-4	98
MEC	1680	d	n/a	300	10/500	s	10 ⁸	25	n/a	n/a	15	15	-25 to +85	MC	140
Zelt	147	bce	200k	n/a	±10/500	f	10 ⁵	10-100	n/a	n/a	15	15	-55 to +85	module	59
TPN	SP656	c	1.3M	1k	±11/500	0.1	400M	100	n/a	n/a	15	15	-25 to +85	SPCL	195
ADI	220J	bh	n/a	n/a	±10/400	0.025	10 ⁸	100	n/a	n/a	15	15	10 to 60	MC, EP	160

Discrete op amps (wideband)

88

Mfr	Device Number	Notes	Differential Input Impedance Typical (ohms)	Differential Output Impedance Typical (ohms)	Output Voltage Swing/Load Resistance Maximum (Volts/ohms)	Input Offset Voltage (mV)	Dc Voltage Gain	Unity Gain Bandwidth (MHz)	Common Mode Input Voltage Maximum (Volts)	Common Mode Rejection Ratio (Decibels)	Supply Voltages (Volts)		Operating Temperature Range (°C)	Package Type	Price per Unit
											+	-			
FC	ADO-65/14	djl	10 ¹²	100	±5/50	±1	90	10	±18	60	15	15	0 to 70	EP	55
CL	FS-125	clp	30k	1	±2.2/100	2	500k	30	n/a	n/a	15	15	0 to 70	EP	97
FC	ADO-74	ejl	600k	25	±10/2k	±0.15	126	40	±10	100	15	15	-25 to +85	EP	80
FC	ADO-75	ejl	600k	25	±10/2k	±0.15	126	40	±10	95	15	15	-25 to +85	EP	75
DDC	CD-23	l	350k	n/a	±10/100	f	40k	100	n/a	n/a	15	15	0 to 50	module	125
OEI	9251	jl	2k	10	±1.5/100	50	30	100	±1	30	6	6	-55 to +75	module	64
CL	OA-125	cl	10k	1	±2.2/100	1.5	200k	125	n/a	n/a	15	15	-25 to +85	EP	135
OEI	9491	jl	10k	100	±5/1.8k	20	300	300	±1	50	15	15	-25 to +75	module	220

Discrete op amps (built-in power supply)

89

Mfr	Device Number	Notes	Differential Input Impedance Typical (ohms)	Differential Output Impedance Typical (ohms)	Output Voltage Swing/Load Resistance Maximum (Volts/ohms)	Input Offset Voltage (mV)	Dc Voltage Gain	Unity Gain Bandwidth (MHz)	Common Mode Input Voltage Maximum (Volts)	Common Mode Rejection Ratio (Decibels)	Supply Voltages (Volts)		Operating Temperature Range (°C)	Package Type	Price per Unit
											+	-			
Kepco	36-5M	Hi-pwr	n/a	n/a	±36, 5A	null	35k	0.3(1)	n/a	n/a	blt	in	-20 to +65	C, R	803
Kepco	36-1.5M	Hi-pwr	n/a	n/a	±36, ±1.5A	null	35k	0.3	n/a	n/a	blt	in	-20 to +65	C, R	562
Kepco	P15-20M	Hi-pwr	n/a	n/a	±15, ±20A	null	35k	0.3(1)	n/a	n/a	blt	in	-20 to +65	C, R	1150
Kepco	72-1.5M	Hi-pwr	n/a	n/a	±72, 1.5A	null	35k	0.3(1)	n/a	n/a	blt	in	-20 to +65	C, R	1204
Kepco	72-5M	Hi-pwr	n/a	n/a	±72, 5A	null	35k	0.3(1)	n/a	n/a	blt	in	-20 to +65	C, R	1579
Kepco	7-2B	Unipolar	n/a	n/a	0-7	null	0.5 x 10 ⁶	0.5V(1)	n/a	n/a	blt	in	-20 to +65	plug-in	147
Kepco	OPS-2000	Hi-volt	n/a	n/a	0-2000	null	0.5 x 10 ⁶	1 (1)	n/a	n/a	blt	in	-20 to +65	C, R	394
Kepco	OPS-1000	Hi-volt	n/a	n/a	0-1000	null	0.5 x 10 ⁶	1 (1)	n/a	n/a	blt	in	-20 to +65	C, R	394
Kepco	OPS-500	Hi-volt	n/a	n/a	0-500	null	0.5 x 10 ⁶	1 (1)	n/a	n/a	blt	in	-20 to +65	C, R	394
Kepco	OPS-20	Unipolar	n/a	n/a	0-20	null	0.5 x 10 ⁶	1 (1)	n/a	n/a	blt	in	-20 to +65	plug-in	199
Kepco	21-1B	Unipolar	n/a	n/a	0-20	null	0.5 x 10 ⁶	1 (1)	n/a	n/a	blt	in	-20 to +65	plug-in	147
Kepco	15-1.5B	Unipolar	n/a	n/a	0-15	null	0.5 x 10 ⁶	1 (1)	n/a	n/a	blt	in	-20 to +65	plug-in	147
Kepco	40-0.5B	Unipolar	n/a	n/a	0-40	null	0.5 x 10 ⁶	1.5 (1)	n/a	n/a	blt	in	-20 to +65	plug-in	147
Kepco	72-0.3B	Unipolar	n/a	n/a	0-72	null	0.5 x 10 ⁶	1.5 (1)	n/a	n/a	blt	in	-20 to +65	plug-in	147
Kepco	100-0.2B	Unipolar	n/a	n/a	0-100	null	0.5 x 10 ⁶	2 (1)	n/a	n/a	blt	in	-20 to +65	plug-in	147

SPUTTERING TARGETS

GLAZED PARTS

Get higher yields across the board

THICK FILM PASTES

O-I microelectronic materials make the difference.

Higher yields. That's where the little things mean a lot.

Like with package sealants. If you could get 5 more good seals on every 100 packages you make, think of the money you'd save.

Like with thick film conductor pastes. Good paste can make a circuit. Bad paste can break it. Forever.

Like with substrate glazes, insulating films, glazed package parts, preform materials and sputtering targets.

We make them all. And more. They're all compatible, highly sophisticated products from the O-I family of work-together electronic materials.

To you, they mean higher yields. Across the board. We'd like to prove it to you. Write us a letter about your materials needs. We'll get back to you fast with literature. Samples, too, if you'd like.

You'll see. Our materials *do* make the difference.

OWENS-ILLINOIS
ELECTRONIC MATERIALS
Toledo, Ohio 43601



PACKAGE SEALANTS

INSULATING FILMS

PREFORM MATERIALS

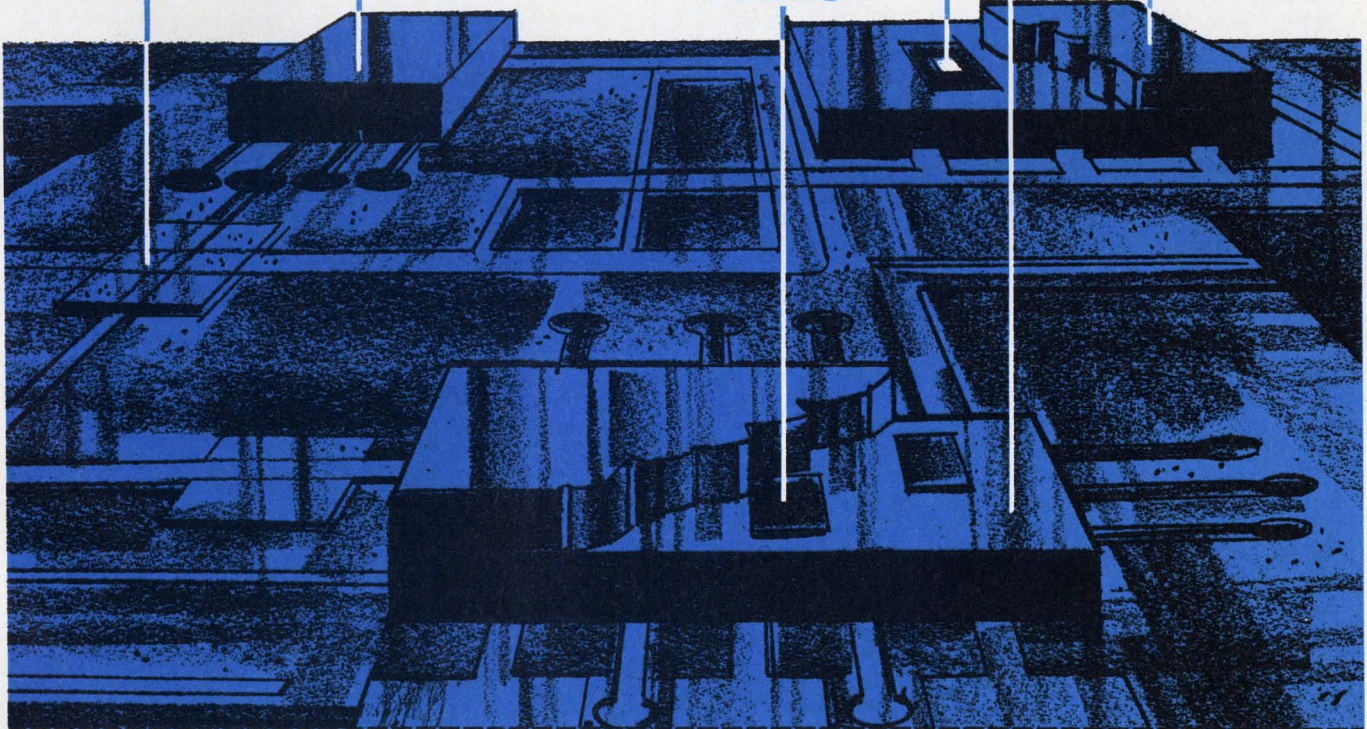

OWENS-ILLINOIS, INC.
Customer Service Mgr.
Electronic Materials
Dept. E-6
Box 1035
Toledo, Ohio 43601

Please send me literature on:

- Package Sealants
- Substrate Glazes
- Sputtering Targets
- Have a technical representative call.
- Glazed Package Parts
- Thick Film Pastes
- Preform Materials

Name _____
 Title _____
 Company _____
 Address _____
 City _____ State _____ Zip _____

INFORMATION RETRIEVAL NUMBER 74

Mfr	Device Number	Notes	Differential Input Impedance Typical (ohms)	Differential Input Impedance Typical (ohms)	Output Voltage Swing/Load Resistance Maximum (Volts/ohms)	Input Offset Voltage (mV)	Dc Voltage Gain	Unity Gain Bandwidth (MHz)	Common Mode Input Voltage Maximum (Volts)	Common Mode Rejection Ratio (Decibels)	Supply Voltages (Volts)		Operating Temperature Range (°)	Package Type	\$ Price per Unit
											+	-			
ADI	741K		0.3M	75	±10/2k	2	25k	0.5	±12	70	15 15	0 to 70	TO-99	6.50	
ADI	502K		10M	75	±10/2k	2	25k	0.5	±12	70	15 15	0 to 70	TO-99	11.80	
ADI	502J		10M	75	±10/2k	6	15k	0.5	±12	70	15 15	0 to 70	TO-99	8.70	
ADI	741J		0.3M	75	±10/2k	6	15k	0.5	±12	70	15 15	0 to 70	TO-99	4.60	
BB	3057/01		0.3	n/a	±10/4k	±6	90	0.7	±11	90	15 15	-25 to +85	MC	6.95	
BB	3053/01		0.3M	n/a	±10/4k	±6	93	0.9	±11	80	15 15	-55 to +125	MC	9.95	
BB	3056/01		0.3M	n/a	±10/4k	±4	93	0.9	±11	90	15 15	-25 to +85	MC	12	
BB	3055/01		0.3M	n/a	±10/4k	±3	93	1	±11	90	15 15	-25 to +85	MC	17	
BB	3054/01		0.3M	n/a	±10/4k	±3	93	1	±11	90	15 15	-25 to +85	MC	19	
BB	3054S/01		0.3M	n/a	±10/4k	±3	93	1	±11	90	15 15	-25 to +85	MC	36	
BB	3052/01	u	0.3M	n/a	±10/4k	±4	93	1	±11	90	15 15	25	MC	17	
BB	3051/01	u	0.3M	n/a	±10/4k	±3	93	1	±11	90	15 15	25	MC	22	
BB	3050/01	u	0.3M	n/a	±10/4k	±3	93	1	±11	90	15 15	25	MC	24	
BB	3050S/01	u	0.3M	n/a	±10/4k	±3	93	1	±11	90	15 15	25	MC	41	
FC	ADO225/1T	*	3M	n/a	±10/2k	±1.5	500k	n/a	±13.5	120	15 15	-20 to +85	MC	37.50	
FC	ADO235/MT	*	5M	10	±10/10k	±1	40k	n/a	±15	30	15 15	-55 to +125	MC	56.25	
FC	ADO225/MT	*	3M	n/a	±10/2k	±1	1M	n/a	±13.5	120	15 15	-55 to +125	MC	56.25	
FC	ADO225/CT	*	3M	n/a	±10/2k	±1.5	500k	n/a	±13.5	120	15 15	0 to 70	MC	22.50	
FC	ADO235/1T	*	5M	10	±10/10k	±1	40k	n/a	±15	30	15 15	-20 to +85	MC	37.50	
FC	ADO244/MT	*	250k	150	±10/2k	±2	45k	n/a	±10	90	15 15	-55 to +125	MC	req	
FC	ADO49C	*	250k	200	±10/2k	±0.0075	25k	0.5	±8	66	15 15	0 to 70	EP	20	
FC	ADO249/CC & /CT	*	150k	5k	±10/5k	±1	20k	1	±10	90	15 15	0 to 70	MC, DIL	5.95	
FC	ADO248/CP & CP8 & CT	*	2M	75	±10/2k	±6	25k	1	±12	90	15 15	0 to 70	MC, DIP	4.85	
FC	ADO247/CT & /CC	*	2M	75	±10/2k	±6	50k	1	±12	90	15 15	0 to 70	MC, DIL	11.25	
FC	ADO241/MT	*	1M	n/a	±10/2k	±5	20k	1	±12	90	15 15	-55 to +125	MC	8.95	
FC	ADO209/1T	*	400k	150	±10/2k	±5	25k	1	±8	90	15 15	-20 to +85	MC	5.85	
FC	ADP249/MC	*	150k	5k	±10/5k	±1	20k	1	±10	90	15 15	-55 to +125	DIL	17.95	
FC	ADO249/MC	*	150k	5k	±10/5k	±1	20k	1	±10	90	15 15	-55 to +125	DIL	17.95	
FC	ADO248/MT	*	2M	75	±10/2k	±5	25k	1	±12	90	15 15	-55 to +125	MC	8.95	
FC	ADO247/MT & /MC	*	2M	75	±10/2k	±5	50k	1	±12	90	15 15	-55 to +125	MC, DIL	27	
FC	ADO241/CT & /CP	*	1M	n/a	±10/2k	±6	20k	1	±12	90	15 15	0 to 70	MC, DIP	4.85	
FC	ADO239/CP	*	150k	5k	±12/10k	±6	6.5k	1	±12	90	15 15	0 to 70	DIP	4.85	
FC	ADO209/CT	*	250k	150	±10/2k	±7.5	15k	1	±8	90	15 15	0 to 70	MC	2.65	
FC	ADO209/MT	*	700k	150	±10/2k	±2	25k	1	±8	100	15 15	-55 to +125	MC	14.95	
FC	ADO52C	*	25k	500	±4/1.5k	±0.005	2k	20	±2.5	80	12 6	0 to 70	EP	20	
FC	ADO52A	*	25k	500	±4/1.5k	±0.005	2.5k	20	±2.5	80	12 6	-55 to +125	EP	35	
FC	ADO202/CT	*	32k	200	±3.5/3.5k	±5	2k	30	-4, +0.5	92	12 6	0 to 70	MC	2.65	
FC	ADO202/MT	*	40k	200	±3.5/3.5k	±2	2.5k	30	-4, +0.5	100	12 6	-55 to +125	MC	8.05	
FC	ADO49A	*	400k	200	±10/2k	±0.005	25k	50	±8	66	15 15	-55 to +125	EP	28	
FC	ADO215/CT	*	1M	75	±10/2k	±7.5	10k	65	±10	92	15 15	0 to 70	MC	11.90	
FC	ADO215/MT	*	1M	75	±10/2k	±5	15k	65	±10	92	15 15	-55 to +125	MC	45	
GE	PA238	*	35k	100	±10/6k	2	12k	25	ina	90	7 7	-55 to +110	DIP	req	
GE	PA223	*	400k	100	±20/20k	6	7k	25	ina	70	13 13	-55 to +110	DIP	req	
ITT	741-1		1M	ina	±12/10k	5	50k	ina	ina	70	22 22	-55 to +125	TO-99	5.95	
ITT	709-1C		400k	ina	±14/10k	5	25k	ina	ina	70	18 18	-55 to +125	TO-99	3.90	
MOTO	MC1535G	o	45k	1.7k	±3.6/10k	1	7k	ina	-2.7, +3.9	90	6 6	-55 to +125	MC	12.75	
MOTO	MC1535F	o	45k	1.7k	±3.6/10k	1	7k	ina	-2.7, +3.9	90	6 6	-55 to +125	TO-86	15	
MOTO	MC1533G		1M	100	±13/10k	1	60k	ina	-9, +10	100	15 15	-55 to +125	MC	12.75	
MOTO	MC1533F		1M	100	±13/10k	1	60k	ina	-9, +10	100	15 15	-55 to +125	TO-91	15	
MOTO	MC1533L		1M	100	±13/10k	1	60k	ina	-9, +10	100	15 15	-55 to +125	TO-116(6)	12.75	
MOTO	MC1530		20k	25	±5.2/1k	1	5k	ina	±2.7	75	6 6	-55 to +125	MC, FP	15, 12.75	
MOTO	MC1531		2M	25	±5.2/1k	3	3.5k	ina	±2.4	65	6 6	-55 to +125	MC, FP	15, 12.75	
MOTO	MC1437L	o	150k	30	±14/10k	1	45k	ina	±10	100	15 15	0 to 75	TO-116(6)	6.50	
MOTO	MC1435L	o	45k	1.7k	7/10k	1	7k	ina	-2.7, +3.9	90	6 6	0 to 75	DIP	6.75	
MOTO	MC1435G	o	45k	1.7k	7/10k	1	7k	ina	-2.7, +3.9	90	6 6	0 to 75	MC	6.75	
MOTO	MC1435F	o	45k	1.7k	7/10k	1	7k	ina	-2.7, +3.9	90	6 6	0 to 75	TO-86	8.25	
MOTO	MC1433G		600k	100	±13/10k	1	60k	ina	±9	100	15 15	0 to 75	TO-91	3.90	
MOTO	MC1433F		600k	100	±13/10k	1	60k	ina	±9	100	15 15	0 to 75	MC	8.85	
MOTO	MC1433L		600k	100	±13/10k	1	60k	ina	±9	100	15 15	0 to 75	DIP	8.25	
MOTO	MC1430		15k	25	±5/1k	2	5k	ina	±2.5	75	6 6	0 to 75	TO-116(5,6)	5.25	
MOTO	MC1430		15k	25	±5/1k	2	5k	ina	±2.5	75	6 6	0 to 75	MC, FP	6.75, 5.25	
MOTO	MC1431		600k	25	±5/1k	5	3.5k	ina	±2.2	75	6 6	0 to 75	MC, FP	6.75, 5.25	
MOTO	MC1431		600k	25	±5/1k	5	3.5k	ina	2.2	75	6 6	0 to 75	TO-116(6)	5.25	
MOTO	MC1741CL		1M	300	±14/10k	2	100k	n/a	±13	90	15 15	0 to 75	TO-116(5)	4.85	
MOTO	MC1741CF		1M	300	±14/10k	2	100k	n/a	±13	90	15 15	0 to 75	TO-91	7.50	
MOTO	MC1741CG		1M	300	±14/10k	2	100k	n/a	±13	90	15 15	0 to 75	TO-99	4.85	
MOTO	MC1537L	o	400k	30	±14/10k	1	45k	n/a	±10	100	18 18	-55 to +125	TO-116(6)	18	
MOTO	MC1539L		300k	4k	±13/1k	1	120k	n/a	±12	10	15 15	-55 to +125	TO-99	11.25	

*Differential

were
Photocells ~~are~~ too expensive
for my application

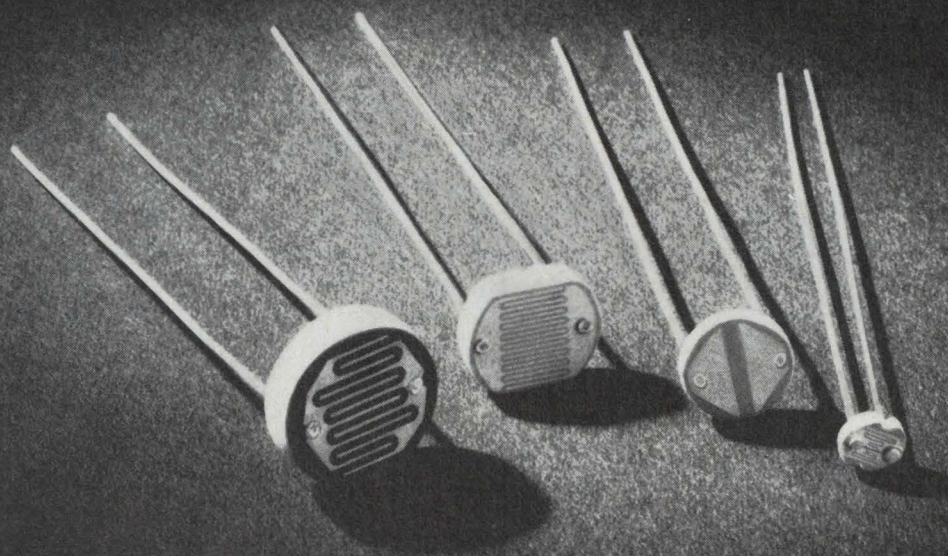

New low-cost design offers many new application possibilities

Plastic encapsulated cells are now readily available in 4 sizes from .170 inches to .435 inches in diameter... and they're as rugged and nearly as reliable as hermetically sealed cells for many applications.

Look again at the applications where you thought photocells were too expensive. We'll send you free samples if you'll tell us why you need them: Call (914) 664-6602 or write Clairex®, 560 South Third Avenue, Mount Vernon, New York 10550.

CLAIREX ELECTRONICS

A DIVISION OF CLAIREX CORPORATION

Mfr	Device Number	Notes	Differential Input Impedance Typical (ohms)	Differential Input Impedance Typical (ohms)	Output Voltage Swing/Load Resistance Maximum (Volts/ohms)	Input Offset Voltage (mV)	Dc Voltage Gain	Unity Gain Bandwidth (MHz)	Common Mode Input Voltage Maximum (Volts)	Common Mode Rejection Ratio (Decibels)	Supply Voltages (Volts)		Operating Temperature Range (°C)	Package Type	\$ Price per Unit
											+	-			
MOTO	MC1439L		300k	4k	±13/2k	2	100k	n/a	±12	110	15	15	0 to 75	TO-116(6)	2.70
MOTO	MC1439G		300k	4k	±13/2k	2	100k	n/a	±12	110	15	15	0 to 75	TO-99	3.60
MOTO	MC1709L		400k	150	±14/10k	1	45k	n/a	±10	90	15	15	-55 to +125	TO-116(5)	5.70
MOTO	MC1709G		400k	150	±14/10k	1	45k	n/a	±10	90	15	15	-55 to +125	TO-99	5.70
MOTO	MC1709F		400k	150	±14/10k	1	45k	n/a	±10	90	15	15	-55 to +125	TO-91	9.25
MOTO	MC1741L		1M	300	±14/10k	2	200k	n/a	±13	90	15	15	-55 to +125	TO-116(5)	22.50
MOTO	MC1741F		1M	300	±14/10k	1	200k	n/a	±13	90	15	15	-55 to +125	TO-91	30.90
MOTO	MC1741G		1M	300	±14/10k	1	200k	n/a	±13	90	15	15	-55 to +125	TO-99	22.50
MOTO	MC1741CP		1M	300	±14/10k	2	100k	n/a	±13	90	15	15	0 to 75	TO-116(6)	4.50
MOTO	MC1539G		300k	4k	±13/1k	2	120k	n/a	±12	110	15	15	-55 to +125	TO-99	11.25
MOTO	MC1536G		10M	1k	±23/5k	2	500k	1	±26	110	40	40	-55 to +125	TO-99	58.50
MOTO	MC1456G		3M	1k	±12/2k	5	100k	1	±12	110	15	15	0 to 75	TO-99	22.50
MOTO	MC1556G		5M	1k	±13/2k	2	200k	1	±13	110	15	15	-55 to +125	TO-99	42
MOTO	MC1436G		10M	1k	±22/5k	5	500k	1	±26	110	34	34	0 to 75	TO-99	27
MOTO	MC1520	*	2M	50	±4/7k	5	1.5k	2	±3	90	6	6	-55 to +125	MC, FP	12, 9.75
NAT	LM307		2	n/a	±14/10k	2	25k	1	±12	90	18	18	0 to 70	MC	6
NAT	NH0004		1.5M	n/a	±11.5/2k	0.2	10k	1	±38	90	40	40	-55 to +125	MC	90
NAT	LM709C		250k	150	±14/10k	2	25k	1	±8	90	18	18	0 to 70	MC, DIL	2.65
NAT	NH0001		1.5M	n/a	±11.5/2k	0.2	10k	1	±15	90	20	20	-55 to +125	MC	72
NAT	LM308A		40	n/a	±14/10k	0.3	80k	1	±14	110	18	18	0 to 70	MC, FP, DIL	30
NAT	LM208A		70M	n/a	±14/10k	0.3	80k	1	±13.5	110	20	20	-25 to +85	MC, FP, DIL	50
NAT	LM108A		70M	n/a	±14/10k	0.3	80k	1	±13.5	110	20	20	-55 to +125	MC, FP, DIL	185
NAT	LM308		40M	n/a	±14/10k	2	25k	1	±14	100	18	18	0 to 70	MC, FP, DIL	15
NAT	LM208		70M	n/a	±14/10k	0.7	50k	1	±14	100	20	20	-25 to +85	MC, FP, DIL	40
NAT	LM108		70M	n/a	±14/10k	0.7	50k	1	±14	100	20	20	-55 to +125	MC, FP, DIL	75
NAT	LM101		800k	n/a	±14/10k	1	25k	1	±12	90	22	22	-55 to +125	MC, FP	22.50
NAT	LM201		400k	n/a	±14/10k	1	25k	1	±12	90	22	22	0 to 70	MC, FP	11.25
NAT	LM301A		2M	n/a	±14/10k	2	15k	1	±12	90	18	18	0 to 70	MC	5.25
NAT	LM101A		4M	n/a	±14/10k	0.7	25k	1	±15	96	22	22	-55 to +125	MC, FP, DIL	45
NAT	LM201A		4M	n/a	±14/10k	0.7	25k	1	±15	96	22	22	-25 to +85	MC, FP, DIL	18
NAT	LH101		800k	n/a	±14/10k	1	25k	1	±12	90	22	22	-55 to +125	MC, FP	22.50
NAT	LH201		400k	n/a	±14/1k	2	15k	1	±12	90	22	22	0 to 70	MC, FP	11.25
NAT	LM107		4M	n/a	±14/10k	0.7	25k	1	±15	96	22	22	-55 to +125	MC, FP, DIL	50
NAT	LM207		4M	n/a	±14/10k	0.7	25k	1	±15	96	22	22	-25 to +85	MC, FP, DIL	20
NAT	LM307		2M	n/a	±14/10k	2	15k	1	±12	90	18	18	0 to 70	MC	6
NAT	LM302		10 ¹²	0.8	±10/8k	5	0.9995	10	n/a	n/a	18	18	0 to 70	MC	4.50
NAT	LM202		10 ¹²	0.8	±10/8k	3	0.9995	10	n/a	n/a	18	18	-25 to +85	MC	9
NAT	NH0003C	u	100k	n/a	±10/100	0.4	20	10	±38	90	20	20	0 to 70	MC	40.50
NAT	LM102		10 ¹²	0.8	±13/8k	2	0.9996	10	n/a	n/a	18	18	-55 to +125	MC	22.50
NAT	LM110	u	10 ¹²	0.75	±10/10k	1.5	0.9999	20	n/a	n/a	18	18	-25 to +85	MC, FP, DIL	15
NAT	LM310		10 ¹²	0.75	±10/10k	2.5	0.9999	20	n/a	n/a	18	18	0 to 70	MC, FP, DIL	4.85
OEI	9314	*	400k	200	±11.5/1k	5	45k	5	±10	86	15	15	-55 to +125	TO-99	13
OEI	9302	*	250k	150	±10/300	10	10k	20	±10	75	15	15	0 to 70	TO-99	18
OEI	9300	1*	5k	150	±1/1k	10	80	80	±1	30	6	6	0 to 70	TO-99	11
OEI	9308	*	250k	100	±10/3k	7.5	30k	120	±10	80	15	15	-55 to +70	TO-99	32
QC	QC1100C	c*	1M	10k	±0.4/10k	0.5	10k	0.5	±0.4	80	12	12	0 to 70	MC	10
QC	QC741C	c*	2M	75	±14/10k	1	200k	1	±13	90	15	15	0 to 70	MC, DIP	3.25
QC	QC748C	c*	2M	75	±14/10k	2	200k	1	±13	90	15	15	0 to 70	MC, DIP	4.85
QC	QC747C	c*	2M	75	±14/10k	1	200k	1	±13	90	15	15	0 to 70	DIP	10.50
QC	QC2107	c*	4M	75	±14/10k	0.5	200k	1	±15	96	15	15	-55 to +125	DIL	50
QC	QC207	c*	4M	75	±14/10k	0.5	200k	1	±15	96	15	15	0 to 70	MC, DIP	9.60
QC	QC1735-9	c*	5	10	±12/10k	1	100k	1	±13	90	15	15	0 to 70	MC	14.30
QC	QC1735-1	*	5	10	±12/10k	1	100k	1	±13	90	15	15	-55 to +125	MC	22.40
QC	QC741	c*	2M	75	±14/10k	1	200k	1	±13	90	15	15	-55 to +125	MC	5.95
QC	QC748	c*	2M	75	±14/10k	1	200k	1	±13	90	15	15	-55 to +125	MC	9.50
QC	QC747	c*	2M	75	±14/10k	1	200k	1	±13	90	15	15	-55 to +125	DIL	20.50
QC	QC1041A	c*	4M	75	±14/10k	0.5	300k	1	±15	96	15	15	-55 to +125	MC	18.50
QC	QC1041C	c*	4M	75	±14/10k	0.5	300k	1	±15	96	15	15	0 to 70	MC, DIP	4.95
QC	QC2207	c*	4M	75	±14/10k	0.5	200k	1	±15	96	15	15	0 to 70	DIP	22
QC	QC307	c*	2M	100	±14/10k	1	200k	1	±12	90	15	15	0 to 70	MC, DIP	4.50
QC	QC107	c*	4M	75	±14/10k	0.5	200k	1	±15	96	15	15	-55 to +125	MC	18.50
QC	QC1735-3	c*	5M	10	±12/10k	1	100k	1	±13	90	15	15	-20 to +85	MC	17.90
QC	QC1456	*	3M	100	±14/10k	5	150k	1	±15	110	15	15	0 to 70	MC, DIP	13.50
QC	QC208	*	70M	100	±14/10k	0.7	300k	1	±14	100	15	15	-25 to +85	MC, DIL	19, 21
QC	QC2307	o*	2M	100	±14/10k	1	200k	1	±12	90	15	15	0 to 70	DIL	11.20
QC	QC1556	*	5M	100	±14/10k	2	200k	1	±15	110	15	15	-55 to +125	MC	26.50
QC	QC308	*	40M	100	±14/10k	1.5	300k	1	±13	100	15	15	0 to 70	MC, DIP	13.50
QC	QC108	*	70M	100	±14/10k	0.7	300k	1	±14	100	15	15	-55 to +125	MC, DIP	38.50, 50
QC	QC101	*	800k	100	±14/10k	1	160k	1	±12	90	15	15	-55 to +125	MC	6.50
QC	QC201A	*	2M	100	±14/10k	1.5	200k	1	±15	96	15	15	0 to 70	MC, DIP	8.25
QC	QC201	*	400k	100	±14/10k	2	150k	1	±12	90	15	15	0 to 70	MC, DIP	5
QC	QC301A	*	2M	100	±14/10k	2	200	1	±12	96	15	15	0 to 70	MC, DIP	4.25
QC	QC201	*	400k	100	±14/10k	2	150k	1	±12	90	15	15	0 to 70	DIL	7
QC	QC101A	*	2M	100	±14/10k	0.7	200k	1	±15	96	15	15	-55 to +125	MC	16.50
QC	QC101	*	800k	100	±14/10k	1	160k	1	±12	90	15	15	-55 to +125	DIL	10.50
QC	QC301A	*	2M	100	±14/10k	2	200	1	±12	96	15	15	0 to 70	DIL	6.25
QC	QC201A	*	2M	100	±14/10k	1.5	200k	1	±15	96	15	15	0 to 70	DIL	10.25
QC	QC101A	*	2M	100	±14/10k	0.7	200k	1	±15	96	15	15	-55 to +125	DIL	18.50

* Differential



And Mallory TCG computer grade capacitors are small. A few of them together can give you the same capacitance as a bulky "can" . . . at a fraction of the volume. They mount directly on printed circuit boards and can be grouped in series or parallel for optimum space utilization.

All-welded construction and PVC sleeves are standard. High-purity aluminum foil assures low dc leakage current. And, an operating range of -40 to $+85^{\circ}\text{C}$ plus a pressure sensitive vent* assure safe, effective service in variety of high C/V applications.

Available in diameters from $\frac{5}{16}$ to 1 inch, case lengths from $\frac{5}{8}$ to $3\frac{5}{8}$ inch, and voltages from 3 to 450 WVDC. Ratings from 22,000 mfd at 3 WVDC to 100 mfd at 450 WVDC.

*Not on $\frac{5}{16}$ -inch diameter capacitors.

Small is beautiful.

MALLORY

MALLORY CAPACITOR COMPANY

a division of P. R. MALLORY & CO. INC.
3029 E. Washington St., Indianapolis, Indiana 46206; Telephone: 317-636-5353

Electrical and electronic components • sequence timers • metallurgical products • batteries

Mfr	Device Number	Notes	Differential Input Impedance Typical (ohms)	Differential Input Impedance Typical (ohms)	Output Voltage Swing/Load Resistance Maximum (Volts/ohms)	Input Offset Voltage (mV)	Dc Voltage Gain	Unity Gain Bandwidth (MHz)	Common Mode Input Voltage Maximum (Volts)	Common Mode Rejection Ratio (Decibels)	Supply Voltages (Volts)		Operating Temperature Range (°C)	Package Type	Price per Unit
											+	-			
QC	QC1556	*	5M	100	±14/10k	2	200k	1	±15	110	15	15	-55 to +125	DIL	28.50
QC	QC1456	*	3M	100	±14/10k	5	150k	1	±15	110	15	15	0 to 70	DIL	15.50
QC	QC308	*	40M	100	±14/10k	1.5	300k	1	±13	100	15	15	0 to 70	DIL	15.50
RAD	2911	*	250k	n/a	±13/2k	2	45k	7	±13	96	15	15	0 to 75	MC	3.50
RAD	2909	*	300k	n/a	±13/2k	2	45k	7	±13	96	15	15	-55 to +125	MC, FP	7.50
RAD	2605	*	300M	n/a	±12/2k	3	150k	12	±11	90	15	15	0 to 75	MC, FP	10.70
RAD	2515	*	80M	n/a	±12/2k	5	15k	12	±11	90	15	15	0 to 75	MC, FP	14
RAD	2600	*	500M	n/a	±12/2k	1	150k	12	±11	100	15	15	-55 to +125	MC, FP	17.85
RAD	2510	*	100M	n/a	±12/2k	4	15k	12	±12	90	15	15	-55 to +125	MC, FP	27.25
RAD	2505	*	40M	n/a	±12/2k	4	25k	12	±11	90	15	15	0 to 75	MC, FP	12.80
RAD	2500	*	50M	n/a	±12/2k	2	30k	12	±11	90	15	15	-55 to +125	MC, FP	24.80
RAD	2525	*	80M	n/a	±12/2k	5	15k	18	±11	90	15	15	0 to 75	MC, FP	14
RAD	2520	*	100M	n/a	±12/2k	4	15k	18	±11	90	15	15	-55 to +125	MC, FP	27.25
RAD	2625	*	300M	n/a	±12/2k	3	150k	35	±11	90	15	15	0 to 75	MC	10.70
RAD	2620	*	500M	n/a	±12/2k	1	150k	35	±11	100	15	15	-55 to +125	MC	17.85
RAY	RM4132		20M	n/a	±15/5k	0.7	160k	0.15	±15	94	20	20	-55 to +125	MC, FP, DIL	45
RAY	RC4132		10M	n/a	±15/5k	1.5	160k	0.15	±15	90	20	20	0 to 70	MC, FP, DIL	10.60
RAY	RE4132		10M	n/a	±10/5k	1.5	160k	0.15	±12	90	15	15	0 to 70	MC, FP, DIL	9.15
RAY	RM709A		350k	150	±10/2k	0.2	45k	1	±8	100	15	15	-55 to +125	MC, FP, DIL	14.95
RAY	RE101A		2M	n/a	±10/2k	2	160k	1	±13	90	15	15	0 to 70	MC, FP, DIL	5.25
RAY	RM101A		4M	n/a	±15/2k	0.7	160k	1	±15	96	20	20	-55 to +125	MC, FP, DIL	45
RAY	RM709		220k	150	±10/2k	1	45k	1	±8	90	15	15	-55 to +125	MC, FP, DIL	5.85
RAY	RM107		4M	n/a	±15/2k	0.7	160k	1	±15	96	20	20	-55 to +125	MC, FP, DIL	49.50
RAY	RC101A		2M	n/a	±15/2k	1.5	160k	1	±15	96	20	20	0 to 70	MC, FP, DIL	11.25
RAY	RE709		300k	150	±10/2k	8	45k	1	±8	86	15	15	0 to 70	MC, FP, DIL	1.25
RAY	RC709		250k	150	±10/2k	2	45k	1	±8	90	15	15	0 to 70	MC, FP, DIL	2.65
RAY	RE107		2M	n/a	±10/2k	2	160k	1	±15	90	15	15	0 to 70	MC, FP, DIL	6
RAY	RE741		0.5M	n/a	±13/2k	2	100k	1	±13	80	15	15	0 to 70	MC, FP, DIL	3.85
RAY	RC107		2M	n/a	±15/2k	1.5	160k	1	±15	96	20	20	0 to 70	MC, FP, DIL	11.25
RAY	RE4131		3M	n/a	±10/2k	1.5	160k	4	±12	96	15	15	0 to 70	MC, FP, DIL	5.05
RAY	RM4131		4M	n/a	±15/2k	0.7	160k	4	±15	96	20	20	-55 to +125	MC, FP, DIL	30
RAY	RC4131		3M	n/a	±15/2k	1	160k	4	±15	96	20	20	0 to 70	MC, FP, DIL	7.60
RAY	RM702		25k	200	±5/100k	2	2.6k	20	+0.5-4	80	12	6	-55 to +125	MC, FP, DIL	8.05
RAY	RC702		25k	200	±5/100k	2	2.6k	20	+0.5-4	80	12	6	0 to 70	MC, FP, DIL	2.65
RAY	RM702A		50k	200	±5/100k	1	4k	20	+0.5-4	90	12	6	-55 to +125	MC, FP, DIL	9.90
RCA	CA3032/702C		20k	200	10 p-p	n/a	n/a	n/a	0.5-4	80	12	6	0 to 70	TO-5	3.30
RCA	CA3031/702A		25k	130	10 p-p	2	n/a	n/a	0.5-4	85	12	5	-55 to +125	TO-5	4.95
RCA	CA3038A		40k	200	5 p-p	2	n/a	n/a	0.5-4	85	6	3	-55 to +125	TO-5	4.95
RCA	CA3038A	(7)	10k	85	14 p-p	1	n/a	n/a	0.65-8	103	12	12	-55 to +125	TO-116(6)	6.44
RCA	CA3030A	(7)	10k	85	14 p-p	1	n/a	n/a	0.65-8	103	12	12	0 to 70	TO-116(5)	4.79
RCA	CA3015A	(7)	10k	85	14 p-p	1	n/a	n/a	0.65-8	103	12	12	-55 to +125	TO-5	6.44
RCA	CA3016A	(7)	10k	85	14 p-p	1	n/a	n/a	0.65-8	103	12	12	-55 to +125	FP	11.39
RCA	CA3038	(7)	7.8k	92	14 p-p	1.37	n/a	n/a	0.65-8	103	12	12	-55 to +125	TO-116(6)	4.79
RCA	CA3030	(7)	7.8k	92	14 p-p	1.37	n/a	n/a	0.65-8	103	12	12	0 to 70	TO-116(5)	2.61
RCA	CA3015	(7)	7.8k	92	14 p-p	1.37	n/a	n/a	0.65-8	103	12	12	-55 to +125	TO-5	3.96
RCA	CA3016	(7)	7.8k	92	14 p-p	1.37	n/a	n/a	0.65-8	103	12	12	-55 to +125	FP	8.91
RCA	CA3047A	(7)	1M	n/a	32/500	2.9	n/a	n/a	6	108	18	18	0 to 70	TO-116(5)	4.79
RCA	CA3033A	(7)	1M	n/a	32/500	2.9	n/a	n/a	6	108	18	18	-55 to +125	TO-116(6)	8.09
RCA	CA3047	(7)	1.5M	n/a	22/500	2.6	n/a	n/a	3.5	100	12	12	-55 to +125	TO-116(5)	2.61
RCA	CA3033	(7)	1.5M	n/a	22/500	2.6	n/a	n/a	3.5	100	12	12	-55 to +125	TO-116(6)	4.79
RCA	CA3037A	(4)	20k	160	6.75 p-p	0.9	n/a	n/a	+0.5-4	70	6	6	-55 to +125	TO-116(6)	4.79
RCA	CA3029A	(4)	20k	160	6.75 p-p	0.9	n/a	n/a	+0.5-4	70	6	6	-55 to +125	TO-116(5)	3.14
RCA	CA3010A	(4)	20k	160	6.75 p-p	0.9	n/a	n/a	+0.5-4	70	6	6	-55 to +125	TO-5	4.79
RCA	CA3008A	(4)	20k	160	6.75 p-p	0.9	n/a	n/a	+0.5-4	70	6	6	-55 to +125	FP	9.74
RCA	CA3037	(4)	14k	200	6.75 p-p	1.08	n/a	n/a	+0.5-4	94	6	6	-55 to +125	TO-116(6)	3.14
RCA	CA3029	(4)	14k	200	6.75 p-p	1.08	n/a	n/a	+0.5-4	94	6	6	0 to 70	TO-116(5)	1.62
RCA	CA3010	(4)	14k	200	6.75 p-p	1.08	n/a	n/a	+0.5-4	94	6	6	-55 to +125	TO-5	2.61
RCA	CA3008	(4)	14k	200	6.75 p-p	1.08	n/a	n/a	+0.5-4	94	6	6	-55 to +125	FP	6.44
SIG	515		ina	ina	ina	0.5	4.5	1	ina	ina	12	12	-55 to +125	MC, FP, DIL	req
SIG	NE516		400k	n/a	±11	ina	18k	1	ina	ina	12	12	-55 to +125	MC, FP, DIL	req
SIG	S5709		400k	n/a	±14	1	45k	1	ina	ina	12	12	-55 to +125	MC, FP, DIL	req
SPRA	U1N2139D		300k	4k	±13/1k	1	120k	n/a	±12	110	15	15	-55 to +125	TO-99	11.25
TPN	1303	c*	210k	3k	±11/5k	±2	30k	2	±13	90	15	15	0 to 100	DIP	3.50
TPN	1301	c*	210k	3	±11/5k	±2	30k	2	±13	90	15	15	0 to 100	MC	3.50
TPN	1300	c*	210k	3k	±11/5k	±2	30k	2	±13	90	15	15	0 to 100	DIP	6
TPN	T82AH	c*	1M	150	±12/1k	1	60k	5	±9	90	15	15	-55 to +125	MC	12
TPN	T52	c*	210k	1k	±11/5k	±2	26k	2	±13	90	15	15	-25 to +100	MC	7.50
TPN	S52	c*	210k	1k	±11/5k	±2	26k	2	±13	90	15	15	-25 to +100	DIP	7.50

* Differential

Intech plays the game without spikes.

If you've had uncertain feelings about chopper op amps, you've had just cause.

The Op Amp Boys have been making noise about chopper performances when the amplifiers they offered were only useful with elaborate filters.

Sometimes you were "spiked." But good.

Intech's got the quiet answer to your historically noisy problem: the A-240 series chopper operational amplifiers. These uniquely designed units virtually eliminate chopper spikes. This feature alone makes the A-240 the first chopper to be used in wideband applications without the use of special filters.

In fact, the engineers who have evaluated the A-240 can't even distinguish the chopper frequency.

While the Op Amp Boys drift from one performance spec to another, the Intech units hold their own at

$.05\mu\text{V}/^\circ\text{C}$. Low frequency input noise voltage stands at $1.0\mu\text{V}$ p-p maximum.

Compare that to the "old" chopper amplifier specifications.

Intech does not make idle claims. Try the A-240 on a trial basis. You'll experience what we're proclaiming. The units, packaged in 1.5" x 1.5" x .5" modules, are \$91.00 each (quantity discounts available) and are available from factory and distributor stock.

If you want to get back into the ballgame, contact your local Intech representative, or write us directly using this publication's reader service card, for more information and comparison studies on the A-240 series.

Intech Incorporated, 1220 Coleman Avenue, Santa Clara, California 95050.

Phone: (408) 244-0500. 

THE SCORE*

*Vertical resolution: 5 nA/div. Horizontal resolution: 2 ms/div.

Chopper amp boys

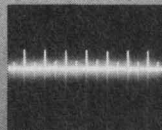

Intech

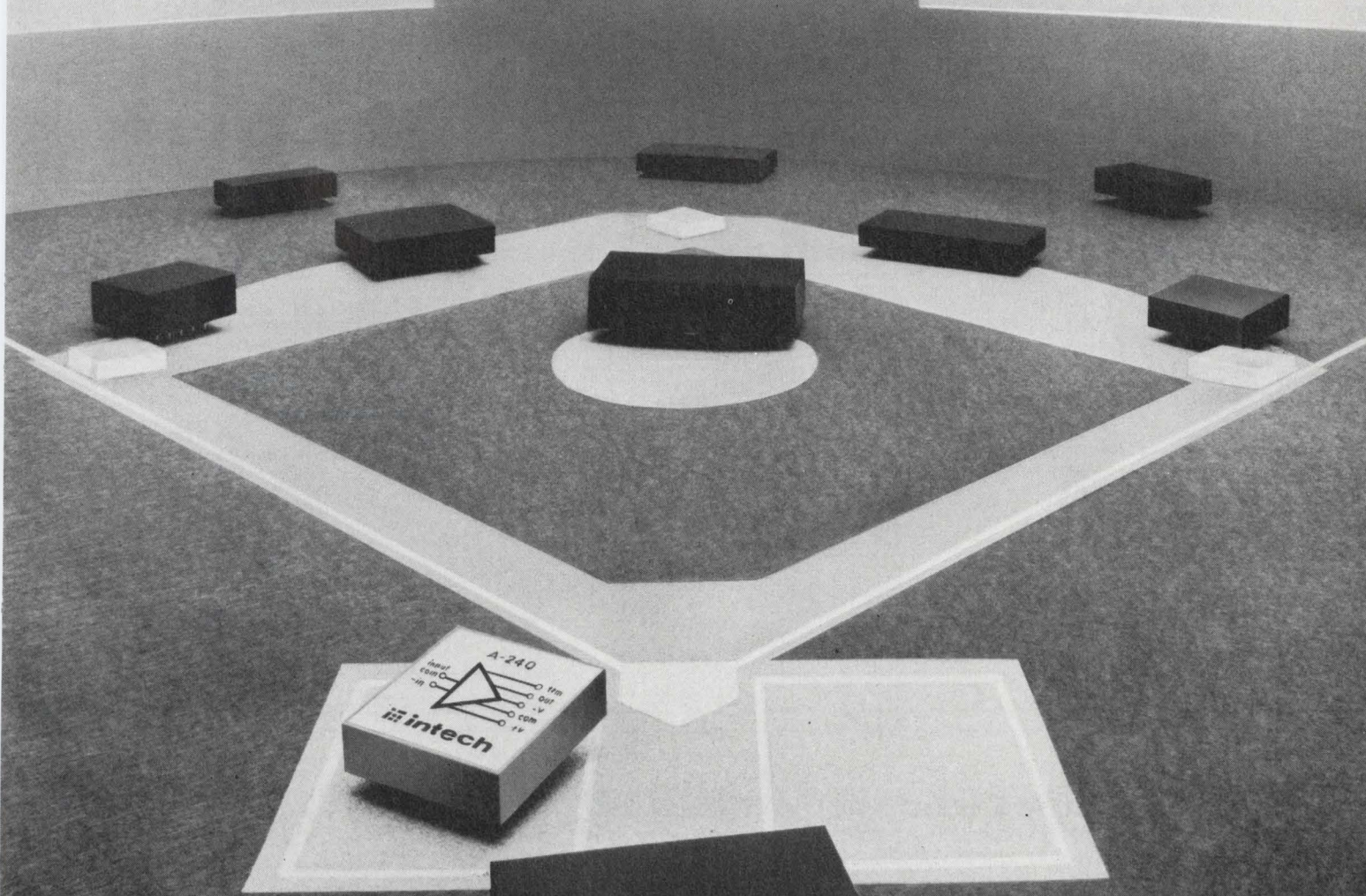
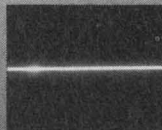

Intech takes on the chopper amp boys.

Hybrid op amps (general purpose)

93

Mfr	Device Number	Notes	Differential Input Impedance Typical (ohms)	Differential Output Impedance Typical (ohms)	Output Voltage Swing/Load Resistance Maximum (Volts/ohms)	Input Offset Voltage (mV)	Dc Voltage Gain	Unity Gain Bandwidth (MHz)	Common Mode Input Voltage Maximum (Volts)	Common Mode Rejection Ratio (Decibels)	Supply Voltages (Volts)		Operating Temperature Range (°C)	Package Type	Price per Unit
											+	-			
GI	P PC201-		200k	200	24/10k	1	73	0.4	ina	120	12	12	-55 to +125	FP	req
GI	PC200		100k	200	24/10k	1	73	0.4	ina	80	12	12	-55 to +125	FP	req
INT	FA201		10 ¹²	0.2	±10/2k	1	1	0.5	n/a	n/a	15	15	-25 to +85	EP	24.50
INT	FA202		10 ¹²	0.2	±10/2k	0.5	1	0.5	n/a	n/a	15	15	-25 to +85	EP	32
INT	FA203		10 ¹¹	0.2	±10/2k	0.5	1	0.5	n/a	n/a	15	15	-25 to +85	EP	48
BB	3350/03	dt	10 ¹¹	n/a	±10/2k	±2	86	1	±10	60	15	15	-25 to +85	DIP	27
BB	3349/03	d	10 ¹¹	n/a	±10/2k	±2	86	1	±10	60	15	15	-25 to +85	DIP	37
BB	3357/15	et	0.5M	n/a	±10/0.5k	±0.5	120	1	±10	100	15	15	-25 to +85	MC	55
BB	3145/15	et	0.5M	n/a	±10/0.5k	±0.5	120	1	±10	100	15	15	-25 to +85	MC	75
BB	3144/15	et	0.5M	n/a	±10/0.5k	±0.3	120	1	±10	100	15	15	-25 to +85	MC	95
BB	3358/12C	et	0.5M	n/a	±10/0.5k	±0.5	120	1	±10	100	15	15	-25 to +85	MC	50
BB	3134/12C	et	0.5M	n/a	±10/0.5k	±0.5	120	1	±10	100	15	15	-25 to +85	MC	70
BB	3133/12C	et	0.5M	n/a	±10/0.5k	±0.5	120	1	±10	100	15	15	-25 to +85	MC	85
BB	3269/14	e	1M	n/a	±10/3k	rs	114	1	±10	86	15	15	-25 to +85	MC	24
BB	3268/14	e	1M	n/a	±10/3k	rs	114	1	±10	86	15	15	-25 to +85	MC	34
BB	3267/12C	e	1M	n/a	±10/1k	rs	114	1	±10	86	15	15	-25 to +85	MC	11
BB	3266/12C	e	1M	n/a	±10/1k	rs	114	1	±10	86	15	15	-25 to +85	MC	21
BB	3227/03	e	0.3	n/a	±10/5k	±1	93	1	±10	80	15	15	-25 to +85	r	11
BB	3226/03	e	0.3	n/a	±10/5k	0.5	93	1	±10	80	15	15	-25 to +85	r	16
BB	3352/03	e	0.3M	n/a	±10/5k	±0.5	93	1	±10	80	15	15	-25 to +85	r	21
MEC	1764	d	10 ¹¹	1k	10/2k	s	300k	1.5	±10	74	15	15	-25 to +85	MC	60
SSEC	3051		10 ⁶	10	0.001	n/a	50k	2	10	120	15	15	-55 to +100	MIL-T-27	285
SSEC	3002		300x10 ⁶	100	0.005	n/a	20x10 ⁶	2	15	100	15	15	-55 to +125	DIL	175
SSEC	3001		10 ⁶	10	0.001	n/a	50k	2	10	120	15	15	-55 to +100	plug-in	75
B&H	20-247B1	de	500k	n/a	10/2k	0.5	25k	2	11	100	15	15	-55 to +125	TO-8	31
B&H	20-007B1	e	500k	n/a	10/2k	0.5	25k	2	11	100	15	15	-25 to +85	EP	21
B&H	20-107B1	e	500k	n/a	10/2k	0.5	25k	2	11	100	15	15	-25 to +85	EP	21
Amp	4TF401	ce	300	20	±10	10	100	2	±10	80	15	15	-25 to +85	EP	23
B&H	20-008B1	d	10 ¹¹	n/a	10/2k	1	25k	4	7	80	15	15	-25 to +85	EP	35
B&H	20-248B1	d	10 ¹¹	n/a	10/2k	1	25k	4	7	80	15	15	-55 to 125	TO-8	60
B&H	20-108B1	d	10 ¹⁰	n/a	10/2k	1	25k	4	7	80	15	15	-25 to +125	EP	35
Amp	ATF404	cd	10 ¹¹	20	±10	ext	100	4	±10	74	15	15	-25 to +85	EP	34
MEC	1810	d	10 ¹¹	1k	10/2k	s	40k	8	±10	69	15	15	-25 to +85	MC	33
PARC	215		50	50	±15	±0.015	10 ⁸	10	n/a	n/a	24	24	15 to 45	C, R	595
MEC	1821	d	10 ¹¹	1k	10/2k	s	20k	10	±10	74	15	15	-25 to +85	MC	14.25
GI	NC260		1M	12	20/1k	5	1	40	n/a	n/a	12	12	-55 to +125	TO-5	req
GI	PC260		1M	12	20/1k	5	1	40	n/a	n/a	12	12	-55 to +125	FP	req
GI	NC0002		200k	6	22/1k	40	1	50	n/a	n/a	12	12	-55 to +125	TO-5	req
GI	HC0002C		200k	6	22/1k	40	1	50	n/a	n/a	12	12	0 to 70	TO-5	req
GI	PC212		100k	50	22/5k	2	64	900	±10	80	12	12	-55 to +125	FP	req
GI	NC210B		90k	50	26/5k	1	67	1600	±12	80	15	15	-55 to +125	TO-8	req
GI	PC210		90k	50	34/5k	2	70	1800	±15	80	18	18	-55 to +125	FP	req
GI	NC210A		90k	50	26/5k	0.2	67	2500	±12	80	15	15	-55 to +125	TO-8	req

Hybrid op amps (differential)

94

TPN	1404	c	4M	2k	±4/4k	±5	100k	0.15	±3.5	95	4.5	4.5	-25 to +85	S2	49
Zelt	ZA802M1	d	10 ¹¹	n/a	±10/1.4k	f	100k	2	±10	100	15	15	-25 to +85	module	26
TPN	1406	c	300k	1k	±12/2k	±2	50k	2	±10	100	15	15	-25 to +85	MC	26
TPN	1408	c	100G	2k	±10/2k	±1	500k	2	±10	80	15	15	-25 to +85	T-1	30
OPA	435		100k	50	±20/1k	±20	20k	2	±20	80	24	24	-55 to +125	TO-3	30
TPN	1402	c	100G	1k	±14/5k	0.3	20k	2.5	±12	76	15	15	-25 to +85	MC	50
Zelt	ZA801D1	d	10 ¹¹	n/a	±10/1.4k	f	100k	4	±10	80	15	15	-25 to +85	DIP, EP	30
Zelt	ZA801T1	d	10 ¹¹	n/a	±10/1.4k	f	100k	4	±10	80	15	15	-25 to +85	TO-8	35
Zelt	ZA801M1	d	10 ¹¹	n/a	±10/1.4k	f	100k	4	±10	80	15	15	-25 to +85	module	14.75
Zelt	ZA101D1	e	10 ⁶	n/a	±10/2k	f	50k	4	±10	94	15	15	-25 to +85	DIP, EP	20
Zelt	ZA801E1	d	10 ¹¹	n/a	±10/1.4k	f	100k	4	±10	80	15	15	-25 to +85	DIP	45
DDC	H50	d	10 ¹¹	n/a	±10/2k	f	20k	4	±10	70	15	15	-55 to +125	TO-8	60
TPN	1405	c	100G	500	±11/500	±5	300k	12	±10	75	15	15	-25 to +85	DIL	55
OEI	9706	d	10G	30	±10/3.3k	10	1k	20	±7	80	15	15	-55 to +85	module	54
OPA	4009		100k	2.5k	±15/10k	±100	650	30	±30	80	36	36	-55 to +125	TO-5	10
OEI	9712	d	10G	30	±10/50	10	300	30	±11	70	15	15	-55 to +65	module	62
OEI	9776	d	10G	30	±10/3k	10	300	30	±5	70	15	15	-55 to +75	module	58
TPN	1407	c	100G	1k	±11/5k	±1	80k	30	±10	75	15	15	-25 to +85	MC	63
TPN	Q25AH	c	100G	1k	±11/5k	±1	80k	30	±10	75	15	15	-55 to +125	MC	180
TPN	Q85AH	c	2M	1k	±11/5k	6	80k	30	±11	92	15	15	-55 to +125	MC	161
OEI	9412		3k	30	±10/50	7.5	300	60	±11	70	15	15	-55 to +65	module	52
OEI	9406		5k	1k	±10/3.3k	10	1k	70	±6	80	15	15	-55 to +85	module	34

Hybrid op amps (chopper-stabilized)

95

TPN	1412	c	1M	200	±14/2.4k	0.025	100M	1	n/a	n/a	15	15	-25 to +85	A-5	125
INT	A501	p	250k	20	±10/200	±2	0.5x10 ⁶	100	n/a	n/a	15	15	-25 to +85	EP	105
INT	A502	p	250k	20	±10/200	±1	2x10 ⁶	100	n/a	n/a	15	15	-25 to +85	EP	125

Now, you can enjoy a choice of suppliers...



CLARE TF MILITARY RELAY
Three contact arrangements: 1 Form C
with base-connected movable contacts;
1 Form C and 2 Form C with movable
contacts insulated from case.

Clare's TO-5 Relay meets or exceeds MIL-R-5757E!

In TO-5's, you can now enjoy a *choice* of suppliers—and you can sit back and enjoy Clare's dependable performance and prompt delivery. For Clare's TF (TO-5) Relays meet or exceed the requirements of MIL-R-5757E. TF features: a rigid frame to keep elements stable, balanced armature aligned; pressurized nitrogen to minimize arcing, extend contact life; hermetically-sealed case—all welded; optimized magnetic circuitry to assure maximum contact pressure. Withstands shock to 80 G, vibration to 30 G. Keeps going at temperatures from -65°C to $+125^{\circ}\text{C}$. 1,000,000 operations at low level, 100,000 at rated load.

For information, circle Reader Service number, call your Clare sales engineer or distributor, or write for Data Sheet 758. C. P. Clare & Co., Chicago, Illinois 60645...and worldwide.



a GENERAL INSTRUMENT Company

INFORMATION RETRIEVAL NUMBER 78

ZM1000
 READOUT
 TUBE
 NOW



\$2.95
 IN THOUSAND LOTS

The Amperex ZM1000 is the first digital numerical indicator tube, designed from the ground up for high-volume applications. It provides big economies, not only in initial cost but also in application. Its low price of \$2.95 in thousand lots is only part of the story... in volume, the ZM1000 sells for less than \$2.00.

We scrapped every notion about how to make numerical indicator tubes and developed a completely new design that offers unsurpassed performance and reliability at mass-production prices.

Every ZM1000 has a built-in decimal-point indicator. Use it if you wish — or ignore it... in either case, there's no additional cost for the decimal-point. The ZM1000's large numerals are clearly legible at 35 feet, yet an 8-digit readout can be installed in only 6 inches of panel.

Superior design makes the ZM1000 more economical to use, too; its high-temperature base is designed to plug directly into a printed circuit board or an inexpensive, readily available socket.

- IMPORTANT FEATURES
- Dynamic life expectancy..... 200,000 hrs.
 - Height of numeral..... 0.6"
 - Tube diameter..... 0.75"
 - Height of tube..... 1.67"

For complete data and comprehensive application bulletin on indicator-driver circuits for the ZM1000, write: Amperex Electronic Corporation, Semiconductor and Microcircuits Division, Slatersville, Rhode Island 02876.

Amperex®
 TOMORROW'S THINKING IN TODAY'S PRODUCTS
 A NORTH AMERICAN PHILIPS COMPANY

New Products

Hybrid transistor - can vhf/uhf amplifiers gain 14 dB minimum from 5 to 500 MHz

Avantek, Inc., 2981 Copper Rd., Santa Clara, Calif. Phone: (408) 739-6170. P&A: \$100 to \$175; stock.

Offering guaranteed performance over the frequency range of 5 to 500 MHz, the MICamp line of thin-film vhf/uhf amplifiers in TO-8 transistor cans features a minimum gain of 9 or 14 dB. In addition, these wideband rf amplifiers can be cascaded to achieve flat gains as high as 56 dB, with good matching between individual units and no sacrifice in bandwidth.

When developing rf amplifiers, equipment designers can now employ the same time and cost-saving techniques that are used at low frequencies when designing with operational amplifiers. Irksome rf circuit problems like impedance matching networks, feedback loops,

biasing, stabilization elements, noise figure, and intermodulation are actually pre-solved by MICamp series UTO-500 amplifiers.

The user simply inserts the MICamps in a PC card or thick-film carrier, solders them in a cascaded configuration, applies a dc voltage — and the units are operational and within specification. This frees the engineer from close-up rf network design and lets him concentrate on the bigger problems in his overall equipment design.

MICamp amplifiers are hybrid structures on sapphire substrates with gold interconnects. They are single-stage devices employing two transistor chips per stage — one for amplifying, and the other for biasing and stability.

Each unit provides over eight octaves of flat rf bandwidth, from

2 to 700 MHz instantaneous. Their minimum flat frequency response ranges from 5 to 500 MHz.

All input and output impedances terminate into 50 Ω over the full eight octaves for a maximum VSWR specification of 2:1, in and out. Maximum gain flatness is within ± 1 dB.

Initiating the line are three models: the UTO-501, the UTO-502 and the UTO-503. Minimum gain is 14 dB for the first two, and 9 dB for the third one.

For a gain compression of 1 dB, minimum power output is -2 dBm for the 501, 7 dBm for the 502, and 13 dBm for the 503. Maximum noise figure is 4, 5.5 and 6.5 dB, respectively.

Dc input power can be 15 or 24 V, depending on the model. The continuous operating temperature range goes from -54 to $+100^\circ\text{C}$ for all the units.

Individual amplifiers can be supplied in a standard TO-8 transistor can or in a fully shielded package. Amplifiers can also be bought cascaded on the same substrate in groups of two, three or four. These packages can be fully shielded too.

Expected applications for the new MICamp amplifiers are numerous. They include: communications equipment operating in hf, vhf, uhf, and microwave regions; special CATV equipment; high-frequency laboratory instruments; radar and navigational systems; collision avoidance and beacon sets; and telemetry and space communication data links; and high-speed digital systems.

Because of their flat wideband frequency response, series UTO-500 units can also be used in a multitude of equipment functions. Some of these are: rf and i-f stages in receivers, local and master oscillator multiplier chains, pulse counting, rf feedback loops, and isolation and buffer stages.

CIRCLE NO. 250

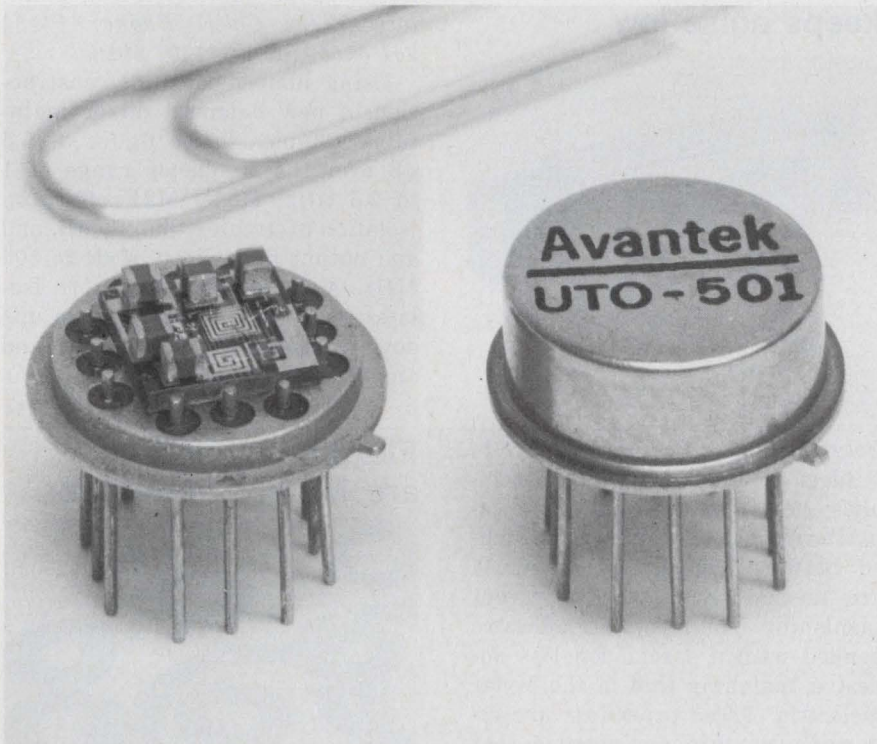

Vhf/uhf amplifiers in TO-8 metal cans guarantee 14 dB of gain from 5 to 500 MHz. Four of these thin-film hybrids can be cascaded for a flat gain of 56 dB with no sacrifice in the multi-octave wideband performance.

Four-GHz transistors retail for only \$14

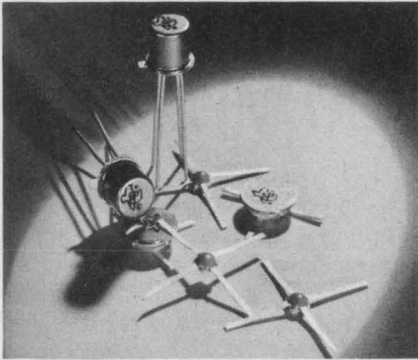

Texas Instruments Inc., 13500 N. Central Expressway, Dallas, Tex. Phone: (214) 238-2011. P&A: \$20 or \$30; 10 to 30 days.

Featuring operation from 100 MHz to 4 GHz over the temperature range of -55 to $+85^{\circ}\text{C}$ with negligible change in parameters, the MS175 and MS173 microwave transistors offer designers of high-frequency circuits a good performance/price ratio with unit prices (100-piece quantities) of \$14 and \$20, respectively. Prices for 1-to-99 quantities are \$20 and \$30, respectively.

They were developed from the MERA (molecular electronics for radar applications) program and include full S-parameter characterization to simplify their use in computer-aided-design circuits.

Power outputs are 100 mW at 4 GHz and 300 mW at 2 GHz for the MS175. The MS173 has power outputs of 50 mW at 4 GHz and 200 mW at 2 GHz.

Typical noise figures are less than 2 dB at 500 MHz and less than 4 dB at 1 GHz for the MS175. The MS173 has noise figures of less than 3 dB at 1 GHz and less than 6 dB at 2 GHz.

Power gain with a 50- Ω termination is 16 dB at 500 MHz and 12 dB at 1 GHz for the MS175 and MS173, respectively.

Both transistors are direct plug-in replacements of presently available types that reportedly cost as much as five times more. Both are available in three package configurations including TO-72 cases.

The MS175 handles emitter-to-collector currents of 1 to 50 mA. The MS173 handles emitter-to-collector currents of 1 to 30 mA.

CIRCLE NO. 251

Low-profile mixer reaches 1000 MHz

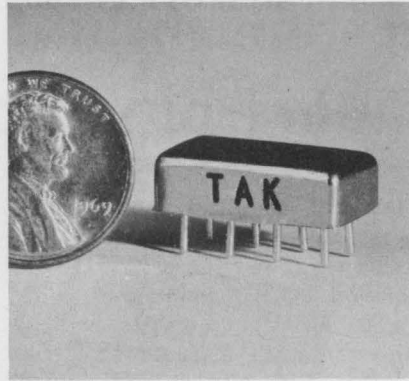

Merrimac Research and Development, Inc., 41 Fairchild Pl., West Caldwell, N.J. Phone: (201) 228-3890. P&A: \$65; 30 days.

Spanning the frequency range of 10 to 300 MHz, the SES-113-155 spst rf switch provides 60-dB isolation (10-100 MHz) when OFF and 2-dB insertion loss (10-200 MHz) when ON. Maximum rf input power is +20 dBm and it operates from +8 dBm. Gate ON and OFF ratios are +1.4-V/30 mA and $-1.4\text{-V}/30\text{-mA}$, respectively. Maximum current is 60 mA.

CIRCLE NO. 253

Balanced mixer keeps noise low

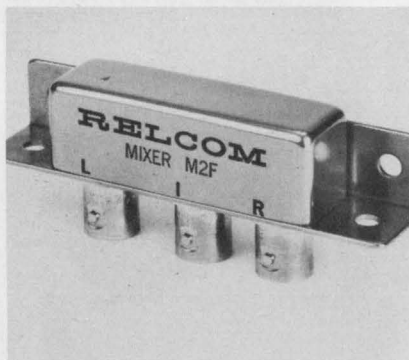

Polytton Corp., New Rochelle, N.Y.

Ideal for use in cavity assemblies, new flexible dc blocking capacitors consist of Mylar sandwiched between copper layers, which are flashed with gold to prevent tarnishing. The layers are adhesive bonded with a special low-loss adhesive, matching that of the Mylar dielectric. These capacitors are reportedly so thin and flexible that they can readily follow the contour of the contacting flanges.

CIRCLE NO. 255

Mini-Circuits Laboratory, div. of Scientific Components Corp., 2913 Quentin Rd., Brooklyn, N. Y. Phone: (212) 252-5252. P&A: \$16; stock.

Measuring just 0.2-in. high, a new hermetically sealed double balanced mixer operates from 2 to 1000 MHz. Noise figure for model TAK-7 is typically less than 6 dB throughout most of its frequency range. The unit is compatible with IC printed-circuit-board layouts; it has eight leads located on a 0.2-in. grid.

CIRCLE NO. 252

Broadband rf switch covers 10 to 300 MHz

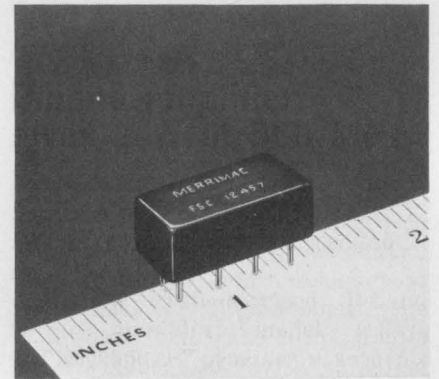

Relcom, 2329 Charleston Rd., Mountain View, Calif. Phone: (415) 961-6265. P&A: \$140; stock.

Using lumped-constant construction, a new balanced mixer maintains a typical noise figure of 5.5 dB over the frequency range of 1 to 2.5 GHz. Model M2F offers an isolation of greater than 20 dB, and an output bandwidth of dc to 500 MHz. A set of built-in filters isolates its R port. Two uses are up/down frequency conversion and amplitude modulation.

CIRCLE NO. 254

Flexible capacitors are Mylar sandwiches

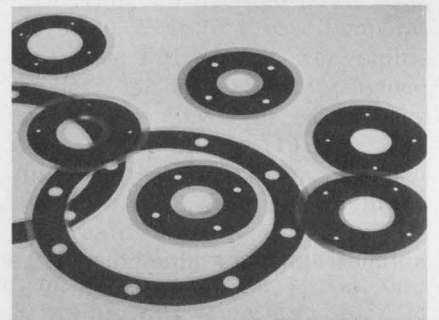

Any DC VOM with 0.1% accuracy should cost more.

Model 1241
\$289
complete.

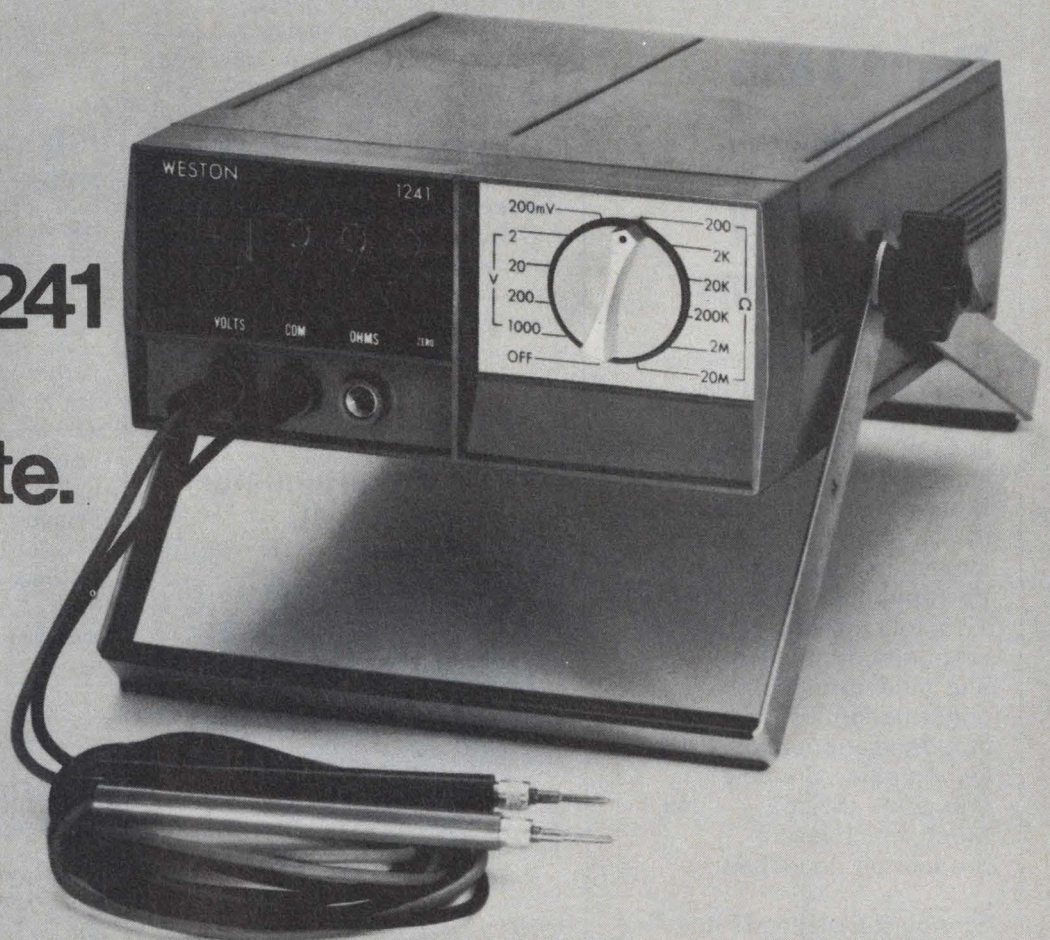

We wanted the price low enough that anyone taking DC voltage or resistance readings wouldn't have to think twice about choosing our new Model 1241. As it turned out, we can give you an even bigger break. Because most of the circuitry, as well as the rugged housing and many convenience features, had been developed previously for the Weston 1240 DMM which we introduced last November.

Here's a proprietary-designed Weston instrument you can pack in your tote case, use on the bench, or mount in a

standard 3½" panel. The only "extra" you may ever need is an optional battery pack for remote field applications. Model 1241 gives you high-impedance measuring capability to 3½ digits on five voltage and six ohm ranges.

In addition to its outstanding accuracy of 0.1% of reading $\pm 0.05\%$ F.S. on Volts (0.5% ± 1 digit on Ohms), this advanced meter features complete circuit overload protection. Fuses are replaceable without opening the rugged, glass-filled thermoplastic case. And, of course, there's Weston's patented dual

slope* integration, automatic decimal positioning, and non-blinking display.

If you want to see how much quality a dollar will buy today, contact your Weston Distributor. He also has in stock our 1240 DMM, with 26 AC-DC ranges plus all the above features. Or write today for complete specifications.

WESTON INSTRUMENTS DIVISION,
Weston Instruments, Inc., Newark, N.J.
07114, a Schlumberger company

WESTON®

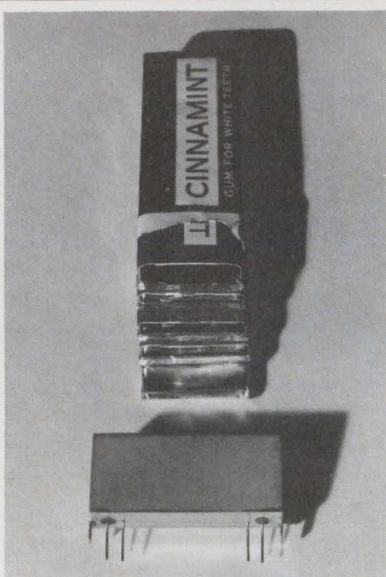

The 10.7 MHz Flatpack—solves sticky filter problems

You name it and Comline® Flatpack integrated crystal filters have got it. **Size?** Less than one-sixth that of standard. **Versatility?** Mounts flat for low profile (.22 in.) or on edge for minimum board space. **Performance?** Beautiful! Two, four, six and eight-pole response. Monolithic and tandem monolithic construction for maximum stopband attenuation. **Price?** Unbeatable! Six-pole flatpack — \$22.82, 1-4 pcs. Much, much less in production quantities.

Standard Comline Flatpack bandwidths — 13 and 30 kHz. Other bandwidths on request. Conventional 10.7 MHz filter packages also available.



Piezo Technology Inc.

2400 Diversified Way
Orlando, Florida 32804
305-425-1574

a subsidiary of Walter Kidde & Company, Inc.



MICROWAVES & LASERS

Compact coupler goes to 110 MHz

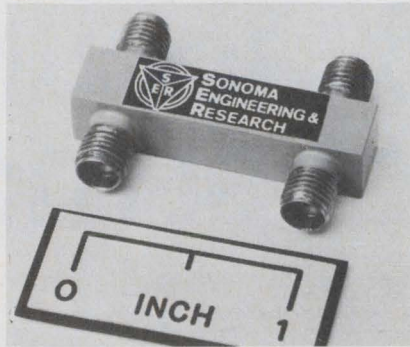

Sonoma Engineering & Research, 760 Montecito Center, Santa Rosa, Calif. Phone: (707) 539-2702.

Spanning the frequency range of 40 to 110 MHz, a new subminiature octave coupler measures only 1-1/4 by 2-1/2 by 1/2 in. Besides this model S-3D11, other subminiature couplers are available to cover the frequency range of 25 MHz to 4 GHz. Units with phase matching or with special frequency bands can also be manufactured to custom specifications.

CIRCLE NO. 256

Multi-band attenuator is flat to ± 4 dB



Nesco Manufacturing Co., 28 Osgood St., Methuen, Mass. Phone: (617) 685-2785.

For any value of attenuation, down to a minimum isolation of 60 dB, model MBA-124 multi-band variable attenuator keeps its output flat within a ± 4 -dB deviation between 0.5 and 12.4 GHz. Maintaining an insertion loss of 0.5 to 2.5 dB over the entire spectrum, the compact device will handle 1 W of cw power. When used as a spst switch, its response time is 35 ns.

CIRCLE NO. 257

Schottky diodes get beam leads

Sylvania Electric Products Inc., Semiconductor Div., 1100 Main St., Buffalo, N.Y.

Two new series of beam-lead Schottky-barrier diodes are designed for use in the S-band, X-band and Ku-band frequency ranges. Type D5600 and D5800 units can operate over a temperature range of -65 to $+150^\circ\text{C}$. At $+25^\circ\text{C}$, maximum power dissipation for the S-band devices is 100 mW, 75 mW for the X-band diodes and 60 mW for the Ku-band ones.

CIRCLE NO. 258

P-band amplifier gives 2 W at 500 MHz

Applied Research Corp., 76 S. Bayles Ave., Port Washington, N.Y. Phone: (516) 883-5700. Availability: 6 wks.

A new transistorized P-band power amplifier, model HFW-2(TX)-2550/P, provides a saturated power output of 2 W within a passband of 250 to 500 MHz. The unit has a gain of 10 dB, and its primary power requirement is 28 V dc at 0.6 A. It measures 4-13/16-in. long by 2-in. wide by 1-5/8-in. high. Applications include telemetry and uhf communications.

CIRCLE NO. 259

Hybrid multicoupler delivers 40 watts

Electronic Navigation Industries Inc., 1337 Main St. East, Rochester, N.Y. Phone: (716) 288-2420. Price: \$210.

Boasting an average power rating of 40 W at 75°C case temperature, the PM 40-4 power multicoupler is a four-way hybrid device covering the frequency range of 250 kHz to 110 MHz. The unit features a maximum insertion loss of 0.4 dB, and an amplitude balance of 0.2 dB. Its VSWR is 1.2:1 maximum and its isolation is 25 dB minimum.

CIRCLE NO. 260

FET-input op amps hold bias to 100 fA

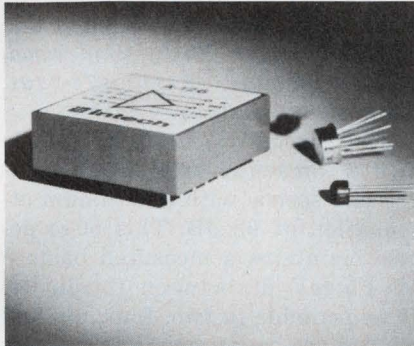

Intech Inc., 1220 Coleman Ave., Santa Clara, Calif. Phone: (408) 244-0500. Price: \$49.50 or \$58.50.

Two new FET-input operational amplifiers guarantee an input bias current of less than 100 femto-ampere (10^{-15} A). Maximum input voltage drift is $50 \mu\text{V}/^\circ\text{C}$ for model A-126 and $25 \mu\text{V}/^\circ\text{C}$ for model A-127. Additional features for both amplifiers include a 10^7 -M Ω input impedance, a 100-dB common-mode rejection ratio, and a 2- μV rms input noise.

CIRCLE NO. 261

DIP decoder/driver has quad-latch memory

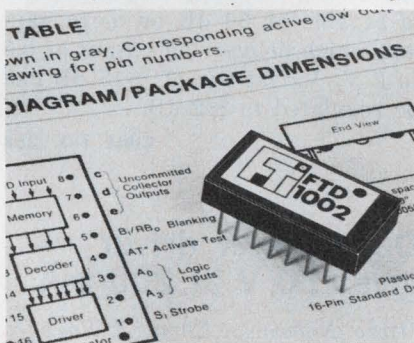

Fabri-Tek Micro-Systems, Inc., 1150 N.W. 70th St., Fort Lauderdale, Fla. Phone: (305) 933-9351. Price: \$13.75.

Housed in a 16-pin dual-in-line package, a BCD-to-seven-output decoder/driver features a quad-latch memory. This means that model FTD-1002 allows continuous transfer of four-bit BCD input data to the decoder when the memory strobe is high. With the strobe low, data information is retained until another strobe transition takes place.

CIRCLE NO. 262

Now you can specify:

- Clean-cut, modern design
- Time-Tested, tough phenolic case
- Environment-Free Viewing Area

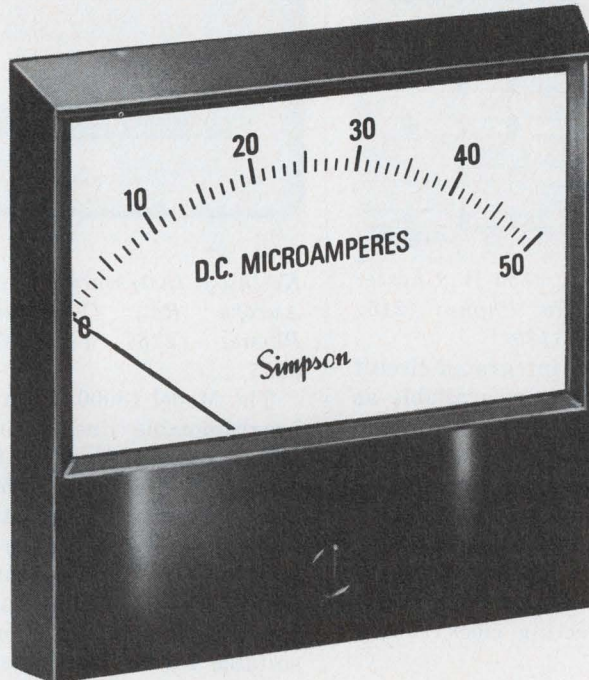

all in the new Simpson

CENTURY SERIES PANEL INSTRUMENTS

- $1\frac{1}{2}$ ", $2\frac{1}{2}$ ", $3\frac{1}{2}$ " and $4\frac{1}{2}$ " sizes. Ranges, scales and other characteristics to meet your exact requirements.
- Variety of movements. Matching Relays, Wattmeters and Elapsed Time Meters also available.

Standards now in stock at electronic distributors everywhere. For custom specials, see your Simpson Representative . . . he's listed in the Yellow Pages. For more details, write for Bulletin 2081.



SIMPSON ELECTRIC COMPANY

5200 W. Kinzie St., Chicago, Ill. 60644, Phone: (312) 379-1121
 Export Dept: 400 W. Madison St., Chicago, Ill. 60606, Cable SIMELCO
 IN CANADA: Bach-Simpson, Ltd., London, Ontario
 IN INDIA: Ruttonsha-Simpson Private, Ltd., International House,
 Bombay-Agra Road, Vikhroli, Bombay

Digital clocks sell for \$180

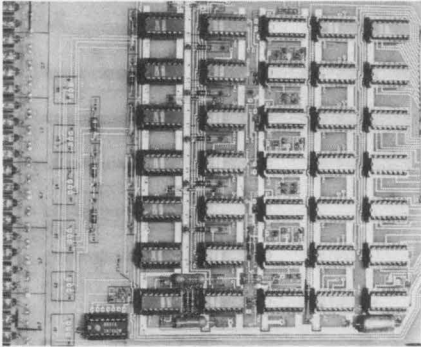

Chrono-Log Corp., 2853 W. Chester Pike, Broomall, Pa. Phone: (215) 356-6771. Price: \$180.

Series 50,000 integrated-circuit digital clocks are now available as plug-in PC cards at a cost of \$180 in quantities of 500 or more. The basic clock and calendar circuits operate from 5 V dc and use a combination of TTL ICs, and DTL and TTL circuits. Data outputs are buffered to prevent external transients from affecting clock timing accuracy.

CIRCLE NO. 263

Electrometer op amps use varactor inputs

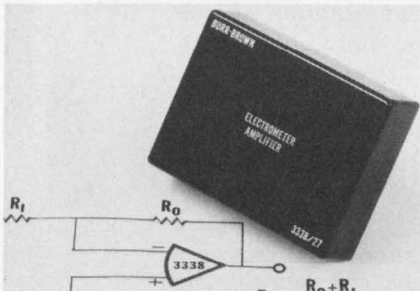

Burr-Brown Research Corp., International Airport Industrial Park, Tucson, Ariz. Phone: (602) 294-1431. P&A: \$65 or \$95; stock to 4 wks.

Available in both inverting and non-inverting versions, a new line of electrometer op amps have an input stage that consists of a varactor-diode modulator and detection network, for resolutions down into the femtoampere range. The inverting models are the 3336/27 and the 3337/27; the non-inverting models are the 3338/27 and the 3339/27.

CIRCLE NO. 264

Programmable amplifier spans 0.1 nA to 10 μA



Keithley Instruments, Inc., 28775 Aurora Rd., Cleveland, Ohio. Phone: (216) 248-0400. Price: \$595.

The Model 18000 is a high-speed, programmable linear current amplifier with a range of 0.1 nA to 10 μA. It features a 500-μs response at 10 nA and stability of 0.5% per week. Range selection may be remotely programmed using a three-line binary input. Compact size and construction make it suitable for critical measurements.

CIRCLE NO. 265

Five-watt supply powers 50 op amps



Datel Systems Corp., 943 Turnpike St., Canton, Mass. Phone: (617) 828-1890. P&A: \$79; stock.

Directly operating from a 115-V ac power line, a new dc power supply provides a dual output of ±15 V at 150 mA—enough to drive up to 50 operational amplifiers. Model BPM-15/150 is a 5-W device whose output regulation is ±0.05% for load changes of no load to full load. Voltage regulation for line changes at a constant load is also ±0.05%.

CIRCLE NO. 266

Multi-diode switch attenuates 92 dB

Vanguard Electronics, a Wyle Co., 930 W. Hyde Park, Inglewood, Calif. Phone: (213) 678-7161. Price: from \$10.

The model VE16319A diode switch can switch zero dBm at nanosecond speeds with a minimum attenuation of 92 dB. This 50-Ω device maintains a measured balance of ±5 mV dc between its diodes. It is available in two, four, six and eight-diode configurations. Operating temperature range is -55 to +71°C.

CIRCLE NO. 267

Vhf agc module regulates to ±1 dB

Finney Co., 34 West Interstate, Bedford, Ohio. Phone: (216) 232-6161.

Solving the problem of amplifier input signal variation is a new vhf automatic-gain-control module. Model M-99 can effectively regulate a ±10-dB variation in input signal so that the output signal change will be only ±1 dB. It adds agc to any vhf strip amplifier that is capable of 30 dB or more gain and which delivers an output of 0.5 to 2 V. Variations of ±15 dB can be regulated to ±2 dB.

CIRCLE NO. 268

Quad power driver gives 50 V at 200 mA

Micro Networks Corp., 5 Barbara Lane, Worcester, Mass. Phone: (617) 756-4635. P&A: \$13.50; stock.

Consisting of a TTL monolithic gate and four transistor output stages, a quad two-input non-inverting power driver has an output voltage rating of 50 V and output current of 200 mA per output stage. Model MN304 provides internal voltage limiting to reduce microcircuit power consumption. Its operating temperature range is from 0 to 70°C. The unit is housed in a dual-in-line package.

CIRCLE NO. 269

Trading off performance
for cost in conversion equipment?

Stop!

**Raytheon Computer
just cut prices
33%**

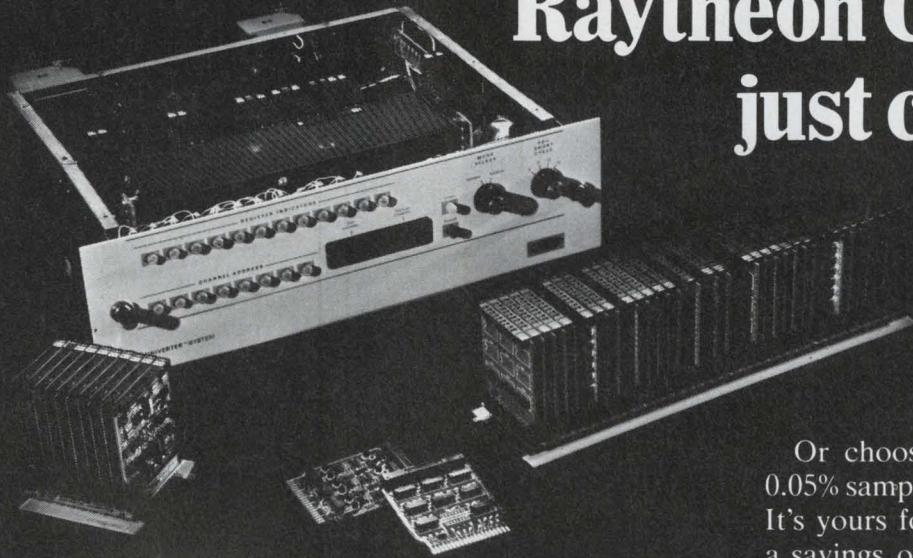

Now you don't have to make any cost/performance trade-offs in A-to-D and D-to-A conversion or interface equipment. We've taken the best price/performance ratio in the industry and made it even better. With price reductions from 15% to 50%.

So now you can pick from the industry's broadest line of conversion equipment. With ADC's. DAC's. Multiplexers. Sample-and-holds. All at new low prices. All available now. Off-the-shelf.

Take our 12-bit, multiplexed ADC. Case-mounted with 32 channels, this unit was a good buy for \$3,640. The new price is only \$2,300. Want more capacity? It's available with up to 256 channels. With savings to match.

Or choose our high performance 0.05% sample-and-hold amplifier card. It's yours for only \$125. And That's a savings of more than 33%.

And we'll throw in wiring lists, test results, and technical manuals. Free. We'll deliver your conversion equipment and documentation cheaper and faster than you could do it yourself.

And, if your systems need computer power, try one of ours. Choose from a family of 16-bit machines. With cycle times from 900ns to 1.75 μ s, including our new 1.0 μ s 704 mini for under \$10,000. All are software compatible with over 400 proven off-the-shelf programs.

Get the best price/performance bargain in the industry for your system, today. Call or write and ask for Data File E-188.

Raytheon Computer, 2700
S. Fairview Street, Santa Ana,
California 92704. Phone
(714) 546-7160.

RAYTHEON

The only thing Raytheon Computer does is your job. Cheaper.

from **OEI** the
**only COMPLETE LINE of
 CURRENT BOOSTERS**

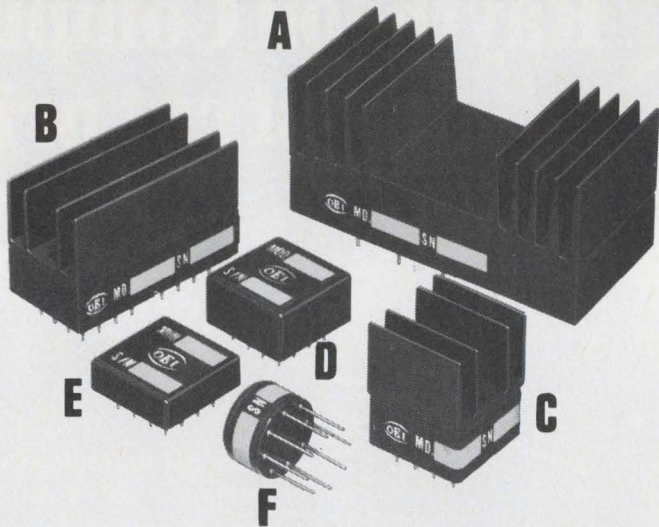

	OUTPUT CURRENT	SLEWING RATE	MODEL	PRICE	
				1-2	100-299
A—	10 AMPS	30V/ μ Sec	9691	\$135.	\$90.
B—	3 AMPS	100V/ μ Sec	*9690	93.	63.
C—	1 AMP	300V/ μ Sec	*9689	71.	48.
D—	0.5 AMP	600V/ μ Sec	*9682	62.	42.
D—	0.2 AMP	1800V/ μ Sec	9162A	50.	34.
E—	0.1 AMP	900V/ μ Sec	*9110B	41.	27.
F—	0.1 AMP	2000V/ μ Sec	*9510	56.	38.

* May be used also as a distortion-free unity gain buffer amplifier/follower/cable driver without an operational amplifier.

**LITERALLY ANY OPERATIONAL AMPLIFIER IS
 COMPATIBLE WITH OEI CURRENT BOOSTERS
 . . . EVEN YOUR 741!**



OPTICAL ELECTRONICS INC.

P. O. BOX 11140

TUCSON, ARIZONA 85706

Phone 602/624-8358

MODULES & SUBASSEMBLIES

**Video sequencer
 multiplies displays**

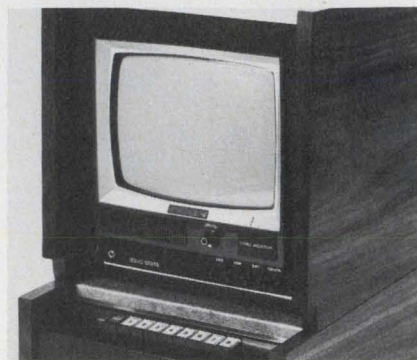

Scientific-Atlanta, Inc., P.O. Box 13654, Atlanta, Ga. Phone: (404) 938-2930.

A new solid-state automatic video sequencer can display multiple video inputs to a single closed-circuit TV monitor. The unit features selectable sequencing speeds and gated logic switching. Individual video amplifiers are provided for each input channel. Both rack-mounted and desktop models are available. A single plug-in card allows the system to be expanded.

CIRCLE NO. 270

**Graphical display
 monitors waveforms**

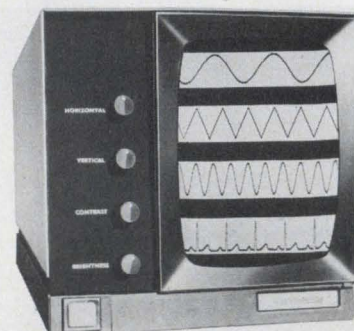

Canadian Westinghouse Co., Ltd., Box 510, Hamilton, Ontario, Canada. Phone: (416) 528-8811.

A new display converts input data for readout in waveform on a standard television monitor in a manner similar to a pen recorder. Up to eight graphical records on a moving time base can be presented simultaneously. Each trace's time base is independent so that the screen can simultaneously cover: seconds for one trace; minutes for another; and so on up to several days for the last trace.

CIRCLE NO. 271

Beam-lead-chip TTL ICs are packaged units too

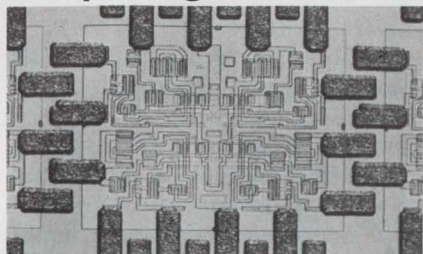

Motorola Semiconductor Products Inc., P.O. Box 20912, Phoenix, Ariz. Phone: (602) 273-6900. P&A: \$2.70 to \$7.90 (100-piece lots); stock.

Complementing the popular 5400 series of logic elements, eight new beam-lead TTL circuits are available as off-the-shelf items in both chip and packaged forms.

These include the 5400 and 5401 quad dual input NAND gates with open collectors, the 5402 quad dual-input NOR gate, the 5440 dual 4-input NAND buffer and the 5443 expandable dual-input AND-OR-INVERT gate.

They also include the 5454 4-wide dual-input AND-OR-INVERT gate, the 5460 dual 4-input expander and the 5472 J-K flip-flop.

They employ a silicon nitride dielectric that hermetically seals the chip. The beam leads are gold cantilevered structures extending from the chip, and are readily bondable to gold-metalized substrates.

Metalization consists of platinum silicide ohmic contacts that are topped by layers of titanium and platinum. These are followed by two layers of gold.

The first gold layer provides the chip intraconnection. The second layer, which is thicker, forms the cantilevered beams.

Packaged circuits are available in 1/4-in. square ceramic flat packs. Both chips and packaged units comply with the electrical specifications of series 5400 units and can be used interchangeably with them.

Typical characteristics include 13-ns propagation delay for all units, power dissipation of 10 mW per gate for each NAND gate and power dissipation of 40 mW for the flip-flop circuit which has a toggle frequency of 15 MHz.

CIRCLE NO. 272

When the chips are down

REDCOR has delivered, or has on order, more computer-controlled MOS test systems than all other manufacturers combined. In fact, nearly 80% of all MOS LSI/MSI devices produced in the upcoming years will be REDCOR-tested. Surprising, perhaps, but true. Why this vote of confidence from so many industrial giants? One reason is that we design and build, using state-of-the-art techniques, all the system components, including the computers. And we provide the systems engineering, the software, and the field service . . . a "one source, one responsibility" commitment. MOS testing may not be your application, but whatever your systems requirement, let a REDCOR Systems Pro solve it for you.

R REDCOR CORPORATION
C Telephone: (213) 348-5892

MOS shift registers can recirculate data

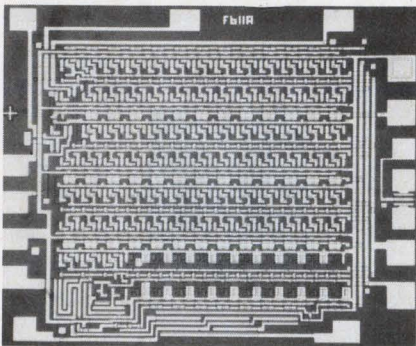

Plessey Co. Ltd., Microelectronics Div., London, England.

Two new MOS static shift registers incorporate data stream select logic on the input to the register, thus facilitating the recirculation of data. Model MP220B can be programmed on a package pin to be either 56 or 80 bits long; the MP-225B is a 100-bit register. Both devices operate from dc to 1 MHz over the temperature range of -20 to $+70^{\circ}\text{C}$. They can be easily interfaced with TTL circuits.

CIRCLE NO. 273

Dual 4-input NAND gate has 2 Schmitt triggers

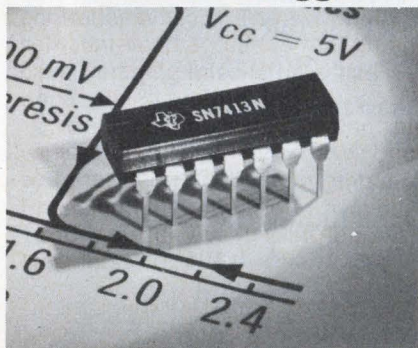

Texas Instruments Inc., Components Group, P.O. Box 5012, Dallas, Tex. Phone: (214) 238-2011. P&A: \$1.65; stock.

Comprised of two identical Schmitt-trigger circuits, a new TTL dual four-input positive NAND gate exhibits different input threshold levels for positive and negative-going signals. The hysteresis or backlash—the difference between the two threshold levels—is typically 800 mV. Type SN54/7413 features built-in temperature compensation.

CIRCLE NO. 274

Compensated op amps roll-off 6 dB/octave

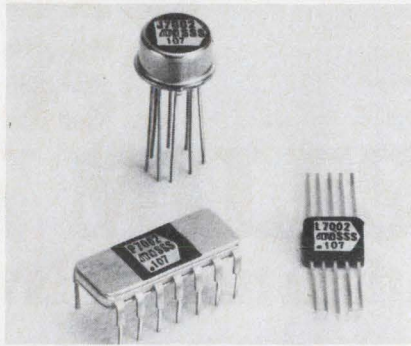

Precision Monolithics Inc., 1500 Space Park Drive, Santa Clara, Calif. Phone: (408) 246-9222. P&A: \$13 or \$33; stock.

Two new operational amplifiers, models SSS 107 and SSS 207, feature internal frequency compensation, a 6-dB/octave roll-off, and short-circuit protection to ground and power supplies. Maximum input offset voltage is 1.8 or 2 mV, maximum input offset current is 5 or 10 nA, and maximum input bias current is 50 or 75 nA.

CIRCLE NO. 275

Hybrid clock drivers can vary pulse width

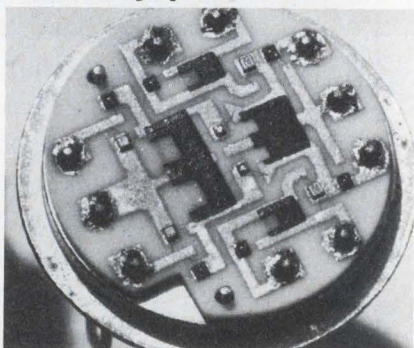

General Instrument Corp., 600 W. John St., Hicksville, N.Y. Phone: (516) 733-3000. Price: \$18 or \$27.

Designed to operate in conjunction with standard TTL/DTL line drivers, four new hybrid dual-phase clock drivers provide fixed-width clock pulses for multiple MTOS (metal thick oxide silicon) shift registers. The NC0009/NC0009C and DIP0009/DIP0009C drivers have two external capacitors to set pulse width, which is externally adjustable. Military and commercial versions are available.

CIRCLE NO. 276

Commercial amplifier compensates on chip

Amelco Semiconductor, 1300 Terra Bella Ave., Mountain View, Calif. Phone: (415) 968-9241. P&A: \$1.95; stock.

Incorporating an MOS capacitor on its substrate to eliminate the need for external compensation, a new monolithic operational amplifier is a limited-temperature device for commercial applications. Model 741D includes input and output overvoltage and short-circuit protection. Its offset voltage is typically 5 mV, while typical offset current is 200 nA.

CIRCLE NO. 277

Plastic pnp switches compress storage time

Fairchild Semiconductor, 313 Fairchild Dr., Mountain View, Calif. Phone: (415) 962-3563. P&A: 50¢ or 60¢; stock.

Three new pnp plastic transistors can be used as high-speed logic switches because of their short storage time constants—12 ns for the 2N4257A, 15 ns for the 2N4258A and 20 ns for the 2N5910. The devices also offer a wide selection of supply voltage. The 2N-4257A operates with 6 V at 3 mA, the 2N4258A operates from 12 V, and the 2N5910 from 20 V.

CIRCLE NO. 278

Dual MOS transistor is complementary

Hughes Aircraft Co., MOS Div., 500 Superior Ave., Newport Beach, Calif. Phone: (714) 548-0671. Price: \$20.

Designed for circuit breadboarding and evaluation, a new complementary dual transistor-plus-inverter provides complementary n- and p-channel MOSFETS that can be externally interconnected to produce large systems requiring very little dc power. Systems breadboarded with this device are capable of operating at frequencies in excess of 5 MHz. Model LCOS4007 operates at signal supply voltages of 5 to 12 V.

CIRCLE NO. 279

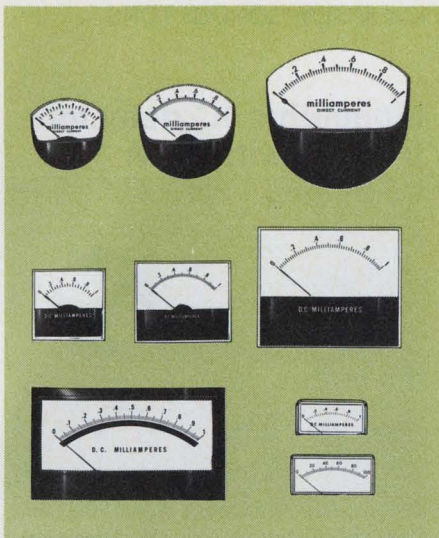

Honeywell's versatile line of precision meters.

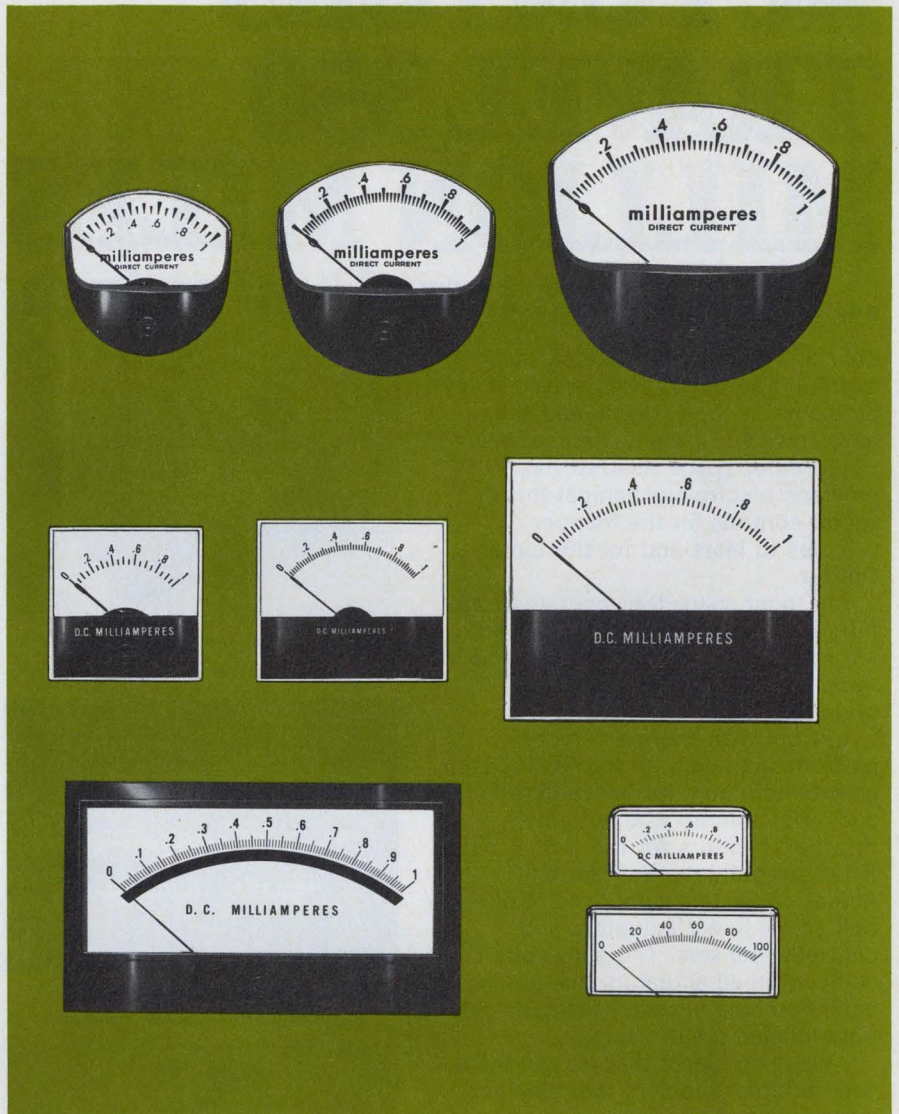

Now that versatile line of precision meters is **Jewell**

Same plant. Same people. Same meters that were made popular by superior styling, design and quality. Only now they're Jewell. Everything else is the same—including the compact, frictionless movements and self-shielded, low-cost construction. So, when you need a meter for your application, the best place to find it is still Manchester, N.H. *Write for our spanking new catalog . . . or get in touch with our nearest sales representative, distributor or mod-center.*

Jewell JEWELL ELECTRICAL INSTRUMENTS, INC.
 Grenier Field, Manchester, N. H. 03105 • 603/669-6400



INFORMATION RETRIEVAL NUMBER 86

SOME OF OUR ACTUATORS TRAVEL 350 MILLION MILES ...and others travel $\frac{3}{10}$ of an inch.

Kearfott's electro-mechanical and hydraulic actuators have solved many problems in their travels and they have traveled in many applications.

In outer space Kearfott has provided electro-mechanical thrust vector controls for the Mariner vehicles to Mars and for the Lunar Orbiter.

In inner space they operate at 580 fathoms deep aboard the DSRV and are found on SUBROC missiles and in hydrofoil steering and control systems.

In between there are radar platform actuators for the RF-4C. Trim control actuators for helicopters and VTOL aircraft and autopilot/throttle actuators for the C-5. For the F-111 we build the Ram Air Exit Actuation System comprised of our ball screw linear actuators and controller-sensors. The six wholly self-contained actuators that go on each Pershing missile have had unparalleled performance.

We're confident that we can solve your actuator problem too. Why not write for details? Singer - General Precision, Inc., Kearfott Division, 1150 McBride Avenue, Little Falls, New Jersey 07424.

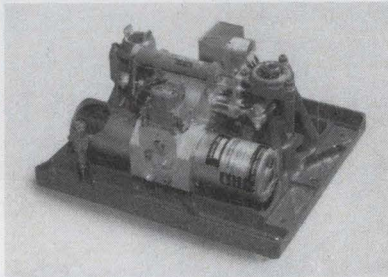

Self-contained hydraulic system for Pershing.

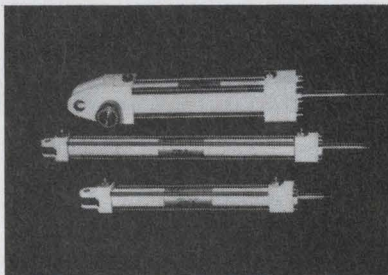

Linear actuators for deep submergence rescue vehicle.

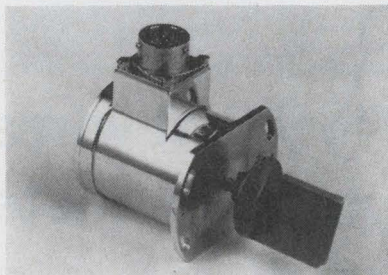

Jet vane actuators for Mariner series.

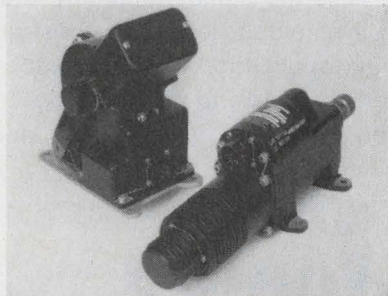

Autopilot/throttle electro-mechanical actuators for C-5A.

ICs & SEMICONDUCTORS

Monolithic IC detector triggers with 1 nA

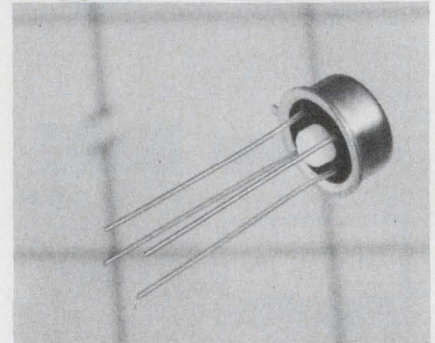

General Electric Co., N. Syracuse, N. Y. Phone: (315) 456-2396. P&A: \$7.50 (100 to 999); stock.

Intended for applications requiring the logic function of a Schmitt trigger but offering superior voltage and temperature stability, the PA494 IC detector features an input sensitivity of 1 nA. Operating voltage is 2.3 to 9 V, and maximum current drive is 250 mA. The trigger threshold is 60% of the supply voltage and hysteresis is 10%. Threshold stability varies less than 1%.

CIRCLE NO. 280

Economy plastic SCRs handle 400 V at 4 A

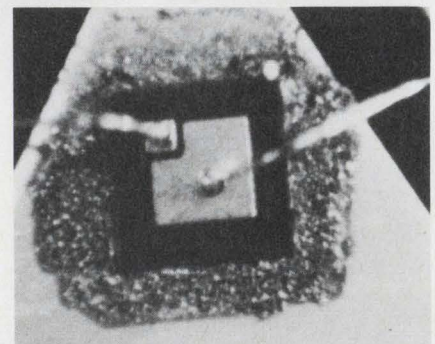

Transistron Electronic Corp., 168 Albion St., Wakefield, Mass. Phone: (617) 245-4500. Price: 55¢ to \$1.20.

Series TC106 low-cost plastic medium-power SCRs are sensitive-gate (200 μ A) planar passivated devices rated as high as 400 V and 4 A rms at 75°C case temperature. The units are packaged in the popular tab-mounted configuration. Expected applications range from speed and temperature controls to power logic designs.

CIRCLE NO. 281

SINGER
KEARFOTT DIVISION

INFORMATION RETRIEVAL NUMBER 87

Four-bit adder trims ripple time

National Semiconductor Corp., 2900 Semiconductor Dr., Santa Clara, Calif. Phone: (408) 732-5000. P&A: \$11.82 or \$26.64; stock.

When interconnected (four packages) to add a 16-bit word, a new four-bit binary full adder holds ripple time to 12 ns, from carry-input to carry-output. Model DM-7283/8283 achieves this performance because of its internal carry look-ahead circuitry. The unit can add two four-bit numbers, accepting a carry at the input and propagating it to the output. It is available in either a military or industrial version.

CIRCLE NO. 282

Glass zener diodes handle up to 1 W

Unitrode Corp., 580 Pleasant St., Watertown, Mass. Phone: (617) 926-0404. P&A: from 95¢; stock.

Industrial fused-in-glass 1-W zener diodes are now available to replace the popular DO-13 metal-can types 1N3016 to 1N3051. This new series offers voltage ratings from 6.8 to 200 V. The devices have the same electrical specifications as the 1N3016 and 1N3051 family, but are only one-quarter the size.

CIRCLE NO. 283

Coupled-pair photo-SCR uses LED light source

Monsanto Electronic Special Products, 10131 Bubb Rd., Cupertino, Calif. Phone: (408) 257-2140. P&A: \$18.75; stock.

A new photo-coupled pair, designated as the MCS1 opto-isolator, utilizes a photo-sensitive SCR as the detector and a gallium-arsenide solid-state lamp as the light source. Because of its bistable characteristic, the unit can be used as a latching relay in dc circuits. Furthermore, its current carrying capabilities allow the device to directly activate solenoids, motors, lamps and other 120-V ac loads.

CIRCLE NO. 284

NEW from BULOVA ... DC Servo Amps 2.5w to 2,500w

Here's a line of servo amps packaged for flexibility and priced for system saving. It's another example of Bulova's unique capability in producing quality servo products at a price lower than you can make or buy.



Available from 2.5 w to 2.5 Kw
— Styled in flat pack, modular or rack mount — to meet industrial or mil-spec — able to operate from AC or DC — to include power supply when required.

- FEATURES:**
- Adjustable Gain
 - Current Limiting
 - Voltage or Current Feedback
 - Wide Bandwidth
 - Low Cost

- DESIGNED TO DRIVE:**
- DC Torque Motors
 - Low Inertia Motors
 - DC Servo Motors
 - Servo Valves
 - Deflection Coils

Bulova also offers a complete line of AC servo products, including servo amplifiers, modulators and demodulators, plus a line of power supplies.

Don't miss out on this Bulova Servo Special. For new applications or old . . . for help in planning new servo systems . . . for the lowest price on DC Servo Amps . . . Look to Bulova!

Call (212) 335-6000, or write —



BULOVA SERVO PRODUCTS

Electronic Division of Bulova Watch Company, Inc.
61-20 Woodside Ave., Woodside, N. Y. 11377 (212) 335-6000

Go Bulova, and leave the designing to us!

INFORMATION RETRIEVAL NUMBER 88

IR emitting diode challenges bulbs



RCA/Electronic Components, Solid State Div., 415 S. Fifth St., Harrison, N. J. Phone: (201) 485-3900. P&A: \$4.50; stock.

Intended to replace tungsten bulbs in computer readout devices, a new gallium-arsenide infrared light-emitting diode features a minimum power output of 1 mW at 50 mA. Type 40736R radiates in the near infrared-region (9300 Å). It is a single-lead device that is compatible with most photo-transistors now available.

CIRCLE NO. 285

Power transistors take 120 V at 4 A

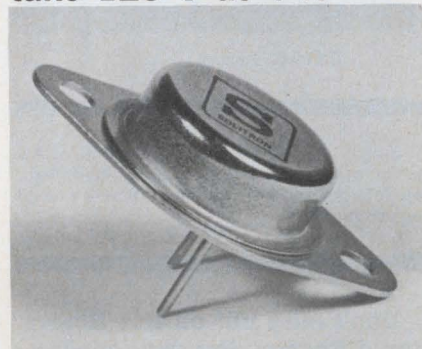

Solitron Devices, Inc., Semiconductor Div., 1177 Blue Heron Blvd., Riviera Beach, Fla. Phone: (305) 848-4311. Availability: stock.

A new line of type 2N3055 commercial single-diffused power transistors offer voltage ratings from 20 to 120 V, gains of 10 to 70, and currents of 3 or 4 A. The units are packaged in tin-plated TO-3 cases for easy wave-solder assembly. Typical applications include high-energy switching and power circuits.

CIRCLE NO. 286

Get your free C103 SCR from your authorized GE semiconductor distributor

- | | | |
|--|---|---|
| <p>Birmingham
Forbes Distributing Co. (205) 251-4104</p> <p>Huntsville
Electronic Wholesalers, Inc. (205) 534-2461</p> <p>Phoenix
Hamilton Electro of Arizona (602) 272-2601
Kieruff Electronics, Inc. (602) 273-7331</p> <p>Los Angeles
Kieruff Electronics, Inc. (213) OV 5-5511</p> <p>Mountain View
Elmar Electronics (415) 961-3611
Hamilton Electro Sales (415) 961-7000</p> <p>Oakland
Brill Electronics (415) TE 4-5888</p> <p>Palo Alto
Kieruff Electronics, Inc. (415) 968-6292</p> <p>Riverside
Electronic Supply (213) 683-8110</p> <p>San Diego
Hamilton Electro Sales (714) 279-2421
Kieruff Electronics, Inc. (714) 278-2112
G. S. Marshall Company (714) 278-6350
Western Radio & TV Supply (714) BE 9-0361</p> <p>Denver
Electronic Parts Co. (303) 266-3755
Hamilton Electro Sales (303) 443-8551
L. B. Walker Radio Co. (303) WE 5-2401</p> <p>North Haven
Cramer Electronics, Inc. (203) 239-5641</p> <p>Norwalk
Arrow Electronics (203) 838-4851</p> <p>Waterbury
Bond Radio Electronics, Inc. (203) 753-1184</p> <p>Wilmington
Almo Industrial Electronics (302) OL 6-9467</p> <p>Ft. Lauderdale
Cramer Florida Electronics (305) 566-7511</p> <p>Hollywood
Schweber Electronics (305) 927-0511</p> <p>Miami
Electronic Wholesalers, Inc. (305) 696-1620</p> <p>Orlando
Electronic Wholesalers, Inc. (305) 841-1550
Hammond Electronics (305) 241-6601</p> <p>Atlanta
Jackson Electronics Co. (404) 355-2223</p> <p>Addison
Hamilton Electro Sales (312) 543-8500</p> <p>Chicago
Electronic Distributors, Inc. (312) AV 3-4800
Newark Electronics Corp. (312) 638-4411
Semiconductor Specialists, Inc. (312) 279-1000</p> <p>Evansville
Ohio Valley Sound (812) HA 5-6173</p> <p>Indianapolis
Graham Electronics, Inc. (317) ME 4-8486
Semiconductor Specialists Inc. (317) 243-8271</p> <p>Cedar Rapids
Deeco, Inc. (319) EM 5-7551</p> <p>Wichita
Interstate Electronics Supply Corp. (316) AM 4-6318</p> <p>Louisville
P. I. Burks Co. (502) 583-2871</p> <p>Lafayette
Ralph's of Lafayette (318) 234-4507</p> <p>New Orleans
EPCOR (504) 486-7441
Sterling Electronics, Inc. (504) JA 2-8726</p> | <p>ALABAMA</p> <p>ARIZONA</p> <p>ARKANSAS</p> <p>CALIFORNIA</p> <p>CONNECTICUT</p> <p>DELAWARE</p> <p>FLORIDA</p> <p>GEORGIA</p> <p>ILLINOIS</p> <p>INDIANA</p> <p>IOWA</p> <p>KANSAS</p> <p>KENTUCKY</p> <p>LOUISIANA</p> <p>MAINE</p> <p>MARYLAND</p> <p>MASSACHUSETTS</p> <p>MICHIGAN</p> <p>MINNESOTA</p> <p>MISSISSIPPI</p> <p>MISSOURI</p> <p>NEBRASKA</p> <p>NEW JERSEY</p> <p>NEW MEXICO</p> <p>NEW YORK</p> <p>NORTH CAROLINA</p> <p>OHIO</p> <p>OKLAHOMA</p> <p>OREGON</p> <p>PENNSYLVANIA</p> <p>RHODE ISLAND</p> <p>SOUTH CAROLINA</p> <p>TENNESSEE</p> <p>TEXAS</p> <p>UTAH</p> <p>VIRGINIA</p> <p>WASHINGTON</p> <p>WEST VIRGINIA</p> <p>WISCONSIN</p> | <p>Baltimore
Kann-Eliert Electronics, Inc. (301) TU 9-4242</p> <p>Hanover
Hamilton Electro Sales (301) 796-5000</p> <p>Rockville
Cramer/Washington, Inc. (301) 424-2700
Schweber Electronics (301) 427-4977</p> <p>Salisbury
Almo Industrial Electronics (301) PI 2-1393</p> <p>Dedham
Gerber Electronics (617) 329-2400</p> <p>Newton Centre
Cramer Electronics, Inc. (617) WO 9-7700</p> <p>Springfield
T. F. Cushing, Inc. (413) 788-7341</p> <p>Waltham
Schweber Electronics (617) 891-8484</p> <p>Detroit
Radio Specialties Co. (313) 491-1012</p> <p>Grand Rapids
Newark-Industrial Electronics (616) 452-1411</p> <p>Redford
Semiconductor Specialists, Inc. (313) 255-0300</p> <p>Edina
Lew Bonn Company (612) 941-2770</p> <p>Minneapolis
Semiconductor Specialists, Inc. (612) 866-3434</p> <p>St. Paul
Gopher Electronics Co. (612) 645-0241</p> <p>Jackson
Ellington Radio, Inc. (601) FL 3-7877</p> <p>Kansas City
Radio Lab, Inc. (816) HA 1-0171</p> <p>North Kansas City
ECI Semiconductor Inc. (816) HA 1-8400</p> <p>University City
Olive Industrial Electronics (314) VO 3-4051</p> <p>Lincoln
Scott Electronic Supply Corp. (402) 434-8308</p> <p>Omaha
Radio Equipment Co. (402) 341-7700</p> <p>Camden
General Radio Supply Co., Inc. (609) 954-8560</p> <p>Cedar Grove
Hamilton Electro Sales (201) 239-0800</p> <p>Cherry Hill
Hamilton Electro Sales (609) 662-9337</p> <p>Mt. Ephraim
Almo Industrial Electronics (609) 933-3800</p> <p>Pennsauken
Cramer/Penn, Inc. (609) 662-5061</p> <p>Totowa
Arrow Electronics, Inc. (201) 256-7331</p> <p>Albuquerque
Kieruff Electronics, Inc. (505) 268-3901
Sterling Electronics, Inc. (505) 247-2486</p> <p>Cheektowaga
Standard Electronics, Inc. (716) 685-4330</p> <p>East Syracuse
Cramer Electronics, Inc. (315) 437-6671</p> <p>Endicott
Standard Electronics, Inc. (607) 754-3102</p> <p>Farmingdale, L. I.
Arrow Electronics, Inc. (516) MY 4-6800</p> <p>Hempstead
Cramer Electronics (516) 231-5600</p> <p>Rochester
Cramer/Rochester, Inc. (716) 275-0300</p> <p>Rochester Radio Supply Co. (716) 454-7800</p> <p>Rome
Rome Electronics, Inc. (315) FF 7-5400</p> <p>Syracuse
Hamilton Electro Sales (315) 437-2641</p> <p>Westbury, L. I.
Schweber Electronics (516) ED 4-7474</p> <p>Yorkville
Valley Industrial Electronics, Inc. (315) RE 6-3393</p> <p>Charlotte
Dixie Radio Supply Co. (704) 377-5413</p> <p>Raleigh
Southeastern Radio Supply Co., Inc. (919) 828-2311</p> <p>Winston-Salem
Electronic Wholesalers, Inc. (919) 725-8711</p> <p>Akron
Sun Radio Co., Inc. (216) 434-2171</p> <p>Cincinnati
Hughes-Peters, Inc. (513) 351-2000</p> <p>Cleveland
Pioneer-Standard Electronics, Inc. (216) 432-0010</p> <p>Columbus
Electronics Marketing Corp. (614) 299-4161
Hughes-Peters, Inc. (614) AX 4-5351</p> <p>Dayton
Srecco Electronics, Inc. (513) BA 4-3871</p> <p>Toledo
Warren Radio Co. (419) CH 8-3364</p> <p>Philadelphia
Almo Electronics Corp. (215) OR 6-6000</p> <p>Pittsburgh
R.P.C. Electronics (412) 782-3770
Semiconductor Specialists, Inc. (412) 781-8120</p> <p>York
Rosen Electronics Co. (717) 843-3875</p> <p>Providence
W. H. Edwards Co. (401) 781-8000</p> <p>Columbia
Dixie Radio Supply Co., Inc. (803) 253-5333</p> <p>Chattanooga
Harpe Electronic Distributors, Inc. (615) 267-2381</p> <p>Kingsport
Radio Electric Supply Co. (615) 247-8111</p> <p>Memphis
Bluff City Distributing Co. (901) 276-4501</p> <p>Nashville
Electra Distributing Co. (615) AL 5-8444</p> <p>Arlington
Arco Electronics (817) CR 7-2231</p> <p>Dallas
Hamilton Electro Sales (214) ME 8-0900
Sterling Electronics (214) 357-9131
Wholesale Electronic Supply (214) TA 4-3001</p> <p>El Paso
McNico, Inc. (915) LO 6-2936
Midland Specialty Co. (915) 533-9555</p> <p>Houston
Hamilton Electro of Houston (713) 526-4661
Sterling Electronics (713) 623-6600</p> <p>Salt Lake City
Kimball Electronics (801) 328-2075</p> <p>Charlottesville
Virginia Radio Supply Co. (703) 296-4184</p> <p>Richmond
Meridian Electronics, Inc. (703) 353-6648</p> <p>Roanoke
Peoples Radio & TV Supply Co. (703) 342-8933</p> <p>Seattle
Almac/Strum Electronics (206) 763-2300
Hamilton Electro Sales (206) MA 4-5930
Kieruff Electronics, Inc. (206) RO 3-1550
Washington Electronics, Inc. (206) MU 2-8981</p> <p>Tacoma
C&G Electronics Co. (206) BR 2-3185</p> <p>Charleston
Chemcity Electronics (304) 342-8151</p> <p>Milwaukee
Electronic Expeditors, Inc. (414) 374-6666</p> <p>West Allis
Marsh Radio Supply Co. (414) 545-6500</p> |
|--|---|---|

GENERAL  ELECTRIC

221-25

GENERAL ELECTRIC wants to GIVE you an SCR

BECAUSE WE KNOW YOU'LL BE BACK FOR MORE

We're so confident that our C103 will meet your low current SCR needs that we'd like to give you one so you can try it in your circuit. Just fill out the coupon below and we'll send you, free, a new 800 ma SCR.

This new C103 features the same pellet structure as the performance-proven C106 (4-amp SCR).

Epoxy-encapsulated in the TO-18 plastic package, GE's C103 is available in peak reverse voltage ratings from 30 to 200 volts.

The C103 combines high surge capability (8 amps) with a low forward blocking current ($1\mu\text{A}$) and offers a very sensitive gate ($200\mu\text{A}$).

The C103 low-cost low current SCR is so versatile that it can replace more than 200 existing SCR's and is easily interchangeable in both package and electrical characteristics.

And because it's rugged, it's ideal for use in industrial and military as well as consumer applications such as motor controls, indicator drivers, off-the-line regulators for appliance and electronic equipment, light, heat and proximity detection, temperature and pressure control, counting or switching and as gate amplifiers for larger devices. GE's C103 is now available from distributors' stock or in volume from the factory.

To get your sample C103 SCR, fill out the coupon below and present it (or mail it) to your authorized General Electric distributor.

For more information, write General Electric Company, Section 220-89, 1 River Road, Schenectady, N. Y. 12305. In Canada: Canadian General Electric, 189 Dufferin Street, Toronto, Ont. Export: Electronic Sales, IGE Export Division, 159 Madison Avenue, New York, N. Y. 10016.

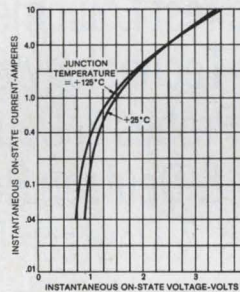

C103 RATINGS

Peak reverse voltage	200 volts max.
RMS On-state current	0.80 amp. max.
Gate trigger current	200 μ amp. max.
Peak surge current	8.0 amps. max.
Peak reverse and off-state current	1.0 μ amp. max.



GENERAL  ELECTRIC

FREE SCR SAMPLE

Present (or mail) this coupon to your authorized GE distributor (see listing on opposite page).

Attn: Industrial Sales Mgr. Please furnish 1 C103 SCR.

Rating: 30V 60V 100V 200V

Name _____

Firm: _____ Position: _____

Street _____

City _____ State _____ Zip _____

Distributor Name _____

Offer expires July 31, 1970

Stepping switch slims down size

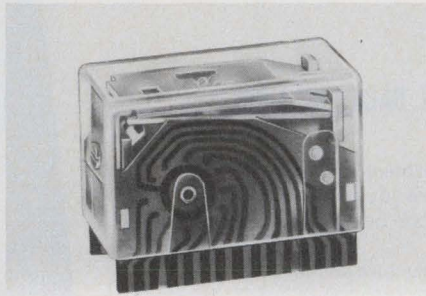

Schrack Electrical Sales Corp.,
1140 Broadway, New York, N.Y.
Phone: (212) 683-0790.

A new miniature stepping switch, model RTM, is claimed to be only one-quarter the size of comparable units. Dimensions for the device are 1-41/64-in. long by 13/16-in. wide by 15/16-in. high. A unique hold-down spring enables mounting the switch in any position. All contacts are gold plated.

CIRCLE NO. 293

Packaged capacitors are for PC boards

American Components Inc., Eighth Ave. at Harry St., Conshohocken, Pa. Phone: (215) 828-6240. P&A: 25¢ to \$1.63; stock to 4 wks.

Ideal for printed-circuit-board applications, type PC molded radial-lead ceramic capacitors are now available in three sizes and three dielectric materials. The smallest units, style PC-1, measure only 0.1 by 0.06 by 0.175 in. and range in capacitance from 5 to 12,000 pF at 50 V dc. Style PC-2 measures 0.14 by 0.07 by 0.218 and covers 5 to 30,000 pF; style PC-3 measures 0.2 by 0.14 by 0.468 and provides 5 to 510,000 pF.

CIRCLE NO. 294

Variable inductor changes electrically

Ceramic Magnetics, Inc., 87 Fairchild Rd., Fairfield, N.J. Phone: (201) 227-4222.

Model MN31 electrically controlled variable inductor can alter its inductance from 0.17 mH to 0.65 H over four different ranges; minimum Q changes from 35 to 200. The device, which is designed primarily for audio applications, requires a control current of 0 to 30 mA. At 20 kHz, full-drive loss is 150 mW.

CIRCLE NO. 295

Pushbutton caps take custom legends

Dialight Corp., 60 Stewart Ave., Brooklyn, N.Y. Phone: (212) 497-7600.

Permitting the user to insert any legend he wishes, a new series of pushbutton caps has a removable snap-off frame allowing legends to be inserted or replaced on momentary or alternate-action switches, without the use of tools. Series 534 units accept any transparent or translucent material, such as paper, parchment, polyester or film. The rectangular caps are 3/4 by 1 in.

CIRCLE NO. 296

Apollo & Deutsch Relay

Automatic Test Equipment & Deutsch Relay

Computer Technology & Deutsch Relay

Deep Sea Probes & Deutsch Relay

Education & Deutsch Relay

Jumbo Jets & Deutsch Relay

Office Equipment & Deutsch Relay

Polaris & Deutsch Relay

Safeguard & Deutsch Relay

Security Systems & Deutsch Relay

Stereo & Deutsch Relay

Traveling in good company

Leading tomorrow's technology today. Deutsch accepts the challenge of the future by continually developing its corporate capability... a vertically-integrated, responsive, quality-oriented organization. And its product speaks for itself.

Ask and see.

DEUTSCH

THE
Switching
Company

RELAY DIVISION, 65 Daly Road, East Northport, New York 11731
516-266-1600 TWX 510-226-0233
For Quality Connectors, Fittings & Fasteners, Contact The Deutsch Company,
7001 West Imperial Highway, Los Angeles, California 90045 213-673-5080

INFORMATION RETRIEVAL NUMBER 92

Hybrid tape sensor incorporates LEDs

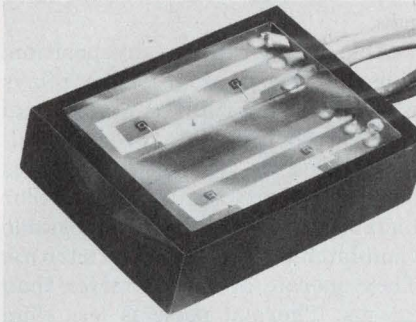

HEI, Inc., Jonathan Industrial Center, Chaska, Minn. Phone: (612) 445-3510. Price: \$18.

Replacing bulky assemblies of photosensors and light bulbs, a miniature end-of-tape/beginning-of-tape sensor uses gallium-arsenide light-emitting diodes as light sources and photo-Darlington transistors as light sensors. Housed in a novel hybrid thick-film package, model EOT-200 senses reflective strips placed on the magnetic tape for triggering the tape drive to reverse or stop.

CIRCLE NO. 291

TO-can oscillator uses thin films

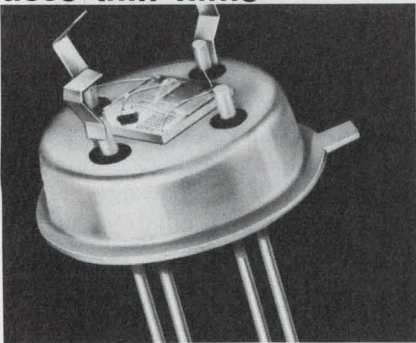

TRW Inc., Semiconductor Div., 14520 Aviation Blvd., Lawndale, Calif. Phone: (213) 679-4561. Price: \$30.

Designed for use as a local oscillator in the second mixer stage of dual conversion receivers, a new crystal-controlled microcircuit oscillator employs same-substrate thin-film capacitors and resistors. Model MCO-F operates over the frequency range of 5 to 25 MHz, with a frequency stability of $\pm 0.003\%$ from -55 to $+125^\circ\text{C}$. It comes in a four-lead TO-5 can.

CIRCLE NO. 292

MOTOR PROBLEMS ED?
WELL YOU'VE COME TO THE
RIGHT PLACE! - McLEAN
IS THE NAME IN
PRECISION INSTRUMENT MOTORS!



FR INSTANCE McLEAN SOLVES
MOTOR PROBLEMS THAT JUST
CAN'T BE SOLVED BY
ORDINARY MOTOR MANUFACTURERS.



FURTHERMORE, McLEAN
MOTORS ARE COMPUTER
DESIGNED AND CARRY A
25,000 HR. GUARANTEE!



ANY QUESTIONS? YUP-WHERE
CAN I GET ONE
OF THOSE SHARP
SCOTCH PLAID JACKETS?



Some people like our jackets, but most everyone likes the Motor and Blower economies they stand for even better. A very calculating computer, with an eye to thrift, matches Precision Instrument Motors to the job . . . mates Motors and Blowers exactly to a cooling problem . . . and precision manufacture, exceeding MIL-SPEC requirements, enables us to make our exceptional guarantee. Write or phone for full information about anything (except our jackets).

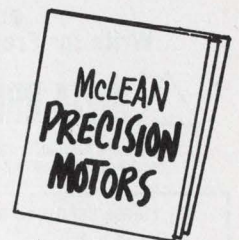

Write
Today-

McLEAN 
ENGINEERING LABORATORIES mclean

Princeton Junction, New Jersey 08550 • Phone: 609-799-0100 • Telex: 84-3422

INFORMATION RETRIEVAL NUMBER 91

Make your home safer and your family more secure with DeltAlert... the new burglar light/alarm

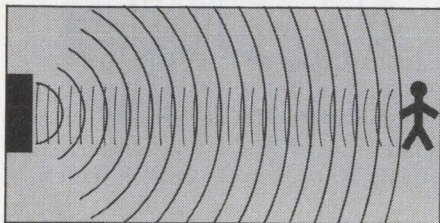

FACT: the rising tide in residential burglary threatens all of us today.

FACT: a home guarded with lights will reduce chance of robbery by 95%.

FACT: the simple-to-operate DeltAlert adds to overall home safety and protection.

Send for free illustrated brochure. See how you can easily protect your home and family economically with the brand new DeltAlert. The system monitors and blankets a 15 to 30 foot area, using sonar principles to "catch" any intruder entering the monitored area by turning on lights, activating alarms, or both. Easy to operate! Simply plug into a wall outlet, and plug lights into the back of the DeltAlert. No rewiring necessary. The unit comes in a handsome walnut finish, designed to complement any decor.



ONLY \$59.95
ppd.

Money Back Guarantee

Let your night watchman be DeltAlert.

Order Today,
or
Write for Free Brochure

DELTA PRODUCTS, INC.

*Effective August 1, 1970, DeltAlert will increase to \$69.95 ppd.

Please send free brochure DP 70-6
Enclosed is \$ _____
 Ship ppd. Ship C.O.D.
Please send _____ DeltAlert(s)
Name _____
Address _____
City/State _____ Zip _____

DELTA PRODUCTS, INC.

P.O. BOX 1147 ED / GRAND JUNCTION, COLO. 81501
(303) 242-9000

INFORMATION RETRIEVAL NUMBER 90

COMPONENTS

DIP Hg-film relays cycle 11×10^9 times

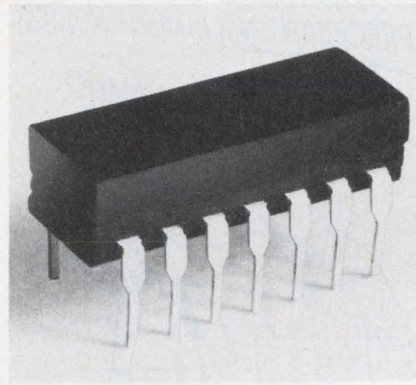

Fifth Dimension Inc., P.O. Box 483, Princeton, N.J. Phone: (609) 924-5990. P&A: \$10; stock to 6 wks.

Able to operate in any position, a new series of dual-in-line relays with mercury-film contacts can successfully complete over 11 billion cycles of life testing. Series 9000 units are available in either bistable (latching) or monostable (non-latching) configurations. They operate at speeds faster than 2.5 ms. Thermal noise is less than $1 \mu V$.

CIRCLE NO. 287

Bright display tubes emit white light

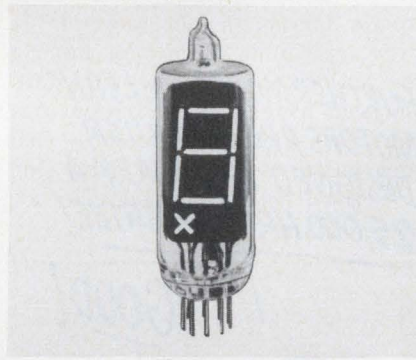

RCA/Electronic Components, 415 S. Fifth St., Harrison, N.J. Phone: (201) 485-3900. P&A: \$1.75 to \$3.30; stock.

Designated as series DR2100, a new line of Numitron digital display tubes emit white light with a brightness level of 7000 foot-lamberts. These displays can be mounted on 0.5-in. centers for a 16-digit capability within an 8-in. space. They present a seven-segment number that is 0.4-in. high and 0.23-in. wide.

CIRCLE NO. 288

Photodiode/amplifier fits in TO-5 package

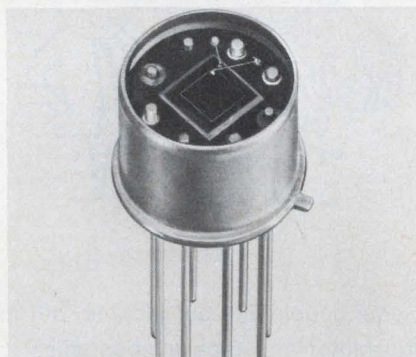

Electro-Nuclear Laboratories, Inc., 115 Independence Dr., Menlo Park, Calif. Phone: (415) 322-8451. P&A: \$200; stock.

A new photodiode/amplifier combines a silicon photodiode with a guard ring and low-noise transresistance (shunt-feedback) amplifier in a single TO-5 package. Model 686 virtually eliminates pick-up noise between the detector and amplifier. In operation, the reverse-biased photodiode acts as a light-controlled current source.

CIRCLE NO. 289

Ultra-small CRT has 3/4-in. face



General Electric Co., Tube Dept., 316 E. Ninth St., Owensboro, Ky. Phone: (502) 683-2401.

Capable of displaying alphanumeric or TV signals, a new 3/4-in. electrostatic deflection CRT is a single-gun tube with a deflection sensitivity of about 230 V/in./kV. The Y4028 has a miniature flat faceplate that is available with any commercial phosphor. Typical anode voltages range from 1000 to 2000 V. Overall length is 3-3/4-in.

CIRCLE NO. 290

ARITECH VOLTAGE CONTROLLED FILTERS

VCFs can help you

**solve problems
in radar, telemetry, voice coding,
signal conditioning, data acquisition,
plus many other areas.**

VCFs allow you to electronically shift cut-off frequency without affecting the shape of the response. They are compact, stable, and extremely reliable.

Our standard VCFs — now in stock — are 4-pole Butterworth, 24 dB/octave, either high-pass, low-pass, or band-pass.

Cut-off Frequency Range	0.1 Hz to 20 kHz
Tuning Ratio	50:1
Tuning Voltage	0 to 5 VDC
Module Size	0.75" x 2.15" x 2.15"
Quantity prices for some versions	— under \$80.

See us also for custom active filters.

ARITECH
CORP

130 Lincoln St., Brighton, Mass. 02135
Telephone: (617) 254-2990

INFORMATION RETRIEVAL NUMBER 93

Introducing DIGI POWER

4 POWER SUPPLIES IN ONE.

A NEW LABORATORY POWER SUPPLY FOR THE DESIGN AND BREADBOARDING OF INTEGRATED CIRCUIT DEVICES.



MODEL 401
LABORATORY
POWER SUPPLY

Furnishes the required voltages for digital and linear IC's and MOS circuits.

\$295.00 FOB Plant — Delivery Off-the-shelf

Astro-Space Laboratories, Inc.



110 Wynn Drive, N.W. / Huntsville, Alabama 35806
205/837-5830

INFORMATION RETRIEVAL NUMBER 94

ELECTRONIC DESIGN 13, June 21, 1970

Hart-Advance Space Savers

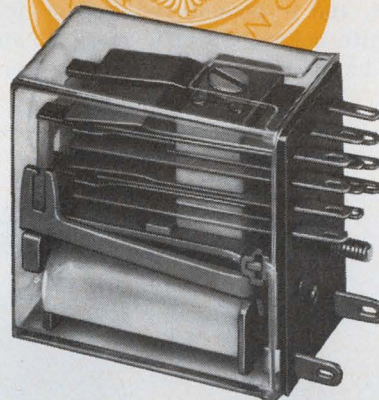

VersaPac Offers 2 to 8 Form C Contacts in Long Life Miniature Cradle Relay

PLENTY OF LIFE—VersaPac relays are regular old graybeards when it comes to long life. Plug them in and forget about them for millions of operations!

REALLY STACKED—We know space, weight and costs are big problems for you. That's why we designed VersaPac miniature relays to do a lot more... and do it economically! Mini-size at 1-2 cu. in. and lightweight at 1-1.4 oz.

CROSS-BAR CONTACTS—Contacts are single or bifurcated and rated at 3 and 5 amps, 6-115 volts. Gold plated silver-alloy contacts.

AVAILABLE WITH printed circuit and solder terminals, or for use with P.C. or solder type sockets.

For full details, write today for DISTRIBUTOR CATALOG.



HART-ADVANCE RELAY DIVISION
OAK ELECTRO/NETICS CORP • CRYSTAL LAKE, ILL. 60014
PHONE: 815-459-5000 TWX: 910-634-3353

INFORMATION RETRIEVAL NUMBER 95

Indicator lights mount within 1/2 in.

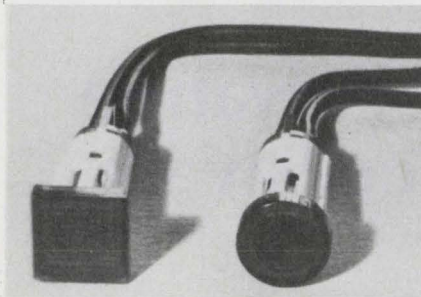

Nucleonic Products Co., Inc., 6660 Variel Ave., Canoga Park, Calif. Phone: (213) 887-1010.

Molded of Makrolon polycarbonate plastic, series 1.69507 indicator lights require a center-to-center mounting space of only 1/2-in. and less than 1.181-in. behind-the-panel depth. The units are available with round or square lenses in transparent red, yellow, green, clear or blue colors, and in opaque red, yellow or white colors. Specific messages can be provided.

CIRCLE NO. 297

Molded film inductors are only 0.035 in.³

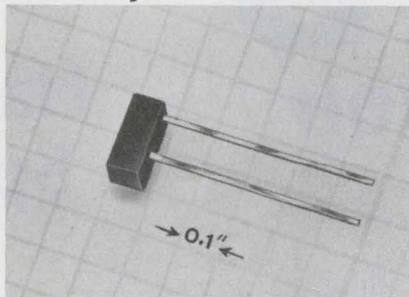

Piconics Inc., Cummings Rd., Tyngsboro, Mass. Phone: (617) 649-7501. P&A: \$1.90; 2 to 3 wks.

Ranging in value from 1 to 10 μ H, a new series of miniature hybrid molded inductors measures only 0.06 by 0.06 by 0.18 in. Series D devices use a special wrap-around anchored-lead design with internally-welded construction to provide extremely rugged mechanical geometry. Inductors are available with either silver-plated copper or solid-gold ribbon leads.

CIRCLE NO. 298

Pushbutton indicators solder onto PC board

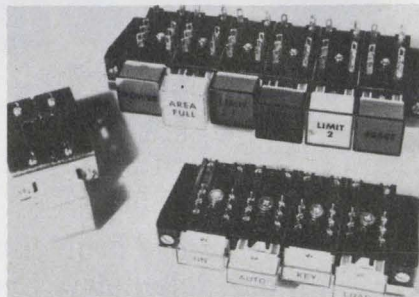

Nuclear Products Co., Inc., 6660 Variel Ave., Canoga Park, Calif. Phone: (213) 887-1010.

The Vario 4 system features individual illuminated pushbutton switches with momentary or maintained action, which mount on 0.8-in. centers and are flow-soldered to printed circuit boards. Strip assemblies of up to 20 pushbutton modules may be obtained with various interlock, reciprocal-release or release-button mechanisms. Lamps are front-of-panel replaceable.

CIRCLE NO. 299

... This Miss ... Never Misses



Patents Pending

... with her New DC IV Diagnostic Computer

She quickly pinpoints problem logic devices and other functional defects in digital circuit boards ... before they become production bottlenecks.

- Built-in mini-computer provides flexibility, speed and instant self-generation of test sequence from English statements.
- Optional CRT enhances operator-machine dialog.
- Simultaneous examination of all signal pins.
- Definition of input and output pins dynamically assigned under program control.
- Automatically tests inputs as well as outputs.
- Up to 4080 test pin capability for complete systems checkout.

Contact us for complete technical information: Digital/General Corp., University Circle Research Center, 11000 Cedar Avenue, Cleveland, Ohio 44106. Telephone (216) 721-0440.

DIGITAL / general

CORPORATION

Nationwide and Worldwide Service By Raytheon Service Company

RAYTHEON

16-bit minicomputer accesses in 400 ns

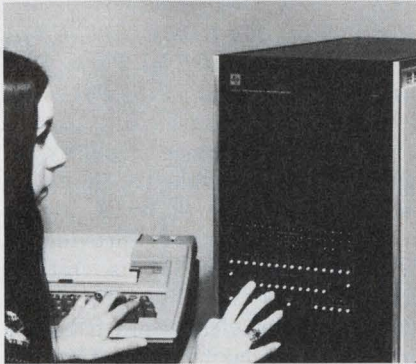

Texas Instruments Inc., Digital Systems Div., P.O. Box 66027. Phone: (713) 494-5115.

The model 980 is a 16-bit stand-alone minicomputer featuring 1- μ s cycle time and 400-ns access time. Its basic memory capacity is 4096 words and is expandable to a capacity of 65,536 words. Up to 85 instructions, including multiply and divide, are available. Software includes a real-time monitor, an assembler and a FORTRAN compiler.

CIRCLE NO. 335

Video display terminal shows 400 characters



Unicom Inc., 1275 Bloomfield Ave., Fairfield, N.J. Phone: (201) 228-1696. Price: \$2745.

Using 64 alphanumeric and control ASCII characters in a 5-by-7 dot matrix, the CT-3000 video communications terminal displays 400 characters/line. It offers internally addressable page memory, sufficient drive for 10 monitors and can be used with any standard TV monitor. Available options include a capacity of 800 characters/page.

CIRCLE NO. 336

Great little tester...

the Simpson Handi-VOM®

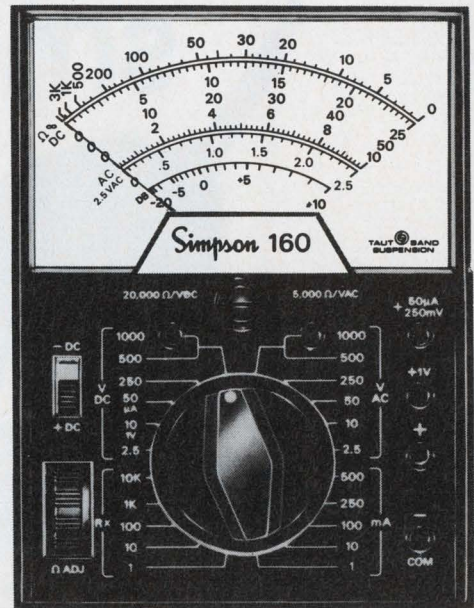

Goes anywhere:

Small and light enough to carry in your shirt pocket, tool box or brief case. 3 $\frac{5}{16}$ " wide by 4 $\frac{9}{16}$ " high by 1 $\frac{3}{4}$ " deep. Only 12 ounces.

Does big-VOM jobs:

Ranges: DC Volts: 0-0.25, 1.0, 2.5, 10, 50, 250, 500, 1000 at 20,000 Ω /v. AC Volts: 0-2.5, 10, 50, 250, 500, 1000 at 5,000 Ω /v. DC Microamperes: 0-50. DC Milliampers: 0-1, 10, 100, 250, 500. Resistance: Rx1 (30 Ω center), Rx10, Rx100, Rx1k, Rx10k.

Has big-VOM features:

Accuracy: \pm 2% F.S. DC, \pm 3% F.S. AC. Self-shielding: Taut Band Movement. Varistor Protected: Resists 200,000% overloads. Tough, Rugged Case: Withstands even a bench fall.

Priced Right:

Model 160 with batteries, test leads and operator's manual \$55.00
 Vac-formed or leather carrying case \$11.00
 Amp Clamp Adapter lets you measure up to 250 amps in six ranges, Model 150 \$30.00
 Adapter plugs \$ 1.55

In stock at electronic distributors everywhere or write for Bulletin 2080

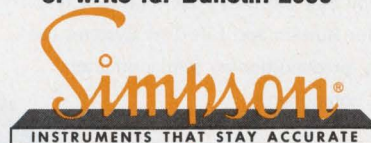

SIMPSON ELECTRIC COMPANY

5200 W. Kinzie St., Chicago, Ill. 60644, Phone: (312) 379-1121
 Export Dept: 400 W. Madison St., Chicago, Ill. 60606, Cable SIMELCO
 IN CANADA: Bach-Simpson, Ltd., London, Ontario
 IN INDIA: Ruttonsha-Simpson Private, Ltd., International House, Bombay-Agra Road, Vikhroli, Bombay

small

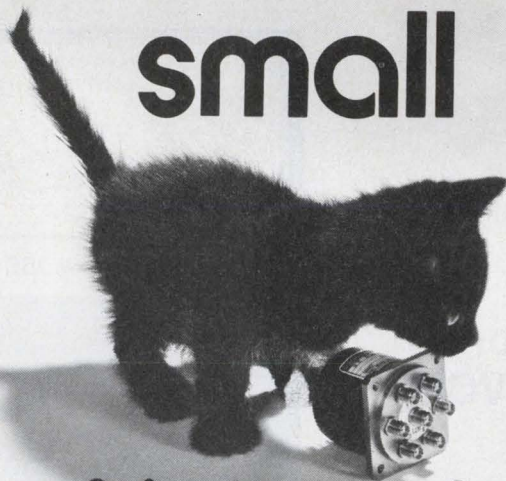

fast & independent

TYPE-MO COAXIAL SWITCH about a 1½" cube, 6 positions, up to 18 GHz, SMA connectors. Independent solenoids for each position mean faster switching times.



Power connector or terminals . . . sealed . . . immersion proof . . . extreme environments. (Sorry, kitten is not for sale.)

Transco Products, Inc. 4241 Glencoe Ave., Venice, Calif. 90291

INFORMATION RETRIEVAL NUMBER 98

You can reduce costs by Improving Reliability

EARLY SEMICONDUCTOR FAILURES INCREASE COSTS.



The semiconductor components you buy can pass your supplier's tests and still fail in your equipment. Our Burn-in and Life-Test Systems can eliminate costly rework by preconditioning semiconductors and IC components.

Circle our information retrieval number for a copy of "A Logical Approach to Testing ICS."

Contact

AEROTRONIC ASSOCIATES

CONTOOCOOK, NEW HAMPSHIRE 03229 TELEPHONE (603) 746-3141

INFORMATION RETRIEVAL NUMBER 99

DATA PROCESSING

Modular core memory cycles in 650 ns

Mnemotek, 7206 Hibbs Lane, Edgeley-Levittown Industrial Park, Levittown, Pa. Phone: (215) 943-9060. Availability: Sept., 1970.

Featuring a basic capacity of 4k by 9, expandable to 8k by 27 in increments of 4k by 9, a new modular core memory provides a total cycle time of 650 ns. Options include total recall (data retention), master clear, internal testing, internal parity generation and checking, random sequential addressing, and data and address indicator lights.

CIRCLE NO. 337

Memory with 10 kbits boasts 90-ns access

Memory Technology Inc., 83 Boston Post Rd., Sudbury, Mass. Phone: (617) 891-8465.

With capacities up to 10,240 bits and word lengths up to 80 bits per word, a new read-only memory accesses in 90 ns. The Nanoram 90 features 190-ns cycle time and a non-volatile form of storage that is mechanically alterable. Individual bits, words, or the entire memory contents can be modified. It is TTL compatible and consumes less than 5 W of power.

CIRCLE NO. 338

560-kbit memories retail for \$2700

Data Disc, Inc., 1275 California Ave., Palo Alto, Calif. Phone: (415) 326-7602. Price: \$3200 or \$2700.

Two new low-cost disc memories, the 7102 and 7102E, feature 17-ms access time, 560 kbits of storage and read/write and track-selection capability at costs of \$3200 and \$2700, respectively. The 7102E does not include mounting hardware and power supply that are available with the 7102. Plug-in compatibility to larger-capacity memories is possible.

CIRCLE NO. 339

\$7300 computer/plotter takes 160 instructions



Olivetti Underwood Corp., 1 Park Ave., New York, N.Y. Phone: (212) 679-3400. Price: \$7300.

Featuring a memory consisting of 10 registers each storing a 31-digit number with sign and decimal point, the P203 computer/plotter costing \$7300 stores up to 160 instructions (single address). It has 3 operating, 5 storage and 2 instruction registers (3 storage registers can be used for data or instructions). Printed paper output is at 30 characters/s.

CIRCLE NO. 340

CRT display terminal programs and stores



Computer Terminal Corp., 9725 Data Point Dr., San Antonio, Tex.

In a package the size of a typewriter, the Datapoint 2200 terminal offers keyboard entry on a CRT display, a dual magnetic-tape cassette for program and data storage, Bell System compatibility and general-purpose computing. It operates in off-line data preparation or on-line unattended polling modes, has a CRT display of twelve 80-character lines and contains a memory of 8000 eight-bit bytes.

CIRCLE NO. 341

Quality tape cassettes are fully certified

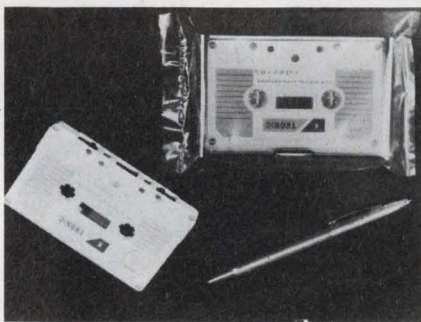

K/Tronic, Inc., 10601 Saratoga-Sunnyvale Rd., Cupertino, Calif. Phone: (408) 253-7100.

Designed to fit into any standard deck, new computer-grade digital-tape cassettes are fully checked and certified for slitting accuracy, rippled edges, output uniformity, dropouts, noise level, tolerance of plastic parts and fastwind characteristics. Tapes are 0.15-in. wide and are available in lengths of 150 and 300 ft.

CIRCLE NO. 342

Digital-tape cassette eliminates static



Computer Cassette Co., 4087 Glencoe Ave., Venice, Calif. Phone: (213) 398-2713. P&A: \$2.50; stock to 2 wks.

Specifically designed for computer applications, a new cassette features anti-static digital tape and liners, lubricated bearings and a positive hub lock that eliminates tape slippage. Each new cassette is certified individually for absence of dropouts at 800 bits/in. and 15 in./s. Each contains 300 ft of computer-grade tape.

CIRCLE NO. 343

Before you test...

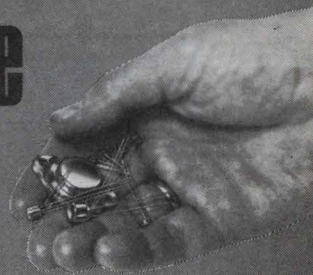

test LORLIN

FAST-ACCURATE-AUTOMATIC

When you use a Lorlin transistor or diode tester programmed specifically for your product you will find you get more thruput with greater accuracy than from any competitive equipment. And you will also pay less for this Lorlin Tester.

Lorlin Automatic Testers for transistors can test over a range of 0.1 nanoamps to 10 amps and 10 mV to 600 V. Diodes can be tested automatically over a range from 1 nanoamp to 25 amps and from 10 millivolts to 2000 volts. All types of semiconductors from small signal to high power can be tested for breakdown voltages, leakage, gain and saturation voltages with 1% accuracy. Dual transistors can be tested for matching parameters.

Models are available with up to 24 test positions and 18 sorting classifications. Remote test stations with the same range and accuracy are available to permit several operators to share one tester. All Lorlin testers will interface with automatic probing, handling and classifying equipment.

Lorlin testers are designed for maximum reliability, ease of service, convenience of programming, and simplicity of operation. Their speed, accuracy and reasonable price provide users a substantial return on their capital investment. Write or call for more information and a test demonstration in your plant.

LORLIN industries inc.

Precision Road, Danbury, Connecticut 06810
Tel: 203-744-0096

For Literature Circle 100
For Demonstration Circle 101

NEW
RF MILLIVOLTMETER

- Solid State
- Programmable
- Accuracy 1% fs + 1% rdg.
- Half Rack Size 5.2" high
- Push Button Ranging
- Linear DC Output
- Many more features

Write for Details

BOONTON
ELECTRONICS
CORPORATION

ROUTE 287 PARSIPPANY, N.J. 07054

Telephone: 201-887-5110

TWX: 710-986-8241

INFORMATION RETRIEVAL NUMBER 102

152

DATA PROCESSING

**Rugged minicomputer
meets military specs**

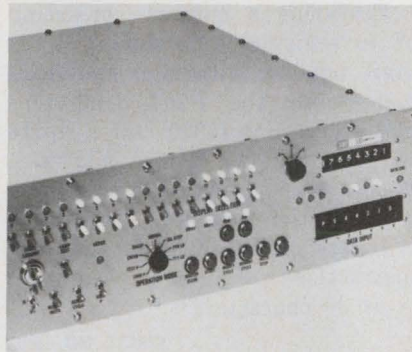

Control Data Corp., 8100 34th Ave. S., Minneapolis, Minn. Phone: (612) 888-5555. Price: \$16,700.

Designated the CDC 5100, a new minicomputer is designed to operate under extreme environmental conditions covered in military specification MIL-E-16400 (Class 4). It features a lithium-ferrite-core destructive readout memory, a 16-bit internal I/O channel, four 32-word file registers and two external interrupts. Basic memory is 4096 words.

CIRCLE NO. 344

**Keyboard costing \$1800
records dual-image tape**

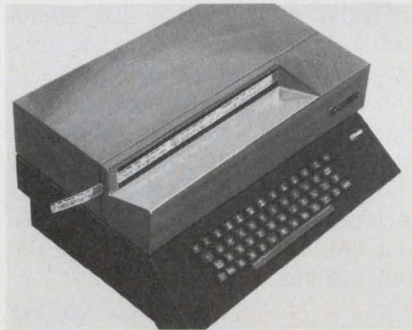

Interface Mechanisms, Inc., 5503 232 St., S.W., Mountlake Terrace, Wash. Phone: (206) 774-3511. P&A: \$1800; 45 days.

Model 2101 is a low-cost \$1800 stand-alone keyboard for recording data onto dual-image tape. Data is printed on white paper tape, with each character containing the machine code and corresponding human readable letter, numeral or symbol. The last keyed character is visible so that data can be confirmed, or errors corrected using perforated tape procedures.

CIRCLE NO. 345

**14-digit calculator
contains memory**



Dictaphone Corp., 120 Old Post Rd., Rye, N.Y. Price: \$875.

Equipped with a single memory system is the model 1412 14-digit calculator that sells for \$875. It allows the accumulation or the storage of a series of numbers for future calculations. Features include pushbutton decimal setting, a floating negative sign and zero suppression. The display uses mosaic lamps and non-glare glass. Calculating speeds range from 0.03 to 0.3 s.

CIRCLE NO. 346

**Fast 450-baud coupler
is sensitive to -50 dBm**

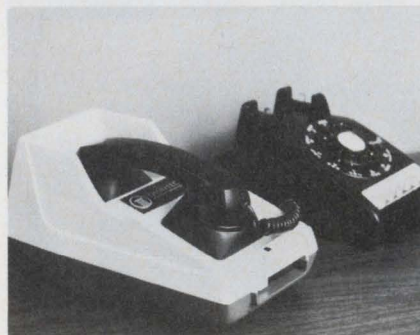

Omnitec Corp., 903 N. Second St., Phoenix, Ariz. Phone: (602) 258-8216. P&A: under \$300; stock.

Operating at data rates of over 450 baud is the new 701B telephone coupler with a sensitivity of -50 dBm acoustic. It features dual TTY and EIA interfaces, full or half duplex operation, acoustic or hard-wire coupling and an injection-molded case incorporating integral sound barriers as a part of the basic design. All circuitry is mounted on a single PC board.

CIRCLE NO. 347

For us, the truth comes easy.

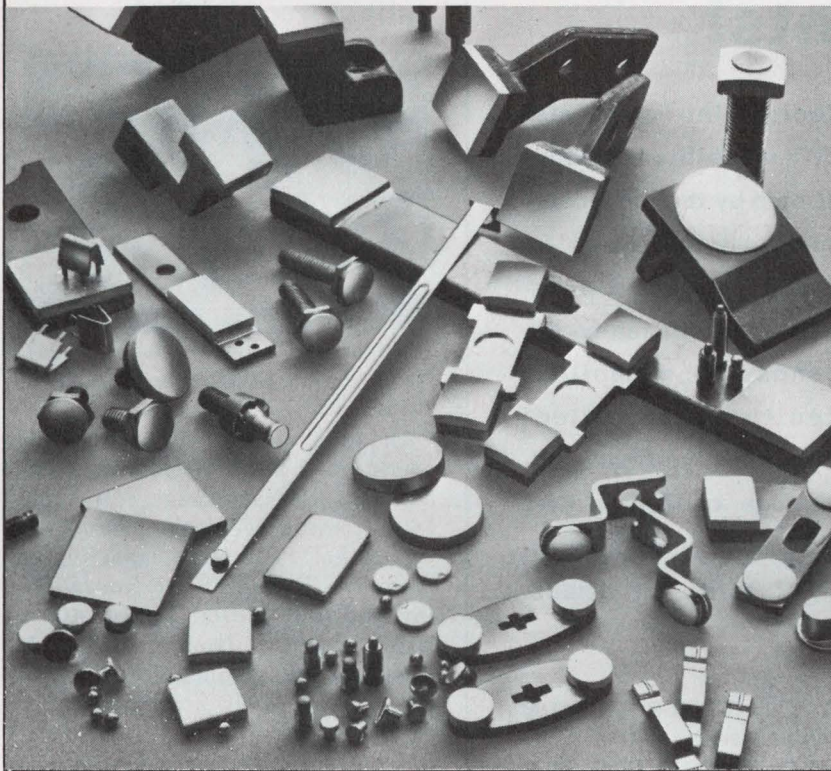

When we recommend a contact material for your switch, thermostat, relay, elevator control, or any other contact application, it's because it's the proper material for you to use.

... Not because it happens to be the one we manufacture.

When you produce the broadest line of contact materials you can afford to be objective. No one else can.

While this objectivity is good for our business, it's even better for yours because we'll only recommend a metal because it's best suited for your application ... not to make a sale.

Our engineering background, manufacturing facilities and broad experience in applications surpass those of any one in the field. So does our product line of contact metals. For information and/or technical assistance, call or write the H. A. Wilson Technical Service Department (201) 686-6600.

ENGELHARD

ENGELHARD INDUSTRIES DIVISION
ENGELHARD MINERALS & CHEMICALS CORPORATION
2655 U. S. ROUTE 22, UNION, NEW JERSEY 07083

An Equal Opportunity Employer

193

INFORMATION RETRIEVAL NUMBER 103

FOR EXCELLENCE IN TERMINATION HARDWARE SPECIFY GRAYHILL

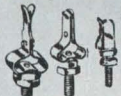

Test Clips

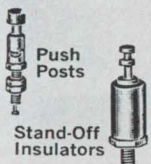

Push Posts

Stand-Off Insulators



Binding Posts



Sockets



Plastic Molded Parts

Test Clips

Adjustable tension, threaded studs or plug in bases, various sizes.

Push Posts

Plunger action lets you connect and disconnect quickly and easily, assures positive contact.

Binding Posts

Screw type or spring loaded, banana plug or stud mounting, single or multiple units, with various colors for circuit identification.

Stand-Off Insulators

High dielectric strength, low loss insulation, low moisture absorption, various mounting styles.

Sockets

Lamp or transistor, various colors, various mountings including printed circuit.

Custom Molded Parts

Tight tolerances provide you with "assembly ready" units. Thermosetting plastics to meet most specifications.

For your Grayhill Engineering Catalog offering complete technical data—contact



565 Hillgrove Avenue
LaGrange, Illinois 60525
Area Code 312, Phone 354-1040



... the Difference Between Excellent and Adequate

INFORMATION RETRIEVAL NUMBER 104

ELECTRONIC DESIGN 13, June 21, 1970

ON THE MOST WANTED LIST

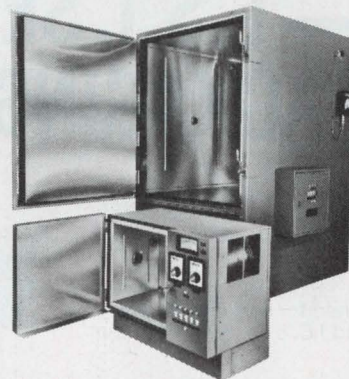

ALIAS MINI & MAXI

Real names: **TH-Jr. and TH-65.** Smallest and largest members of the "Tenney Gang" of reach-in, temperature-humidity chambers. Easily identified by the Tenney Vapor-Flo® humidity generation system and the fully hermetic, all-welded Hermeticool® refrigeration system.

Known to cover a temperature range of 0°F to 200°F and a humidity range of 20% to 95% RH. Noted for responsive performance. Praised for ease of operation and high reliability.

Can be found serving in evaluation or manufacturing of products sensitive to temperature and humidity environments. For details on Mini, Maxi and all the Gang in-between, call or write today:

Tenney
ENGINEERING, INC.

1090 Springfield Rd., Union, New Jersey 07083 • (201) 686-7870
Western Division: 15721 Texaco St., Paramount, Calif. 90723



619A

INFORMATION RETRIEVAL NUMBER 105

153

Where reliability really counts!

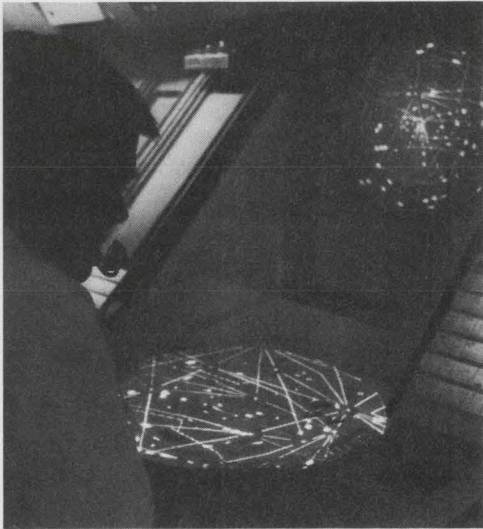

Zenith Flat-Face Metal CRT reliability is demonstrated by their extensive use in enroute air traffic control centers and airports. When safety depends on reliability, Zenith is specified! Shouldn't you take advantage of Zenith CRT quality in your application? Write for details.



ZENITH RADIO CORPORATION
THE RAULAND DIVISION

5616 W. JARVIS AVE. • CHICAGO, ILL. 60648 • 312-647-8000

INFORMATION RETRIEVAL NUMBER 106

L.S.I. SERIES IC PACKAGING SOCKETS

- Designed for use with 24 and 36 lead I.C.'s on .600" between rows.
- Accepts packages with round or flat leads.
- Contoured entry holes for easy, damage free I.C. insertion.
- Available in Diallyl Phthate with gold plated contacts.
- Wire Wrap or printed circuit termination.

Booths 3949-50 NEPCON EAST

Request Data Sheet 166D

AUGAT INC.

TEL: 617/222-2202
31 PERRY AVENUE, ATTLEBORO, MASS. 02703

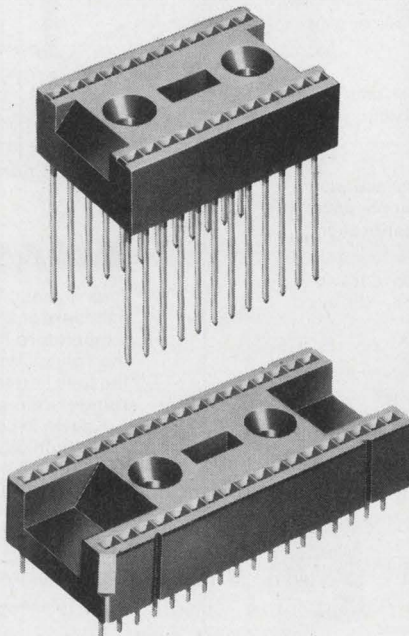

INFORMATION RETRIEVAL NUMBER 107

INSTRUMENTATION

Universal ac bridge sells for only \$60

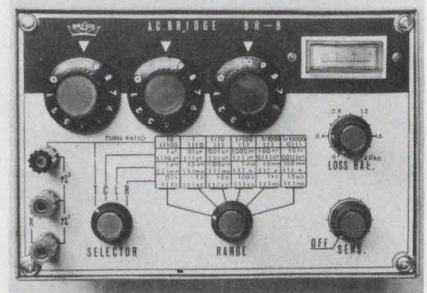

Electronic Tools Div. of C. H. Mitchell Co., 18531 Ventura Blvd., Tarzana, Calif. Price: \$60.

Using a single 9-V battery for operation, a new transistorized six-decade 1-kHz ac bridge costs only \$60. It measures resistances from 0.1 Ω to 11.1 M Ω , capacitances from 10 pF to 1110 μ F and winding ratios from 10⁻¹:1 to 11,100:1 with accuracies from 1 to 5%. It also measures inductances from 1 μ H to 111 H at accuracies of 2 to 5%.

CIRCLE NO. 348

Four-digit multimeter is accurate to $\pm 0.3\%$



Rhode & Schwarz Sales Co., Inc., 111 Lexington Ave., Passaic, N.J. Phone: (201) 773-8010. P&A: \$750; stock.

The UGWD is a four-digit (fourth digit is an overrange 1) dual-slope multimeter measuring ac and dc voltages from 100 μ V to 1000 V, and resistances from 1 Ω to 15 M Ω , at an accuracy of $\pm 0.3\%$ of reading $\pm 0.1\%$ of full scale. Overrange is 50% for dc voltages and resistances. Integrating time is 300 ns and sampling rate is 3 measurements/s.

CIRCLE NO. 349

Digital multimeter retails at \$295



Electro-Numerics Corp., 2961 Corvin Dr., Santa Clara, Calif. Phone: (408) 738-1840. P&A: \$295; stock.

Offering overload protection, a new three-digit multimeter with 100% overrange and an optional battery operation, costs only \$295. The model 1000A measures dc voltages from ± 200 mV to ± 1 kV in 5 ranges and resistances from 200 Ω to 20 M Ω in 6 ranges. Sampling rate is 10 readings/s and step response is 700 ms. Input impedance is 10 to 100 M Ω .

CIRCLE NO. 350

Four-function generator retails at only \$295

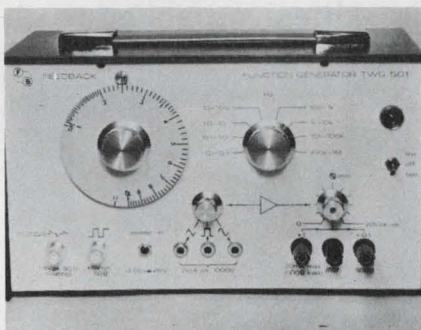

Feedback Inc., 438 Springfield Ave., Berkeley Heights, N.J. Phone: (201) 464-5181. P&A: \$295; stock.

Covering 0.01 Hz to 1 MHz in 8 decades, the TWG501 low-cost multi-function generator offers sine, square, triangular and pulse outputs at a cost of \$295. Frequency-setting accuracy is $\pm 2\%$ with under 0.1% of drift. Sine-wave distortion is less than 2%, square-wave risetime is 15 ns and triangular waves are 99% linear. Output is 20 V pk-pk at 20 mA.

CIRCLE NO. 351

Easy-to-use analyzer tests PC boards at once

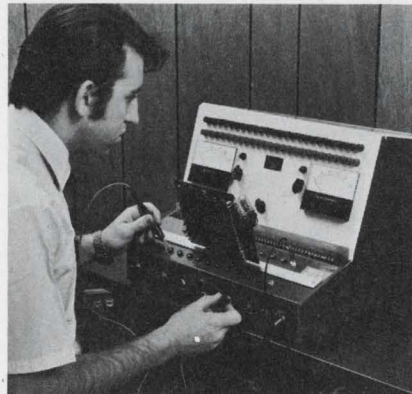

Besa Scientifics, Inc., 284 5th Ave., New York, N.Y. Phone: (212) 736-9123.

The Besamatic 1200 P PC-board analyzer pinpoints circuit problems in seconds and can be operated by unskilled personnel. It utilizes controlled programs to test most digital PC boards. Built-in features include a light bank, Nixie display, stop-on-fault-capability, meters and probes, a power supply with 7 simultaneous voltage levels and a generator covering 50 to 100 kHz in 10 kHz increments.

CIRCLE NO. 352

Seven-channel scope self-adjusts time base

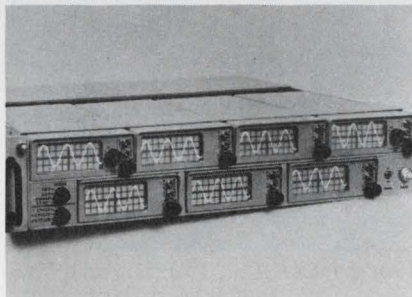

Calico Div. of California Instruments Corp., 3511 Midway Dr., San Diego, Calif. Phone: (714) 224-3241. P&A: \$4195; 30 days.

Designed to monitor vibration signals from systems operating in a sweeping mode, model 7005 oscilloscope with 7 channels of display offers a self-adjusting time base. It can be operated in a sweep-synchronization mode with 1, 2 or 3 cycles of display. It has 7 1-by-3-in. CRTs and mounts in a 19-in. rack.

CIRCLE NO. 353

INFORMATION RETRIEVAL NUMBER 108 ▶

SWITCH TO FRITCH®

FREQUENCY RESPONSIVE SWITCHES

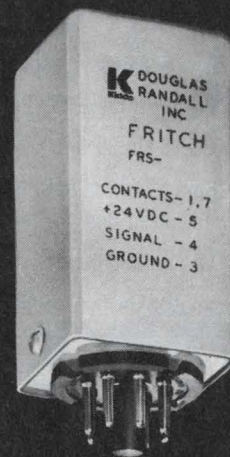

HERE'S WHY:

- Broad Frequency Range ... 20 HZ to 100 KHZ
- Low Signal Power ... as low as 0.3 milliwatts
- Fast Response Time ... up to 150 operations per second
- Solid State Reliability
- Shock and Vibration Resistant
- SPST to DPDT Outputs

Especially Recommended For:
"TOUCH-TONE"* Decoding • Telemetry • Over and Under Frequency Control • Multi-Zone Alarm Detection Over One Telephone Line.

Price in units of 100 ... \$14.40
(Oscillators also available)

*Registered Service Mark of AT&T.

DOUGLAS RANDALL, INC.

6 Pawcatuck Ave.,
Westerly, R.I. 02891

A Division of
Walter Kidde & Company, Inc.



C-COR AMPLIFIERS

— PULSE —
Fast Rise-Time
for

- High Resolution Video
- Nuclear Instrumentation
- Laser-Optics
- Digital Computer Design

1 nS to 10 nS Rise times

5 Hz Response

12 V Peak, 50 Ω Load

Matched In/Out Impedances

\$95 — \$775

— FAMILY FEATURES —

- Low Frequency Response
- Output thru $\pm 25V$ Peak
- High Gain 20 thru 60 dB
- Spin-offs from AEC/NASA Advanced Design Projects
- Missile Reliability
- Adjustable Gain in Some Versions

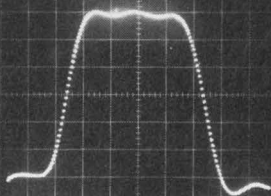

1 nS Response (10-90% levels)
Rise Time of a 5 nS Positive Pulse
Oscilloscope: Tektronix 561-B
Vertical: 200 mV/cm.
Horizontal: 1 nS/cm.

EXAMPLES

R.T.	Gain	Output	Model
1 nS	23dB	$\pm 6 V_p$	3010-AP
2 nS	40dB	$-6 V_p$	3364-G
3 nS	20dB	+4 Vp -8 Vp	3329-F
4 nS	60dB	+4 Vp -8 Vp	3388-F
5 nS	20dB	$\pm 1\frac{1}{2} V_p$	3518

Select from 17 models off-the-shelf.
"C-COR Amplifiers . . . Rated First
Where Performance is Rated First."



C-COR

ELECTRONICS, INC.

60 Decibel Road
State College, Pennsylvania 16801
814 238-2461

PACKAGING & MATERIALS

Sealing compound clings to any metal



Bishop Manufacturing Corp., 10
Canfield Rd., Cedar Grove, N.J.
Phone: (201) 239-2400.

Conformability and permanent adherence to virtually all metals, extruded dielectrics and cable jackets are some of the principal features of improved Electro-Seal 10 sealing compound. Another feature is a trouble-free plastic separator for easy stripping and quick application. This improved compound is impervious to ozone, water, and corrosive chemicals.

CIRCLE NO. 354

Fiber-optic guides pass ambient light

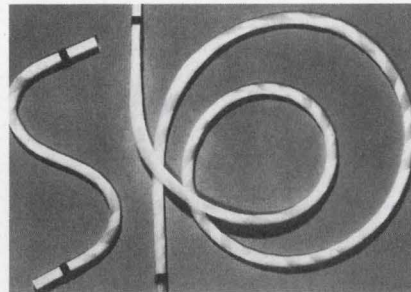

Van Deusen Co., 775 Laguna Canyon Rd., Laguna Beach, Calif.
Phone: (714) 494-4310. Price: from \$15/ft.

Series 3000 fiber-optic image guides feature a unique end-cap construction that allows ambient light to illuminate the image area. The new guides are available at prices as low as \$15 per foot for a 0.25 by 0.25-in. array of 10-mil polymer fibers. Standard lengths range from one to four feet. The guides are manufactured with a semi-automated process.

CIRCLE NO. 355

Shielded boxes accept PC cards

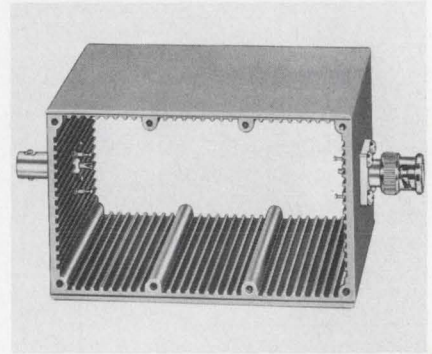

Pomona Electronics Co., Inc., 1500
E. Ninth St., Pomona, Calif.
Phone: (714) 623-3463.

Slotted to accept 1/16-in. printed circuit boards, a new line of shielded black boxes offers an inside useable space that measures 4-in. long by 2-in. wide by 3-in. deep. Models 3311, 3312, 3313 and 3316 provide two different combinations of BNC connectors, or allow the user to install his own connectors. Available accessories include boards and aluminum shielding dividers.

CIRCLE NO. 356

Silicone emi gasket is adhesive-backed

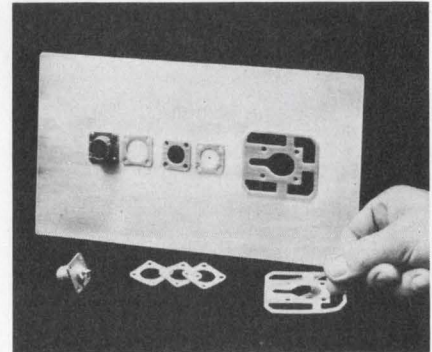

Metex Corp., 970 New Durham Rd.,
Edison, N.J. Phone (201) 287-0800.

Called Polastick, a new adhesive-backed silicone composite gasket for emi shielding and pressure sealing eliminates the tedious and often expensive task of gasket bonding. The material will seal up to 100 psi and will withstand temperatures between -70 and $+380^{\circ}F$. Monel wires imbedded in the silicone provide effective emi shielding without restricting compressibility.

CIRCLE NO. 357

Drafting table suits the user

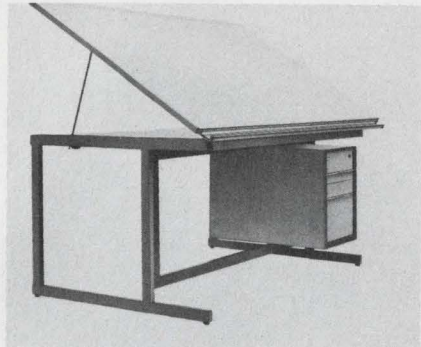

Stacor Corp., 285 Emmet St., Newark, N.J. Phone: (201) 242-6600.

Draftmaster II is a modern human-engineered drafting table with 35 in. of working height to give maximum working comfort, when the draftsman is standing or sitting on a stool. Another feature is the absence of front cover legs, which allows users to move about freely and work comfortably at the corners of the board. Three types of drafting surfaces can be supplied.

CIRCLE NO. 358

Flexible-neck tool blows and illuminates

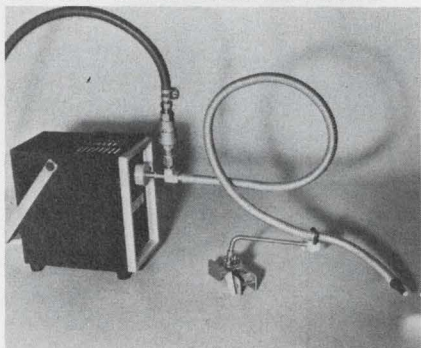

Keystone Optical Fibers, Inc., sub. of Keystone Bay State Industries, Inc., 151 Hallet St., Boston, Mass. Phone: (617) 436-8000. Price: \$149.50.

A new flexible fiber-optic blower/illuminator, called Air Flex-I-Lite, simultaneously directs air and light on a work area. Air is channeled for discharge at the critical workpiece and, at the same time, a bright cold light emits from this output end in an annular ring around the air passage.

CIRCLE NO. 359



There's Something New In Positioning Devices...

BRUSHLESS
WIDE ANGLE
DIRECT DRIVE
LOW COST

DC Torque Motors from Aeroflex...

Now, the maker of wide angle, high reliability, brushless DC torque motors for the critical aerospace and defense markets — Aeroflex — presents the new Valueline for commercial/industrial applications. A quality counterpart of the mil-spec Aeroflex torque motor, Valueline offers the value-engineered alternative to motor-gearhead combinations, at prices and performance criteria to meet commercial requirements.

This low cost line comes in a variety of sizes and outputs, with a direct drive design that provides space-saving packaging and simplified installation. Valueline Brushless DC Torque Motors, requiring no gear trains, offer the designer these benefits: • System simplification • High torque/power ratio • Fast response • Rapid acceleration at low speed • Low input power • Smooth, quiet output • Precise positioning • Excellent linearity • Infinite resolution • Virtually, unlimited service life.

With the Aeroflex Valueline, there's no reason to go gear train. Go direct drive at a cost savings to your systems budget. Send for the complete Valueline product performance story — VL670.



TORQUE MOTOR PRODUCTS DIVISION
AEROFLEX LABORATORIES Inc.

South Service Road, Plainview, L. I., N. Y. 11803
Tel. (516) 694-6700

**WRITE
FOR
FREE
BROCHURE**

the valueline



New Infrared Detectors and Emitters.

Lead-Tin-Telluride Detectors for 8-14 micron radiation. Optimum performance at 77°K. Peak spectral response can be selected. Available in various configurations.

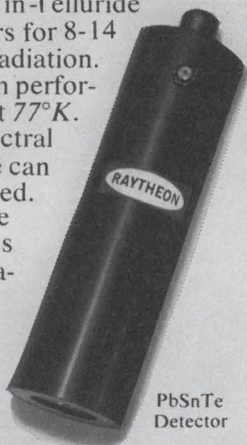

PbSnTe Detector

Also available—a new family of high power, high efficiency gallium arsenide emitters. 150 milliwatts continuous output at better than 10% efficiency. Substantially higher outputs achievable by cooling the diodes.



GaAs Emitter

Raytheon produces IR detectors covering the spectrum from 2 microns to 8 mm. Both single elements and arrays have been produced.

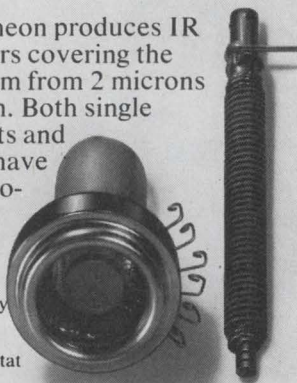

InSb Array Dewar Assembly and Cryostat

RAYTHEON

Special Microwave Devices Operation
130 Second Avenue
Waltham, Mass. 02154
(617) 899-8080

Evaluation Samples

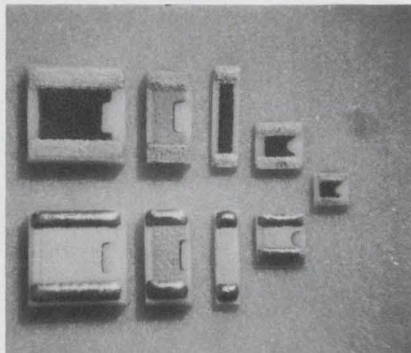

Thick-film resistors

Free samples of precision thick-film resistors are available. They include nine different types optimized for size, power, resistance and high-frequency performance. Some are as small as 35 mils square. Resistances include values up to 1000 M Ω , and power ratings extend up to 1/2 W. Wire-bondable versions are available with gold electrodes. Other versions include palladium-silver electrodes tinned with silver-bearing solder. Mini-Systems, Inc.

CIRCLE NO. 360

Wire sample card

A new free wire sample card with 11 6-in. samples of wire styles is available. The 11 styles include heater, lead, high-voltage, appliance, machine tool, fixture hook-up and flexible-cord wire. All carry the listing of the Underwriters' Laboratories and the Canadian Standards Association. Easy Heat-Wirekraft Div. of MSP Industries.

CIRCLE NO. 361

Glass strips

Samples of multi-channel glass strips ranging in size from 3/8 to 1/20-in. wide are available. Each strip contains four rectangular openings. The glass can be supplied in various shapes such as tees, channels and many other unusual forms. It is presently manufactured in flint-lime types. Friedrich & Dimmock, Research Div.

CIRCLE NO. 362

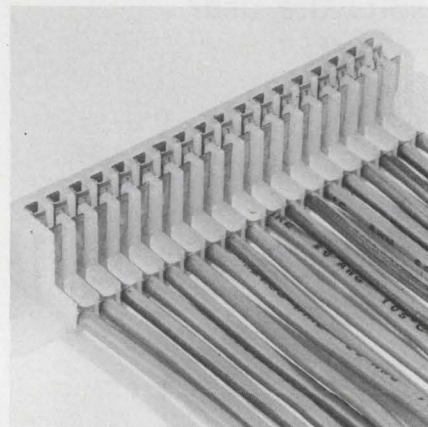

PC edge connector

New to the field of printed-circuit edge connectors is an 18-circuit right-angle model that is available as an evaluation sample. Like other connectors in its Edgecon series, it is designed for use in computers and communications equipment. It has reliable crimp-type terminals supplied in chain-link form that snap-lock into nylon housings. The terminals can be easily removed with a simple hand tool. Molex Products Co.

CIRCLE NO. 363

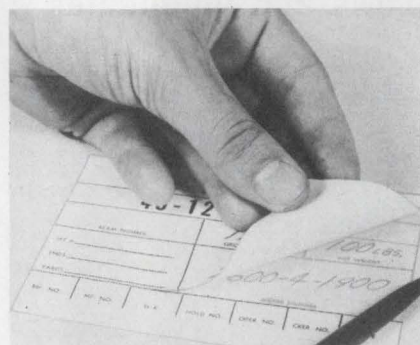

Labels

A sample of a new-construction carbon liner that produces a permanent record of labeled information and improves the efficiency of evidence documentation is available. This very practical pressure-sensitive product can be adapted for use in mail labeling, order entering, quality-control coding, and many other applications where recorded numbers, words or coding is required. York Tape and Label Corp.

CIRCLE NO. 364

Design Aids

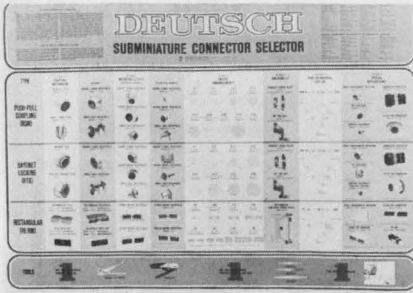

Connector selector

Environmentally sealed high-density connectors are described in a new wall chart. This handy selector graphically depicts shell styles, coupling types, insert arrangements, application performance levels and specification data. It also has information on lanyard disconnects, rfi shielding and devices using filter pins. Included on the chart are bayonet-locking, push-pull coupling, rack-and-panel, jack-screw-mating and in-line connectors, and hermetically sealed receptacles. Deutsch Co., Electronic Components Div.

CIRCLE NO. 365

Counter selector

An impulse-counter selector chart that gives outline specifications for a wide range of counter models is available. Models include totalizing, predetermining, printing, differential, transmitting and auxiliary types. A brief description of an impulse counter and its application is given with available voltages, counting speeds, number of digits and overall dimensions. Landis & Gyr Inc.

CIRCLE NO. 366

Semiconductor guide

A new cross-reference for universal-replacement transistors and rectifiers is available in a pocket-size booklet. The most popular transistor and rectifier types used are listed in numerical order. Specifications are presented in a quick-reference tabular format. Case outline dimensions for cross-referenced units are also given. International Rectifier Semiconductor Div.

CIRCLE NO. 367

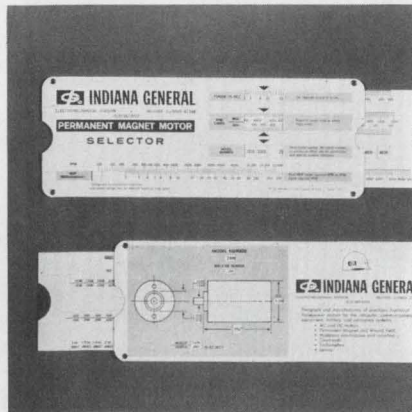

Motor selector slide

Designed for use in the selection of permanent magnet motors is a new slide rule that simplifies motor selection. By adjusting its slide to the amount of torque required, the designer may quickly determine maximum and minimum revolutions-per-minute limits and then read the millihorsepower available within these limits. If the millihorsepower is initially known, revolutions per minute and torque may be determined by using a reverse procedure. Electro-Mechanical Products, Indiana General.

CIRCLE NO. 368



Foam properties

An application table listing the properties of Eccosyn syntactic foams is available in a handy folder. Listed properties include color, mix preparation, cure conditions, density, cell structure, compressive strength, service temperature and water absorption. Also listed are thermal conductivity and expansion coefficient, dielectric constant, dissipation factor, volume resistivity and dielectric strength. All pertinent applications are also discussed in the folder. Emerson & Cuming Inc.

CIRCLE NO. 369

Another
unique quality
of Electro Cube
is to pack
more into a
small package
reliably



electro cube
capacitors

Our new 50 Volt metallized polycarbonate capacitors, with .00008 gauge film, make conventional units look like elephants. If space is a problem, ask. We'll help. Electro Cube, Inc., 1710 South Del Mar Avenue, San Gabriel, California 91776. (213) 283-0511.

New

MICRO-VECTORBORD® AND D.I.P. PLUGBORDS ARE HERE!

Save time — Save work — Save money

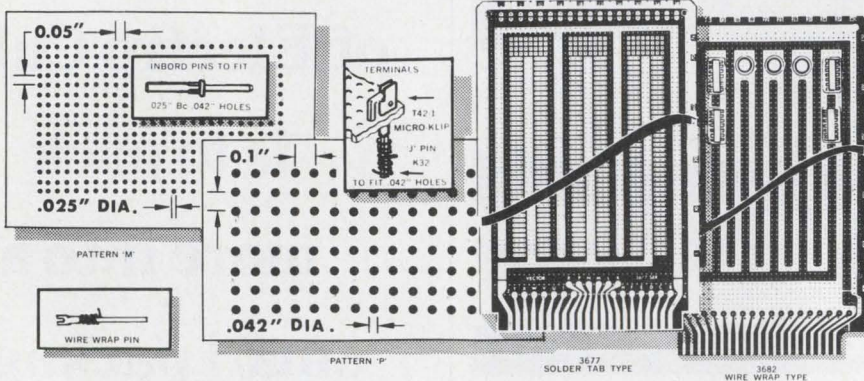

WIDE SELECTION OF SIZES AND MATERIALS

MICRO-VECTORBORD "P" .042" holes match D.I.P. leads. Epoxy glass or paper, cop. cld. also 1/64" to 1/16" thk.

MICRO-VECTORBORD "M" .025" holes match Flat-Paks, 1/32" Epoxy glass, cop. cld. also or .007" Mylar.

NEW SOLDER-PAD D.I.P. PLUGBORDS — 3677 Series Epoxy glass, "P" pat., 1/16" thick with 44 etched plug contacts (2 side total) power, ground

busses, pads for up to 24 D.I.P.'s (14's). Also 21 units 16-leads D.I.P.'s, T-O's and discretes.

NEW WIRE WRAP D.I.P. PLUGBORDS — 3682 Series Similar to above but closely spaced bus lines for higher density. Up to 48 D.I.P. 14 lead wire wrap sockets mountable or T-O's and discretes.

TERMINALS — Micro-Klips, Mini-Wire-Wraps, Rd. Pins, Patch Cords, etc., available.

Vector

Send for complete literature

ELECTRONIC CO., INC.

12460 Gladstone Ave., Sylmar, California 91342

Phone (213) 365-9661 • TWX (910) 496-1539



INFORMATION RETRIEVAL NUMBER 113

Application Notes

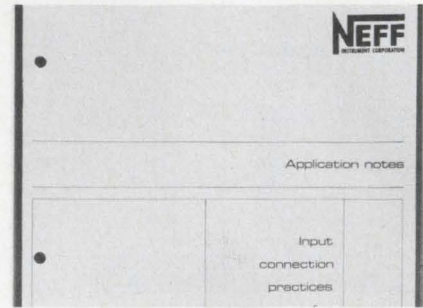

Differential amplifiers

The correct input connection practices for differential amplifiers are described in a 12-page application note. It defines common terms, discusses the function of the guard shield and gives typical input circuits for thermo-couples and bridge transducers. A set of rules are formulated for correct input connections. Neff Instrument Corp.

CIRCLE NO. 370

Inverter thyristors

How to characterize and what affects thyristor inverters is the subject of a 16-page application booklet. It gives detailed classification of inverter circuits, with each circuit supported by characteristic curves, methods of operation and proper applications. This is followed by discussions on SCR switching ratings and characteristics, and specifying SCR thyristors for inverted service. All discussions are fortified with illustrations, curves and circuit diagrams. International Rectifier.

CIRCLE NO. 371

Power-supply connections

Reprints of an 11-page article entitled "Avoid the Pitfalls of Power-Supply Connections" are available. The five pitfalls presented include improper dc distribution, ground loops, improper remote-sensing connections, improper remote-programming connections and improper ac power-input connections. Rules for avoiding each of the pitfalls are presented and illustrated. Hewlett-Packard, New Jersey Div.

CIRCLE NO. 372

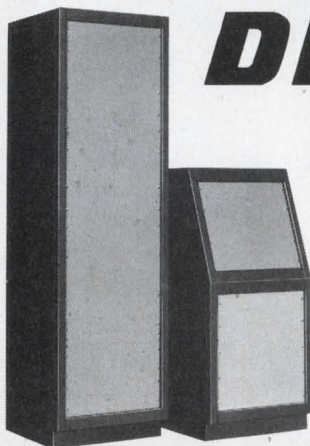

DELIVERY?

400+ cabinet components from stock!

Honeywell Series 40 Electronic Cabinetry offers 15 different frames . . . two week delivery . . . with hundreds of modular components that let you mix and match to a perfectly fitting and functionally modern cabinet system.

MODU-MOUNT® Cabinetry features a multi-formed frame to combine great strength with optimum space utilization and mounting convenience. Rails and supports are positionable for any equipment. Standard E.I.A. openings. Interchangeable panels and other options for maximum versatility. Full details . . . call or write Will McLaughlin or Ray Martin, Honeywell, Inc., Wabash, Indiana 46992. Telephone: 219 - 563-2161.

Honeywell CABINET DESIGNERS FACTBOOK

Comprehensive 28-page book available no charge to complement your cabinet design and specifying knowhow.



Complete 24-page price/discount book provides total information. Available with Honeywell Series 40 Handbook on request.

INFORMATION RETRIEVAL NUMBER 114

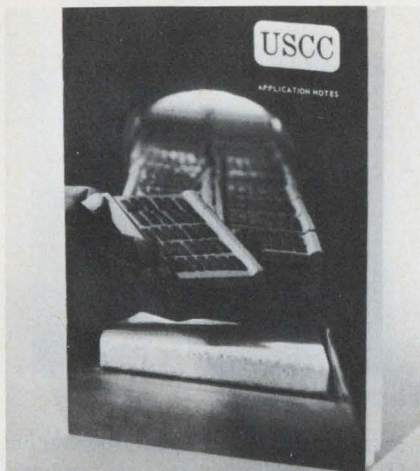

Chip capacitors

A 28-page manual discusses practical considerations for selecting and using monolithic chip capacitors. Featured are important criteria needed by engineers and engineering designers to specify the right capacitor for every application. Answers are given on important electrical and environmental characteristics, such as dielectrics, the effects of temperature on the crystalline structure of ceramic dielectrics, combined voltage and temperature effects and W and NPO dielectrics. You'll also find answers to questions concerning mounting and applications of chip capacitors, storage and handling considerations, methods of chip attachment and ultra-thin metals and terminations. U.S. Capacitor Corp.

CIRCLE NO. 373

GaAs applications

An illustrated application handbook for optoelectronic devices entitled "GaAs Lite Tips" describes in words and circuit diagrams various ways to use light-emitting semiconductors. Some applications detail how light-emitting diodes can serve as constant-brightness light sources. Others describe how to use a photodiode coupled pair from a relay and how to operate a number of solid-state displays with only one decoder/driver, Monsanto Co., Electronic Products & Controls Div.

CIRCLE NO. 374

The Motor Catalog

IMC Eastern Division

Our Driver Manual.

(It's a free license to control all driving situations.)

Fault-free control of load driving can be yours when the motor matches (or exceeds) your product or system requirements and avoids the performance compromises inherent in common motors.

The Motor Catalog offers you literally thousands of choices — size, type, horsepower, torque, input — to obtain exactly the motor you need. In addition, there's comprehensive theory and applications information.

IMC Magnetics Corp., Eastern Division, 570 Main Street, Westbury, N.Y. 11591, Tel. (516) 334-7070, TWX 510-222-4469

INFORMATION RETRIEVAL NUMBER 115

New Literature

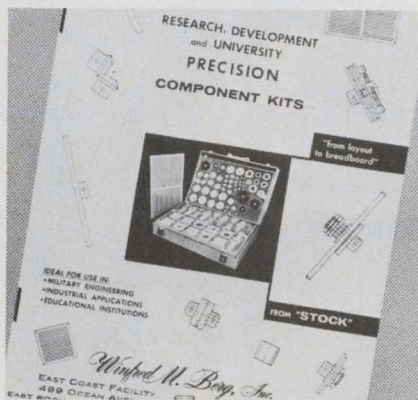

Breadboard kits

A new catalog of breadboard component kits shows over nine varieties of kit sizes and styles from which to select. Some kits contain over 650 parts. Cases are felt-lined, and the hardware is ready for assembly. Winfred M. Berg, Inc.

CIRCLE NO. 375

Relay course

"A Five-Minute Course in Relays/Contactors" is an eight-page brochure that gives answers to some of the most frequently asked questions about relays and contactors, as well as applications and uses. Also described are mercury plunger relays for high-power switching. They have currents ratings as high as 60 A and operating lives in excess of 100,000,000 cycles. Mack Electric Devices Inc.

CIRCLE NO. 376

Measuring frequency

"Precision Frequency Measurements" is a 16-page booklet that discusses the use of the model 5360A computing counter as a high-resolution digital frequency-measuring instrument. Several kinds of frequency measurements are described in detail, and the counter's capabilities are compared with those of conventional counters. Measurements treated include short-term stability, time comparisons between frequency standards, crystal warm-up characteristics, and fractional-frequency deviation. Hewlett-Packard.

CIRCLE NO. 377

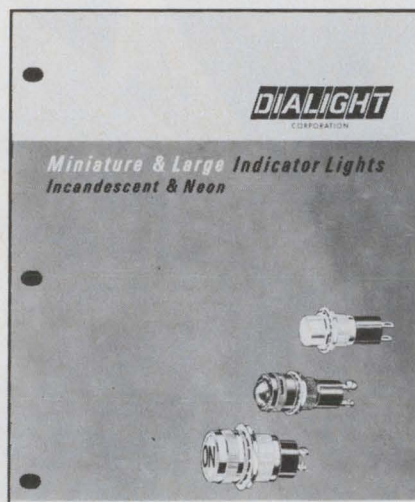

Indicator lights

Well illustrated and fully detailed, a 20-page catalog covers miniature and large indicator lights, as well as incandescent and neon lamps. A section of the catalog lists the different lens cap assemblies available for panel-mounting indicators or for use with open assemblies. In addition, comprehensive data tells of materials and finishes, construction features, and applicable military specifications. Dialight Corp.

CIRCLE NO. 378

Teletype talk

A 16-page telecommunications primer—"The ABC's of Teletype Equipment"—discusses how teleprinters transmit and receive, and explains the five and eight-level data transmission codes. Shown and described is Teletype equipment as well as its component parts. Teletype Corp.

CIRCLE NO. 379

Validator software

Described in a four-page brochure is The Validator, a software package which provides economical systems input validation. The functions of the package as well as its advantages to the user are covered in detail. Data Management Services, Inc.

CIRCLE NO. 380

Application Report



Flip-flop notes

Explaining the use of series 54H/74H100 circuits in several typical applications, an 18-page application report describes the internal functional and terminal characteristics of this family of flip-flops. Practical guidelines for optimum use of the ICs are also given. Texas Instruments Inc.

CIRCLE NO. 381

Tools catalog

Covering production equipment and basic supplies, a 164-page tools catalog is specifically addressed to the manufacturing engineer, the purchasing agent, and the production and quality control departments. Included in the catalog are wire strippers, screwdrivers, pliers, soldering and desoldering tools, semiconductor handling equipment, and many other items. Henry Mann, Inc.

CIRCLE NO. 382

Adhesives guide

Featuring a two-page chart that identifies and describes twenty Bostik industrial adhesives, a 12-page catalog includes a glossary of commonly used terms and hints on how to optimize the use of adhesives. Listed are neoprenes, natural rubbers, reclaim rubbers, nitriles and resin-based rubbers. Also discussed are the principal variables encountered in selecting the right adhesive—for example, the materials to be bonded, service conditions to be met, production requirements, and finally, applied costs. USM Corp., Chemical Div.

CIRCLE NO. 383

There are 17 big panel meters on the market.

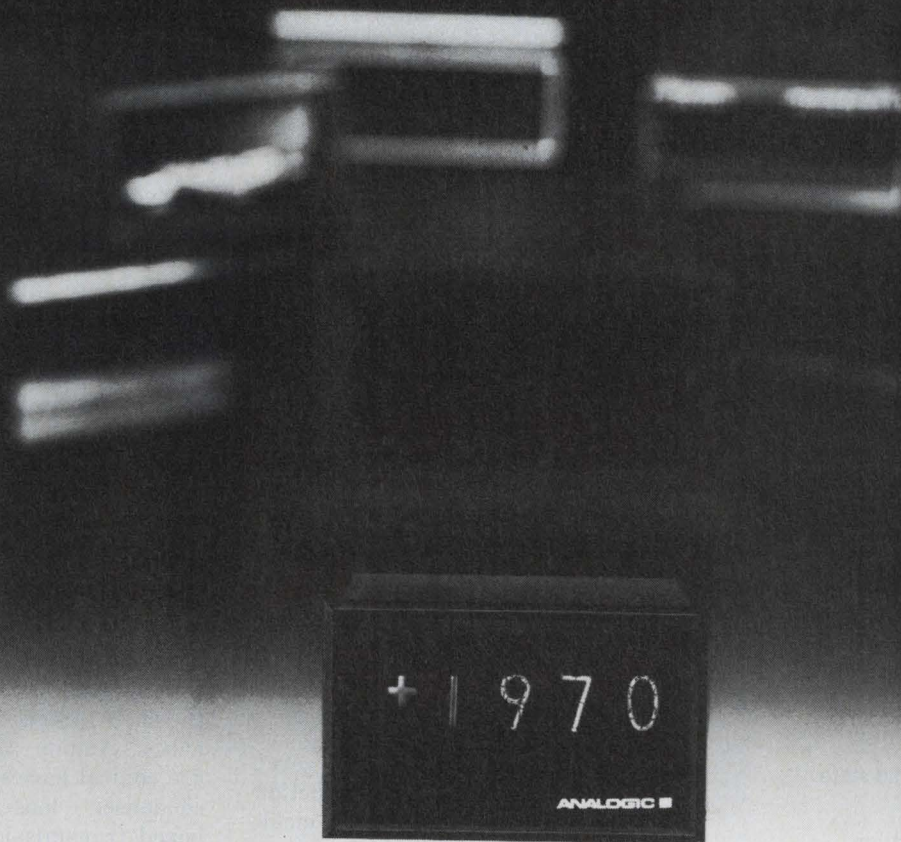

Analogic offers you the only small alternative.

If your specifications require a small digital panel meter, Analogic's AN2500 series is your only choice. For example, the AN2510 shown above is only 2 $\frac{1}{4}$ "H x 3 $\frac{5}{8}$ "W x 2 $\frac{7}{8}$ "D . . . approximately half the size of competitive units.

Small size is only part of the story. The AN2510 features high accuracy (0.05%), wide operating temperature range (-10°C to $+60^{\circ}\text{C}$), differential input and BCD output . . . all while using only half the power of larger units. The price? A small \$179.50, less with our substantial OEM discounts.

You'll probably find there's a standard Analogic DPM that meets your exact requirements. And if you don't — then we'll design it. Write or phone for complete information.

ANALOGIC ■

... THE DIGITIZERS

Audubon Road, Wakefield, Massachusetts 01880
Tel. (617) 246-0300, TWX (710) 348-0425

EMC simplified

BY USE OF **ACL**

FI-601

14 KHz to 1.0 GHz

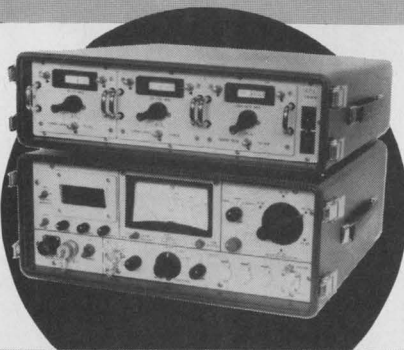

- Electronically swept plug-in RF tuners.
- Complete coverage of 14KHz to 1 GHz with 6 tuners
- Complete solid state circuitry
- Built-in Spectrum Display for IF monitoring
- Selectable IF bandwidth (4 provided)
- Designed for testing in accordance with such specifications as:
MIL-STD-461, 462, 463
MIL-STD-826 MIL-STD-449
FED-STD-222

ACL

ASTRO COMMUNICATION LABORATORY

A Division of Aiken Industries, Inc.

9125 GAITHER ROAD
GAITHERSBURG, MD. 20760

Phone: (301) 948-5210 TWX 710-828-9706

RF Equipment for The Systems Engineer

NEW LITERATURE

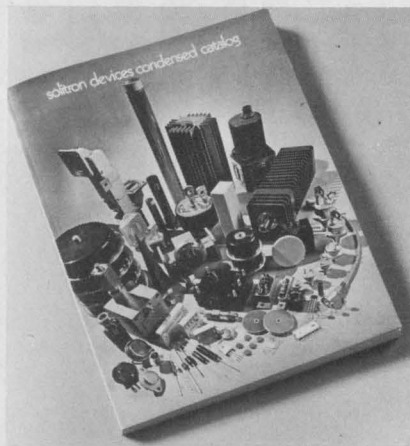

Component catalog

Bound with a full-color cover, a 208-page condensed catalog presents a full array of electronic components. Described are high-voltage rectifiers, and special rectifier assemblies. Small-signal, power, rf, industrial and field-effect transistors, as well as linear and MOS ICs are included. There is also a section on microwave components like step attenuators, fixed pads, waveguide switches, variable attenuators, and terminations. Solitron Devices, Inc.

CIRCLE NO. 384

Plastic parts

Four full-color brochures cover the specifications and production of injection and compression molded plastic parts. Included are a wide variety of plastic items developed for the automotive, appliance, electrical and television industries. The Haas Corp.

CIRCLE NO. 385

PC connectors

Revised and expanded to 56 pages, a PC connector guide describes 26 separate series of metal-to-metal connectors. These conform to the newest requirements of MIL-E-5400, MIL-E-8189 and MIL-T-21200. The connectors are compatible with solder, wire-wrapping, crimp, taper-tab, and taper-pin terminating techniques. A three-page illustrated foldout index simplifies connector selection. Elco Corp.

CIRCLE NO. 386

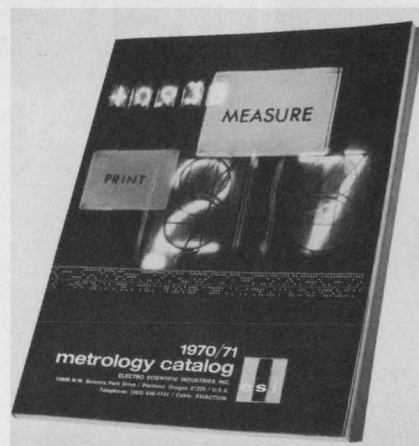

Instrument catalog

Many types of instruments such as devices for measuring voltage, resistance, capacitance, ratio and temperature are contained in a 128-page catalog. Other instruments include automated and multi-purpose measurement systems, data acquisition systems, generators, detectors, standards and accessories. Electro Scientific Industries.

CIRCLE NO. 387

Optical components

Featuring numerous new products in its 28 pages, an optics catalog lists a wide variety of off-the-shelf precision optical components. Among the new additions are conical lenses, glass and quartz condenser lenses, laser lenses, boxed transmission filter sets, and laser polarizers. Standard products include beamsplitter cubes and plates, telescope objective lenses and hardware, precision retroreflectors, and quarter-wave and half-wave plates. Special Optics.

CIRCLE NO. 388

Semiconductors

Called a semiconductor digest, a 16-page catalog contains parts numbers, primary specifications, cross-references and outline dimensions. Covered are: silicon controlled rectifiers, power logic triacs, power rectifiers, selenium rectifiers, zener regulators, light-sensitive devices, and heat exchangers. International Rectifier Corp., Semiconductor Div.

CIRCLE NO. 389

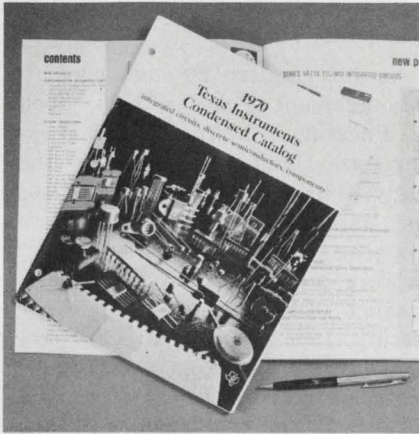

Semiconductor catalog

A 60-page condensed semiconductor and components catalog gives listings for: integrated circuits, silicon transistors, optoelectronic devices, germanium transistors, diodes, rectifiers, resistors, microwave components, thyristors, trigger diodes, and power transistors. Electrical parameters, mechanical data, product features, applications information, and circuit diagrams are provided. A 10-page section highlights recently introduced semiconductors, ranging from TTL MSI integrated circuits through discrete optoelectronic devices. Texas Instruments Inc.

CIRCLE NO. 390

CAD optimization

MATCH, a proprietary CAD (computer-aided design) program for circuit designers, is claimed to be the first generally available program to provide optimization—the automatic variation of circuit parameters so as to improve circuit design. The user can specify a desired frequency response, giving either the magnitude or phase. MATCH then takes a “ballpark” design and varies its element values to fit the response to that desired. This optimization feature simplifies broadbanding, equalization, and synthesis problems, and is also useful for correcting designs to account for parasitics. Applicon Inc.

CIRCLE NO. 391



...measure 1 μ v to 1000V and enjoy multimeter convenience



Here's the sweetest little performer around in a low-priced, 3½-digit dc multimeter. A new entry fielded by Keithley, leader in low voltage measurements, the Model 160 sweetens its fantastic $\pm 1 \mu\text{v}$ sensitivity with $\pm 0.1\%$ accuracy, true input impedance of 10 megohms, $\pm 1 \mu\text{v/day}$ stability and high ac rejection.

As an ammeter, it stands alone handling $\pm 0.1 \text{ nA}$ to ± 2 amperes full scale, with $\pm 0.2\%$ accuracy. Similarly, as an ohmmeter, this versatile performer spans a resistance range from 0.1 ohm to 2000 megohms full scale measured using 2-terminal leads.

Wide capability in measuring voltage, current and resistance make the Model 160 useful on every R & D and production test bench. Conven-

ience features are numerous. A display rate of two readings per second with 100% overranging. When overloaded, the display blanks the last 3 digits for no-error interpretation. Two front panel input terminals handle all functions. Choice of grounded or floating operation. And lots of other sweet features. Including a low price of \$545.

See how sweet it is. Call your Keithley Sales Engineer or contact us direct for details. Get a free “how sweet it is” button, too. (Great for the kids.) Keithley Instruments, Inc., 28775 Aurora Road, Cleveland, Ohio 44139. Or telephone 216/248-0400. In Europe: 14, Ave. Villardin, 1009 Pully, Suisse. Prices slightly higher outside the U.S.A.



KEITHLEY

MINIATURE BALANCED MIXERS

How about this! A mixer with a 6.0 dB noise figure at 1.5 GHz. And packaged in a TO-5 container. Too good to be true? Check the typical performance below.

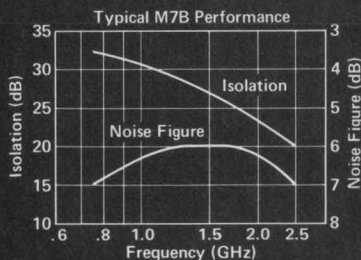

Performance is guaranteed over a temperature range -54°C to $+100^{\circ}\text{C}$ and after environmental stressing per MIL-STD-202D. Other models available for lower frequency applications.

For additional details circle our reader reply number. Better yet, call a RELCOM sales engineer collect for an evaluation unit. Delivery from stock.

RELCOM

2500 MHz



2329 Charleston Road
Mountain View • California 94040
Telephone (415) 961-6265
TWX (910) 379-6979

INFORMATION RETRIEVAL NUMBER 120

NEW LITERATURE



Labels

New pressure-sensitive aluminum-foil labels are fully illustrated in a catalog. Shown are 64 pages of labels for use by purchasing agents, engineers, designers and production personnel. Time-saving ideas for cost savings are given. Special pages are devoted to advertising posters, decals, name plates, warning tags, and scores of other identification products. Seton Name Plate Corp.

CIRCLE NO. 392

Plastic fasteners

Specifications, recommended applications, and prices for a comprehensive line of molded, machined and stamped plastic fasteners are given in a 24-page catalog. Shown are machine and set screws, machine bolts, hex nuts, lock nuts, cap nuts, wing nuts, washers, insulators and rivets, in a broad range of heads, points, thread sizes, lengths and colors. Materials include nylon, Lucite, polypropylene, mica and Teflon. Product Components Corp.

CIRCLE NO. 393

Buss assemblies

Short-run laminar buss assemblies are the subject of a 12-page illustrated design manual. There is also detailed information on Mektron Quik/Bus options. Rogers Corp.

CIRCLE NO. 394

Shipping tips

An informative 20-page booklet, "Management Takes a New Look at Packing, Shipping, and Loss Through Damage," examines the many hidden costs in: freight loss and damage, packing for today's shipping environment, new inner packing materials and techniques, product fragility, and package testing. It also tells managers how to get the most from their transportation, how to use shipping insurance to the best advantage, and how to cut costs through proper packing. Sealed Air Corp.

CIRCLE NO. 395

Small motors

Over 500 fractional and integral-horsepower motors are presented in a comprehensive 24-page booklet with descriptions, applications, dimensions, prices and ordering information. Covered are a broad line of small NEMA 48 and 56-frame motors, rated from 1/20 to 5 hp, for use in fans, blowers, compressors, pumps, machine tools, and general workshop equipment. Also included are NEMA 143T and 145T-frame integral-horsepower motors, rated from 1 to 3 hp. Westinghouse Electric Corp.

CIRCLE NO. 396

Patient monitoring

A 24-page booklet discusses the electrical environment surrounding patients in typical monitoring and catheterization situations—and recommends specific steps and procedures to help insure patient safety. Emphasized is why particular care should be exercised in using electrical equipment for the patient with a direct electrical pathway to his heart. A section is also devoted to instrumentation with isolation protection, explaining the added measure of safety this contributes beyond equipment grounding. Hewlett Packard, Medical Electronics Div.

CIRCLE NO. 397

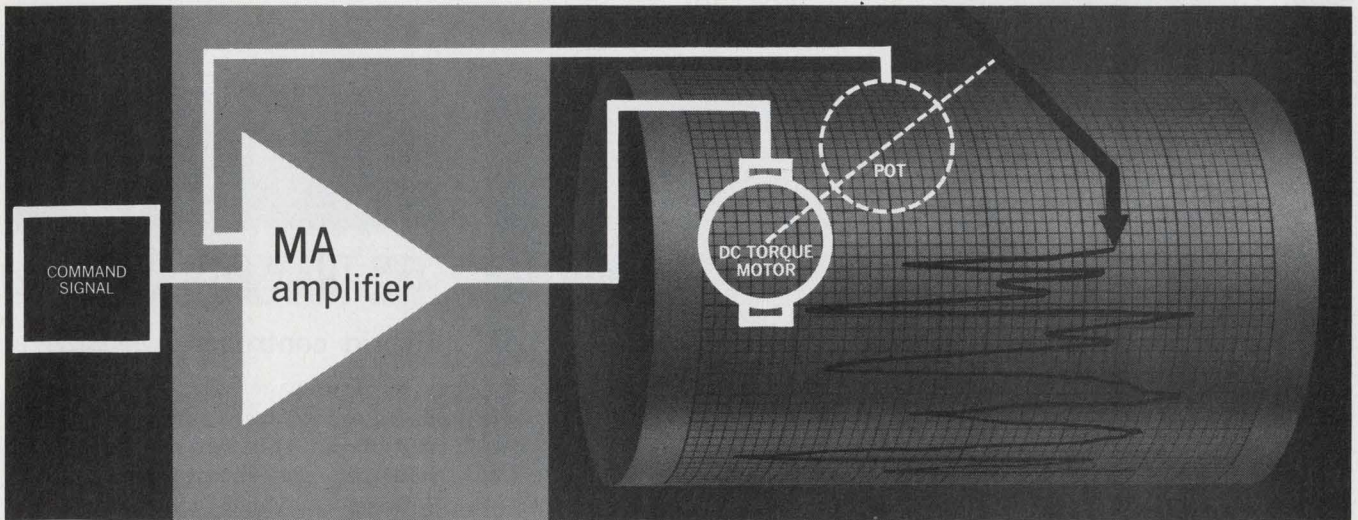

We sell more than amplifiers

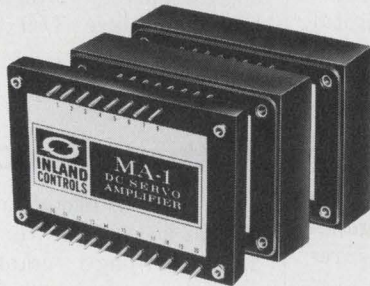

Sure . . . we can provide you with DC servo power amplifiers ranging from 25 to 1,500 watts output. But complete system design is our forte. Working with our sister divisions that manufacture motors and tachs, we can coordinate the design of your system from command signal to primary driver and eliminate interface problems.

The chart recorder above is just one example. Give us a call and let us show you how we debug your application before the bugs get in.



Inland Controls, Inc. 250 Alpha Drive, Pittsburgh, Pa. 15238 Tel: 412-782-3516 TWX 710-664-2082

INFORMATION RETRIEVAL NUMBER 121

0-1

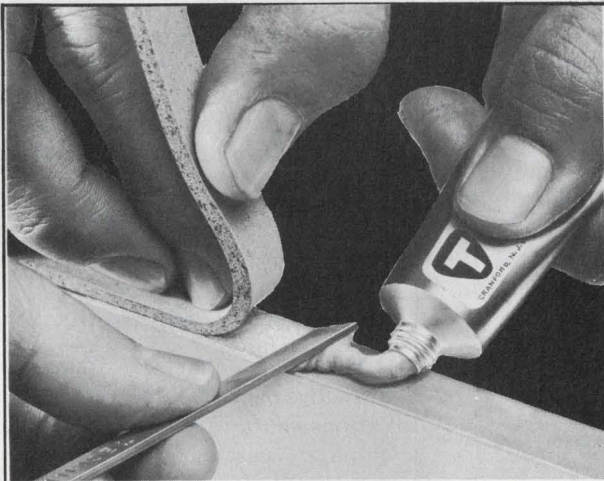

ONE-PART CONDUCTIVE SILVER/SILICONE ADHESIVE

CONDUCTIVE SYSTEM 72-00002 • EMI/RFI shield and fluid seal • Fast, room-temperature cure • Permanent flexibility • Highly compressible • Pure silver and silicone • Copper and solvent free • Unaffected in salt spray environment • Volume resistivity: 0.010 ohm-cm • No mixing or measuring • Operating temperature: -75°F. to +350°F. • Available in 2.0 ounce kits • Write for data #721 on Conductive System 72-00002.

TECKNIT TECHNICAL WIRE PRODUCTS, INC.

East Division • 129 Dermody St., Cranford, N. J. 07016 (201) 272-5500
West Division • 427 Olive St., Santa Barbara, Calif. 93101 (805) 963-1867

INFORMATION RETRIEVAL NUMBER 122

ELAPSED TIME INDICATORS

For a precise record of operating hours

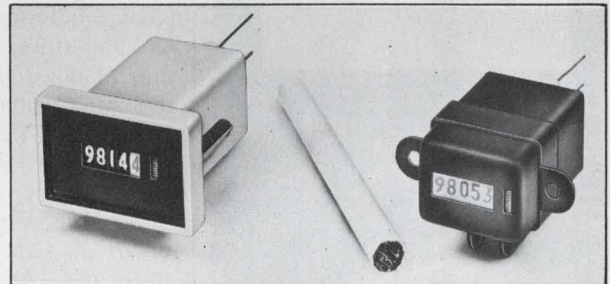

ENM presents a complete line of precision timing devices which provide an accurate and reliable count of operating hours for a wide variety of machinery and equipment.

Series T4 Miniatures

For panel or bracket mounting. Five digits. New synchronous motor drive. Panel unit: 1.59" x 1.03" x 2.03", 3½ oz. Bracket unit: 1" x .81" x 1.97", 2½ oz.

Series T5B Economy Line

For panel mounting. Five digits. With visual indication of motor operation. 1.89" x 1.89" x 1.83", 6 oz.

WRITE FOR CATALOG SHEET
APPLICATION HELP AVAILABLE

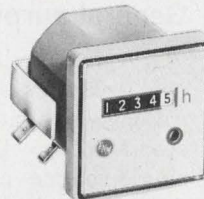

ENM COMPANY

5306 W. Lawrence Ave., Chicago, Ill. 60630
PHONE: (312) 282-8787 TELEX: 02-5468
Representatives in principal cities

INFORMATION RETRIEVAL NUMBER 123

TEST



AMF Cybertran
Video Preamppliers
... Seen but not heard.
If you're looking for low noise at extremely low cost, our Video Amplifiers are the ones. Available with bipolar or FET front end, they also feature gain from 0 to 60 db, frequency range from 10 Hz to 50 MHz, Z_i of 50 Ω to 1000 M Ω , and Z_o of 50 Ω or 75 Ω . For more information on standard or special Quiet Ones from AMF, contact: Ed Rosenthal, AMF Alexandria Div., 1025 N. Royal St., Alexandria, Va. 22314

AMF
ALEXANDRIA

INFORMATION RETRIEVAL NUMBER 124

NEW LITERATURE

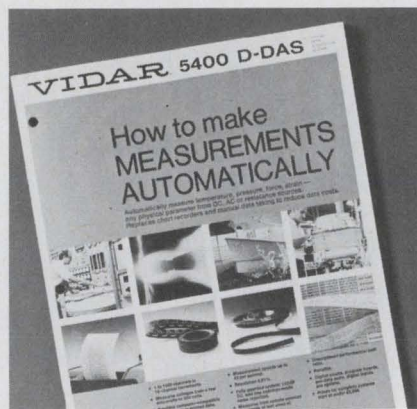

Digital data systems

"How to Make Measurements Automatically" is a 16-page brochure that explains how digital data acquisition systems can automatically measure temperature, pressure, force, strain, and other physical parameters. Included are a detailed systems description and a listing of the considerations involved in selecting the components of an automatic measurement system. Vidar Corp.

CIRCLE NO. 398

Computers & converters

Packed with information, a four-page condensed catalog gives data on computers, basic and multiplexing analog-to-digital and digital-to-analog converters, and a line of DTL and TTL analog and digital logic cards. The series 700 computers offer a choice of central processing units with either 900-ns, 1.5- μ s or 1.75- μ s cycle times. Raytheon Computer.

CIRCLE NO. 399

General-purpose relays

A complete line of general-purpose relays is shown in a 24-page catalog. Designed to simplify relay specification, this comprehensive single-volume catalog includes facts, figures and dimensional drawings on all relays ranging from heavy-duty power to miniature plug-in types specifically engineered for PC applications. Guardian Electric Manufacturing Co.

CIRCLE NO. 400

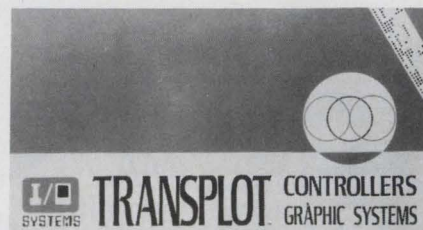

Hybrid controllers

A four-page fully illustrated brochure contains detailed information on standard and optional built-in digital interfaces for Transplot hybrid controllers and graphic systems. Also described are the controllers themselves and special parallel interfaces for several computers. I/O Systems, Inc.

CIRCLE NO. 401

Accessories for ICs

Listing a broad assortment of digital accessories for IC handling, an eight-page catalog provides complete ordering information for dual-in-line IC sockets, flatpack holders, wire-wrap cards and panels, patch cord kits, connectors and power planes. Details on custom wire-wrap services, and pre-cut and stripped wire packages are included. Cambridge Thermionic Corp.

CIRCLE NO. 402

Microwave equipment

Selection charts, dimensional drawings, specifications and applications data are presented in a 40-page catalog on microwave equipment. Described are rf terminations, baluns, calorimeters, attenuators, power meters and cooling units. Electro Impulse, Inc.

CIRCLE NO. 403

Capacitor bulletins

Two new six-page catalogs describe 50-V metalized polycarbonate and polystyrene capacitors. Both lines came in radial-lead, axial-lead and flatpack styles. Engineered Components Co.

CIRCLE NO. 404

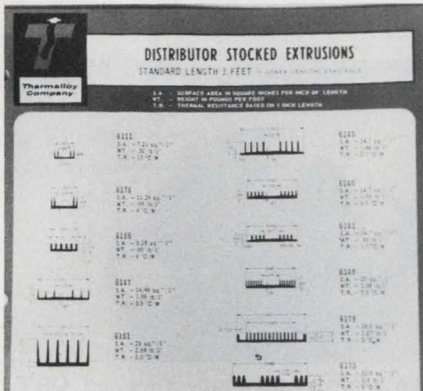

Heat sink extrusions

Profile drawings of a complete line of aluminum extrusions for heat sinking are shown in a four-page brochure. Each extrusion is clearly dimensioned for surface area in square inches per inch of length. Extrusion weights are given in pounds per foot and thermal resistance is given in per unit length. Thermalloy Co.

CIRCLE NO. 405

Delay-line memories

Besides the usual specifications information, an illustrated two-color eight-page brochure includes the basic characteristics and modulation techniques for two magnetostrictive delay-line memories. Series ML units are available with delays up to 10 ms and bit rates to 2 MHz; series CRT units have maximum delays of 8.5 ms and 2.5-MHz bit rates. Microsonics Div., Sangamo Electric Co.

CIRCLE NO. 406

IC testers

Benchtop integrated circuit testers are the subject of a 12-page brochure that explains the operation, testing procedures, specifications and accessories for models 716A and 824. The 716A is designed for simultaneous dc and functional testing of digital and linear ICs, either manually or semi-automatically. Model 824 operates in conjunction with the 716A for production functional testing of digital ICs. Microdyne Instruments, Inc.

CIRCLE NO. 407

**LC & DC • DISPERSIVE • DIGITAL
MAGNETOSTRICTIVE • QUARTZ
GLASS • VARIABLE • TAPPED
LC & DC • DISPERSIVE • DIGITAL
MAGNETOSTRICTIVE • QUARTZ
GLASS • VARIABLE • TAPPED
LC & DC • DISPERSIVE • DIGITAL
MAGNETOSTRICTIVE • QUARTZ
GLASS • VARIABLE • TAPPED
LC & DC • DISPERSIVE • DIGITAL
MAGNETOSTRICTIVE • QUARTZ
GLASS • VARIABLE • TAPPED
LC & DC • DISPERSIVE • DIGITAL**

MICROSONICS

for proven design, reliability & performance in

DELAY LINES

Serial Memories



Write for Bulletins today

MICROSONICS

60 Winter Street, Weymouth, Mass. 02188

Tel: 617 337-4200

A division of the Sangamo Electric Company

INFORMATION RETRIEVAL NUMBER 125

He has
a new view
of life



He's had a heart attack, but he's back on the job. He saw for himself how modern drugs, coronary care units, and new methods of rehabilitation are helping doctors fight the Nation's Number 1 killer.

Heart scientists predict many exciting advances in the foreseeable future, provided more funds are available for research, education and community service. Help make these predictions come true. Give generously to fight the Number 1 threat to your life.

GIVE...
so more will live
**HEART
FUND**

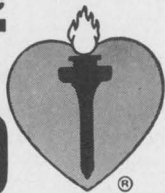

Contributed by the Publisher

Product Bulletin board

Hailed as a U.S. first, a mass-produced home cartridge color television system is expected to be available to the public early in 1971. Called Cartrivision, the system will be manufactured and marketed by Avco's Cartridge Television, Inc. Admiral Corp. will be the first television set manufacturer to adopt the new system. The principal system component, a solid-state combination receiver/recorder-playback unit, will cost from \$800 to \$900. It consists of a cartridge video tape deck and a full-size color television receiver built into a single cabinet. Cartridges will be sold in 15 or 30-minute, and one or two-hour formats. Full-length movies will involve rental charges as low as \$3.

Lexan 500, a new metal-like plastic, is expected to have its most immediate impact as a metal replacement in areas not yet serviced by engineering thermoplastics. Developed by the Plastics Dept. of the General Electric Co., the new polycarbonate meets the need for a self-extinguishing material with high rigidity and creep resistance without sacrificing impact strength. Price is 85¢/lb.

CIRCLE NO. 408



Serving as a world-wide time reference system, the Computron digital clock reports time, to the second, for any of the 24 time zones around the globe. A miniature keyboard, integrated circuits and computer-like programming control the unit's display. Above the keyboard is a time-zone map showing the world's major cities. Initial cost for the Computron, which is made by the Bulova Watch Co., Inc., is \$575.

CIRCLE NO. 409



An electrostatically focused CRT, the WX-30838P, features double-axis auxiliary microdeflection and an optical rear window. The rear window makes it possible to project maps, grids and other data onto the CRT screen as a background to the actual display. The CRT itself can also be photographed through this window without blocking the tube face. The manufacturer is Westinghouse Electric Corp., Electronic Tube Div.

CIRCLE NO. 410

Two computer-aided design programs are now available from Applicon, Inc., Burlington, Mass. — MATCH for filter design and ALICE for logic simulation. MATCH is unique because of its circuit optimizing feature. Both programs, which are fully debugged and fully documented, can be accessed by Teletype over telephone lines. The company estimates that the average charge for one hour of hard use of either program will be \$35 to \$40.

CIRCLE NO. 411

An alphanumeric software package has been announced by the Beta Instrument Corp., Newton Upper Falls, Mass., for its COM 600 computer output microfilm system, which converts computer data on magnetic tape to visual images on microfilm. The software package includes a fixed-length print generator feature, which allows the machine to interpret and record, on microfilm, the standard line printer tape formats of all third-generation computer systems.

CIRCLE NO. 412

Design Data from Manufacturers

Advertisements of booklets, brochures, catalogs and data sheets. To order use Reader-Service Card.
(Advertisement)

Giving general-purpose solutions to terminal-oriented real-time problems for the IBM/360 systems is a new manufactured software product from Information Storage Systems, Inc., Cupertino, Calif. According to the company, ENVIRON/1 will deliver better performance than most systems installed on an individual basis and can process the same application on a smaller central processing unit. In addition, for sequential processing, the new system is said to be 3 to 40 times faster than IBM's methods.

CIRCLE NO. 413

Price changes

Over \$2000 worth of performance features have been added to Lockheed's MAC 16 minicomputer without any increase in price. Formerly optional features now included in the basic configuration are a direct memory access channel, power fail/restart, plug-in memory expansion, a 60-Hz clock, and eight hardware priority interrupts. Pricing of the upgraded unit starts at \$11,200 with a 4k-word memory, and \$15,150 with an 8k-word memory.

CIRCLE NO. 414

Bidirectional display counters from Data Technology, Inc. are now available at reduced prices — for example, a 5-MHz counter module gives a four-decade display, with plus-and-minus indication, for just \$565.

CIRCLE NO. 415

Four top-of-the-line frequency synthesizers made by General Radio Co. now sell for \$4990 to \$7195. Models 1161, 1162, 1163 and 1164 provide seven programmable decimal digits and a continuously adjustable decade. Total frequency coverage is dc to 70 MHz.

CIRCLE NO. 416

Cable, Wire & Insulation Products Catalog



A new 35-page, fully illustrated catalog contains complete specifications for the Coleman line of cable, wire and insulation products for power, communications, military and industrial applications. Included is the new COLE-FLEX line of insulating materials, featuring irradiated shrinkable tubing. All items shown in the catalog are available from stock. Send today for your free copy.

Coleman Cable Electronic Products Division

91 Cabot Street
West Babylon, N.Y. 11704

171

Minimizing Capacitance Changes



Causes of capacitance value changes in wound dielectric capacitors are treated in an Electro Cube technical bulletin to aid designers in selecting and using capacitors. Graphs and formulas are used to illustrate the straight-forward discussion and to compare performance of various dielectrics with changes in operating and environmental conditions. Also available are bulletins treating the sometimes confusing considerations of capacitor dissipation factor and insulation resistance, as part of a continuing series of two and four page technical discussions by Fred L. Johnson.

Electro Cube, Inc.
1710 South Del Mar Avenue
San Gabriel, California 91776

172

10 Year Sleeve Bearing Life

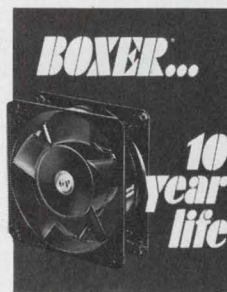

The new Grand Prix Sleeve Bearing provides — continuous lubricant circulation, positive oil retention, inherent cooling — assuring longer, more efficient operation than can be obtained from conventional designs. You will find the patented Grand Prix bearing fully described in illustrated catalog NTI, along with specifications for the complete line of G. P. equipped Boxer and MiniBoxer axial fans. Write or call today for your free copy.

IMC Magnetics Corp.
New Hampshire Division, Route 16B
Rochester, N. H. 03867 — (603) 332-5300

173

Electronic Design

ELECTRONIC DESIGN's function is:

- To aid progress in the electronics manufacturing industry by promoting good design.
- To give the electronic design engineer concepts and ideas that make his job easier and more productive.
- To provide a central source of timely electronics information.
- To promote two-way communication between manufacturer and engineer.

Want a subscription? ELECTRONIC DESIGN is sent free to qualified engineers and engineering managers doing design work, supervising design or setting standards in the United States and Western Europe. For a free subscription, use the postfree application form inside the back cover. If none is included, write to us direct for an application form.

If you do not qualify, you may take out a paid subscription for \$25 a year in the U.S.A., \$35 a year elsewhere. Single copies are \$1.50 each.

If you change your address, send us an old mailing label and your new address; there is generally a prepaid postcard for this inside the back cover. You will have to requalify to continue receiving ELECTRONIC DESIGN free.

The accuracy policy of ELECTRONIC DESIGN is:

- To make reasonable efforts to ensure the accuracy of editorial matter.
- To publish prompt corrections whenever inaccuracies are brought to our attention. Corrections appear at the end of the Letters column.
- To refuse any advertisement deemed to be misleading or fraudulent.

Microfilm copies are available of complete volumes of ELECTRONIC DESIGN at \$19.00 per volume, beginning with Volume 9, 1961. Work is now in process to complete the microfilm edition of Volumes 1-8. Reprints of individual articles may be obtained for \$2.00 each, prepaid (\$.50 for each additional copy of the same article) no matter how long the article. For further details and to place orders, contact the Customer Services Department, University Microfilms, 300 North Zeeb Road, Ann Arbor, Michigan 48106; telephone (313) 761-4700.

Want to contact us? If you have any comments or wish to submit a manuscript or article outline, address your correspondence to:

Editor
ELECTRONIC DESIGN,
850 Third Avenue,
New York, N.Y. 10022.

Design Data from

Mini-Computer Mated with Real-Time Analyzer for Automatic Testing

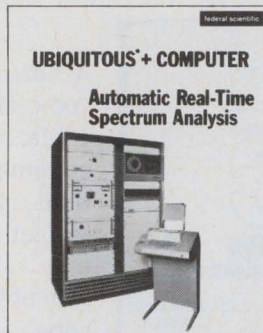

Federal Scientific Corporation
a subsidiary of Elgin National Industries, Inc.
615 West 131st Street, New York, N. Y. 10027.

174

Complete Spectrum Processing System SP-6-1 automatically scales, equalizes, processes underwater acoustic data and noise/vibration signatures for production testing. Monitors on-line signals (nuclear reactor noise, heart sounds, machine tool vibration), recognizes aberrations, gives alarm. Setup conditions are entered via teletype unit as requested by computer. System prints out all spectral data or only frequency amplitude above preset levels. Data also pre-recordable on tape, played back often faster than real time. Analysis over frequency bands as wide as 40 kHz are possible. Many options.

Now 5V/20A Power Supplies Fit Microcircuitry

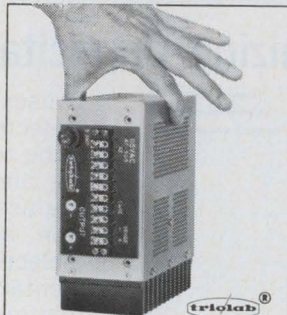

600 Series 100 Watt
Switching Regulator Power Supplies

Trio Laboratories, Inc.
80 Dupont Street
Plainview, N. Y. 11803

175

1/3 smaller (3.25"x6.50"x7.50"), 1/4 lighter (6 lbs.), cooler, more reliable than conventional 5V/20A supplies, Series 600 utilizes size-reduction advantages of the switching regulator — but eliminate its RFI (input & output meet MIL-I-6181). Single, dual, triple outputs at 3VDC to 30VDC; efficiencies 65-90%. Continuously deliver full regulated power at -20° to 71°C without derating, heat sinking, air cooling; maintain full-load storage for 30MSEC after AC power dropout. Also: IC regulating amplifier, automatic overvoltage crowbar, self-resetting automatic overload, short-circuit protection, remote sensing, mountability on 3 sides. \$400 ea. Imm. del.

FUNDAMENTALS OF INTEGRATED CIRCUITS

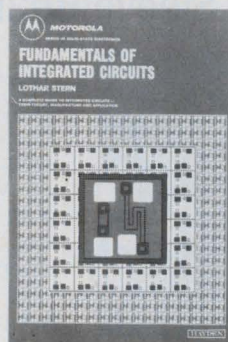

A practical guide to integrated circuits, their theory, manufacture, and applications. This new guide by Lothar Stern offers complete, highly readable coverage of the various techniques of circuit fabrication, and their effect on circuit design and performance. As to marketing considerations, it compares the characteristics of the numerous IC structures devised to date in terms of economics and logistics. A volume in the **Motorola Series in Solid-State Electronics**. 198 pages, 7 x 10, illustrated. \$8.95, clothbound. Circle the reader-service number below for 15-day examination copies.

Hayden Book Company, Inc.
116 West 14th Street
New York, N.Y. 10011

176

Manufacturers

Advertisements of booklets, brochures, catalogs and data sheets. To order use Reader-ServiceCard.
(Advertisement)

DRAFTING AIDS CATALOG



Send today for the By-Buk Printed Circuit Drafting Aids P-45 Catalog featuring the most comprehensive listings of basic pressure sensitive printed circuit drafting shapes, tapes and aids. Contains thousands of pads, tees, elbows, corners, donuts, connectors, fillets, colored tapes, multipads for dual in-lines, flat packs, TO cans and more. Here is your guide to better printed circuit drafting. Scores of ideas to speed master artwork preparation time and reduce drafting costs. Send for your free catalog and samples.

By-Buk Company

4326 West Pico Blvd., Los Angeles, Calif. 90019
Phone: (213) 937-3511

177

Bus Bars For Noise Reduction

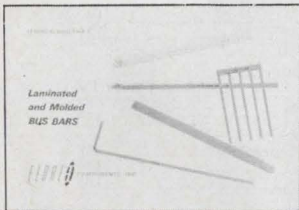

A 16 page Technical Bulletin is now available, describing a new concept in power or signal distribution. Basic mechanical and electrical design principles, along with descriptive pictures and diagrams, are included in this bulletin. These compact buses can replace bulky cable harnesses and repetitive wiring for computer or modular application. This method of construction satisfies the demanding requirements of low inductance and resistance of high speed, solid state systems, while controlling electrical noises.

Send For Free Sample

Eldre Components, Inc.

1239 University Avenue
Rochester, New York 14607

178

Free — New Alvin Template Catalog



A must for every electronic engineer and draftsman! The comprehensive 36 page Alvin catalog clearly illustrates and describes over 400 templates for practically every use. This template catalog is categorized in sections and shows the templates used for each field, ie, electrical and electronic symbol templates, mechanical engineering templates and many others. Alvin's precision made, time-saving templates cover completely the needs of draftsmen and engineers in all categories. Send for free catalog now.

ALVIN & CO., INC.

611 Palisado Avenue
Windsor, Connecticut 06095

179

Electronic Design

Advertising Sales Staff

Keith Aldrich
Sales Manager

New York 10022

Robert W. Gascoigne
Thomas P. Barth
Samuel M. Deitch
850 Third Avenue
(212) Plaza 1-5530
TWX: 867-7866

Philadelphia 19066

William C. Repetto
P. O. Box 206
Merion Station, Pa.
(215) MA-3-5888

Boston 01945

Joseph F. Palmer
14 Peter Hobart Drive
Hingham, Mass.
(617) 742-0252

Chicago 60611

Thomas P. Kavooras
Berry Conner, Jr.
200 East Ontario
(312) 337-0588

Cleveland

Thomas P. Kavooras
(Chicago)
(312) 337-0588
(call collect)

Los Angeles 90303

Stanley I. Ehrenclou
W. James Bischof
2930 Imperial Highway
Inglewood, Calif.
(213) 757-0183

San Francisco 94022

Arthur R. Shields, Jr.
95 Main Street
Los Altos, Calif.
(415) 941-3084

London W. 1

For United Kingdom and Holland
Brayton C. Nichols
44 Conduit Street
Tel: REGent 4714

Verviers, Belgium

For Continental Europe
Andre Jamar
1, Rue Mallar, 1
(087) 253.83 Telex 41563

Tokyo

Haruki Hirayama
Electronic Media Service
5th Floor, Lila Bldg.
6-8-14, Roppongi,
Minato-ku
Phone: 402-4556
Cable: Electronicmedia, Tokyo



The next time postal service breaks down, it's your fault.

In 1966, the Chicago Post Office ground to a halt. For three weeks, the mail was almost at a standstill.

If you want that to happen in your town, just wait.

Today's U.S. Post Office is probably the most inefficient, most antiquated big business in the United States. Unless something is done right now—by people like you—the situation is going to get worse.

Are you interested in straightening out the mess?

Right now, there's a bill before a committee of Congress called HR 11750. HR 11750 is, in brief, the recommendations of a bipartisan committee for the reorganization of the U.S. Post Office on a business like basis (along the lines of TVA). HR 11750 is designed to take the Post Office out of politics, to apply modern business methods to its operation and, in the process, to save taxpayers the \$1,200,000,000 annual deficit that today's horse-and-buggy Post Office incurs.

You can help get HR 11750 out of committee and enacted into law by letting your congressman know how you feel. Tear out this column, pin it to your letterhead and mail it to your congressman today. Let your voice be heard.

If the Post Office in your city breaks down next, you can't say you haven't been warned.

Citizens Committee for Postal Reform

1725 Eye Street, N.W., Washington, D.C. 20006
Lawrence F. O'Brien/Thruston B. Morton
National Co. Chairmen

Advertisers' Index

Advertiser	Page	Advertiser	Page
ACDC Electronics, Inc.	64 A-B	Jewell Electrical Instruments Inc.	139
AMF, Alexandria	168	Keithley Instruments, Inc.	165
AMF Incorporated		Kepco, Inc.	102
Potter & Brumfield Division	117	Laser Diode Laboratories, Inc.	62
Abbott Transistor Laboratories		Leach Corporation	48A-B
Incorporated	13	Lorlin Industries, Inc.	151
Acopian Corporation	47	McLean Engineering Laboratories	145
Advanced Micro Devices, Inc.	4, 5	Macrodata Company	53
Aerotronics Associates, Inc.	150	Magnecraft Electric Co.	100
Aeroflex Laboratories, Incorporated	157	Mallory & Co., Inc., P. R.	123
AirBorn, Inc.	58	Microsonics, Inc.	169
Alvin & Co., Inc.	173	Monsanto Company	Cover III
Allen-Bradley Co.	23	Motorola Semiconductor Products, Inc.	32A-H
Amperex Electronic Corporation	128	National Cash Register Company, The	65
Amphenol, The Bunker-Ramo Corporation	24	National Semiconductor Corporation	76, 77
Analogic Company	163	Oak Electro/Netrics Corp.	147
Aritech Corp.	147	Optical Electronics, Inc.	136
Astro Communication Laboratory, Inc.	164	Owens-Illinois Electronic Materials	119
Astro Space Laboratories, Inc.	147	Philco-Ford Corporation Microelectronics	
Augat, Inc.	154	Division	8, 9
Automatic Electric Company	10, 11	Piezo Technology, Inc.	132
Beckman Instruments, Inc., Helipot Division		Potter & Brumfield, Division of	
Bodine Electric Company	17	AMF Incorporated	117
Boonton Electronics Corporation	152	Power/Mate Corp.	111
Buckbee Mears Company	90	RCA Electronic Components	
Bulova Servo Products, Electronics		and Devices	Cover IV
Division of Bulova Watch Company	141	Radiation, Incorporated	83
By-Buk Company	173	Raytheon Computer	135
C-Cor Electronics, Inc.	156	Raytheon Company Special	
California Instruments Company	60	Microwave Devices Operation	158
Cambridge Thermionic Corporation	62	Redcor Corporation	137
Celanese Plastics Company	97	Relcom	166
Cinch Nu-line, A Division of		Siliconix Incorporated	85
TRW, Inc.	Cover II	Simpson Electric Company	133, 149
Clare & Co., C. P.	127	Singer-General Precision, Inc.	
Clairex Electronics, A Division of		Kearfoot Division	140
Clairex Corporation	121	Sperry Gyroscope Division	59
Coleman Cable Electronic Products		Sprague Electric Company	18
Division	171	Standard Condenser Corporation	33
Computer Labs	56	Switchcraft, Inc.	12
Computer Microtechnology, Inc.	80	Sylvania Electronic Components	
Control Products Division, Bell & Howell	105	Semiconductor Division	72, 73
Cutler-Hammer	43	TRW Semiconductor Division of	
Dale Electronics, Inc.	35	TRW, Inc.	115
Delta Products, Inc.	146	Technical Wire Products, Inc.	167
Deutsch Relay Division	144	Technology Communications	64
Digital General Corporation	148	Tektronix, Inc.	2
Douglas Randall, Inc.	157	Teletype Corporation	36, 37
ENM Company	167	Tenney Engineering, Inc.	153
Eastman Kodak Company	101	Teradyne	20
Eldre Components, Inc.	173	Texas Instruments Incorporated,	
Electro Cube, Inc.	159, 171	Components Group	27
Electronic Design	175	Transco Products, Inc.	150
Electronic Memories, Inc.	49	Trio Laboratories, Inc.	172
English Electric Valve Co., Ltd.	160A	Triplet Corporation	95
Engelhard Industries Division,		Trygon Power Supplies	111
Engelhard Minerals & Chemicals		Tung Sol Division, Wagner	
Corporation	153	Electric Corporation	54
Erie Technological Products, Inc.	39	U. S. Capacitor Corporation	66
Fairchild Semiconductor, A Division		Union Carbide Corporation	71
Fairchild Camera and Instrument		Unitrode Corporation	29
Corporation	6, 7	Vector Electronic Company Inc.	160
Federal Scientific Corp.	172	Victor Electric Wire & Cable Corp.	58
Fluke Mfg. Co., Inc., John	55	Vitramon, Incorporated	48
General Automation, Inc.	63	Watkins-Johnson	84
General Electric Company	14, 15	Weston Instruments, Inc.	131
General Electric Company,		Winchester Electronics, Division of	
Semiconductor Products Department	142, 143	Litton Industries	57
General Radio Company	40	Xerox Data Systems	113
Grant Pulley & Hardware Co.	16	Zenith Radio Corporation	154
Grayhill, Inc.	153	<i>Career Advertising:</i>	
Hansen Mfg. Co., Inc.	46	National Cash Register Company, The	65
Hayden Book Company, Inc.	160B		
Hewlett-Packard	1, 44, 45, 52, 81		
Hi-G, Incorporated	108, 109		
Honeywell, Inc.	160		
Honeywell Test Instrument Division	91		
IMC Magnetics Corporation	161, 171		
IRC, Division of TRW, Inc.	99		
ITT Electron Tube Division	50, 51		
Ingersoll Products, A Division of			
Borg Warner Corporation	61		
Inland Controls, A Division of Kollmorgen	167		
Intech, Incorporated	125		
International Electronic Research			
Corporation	38		
Intronics, Incorporated	31		

now you can reach
more engineers
and reach them
faster...

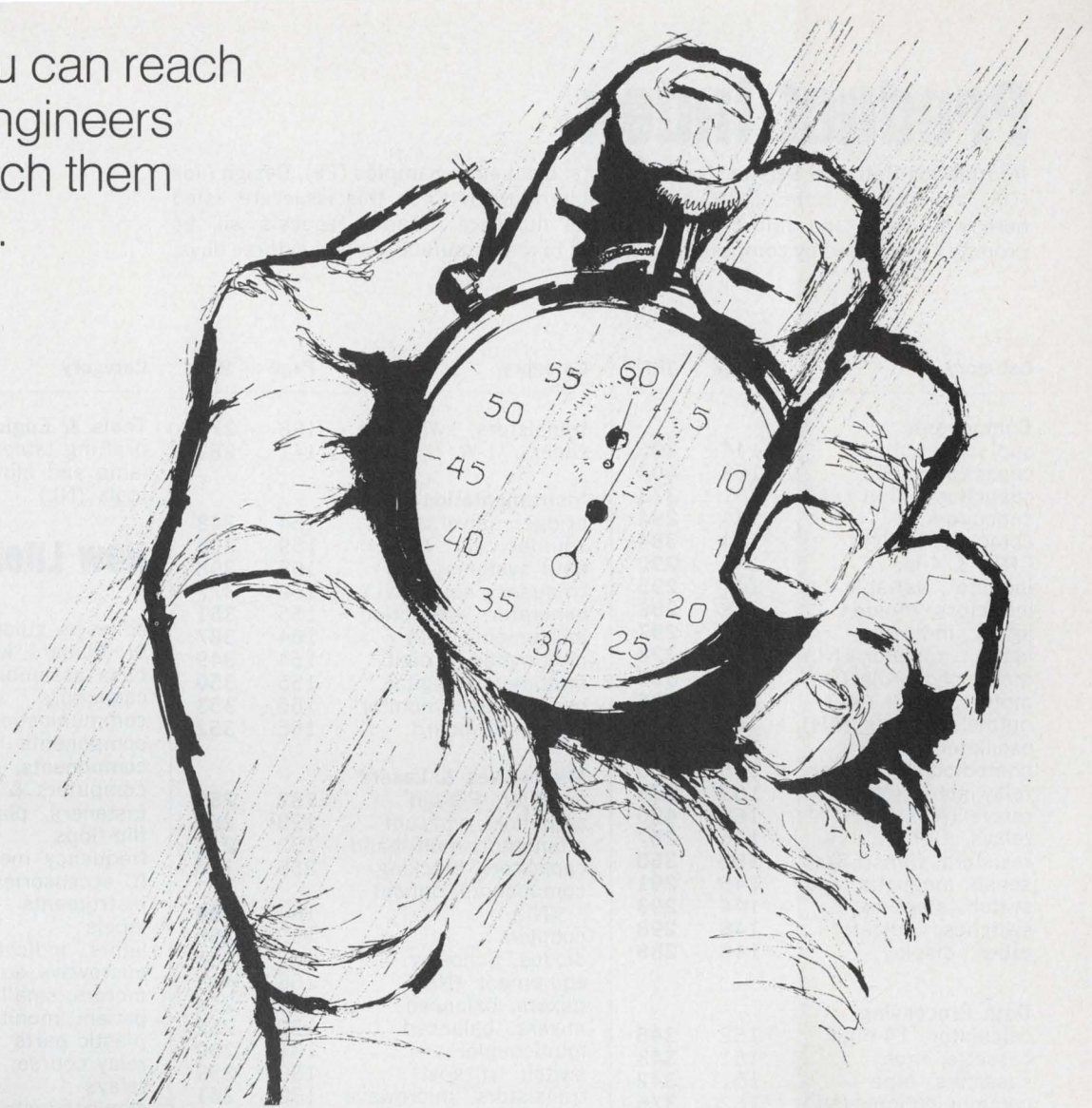

Electronic Design's *NEW*

FAST CLOSE FORM

Marketing and salespeople can't specify your products . . . engineers *can*. Products don't move through distributors until they are specified by engineers. Now there's a way to reach *more** EOEM engineers and reach them *faster*. It's Electronic Design's new FAST CLOSE FORM—right up front in the News Section. You can get out your new product story, your price announcements or delivery and distribution information, quickly, while they're still hot. Closing date for film positives is only *24 hours before press time* . . . *48 hours before the issue mails*. You save 3 full weeks over normal closing. The form will accept full pages or spreads in b&w or 2-color; premium is only \$150 per insertion. Call your Electronic Design representative today for complete information.

*Electronic Design has 72,271 EOEM engineers and engineering managers—53,372 more than Electronic News . . . 37,998 more than Electronics. Source: December, 1969 BPA and ABC Publisher's Statements.

ELECTRONIC DESIGN FAST CLOSE SCHEDULE

(Post on your production bulletin board.)

ISSUE DATE	REGULAR CLOSING	FAST CLOSE		ISSUE DATE	REGULAR CLOSING	FAST CLOSE	
		ORDER IN N.Y. OFFICE	FILM POS. AT PRINTER			ORDER IN N.Y. OFFICE	FILM POS. AT PRINTER
June 7	May 4	May 22	May 25	Sept. 27	Aug. 24	Sept. 11	Sept. 14
June 21	May 18	June 5	June 8	Oct. 11	Sept. 8	Sept. 25	Sept. 28
July 5	June 1	June 19	June 22	Oct. 25	Sept. 21	Oct. 9	Oct. 12
July 19	June 15	July 3	July 6	Nov. 8	Oct. 5	Oct. 23	Oct. 26
Aug. 2	June 29	July 17	July 20	Nov. 22	Oct. 19	Nov. 6	Nov. 9
Aug. 16	July 13	July 31	Aug. 3	Dec. 6	Nov. 2	Nov. 20	Nov. 23
Sept. 1	July 27	Aug. 14	Aug. 17	Dec. 20	Nov. 16	Dec. 4	Dec. 7
Sept. 13	Aug. 10	Aug. 28	Aug. 31				

Product Index

Information Retrieval Service. New Products, Evaluation Samples (ES), Design Aids (DA), Application Notes (AN), and New Literature (NL) in this issue are listed here with page and Information Retrieval numbers. Reader requests will be promptly processed by computer and mailed to the manufacturer within three days.

Category	Page	IRN	Category	Page	IRN	Category	Page	IRN
Components			transistors, switching	138	278	Tools & Engineering Aids		
cap, pushbutton	144	296	zeners, 1-W	141	283	drafting table	157	358
capacitors (NL)	168	404	Instrumentation			lamp and blower	157	359
capacitors, chip (AN)	161	373	bridge, universal ac	154	348	tools (NL)	162	382
capacitors, PC	144	294	counter chart (DA)	159	366	New Literature		
components (NL)	164	384	data systems (NL)	168	398	adhesive guide	162	383
CRT, 3/4-in.	146	290	frequency notes (NL)	162	377	breadboard kits	162	375
inductor, variable	144	295	generator, 4-function	155	351	buss assemblies	166	394
inductors, molded	148	298	instruments (NL)	164	387	capacitors	168	404
lights, indicator	148	297	multimeter, 4-digit	154	349	communications	162	376
lights, indicator (NL)	162	378	multimeter, digital	155	350	components	164	384
motor slide rule (DA)	159	368	oscilloscope, monitor	155	353	components, optical	164	388
motors, small (NL)	166	396	tester, PC-board	155	352	computers & converters	168	399
opto-electronics (AN)	161	374	Microwaves & Lasers			fasteners, plastic	166	393
oscillator	145	292	amplifier, P-band	132	259	flip-flops	162	381
photodiode/amplifier	146	289	amplifiers, vhf/uhf	129	250	frequency measurement	162	377
relay notes (NL)	162	376	attenuator, multi-band	132	257	IC accessories	168	402
relays (NL)	168	400	capacitors, blocking	255	130	instruments	164	387
relays, DIP	146	287	components, optical (NL)	164	388	labels	166	392
resistors, film (ES)	158	360	couplers	132	256	lights, indicator	162	378
sensor magnetic tape	145	291	diodes, Schottky	132	258	microwave equipment	168	403
switch, stepping	144	293	equipment (NL)	168	403	motors, small	166	396
switches, indicator	148	298	mixers, balanced	130	254	patient monitoring	166	397
tubes, display	146	288	mixers, balanced	130	252	plastic parts	164	385
Data Processing			multicoupler	132	260	relay course	162	376
calculator, 14-digit	152	346	switch, rf spst	130	253	relays	168	400
cassette, tape	151	343	transistors, microwave	130	251	semiconductors	164	389
cassettes, tape	151	342	Modules & Subassemblies			semiconductors	165	390
communications (NL)	162	376	amplifier, current	134	265	shipping tips	166	395
computer, console	141	340	amplifiers (AN)	160	370	software, CAD	165	391
computers (NL)	168	399	clocks, digital	134	263	software, validator	162	380
coupler, telephone	152	347	decoder, driver	133	262	tools	162	382
keyboard system	152	345	display, graphical	136	271	Application Notes		
memories, disc	150	339	driver, quad	134	269	amplifiers, differential	160	370
memory, core	150	337	gain control, vhf	134	268	capacitors, chip	161	373
memory, read-only	150	338	op amps, electrometer	134	264	opto-electronics	161	374
minicomputer	152	344	op amps, FET	133	261	power-supply lines	160	372
minicomputer, 16-bit	149	335	plastic parts (NL)	164	385	power-supply lines (AN)	160	372
software, CAD (NL)	165	391	power supply	134	266	switch, diode	134	267
software, validator (NL)	162	380	power-supply lines (AN)	160	372	video sequencer	136	270
terminal, computer	151	341	switch, diode	134	267	Packaging & Materials		
terminal, display	149	336	video sequencer	136	270	adhesives guide (NL)	162	383
ICs & Semiconductors			adhesives guide (NL)	162	383	breadboard kits (NL)	162	375
adder, four-bit	141	282	buss assemblies (NL)	166	394	buss assemblies (NL)	166	394
detector, IC	140	280	cabinets, shielded	156	356	cabinets, shielded	156	356
drivers, clock	138	276	connector, PC (ES)	158	363	connector, PC (ES)	158	363
flip-flops (NL)	162	381	connectors (DA)	159	365	connectors (DA)	159	365
IC accessories (NL)	168	402	fasteners, plastic (NL)	166	393	fasteners, plastic (NL)	166	393
ICs, TTL beam-lead	137	272	fiber-optic guides	156	355	fiber-optic guides	156	355
LED, infrared	142	285	foams chart (DA)	159	369	foams chart (DA)	159	369
MOSFETS,			gasketing	156	357	gasketing	156	357
complementary	138	279	glass strips (ES)	158	362	glass strips (ES)	158	362
op amp, compensated	138	277	labels (ES)	158	364	labels (ES)	158	364
op amps, compensated	138	275	labels (NL)	166	392	labels (NL)	166	392
photo-SCR pair	141	284	plastic parts (NL)	164	385	plastic parts (NL)	164	385
SCRs, plastic	140	281	sealing compound	156	354	sealing compound	156	354
semiconductors (DA)	159	367	shipping tips (NL)	166	395	shipping tips (NL)	166	395
semiconductors (NL)	164	389	wires (ES)	158	361	wires (ES)	158	361
semiconductors (NL)	165	390	Design Aids			connector selector	159	365
shift registers	138	273	connector selector	159	365	counter chart	159	366
thyristors (AN)	160	371	counter chart	159	366	foams chart	159	369
transistors, power	142	286	foams chart	159	369	motor slide rule	159	368
			motor slide rule	159	368	semiconductor guide	159	367
			semiconductor guide	159	367	Evaluation Samples		
			Evaluation Samples			connector, PC	158	363
			connector, PC	158	363	glass strips	158	362
			glass strips	158	362	labels	158	364
			labels	158	364	resistors, thick-film	158	360
			resistors, thick-film	158	360	wires	158	361
			wires	158	361			



**No matter how you look at it,
this new counter gives you the most performance
at the lowest cost of usership.**

The initial cost of the 110B—low as it is—is only half the story. It's the total cost of usership over the life of the instrument that determines the true performance value. With over 60% MSI construction for the ultimate in reliability, extensive use of plug-in IC's, wide-open, clean internal layout for optimum serviceability (and minimum downtime),

plus the no-nonsense Monsanto 2-year warranty, the Model 110B sets new records in low cost of usership.

OK, how about performance? ... Glad you asked. Here are just six of the features available in the Model 110B Counter/Timer—

1. Frequency range: 0 to 150 MHz
2. Pulse pair resolution: < 7 nsec

3. TTL Logic
4. BCD output (TTL compatible)
5. All functions programmable
6. Human factors engineering inside and out for maximum convenience

Prices begin at \$1285. Write for technical details. Monsanto Electronic Instruments, 600 Passaic Ave., West Caldwell, New Jersey 07006.

The new RCA-TA7493 for 12-V service.

It's moisture-proof for reliable
2-way communications.

TA7493 is a high-power, low-voltage
RCA "overlay" transistor with emitter ballasting.
A completely hermetic, ceramic-metal package
prevents moisture contamination and
assures long-life performance.

It is ideally suited for VHF mobile
and marine transmitters.

The TA7493 offers a 25-watt (min.)
output at 175MHz. It features
low-inductance radial leads
(electrically isolated from the stud),
making this silicon device particularly
useful for stripline circuits.

It has been life-tested at full-rated output
to provide you with the most reliable transistor of
its kind: the dry transistor from RCA.

For more information, see your local

RCA Representative or your RCA Distributor.

For technical data, write RCA Electronic Components,
Commercial Engineering,* Harrison, N. J. 07029.

In Europe: RCA International Marketing S.A.,
2-4 rue du Lièvre, 1227 Geneva, Switzerland.

RCA

The Dry Transistor

