

**BUSCON PREVIEW: A PLETHORA OF BUS PRODUCTS  
AVOID DESIGN PITFALLS WITH PLDs**

FOR ENGINEERS AND ENGINEERING MANAGERS — WORLDWIDE

# ELECTRONIC DESIGN

A PENTON PUBLICATION U.S. \$5.00

OCTOBER 11, 1990

SECURITY • DISKLESS WORKSTATION •  
DATA-ACQUISITION CONTROL • MEDICAL  
NETWORK SERVERS • TELECOMMUNICATIONS  
PORTABLE INSTRUMENTS • PROTOCOL CONVERTERS

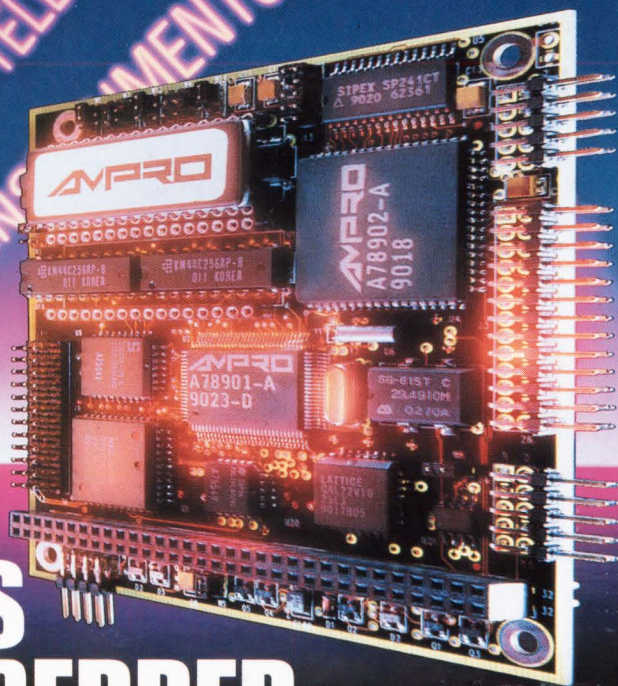

## MINIMODULES BROADEN EMBEDDED USES OF PCs

• **PRODUCT REPORT: PLD TOOLS KEEP PACE WITH DEVICES**

**QUICKLOOK**  
PAGE 97

# Go ahead ... add 5 psec

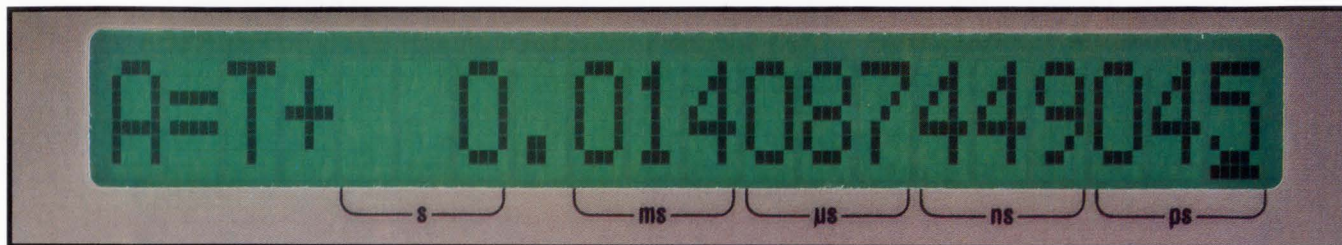

## Picoseconds are no problem for the DG535 Precision Pulse & Delay Generator.

The DG535 provides 4 edge (delay) and 2 pulse (delay and width) outputs, all with 5 ps resolution, 1000 sec range, 50 ps rms jitter, and adjustable output levels. The outputs drive 50 Ohms or high impedances to 4 Volts with a slew rate of 1 V/ns - just right for driving TTL or ECL or even high speed analog circuits. Throw in the 35 Volt output option and you can trigger almost anything. For even greater accuracy and stability, add the 1 ppm optional timebase .

Top it off with the intelligent menu-based front panel and standard GPIB interface, and the DG535 is probably the most versatile timing generator you can find.

On the bench or in a test environment, the DG535 has the accuracy, stability, precision, and reliability you need to solve your tough timing problems - all at a price you can afford. Call SRS for more information on the DG535, even if you don't need picosecond resolution.



### DG535

**\$3500**

- 4 delay, 2 pulse channels
- 5 ps delay resolution
- 50 ps rms jitter from trigger
- Adjustable output levels to 4 Volts
- 0 to 1000 sec delay range
- Internal/external trigger to 1 MHz
- Internal/external timebase
- 9 location set-up memory
- GPIB interface standard
- $\pm 35$  Volt output option
- 1 ppm timebase option
- 100 ps rise/fall time option



**STANFORD RESEARCH SYSTEMS**

1290 D Reamwood Avenue, Sunnyvale, CA 94089 TEL (408) 744-9040 FAX 4087449049 TLX 706891 SRS UD

# Our new LED agreement goes beyond the surface.



When it comes to surface-mount (SMT) LED indicators, Hewlett-Packard and Siemens are making a



world of difference. Through our extensive co-development efforts, we can offer you standard, multi-sourced SMT LEDs.

By combining our expertise in the optoelectronics field, we've done more than respond to your

need for a global standard. Our SMT LEDs are designed to give you performance comparable to through-hole LEDs.

To brighten your design outlook even further, our LED indicators will provide SMT manufacturing process compatibility for ease of placement and soldering. Plus, we'll offer a full range of LED colors, and light intensity that outshines all others.

Best of all, these lamps are from HP and Siemens. So you're

assured of our commitment to excellence in service, support and reliability.

Call for our free information package: **1-800-752-0900, ext. 1498**. For people like you who demand high performance SMT LEDs, two sources, and one standard, a new day is dawning.

There is a better way.



**HEWLETT  
PACKARD**

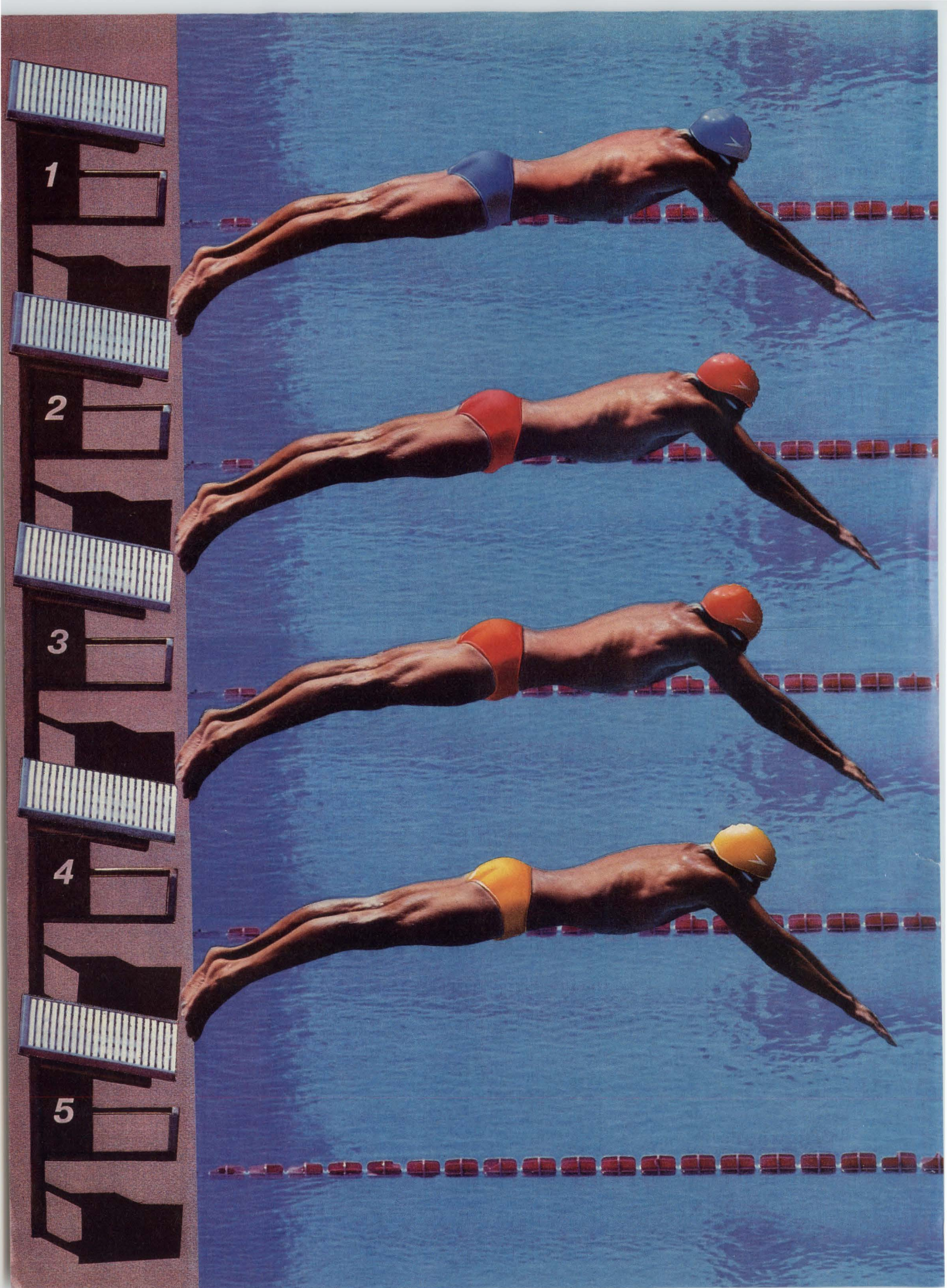

1

2

3

4

5

# A Precision Start, Every Time.

## Motorola's Low-Skew Clock Drivers for Precision Control and Timing of High Speed RISC and CISC Designs

Record setting performance for high speed processor designs depends on perfect timing, perfect control from start to finish.

If your high speed CISC or RISC processor flies off the blocks at 25MHz, 33 MHz or faster, clock signal skew from ordinary clock drivers can result in false starts for devices in close proximity. And, you may also require very exact 50% duty cycle waveforms.

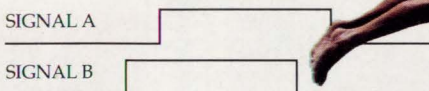

*Skew is like lining up starting blocks unevenly—nobody starts at exactly the same time.*

Either way, without precise operation, performance suffers. Worst case? You blow your race to production and the entire design could be disqualified.

### A Precision Start

To get all of your board's devices off to a precision start for critical events, Motorola's low-skew clock drivers are setting the target pace.

Offering 200% to 300% less output skew than ordinary clock drivers, typical delay skews are as low as 0.1 nS in ECL and 0.5 nS for TTL or 0.5 nS for CMOS outputs.

When you design with low-skew clock drivers, you don't need to handicap your high speed circuits with delay chips that compromise power and speed. And you can avoid trial and error tests with other high speed logic devices you had hoped would sooner or later work.

Instead, Motorola's line of low skew clock drivers let you design for optimum speed control from the beginning, with high performance dependability part-to-part and tight clock duty cycles.

### Programmable Time Delays

For really difficult timing requirements, your design can also incorporate Motorola's Programmable Time Delays. Along with Low Skews, MC10E/100E195 (20 pS steps) or 196 (80 pS steps) ECL input delays provide you with more design options when board layout dictates.

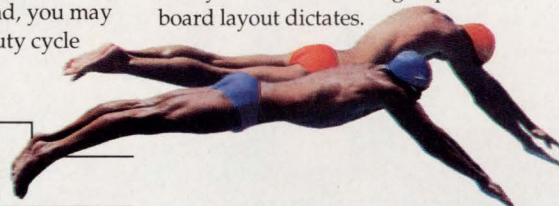

Part #	Input Levels	Output Skew (nS)	Output/Input Freq. Ratio	Max. Input Freq. (MHz)	Output Levels
F803	TTL	1	+2	70	TTL
H640	TTL or ECL	0.5	+2 and +4	135	TTL
H641	ECL	0.5	1X	100	TTL
H642	TTL or ECL	0.5	+2 and +4	135	TTL
H643	ECL	0.5	1X	100	TTL
E111	ECL	0.1	1X	1000	ECL
MC88913	TTL	1	+2	110	CMOS
MC88914	TTL	1	+2	110	CMOS
MC88915	TTL	0.5	1X, 2X, and 4X	70MHz*	CMOS

\*MC88915 is a PLL Clock Driver, therefore 70MHz is the maximum output frequency.

### CMOS Skews of 0.5-1 nS and Phase-Locked Loop Capability

For multiple synchronous outputs, the MC88913 Clock Driver (skew 1.0 nS) and MC88914 CMOS Clock Driver with Reset (1.0 nS skew) provide high speed, low power hex divide by two capability. The MC88915 Low-Skew Phase-Locked Loop Clock Driver locks output frequency and phase into the input reference clock — and can synchronize several boards. It also functions as a frequency multiplier that can double or quadruple the input frequency. Skew is 0.5 nS.

### FAST Schottky TTL Low-Skew Clock Drivers

For quad D-type flip-flop applications requiring matched propagation delays, the MC74F803 Clock Driver provides 1.0 nS skew.

### 68030/040 0.5 nS Skew ECL/TTL Clock Driver

Motorola's MC10H640 series Clock Drivers generate clock output for 68030/040 and are warranted to meet all clock specs required by these microprocessors.

### ECL Clock Driver with 9 Differential Outputs

The MC10E111 is a low-skew differential driver designed with clock distribution in mind — nine outputs and .1 nS skew.

### Full Microprocessor Support

Motorola's clock drivers support the full 68000 CISC and 88000 RISC MPU lines. They also can drive Intel CISC and RISC MPUs, AMD, SPARC, MIPS, and Clipper MPUs.

### Start your drive for the finish

If you want the best in clock drivers for fast processor designs, begin your drive for the finish with a perfect start. Specify Motorola Clock Drivers to win at any pace.

To get off the blocks fast, call toll free for more information: 1-800-521-6274. Or, fill out and return the coupon below.



**MOTOROLA**



To: Motorola Literature Distribution Center, P.O. Box 20912, Phoenix, AZ 85036.  
Send me more information about Motorola Clock Drivers. 449ED101190

Name \_\_\_\_\_

Title \_\_\_\_\_

Company \_\_\_\_\_

Address \_\_\_\_\_

City \_\_\_\_\_ State \_\_\_\_\_ ZIP \_\_\_\_\_

Phone ( ) \_\_\_\_\_

# ELECTRONIC DESIGN

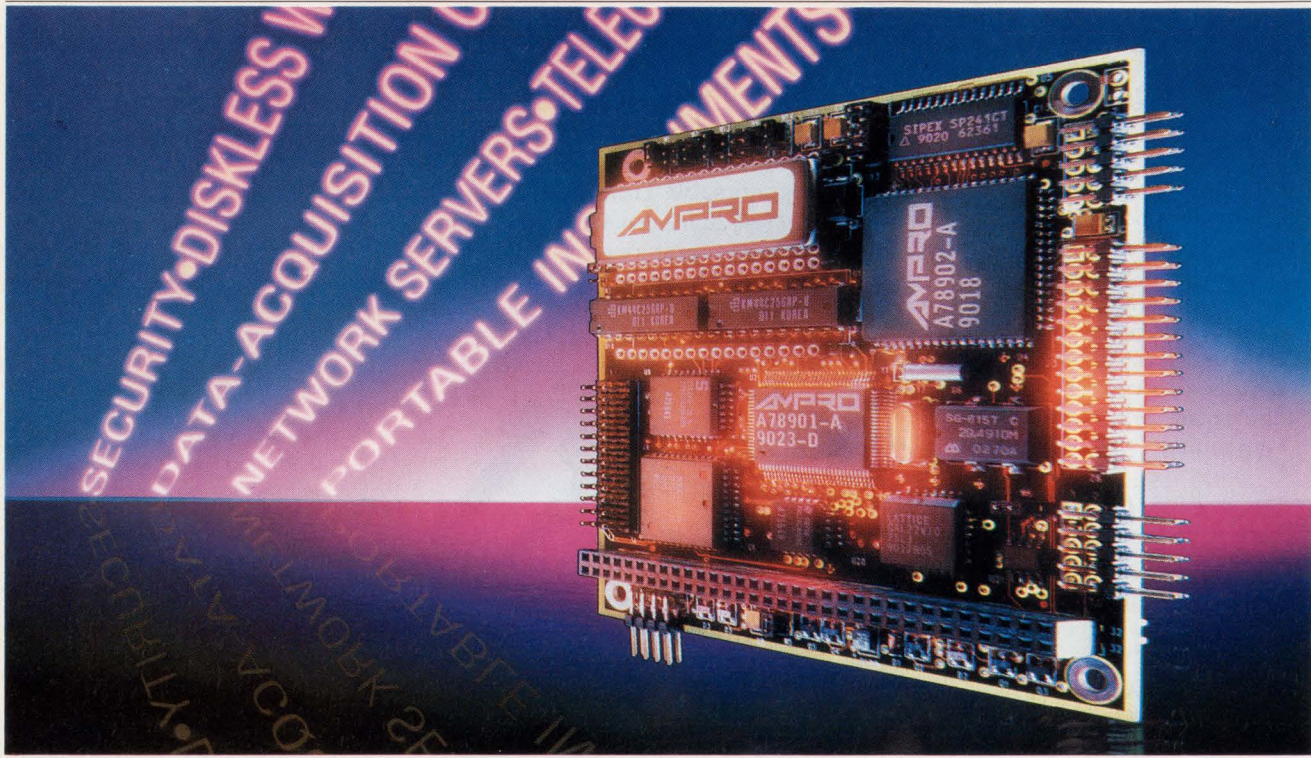

**TECHNOLOGY ANALYSIS** **39 BUSCON PREVIEW: MORE POWERFUL BOARDS COMING**  
VME 64, STD 32, Multibus I and II, and Futurebus+ board makers emphasize "total" solutions.

**COVER FEATURE** **49 TINY MODULES FORM COMPLETE EMBEDDED PCS**  
Modules can be pieced together for different configurations, up to 386SX.

**PRODUCT REPORT** **55 PLD DESIGN TOOLS MATURE**  
Better features and interfaces help design tools keep pace with complex PLDs and FPGAs.

**PRODUCT REPORT INNOVATION** **71 RISC CPU MODULE PACKS ALL LOGIC**  
A 3.5-by-3.5-in. RISC-CPU module gives designers a complete Mips processor with cache and floating point.

**DESIGN APPLICATIONS** **75 AVOID DESIGN PITFALLS WHEN WORKING WITH PLDS**  
Programmable logic devices give a big boost to system integration, but certain design practices must be followed.

**81 UNDERSTAND EISA BUS-CYCLE TRANSLATIONS**  
Create flexible EISA-based systems by matching 8-, 16-, or 32-bit expansion cards to the bus.

**PRODUCT INNOVATIONS** **117 PC CHIP SET EASES DESIGN OF CACHE-BASED COMPUTERS**  
An on-board cache controller and tag RAM ease system timing requirements.

**121 FIVE LOW-COST 10-BIT ADCS CONVERT IN UNDER 2.5  $\mu$ S**  
A quintet of 10-bit ADC ICs sample and convert 5-V waveforms in 0.5 to 2.5  $\mu$ s maximum, with Nyquist rates reaching 300 kHz.

## 14 EDITORIAL

### 16 TECHNOLOGY BRIEFING

A look ahead at TAB in the 1990s

### 23 TECHNOLOGY NEWSLETTER

- Disk-drive group forges test standards
- Automotive systems meet silicon
- Workgroup computing gains Sparc platform
- Superscalar support group sets standards
- RISC CPUs span high- to low-end system needs
- Image processing card enhances NeXt computer
- Bipolar silicon keeps chasing GaAs FETs

### 31 TECHNOLOGY ADVANCES

- Development tool simulates complex ICs very fast
- IC promises more compact, reliable ATE
- Mixing gold and aluminum bond wires on power ICs cuts cost and up's reliability

## 97 QUICK LOOK

### 103 PEASE PORRIDGE

What's all this noise stuff, anyhow? (Part II)

### 109 IDEAS FOR DESIGN

- Connect ADC to PC's I/O port
- Tune bandpass filters to 0.1% accuracy
- Window comparator tracks voltage

### 125 SALARY SURVEY

### NEW PRODUCTS

#### 131 Instruments

Custom ICs shrink a 1-GHz scope to a portable, affordable size

#### 134 Software

#### 143 Digital ICs

#### 145 Packaging & Production

#### 147 Analog

### 153 INDEX OF ADVERTISERS

### 155 READER SERVICE CARD

## COMING NEXT ISSUE

- Special Report: The cutting edge of mixed-signal simulation tools
- Product Report: The latest on logic-analyzer offerings
- A preview of Electronica 90 in Germany
- Op-amp macromodels that mimic real parts
- A highly integrated RISC CPU with I/O and cache circuitry
- Top-down designs made easier with process-independent CAE tools
- Plus regular features:  
Ideas for Design  
Quick Look  
Technology Advances



Certificate of Merit  
Winner, 1988  
Jesse H. Neal Editorial  
Achievement Awards

Cover photo: Jook Leung

ELECTRONIC DESIGN (USPS 172-080; ISSN 0013-4872) is published semi monthly by Penton Publishing Inc., 1100 Superior Ave., Cleveland, OH 44114. Paid rates for a one year subscription are as follows: \$75 U.S., \$140 Canada, \$230 International. Second-class postage paid at Cleveland, OH, and additional mailing offices. Editorial and advertising addresses: ELECTRONIC DESIGN, 611 Route #46 West, Hasbrouck Heights, NJ 07604. Telephone (201) 393-6060. Facsimile (201) 393-0204.

Printed in U.S.A. Title registered in U.S. Patent Office. Copyright © 1990 by Penton Publishing Inc. All rights reserved. The contents of this publication may not be reproduced in whole or in part without the consent of the copyright owner.

Permission is granted to users registered with the Copyright Clearance Center Inc. (CCC) to photocopy any article, with the exception of those for which separate copyright ownership is indicated on the first page of the article, provided that a base fee of \$1 per copy of the article plus \$.50 per page is paid directly to the CCC, 27 Congress St., Salem, MA 01970 (Code No. 0013-4872/90 \$1.00 + .50). Copying done for other than personal or internal reference use without the express permission of Penton Publishing, Inc. is prohibited. Requests for special permission or bulk orders should be addressed to the editor.

For subscriber change of address and subscription inquiries, call (216) 696-7000.

POSTMASTER: Please send change of address to ELECTRONIC DESIGN, Penton Publishing Inc., 1100 Superior Ave., Cleveland, OH 44114.

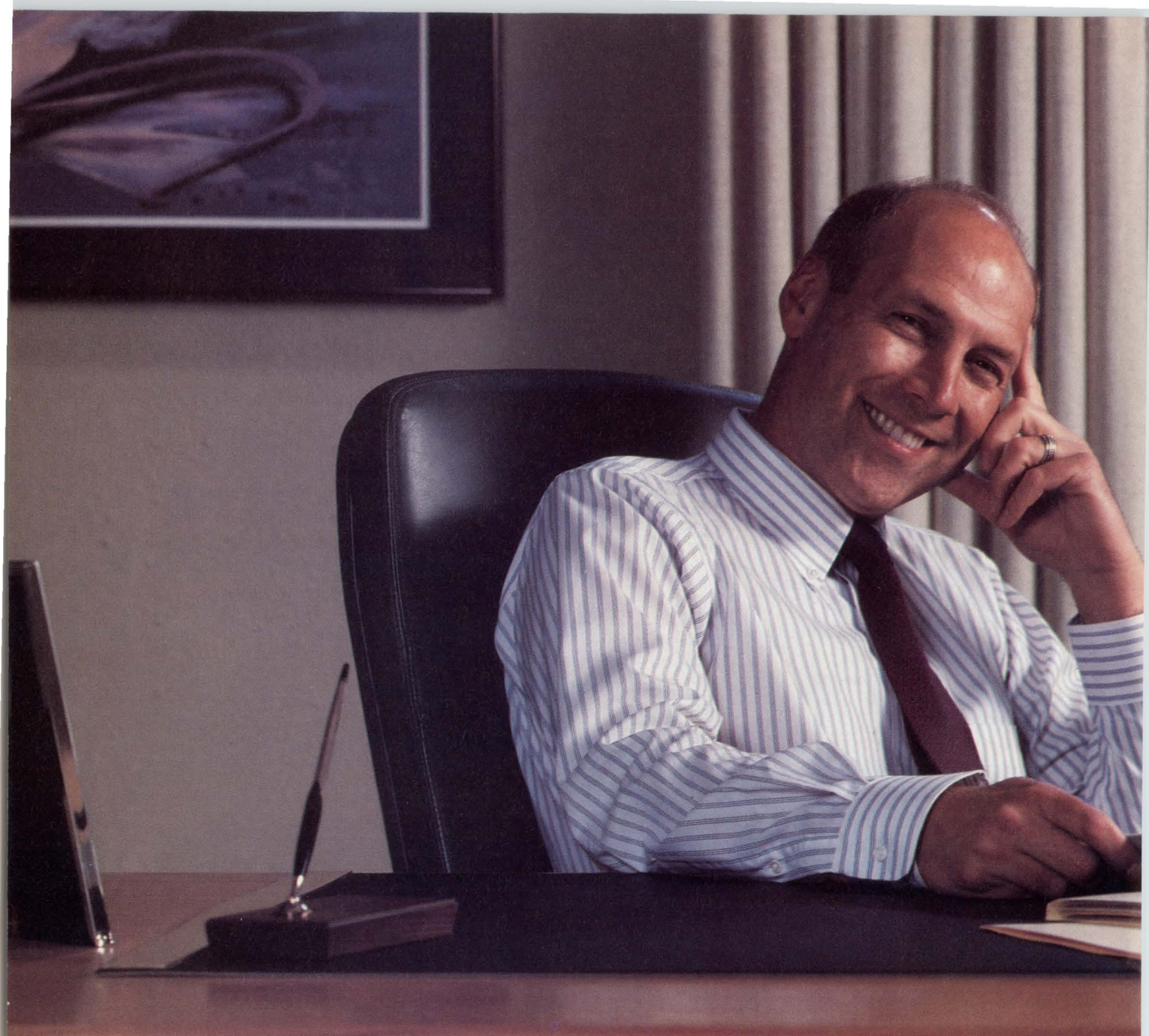

# THIS MAN MANAGES MULTIPLE DESIGN DISCIPLINE DEADLINES THAT COULD KILL

The dilemma rears its ugly head time and time again. Do the impossible. By tomorrow. Worse yet, do it with an intimidating hodge-podge of design automation tools and data formats. And while you're at it, make sure all these tools and data play together freely and efficiently. No problem. Right?

To avoid this kind of chaos, you need to consider a fundamental change in your engineering strategy. Which is why we now offer you our Concurrent Design Environment.™

Simply put, the Concurrent Design Environment allows tools from virtually any source to work together.

Within it, our new Falcon Framework™ lets you assemble precisely the design automation environment your situation requires — without sacrificing the considerable benefits of integration. And our OpenDoor™ program ensures that your choice of tools includes the best the entire industry has to offer.





# ES 125 ENGINEERS, ES, DISPARATE TOOLS AND L. SO WHY IS HE SMILING?

The Concurrent Design Environment also includes engineering management tools of unprecedented scope and power. Like our Decision Support System, which automatically monitors any aspect of the design process you care to specify. So you spot and correct little problems long before they grow into big ones.

No matter how tight your deadlines, no matter how large your engineering teams, our Concurrent Design Environment will keep you ahead of the game. Which, after all, is a very nice place to be. For a free videotape, call **1-800-547-7390**.

 **Mentor  
Graphics®**  
Changing The Way The World Designs. Together.

# HOW TO MAKE ANY DRIVE BE DIGITALLY PRECISE.

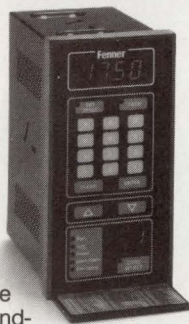

Pick a drive. AC, DC, servo or clutch. The M-Trim Universal Digital Speed Controller can replace its speed pot, giving you stand-alone accuracy within 0.01%. With zero error in the follower mode. Even more complex, multi-motor systems can be coordinated with the M-Trim.

Diagnostics are as easy as dialing a telephone. And M-Trim's RS-422 port and direct-access programming can link with your application's computers. Call 1 800 FIC-4411. Or write: Fenner, 8900 Zachary Lane North, P.O. Box 9000, Maple Grove, MN 55369. Fax: 612 424-8734.

## Fenner

©1989 Fenner Industrial Controls

CIRCLE 7

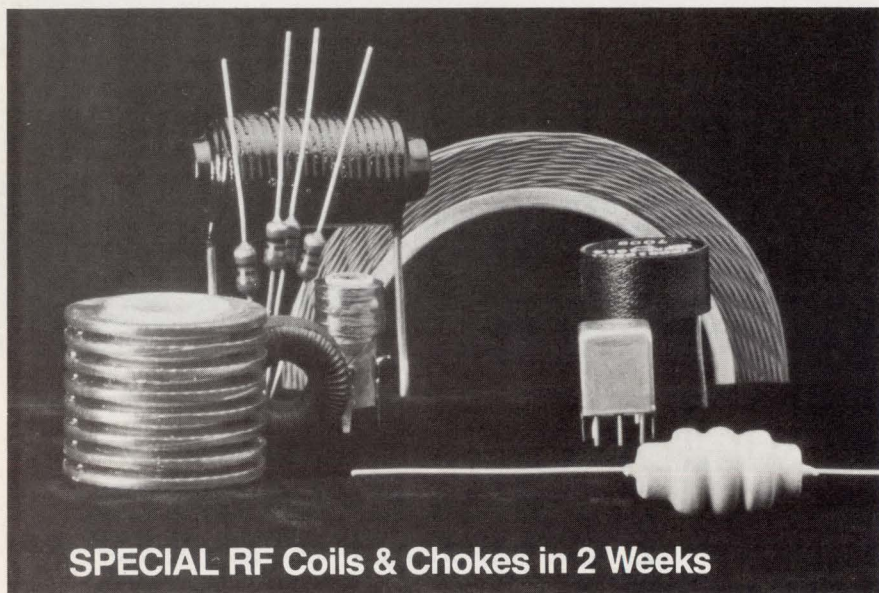

## SPECIAL RF Coils & Chokes in 2 Weeks

Sample RF coils and RF chokes designed to meet your special requirements are shipped within 10 days to 2 weeks. Production quantity shipments start within 3 to 4 weeks after approval of samples. Intensive specialization in coil design and manufacture assures a high degree of optimum performance.

Most popular standard inductors available from stock for immediate shipment. Full line catalog on request.



**J.W. Miller Division**  
**BELL INDUSTRIES**

306 E. Alondra Blvd. ■ Gardena, CA 90247  
(213) 537-5200 ■ FAX (213) 631-4217

Since 1924, leading manufacturer of standard and custom inductors.

CIRCLE 85

# ELECTRONIC DESIGN

**Editor-in-Chief:** Stephen E. Scrupski

**Executive Editor:** Roger Allan

**Managing Editor:** Bob Milne

**Senior Editors:** Frank Goodenough, Milt Leonard, John Novellino

**Technology Editors:**

*Analog & Power:* Frank Goodenough

*Communications & Industrial:*

Milt Leonard (San Jose)

*Components & Packaging:* David Maliniak

*Computer-Aided Engineering:*

Lisa Maliniak

*Computer Systems:* Richard Nass

*Semiconductors:* Dave Bursky (San Jose)

*Test & Measurement:* John Novellino

**News Editor:** Sherrie Van Tyle

**New Products Editor:** Susan Nordyk

**Field Bureaus:**

*West Coast Executive Editor:*

Dave Bursky (San Jose)

*Boston:* Lawrence Curran

*Dallas:* Jon Campbell

*Frankfurt:* John Gosch

*London:* Peter Fletcher

**Chief Copy Editor:** Roger Engelke, Jr.

**Editorial Production Manager:**

Lisa Iarkowski

**Administrative Assistant:** Janis Kunkel

**Editorial Support Supervisor:** Mary James

**Editorial Assistant:** Ann Künzweiler

**Editorial Secretary:** Bradie Guerrero

**Editorial Offices:** (201) 393-6272

**Advertising Production:**

(201) 393-6093 or FAX (201) 393-0410

**Production Manager:** Michael McCabe

*Production Assistants:*

Donna Marie Bright, Doris Carter,

Eileen Slavinsky

**Circulation Manager:** Elaine Brown

*Subscription Inquiries:*

Mary Lou Allerton (216) 696-7000

**Promotion Manager:** Clifford Meth

**Reprints:** Helen Ryan (201) 423-3600

**Group Art Director:** Peter K. Jeziorski

**Computer Systems Administrator:**

Anne Gilio Turtoro

**Published by Penton Publishing**

**Vice President-Editorial:** Perry Pascarella

**Group Editorial Director:** Leland Teschler

**Publisher:** Paul C. Mazzacano

Want to see a precision narrowband sweep that usually takes about a minute?

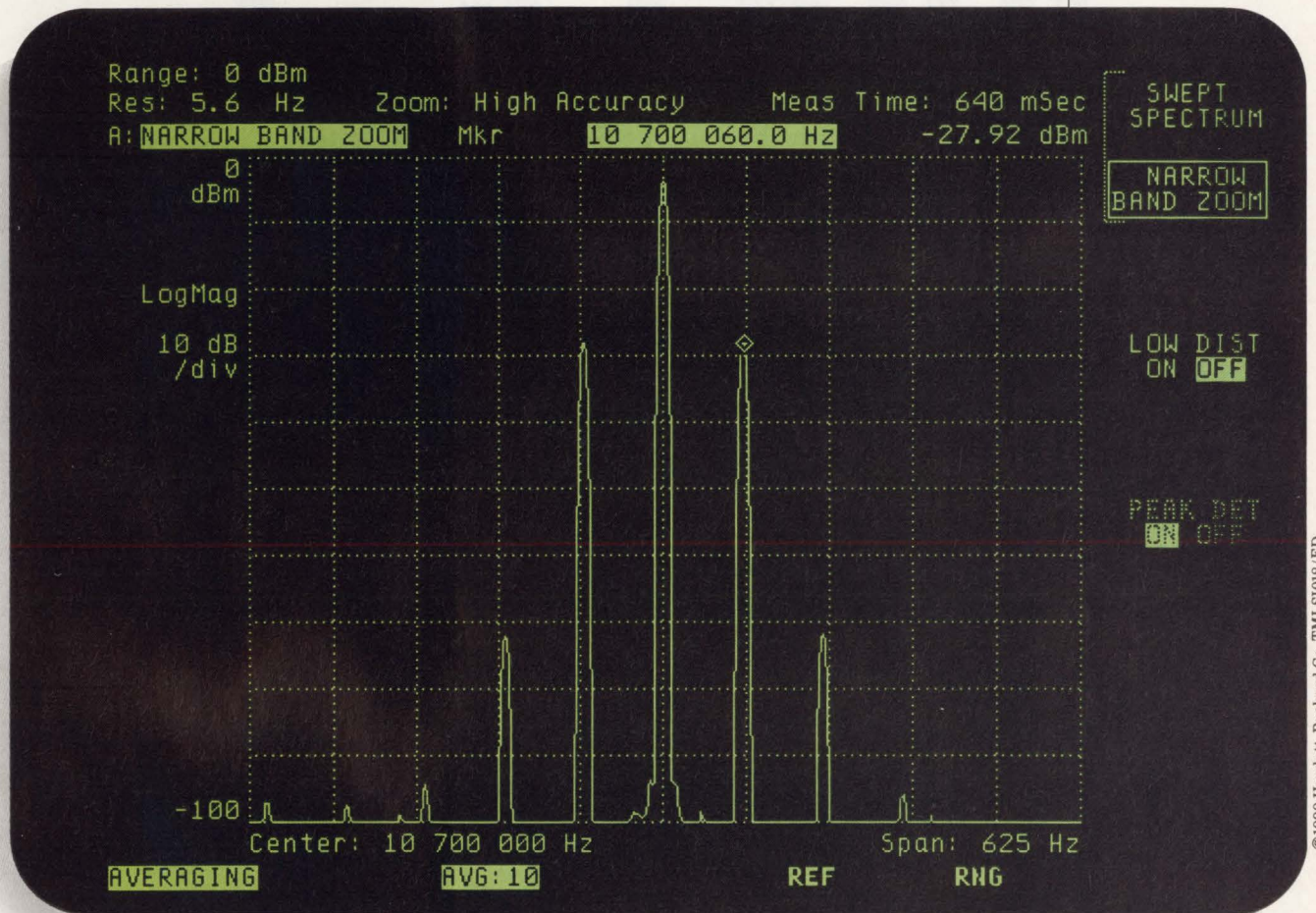

©1990 Hewlett-Packard Co. TML51018/ED

Oops, you blinked.

By blending digital-filter and FFT techniques with swept technology, the new HP 3588A spectrum analyzer makes this measurement in less than a second... with high resolution and  $\pm 0.25$  dB typical accuracy.

This analyzer offers unprecedented speed in two measurement modes. In the swept mode, you get a 10 Hz to 150 MHz range, RBW as narrow as 1.1 Hz and measurements up to 16 times

faster than previously available. The narrowband-zoom mode gives you a span of 40 kHz or less *anywhere* in the 150 MHz range, RBW to 0.0045 Hz and measurements up to 400 times faster than traditional swept analyzers.

So, call 1-800-752-0900 today. Ask for Ext. 1212, and we'll send a videotape demo so you can see these fast measurements for yourself. But don't blink.

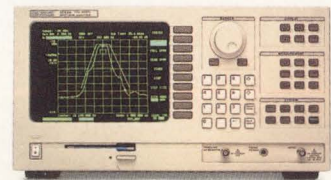

There is a better way.

 HEWLETT  
PACKARD

# 10BASE-T.

# Turnkey.

You've Got Better Things  
To Do With Your Design  
Time (And Money) Than  
Learning The Mysteries  
Of Twisted Pair Ethernet.  
Let Us Help.

No other chip supplier knows its way around networks like Advanced Micro Devices: Backbones, LANs, WANs, you name it.

Just ask our chipset development partners at HP® and SynOptics.™

AMD is a major, major maker of 10BASE-T transceivers. We sell the most cost-effective solution. Our silicon is CMOS, so we'll save you energy as well as time. And you can trust that we're compliant. (We helped write the standard.)

Are you starting development soon? How about now? Call (800) 222-9323.

**Advanced Micro Devices** 

901 Thompson Place, P.O. Box 3453, Sunnyvale, CA 94088.

CIRCLE 170

# The IBM RISC System/ Designing on any other workstation



Whatever you're creating, you'll sail into a whole new age with any of the four POWERstations in the RISC System/6000 family. Because POWER (Performance Optimization With Enhanced RISC) processing can give you performance you've probably only dreamed about:

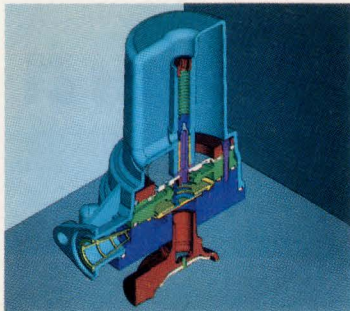

up to four instructions per machine cycle, 42 MIPS and 13 MFLOPS. Suddenly, complex designs don't take eons anymore.

The four RISC System/6000 POWERstations feature a range of graphics processors from grayscale to Supergraphics to satisfy any graphics demand. Great news for Power Seekers working on animation, scientific visualization, medical imaging and engineering solutions like CADAM™, CAEDS™ and CATIA™. And for electrical design automation, there's IBM's all new CBDS™ and an arsenal of over 60 EDA appli-

# 6000™ family. will seem downright primitive.

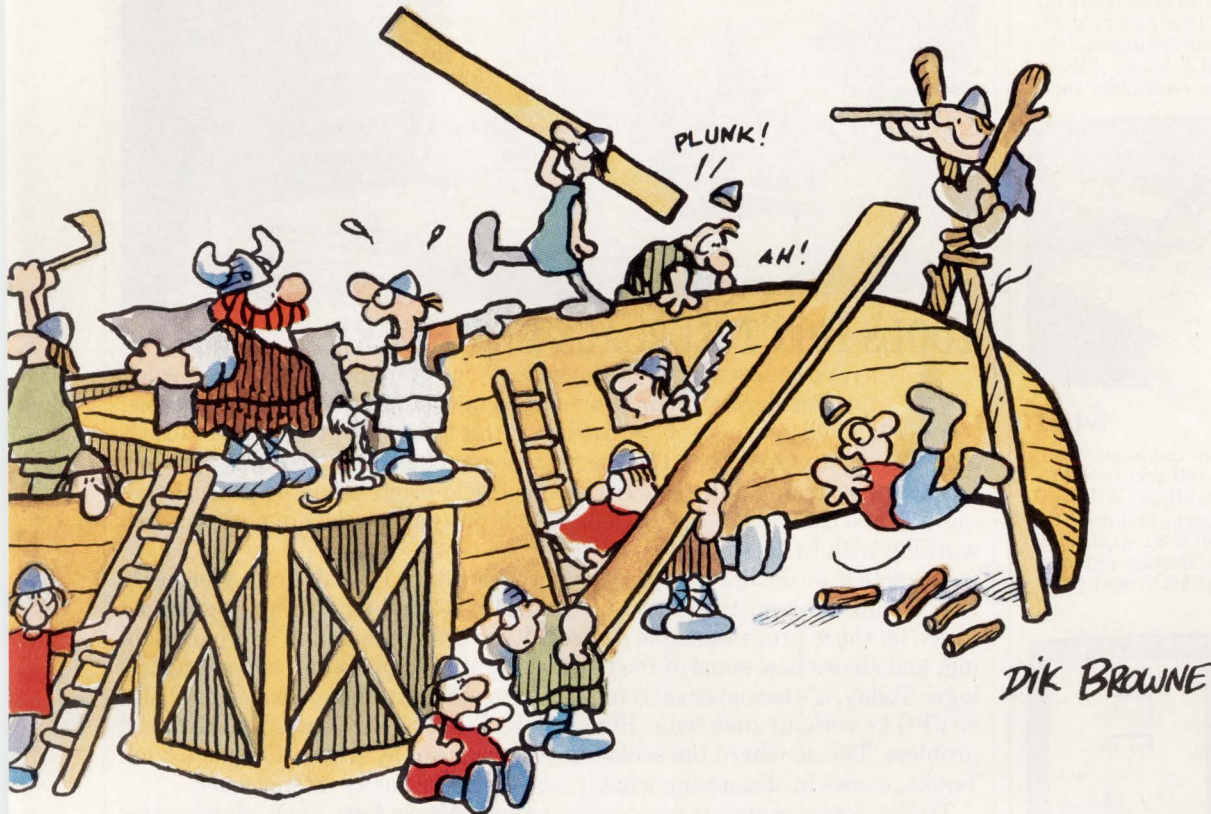

cations from more than a dozen vendors.

With every POWERstation, you can get an almost unimaginable palette of 16 million colors, which gives you 3D images so realistic, they fairly leap off the screen, with super sharp resolution of 1,280x1,024 pixels. And when it's time to call in the heavy artillery, the POWERstation 730 draws nearly one million 3D vectors per second. Like all POWERstations, it can come complete with its own graphics processor, freeing the POWER processor to rapidly create and analyze your designs. All at prices that won't sink anybody's budget.

So if you're tired of paddling upstream with yesterday's performance, call your IBM marketing representative or Business Partner to find out more about the RISC System/6000 family. For literature, call 1 800 IBM-6676, ext. 991.

Civilization never looked so good.

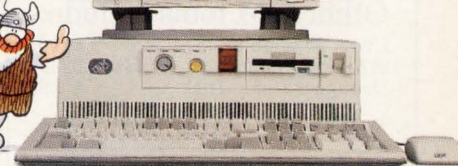

## For the Power Seeker.

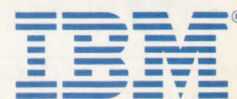

## Low Cost 8051 Tools

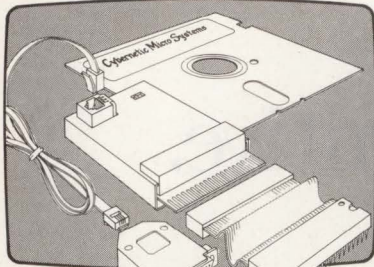

**d<sup>2</sup>ICE-51 \$1250**

This Real-Time emulator is low cost and smallest sized full speed 8051 in-circuit emulator. Full access to hardware I/O. Includes all debugging features of Sim and dICE below. Fits in shirt pocket. Cross Assembler incl.

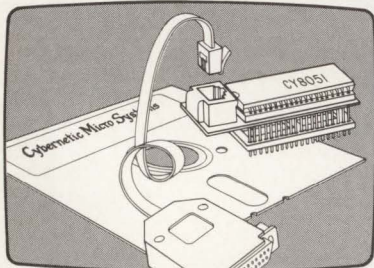

**dICE-51 \$495**

This reduced-speed in-circuit 8051 debugger provides full access to I/O but will not run real-time. With the same user interface features as Sim8051 below, dICE-51 generates execution profiles during reduced speed execution. (CMOS and MIL also available.)

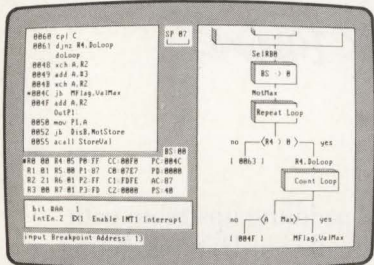

**Sim8051 \$395**

This software Simulator/debugger allows 'no-circuit', debugging of 8051 code on IBM-PCs. All Cybernetics 8051 debug tools offer multi-window source code displays, symbolic access to data, single key commands, breakpoints, trace, full speed and single step execution, execution profiler, and more.

### Other 8051 tools include:

- Cross Assembler \$195
- 8751 Programmer \$195-\$345
- Debugger Demo Disk \$ 39



**Cybernetic Micro Systems**  
 PO Box 3000 • San Gregorio CA 94074  
 Ph: (415) 726-3000 • Fax: (415) 726-3003

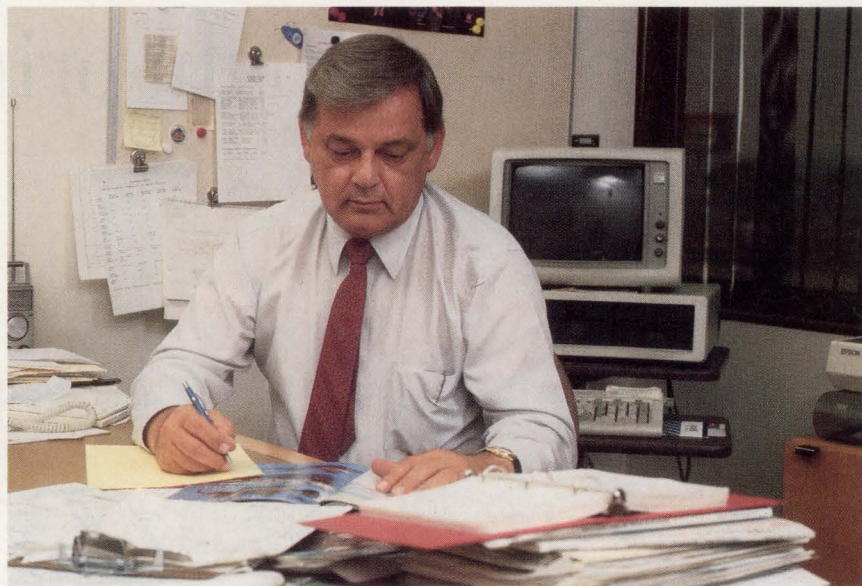

## TOOLS DON'T REPLACE ENGINEERS

**A**nyone concerned about the importance of engineering as a specialty, considering the improvements in computer-based design tools, should take note of two articles in this issue that present an interesting juxtaposition: The special report on tools for designing systems based on programmable logic devices and field-programmable gate arrays (pg. 55), and the Design Applications article on avoiding design pitfalls when working with PLDs (pg. 75).

The article on design tools, written by CAE Editor Lisa Maliniak (formerly Lisa Gunn), explores the many automated tools that help configure systems based on these programmable devices. It covers optimization and partitioning, and shows how some of the tools use synthesis procedures to set up the logic. Today, it's become nearly impossible to design a system based on PLDs or FPGAs without such tools. But those tools aren't the total solution to the problem. This is where the second article, written by Altera Corp.'s Chuck Tralka, comes in, discussing what it takes to make such systems work.

Tralka, a senior applications engineer with Altera Corp., one of the major suppliers of PLDs, bases his article on the many phone calls he has handled from designers struggling with system timing problems, glitches, ground bounce, etc.—the real-world problems that arise when the printed-circuit board prototype is reassembled. Engineers are needed to solve these problems—that's what they get paid for. And, as far as we can see, they will continue to be needed for many years to come.

One final note: As much as engineers will be needed in the future, our salary survey on page 125 shows, we believe, that they're entitled to still more concrete recognition of their efforts. Simply stated, they deserve better pay. One of our readers, in his response to our survey form, commented that the farther away someone within the company is from the hands-on part of the project, the more they seem to get paid. We would like to hear your thoughts on the figures we cite in our survey. Fax us your opinions to 201-393-0637 or write to us at 611 Route 46 West, Hasbrouck Heights, NJ 07604.

Stephen E. Scrupski  
 Editor-in-Chief

CIRCLE 88



# incredible!

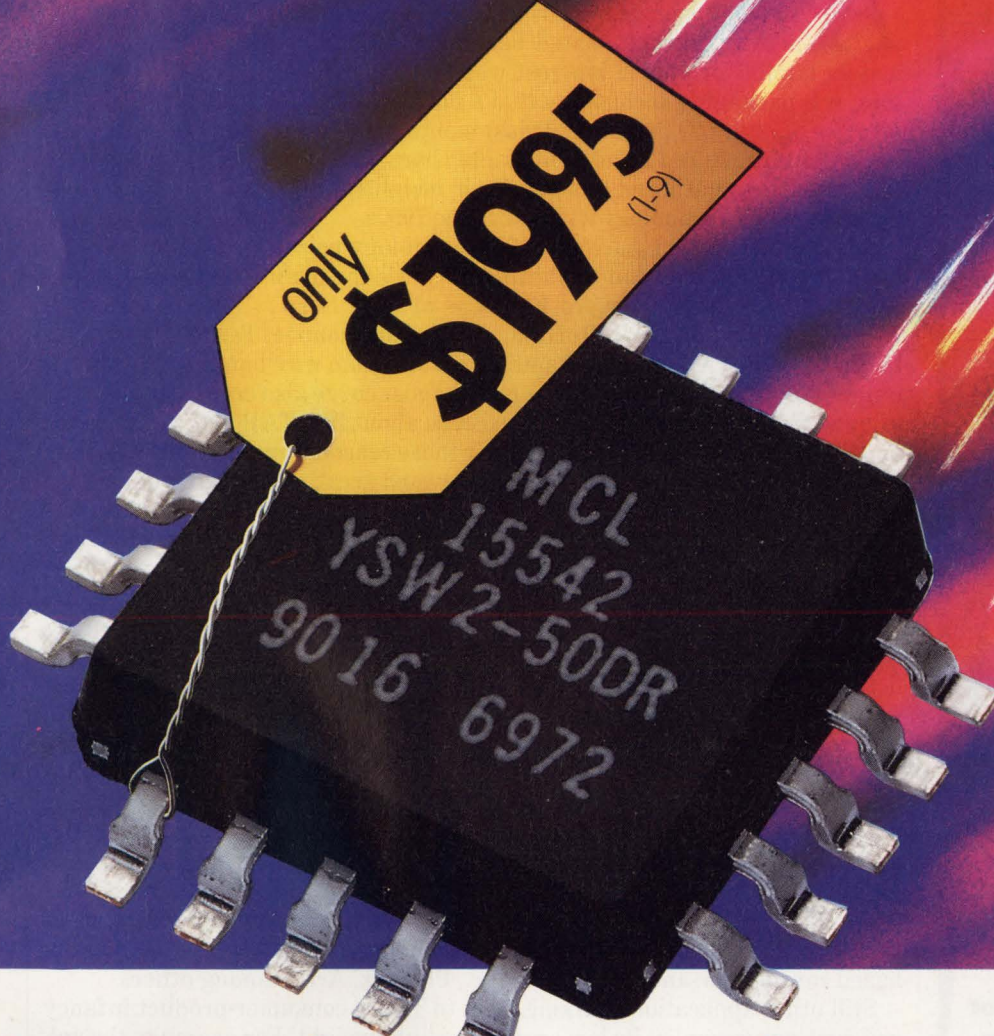

## SPDT switch dc to 5GHz with built-in driver

Truly incredible... a superfast 3nsec GaAs SPDT reflective switch with a built-in driver for only \$19.95. So why bother designing and building a driver interface to further complicate your subsystem and take added space when you can specify Mini-Circuits' YSW-2-50DR?

Check the outstanding performance specs of the rugged device, housed in a tiny plastic case, over a -55° to +85° C span. Unit-to-unit repeatability for insertion loss is 3-sigma guaranteed, which means less than 15 of a 10,000-unit production run will come close to the spec limit. Available for immediate delivery in tape-and-reel format for automatic placement equipment.

### SPECIFICATIONS YSW-2-50DR

	dc- 500MHz	500- 2000MHz	2000- 5000MHz
Insertion loss, typ (dB)	0.9	1.3	1.4
Isolation, typ(dB)*	50	40	28
1dB compression, typ (dBm @ in port)	20	20	24
RF input, max dBm (no damage)	22	22	26
VSWR (on), typ	_____	1.4	_____
Video breakthrough to RF, typ (mV p-p)	_____	30	_____
Rise/Fall time, typ (nsec)	_____	3.0	_____

\*typ isolation at 5MHz is 80dB and decreases 5dB/octave from 5-1000 MHz

finding new ways...  
setting higher standards



## Mini-Circuits

WE ACCEPT AMERICAN EXPRESS

P.O. Box 350166, Brooklyn, New York 11235-0003 (718) 934-4500 Fax (718) 332-4661 Telexes: 6852844 or 620156

CIRCLE 105

hey!  
if you know  
**SUSIE**

Digital Logic Simulator  
for 286/386/486

FPGAs  
PLDs  
MPUs  
Memories

like we know  
**SUSIE**

- Real time interactive
- Displays:
  - Timing violations
  - Bus conflicts
  - Race conditions
- On-the-fly changes to:
  - Test vectors
  - Propagation delays
  - Interconnections
  - HEX files
- Compatible with all  
CAD software
- The best package for  
price/performance

you'll wonder how  
you ever got  
along without her!

Call for a free demo disk  
**(805) 499-6867**

**ALDEC**  
Newbury Park, CA Fax: (805) 498-7945

CIRCLE 101

## A LOOK AHEAD AT TAB IN THE 1990s

As interconnection densities and data rates surge upward, component and circuit packaging must strive to keep pace or risk performance bottlenecks. Tape-automated bonding (TAB), which had its humble origins in low-cost watches and calculators, is a packaging technology that's now fulfilling its promise of high-I/O potential. At last month's SMTCON West Conference and Exhibition, Santa Clara, Calif., industry experts gathered to share their insights on the directions TAB technology will take in the 1990s.



DAVID MALINIAK  
COMPONENTS & PACKAGING

A peek into TAB's future reveals a technology poised to spread into a myriad of applications. That's the main thrust of a paper by Howard E. Evans of IBM Corp., Austin, Texas, and Paul R. Hoffman of Olin Interconnect Technologies, Santa Clara, Calif. TAB requires a smaller die size than wire bonding for a given number of inputs and outputs. Its relative cost curve also crosses under that of quad flat packs once I/O count exceeds about 200. TAB also yields great benefits in IC testing and handling. For those reasons, among others, TAB is expected to fuel the accelerating trend toward greater packaging density.

Even as overall TAB usage grows, a trend toward use in more sophisticated system applications is apparent. The technology's expanding use in both low- and high-end computer systems will mean more TAB ASIC packages requiring more I/O, ground planes, and improved thermal performance. According to Evans and Hoffman, major ASIC vendors who aren't producing very-high-I/O, fine-pitch TAB ASIC packages have them in the works. Within the next two years, implementations will reach 500 or more leads with 0.25-mm outer-lead-bond pitches.

Ground planes for enhanced electrical performance up to near 100 MHz are also on the way. At least one major manufacturer of TAB film, Rogers Corp., Chandler, Ariz., has announced two-metal-layer TAB tape that incorporates a ground layer for improved impedance matching (*ELECTRONIC DESIGN*, Sept. 27, p. 202). 3M Corp., Austin, also offers a two-layer tape. Such tapes will pave the way for TAB's use in multichip modules for high-end system applications. These applications are being advanced by ongoing work at the Microelectronics and Computer Technology Corp. (MCC), an Austin-based consortium, and at Motorola Inc., Phoenix, Ariz., among others.

Still other applications harking back to TAB's consumer-product infancy will continue to exploit its low profile and light weight. For example, the volume of smart cards is expected to expand significantly. TAB is also replacing stamped lead frames in pin-grid-array and quad flat packages as their size, electrical characteristics, and thermal needs outstrip the limits of wire-bonding technology. Another burgeoning application for TAB is in stacked memory modules. These modules can take advantage of TAB's mounting density compared with wire bonding.

For flip-TAB applications, where chips are attached face down, integrated heat sinks will become more common, state Evans and Hoffman. Area-array TAB, which involves bonding to the active chip areas instead of to bonding pads at their edges, will also come into play to further decrease package size and cost. 3M's area-TAB tape incorporates through-holes that correspond to bumps placed on the chip. The result is high I/O counts without significantly increased die sizes.

Finally, to further aid TAB's widespread acceptance and universality, design guidelines were established under a joint EIAJ (Electronic Industry Association of Japan)/Jedec proposed standard. U.S. TAB vendors are now rallying around the standard, which includes compatibility with metric quad flat-pack sizes. Standardization will help drive TAB proliferation as new users will have access to available packages and their associated tooling.

See Us At ELECTRONICA '90  
Munich, Germany (Nov. 6 - 10)  
Booth F31, Halle 16

# SMC.<sup>®</sup> Above the rest.



Climbing takes skill, experience and teamwork. Reaching the top also takes leadership, forward thinking and focus. Since 1971, Standard Microsystems has applied this philosophy to the design and manufacture of standard and semi-custom integrated circuits.

Today, SMC's engineering expertise and extensive SuperCell™ library, allows us to offer innovative and timely solutions to your unique application needs. Our portfolio focuses on networking and mass storage controller devices for the computer industry.

The next time you face a networking or mass storage challenge, call SMC. Discover how our cost-effective and technically superior products can help you climb ahead of your competition.

**STANDARD MICROSYSTEMS  
CORPORATION**  
COMPONENT  
PRODUCTS DIVISION

The Standard for LAN and Mass Storage ICs.

35 Marcus Blvd., Hauppauge, NY 11788 (516) 273-3100 Fax (516) 231-6004

SuperCell is a trademark of Standard Microsystems Corporation.

CIRCLE 177

# THE WORLD'S LARGEST SELECTION OF **POWER SPLITTERS/ COMBINERS**

**2 KHz to 8 GHz** from **\$10<sup>45</sup>**

With over 300 models, from 2-way to 48-way, 0°, 90° and 180°, a variety of pin and connector packages, 50 and 75 ohm, covering 2KHz to 8000MHz, Mini-Circuits offers the world's largest selection of off-the-shelf power splitter/combiners. So why compromise your systems design when you can select the power splitter/combiner that closely matches your specific package and frequency band requirements at lowest cost and with immediate delivery.

And we will handle your "special" needs, such as wider bandwidth, higher isolation, intermixed connectors, etc. courteously with rapid turnaround time.

Of course, all units come with our one-year guarantee.

For detailed specs and performance data, refer to the *MicroWaves Product Directory, EEM or Mini-Circuits RF/IF Signal Processing Handbook, Vol. II*. Or contact us for our free 68-page *RF/IF Signal Processing Guide*.

finding new ways ...  
setting higher standards

## Mini-Circuits

A Division of Scientific Components Corporation  
P.O. Box 350166, Brooklyn, New York 11235-0003 (718) 934-4500  
Fax (718) 332-4661 Domestic and International Telexes: 6852844 or 620156  
WE ACCEPT AMERICAN EXPRESS

CIRCLE 140

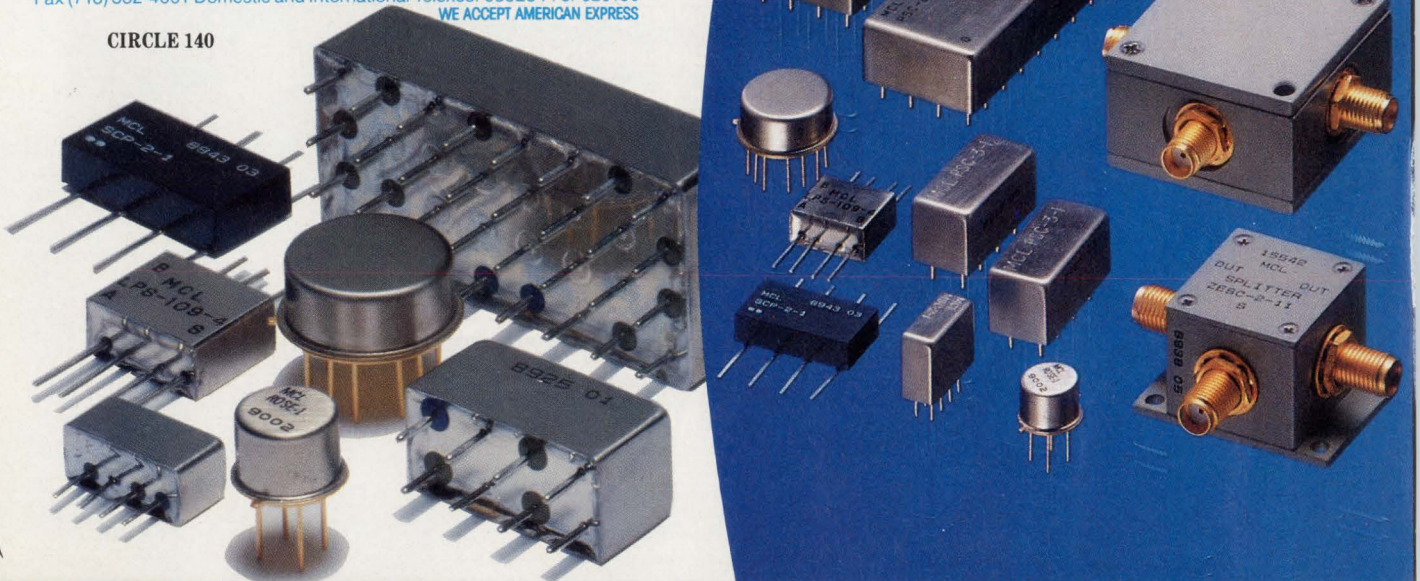

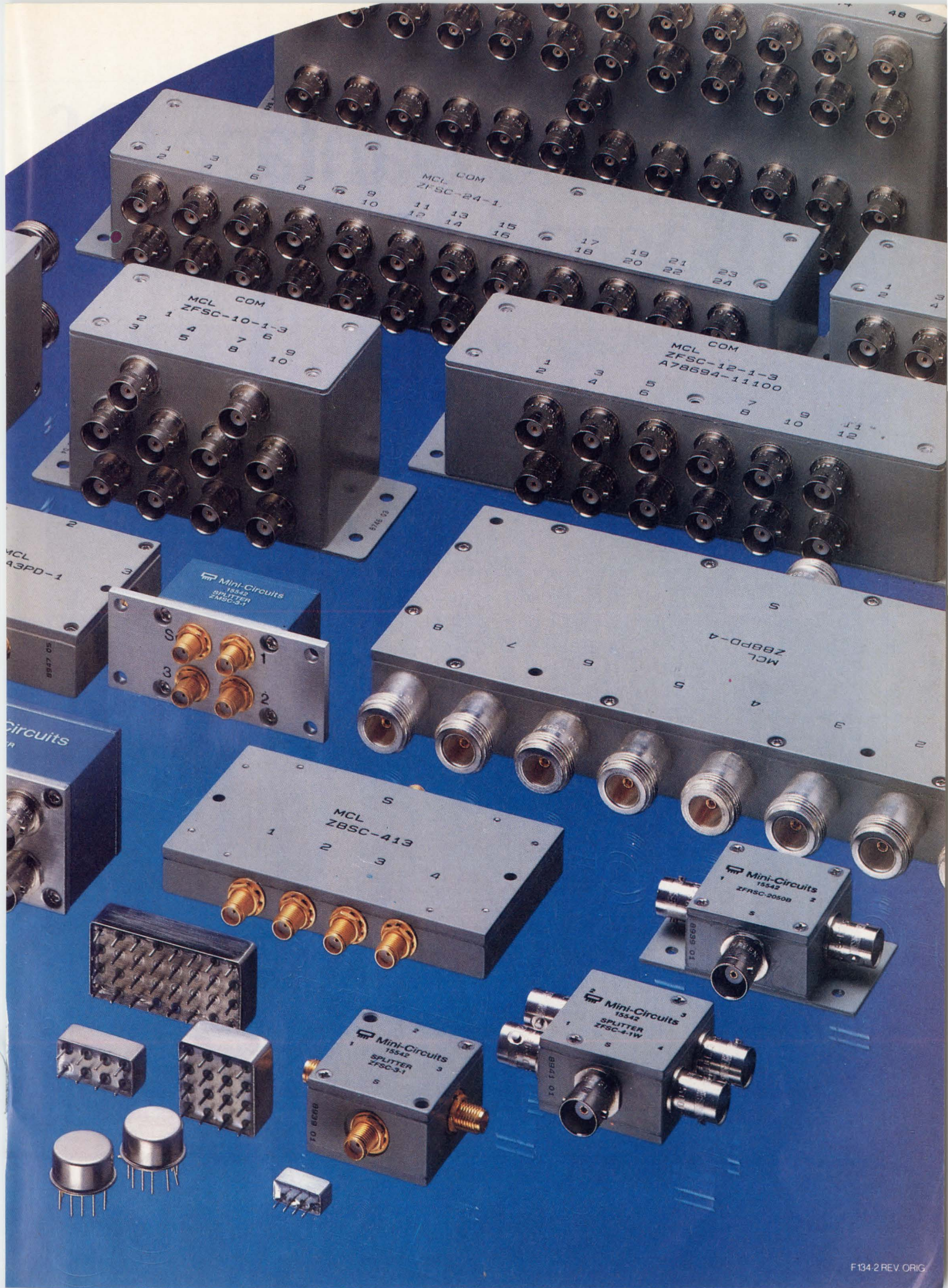

# Take Advantage Of Board-Level Partner



© 1990 Motorola, Inc. Motorola Computer Group is a member of Motorola's General Systems Sector. VMExec is a trademark of Motorola, Inc. All other product or brand names mentioned are trademarks or registered trademarks of their respective holders.



# All That Our VME ship Has To Offer.

Become  
A Partner Today.  
BUSCON Booth #505

Once you've seen what Motorola brings to the table, we think you'll agree it's everything you need. Like the most complete line of VME products, services and engineering support available anywhere. Award-winning quality. Competitive pricing. All from the company that pioneered VME technology, and whose product line ranges from ICs to boards to full systems. And includes everything in between.

You decide exactly what you need from our more than 100 VME products at every level of price and performance. From CPU boards, like our new '040-based MVME165, to memory boards, to communications boards. And the industry's widest assortment of development tools, software resources, and technical support.

A partnership with Motorola not only helps you control costs, but even more importantly, speeds your time to market.

Our products include more functionality with a higher level of integration to accelerate your development efforts. And because of Six Sigma quality control you can be assured that our products will work right out of the box. It all adds up to the fact that getting you to market sooner is a promise only a company with the resources of Motorola can make good on.

Every Motorola product includes a built-in migration path, so your future product cycles are

assured. Such as providing a way to upgrade from the 68020 to the 68030 to the 68040, or from a 68000 CISC board to an 88000 RISC board with a simple re-compile. Wherever you're headed, Motorola is going to be there.

And we'll support you during the entire development process. Every board in our product line includes a full suite of board diagnostics available in both a run-time and a source package. This degree of flexibility also extends to our nationwide customer service programs, which run the gamut from total on-

site maintenance to self-maintenance support packages.

For more information, call us today at 1-800-624-8999, ext. 230.

Once you discover the advantages of a partnership with Motorola, you'll see that it's no ordinary board-level decision. It could ensure the future of your company.



## At Motorola, Openness Is Standard Procedure

These days, openness has become something of a buzz word, and everybody seems to have a different idea on what is and isn't "open." To us, it's no big mystery. Openness means open architectures, open software, open networking. And open standards like UNIX<sup>®</sup>, as indicated by our role in founding 88open. It means we're open to helping solve problems with your point of view in mind, not just ours. And it's

been that way ever since we helped introduce VME back in 1982.

That's why Motorola is committed to supporting official and de facto industry standards, interoperable computing between multiple vendors, and non-proprietary open system architectures. It's why we created VMEexec:<sup>™</sup> to facilitate the

interoperability of different real-time software modules within a common UNIX environment. And it's why we support virtually every networking protocol, including XNS, TCP/IP, DECnet,<sup>™</sup> MAP/TOP/OSI, SNA, BSC, X.400, and X.25.

This philosophy of openness is the same reason we offer as many VME boards, products and services as we do. It's to our mutual benefit, and after all, isn't that what partnerships are for?

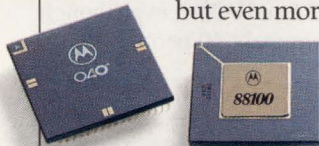

**MOTOROLA**  
Computer Group

# 3.3V Technology Breaks 5V Speed Barrier

## 31 LOGIC PARTS 35% FASTER THAN FCTA

### A New Generation of 3.3 Volt CMOS Center-Pin Power and Ground Products with TTL-Like I/O.

Performance's NEW 3.3V PCTD Logic Family, featuring 0.4 micron effective gate lengths (PACE III Technology) and center power and ground packaging, offers a 35% speed improvement over 5V FCTA, with dramatically lower power dissipation and half the ground bounce.

*"It has been clear for some time that the primary consideration which could limit the use of future generations of CMOS technology in the highest speed applications were issues associated with constraints that have been hangovers from bipolar TTL circuit implementations. If those constraints are not removed, then either performance will be compromised or serious application problems will result. It is easy to see the value of the changes that are needed to take maximum advantage of the attributes of the fine-line CMOS technology in the sub half-micron regime (PACE III). Therefore, we have decided to invest a significant part of our Company's technical and marketing resources to help make the transition from a TTL environment to an optimized CMOS environment.*

*As the 3.3 volt supply, low-lead inductance product line emerges with 0.4 micron PACE III Technology, the uncompromised performance will overcome resistance to change and we will have a 'kinder & gentler' speed."*

Tom Longo

### Performance's 3.3 Volt Logic Family

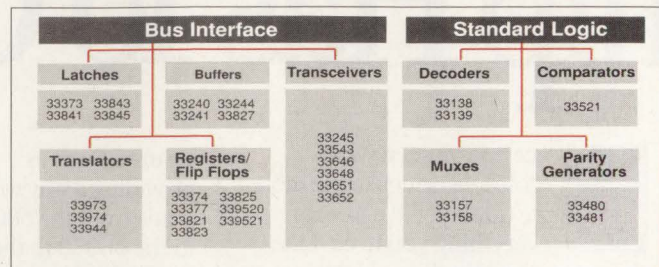

Twenty-five product types are available now with six more available by November, 1990. Included are buffers and latches designed for 5V to 3.3V logic-level translation without speed loss. Future superfast products, using center-pin power and ground with a 3.3V power supply, will include SCRAMs with 64 Kbit to 256 Kbit densities and PACEMIPs RISC processor products such as CPU, FPA and Wrap Functions.

### CMOS Logic Performance Trends

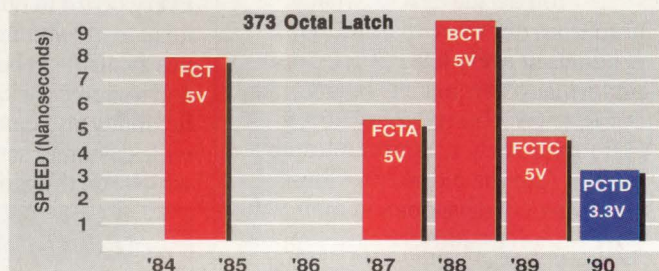

Featuring TTL-like I/O, Performance's PCTD logic **dramatically outperforms** FCTA, BCT and FCTC, even though power dissipation is reduced approximately 40 percent.

### P74PCT33373D 3.1ns (WC) Specification

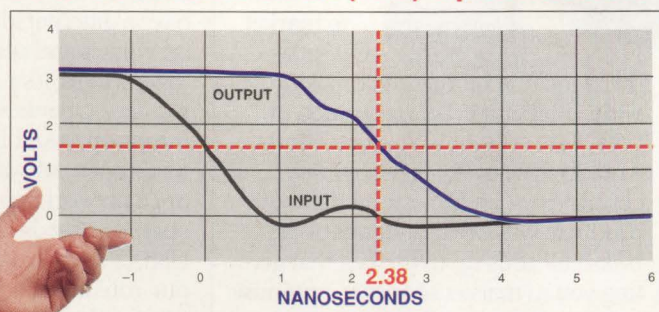

Performance's P74PCT33373D offers a typical propagation delay of 2.4ns with extremely low noise.

For more information or to order Performance's PCTD Logic, call **The Marketing Hotline: (408) 734-9000** or write . . .



610 East Weddell Drive, Sunnyvale, CA 94089

CIRCLE 122



**DISK-DRIVE GROUP FORGES TEST STANDARDS**

A newly formed organization, the Post-HDA (head-disk assembly) Testing Consortium, will try to resolve the issue of a lack of test-data correlation for hard-disk drives. Hard-disk drives are one of the few computer peripherals that can't be field-tested accurately. The consortium has over 30 member companies and is open to major disk-drive makers and users, value-added resellers, test-equipment manufacturers, third-party service companies, and chip- and board-level controller firms. Spearheaded by FlexStar, a test-equipment manufacturer in San Jose, Calif., the Consortium will meet on Oct. 3 at the Sheraton Hotel in Milpitas, Calif., to agree on subcommittee recommendations for test definitions, testing methodologies, detailed test parameters, and test prioritization. Ultimately, the de facto standards will be submitted to the American National Standards Institute and other standards organizations to incorporate into their standards. Following the establishment of the test standards, associate membership will be available to those not directly involved in the manufacture, sale, or integration of hard-disk drives. Interested parties contact Mike Witte, FlexStar, 2040 Fortune Dr., # 101, San Jose, CA 95131-1823; (408) 433-0770. *ML*

**AUTOMOTIVE SYSTEMS MEET SILICON**

With a view to cut the time-to-market and further improve product definition, Silicon Systems, Tustin, Calif., well-known for its disk-drive and modem chips, will team with Intelligent Controls Inc. (ICI), Novi, Mich., to develop advanced automotive electronic products. Over the last few years, Silicon Systems has designed custom signal-conditioning and data-acquisition ICs for automotive systems, including ignition, fuel-injection, anti-skid braking, and active-suspension applications. ICI, recognized in the automotive community for its system-engineering expertise and a leader in electronic engine-control system design, will aid in the design and evaluation of Silicon Systems' products and mixed-signal design capability for the automotive industry. For information call Lana Perry (Silicon Systems) at (714)731-7110, or Jerry Bricker (ICI) at (313)471-5000. *FG*

**WORKGROUP COMPUTING GAINS SPARC PLATFORM**

A combination of hardware and software will make it possible for millions of desktop computers distributed over large distances to share data quickly and easily. Xerox Corp., Palo Alto, Calif., in a joint designing effort with Sun Microsystems Corp., Mountain View, Calif., unveiled a Sparc-based workstation that handles the complex network environments. It also showed off an add-in coprocessor board for IBM and compatible PCs, and a proprietary workgroup software package it calls GlobalView. The software and underlying plug-in hardware can turn PCs into multitasking networked workstations. Those workstations, plus the new Sparc-based workstations, can be linked to form an enterprise-wide environment, potentially encompassing more than 30 million desktop computers. Contact Joseph McGrath (213) 333-7000. *DB*

**SUPERSCALAR SUPPORT GROUP SETS STANDARDS**

To ensure future software compatibility of systems using the Intel i860 superscalar RISC chip, a cooperative organization called MASS860 has been formed. The MASS860 will promote software development with a standard application binary interface (ABI). The organization was founded by Intel Corp., Santa Clara, Calif., and a number of concerned systems suppliers—Alliant, IBM, Oki, Olivetti, and Samsung. One of its goals is to reduce redundant development costs and shorten the time to market. The group's activities include forming open and published standards, creating an i860-based reference design, developing a suite of programs to test application packages for compliance to ABI, and establishing and supporting software libraries for ABI, operating-system, and graphical user-interface development. Intel will provide the hardware and software reference models. System-vendor members will supply the hardware porting platforms, software porting assistance, as well as perform the verification of ABI compliance. The program will be administered by Intel, offering in-depth education on the i860 through video tapes and classes. Intel also set up a porting center at one of its offices in Santa Clara, where technical support and compatibility testing will be supplied. *DB*

**RISC CPUs SPAN HIGH-TO LOW-END SYSTEM NEEDS**

To get more of its chips into embedded-control applications, Intel Corp., Chandler, Ariz., last month unveiled two low-cost versions of its i960 RISC processor—the i960SA and SB. In 80-lead quad-sided flat packages, they'll sell for a mere \$19.20 and \$25.00, respectively, in 1000-unit lots. To get the prices that low, the external 32-bit data bus of the standard i960 processor was shaved down to 16 bits. But the

chips still have a 32-bit CPU core with 32 32-bit registers. They hold the minimum four sets of local internal register cache (256 bytes total), a small, 512-byte internal instruction cache, and a simple, expandable, interrupt controller. The SA and SB are basically the same, except that the SB also includes an 80-bit IEEE-compatible floating-point unit. Even with a lower price, the performance remains respectable. The SA and SB operate at 10 or 16 MHz, and claim a Vax-comparable throughput of 5 MIPS (at 16 MHz). The SB's floating-point unit is rated at 0.5 MFLOPS. To move data into and out of the chip with minimal overhead, a special memory-bus interface assembles 16-bit transfers automatically into 32-bit words and vice-versa. An interface burst mode enables four sequential 32-bit words to be transferred in just 10 clock cycles. For higher performance, a 40-MHz 35-Vax-MIPs version of the 33-MHz i960CA was released. Contact Alan Steinberg (602) 554-8080. *DB*

## IMAGE PROCESSING CARD ENHANCES NEXT COMPUTER

Adding image processing and compatibility with the Joint Photographic Experts Group standard, an add-in card for the NeXT personal computer combines both an image-compression processor and a 64-bit superscalar RISC processor. The card, developed by NeXT Computer Inc., Redwood City, Calif., is the first add-in card for any computer to employ the CL550 image-compression processor from C-Cube Microsystems, San Jose, Calif. It operates in tandem with the i860 processor from Intel Corp., Santa Clara, Calif. The NeXTdimension image-processing card plugs into one of the original NeXT cubes. It adds 32-bit true color, sophisticated drawing, image manipulation, rendering, and display capabilities to the computer. With the CL550, users can compress still images in real time and display full-motion video at up to 30 frames/s. Compression can be done at ratios of up to 100:1, depending on the application and the desired decompression quality. In addition to the new card, NeXT has also released a couple of new computer systems based on the 68040: an upgraded version of the 68030-based cube and a less-expandable desk-top configuration that sells for under \$5000. In addition, C-Cube Microsystems unveiled Apple Macintosh NuBus and IBM PC/AT image-compression/expansion add-in cards that employ the CL550. The cards, which will sell for less than \$1000, enable designers to experiment with still- and motion-video compression and expansion. *DB*

## BIPOLAR SILICON KEEPS CHASING GAAS FETS

At the recent Bipolar Circuits and Technology Meeting in Minneapolis (Sept. 17-18), a number of bipolar silicon ICs containing transistors with  $f_t$ s beyond 15 GHz were divulged. A few of the highlights included:

A joint paper from Bellcore, Red Bank, N.J., and Avantek, Newark, Calif., described a parallel-processing 11-GHz decision circuit for next-generation SONET (Synchronous Optical Network) telecommunications systems. This speed represents an increase from 8 GHz for a nonparallel circuit. A decision threshold of 100 mV was obtained at 10 GHz. The circuit, which is a hybrid, employs master-slave D-type flip-flops made on Avantek's self-aligned silicon-nitride ISOSAT process. The process has 0.6- $\mu$ m-wide arsenic-doped emitters, a 4- $\mu$ m base-to-base pitch, trench isolation, a 2- $\mu$ m-thick field-oxide isolation, polysilicon resistors, and two-layer Titanium-tungsten-gold metal. Transistor  $f_t$ s run 10-15 GHz and  $f_{max}$ s at 20 GHz.

If Signetics, Sunnyvale, Calif., has its way, PLD speed won't be limited by CMOS technology. In a technical presentation, Signetics described a PLD chip compatible with both 10K and 100K ECL, and able to run at clock rates of over 200 MHz, with gate delays under 4 ns. The PLD's core represents a two-level logic element with a 90-by-40 fuse-programmable AND array feeding 8 OR gates. In addition to 11 fixed inputs, the 12th doubles as a global clock signal. Eight output-logic macrocells, each containing an edge-triggered D-type flip-flop, along with output-select and feedback-select multiplexers, are also fuse programmable.

IBM hasn't been idle in this area either. A paper from their Yorktown Heights, N.Y., laboratory added what's probably the fastest JFETs to a 0.8- $\mu$ m ECL process whose npn's sport  $f_{ts}$  of 25 GHz. The active JFETs replace the passive pull-down resistors in the ECL outputs. As the integration level of ECL circuits rises, the power required by each gate must be reduced. When operating in a low-power mode, the pull-down process tends to be slower than the pull-up routine in the typical resistor-load emitter-follower. The FET pull-down stage operates as a push-pull follower. It enhances the speed and drive of a 1-mW ECL gate by 25 and 50%, respectively. Moreover, not only is the FET smaller than the resistor, no process additions are required. For copies of the conference proceedings contact Jan Jopke, (612) 934-5082. *FG*

# High-Speed Amplifiers

## WB05

CURRENT  
BUFFER

- ▶ 10,000 V/ $\mu$ s Slew Rate
- ▶ 1 Amp Output (1.5 A Pulse)
- ▶  $\pm 5$  to  $\pm 15$  Supply
- ▶ 70 MHz Full Power Bandwidth
- ▶ Up To 15 Watts Dissipation

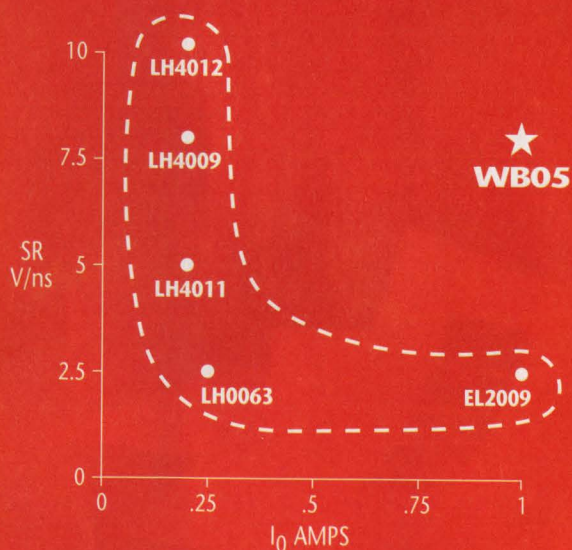

## WA01

TRANSIMPEDANCE  
AMPLIFIER

- ▶ 4,000 V/ $\mu$ s Slew Rate
- ▶ 400 mA Output
- ▶  $\pm 12$  to  $\pm 15$  Supply
- ▶ 40 MHz Full Power Bandwidth
- ▶ Up To 10 Watts Dissipation

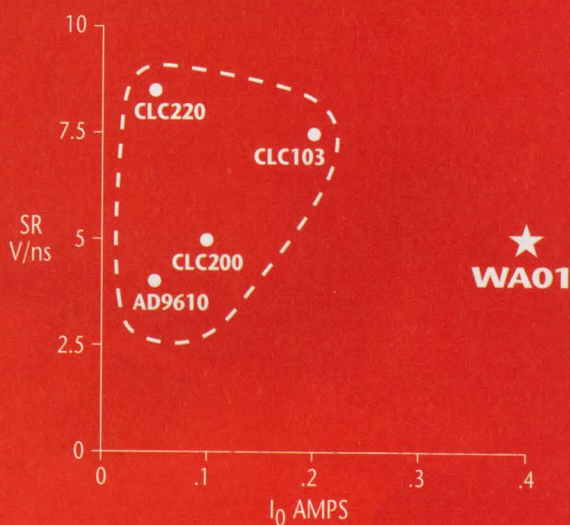

## APPLICATIONS

LASER DIODE DRIVERS  
SONAR TRANSDUCER DRIVERS  
PIN DRIVER

LASER DIODE DRIVERS  
VIDEO AMPLIFIERS  
WAVEFORM GENERATORS

To Place An Order Call  
**602-742-8601**

For Applications  
Assistance Call  
**1-800-421-1865**

**APEX**<sup>®</sup>  
**μtech**

DEDICATED TO EXCELLENCE

APEX  
MICROTECHNOLOGY  
CORPORATION



To receive  
your copy of our  
High Performance  
Amplifier Handbook  
please call toll free  
**1-800-448-1025**

# Test development today:

## The write way



# Now on DOS!

## The right way



Now, HP's **Interactive Test Generator** delivers faster, easier test development on PCs, too.

If the task of writing code is taking you away from test engineering and turning you into a full-time programmer, you'll welcome a faster, easier method of test development...the HP Interactive Test Generator (ITG) software.

Of course ITG is already the preferred programmer's tool if you're using HP BASIC on an HP workstation or BASIC Language Processor. And now, there's an HP ITG for DOS package for PC users who rely on Microsoft QuickC, C or QuickBASIC.

Either ITG package gives you an easy-to-use interface and automatically writes complex code for your test systems. Simple mouse-controlled instrument panels and menu-driven commands make test development intuitive. No need for manuals when programming new or unfamiliar instruments. HP ITG chooses the right command and sends it...automatically.

With HP ITG, you'll cut development time dramatically. And you'll find it easy to integrate the ITG-developed test programs with your other test software.

So whether you're using an HP workstation or a PC, call **1-800-752-0900\*** today. Ask for **Ext. 1430** and we'll send details on doing test development the right way.

\*In Canada, call 1-800-387-3867, Dept. 412.

There is a better way.

 **HEWLETT  
PACKARD**

CIRCLE 93

From OC-3 to OC-12...

# Regenerate your SONET signals with our PLL clock and data recovery IC.

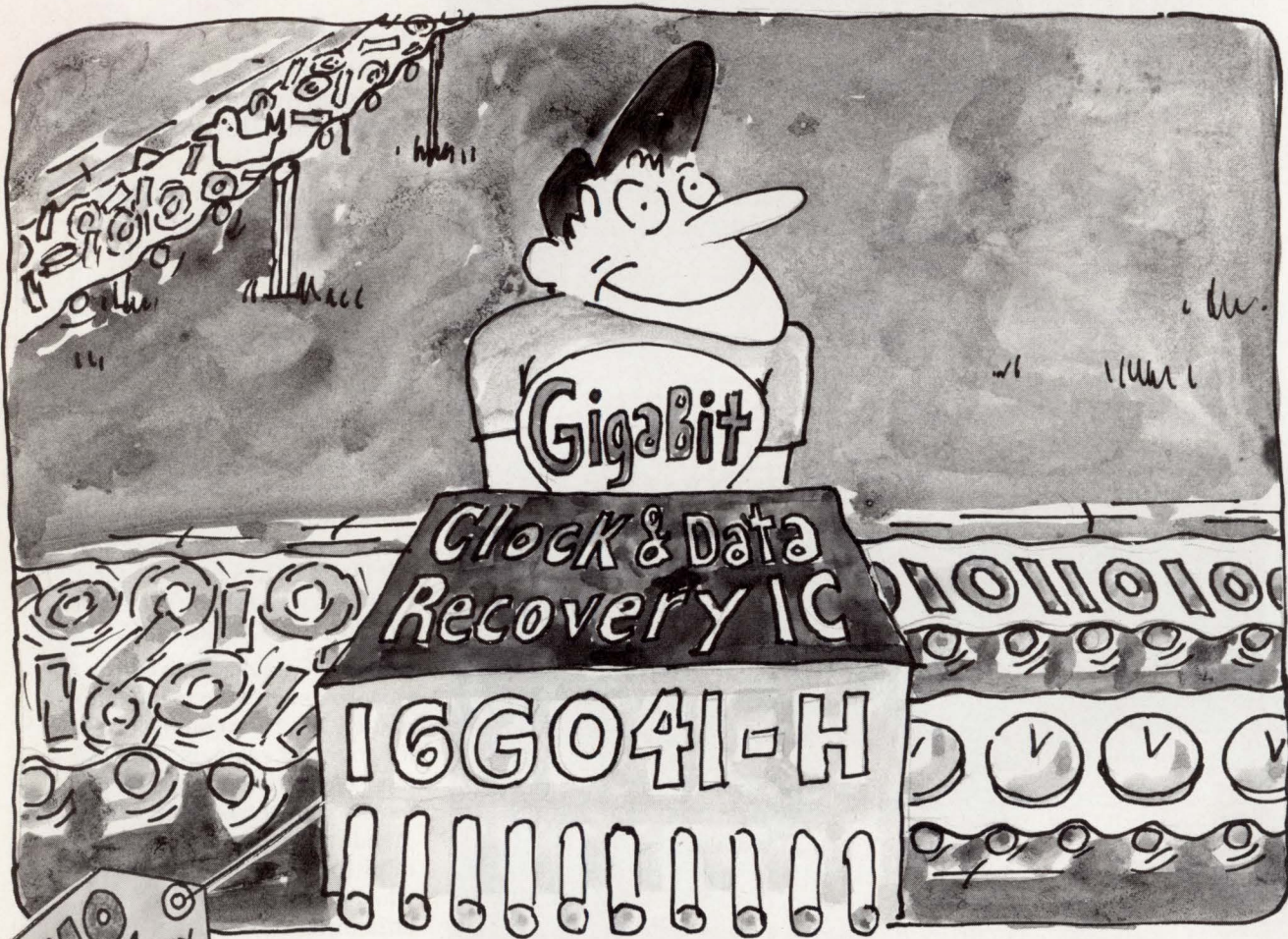

If you are designing a fiber optic receiver subsystem for applications requiring data rates from 100 to 625 Mbit/s NRZ, you should find out more about our PLL-based 16G041-H clock and data regenerator. It's a three terminal (data in, clock and data out) device in a compact 1.25 inch x 1.25 inch flatpack package.

The 16G041-H synchronizes an internal VCO directly to an incoming data stream and simultaneously retimes and regenerates the data, unlike SAW filter clock recovery circuits which first filter the clock signal from incoming data and then retime it. Moreover, the 16G041-H

generates a clock output in the absence of incoming data. The SAW filter does not.

To find out more about our PLL clock and data recovery circuit as well as the other members of our complete high speed fiber optic communications chip family including 16x16 crosspoint switch, limiting amplifier, transimpedance amplifiers, laser diode driver, LED driver, MUX and DEMUX, call us today. United States and Canada: (805) 499-0610, FAX (805) 499-2751; Europe: GIGA, at +45 4343 1588, FAX +45 4343 5967.

**GBL** GigaBit Logic

CIRCLE 166 FOR PRODUCT INFO.  
CIRCLE 167 FOR CAREER INFO.

# The Highest Density, Fastest, VME-Compatible Memory

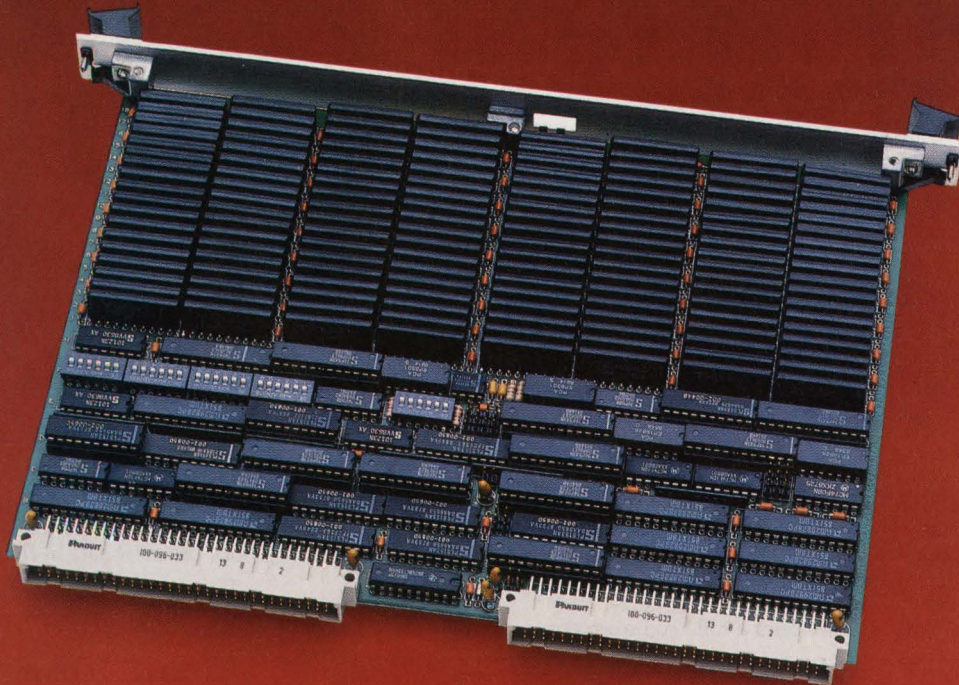

## Clearpoint, of course!

### Advanced Chip Technology and Design

Get up to 64 MB of fast, VME-compatible memory in a single slot. Designed with state-of-the-art 4 Mb DRAM technology, Clearpoint's VMERAM-FP1 assures higher reliability through lower component count. Each of Clearpoint's VME-compatible boards supports all VMEbus addressing and data transfer types—block mode (BLT), unaligned (UAT), and address only (ADO).

### The Fastest Byte Parity

The VMERAM-FP1, available in 4 to 64 MB, provides the fastest sustained block transfer timing available. Typical operating speeds boast 100 ns read and 74 ns write.

*Our company-wide pledge to deliver reliability and performance.*



Quality Commitment

Clearpoint is a registered trademark of Clearpoint Research Corporation.

### Error Detection and Correction Options

Clearpoint offers several EDC boards for the VMEbus and the VSB subsystem bus. Our proprietary second generation EDC chip set with "extra bit" automatically replaces a bad DRAM and re-maps the array to include the new location.

- VMERAM-EC1: EDC with 64-bit cache and Clearpoint's exclusive "extra bit" technology, the VMERAM-EC1 includes 24- and 32-bit addressing, 8-, 16-, and 32-bit data transfers, and is available in 2 to 64 MB densities.
- VMERAM: The VMERAM is the low-cost alternative for EDC memory, with pricing comparable to parity memory. The VMERAM is available in 2 to 16 MB densities.
- VSBRAM-EC1: Features include "extra-bit" EDC and dual 64-bit caches for simultaneous transfer capabilities. Dual-ported for the VMEbus and VSB subsystem bus, the VSBRAM-EC1 is available in 2 to 64 MB densities.

### The Clearpoint Difference

Clearpoint is a leading vendor in the VME marketplace, with the most comprehensive service program available. All Clearpoint memory products are covered by a lifetime warranty and a toll-free technical support hotline. Dedicated inventory in multiple locations worldwide support our 24-hour replacement program.

**Call or write to receive the facts:**

- Product/Services Catalog
- Designer's Guide
- Spec Sheets
- Newsletter
- Applications Video
- Quality Assurance Information



**CLEARPOINT**

Clearpoint Research Corporation  
35 Parkwood Drive  
Hopkinton, MA 01748  
1-800-CLEARPT  
(1-800-253-2778)

# WE APPROACH THE MEMORY BUSINESS FROM ONE POINT OF VIEW... YOURS.

At Micron Technology, we offer a full line of leading-edge RAM components in speeds and packages for virtually any application.

But the memory business is more than just parts — it's people.

That's why we offer a total commitment to

service and support, and a team of engineers and technical support personnel that are the most experienced memory professionals in the industry.

Because in the memory business there's only one point of view that counts. Yours.

Component Product Family	Memory Size (Total)	Org. (Bits)	Speed (ns)	Package					Special Features	Availability	Military Qualified	
				DIP	ZIP	SOJ	PLCC	TSOP				POFP
SRAMs	1MEG	x1,x4,x8	25-45	X		X			x4 option: OE	Now	2H90	
	256K	x1,x4,x8	20-45	X	X	X			x4 option: OE	Now	X	
	64K	x1,x4,x8	12-45	X		X			x4 options: Separate I/O, OE	Now	X	
	16K	x1,x4,x8	12-45	X		X			x4 options: Separate I/O, OE	Now	X	
Cache Data SRAMs	288K	x9	14-34				X		486 Compatible, Self-timed write, Fast toe 7ns, 486 Burst and extended burst support	Samp: 1H91, Prod: 2H91		
	144K	x18	20-35				X	X	386/486 Compatible, Fast toe 8ns, Auto write completion, Parity bits	Now		
	128K	x16	20-35				X	X	386 Compatible, Fast toe 8ns	Now		
Synchronous SRAMs	288K	x18	15-25				X		Registered address, chip enables and write control; Data latch, Fast toe 6ns, Byte write capability	Samp: 2H90, Prod: 1H91	Samp: 1H91	
	256K	x16	15-25				X					
SRAMs with Address Latch	288K	x18	15-35				X		Address, data and chip enable latches; Byte write capability, Fast toe 6ns, 3.0 Volt output buffer option	Samp: 2H90, Prod: 1H91	Samp: 1H91	
	256K	x16	15-35				X					
	16K	x8	100	X		X			Intel 8051 and 8096 compatible	Now	X	
	16K	x8	15-35	X		X			Compatible with high end micro controllers	Now	X	
FIFOs	18K	2Kx9	15-35	X			X		Family options: 300 mil DIP package, Programmable flags	Samp: 1H91	2H91	
	9K	1Kx9	15-35	X			X			Samp: 1H91	2H91	
	4.5K	512x9	15-35	X			X			Samp: 1H91	2H91	
DRAMs	4MEG	x1,x4,x8,x16	60-100	X	X	X		X	x4,x8 options: Write per bit x16 options: 2WE/1CAS; 1WE/2CAS and 1WE/1CAS with write per bit	x1,x4 Samp: Now, Prod: 1H91; x8,x16 Samp: 1H91	Samp: 1H91	
	1MEG	x1,x4,x16	70-120	X	X	X		X		Now	X	
	256K	x1,x4	100-120	X	X	X		X		Now	X	
	64K	x1	100-150	X			X			Now	X	
Quad CAS DRAMs	4MEG	x4	60-100				X		Separate CAS control for each DQ input/output, Enhanced write per bit capabilities	Samp: 1991		
	1MEG	x4	70-100				X			Now		
Pseudo Static DRAM	1MEG	x8	80-120	X			X	X	Unmultiplexed addresses, Simple refresh control	Samp: 2H90, Prod: 1H91		
Dual Port DRAMs (VRAMs)	1MEG	x4,x8	80-120		X	X			CMOS, Fully static SAM, Serial input, Split read transfer	Now	Samp: 1H91	
	256K	x4	100-120	X	X				CMOS, Fully static SAM, Serial input	Now	X	
Triple Port DRAMs	1MEG	x4,x8	80-120				X	X	CMOS, Two fully static SAMs, Transfer mask, Split transfers, Functional superset of 1MEG VRAM	Samp: Now, Prod: 2H90		
Module Product Family*	DRAM Modules	2MEG, 1MEG, 512K, 256K	x36	70-120		X		X		Industry standard pin-out	256K, 512K: Now; 1MEG, 2MEG Samp: 2H90	
		4MEG, 1MEG, 256K	x9	70-120			X	X		Industry standard pin-out	256K, 1MEG: Now; 4MEG Samp: 2H90	
		4MEG, 1MEG, 256K	x8	70-120			X	X		Industry standard pin-out	256K, 1MEG: Now; 4MEG Samp: 2H90	
	SRAM Modules	256K, 128K, 64K, 16K	x32	15-45		X				Industry standard pin-out with OE	16K, 64K: Now; 128K, 256K: 2H90	1H91
	64K, 32K	x16	30-45	X					Industry standard pin-out monolithic	Now	1H91	
	128K	x8	30-45	X					Compatible with 1MEG monolithic	Now	1H91	

\* Custom module and board-level product manufacturing services available.

## MICRON

TECHNOLOGY, INC.

2805 E. Columbia Rd., Boise, ID 83706 (208) 368-3900

CIRCLE 141



## DEVELOPMENT TOOL SIMULATES COMPLEX ICs VERY FAST

A development tool from Siemens AG simulates complex ICs up to 50 times faster than the universally used Spice (Simulation Program with Integrated Circuit Emphasis) program developed at the University of California at Berkeley in the late 1970s. The new tool, called Titan, drastically reduces the time to analyze a circuit. For instance, Titan can simulate a circuit with, say, 5000 transistors in just two hours, a job that would take Spice up to 100 hours.

Titan can also cope with much larger circuits. Whereas Spice was designed for devices with up to 500 transistors, the Siemens tool is targeted at circuits with more than 5000 transistors. These are analyzed with the same accuracy as Spice's: simulated and measured waveforms agree with each other to within 1%. Titan supports all types of circuits—bipolar, MOS, CMOS, GaAs, and others.

Titan's development was prompted by the challenges of ever-increasing circuit complexities. The critical path of a 4-Mbit DRAM, for example, contains some 6000 transistors. To analyze a read/write/read cycle in this case would take Spice more than a day of computing time on a large mainframe computer.

Moreover, Spice can't always come up with an initial solution and easily simulate strongly oscillating nonlinear circuits. It also lacks the flexibility needed for transistor modeling, and is difficult to maintain.

In shaping Titan, soft-

ware specialists at the Siemens research labs in Munich, Germany, pursued four goals: improving performance by at least one order of magnitude, developing new analysis methods, creating the appropriate software, and designing a flexible model interface.

Titan runs on workstations, vector processors, and mainframes. But top speed and efficiency for large circuits is achieved with vector processors, Siemens says. That's because all algorithms and data structures are designed for best vectoriza-

tion effects. What's more, a multidimensional table model for MOS transistors was developed, avoiding most of the problems associated with classical analytical models.

In addition to vectorization, Titan's high speed is derived from its exploitation of latency. Ordinarily, not all parts of a circuit in large devices are equally active at the same time. The Siemens program determines these differences in degree of activity and latency, and uses different computing time steps in the various circuit parts: Latent or less active parts

are computed in time steps that are larger than those used in more active parts.

Siemens engineers believe that Titan is among the most efficient circuit simulation tools developed so far. Not only does it speed up the simulation process and handle larger circuits, it also has a high degree of universality. Therefore, classical algorithms can be used. The tool is now being employed by a number of design groups at Siemens. Eventually, the tool may be offered to outside customers.

JOHN GOSCH

## IC PROMISES MORE COMPACT, RELIABLE ATE

In the real world, a design's success depends not only on the performance it achieves, but also on how well that performance matches users' needs and at what cost. In a classic case of balancing these engineering and product definition trade-offs, Brooktree Corp., San Diego, Calif., combined the load, driver, and comparator functions of automatic-test-equipment (ATE) pin electronics into one integrated circuit.

The resulting IC, the Bt698, has a high level of integration that offers ATE designers greater reliability, as well as the obvious savings in board space. The chip will make it easier to build the high-pin-count testers with tester-per-pin architectures that are in increasing demand.

To save space in the test head, designers previously resorted to making use of chip-and-wire hybrid assemblies. But these tech-

ATE LOAD, DRIVER, COMPARATOR OPTIONS			
	Chip-and-wire hybrid	PCB, packaged MSI solution	Bt698
Pc-board real estate	3 in. <sup>2</sup>	5 in. <sup>2</sup>	2.5 in. <sup>2</sup>
Quiescent power	3+ + W	2.5 W	1.6 W
IC count	10+	5	1
Reliability	Low	Medium	High
Heatsinking	Yes	Yes	No
Labor	Very high	Medium	Low
Price (100s)	\$150-\$200	\$130-\$175	\$130

niques raised both costs and power-dissipation levels (see the table).

The main considerations that went into the Bt698 were a need for 100-MHz performance, low power dissipation, and small die size. The 100-MHz speed is a de facto standard for high-performance ATE. The low power requirement and small die reduce cost because a standard economical package can be used and an adequate yield can be delivered.

The key trade-off that resulted was an unusual partition of the load function that distributes power to six low-cost transistors off the chip. This unusual

partitioning of the load function means that the Bt698 needs no exotic heatsinking or cooling scheme. It also means that the Bt698's worst-case load power of 250 mW permits the use of a 44-pin PLCC package.

Moving these transistors off chip increases the IC's reliability by lowering junction temperature. It also reduces the die size substantially. Including the transistors on the chip would raise power-dissipation levels to 4 W and add about \$75 to the IC's price, which is \$130 each in 100-piece lots, according to Brooktree.

To further reduce the die

IN THE ERA OF MegaChip™ TECHNOLOGIES

# APPLYING TI's BiCMOS

With more than 50 BiCMOS logic functions from Texas Instruments, you can beat tough bus-interface design challenges. Our free SamplePacs will show you how.

**S**pecially designed for use in bus-interface applications, our growing BiCMOS logic family can make the difference in getting data on and off the bus faster. These advanced functions that combine the best of bipolar and CMOS can help you attain higher system performance levels.

**Lowering power,  
maximizing speed**

For example, our BiCMOS devices can help you minimize power dissipation and maximize speed. Disabled currents are reduced by as much as 95% and active currents by as much as 50% compared to advanced bipolar equivalents.

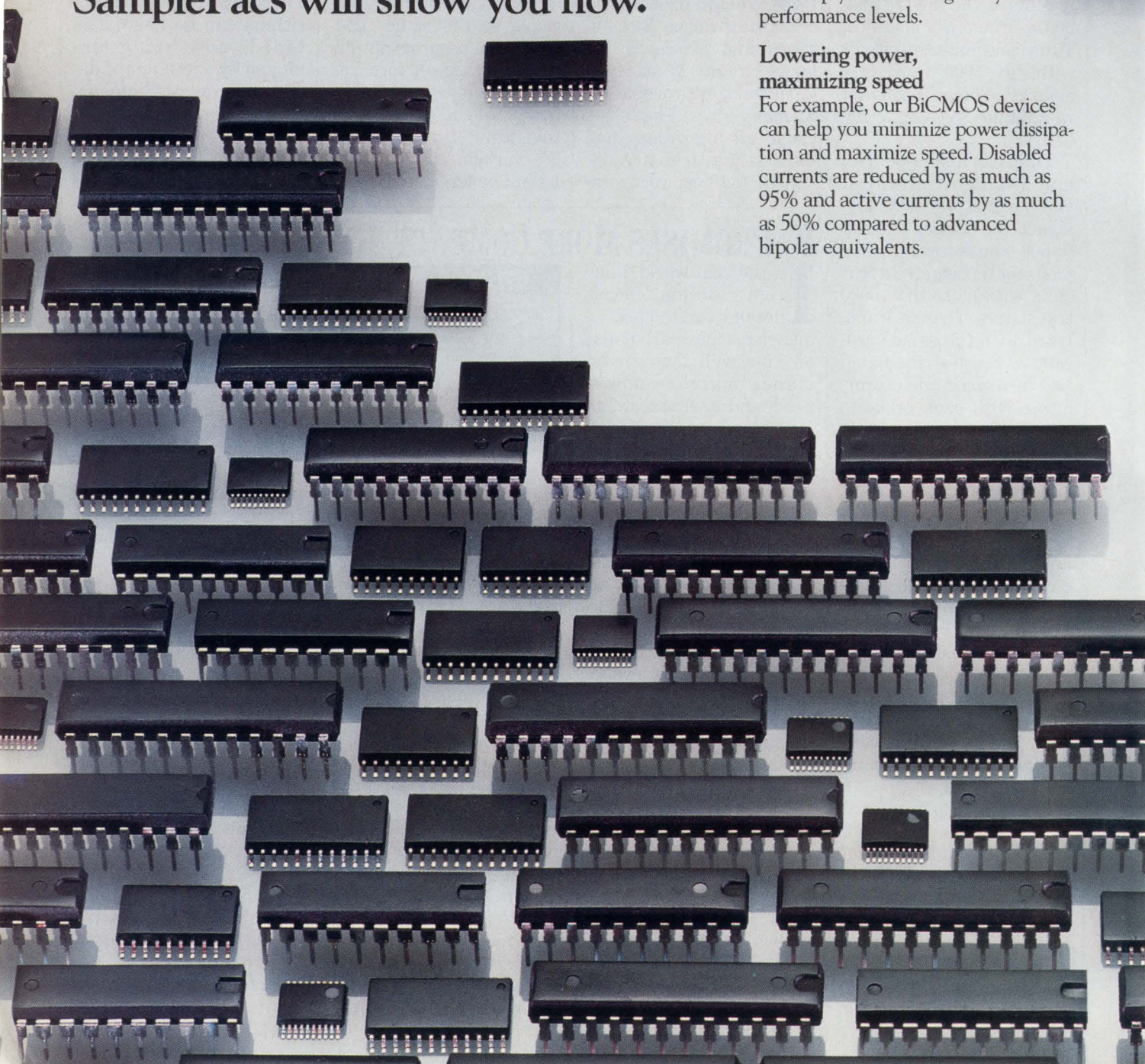

# DIFFERENCE

In fact, your system power savings can amount to more than 25%, and you should experience reduced switching noise as well.

Yet you can maximize system speed. Switching speeds are comparable to advanced bipolar devices and provide the high drive current required for today's industry-standard buses (48/64 mA commercial, 24/48 mA military).

## Gaining even greater performance

If you need even lower power and higher speeds, our submicron Advanced BiCMOS (ABT) family is the choice for you. Planned devices include 8-, 9-, and 10-bit buffers/drivers, transceivers, latches, registers, and registered and latched transceivers.

Our broad BiCMOS family also includes unique functions that can help you more quickly meet the design challenges involved with incident wave switching, driving MOS memories, and system testability.

## Assuring incident wave switching

Wider word widths and additional cards on backplanes are requiring higher drive currents to assure incident wave switching.

Our BiCMOS family delivers. With our low-impedance line drivers, you

get more "instantaneous" current even when impedances are as low as 25 ohms. You minimize transition "flat" spots that can degrade speed or cause oscillation at the receiving devices.

## Managing MOS memory loads

MOS memory array interfaces create the high-capacitive loading environments that can result in overshoot and undershoot conditions. As a result, system reliability suffers. To handle this situation, our BiCMOS memory drivers incorporate a series damping resistor output structure that delivers advanced system performance when driving 256K, 1M, and 4M DRAMs.

## Building in testability with SCOPE

It is becoming more difficult to accurately test today's highly integrated boards and systems, but TI's BiCMOS family contains your solution: SCOPE™ (System Controllability and Observability Partitioning Environment) octals.

Used in place of standard octals, SCOPE devices allow specific circuitry within an assembled module, board, or system to be isolated for verification and debugging without manual probing. Currently, our BiCMOS family includes an octal buffer, transceiver, D-type latch, and D-type flip-flop.

TI's SCOPE products are the first to conform to the Joint Test Action Group (JTAG) specifications adopted by the IEEE 1149.1 Test Standards Committee.

**Get your free SamplePac and sample our BiCMOS difference; call 1-800-336-5236, ext. 3008**

You can take your choice of our BiCMOS SamplePacs containing a free BiCMOS device, our latest advanced logic brochure, plus appropriate product data. Just call the number given above, or use the return card to let us know which SamplePac you need to begin applying TI's BiCMOS difference.

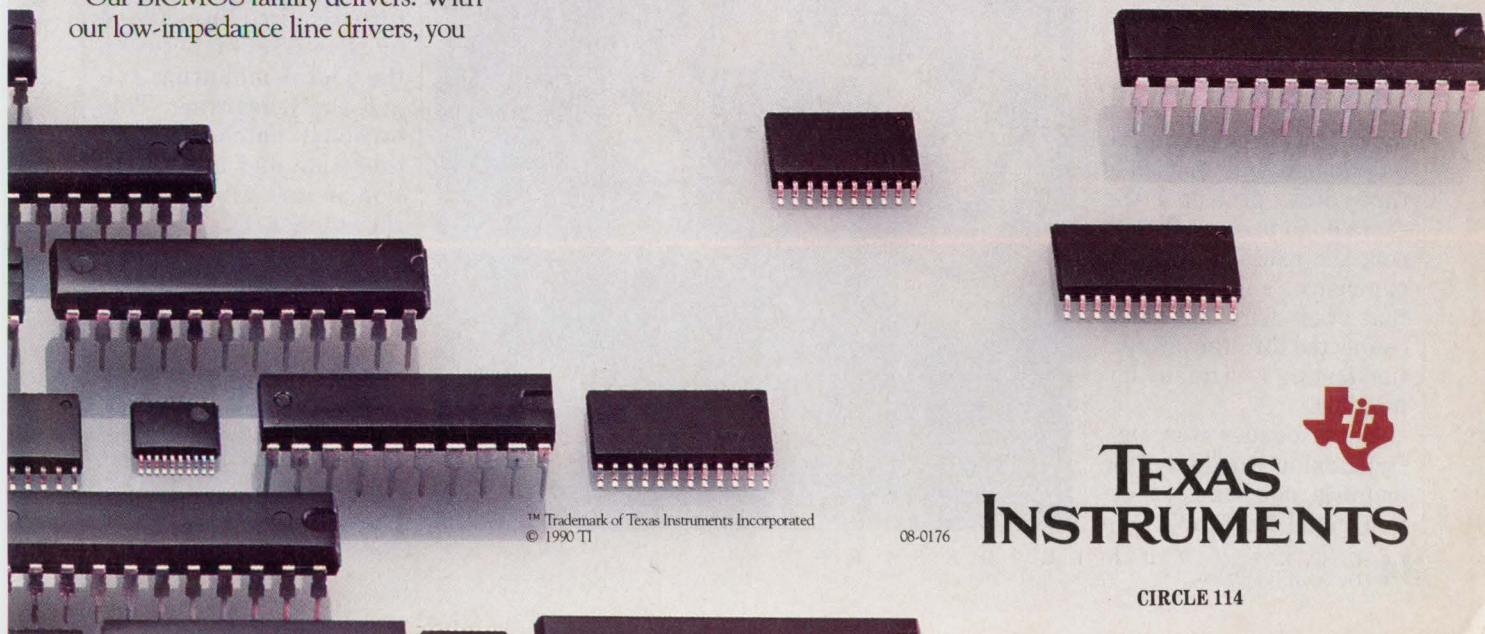
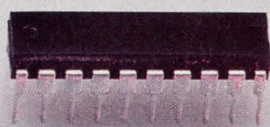
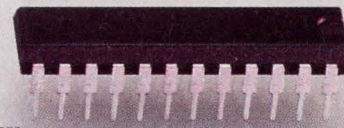
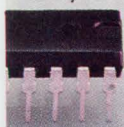

™ Trademark of Texas Instruments Incorporated  
© 1990 TI

08-0176

  
**TEXAS  
INSTRUMENTS**

CIRCLE 114

size while optimizing performance, Brooktree did its own custom layout. A semicustom chip would not reduce the size enough to produce the yield, and the resulting cost, needed to make the Bt698 viable, the company says.

Brooktree also had to pay close attention to maintaining flexibility, because it could be sacrificed to achieve higher integra-

tion. Consequently, the Bt698's comparator logic permits window or edge-strobed comparisons, or both. Also, the digital inputs are differential, so they can be driven by ECL, TTL, or CMOS devices. Finally, the load section's variable gain optimizes the load's transfer function, so the chip needs no external op amps or buffers.

JOHN NOVELLINO

## MIXING GOLD AND ALUMINUM BOND WIRES ON POWER ICs CUTS COST AND UPS RELIABILITY

A mixed-bonding technology development from SGS-Thomson, Agrate, Italy, and Phoenix, Ariz., enables power ICs to handle unusually high currents. The development involves combining thick aluminum and thin gold bond wires on the same chip.

Putting power ICs into practical packages offers numerous challenges to IC-package designers. One key challenge is to get high currents, as well as diagnostic and control signals on and off the chip, and in and out of the package.

Fine, gold bond wires typically used for ICs can't handle high currents. Using multiple gold wires may allow more current to be handled, but that adds three other problems: the extra bond pads waste silicon, the excessive gold is expensive, and to ensure that every wire is reliably connected through production testing is virtually impossible.

If the bonder was malfunctioning randomly (for instance, one bond connection could have only one

wire while all of the others have two, assuming that all connections are doubled), the cost of using redundant bond wires wouldn't help. Even thick gold wires aren't the answer—they add to the cost problem and are difficult to

bond (however, multiple bonds distributed over an IC's power transistors eliminate the need for multiple, extra-wide, metal traces to bring all of the current from each power device to single bond pads).

Thick aluminum bond wires, similar to those used on power transistors, solve the current-handling problem. Yet they can't be used for the signal connections because of the large die area needed for each bond. Hence, SGS-Thomson tried mixing thin gold and thick aluminum bond wires, and they made it work by incorporating a few tricks (*see the figure*).

For example, because gold is one of the few metals that will weld to aluminum, the copper leadframe is gold-plated. Moreover, apart from reasons of cost, gold must be used selec-

tively, which means only on the portions of the frame within the molded package. In addition, if the complete leadframe were to be gold-plated, it would contaminate the tinning bath in which the pins are dipped, leading to possible reliability problems.

The mixed-bonded chip shown in the photo, a half-bridge motor driver, is to be used in an automotive multiplexing system and can handle 20 A while driving a window-lift motor. The technology has also been used with a 10-A switching regulator IC.

The package, called the Multiwatt-8, is an advanced version of the basic Multiwatt package developed by SGS-Thomson over ten years ago. This version has 8 in-line leads on 0.1-in. centers, rather than the usual two rows of staggered leads. Eight leads are used for high-current applications where extra-wide printed-circuit metal tracks must handle the current without the penalty of an appreciable voltage drop.

The new package also has a larger die flag to accommodate today's large chips. The large die flag, in turn, required the addition of stress relief between the metal mounting tab and the leadframe. This involved notches on either side and a convolution in the tab between the notches.

These two features ensure dependable adhesion between the leadframe and molding compound and isolate the die mechanically from the tab.

For additional information call, Tom Hopkins at (602) 867-6288.

FRANK GOODENOUGH

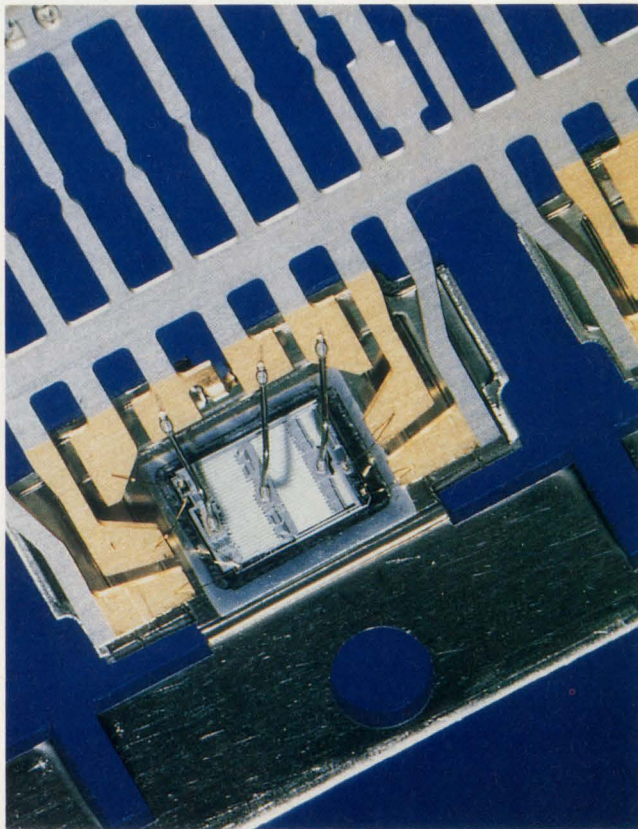

# New Directions for MIPS RISC

## An IDT RISC Technology Seminar

### Seminar Outline

8:30 a.m. — 1:00 p.m., lunch included

- I. RISC Technology and Application Trends
  - Workstations and embedded applications
- II. Performance Analysis
  - SPEC™ benchmarks
  - Embedded processor comparisons: 960 and 29K
- III. R3000 Architectural Overview
  - CPU and floating-point
- IV. New Directions for the MIPS Architecture
  - IDT RISController™ family:
    - R3001
    - R3051™/52™ and supporting chip set
  - IDT RISCore™
  - Next-generation MIPS R4000
- V. Applications Examples
  - Workstations
  - Embedded processing
  - Multiprocessing
- VI. Time-to-Market Strategies
  - Evaluation and prototype boards
  - Development platforms
  - RISC modules
- VII. IDT Future Roadmap

### Get the Facts

IDT's "New Directions for MIPS RISC" seminar provides information on the latest developments in RISC technology, from low-cost 32-bit RISC controllers for embedded systems to the next generation R4000 for single and multiprocessing machines.

This seminar is a must for engineering professionals involved in selecting a microprocessor platform for:

- Embedded controllers
- Workstations
- Multiprocessing
- Military systems
- Software development.

Learn how the R3000 family beats Intel's 960 and AMD's 29K families for cost-effective controller designs. Make an informed decision about RISC for your next-generation design—join us at the RISC seminar and discover how to make your next system a winner!

Seminars are subject to limited seating, so call the Seminar Hotline in the appropriate city to reserve your place.

<b>Alabama</b> Huntsville (407) 773-3412	October 31	<b>Maryland</b> Baltimore (301) 858-5423	October 30	<b>Texas</b> Austin (214) 490-6167	October 23
<b>Arizona</b> Phoenix (602) 860-2702	October 23	<b>Massachusetts</b> Boston (508) 898-9266	October 31 November 6	Dallas (214) 490-6167	October 24
<b>California</b> Encino (818) 981-4438	November 7	<b>Minnesota</b> Minneapolis (612) 932-2920	October 31	<b>Washington</b> Seattle (206) 453-8881	October 23
Irvine (714) 727-4438	November 6	<b>New Jersey</b> Fairfield (516) 536-4242	October 30	<b>Canada</b> Montreal (416) 612-0900	November 8
Santa Clara (408) 492-8350	October 30 November 7	<b>New York</b> Rochester (716) 777-4040	November 1	Ottawa (416) 612-0900	November 7
San Diego (619) 565-8797	November 8	<b>Oregon</b> Portland (503) 620-1931	October 24	Toronto (416) 612-0900	November 6
<b>Colorado</b> Denver (303) 799-3435	October 25	<b>Pennsylvania</b> Philadelphia (609) 596-8668	November 7		
<b>Florida</b> Orlando (407) 773-3412	November 1				
<b>Illinois</b> Chicago (708) 390-9696	October 30				



**Integrated  
Device Technology**

# TESTING CHANGE

## Integrate Dynamic Design, Material And Processing Creativity With GE.

Systems solutions from a single source. A spectrum of material technologies. Copolymers, alloys, composites. Leading-edge process development. The exclusive Engineering Design Database — unique design and analysis tools in a total system for plastics engineering. In-depth, worldwide market expertise.

Nova Biomedical's innovative Nucleus blood analyzer.  
**Materials:** PREVEX<sup>®</sup>, CYCOLAC<sup>®</sup> and LEXAN<sup>®</sup> resins;  
internal parts of ULTEM<sup>®</sup> resin. **Resources:** Part and tool  
design development, structural and mold filling analyses,  
material selection — a two-year program.

**Results:** Exclusive features; pre-emptive market  
positioning. Partnership product development —  
only from GE.

For more information, call:  
**(800) 845-0600**

CIRCLE 118



**GE Plastics**

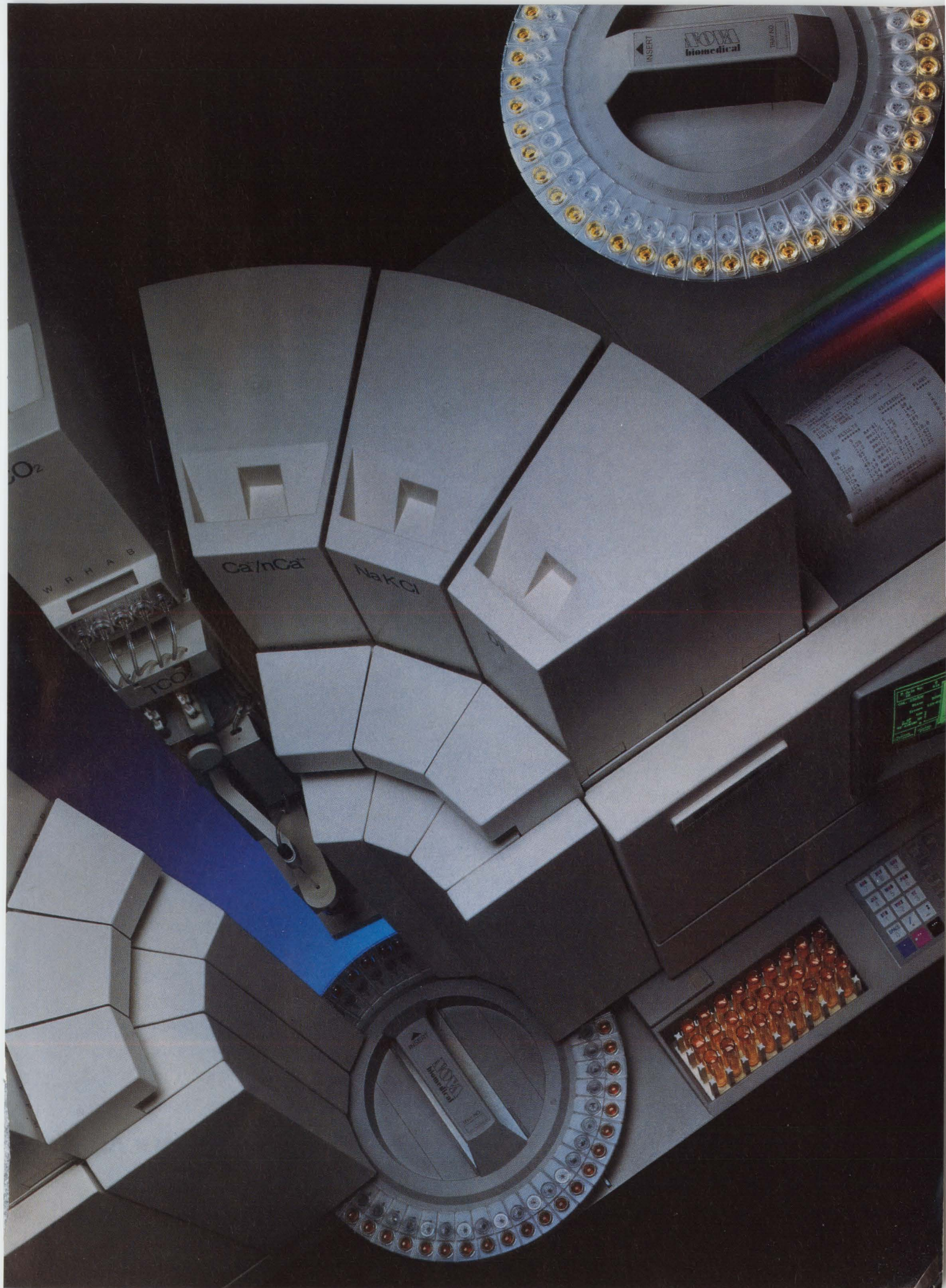

CO<sub>2</sub>

W R H A B

Ca/hCa

NaKCl

100

Printed: 11/11/00 11:11 AM  
Page: 1 of 1  
Job: 11111111  
Printer: 11111111

1 2 3 4 5 6 7 8 9 0  
\* \* \* \* \*  
F1 F2 F3 F4 F5 F6 F7 F8 F9 F10  
ESC

1 2 3 4 5 6 7 8 9 0  
\* \* \* \* \*  
F1 F2 F3 F4 F5 F6 F7 F8 F9 F10  
ESC

# GOOD ANALYSIS DOESN'T HAVE TO COST A FORTUNE.



Deep-seated quirks hidden within your complex designs. They can drive you crazy. Delay product time-to-market. And strain your design budget. But there is a solution.

And Simucad offers it now. In fact, in 1984 we wrote the textbook on cost-effective design analysis, with our industry-standard SILOS simulation software.

Now, the leader is back. With SILOS II, the world's most powerful interactive logic and fault simulation system. Analyze your subject, top-

down and bottom-up, for less than you'd expect. SILOS II spells hardware independence. And the ability to address every element of your design's complex personality—from circuit description to final verification.

Get a head start on your competition. With SILOS II, the essential analysis software. It'll improve both your mental and fiscal health. Call us today, (415) 487-9700.

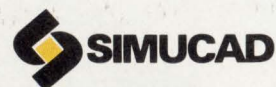



# BUSCON PREVIEW: MORE POWERFUL BOARDS

## COMING VME 64, STD 32, MULTIBUS I AND II, AND FUTUREBUS+ BOARD MAKERS EMPHASIZE "TOTAL" SOLUTIONS

ELECTRONIC DESIGN STAFF

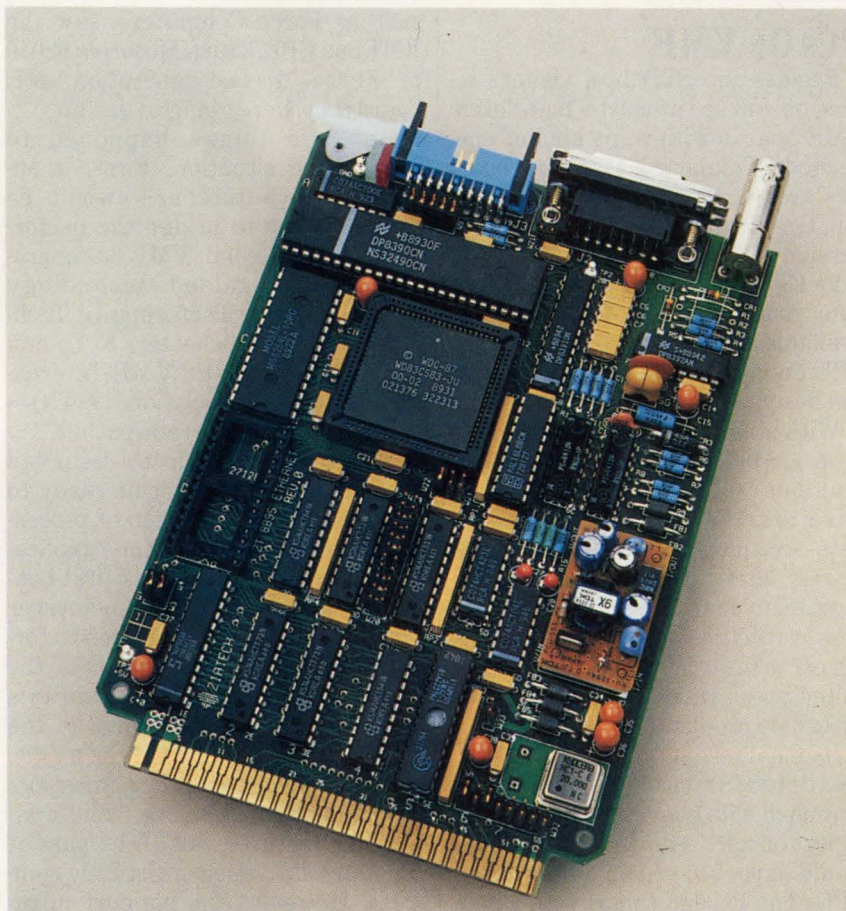

**1. A COMPLETE STD 32 BOARD**, with a newly designed connector, is coming from Ziatech—the ZT 8895 Ethernet interface for the STD bus. Compatible with 5- and 8-MHz 8088 series products, it supports true 16-bit I/O and 20- and 24-bit memory addressing, as well as thick (802.3 10BASE5), thin (802.3 10BASE2), and pre-802.3 interfaces. The board comes with a PROM socket and is compatible with many software drivers.

**T**his year's Buscon promises a broad spectrum of advanced board-level technologies. They range from the modest 8-bit I/O cards to 50+ MIPs cards sporting RISC processors, lots of memory, on-board SCSI, and the capability of transferring data in 64-bit blocks at close to 80 Mbytes/s. This Buscon also marks a turning point for the board-level industry: It's emerging from an industry with a handful of small companies assembling and selling boards, to one where companies must offer customers complete solutions—including software.

While Futurebus+ will be at Buscon, it's not going to steal the show as it has for the past few years. In fact, it's unexpected that any one technology will dominate the show floor—or seminars. Instead, we'll be looking at some of the early offspring of ideas announced at previous shows. Most notably, a rash of VME 64 hardware is expected from almost a dozen different vendors. In addition, the STD 32 bus will make its formal debut now that the connectors are commercially available.

Though many of the vendors will

## BUSCON PREVIEW

bid on the traditional real-time instrumentation and control business, a growing faction is eyeing the workstation and Unix-based server business. Both Digital Equipment Corp., Maynard, Mass., and Sun Microsystems Inc., Mountain View, Calif., have staked out space in the Marlboro, Mass. exposition hall, underscoring the heavy systems implications in the board-level business.

Furthermore, many board companies or divisions have swung over to the systems business. Representatives of Intel Corp., Hillsboro, Ore., for example, will sport "Intel Systems" name tags. Motorola's Microcomputer Division (MCD) switched to systems in dramatic fashion earlier this year with its VMEbus-based workstation announcement.

But despite the efforts of board makers in the software area, there's a perpetual shortfall of software as new hardware emerges. A strong trend over the past year-or-so is to include some kind of PC-compatible machine on the standard buses. This lets system designers take advantage of all the software at hand for DOS-based machines. It also greatly simplifies the job of supplying a friendly human interface to the system. In the case of the STD Bus, vendors adopted the bus and DOS operating system in total, simply exchanging the ISA bus for the STD.

This led to the early adoption of a multiplexing scheme for the 8-bit bus so that it could be fully PC/AT-compatible, handling 16-bit transfers. But the multiplexing scheme wasn't totally accepted; only a handful of STD board makers adopted it. Meanwhile, Ziatech Corp., San Luis Obispo, Calif., developed a fully compatible extension of the bus, allowing for full 32-bit transfers.

Since its introduction one year ago, the STD 32 bus has been the subject of much controversy among STD board makers. So far, only a small group of vendors has committed to the bus and have banded together under the title of Task Group 32. The group has finalized the specification, settled some potentially nagging legal questions, and contracted for the manufacture of the

special connector. Tooling on the connector is completed, and Ziatech, among others, will show the first real STD 32 systems this month with a working connector (*Fig. 1*).

Ziatech reports that at least nine products from three manufacturers will take to the show floor. Pivotal to the new products is a processor board from Ziatech with a 286-like processor designed as a multibus master using STD32's EISA-like protocols. Other products debuting include a high-performance ADC board—the first full 16-bit peripheral ever to emerge on STD, a digital I/O card, a 16-bit Arcnet card, and an arbitration board for the slot-zero function. Jim Eckford, Ziatech's vice president of marketing, hints that a full-blown 32-bit processor card with an Intel 960 is in the works, but won't be ready at show time.

### PCs ON VME

Besides the STD bus, visitors to Buscon will see at least a half-dozen VME boards with some kind of embedded PCs aboard. One pioneer in this area is RadiSys Corp., Beaverton, Ore. The firm developed its own version of a mezzanine bus, which it calls EPC (embedded PC). The company has a number of EPC boards available as well as a selection of CPU engines. Some new EPC magic can be expected from RadiSys.

With all of the talk of 32-, 64-, and even 128-bit buses, it's obvious that Multibus I—generally considered to have started the open-bus business—hasn't been headlining many stories lately. But Intel and other Multibus I makers report that business is still brisk despite a slight falling off to the other more "flashy" architectures. Intel continues to release new products.

Its most recent product is a single-board 80386SX-based PC (*Fig. 2*). It's crammed with everything one would expect on a PC—and everything one would expect to see on a Multibus I CPU. The PC end comes with a pair of serial ports, a parallel port, floppy- and hard-disk controllers, keyboard and mouse connections, a math coprocessor socket, and a piggy-backed VGA graphics board. On the

Multibus I side, there's full Multibus I interface and control circuitry, dual-ported memory, and an iSBX expansion port.

Intel points out that one of the more important aspects of the board concerns how it adapts to a real-time environment. The board can run DOS as a task in its iRMX real-time operating system. Obviously, the DOS task takes a low priority so that the real-time performance isn't impaired. And while DOS performance suffers as the system gets involved in higher-priority tasks, for most applications there's little penalty.

As one part of the board community looks at PC compatibles, others face the next generation in performance. As recently as last Buscon in February, optimists looked to Futurebus+ as the next step in standard-board performance. Many leaders, such as Force Computers, saw the VMEbus CPU with a Motorola 68040 or 88100 as the last-generation VME board they were going to design.

But two things happened to change the situation. First, it appears that Futurebus+ won't be ready in time to bridge the performance gap. Second, VME 64—a previously unheralded technology spearheaded by Performance Technologies Inc., Rochester, N.Y., and now adopted by the VME International Trade Association (VITA)—provides a VME upgrade path.

Moreover, though it's believed that Futurebus+ won't be ready to serve the next generation of processor technology for real-time applications, it's likely to have its first trial in advanced workstation and server applications. DEC is expected to formally announce its profile B of the P896.2 specification. The B profile is a stripped-down I/O version of the bus that removes much of the magic, such as cache coherency, message passing and packet-mode transfers.

These features will all be part of the A profile, which is virtually complete. However, the support infrastructure for the bus hasn't yet emerged. With the aggressive stance of both DEC and Sun Microsystems in the Futurebus+ arena, it was widely believed that semicon-

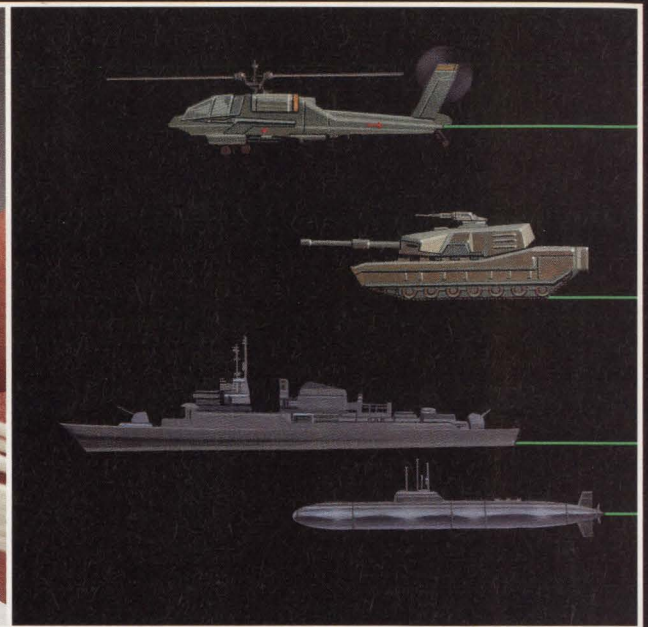
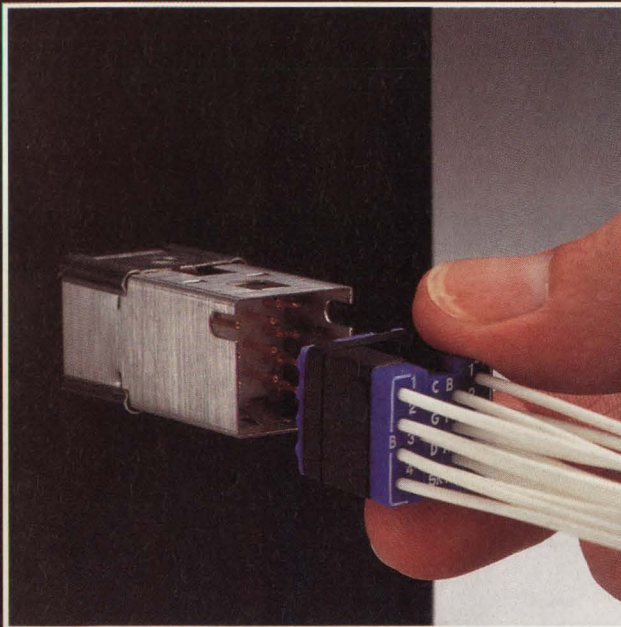

# The mil-spec solderless switch for land, sea or air.

Our QUIK-CONNECT™ module is physically separate from the switch. It can be pre-wired without solder and pre-checked for correct continuity. The QUIK-CONNECT™ module can then simply be pressed into place in the Vivisun Series 95 switch.



It's also compatible with NVIS night vision goggles per MIL-L-85762A. A unique optics system eliminates the glare. When voltages are

trimmed, the switch is easily readable with the unaided eye. It's also readable in direct sunlight and deadface when not energized.

Compact and light. No other Mil-Spec switch can match it. Options: High-Impact Shock • Dustproof/Dripproof/Watertight/Splashproof • Split Ground • Standard Solder Terminations • EMI  
Contact us today.



**AEROSPACE OPTICS INC.**

3201 Sandy Lane, Fort Worth, Texas 76112  
(817) 451-1141 • Telex 75-8461 • Fax (817) 654-3405

*Vivisun Series 95,  
the advanced QUIK-CONNECT™  
solderless pushbutton switch.*

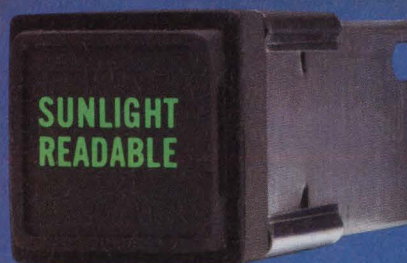

SERIES  
**VIVISUN 95**™

## BUSCON PREVIEW

ductor makers would jump on the bandwagon immediately and offer a broad selection of controller and interface chips. Instead, the major manufacturers have played their cards very close to the vest and developed custom interface and controller chips, rather than look to the IC makers for standard products.

Texas Instruments Inc., Dallas, National Semiconductor Corp., Sunnyvale, Calif., and the Philips Components-Signetics Co., Sunnyvale, Calif., have said they'll produce standard chips. But only an interface chip from National and samples of a chip set from Signetics have emerged (*ELECTRONIC DESIGN*, May 10, p. 63). Indications are that some new introductions will be made, but chip makers have stood back a bit to see where the market will go.

The hiccup in the reality schedule of Futurebus+ left a gap in performance for VMEbus systems developers. VMEbus has been stretched in performance through various approaches, and there's little room to add more. On one side, performance was increased by applying very high-performance mezzanine buses, such as Heurikon's CoreBus; Matrix' DBus; the EVSB bus from Motorola Semiconductor Products, Phoenix, Ariz.; and Radstone Technology's APEX bus. In addition, the VSB bus standard on the P2 connector was also used to enhance performance.

On the other side, vendors added multiple on-board local buses to do as much processing on the main CPU card as possible, leaving only I/O functions on the main system bus. Still, VMEbus system performance can't keep up with the demands of newer processors. The response is to expand the bus through the clever use of the existing address lines during block transfers.

Because addresses aren't needed in block transfers where sequential addresses are transmitted, the VME 64 approach uses the address lines to transfer data after the starting address is sent. This approach is fully compatible with existing VME hardware, yet provides a full 64-bit data path for boards in the system using VME 64. Data-transfer rates close to

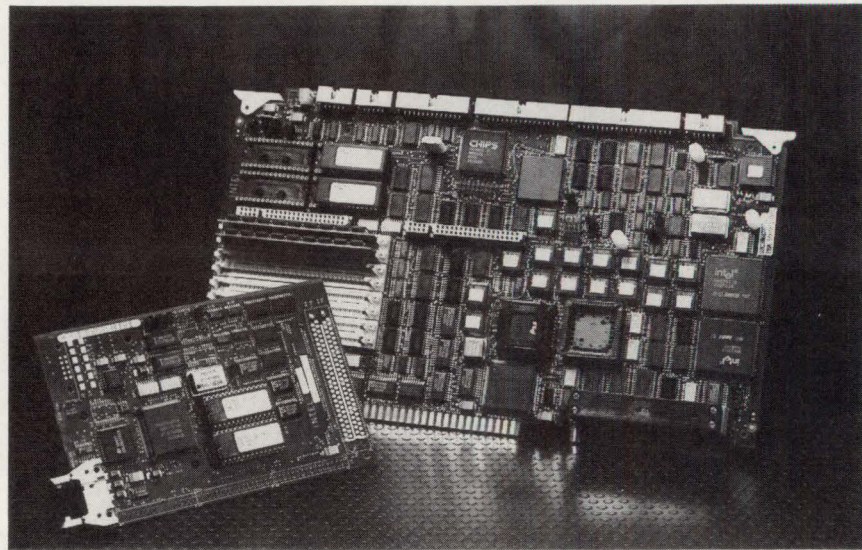

**2. THIS SINGLE BOARD** (background) from Intel, the iSBC 386SX, has everything one would expect from an 80386SX Multibus I PC. The iSBC 272 graphics module (foreground) piggy-backs onto the main board to provide VGA graphics.

the theoretical 80 Mbytes/s have been achieved, and they promise to carry VME at least through another processor generation.

While the VME community is stirring up its customers with 64-bit transfers, Multibus II is seeing a revitalization. Like their VME cousins, Multibus II manufacturers envision Futurebus+ as a path to higher performance. However, its model considers the bus as a high-performance, cache-coherent processor-to-memory architecture, and not as an I/O bus. Intel, the industry's leading Multibus II manufacturer, is billing Multibus II as the I/O of Futurebus+. Intel is capitalizing on some of the activity surrounding Futurebus+ by demonstrating that Multibus II already has many of the advanced features of Futurebus+, such as autoconfiguration, and it's available now. Intel also claims that when Futurebus+ is available, it will provide a smooth bridge for performance enhancements.

Multibus II also got a boost earlier this year when Siemens, the largest Multibus II maker in Europe, decided to market its products here, to join the Multibus II Manufacturer's Group, and to share technical information with U.S. Multibus makers. The move gives Multibus a leg up in a badly needed area, which is having a

critical mass of products available. Multibus II sales have steadily increased over the past year, but still fall far behind VMEbus.

Ten years ago, the board business began as a standard way of adding memory to a processor system because there wasn't enough room on one board. Today, open-architecture systems battle it out against proprietary bus systems for control of real-time applications, workstations, and servers. Traditionally, proprietary buses have held the lead.

But that may soon change. The two hot areas to look for exceptional sales increases of board-level products are in workstations and servers. Most industry leaders are already looking at standard buses; DEC is turning to Futurebus+, VME, and TurboChannel, while Sun is taking a similar stance, replacing TurboChannel with its own SBUS. IBM Corp., Armonk, N.Y., is sticking to its for its RISC-based workstation. And other workstation and minicomputer makers have begun to take a long, hard look at open, standard-architecture buses. □

### HOW VALUABLE?

HIGHLY  
MODERATELY  
SLIGHTLY

### CIRCLE

528  
529  
530

# VGA

## Get On Board.

Introducing VGA that fits your motherboard and your budget.

To put VGA graphics on your motherboard, you need a cost-efficient, highly integrated, powerful solution that uses minimal board space. You need the new CL-GD5320 Enhanced VGA-Compatible Graphics Chip from Cirrus Logic.

Use it to incorporate full 16-bit or 8-bit VGA into low-cost personal computers. You only need two industry standard 256K x 4 DRAMs and as few as five other ICs. Whatever memory speed you select — 80ns, 100ns, or 120ns — you'll get a complete VGA display system with greater performance than systems using a more expensive solution with 64K x 4 DRAMs.

You don't sacrifice features. You get 16-bit and 8-bit support for the VGA graphics standard, and full, register-level backwards compatibility. For maximum performance, it has an 8/16-bit CPU interface, independent video and DRAM clocks,

internal FIFOs, and page mode DRAM access. And it will interface to both analog (PS/2 and multi-sync) and TTL monitors.

You can also pick a ready-to-use solution that's right for you. Anything from a chip with full BIOS, drivers, utilities, user's manual, and documentation — to a complete manufacturing kit including everything you need to quickly move into high-volume production.

Make your PC more competitive and save time, space, and money. Call Cirrus Logic today.

Get on board. Call today for more information on our motherboard VGA solutions. Call 1-800-952-6300. Ask for dept. LM32.

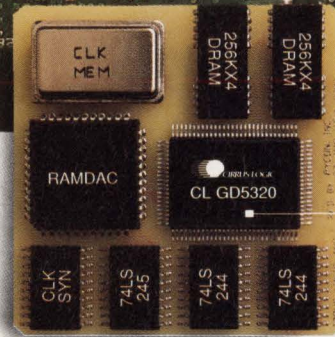

This full 16-bit CL-GD5320 lets you implement 16-bit or 8-bit VGA capabilities on your motherboard with as few as 5 other chips and two 256K x 4 DRAMs. Get a complete solution that saves time, space, power, and expense. You still get all the speed, features and flexibility you're looking for.

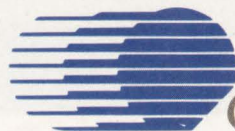

CIRRUS LOGIC

C L O S I N G T H E G A P

# Here's one reason that over half of all SCSI devices sold are NCR.

*We created the market... and we still lead the way.*

Meet NCR's SCSI development team. In 1983, they gave the computer industry its first SCSI device. By providing easy connectability and significantly reducing time to market, a new product era was born.

Since then needs have changed. By combining our system skills, high-performance standard cell methodology, and in-house manufacturing,

NCR has maintained its leadership role with innovative new ideas

like the 53C700 product family. And the joint development of LADDR — a new architecture aimed at cutting the development time of OS/2 device drivers by 90%.

Today SCSI is becoming the leading I/O standard — adopted by industry giants like Apple, IBM, HP, and DEC. And no one is selling more SCSI chip level products than NCR. In fact, no one even comes close.

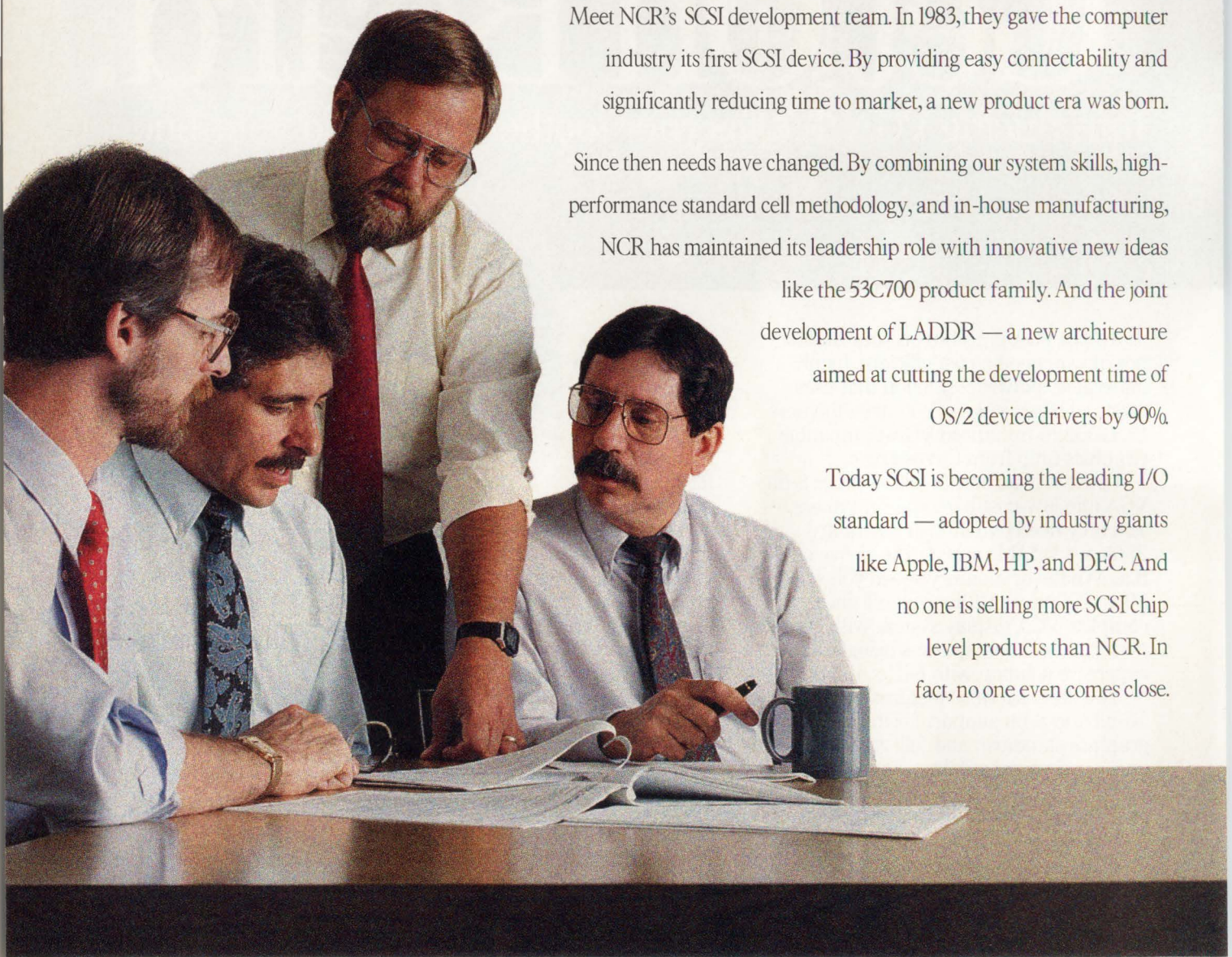

**Part of the NCR SCSI Development Team:** (left to right)  
**Jerry Armstrong**, Sr. Software Engineer; **Harry Mason**, Strategic Marketing Manager; **John Lohmeyer**, NCR Sr. Consulting Engineer and Chairman of the ANSI X3T9.2 Committee and **Dave Skinner**, SCSI Product Manager.



**Worldwide Sales Headquarters**  
3130 De La Cruz Boulevard, Suite 209  
Santa Clara, California 95054  
1-800-334-5454

New Product  
Announcement!

# Here's another.

The NCR 53C700 SCSI I/O Processor...  
So good, *Electronic Design* named it the  
product of the year.

"You can't tell a good SCSI chip just by looking at it..." and according to *Electronic Design*, NCR's 53C700 is the best there is.

The only third generation SCSI device on the market today, it concentrates all the functions of an intelligent SCSI adapter board on a single, smart and extremely fast, chip... for about 15% of the cost.

As the first SCSI I/O processor on a chip, the 53C700 allows your CPU to work at maximum speed while initiating I/O operations up to thousands of times faster than any non-intelligent host adapter. DMA controllers can burst data at speeds of up to 50 Mbytes/s. This new chip cuts down system time hookup to a fraction of what it has been.

Those are just a few of the reasons *Electronic Design's* "Best of the Digital IC's" award went to NCR's 53C700 last year.

## And now the NCR 53C710!

For the complete story on the NCR SCSI product line featuring the new 53C710, as well as the upcoming SCSI seminars with the NCR SCSI Development Team, please call:

**1-800-334-5454**



**NCR**

*Creating value*

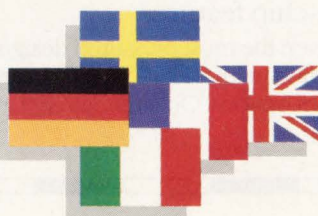

### European Sales Headquarters

Gustav-Heinemann-Ring 133  
8000 Munchen 83  
West Germany  
49 89 632202



CIRCLE 154

### Asia/Pacific Sales Headquarters

2501 Vicwood Plaza  
199 Des Voeux Road  
Central Hong Kong  
852 859 6044



S-MOS MICROCOMPUTERS  
TAKE THE PRESSURE  
OFF YOU  
AND YOUR SYSTEM.  
.....

**Extend battery life up to 10 years**

Now that's a hot subject.

Fortunately, our S-MOS 4-bit SMC6200 Microcomputers (MCU) are a cool alternative for today's power-hungry designs. S-MOS MCU's offer the world's lowest current consumption— $0.9 \mu\text{A}^{\dagger}$ —enabling you to extend the life of your battery up to 10 years.

**On-chip features**

Even the most pressured designers will find relief with all the SMC6200 Series options. On chip Battery Level

<sup>†</sup>Typical





Detect (BLD) circuits signal a low battery to your display. Software selectable twin clocks let you optimize your power consumption. A wide range of on-chip ROM and RAM, I/O ports and on-chip LCD drivers. As well as many other high performance peripherals. Plus, S-MOS offers powerful, easy-to-use PC-based development tools and add-on hardware that help you develop applications quickly.

### S-MOS 4-Bit Microcomputers

Part Number	Memory (bits)		LCD Drivers		Features
	ROM	RAM	Common	Segment	
SMC6214	4096 x 12	208 x 4	3 or 4	32	*AC, **BLD, Timer Twin Clock
SMC6215		488 x 4		50	
***SMC6232	2048 x 12	144 x 4	3 or 4	38	AC, Counter, BLD
***SMC6235	4096 x 12	574 x 4	3 or 4	48	Sound Generator Counter, BLD, AC
SMC6246	6144 x 12	640 x 4	8 or 16	40	Sound Generator Twin Clock, BLD
SMC6266	6144 x 12	1024 x 4	N/A	N/A	2 Channel AC Counter, Twin Clock
***SMC6281	1024 x 12	96 x 4	3 or 4	26	Melody Generator BLD, AC

\*Analog Comparator (AC) \*\*Battery Level Detect (BLD) \*\*\* Microcomputers running as low as 0.9V

Take the pressure off now. For a Free "Create the Future" Mouse Pad and our S-MOS Microcomputer Technical Guide, just call 1-800-888-1967 ext. 123. And move full-steam ahead.

*ASICs, Microcomputers,  
Memories & ChipSets*

**S-MOS**  
SYSTEMS

*A Seiko Epson Affiliate*

CIRCLE 136

**FLUKE®**



**PHILIPS**

Our free PC test system catalog has 17 bits, 0.5 ps,  
+27 dBm, 2.3 GHz, 500 MS/s, and 2 staples.

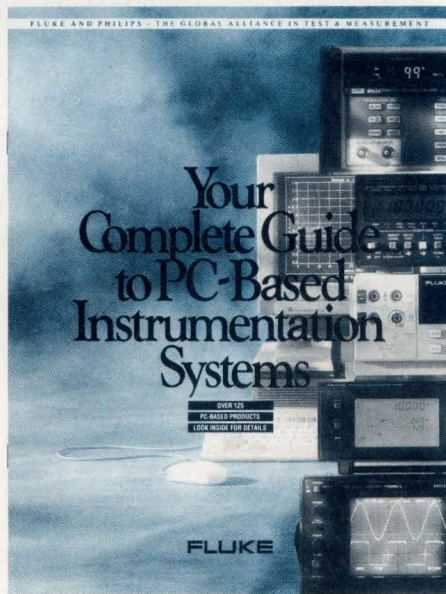

Find everything you need to know about our PC test system instruments and software in one concise catalog. Such as digital multimeters, signal sources and digital storage oscilloscopes. Plus counters, switches, test software, and data acquisition hardware. The catalog even describes

the free workshops and technical support that bring it all together.

It's yours when you call **1-800-44-FLUKE**. Ask for extension 701. You'll see we have every detail covered.

Right down to the staples.

John Fluke Mfg. Co., Inc., P.O. Box 9090, M/S 250C, Everett, WA 98206-9090. U.S. (206) 356-5440. Canada (416) 890-7600. Other countries: (206) 356-5500. © 1990. All rights reserved. Ad. no. 0501-PC.

PERSONAL ANSWERS.

**FLUKE®**

MODULES CAN BE PIECED TOGETHER  
FOR DIFFERENT CONFIGURATIONS,  
UP TO 386SX

# TINY MODULES FORM COMPLETE EMBEDDED PCs

RICHARD NASS

**T**he growing popularity of the PC as an embedded intelligent controller has spawned many single-board industrial-grade PCs. The applications for these PCs run the gamut of performance requirements, from simple data preprocessing and coordination to complex data handling and heavy-duty number-crunching. Such PCs are typically implemented on cards using the STDbus, AT-bus, and several proprietary formats. However, because industrial PCs are both power- (heat) and board-area limited, the boards are often housed in sealed enclosures with little or no ventilation. In addition, the space available to hold the boards may be restricted.

To meet the diverse requirements of most industrial applications, a trio of reduced-size computer boards from Ampro Computers, the CoreModule/XT, /286, and /386SX, deliver desktop computing power in palm-sized 3.6-by-3.8-in. modules that are only 0.6-in. thick (*Fig. 1*). All of the boards include an expansion pin-and-socket connector arrangement that allows additional boards to be stacked on top of each other, somewhat resembling building blocks. Those additional boards might typically include I/O lines, communication ports, IEEE-488 interfaces, and so on.

The XT version, whose performance is about four times that of the original IBM PC, is IBM PC/XT-compatible and runs all compatible software. It contains a 10-MHz NEC V20 microprocessor, similar to the 8088 processor.

The 286 version, based on the 80286 microprocessor, runs at 16 MHz. The high-end

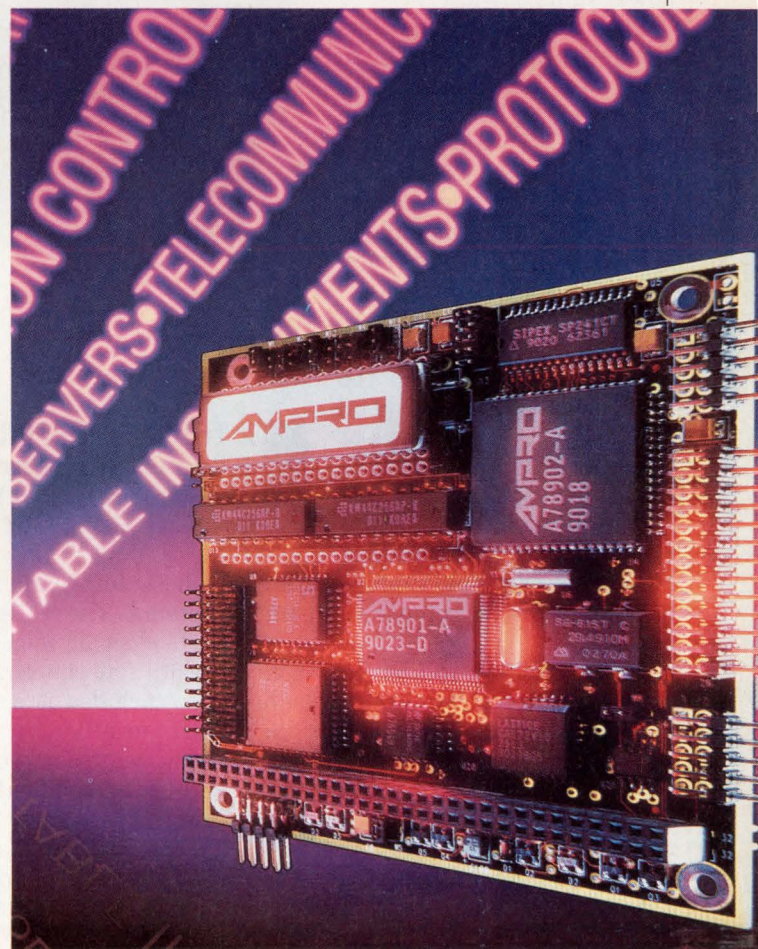

386SX module incorporates an Intel 80386SX processor that also runs at a minimum of 16 MHz. The XT-version can hold from 256 kbytes to 2 Mbytes of RAM. EMS (Extended Memory Specification) 4.0 is built into the board's chip set. The boards can also hold either 256-kbyte-by-4-bit or 1-Mbyte-by-4-bit DIP DRAMS.

There are two sockets on board for solid-state memory, which can be either EPROM,

## PALM-SIZED PC MODULES

flash EPROM, or SRAM. These sockets will support up to 512 kbytes of memory each. Additional sockets are available on an expansion board. With the solid-state memory, these devices can be accessed just as a floppy disk would.

A small header is used to connect a coprocessor daughterboard for floating-point math. On-board are a parallel and serial port, as well as a real-time clock. The clock is run by the system power supply. A battery back-up helps keep the clock running after the system power shuts down.

Each module contains a bus header, rather than an edge connector, for connection to other devices. This is because Ampro didn't want to resort to using a backplane or card cage. Other modules can be added to the base module by simply stacking them directly on top of each another. A female header is located on the component side of the board, with a male header on the back. Two plastic or metal standoffs sit on the edges of the boards opposite the connector to form a sturdy construction, and to add resistance to shock and vibration.

By stacking multiple modules, users can configure a complete system (Fig. 2).

A later release will have all connections done with straight-out male headers. Users can then mount the board, component-side down, and plug it into another pc board, making a basic PC engine. A good example comes while building a piece of equipment containing lots of external logic, such as additional digital or parallel I/O or some other type of interface that would drive various pieces of equipment within an embedded system. Users could build a PC board containing all of the required application-specific logic. Then, with the female headers, the board could be plugged in as if it were a big chip. In this case, the board acts as a component, rather than a board-level product.

Modules can also be used with other Ampro peripheral boards. The XT board will have a companion product called the MiniModule/FSS. The FSS stands for floppy, serial, and SCSI because it contains a floppy-disk controller, a second serial port, and a SCSI interface.

In all, there are 12 module boards. The first few started as display con-

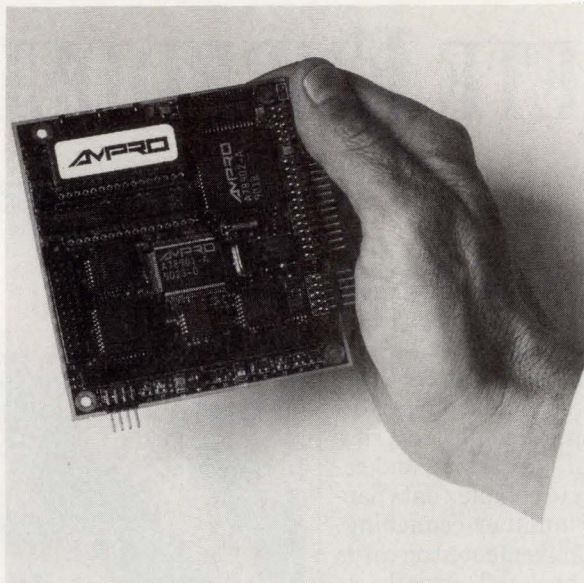

**1. THOUGH IT'S FORM FACTOR** is quite small, the CoreModule boards contain all of the functionality of full-size PCs. The high-end board holds an 80386SX processor. Shown is the CoreModule/XT with its NEC V20 processor.

trollers for CGA, EGA, and VGA systems. The VGA controller supports electroluminescent and liquid-crystal flat panels as well as CRTs. Also included is a CGA-compatible LCD controller.

One controller works with the Private Eye, a miniature 1-in.<sup>2</sup> CGA-compatible display from Reflection Technology, Waltham, Mass., that's used for portable applications. Other modules include a dual serial-parallel board for I/O expansion, an Arcnet network controller, a 2400-baud modem, and a recently announced IEEE-488 minimodule. Ampro will soon announce a send-only fax version of the 2400-baud modem. One last module is an IDE (Integrated Drive Electronics) interface. However, it's incompatible with the CoreModule/XT because it requires a 16-bit I/O bus.

Applications for the boards span a vast range and more continue to emerge. "It's almost easier to think of the few applications that can't use the modules than those that can," says Paul Rosenfeld, vice president of marketing for Ampro. Applications appear anywhere that space is at a premium. A standalone device on a network, such as a printer, is one particular application that stands out. A PC is needed to tie into the network, then the printer is connected to the PC. With the CoreModule, the PC could exist inside the printer, because the display, keyboard, and other components aren't required.

Another board application involves portable devices. A portable data-entry terminal is a good place for a space-saving module, one where users walk through a warehouse entering data. The data can be stored temporarily and later downloaded to another system. Other applications where space needs to be conserved include any type of portable test or medical equipment, as well as portable communications.

The boards have a high reliability factor built-in. Aside from the solid-state disk capability on the board, there aren't any sockets. All components are surface-mounted to the board. No backplane exists and there's nothing to plug into. As a result, there's no worry of anything falling out or getting loose from movement. All components are of the very-low-power CMOS variety. The actual power consumption is less than 1.25 W.

The boards operate over a 0-to-70°C temperature range, so fans or cooling devices aren't required. Although mean-time-between-failure calculations haven't arrived, similar boards are running with MTBFs in the 100,000-to-200,000-hour range.

XT products typically can't store configuration information. This capability is critical for embedded configurations, so that if the system re-

AT&T's new ECL ASICs let you

opt for speed and keep your cool.

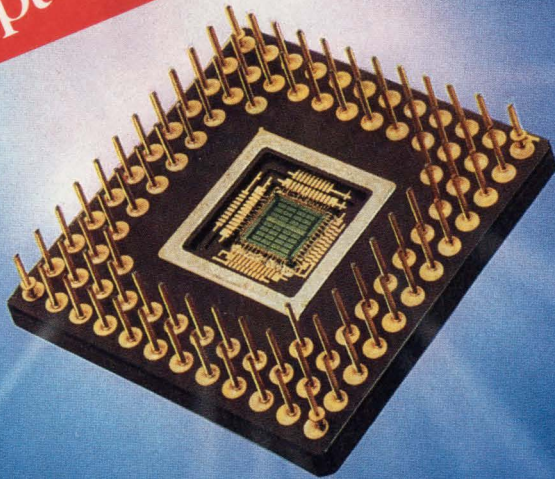

Ready for gate arrays and standard cell ICs that offer superior design solutions? Our 80 ps BEST-1 process is ready to deliver them.

High speed with low power is one part of AT&T's BEST1 (Bipolar Enhanced Self-Aligned Technology) story; cost-effective ASIC development is another.

Our 1K, 4K and 9K arrays and our 20K gate complexity standard cell ICs share a common function library, so you can prototype with quick-turn gate arrays—then easily convert to standard cells from the world's number one standard cell supplier, for high-volume, low-cost production.

Flexibility? Our ECL ASICs offer more than 200 ECL or TTL input, output or bi-directional pins. Our library provides over 50 function blocks, each available in three speed/power ratings (e.g. 3, 4 and 6mW D-FFs at .5, 1 and 2 GHz unloaded) and 40 ECL/TTL I/O buffer choices.

Design? It's a no-problem proposition with single -5.2V or -4.5V power supply and Mentor

Graphics\* and Viewlogic† CAD support.

BEST1 is just the starting point in our ECL/BiCMOS process road map—moving ahead in performance well into the 1990s.

For more reasons to opt for AT&T in ECL ASICs, get our BEST1 Gate Array and Standard Cell ASIC datasheets. Just give us a call at 1 800 372-2447.

\*Mentor Graphics is a registered trademark of Mentor Graphics, Inc.  
†Viewlogic is a registered trademark of Viewlogic, Inc.

The  
components  
of success.



**AT&T**

The right choice

CIRCLE 80

# THE FASTEST, CHEAPEST, EASIEST ARRAY OF GATE ARRAYS.



When it comes to logic devices, no one offers you a wider array of programmable gate arrays than Xilinx.

With toggle rates of up to 100 MHz and densities up to 9,000 gates, Xilinx Field Programmable Gate Arrays offer you the speed you need.

And if that isn't enough, we'll soon be offering even higher speeds and greater gate densities.

All at a fraction of the cost of anything else in the industry.

What's more, our new

Automated Design Implementation and Design Manager software run on PCs and the most popular engineering workstations. So no matter what your platform, you'll benefit from the easiest interface in the industry.

Which means your turn-around time on design revs will be measured in hours, not months. And non-recurring engineering charges will simply be non-existent.

No matter what application you're developing, there's a Xilinx

Field Programmable Gate Array that will make your design faster, cheaper and easier than ever before.

Call 1-800-255-7778 or, if you're working in California, call 408-559-7778. And we'll send you a free copy of the FPGA fact book. It's an objective look at the key reasons why FPGAs should be in your next design.



**XILINX**  
The Programmable  
Gate Array Company.<sup>SM</sup>

CIRCLE 148

## PALM-SIZED PC MODULES

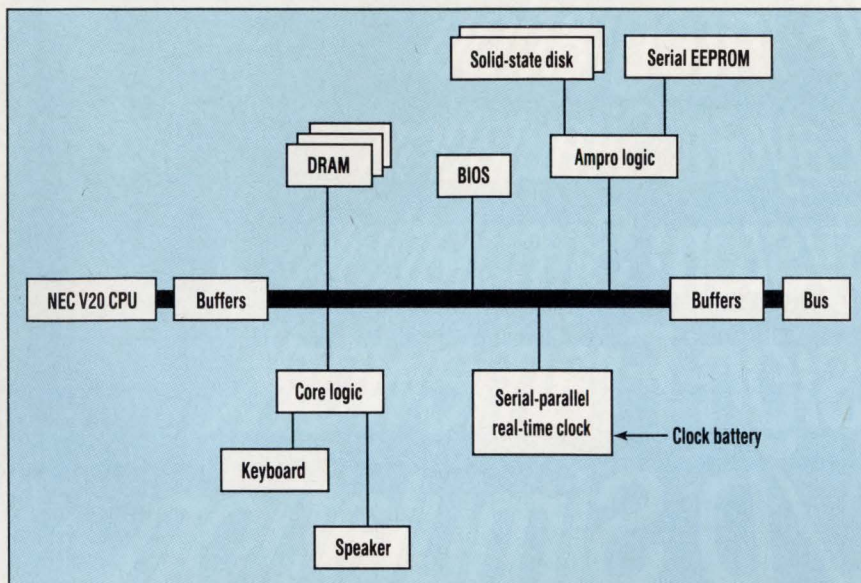

**2. ALL OF THE COMPONENTS** that make up the CoreModule are placed on a system bus. Here, the keyboard and speaker are external devices. Other modules can be added to form a complete embedded PC.

boots itself, it won't lose track of the system configuration that it's operating within. As a result, Ampro built a small serial EEPROM (1 kbits) into the device to store that configuration information. The EEPROM is accessible to users—they can go right to the configuration information and read it back whenever it's needed.

### CUSTOMIZING THE BIOS

Extending the BIOS is an important consideration for OEMs. That's why Ampro put a standard PC/XT and PC/AT BIOS on-board with a number of Ampro extensions. One extension is for built-in SCSI support. During system initialization, the BIOS checks for the another extension called "OEM hooks," which are commonly referred to as either extensions or patches.

For these extensions, a unique 2-byte OEM extension ID indicates at when the particular extension should be executed in the ROM-BIOS power-up/reset sequence. The extensions can either be placed in an on-board byte-wide socket or on an expansion memory board.

Using the patches method, a table of 16 pointers is developed that starts at address F000 at the begin-

ning of the ROM-BIOS EPROM. For each OEM hook, the ROM-BIOS executes code located at a particular memory address. This is the address that's patched into the ROM-BIOS EPROM at the location corresponding to the OEM hook. But this only occurs if the default value in the table has been altered. This feature allows the OEM code to be located directly within the system's ROM-BIOS EPROM. □

### PRICE AND AVAILABILITY

*The XT CoreModule is now in a beta version, with production scheduled for January. The 286 board will be in production around the middle of next year, and the 386SX module should be in production in the fourth quarter of 1991. The XT will sell for under \$100 in volume quantities; prices on the other two products haven't been set. The CoreModule/XT will also be available in a development kit consisting of the XT module, the MiniModule/FSS, and the MiniModule/VGA. Cables, a manual, and DR DOS 5.0 are also included. The kit will sell for \$995.*

**Ampro Computers Inc., 1130 Mountain Views/Alviso Rd., Sunnyvale, CA 94089; (408) 734-2939. CIRCLE 517**

HOW VALUABLE?	CIRCLE
HIGHLY	563
MODERATELY	564
SLIGHTLY	565

## PICO Miniaturized POWER INDUCTORS

DELIVERY—  
STOCK TO  
ONE WEEK!

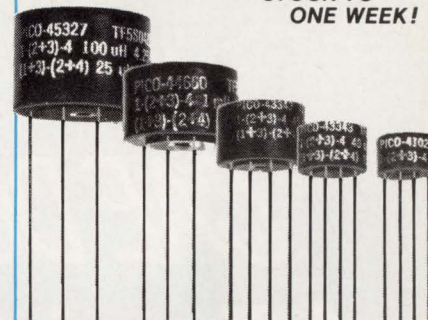

Over 190 PICO standard Power Inductors meet Noise, Spike and Power Filter Applications in Power Supplies, DC-DC Converters and Switching Regulators. These units cover the inductance values from 20 millihenry to 10 microhenry with DC currents to 23 Amps.

- Minimum possible size
- Meets MIL-T-27E (TF5S04ZZ)
- Special high frequency core material to insure low losses
- All units have split windings
- Large selection of sizes available

UNITS CAN BE SUPPLIED AS MILITARY STANDARDS. CONTACT FACTORY FOR APPROPRIATE PART NUMBERS (MIL-T-27/356-01 THROUGH MIL-T-27/356-63).

PICO also manufactures over 800 standard DC-DC Converters and Power Supplies and over 2500 Miniature Transformers.

Delivery—  
stock to  
one week

SEE EEM,  
THOMAS REGISTER  
OR SEND DIRECT FOR  
FREE PICO CATALOG

## PICO Electronics, Inc.

453 N. MacQuesten Pkwy. Mt. Vernon, N.Y. 10552

Call Toll Free **800-431-1064**  
IN NEW YORK CALL **914-699-5514**

CIRCLE 100

*Multi-Window CAE  
UNIX & DOS CAE*

*EDIF Integration*

*ASIC Layout Simulation*

*VHDL System Simulation*

*CAE Design Framework*

*Mixed A/D Simulation*

*VHDL Synthesis*

*When it comes to CAE tool innovations,  
the company that sets the pace is...*

■  
**VIEW***logic*<sup>®</sup>  
The CAE Company

1-800-422-4660

293 Boston Post Road West, Marlboro, MA 01752

(508) 480-0881

CIRCLE 153



# PLD DESIGN TOOLS MATURE

BETTER FEATURES AND INTERFACES  
HELP DESIGN TOOLS KEEP PACE WITH  
COMPLEX PLDs AND FPGAs.

LISA MALINIAK

**C**utthroat competition has manufacturers lining up in what's become a blistering race to get products to market faster. As a result, engineers concerned with a fast time-to-market often use programmable-logic devices (PLDs) and field-programmable gate arrays (FPGAs), devices that deliver the benefits of an ASIC without an ASIC's long turnaround time.

All of the advantages of PLDs and FPGAs are lost, however, without the proper design tools. Not only must these design tools be easy to use, reliable, and efficient, they must also mature along with the various devices.

Such tools split into two main groups: universal and device-specific (see "Windows on PLD/FPGA design tools," p. 62). Universal tools enable users to design without a particular device in mind—designers can pick the device that best fits their needs. On the other hand, users of device-specific tools must know the chip that will be used before starting the design. Device-specific tools are usually offered by the semiconductor manufacturers. These manufacturers argue that, because they know the device better than third-party vendors, their tools will best utilize the device's resources.

Many users choose to employ universal tools to avoid locking into one device manufacturer too early in the process. In most cases, their design can be completed with universal tools before choosing any device at all. And they can examine trade-offs between devices. In addition, universal-tool users need only learn a design language once to design with many different devices (see "Open tools optimize PLD design," p. 60). With device-specific tools, users must learn a new tool each time a different manufacturer's device is needed.

The key concern of universal PLD and FPGA tool users is device support (Fig. 1). Engineers want their tools to support many

devices, and they want that support as soon as the devices are introduced.

Many issues regarding users of PLD and FPGA design software, however, apply to both the device-specific and universal tools. For instance, engineers want easy-to-use user interfaces. In addition, they want the tools to integrate smoothly with the rest of their design environment. System-level simulation, which is becoming essential with today's complex systems, isn't possible unless all of the design tools mesh.

It's particularly important that PLD design tools be well-integrated with the rest of the board-design environment. For instance, functional simulation with the rest of the board is important to uncover errors. Moreover, timing problems uncovered during critical-path analysis may dictate using faster devices. And board layout and thermal analysis may require packaging or power changes.

## OPTIMIZE AND PARTITION

As programmable logic is used for bigger designs, the tools must handle both optimization and device partitioning. Engineers are pushing PLD and FPGA technologies with large circuits that were implemented previously with ASICs. These large designs can't always fit into one device. Therefore, the design tools must efficiently partition the design into multiple devices.

Users are also looking for an easy and efficient way to input designs. Many newer design tools allow for such input methods as the VHSIC hardware description language (VHDL) and waveforms (Fig. 2). Furthermore, users should be able to mix different entry methods within a single overall design description.

Programmable-logic design tools run on various hardware. In a survey of users of all types of design tools conducted by Data I/O, PCs were by far the most popular platform choice. And although the survey found that PC usage is tapering off, it'll continue to be

# PROGRAMMABLE-LOGIC DESIGN TOOLS

the hardware of choice for some time. The use of workstation-based tools, on the other hand, is growing rapidly.

The design-tool industry is doing its best to keep up with the increasing complexity of programmable-logic design. The past several months have seen major introduc-

tions for universal PLD and FPGA design tools. For instance, Logical Devices just introduced the latest revision of its PLD design system, CUPL 4.0. One unique CUPL feature is its ability to minimize logic on a pin-by-pin basis.

The new CUPL has many improvements, including expanded device

support. The biggest change is the addition of automatic device selection. With this feature, users can enter a device-independent design. The software then produces a list of devices that are able to take the design. From this list, users can select a suitable device without knowing all of the details of its internal structure.

CUPL 4.0 also features more simulation capabilities than previous versions. Users can arbitrarily change the order in which simulation waveforms are displayed. In addition, the software can display ten waveforms at once. Users can also combine up to eight waveforms to form a bus with a hex output. Pricing for CUPL 4.0 hasn't been set.

Logical Devices' PLPartition tool takes a design that was created and compiled by CUPL and fits it into one or more PLDs. The tool reads the CUPL output, enables the engineer to select the desired PLDs, and offers a list of design solutions. Solutions can be sorted according to several criteria: cost, power consumption, propagation delay, or number of devices. The Logical Devices products run on PCs and DEC, HP/Apollo, and Sun workstations. PLPartition costs \$995.

## ABLE ABEL

Last month, Data I/O unveiled its newest version of Abel—Abel-4 (ELECTRONIC DESIGN, Sept. 13, p. 107). The PLD and FPGA design software feature a windows-based interactive interface, Open-Abel filters, and device- and system-level simulation. The new user interface provides context-sensitive help for whatever item the cursor is on. An auto-update feature tracks the design and processes only the necessary portions. All messages and error notifications are interactively reported.

Also included with Abel-4 is the enhanced version of the Abel hardware description language (HDL). Abel-HDL is device- and architecture-independent, which makes it possible for users to enter and verify designs without knowing the target device. Abel-4 costs \$1995 for IBM PC/XT/AT, and PS/2 computers and com-

### MOST IMPORTANT DESIGN-TOOL FEATURES TO USERS

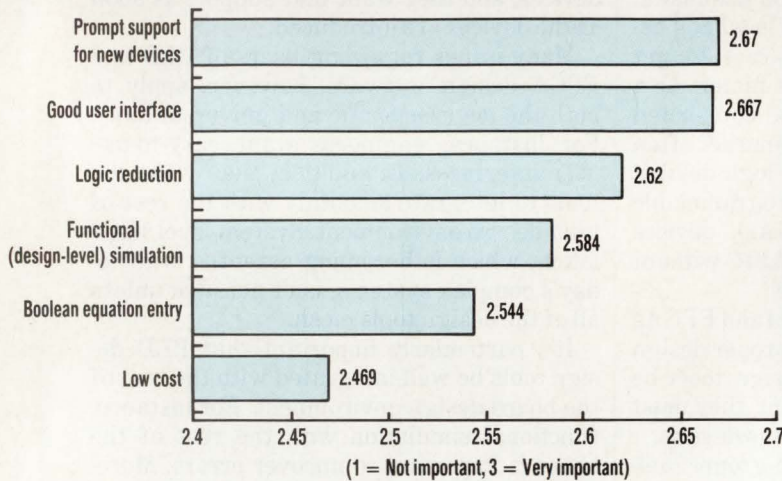

(a)

### LEAST IMPORTANT DESIGN-TOOL FEATURES TO USERS

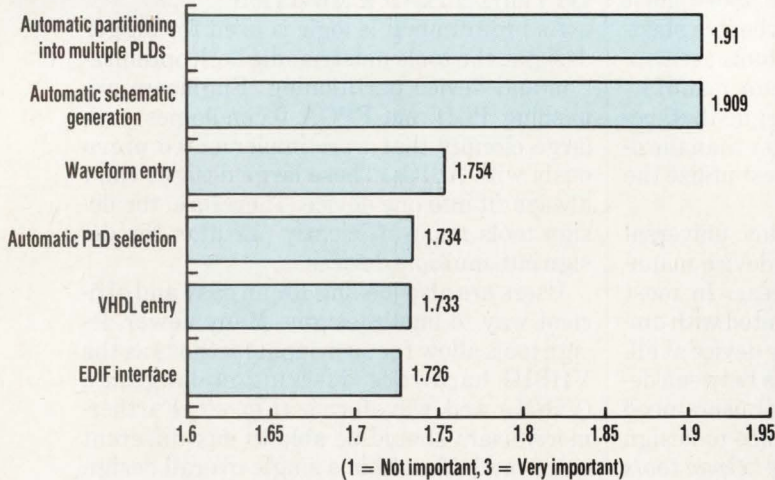

(b)

**1. SURVEY RESULTS SHOW** the features of programmable-logic design tools that are most important (a) and least important (b) to users. These numbers, obtained from a Data I/O Corp. survey, questioned not just users of Data I/O tools, but users of all types of design tools.

# PROGRAMMABLE-LOGIC DESIGN TOOLS

Company:	DESIGN ENTRY METHOD:					
	Boolean equation	Schematic	State machine	Truth table	VHDL	Waveform
Accel Technologies Inc.						
Advanced Micro Devices Inc.						
Data I/O Corp.						
Hewlett-Packard Co.						
Intergraph Corp.						
ISDATA Inc.						
Logical Devices Inc.						
Mentor Graphics Corp.						
Minc Inc.						
National Semiconductor Corp.						
Omaton Inc.						
OrCAD Systems Corp.						
Valid Logic Systems Inc.						

**2. PROGRAMMABLE-LOGIC DEVICES USERS** can choose from a wide assortment of design-entry methods. VHDL and waveform input are a few of the newest methods.

patibles; \$2695 for Sun workstations; and \$4115 for VAX VMS computers.

Data I/O's Open-Abel concept gives users the advantage of a universal language without sacrificing device support. Specialized algorithms called fitters are written by the device manufacturer to fully optimize the architecture. Actually, the fitters written for Open-Abel will interface with any PLD or FPGA design tool that outputs in the Berkeley-PLA format.

During the Design Automation Conference late last June, Minc Inc. made two major announcements: design software for FPGAs and a strategic partnership with Texas Instruments. Minc added the PGADesigner family of software to its PLDesigner family of PLD design software.

PGADesigner builds on the device-independent design-description capability of the PLDesigner family. Users can target FPGA architectures as well as PLDs with one source description.

PGADesigner will combine several design description methods (truth table, equations, and so on) into one system description. In that way, users can choose the efficient method to specify each portion of the design. In addition, they can still use functional simulation for system-level logic verification. The system is then partitioned into the technology of choice: one FPGA, multiple PLDs, or directed combinations. PGADesigner, which runs on PCs and Sun workstations, costs between \$2500 and \$14,000 depending on the configuration.

## LINKS TO GATE ARRAYS

An agreement between Minc and TI calls for Minc to write software that generates programmable-logic descriptions automatically for PLDesigner or PGADesigner tools directly from TI's TGC100 gate-array designs. The software, called ASICPrototyper, will run in the Mentor Graphics and Valid Logic Systems CAE environments. Under the



## NEW ABEL-4: Guaranteed to Knock Your Socks Off!

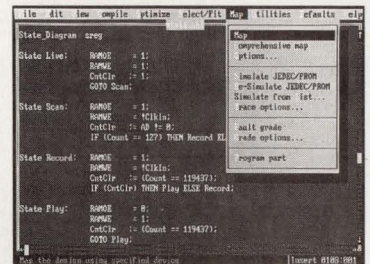

Data I/O's new ABEL™-4 Design Software propels FPGA and PLD design support into a new level of power and ease.

Its advanced new features like SmartPart™ intelligent device selection, multilevel simulation, and a device-independent hardware description language (ABEL-HDL™) help you create more efficient designs in less time. Even today's most complex devices are easy to master with ABEL-4.

You simply won't find a more powerful design tool at such a low price. ABEL-4 versions start at just \$895.\*

### 30-Day Money-Back Guarantee.

We'll even guarantee your complete satisfaction with ABEL-4 in 30 days, or your money back. It's your opportunity to put the power of ABEL-4 to work for you — **RISK FREE!**

So call Data I/O to order.  
**BUT HURRY** — this offer expires December 15, 1990.

**1-800-247-5700**

The Personal Silicon Experts

**DATA I/O**  
Corporation

\*Price valid in U.S.A. only.

CIRCLE 163

# One small step for PQFPs. One giant step for service

Introducing the right technology at the right time—our two-piece Micro-Pitch sockets for JEDEC plastic quad flat pack ICs.

Our patented low-profile (.400") Micro-Pitch sockets are a remarkably simple, safe way to mount high-speed, high-performance PQFPs. And their simplicity—in engineering, and in the minimum use of material—brings them to you at a remarkably low price.

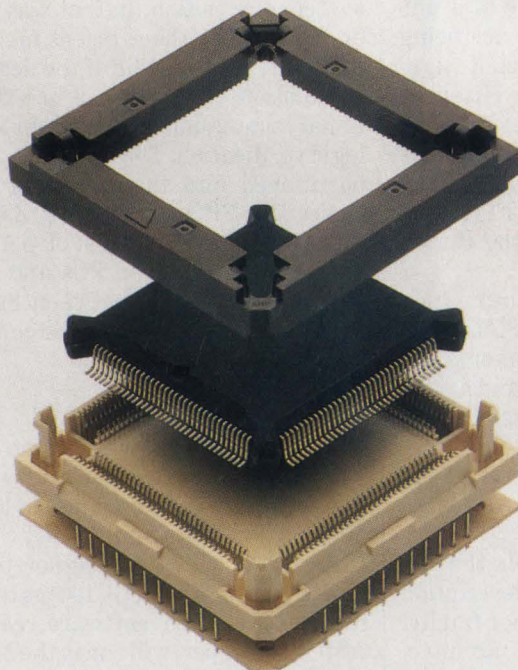

*PQFP as easy as 1-2-3.  
.025" centerline Micro-Pitch sockets ease handling, automate readily. High-speed contacts provide oxide cleaning wipe action, 200 grams normal force for positive mating. Footprint on .075" x .100" three-row grid.*

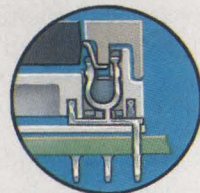

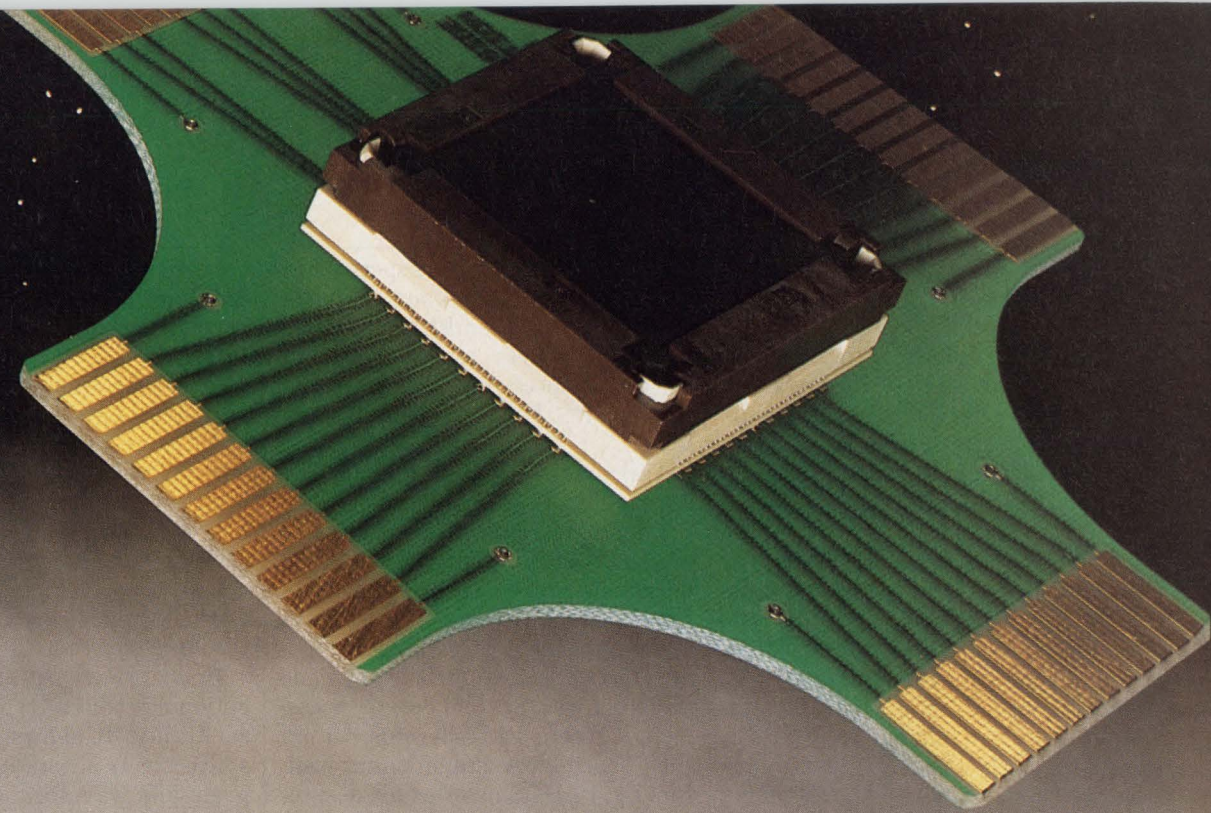

# and manufacturing.

The cover aligns IC leads for easy insertion into the base. It also protects the leads during handling. In fact, your PQFP supplier can insert chips into covers at his site, and send completed units to you. Result: hands-off installation.

Our high-speed tin-plated contacts provide .020" to .030" of contact cleaning wipe during insertion, and a normal mating force of 200 grams on each contact. Very positive engagement. And just the kind of quality engineering you can count on from AMP.

Micro-Pitch sockets have been designed with automation in mind, as well. They're fully polarized cover-to-base, and base-to-board, and compatible with vacuum pickup, for fast robotic implementation.

With today's chip costs, and with the high quality and low installed cost

AMP is known for, this is one option you'll want to pick up. Fast.

**For technical literature and more information, call the AMP Product Information Center at 1-800-522-6752 and ask about Micro-Pitch Sockets. AMP Incorporated, Harrisburg, PA 17105-3608.**

**AMP** Interconnecting ideas

## PROGRAMMABLE-LOGIC DESIGN TOOLS

agreement, Minc will also write software, called ASICPath, which automates the process of migrating programmable-logic design from its tools into the TI ASIC design environment. Delivery of the ASICPrototyper will begin in the fourth quarter; ASICPath will ship in the first half of 1991. Pricing hasn't been set for either product.

Valid Logic entered into the programmable logic market last month with the SystemPLD and SystemPGA tools, which are based on technology from Minc (*ELECTRONIC DESIGN*, Sept. 27, p. 179). With these tools, users can mix PLD and FPGA logic throughout system-level schematics, perform system-level simulation before device selection, and combine or retarget PLDs and FPGAs automatically without design description changes.

A number of design-entry methods can be combined hierarchically in the same schematic. Design entry is both technology- and device-independent. The software simplifies device

selection by letting users specify certain rules or constraints (*Fig. 3*). Pricing for SystemPLD and SystemPGA starts at \$13,500 and \$19,500, respectively. Both products run on DEC, IBM, and Sun workstations.

This month, Hewlett-Packard Co. is unveiling its newest PLD software version—HP PLD Design System (PLDDS) 4.0. The company feels its design software has three key benefits. With PLDDS, users can create and implement their designs independent of their knowledge of PLD architectures. System designers can include their PLD designs within their board-level simulations as well. Finally, PLDDS has flexible design-entry methods. Users can abstract their designs in the same way that they're conceptualized.

HP PLDDS 4.0 enhances the previous software as an integrated, system-level tool. With the new version, users can perform remote compilation from multiple editors. Any workstation with an editor can use

the compiler on another workstation. Software cost is thus minimized by purchasing one compiler with many editors.

Moreover, new schematic-editor enhancements include "rubber band" movement of primitives with wires. Version 4.0 does a better job of informing users of design errors. The compiler supplies a window explaining compiling misses caused by design errors (*Fig. 4*). In addition, over 100 new devices were added to the library.

Hewlett-Packard also has a new optional product—the Logic Synthesis Utility. It shows the results of synthesis from state-transition-diagram and waveform-description design inputs as logic equations and schematics. Users can then transfer these to non-PLD technologies, such as gate arrays. The HP tools, which are designed to run on the company's workstations, cost between \$5600 to \$13,700.

Mentor Graphics Corp.'s PLDSynthesis tool will take on a new

### OPEN TOOLS OPTIMIZE PLD DESIGN

**T**oday's systems designers are rarely able to fully optimize advanced programmable-logic-device (PLD) architectures. In fact, they often complain that a particular device doesn't have enough product terms to properly fit a design. It may be the design tools that are at fault because they either don't synthesize a portion of the design efficiently or don't synthesize it at all. For example, the right synthesis software can exploit a device's T flip-flop emulation capabilities to capture a seemingly large design into one device. Other tools may choose multiple devices for the same design, giving a non-optimal solution.

Frustration continues to grow among the system designer ranks. The reason is simple: Proliferating PLD architectures is at odds with the vast assortment of design tools flowing from proprietary tool vendors and semicon-

ductor manufacturers.

Several factors contribute to the aggravation. First, consider that each chip maker's PLD architecture requires unique software and synthesis algorithms. Then systems designers populate boards with greater numbers of complex PLDs. Sun Microsystems Inc., Mountain View, Calif., for example, puts up to 150 PLDs on some boards. It isn't productive for these designers to use proprietary tools for every PLD architecture they design with. Designers need one tool that does everything efficiently.

One solution is to develop intelligent algorithms for each architecture, and then integrate them with a common language and user interface so that everything is transparent to system designers. This wasn't such a problem years ago when the industry dealt with simple, two-level sum-of-products devices. Those were easily catego-

rized as PROMs, PALs, and FPLAs. Back then, a tool could simply be created by using one or two synthesis algorithms.

But to comply with today's demand for higher performance, innovative chip makers offer more access to key device technologies, spawning an increasing number of new and different architectures. Today, systems designers must contend with a maze of architectural features, such as multiple flip-flop types, buried nodes, XOR gates, and folded arrays. Completely new generations of devices are also entering the market. The most notable is the FPGA, which presents itself in at least two programming configurations—RAM- and fuse-based.

In essence, systems engineers experience an embarrassment of PLD riches, but haven't been able to capitalize on them. PLDs usually have more flexibility than designers can handle. And PLDs are

# PROGRAMMABLE-LOGIC DESIGN TOOLS

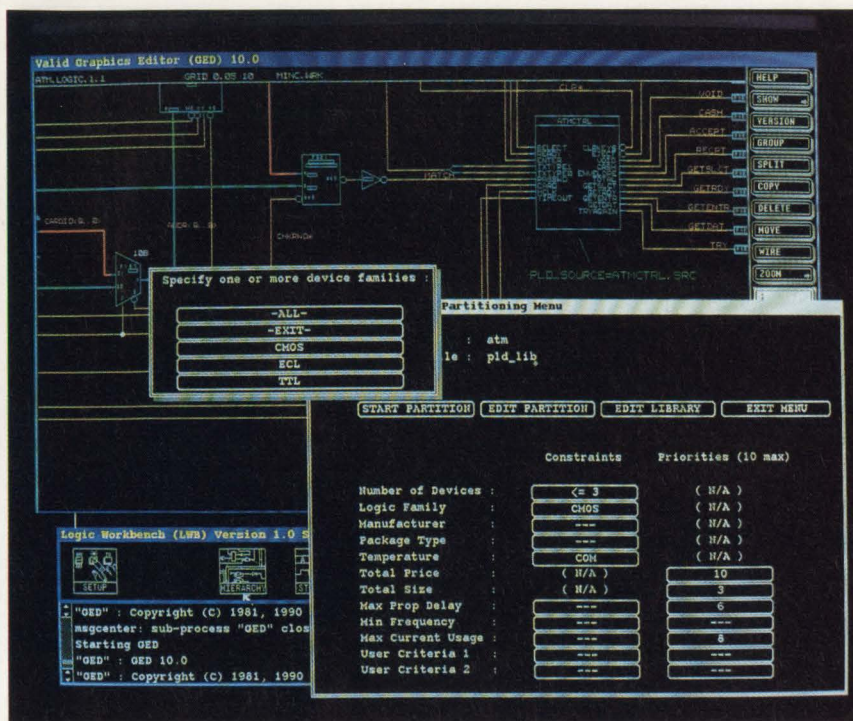

**3. DEVICE SELECTION** and automatic partitioning across devices is driven by user-specified constraints with Valid Logic System's SystemPLD and SystemPGA. These constraints include manufacturer, PLD type, speed, cost, power, and logic family.

role when it's delivered in the 8.0 environment early next year. The PLDSynthesis product is also based on technology from Minc. Within 8.0, PLDSynthesis will be closely integrated with Mentor's Design Consultant (a VHDL design-synthesis tool) and ASIC Consultant products. The integration between these tools will enable users to move easily between programmable-logic devices and ASICs. Mentor feels that VHDL will be a big factor in PLD design, especially as the designs expand in complexity.

The Mentor environment meshes the PLDSynthesis tool tightly with its board-level tools. This is because PLD designs are driven by board requirements rather than by individual design functions. The tool's partitioning capabilities can be fully utilized if the board's PLD functions are combined before synthesis. PLD implementations often require fewer and less expensive devices than what designers would have decided on.

FPGA design will be supported in

just the beginning: FPGAs, still in their infancy, continue increasing in gate densities.

One way to exploit these programmable IC (PIC) technologies is through such high-level behavioral design languages as Abel. With high levels of abstraction, designers can quickly and effectively deal with complex device functions.

These high levels of abstraction, however, must not come at the expense of optimization and partitioning. Newer, more complex architectures require those advanced algorithms that efficiently divide logic into the right-size blocks and then do the routing among those blocks.

Hardware description languages and logic synthesis, plus today's growing trend toward open tools, alleviate design barriers and OEM concerns over depending on multiple sources for device-tool support. The open-

tools concept, in particular, contributes to design optimization and assures systems houses of good device support. The open-tools approach bodes well for the chip maker and the universal tool vendors who open up their proprietary design tools.

Specifically, the concept allows an ASIC or PLD vendor to take advantage of a well-established design language. It also supplies system designers with device-specific synthesis algorithms, place-and-route routines, and optimization procedures through one HDL. Designers have one language that supports multiple devices efficiently.

One example is extending the popular Berkeley PLA file format so that PLD suppliers can tack on their own device-specific software. This format describes logic functions to be mapped into a PLD, and provides a compact way to transfer logic descriptions be-

tween various tools. As a superset of the Berkeley PLA format, it also gives chip makers the green light to many circuit-optimization tools, such as Espresso or MIS.

Open software is attractive to many ASIC and PLD vendors because it gives them direct control. They can write their own device- and architecture-specific algorithms, known as "fitters," can control delivery schedules, engineering due dates, and they still exploit standard tools.

For designers, open tools mean a major step toward tool integration, virtually comprehensive device support, and a considerably tighter PLD design cycle. There are also more choices, greater design flexibilities, and the new power to exercise a design in various device options.

*Contributed by Mike McClure, a product manager at Data I/O Corp., Redmond, Wash.*

# PROGRAMMABLE-LOGIC DESIGN TOOLS

## WINDOWS ON PLD/FPGA DESIGN TOOLS

### DEVICE-SPECIFIC TOOLS

#### FPGA

**Actel Corp.**  
Sunnyvale, Calif.  
(408) 739-1010  
**CIRCLE 300**

**AT&T**  
Berkeley Heights, N.J.  
(800) 372-2447  
**CIRCLE 301**

**Plessey Semiconductors**  
Scotts Valley, Calif.  
(408) 439-6074  
**CIRCLE 302**

**Plus Logic Inc.**  
San Jose, Calif.  
(408) 293-7587  
**CIRCLE 303**

**Xilinx Inc.**  
San Jose, Calif.  
(408) 559-7778  
**CIRCLE 304**

#### PLD

**Altera Corp.**  
Santa Clara, Calif.  
(408) 984-2800  
**CIRCLE 305**

**Cypress Semiconductor Corp.**  
San Jose, Calif.  
(408) 943-2600  
**CIRCLE 306**

**Exel Microelectronics Inc.**  
San Jose, Calif.  
(408) 432-0500  
**CIRCLE 307**

**Gould AMI Semiconductors**  
Pocatello, Ida.  
(208) 233-4690  
**CIRCLE 308**

**Integrated CMOS Technology Inc.**  
San Jose, Calif.  
(408) 434-0678  
**CIRCLE 309**

**Intel Corp.**  
Santa Clara, Calif.  
(408) 765-8080  
**CIRCLE 310**

**Signetics Co.**  
Sunnyvale, Calif.  
(408) 991-2000  
**CIRCLE 311**

**Texas Instruments**  
Dallas, Texas  
(214) 997-2796  
**CIRCLE 312**

### UNIVERSAL TOOLS

#### PC- AND WORKSTATION-BASED

**Data I/O Corp.**  
Redmond, Wash.  
(206) 881-6444  
**CIRCLE 325**

**ISDATA Inc.**  
Monterey, Calif.  
(408) 373-7359  
**CIRCLE 326**

**Logical Devices Inc.**  
Fort Lauderdale, Fla.  
(305) 974-0967  
**CIRCLE 327**

**Minc Inc.**  
Colorado Springs, Colo.  
(719) 590-1155  
**CIRCLE 328**

**Phase Three Logic Inc.**  
Beaverton, Ore.  
(503) 645-0313  
**CIRCLE 329**

#### PC-BASED

**Accel Technologies Inc.**  
San Diego, Calif.  
(619) 554-1000  
**CIRCLE 313**

**Advanced Micro Devices Inc.**  
Sunnyvale, Calif.  
(408) 732-2400  
**CIRCLE 314**

**Aldec Inc.**  
Newbury Park, Calif.  
(805) 499-6867  
**CIRCLE 315**

**National Semiconductor Corp.**  
Santa Clara, Calif.  
(408) 721-5000  
**CIRCLE 316**

**Omaton Inc.**  
Richardson, Texas  
(214) 231-5167  
**CIRCLE 317**

**OrCAD Systems Corp.**  
Hillsboro, Ore.  
(503) 690-9881  
**CIRCLE 318**

#### WORKSTATION-BASED

**Dazix**  
Mountain View, Calif.  
(415) 960-0123  
**CIRCLE 319**

**Hewlett-Packard Co.**  
Fort Collins, Colo.  
(303) 229-3800  
**CIRCLE 320**

**Intergraph Corp.**  
Huntsville, Ala.  
(205) 772-2000  
**CIRCLE 321**

**Mentor Graphics Corp.**  
Beaverton, Ore.  
(503) 626-7000  
**CIRCLE 322**

**Teradyne Inc.**  
Boston, Mass.  
(617) 482-2700  
**CIRCLE 323**

**Valid Logic Systems Inc.**  
San Jose, Calif.  
(408) 432-9400  
**CIRCLE 324**



**NEW**  
**ABEL-4**  
 with SmartPart™  
 intelligent device selection



# Knock-your-socks-off PLD software on a shoestring budget.

Who says you can't afford the world's best PLD development tools? Data I/O's industry-standard design software and programming solutions are more powerful—and more affordable—than ever before. So now the best tools on the market are also the best value.

**NEW ABEL™-4** marks a major milestone in PLD software. The leader in device support, ABEL-4 automatically identifies which PLDs match your design needs with new SmartPart™ intelligent device selection. New optional device fitters automatically assign pins and

configure macrocells for complex device architectures. And an all-new user interface speeds the entire PLD design process.

A major new version of the leading schematic capture software, **NEW FutureNet®-5**, redefines "ease-of-use" with pop-up menus, extensive dialog boxes and a fast symbol browsing feature.

To make designing for testability practical, choose **NEW PLDgrade™**. This inexpensive fault grading software helps you optimize your design for testability before production.

And the affordable **NEW 2900 Programming System** brings the cost of high-performance programming down to earth. Its innovative technology makes programming any PLD—even surface-mount devices—fast and easy.

CALL TODAY for your **FREE** tutorial on designing with PLDs—a \$12.95 value.

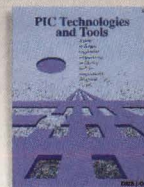

**1-800-247-5700**

The Personal Silicon Experts

**DATA I/O**  
 Corporation

**Data I/O Corporation** 10525 Willows Road N.E., P.O. Box 97046, Redmond, WA 98073-9746, U.S.A. (206) 881-6444/1-800-247-5700  
**Data I/O Canada** 6725 Airport Road, Suite 302, Mississauga, Ontario L4V 1V2 (416) 678-0761  
**Data I/O Europe** World Trade Center, Strawinskylaan 633, 1077 XX Amsterdam, The Netherlands +31 (0)20-6622866/Telex 16616 DATIO NL  
**Data I/O Instrumentic Electronic Systems Vertriebs GmbH** Lochamer Schlag 5A, 8032 Graefelfing, W. Germany, +49 (0)89-858580  
**Data I/O Japan** Sumitomoseimei Higashishinbashi Bldg., 8F, 2-1-7, Higashi-Shinbashi, Minato-Ku, Tokyo 105, Japan  
 (03) 432-6991/Telex 2522685 DATAIO J

©1990 Data I/O Corporation

CIRCLE 163

# At last, radiation survivability is standard procedure.

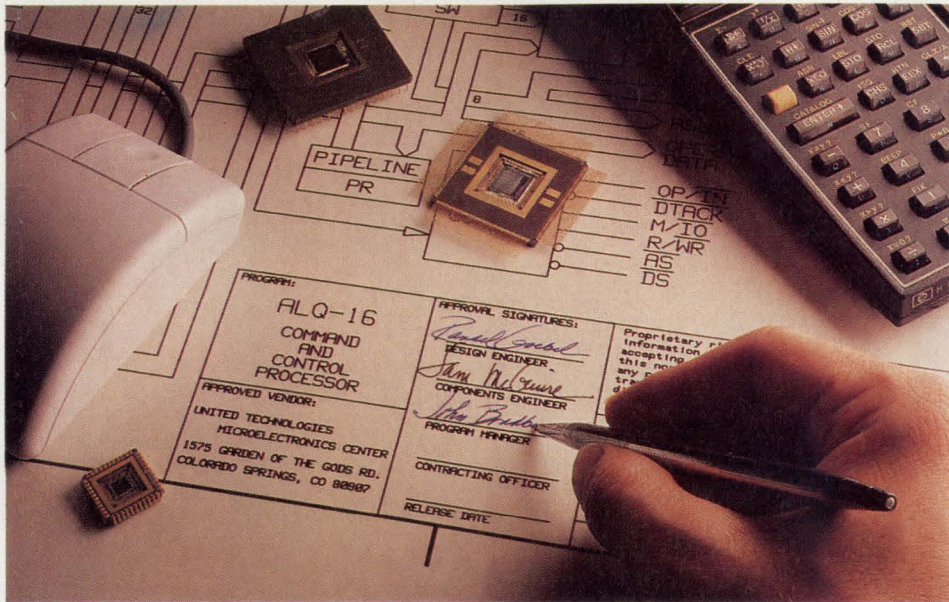

## You can sign-off on it.

Forget about special screening, SCDs, and lot-by-lot testing of non-hardened parts. Now you can sign-off on radiation survivability with off-the-shelf RAD-SPEC<sup>SM</sup> products from UTMC. Our RAD-SPEC circuits are guaranteed to meet MIL-M-38510 radiation levels M, D, R, and H after irradiation. And you get guaranteed M- and D-level RAD-SPEC products at a small premium over standard non-hardened parts. RAD-SPEC is possible because UTMC has developed the hardest production-proven CMOS process in the industry. And we've ramped-up production of military-standard and semicustom products. You can select from 1553 bus interface components, 1750 RISC processors, 75 MFLOP IQMAC vector floating-point DSP, SRAMs, and gate arrays with up to 50,000 gates. You can order RAD-SPEC products to Level S, 883 Level B, and SMD to simplify procurement procedure. Whether you need kilorad levels for a tactical program or megarad-plus for a space-

borne system, RAD-SPEC guarantees better pricing, delivery, and performance. So end the confusion. Remove the risk and high cost from your radiation-survivable program. Call UTMC for more information on our complete line of off-the-shelf RAD-SPEC products.

RAD-SPEC is a service mark of  
United Technologies Microelectronics Center, Inc.

**1-800-MIL-UTMC**  
1575 Garden of the Gods Rd.  
Colorado Springs, CO 80907

**UTMC**  
★ ★ ★  
**RAD  
SPEC**<sup>SM</sup>



DEDICATED TO MILITARY AND AEROSPACE

## PROGRAMMABLE-LOGIC DESIGN TOOLS

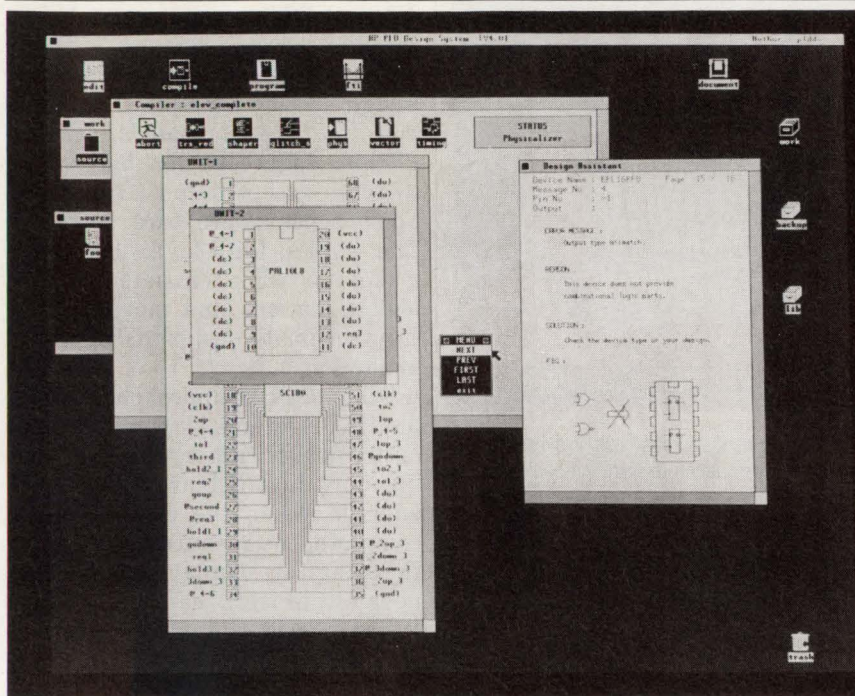

**4. THE NEWEST** version of Hewlett-Packard's PLD Design System lets users know when a design error occurs. A window (left side of screen) explains compiling misses caused by design errors.

software package that links the company's design system to the VHDL world. Hint works as a preprocessor to define state machines and combinatorial circuits in VHDL, and automates state reduction and state assignment for finite-state-machine designs. Hint, which runs on PCs, costs \$2380.

Tango-PLD, a universal tool from Accel Technologies Inc., designs and simulates PLDs. With the software, users can enter and simulate designs before device selection. A combination of input methods are possible with the Tango Design Language. Tango-PLD runs on IBM PC/XT/

Mentor's 8.0 environment with design kits supplied by the FPGA vendors. Users will enter the design with Mentor's front-end tool. The back-end tool, or the design kit, will then optimize and implement the design into a device.

Interactive partitioning and a VHDL compiler are the newest additions to ISDATA Inc.'s LOG/iC development software. LOG/iC Perfect is a synthesis tool that interactively partitions large designs among several PLDs. The partitioner is controlled through menus, and involves users in the decision-making process. Different partitioning sessions can be stored in a stack and called in for review or implementation at any time. The final result is a number of Jedec or HEX files to program the selected components.

The new software also sports the benefits of automatic test-vector production. Input syntax underwent improvements that incorporate recent technological developments. For example, JK or RS flip-flops can now be defined for PLDs. LOG/iC Perfect runs on PCs and workstations, and costs \$3987 (for the PC version) and \$6777 (for the workstation version).

ISDATA also just released Hint, a

## Program It All!



**ALLPRO-88 From \$1995.00**

**DAC-PER-PIN™ High Pin Count Programmer** can expand to 88 grade A pin drivers to support any small high pin count device in any package technology. Fully software configurable, new devices are added on a DAILY basis. Certified by most semi-houses, you only have to buy a programmer ONCE!

For a free Demo or Trade-In  
Call 1-800-331-7766

**LOGICAL  
DEVICES, INC.**

From the makers of CUPL

CIRCLE 165

# SCSI INSTRUMENTS



ANCOT's SCSI instruments are powerful, easier to use, and cost less. Proven in use worldwide, Ancot's portable equipment travels from bench to field and back again without ever slowing down. They are time and labor saving instruments, for design, manufacturing, repairing, and inspection applications.

Call today for product data sheets, demo disc, or to make arrangements for a free evaluation unit in your facility.

**ANCOT**  
CORPORATION

[415] 363-0667

fax: (415) 363-0735  
Redwood City, California

CIRCLE 82

## HEAT PROTECTION IS A



Selco's snap-action industrial thermostats are fast, positive, reliable, and very cost effective. Over 150 models available from stock.

**A.** Our standard, miniature, industrial series offers set points from 35°F to 500°F. Various terminal and bracket configurations, too. Special low prices in OEM quantities.

**B.** Miniature industrial models are also available with a manual reset feature.

**C.** For your HVAC needs, Selco offers heavy-duty models rated at 25 amps for 120, 240, or 277 VAC applications. A number of thermostat

models are exact replacements for original equipment.

**D.** In applications requiring international certification, Selco has a special series that is not only UL and CSA approved, but also listed and approved in England, Denmark, Finland, Holland, Norway, Sweden, Austria, Switzerland, West Germany, France and Australia. Contacts rated at 15 amps—120 VAC, and 8.3 amps—240 VAC.

Contact us today for an informative, 8-page catalog and a FREE sample thermostat. Specify style and set point. It'll make your application a snap-p-p-p.

**selco**

7580 Stage Road, Buena Park, California 90621 • Phones (213) 921-0681  
(714) 521-8673, (800) 25-SELCO, Telex 655457, FAX (714) 739-1507

CIRCLE 113

## PROGRAMMABLE-LOGIC DESIGN TOOLS

AT, and PS/2 computers and compatibles. It costs \$495.

PLD users can purchase another design system for \$495 from Omation Inc. The company's Schema-PLD is a logic compiler that's structured to accept output from Omation's schematic-capture software. The tool's high-level language makes it possible for users to bypass logic equations and move directly from schematic design to PLD implementation.

Schema-PLD approaches multiple PLD systems by compiling the entire design rather than considering individual PLD architectural elements. When the compilation is complete, the resources needed by the design are displayed to the engineer. Engineers can then select PLDs, considering such factors as speed, availability, and cost. Schema-PLD runs on IBM PC/XT/AT and 80386-based computers and compatibles.

OrCAD Systems Corp.'s OrCAD/PLD also costs \$495. The OrCAD/PLD library contains over 2400 parts. The design software allows for numerous input methods, including numerical maps, schematics, and indexed equations. In addition, it's integrated with OrCAD's other design tools. OrCAD/PLD runs on IBM PC/XT/AT, and PS/2 computers and compatibles.

Intergraph Corp.'s PLD design tool—PLDesigner Plus—is based on Minc's PLDesigner. The PLDesigner Plus software, coupled with the Intergraph user interface, runs on Intergraph workstations. Entry methods can be mixed within one design, and functional simulation verifies that a design works properly before device implementation.

Automatic design partitioning and device selection separates the design phase from the design-implementation phase. Device selection from a library of over 3000 parts is based on user-specified criteria. □

HOW VALUABLE?	CIRCLE
HIGHLY	544
MODERATELY	545
SLIGHTLY	546

Food For  
Thought  
About Field  
Programmable  
Gate Arrays.

# Be Brilliant At In Production

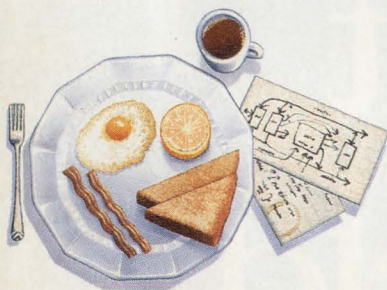

## 7:05 am: Breakfast

Suddenly, between bites, the answer to that new system design jumps right into your brain. But how to make it work in silicon? Use an Actel field programmable gate array!

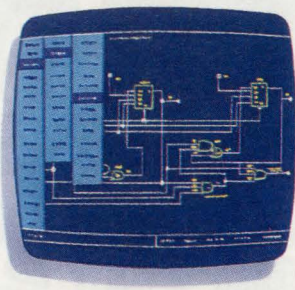

## 8:50 am: Design

You warm up the design program on your 386 and put in the final touches. Then a quick rule check and 25 MHz system simulation with the Action Logic System software.



## 11:00 am: Place & Route

You watch the system place and route all 1700 gates (out of 2000 available) in under 40 minutes. 100% automatically! A final timing check. Then think of something to do until lunch.

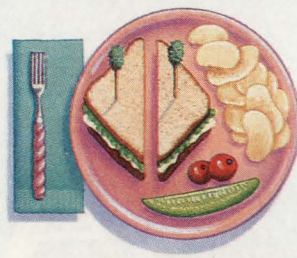

## 12:00 pm: Lunch

Remember lunch? Normal people actually stop working and have a nice meal—right in the middle of the day! With Actel's logic solution, this could become a habit.

## Actel Field Programmable Gate Array Systems.

They're a feast for your imagination.

Actel's ACT™ 1 arrays bring you a completely new approach to logic integration. Not just another brand of EPLD, PAL® or LCA™ chips. But true, high density, desktop configurable, channeled gate arrays.

They're the core of the Action Logic System, Actel's comprehensive design and production solution for creating

your own ASICs. Right at your desk. On a 386 PC or workstation. With familiar design tools like Viewlogic™, OrCAD™ and Mentor™

And do it in hours instead of weeks. Even between meals.

How? With features like 85% gate utilization. Guaranteed. Plus

100% automatic placement and routing. Guaranteed. So you finish fast, and never get stuck doing the most

Actel FPGA Product Family		1010A	1020A
Equivalent Gate Array	PLD/LCA	1200	2000
Equivalent Gates		3000	6000
User I/O		57	69
System Clock (MHz)		20-40	20-40
Availability		NOW	NOW
Technology (micron)		1.2	1.2

# Breakfast And n By Dinner.

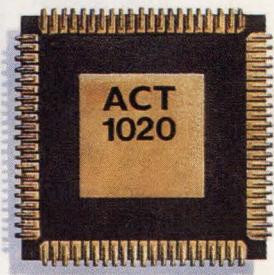

#### 1:15 pm : Program

You load the Activator™ programming module with a 2000-gate ACT 1020 chip and hit "configure." Take a very quick coffee break while your design becomes a reality.

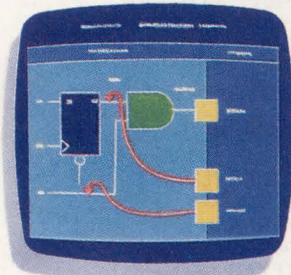

#### 1:25 pm : Test

You do a complete, real-time performance check, with built-in test circuits that provide 100% observability of all on-chip functions. *Without* generating any test vectors.

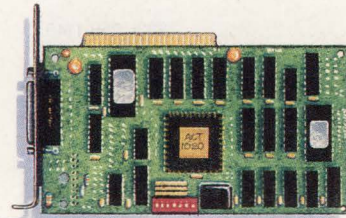

#### 4:00 pm : Production

Your pride and joy is designed, created, tested, and off to the boys in Production. And you're finished way ahead of schedule! Better think of something to do until 5:00.

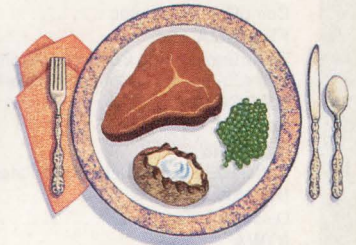

#### 6:00 pm : Dinner

Remember dinner? Normal people actually *go home* and eat with their families. On your way, start thinking about how Actel's logic solution can help you be brilliant tomorrow.

tedious part of the job by hand.

Design verification is quick and easy with our Actionprobe™ diagnostic tools, for 100% observability of internal logic signals. Guaranteed. So you don't have to give up testability for convenience.

In fact, the only thing you'll give up is the NRE you pay with full masked arrays. You can get started with an entry level Action Logic System for under \$5000. Guaranteed.

And Actel FPGAs are even 883 mil-spec compliant.

You can be brilliant right now

with 1200- and 2000-gate devices, and a whole new family of 8000-, 4000- and 2500-gate parts are on the way. Call 1-800-227-1817, ext 60 today for a free demo disk and full details about the Action Logic System.

It could make your whole day.

  
Risk-Free Logic Integration

© 1990 Actel Corporation, 955 E. Arques Ave., Sunnyvale, CA 94086. ACT, Action Logic, Activator, and Actionprobe are trademarks of Actel Corporation. All other products or brand names mentioned are trademarks or registered trademarks of their respective holders.

# ACTEL CORPORATION DIRECT SALES OFFICES

955 E. Arques Ave.  
Sunnyvale, CA 94086  
Tel: (408) 739-1010

8130 McFadden Ave., Suite 109  
Westminster, CA 92683  
Tel: (714) 373-4488

425 N. Martingale Rd., Suite 800  
Schaumburg, IL 60173  
Tel: (708) 706-3866

1740 Mass Avenue  
Boxborough, MA 01719  
Tel: (508) 635-0010

9101 Guilford Road, Suite 107  
Columbia, MD 21046  
Tel: (301) 604-0111

2350 Lakeside Blvd., Suite 850  
Richardson, TX 75082  
Tel: (214) 235-8944

## DOMESTIC REPRESENTATIVES

### ALABAMA

Rep Inc. . . . . (205) 881-9270

### ARIZONA

Luscombe Engineering . . . . . (602) 949-9333

### CALIFORNIA

Centaur Corporation (Calabasas) . . . . . (818) 704-1655

Centaur Corporation (Irvine) . . . . . (714) 261-2123

Centaur Corporation (San Diego) . . . . . (619) 278-4950

I<sup>2</sup> Inc. (Santa Clara) . . . . . (408) 988-3400

I<sup>2</sup> Inc. (Orangevale) . . . . . (916) 989-0843

### COLORADO

Luscombe Engineering . . . . . (303) 772-3342

### CONNECTICUT

CompRep Associates . . . . . (203) 269-1145

### FLORIDA

Sales Engineering Concepts (Altamonte Springs) . . . . . (407) 682-4800

Sales Engineering Concepts (Deerfield Beach) . . . . . (305) 426-4601

### GEORGIA

Rep Inc. . . . . (404) 938-4358

### ILLINOIS

Carlson Electronic Sales Associates . . . . . (708) 956-8240

### INDIANA

Giesting & Associates . . . . . (317) 844-5222

### IOWA

Carlson Electronic Sales Associates . . . . . (319) 378-1450

### KANSAS

DLE Electronics . . . . . (316) 683-6400

### MARYLAND

New Era Sales . . . . . (301) 544-4100

### MASSACHUSETTS

CompRep Associates . . . . . (617) 329-3454

### MICHIGAN

Giesting & Associates (Livonia) . . . . . (313) 478-8106

Giesting & Associates (Comstock Park) . . . . . (616) 784-9437

### MINNESOTA

Gibb Technology Sales . . . . . (612) 835-3370

### MISSOURI

John G. Macke Co. . . . . (314) 432-2830

### NEW JERSEY

Nexus . . . . . (201) 947-0151

### NEW MEXICO

Luscombe Engineering . . . . . (505) 888-0333

### NEW YORK

L-MAR Associates (Apalachin) . . . . . (607) 687-1828

L-MAR Associates (E. Rochester) . . . . . (716) 381-9100

L-MAR Associates (Poughkeepsie) . . . . . (914) 462-8025

### NORTH CAROLINA

Rep Inc. (Charlotte) . . . . . (704) 563-5554

Rep Inc. (Morrisville) . . . . . (919) 469-9997

### OHIO

Giesting & Associates (Cincinnati) . . . . . (513) 385-1105

Giesting & Associates (Cleveland) . . . . . (216) 261-9705

Giesting & Associates (Columbus) . . . . . (614) 486-5616

### OREGON

L<sup>2</sup> Ltd. . . . . (503) 629-8555

### PENNSYLVANIA

Omega Sales . . . . . (215) 244-4000

### TENNESSEE

Rep Inc. . . . . (615) 475-4105

### TEXAS

OM Associates (Austin) . . . . . (512) 794-9971

OM Associates (Houston) . . . . . (713) 789-4426

OM Associates (Richardson) . . . . . (214) 690-6746

### UTAH

Luscombe Engineering . . . . . (801) 565-9885

### WASHINGTON

L<sup>2</sup> Ltd. . . . . (206) 827-8555

### WISCONSIN

Carlson Electronic Sales Associates . . . . . (414) 476-2790

### CANADA

Clark-Hurman Associates (Quebec) . . . . . (514) 426-0453

Clark-Hurman Associates (Ontario-Brampton) . . . . . (416) 840-6066

Clark-Hurman Associates (Ontario-Nepean) . . . . . (613) 727-5626

## INTERNATIONAL DISTRIBUTORS

### AUSTRALIA

Reptechnic (Neutral Bay, NSW) . . . . . (2) 953.9844

### BELGIUM

Acal Auriema N.V. S.A. (Zavenlem) . . . . . (2) 720.5983

### DENMARK

Nordisk Elektronik AS (Herlev) . . . . . (42) 84.20.00

### EGYPT

SEE (Cairo) . . . . . (2) 665.948

### ENGLAND

Gothic-Crellon Ltd. (Wokingham) . . . . . (0734) 78.88.78

Manhattan Skyline Ltd. (Maidenhead) . . . . . (0628) 75.85.1

### FINLAND

OY Fintronic AB (Helsinki) . . . . . (0) 69.26.022

### FRANCE

ASAP (Montigny Le Bretonneux) . . . . . (1) 30.43.8233

SCAIB S.A. (Meylan-Zirst) . . . . . (76) 90.22.60

SCAIB S.A. (Rungis Cedex) . . . . . (1) 46.87.2313

### HONG KONG

Twin-Star Trading Co. (Yau Tong Industrial City) . . . . . (852) 346.9085

### INDIA

Benchmark Systems (Madras) . . . . . (44) 413.866

### ISRAEL

A.S.T.Ltd. (Herzlia) . . . . . (52) 58.33.55

### ITALY

LASI Elettronica S.p.A. (Milan) . . . . . (3) 499.8351

### JAPAN

Innotech Corporation (Tokyo) . . . . . (3) 499.8351

Matsushita Electronics Corporation (Kyoto) . . . . . (75) 951.8151

### KOREA

Eastern Electronics, Inc. (Seoul) . . . . . (2) 566.0514

### NETHERLANDS

Transfer B.V. (Enschede) . . . . . (53) 33.43.81

### NORWAY

Nordisk Elektronik AS (Hvalstad) . . . . . (2) 84.50.70

### SPAIN

Semiconductores S.A. (Barcelona) . . . . . (93) 217.23.40

Semiconductores S.A. (Madrid) . . . . . (1) 742.2313

### SWEDEN

Traco AB (Farsta) . . . . . (8) 93.00.00

### SWITZERLAND

Omni Ray AG (Dietlikon) . . . . . (1) 835.21.11

### TAIWAN

SEED TECH Corporation (Taipei) . . . . . (2) 521.1100

### WEST GERMANY

bit-electronic AG (Munich) . . . . . (089) 41.80.070

ECN Component Network (Ismaning) . . . . . (089) 96.09.080

## DOMESTIC DISTRIBUTORS

Actel products can be purchased from the major distributors listed below:

Wyle Laboratories: call (714) 851-9953 for the number of the office nearest you.

Pioneer Standard Electronics and Pioneer Technologies: call (516) 921-8700 for the number of the office nearest you.



# RISC CPU MODULE PACKS ALL LOGIC

A 3.5-BY-3.5-IN. RISC-CPU MODULE GIVES DESIGNERS A COMPLETE MIPS PROCESSOR WITH CACHE AND FLOATING POINT.

DAVE BURSKY

**W**ith higher integration levels, the performance and functionality of reduced-instruction-set computers has elevated to new

heights. However, off-chip support, such as cache memory, read and write buffers, and clock-generation logic, often handcuffs system performance due to wiring delays of mismatched components. One answer to these limitations comes in the form of a small circuit board, the RPM3010 Mips Nginde from LSI Logic, which integrates all of the critical functions to form a complete CPU subsystem. The board takes the headache out of designing the tim-

ing-critical portion of a system based on the R3000 RISC processor from Mips Computer Systems Inc., Sunnyvale, Calif.

Even though LSI sells the R3000 chips as standalone components, the tight timing margins of the chips requires that system designers spend a fair amount of time developing and debugging a prototype CPU subsystem. The Nginde module cuts that time to almost zero. On one 3.5-by-3.5-in. module, designers at LSI have combined the following: the LR3000 32-bit integer processor; the LR3010 floating-point unit; the LR3220, a six-word-deep read-write buffer with parity checking and generation logic, plus address- and data-bus buffers; dual 32-kbyte instruction and data caches; five registered interrupt inputs; and clock-generation and reset circuits. A 100-pin connector provides the I/O interface and ample power-supply and ground lines (*see the figure*).

Modules will be manufactured with maximum operating frequencies of 20 or 25 MHz. At top speed, they'll have worst-case power consumption of about 22 W. The on-board circuits eliminate the need for any complex external timing. And they provide programmable block refilling for data or instruction caches, instruction streaming, and system configurability. Such a CPU module can be used during system prototyping to shorten the hardware design phase considerably. Or it could be employed as a complete embedded central processor subsystem, even in low-volume production stages of a project.

To squeeze all of the logic and cache memory onto such a small card, designers employed a hybrid and dual-sided surface-mount combination. The CPU and floating-point

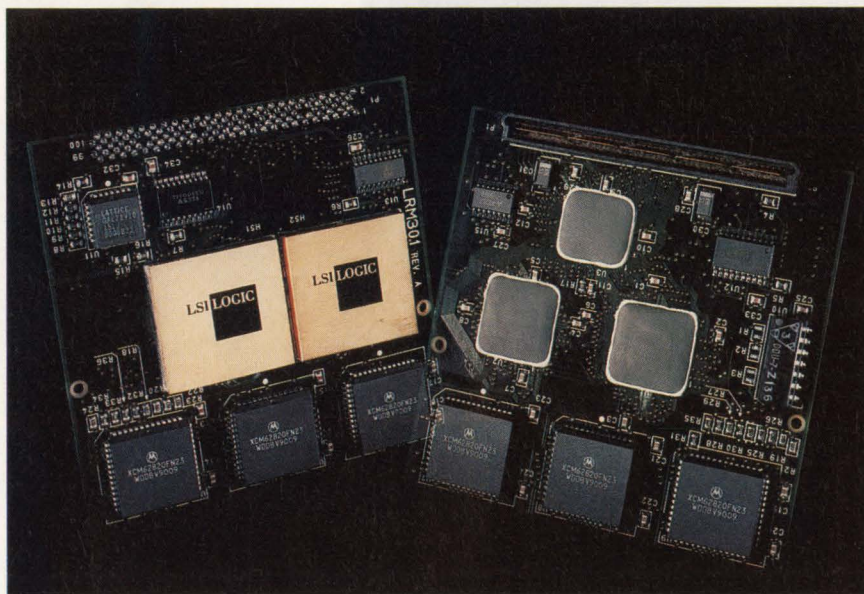

**A COMBINATION OF** chip-on-board and standard surface-mount technology make this 3.5-by-3.5-in. RISC CPU module possible. Crammed into just over 12 square in. are the 32-bit LR3000 CPU, the 3010 floating-point unit, the 3220 read-write buffer, 64 kbytes of cache, and clock-generation and bus-interface circuits.

**Because you're  
thinking fast...**

you need responsive suppliers as well as fast parts. Comlinear is tuned in. With high quality, high-speed products. Assistance from R&D-level applications engineers to help develop your ideas quicker. Off-the-shelf MIL-STD-883 compliant monolithics and hybrids. Quality product documentation with guaranteed specs so you don't waste time. In your business, time is everything. Count on us for the speed you need.

# Now, high-speed AGC is easier than ABC.

Until now, AGC amplifiers were only partial solutions to high-speed automatic gain control. You also had to find a high-performance op amp, numerous passive components and the board space to mount them all.

Now all you need is the new CLC520 AGC+Amp,  $\pm 5V$  and two resistors. That's it.

You get a total high-speed AGC solution—with voltage-controlled gain and voltage output—in a single device. Plus outstanding performance: 160MHz signal-channel and 100MHz gain-control bandwidth. And unexpected flexibility... one resistor sets maximum gain between 2X and 100X, and the gain-control input gives you a 40dB range.

So don't settle for a partial AGC solution. Call about the CLC520 AGC+Amp and learn the ABCs of high-speed AGC.

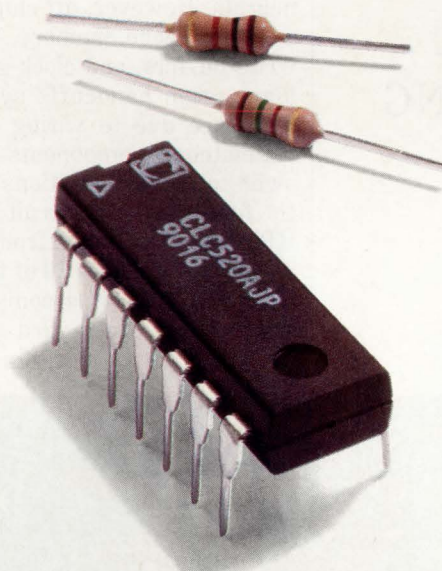

**CIRCLE 155**

 **Comlinear  
Corporation**  
*Solutions with speed*

4800 Wheaton Drive  
Fort Collins, CO 80525  
(303) 226-0500  
1-800-776-0500 (USA)

## More easy-to-use amplifiers...

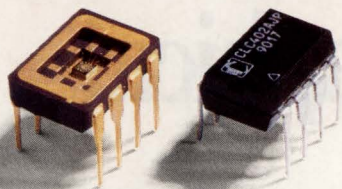

### Op amps settle to 14 bits in 32ns max.

Extremely fast settling to 0.0025% and low 1.6mV max. offset make the CLC402 and CLC502 op amps ideal for high-accuracy A/D and D/A converters. Or in designs demanding high stability at low gain. Now you have extra design margins.

CIRCLE 156

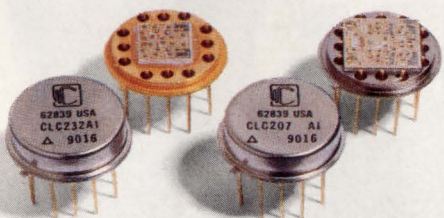

### Low distortion for fast, wide-dynamic-range designs.

The 170MHz CLC207 and 270MHz CLC232 deliver ultra-low distortion. For high gain, choose the CLC207 with -80/-85dBc 2nd/3rd harmonics (2V<sub>p-p</sub>, 20MHz, 200 ohms). And for low gain, the CLC232 with -69dBc harmonics (100 ohms).

CIRCLE 157

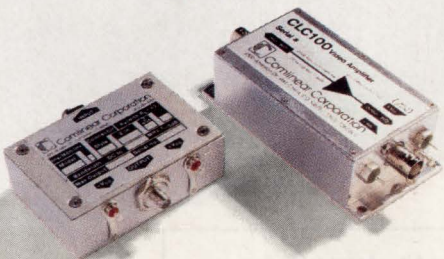

### Modular amplifiers... ready to go.

For bench or system use, this family of dc-coupled modular amplifiers gives you complete amplifier solutions. Including PMT amps, cable drivers, post-amps, very-low-distortion amps, or amps with gain and I/O impedances that you can select.

CIRCLE 158

## RISC CPU MODULE

unit are mounted as unpackaged chips directly onto the combination heatsink and pc board. They're then covered with an encapsulant for environmental protection. The read-write buffer chip is also mounted directly to the pc board, but its power is considerably lower and need not be mounted on a heatsink. Such a direct-attach approach eliminates the expensive pin-grid packages, reduces wire lengths and inductances from chip to chip, and improves the heat removal. Consequently, chip reliability is enhanced.

### PULLING OUT THE HEAT

The heat-sink for the CPU and floating-point unit consists of a high-thermal-conduction copper-tungsten slug, with its coefficient of expansion matched to that of silicon. The slug is mounted to the top-side of the module. An opening is cut in the module pc board so that the chip can be mounted onto the slug and then wire-bonded to the pc board.

Not only does the scheme have all of the benefits mentioned in the previous paragraph, but it also improves manufacturing yield. In some designs, tight timing parameters for various CPU control signals, delays caused by packages, and long pc-board wire traces can often cause devices in a CPU system with marginal timing specifications to not work together. The inability to work together comes from the slight timing mismatches caused by longer-than-desired wiring delays. By reducing the delays, the chance of a timing mismatch is reduced and the manufacturing yield of the subsystem goes up substantially.

The rest of the active components are housed in small-outline or plastic leaded chip carriers and are mounted with standard surface-mount manufacturing techniques. Passive components, such as the bypass chip capacitors and pull-up chip resistors, are surface-mounted directly to the pc board. To minimize chip count, each cache was implemented with just three 8-kword-by-20-bit static RAMs to form dual 8-kword-by-60-bit caches.

The LR3000 integer unit manufac-

tured by LSI is a direct alternate source of the R3000 created by Mips. It consists of two tightly coupled processors—the 32-bit RISC integer processor and a system-control processor that handles the memory management thanks to an on-chip 64-entry translation-look-aside buffer. The floating-point unit is tightly coupled to the CPU and conforms fully to the IEEE floating-point standard for single- and double-precision calculations.

A custom-created write-buffer chip, the LR3220, offers six-level-deep write buffering to prevent pipeline stalls during a write operation. A special clock-generator chip creates the four clock signals required by the LR3000 CPU from a single-phase clock input to the module. With reset logic on the module, various user-selectable modes can be set during the initialization period. The modes are set by controlling the state of the interrupt inputs during initialization.

Of the 100 pins available on the user-interface connector, 32 are assigned for the data bus, 30 for the address bus (plus several bus-control lines), 5 for interrupt inputs, and 4 for byte read and write masks. Three are assigned to indicate branch conditions and others are for the system clocks. Additional lines handle module control and error signaling, and seven lines are reserved for future use. Power and ground pins are actually separate from the two rows of signal pins. The 100-pin Amp  $\mu$ Strip connector has five metal plates positioned between the two rows of 50 pins. The plates form low-resistance power and ground connections. □

### PRICE AND AVAILABILITY

The LRM3310 Mips N-gine is available in sample quantities from stock. In lots of 5000, the card sells for less than \$1000.

LSI Logic Corp., 1551 McCarthy Blvd., Milpitas, CA 95035; Pamela Aratani, (408) 954-4655. CIRCLE 511

HOW VALUABLE?	CIRCLE
HIGHLY	554
MODERATELY	555
SLIGHTLY	556

# Zenith Data Systems Presents Everything You Love About The PC ...Plus The Benefits Of Graphical Computing.

## ZENITH DATA SYSTEMS INNOVATES AGAIN™

Zenith Data Systems was the first to offer Microsoft® Windows™ version 3.0 and Asymetrix® ToolBook® pre-installed on every hard drive 386-based desktop PC. And that's just part of *The Seamless Solution* we've created for today's graphical computing environment.

With Microsoft Windows version 3.0 and the fingertip simplicity of the Microsoft Mouse, your Zenith Data Systems PC lets you glide graphically, *seamlessly* between applications. While Asymetrix ToolBook lets you design your own applications under Windows version 3.0. So your productivity will soar. With the greatest of ease.

A \$643 value,\* Microsoft Windows version 3.0, Asymetrix ToolBook and the Microsoft Mouse are all yours with every Intel386™, 386 EISA or 386SX desktop PC.

Add our award-winning 14" VGA Flat Technology Monitor, and you've got *The Seamless Solution*. So your Windows version 3.0 and ToolBook applications will come to life with breakthrough clarity.

Zenith Data Systems. Transforming the PC into a powerful graphic environment. For more information and the name of your nearest Zenith Data Systems Medallion Reseller, call:

**1-800-523-9393**



### **The Zenith Data Systems Sphere**

*The universal symbol of simplicity, the sphere perfectly represents The Seamless Solution™ from Zenith Data Systems.*

**ZENITH**  
data systems 

Groupe Bull

# AVOID DESIGN PITFALLS WHEN WORKING WITH PLDs

PROGRAMMABLE  
LOGIC DEVICES  
GIVE A BIG  
BOOST TO  
SYSTEM  
INTEGRATION,  
BUT CERTAIN  
DESIGN  
PRACTICES MUST  
BE FOLLOWED.

CHUCK TRALKA

Altera Corp., 2610 Orchard Pkwy.,  
San Jose, CA 95134-2020; (408) 984-2800.

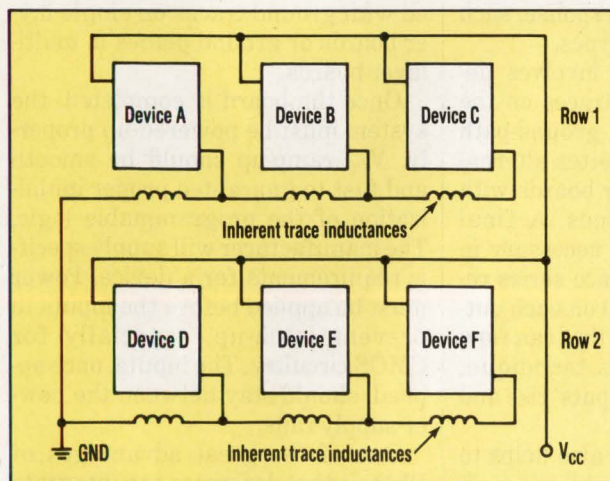

**1. THE INHERENT TRACE** inductances shown in these two separate ground paths can cause ground-bounce problems when several outputs on a device switch simultaneously. Incorrect logic levels may result.

To integrate programmable logic devices into designs successfully, engineers must approach PLDs as both components in a board-level system and as discrete devices. In addition to the same board-level design concerns they face with discrete logic, designers must contend with timing and architectural considerations specific to PLDs. Because large logic blocks are integrated into one PLD, problems that initially appear to be device related often result from improper logic design. Consequently, care must be exercised in designing the PLD logic, the board logic, and the board layout.

At the board level, PLDs behave much like other digital logic ICs. Nonetheless, as programmable logic increases in speed and density, designers must pay more attention to proper board design and layout to ensure that the PLD will function correctly in the system. Good layout practices take into account loading, decoupling, and crosstalk.

The designer's first concern should be that the device pins are connected properly to the rest of the circuit on the board. PLDs usually have a set of dedicated-input pins and a set of I/O pins. The I/O pins can be configured as inputs or outputs, and may provide feedback for internal ("buried") logic functions. It's not uncommon for some pins to be left unused.

Typically, unused dedicated inputs should be tied to ground. Otherwise, they might float to an arbitrary voltage level where they can toggle between a logic one and a logic zero, inducing noise and consuming unnecessary current. In some cases, the PLD manufacturer recommends that all unused I/O pins also be tied to ground for the same reasons. In other instances, unused

I/O pins may actually be used internally for feedback, or the design software may cause the pins to be tied to some internal logic level. If so, these pins must be left floating for proper device operation. Designers should always follow the manufacturer's recommendations.

The next consideration is the resistive and capacitive loads driven by the PLD outputs. Resistive loads limit the output's fan-out. For example, with an output pin at 0 V (a worst-case value) a 1-k $\Omega$  pull-up resistor tied to a  $V_{CC}$  of 5 V will draw 5 mA [(5 - 0)/1000]. Consequently, a pin that can sink 8 mA can control only one such load and remain within the specified maximum current limit.

Unlike resistive loads, purely capacitive loads don't affect fan-out, but instead limit the rise and fall times of the PLD output signals. This is because:

$$I = dQ/dT \text{ and } Q = CV$$

where  $I$  is the output drive current,  $Q$  is the charge,  $T$  is time,  $C$  is the load capacitance, and  $V$  is the voltage change of the output. As a result,

$$dT = d(CV)/I$$

# WORKING WITH PLDS

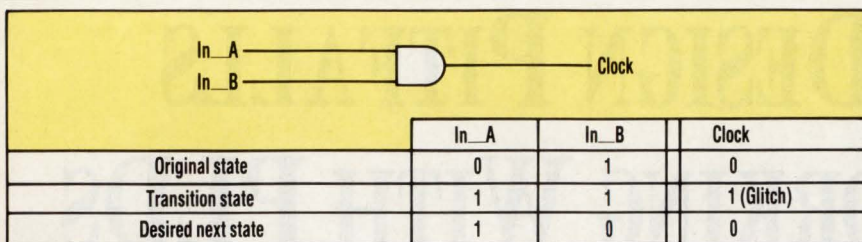

**2. IF A CLOCK SIGNAL IS GATED**, even with a single AND gate, a glitch can result if the inputs don't change at the exact same time. In this case, Input A changed slightly before Input B. A momentary "one-one" state ensued, causing a glitch.

Thus, rise and fall times increase with greater load capacitance and decrease with greater output current drive capability.

The fast switching times of today's PLDs create the potential for another current-related problem—ground bounce. Ground bounce can occur when multiple outputs on a fast device switch at the same time, causing a large transient current to flow through the device's ground path. The rapidly changing current combines with the inherent trace inductance to temporarily raise the ground voltage [ $V = L(dI/dT)$ ] for other devices that share the same ground line. Because their reference voltage has risen, the output voltage levels from these devices may also rise. In the worst case, a logic-low voltage can rise enough to be seen by devices that don't share that portion of the ground line as a logic high.

An example is a typical printed-circuit board with three digital devices (A through C) tied to one ground line and three more devices (D through F) tied to a second ground line (Fig. 1). If several outputs on device C switch at the same time, the resulting current transient can also raise the ground voltage-reference level for devices A and B. If the output of one of these components feeds a device in the second row (D, E, or F), a low output can be interpreted incorrectly as a high signal. The illegal high level can then propagate through the system, causing incorrectly clocked or cleared registered functions and creating glitching in combinatorial logic.

Some PLDs contain output drivers specially designed to reduce this problem. Board designers, however,

can also take steps to reduce ground bounce. The most obvious precaution is to decouple the device's power and ground pins using the capacitor values recommended by the device manufacturer. Decoupling capacitors supply a reservoir of charge that buffers the board power and ground lines from the large transient currents that digital ICs can draw. Each pair of  $V_{CC}$  and ground pins should be decoupled with a separate capacitor placed as close to the device leads as possible.

The board itself should be decoupled with two capacitors in parallel, located as close as possible to the point where power and ground arrive at the board. One should be a large capacitor (typically around 33  $\mu\text{F}$ ) that dampens large, low-frequency current fluctuations. The other should be a small capacitor (usually about 0.1  $\mu\text{F}$ ) that does the same for high-frequency current fluctuations. Use capacitors that have good frequency response, such as monolithic ceramic types.

Another precaution involves designing large ground traces on the board to minimize the ground-path impedance. An even better alternative is using multilayer boards with complete ground planes. A final measure, usually only necessary in extreme cases, is to place series resistors (100  $\Omega$  typically) on each output to limit the current that can flow through the pin. This technique, however, slows the outputs' rise and fall times.

Proper board layout also helps to avoid other common problems, such as signal reflection and crosstalk. To minimize reflection, trace lengths should be short compared to the rise

and fall times of the signals. If the signal's propagation time down the length of the trace is more than half of the rise or fall time, designers should treat the trace as a transmission line.

Transmission lines have a characteristic impedance, which is determined by inherent resistances, inductances, and capacitances. To eliminate reflection, this impedance must match the load impedance. Matching is usually done with a pair of resistors at the load device. One resistor is tied from the signal to  $V_{CC}$  and the other from the signal to ground. Many texts explain the derivation of the resistor values.

Another problem related to traces on the boards is crosstalk. Crosstalk is caused by inductive and capacitive coupling between parallel traces. Inductive coupling results when current flowing in one trace generates a magnetic field that induces a current in another trace. Capacitive coupling occurs when two parallel traces behave like the plates in a capacitor and attempt to maintain a constant voltage between themselves.

To minimize crosstalk, designers should avoid running long traces parallel to one another. If they must be parallel, the traces should be as far apart as possible and should alternate with ground traces. Particularly noisy lines (such as system clocks) should be as distant as possible from other signals and surrounded with ground traces on single-layer boards or ground planes in multi-layer boards.

Once the board is completed, the system must be powered-up properly.  $V_{CC}$  ramp-up should be smooth and fast to guarantee proper initialization of the programmable logic. The manufacturer will supply specific requirements for a device. Power must be applied before the inputs to prevent latch-up, especially for CMOS circuitry. The inputs, once applied, should stay between the power-supply rails.

One of the great advantages of PLDs is that designers can integrate entire subsystems into one device, decreasing component counts and increasing system reliability. Howev-

# WORKING WITH PLDS

er, potential problems can also occur in the PLD. In systems that use discrete logic, these design problems appear at the board level. But in PLD-based systems, they seem to be device problems.

Not surprisingly, then, many PLD problems are related to logic design practices at the device level. A number of these problems can be avoided by careful design practices. Thorough simulation, using the software simulators that PLD manufacturers and third-party vendors supply, will also lessen logic design flaws.

Clock timing is one source of these problems. Nearly all digital designs include some registered logic and, thus, a clocking scheme. Often, one or more clocks are controlled by a logic function in another part of the design. The function may be as simple as one gate, such as a NAND, AND, or NOR gate, or may include more complex logic. Although designers are usually careful about creating and checking the clock's Boolean function, they sometimes overlook potential timing hazards.

For example, intermediate states during logical transitions can cause glitches at the gated function's output. The glitches may last only a few nanoseconds, but that's long enough to clock edge-sensitive functions. Clocks that come from single gates will be reliable if no more than one input changes within the time required for the gate's output to settle to the correct value. If two or more inputs change within this period, the potential for glitching exists.

Even a simple AND gate is susceptible to glitching. If the gate's two inputs change value simultaneously from "zero-one" to "one-zero," the gate's output should theoretically remain at zero. But if the inputs pass through state "one-one" on the way to their final state, the gate will output a one during that period (*Fig. 2*). The incorrect output will be very short, but it may be long enough to clock a flip-flop.

Clocks controlled by more complex logic are difficult to implement reliably in discrete logic, yet are even tougher in PLDs. The problem con-

cerns complex functions that may get implemented in multiple levels of logic within the PLD. Because inputs to such a function can feed different levels simultaneously, designers must allow for a settling time as the signals propagate through all levels. During this time, the function's output may change state, making the function unsuitable as a clock.

The situation is further complicated because designers seldom have precise control over how the PLD design software will minimize the logic. Consequently, the problem can't be avoided by controlling the timing of the inputs to the clock-controlling function.

The best way to eliminate this hazard is to avoid complex gated clocks. One synchronous clock can control all of the registered functions in the design. Then designers can create the appropriate logic (D, T, J, K, etc.) for the register data inputs, which aren't edge-sensitive and must be qualified by the system clock.

For example, designers can convert the output of a multiplexer from a potentially hazardous clock signal to a clean clock signal by adding a flip-flop. The multiplexer's output becomes the D input of the flip-flop, whose Q output clocks the original function, which in this case is a shift register (*Fig. 3*). The system-clock line clocks the flip-flop, thus qualifying the multiplexer's output. The design must include enough set-up time between the changing of the multiplexer inputs and the system clock's arrival.

Gated functions can cause a similar problem when they control register asynchronous preset or clear signals. The same type of glitch that's a nuisance for clock functions can incorrectly preset or clear a register.

Counter designs are particularly susceptible to this problem. For example, one common practice is to decode the output of a counter to check for some terminal count. The decoded output is then used to asynchronously load the same counter, employing preset and clear controls on the counter flip-flops.

This design practice creates two potential hazards. First, designers

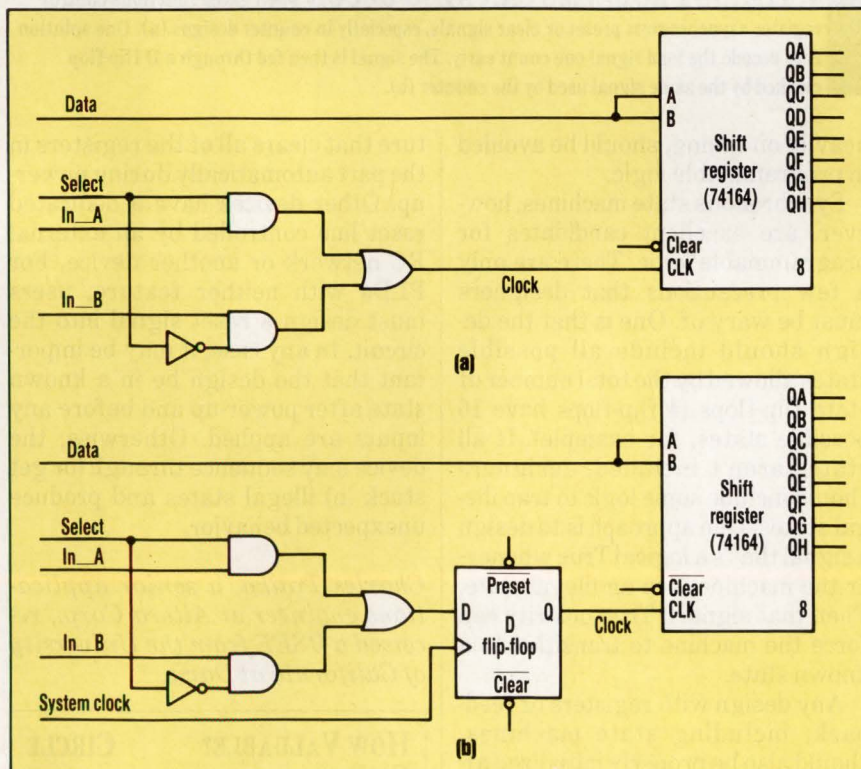

**3. CLOCKS CONTROLLED BY COMPLEX LOGIC** can cause glitches because of timing problems (a). Connecting the gated function to a flip-flop that's clocked by a synchronous system clock avoids such problems (b).

# WORKING WITH PLDS

can't ensure that all flip-flops change state at exactly the same time, so the decoded output may glitch. A glitching output may load an incorrect value into the counter. While the counter is loading, the decoded "load" signal starts to become false, possibly trapping the counter in some intermediate state.

One solution is to use synchronously loaded counters and design the appropriate load logic. Another option is to retain the asynchronously loaded counters but decode the load signal from the counter outputs one count early. This result is fed into the data input of a D flip-flop, which is clocked by the same clock used for the counter (Fig. 4). Finally, the Q output of the flip-flop becomes the counter's asynchronous load input. This design ensures that the counter has a valid load signal for one clock cycle.

PLDs also engender other timing issues. For instance, designers occasionally use an even number of inverters to create delays. But PLD design software minimizes logic without regard for timing, so two series inverters become just a wire. As a result, delay elements should generally be avoided in PLDs.

The completed design's timing should be examined to ensure that it doesn't exceed the device's maximum speeds. Most manufacturers supply timing models and parameters to aid in this design verification. Sophisticated timing analysis tools are also available for higher-density PLDs. To make sure that the largest PLDs operate properly, designers must perform complete functional and timing simulations with software supplied by the manufacturer or third-party vendors.

Not all designs lend themselves to PLD implementation. For instance, PLDs can accommodate designs that rely on combinatorial feedback if they don't require precise timing control. But many programmable device architectures are unable to handle combinatorial feedback within a logic array, so designers must consume a macrocell feedback. And asynchronous state machines, whose proper operation depends

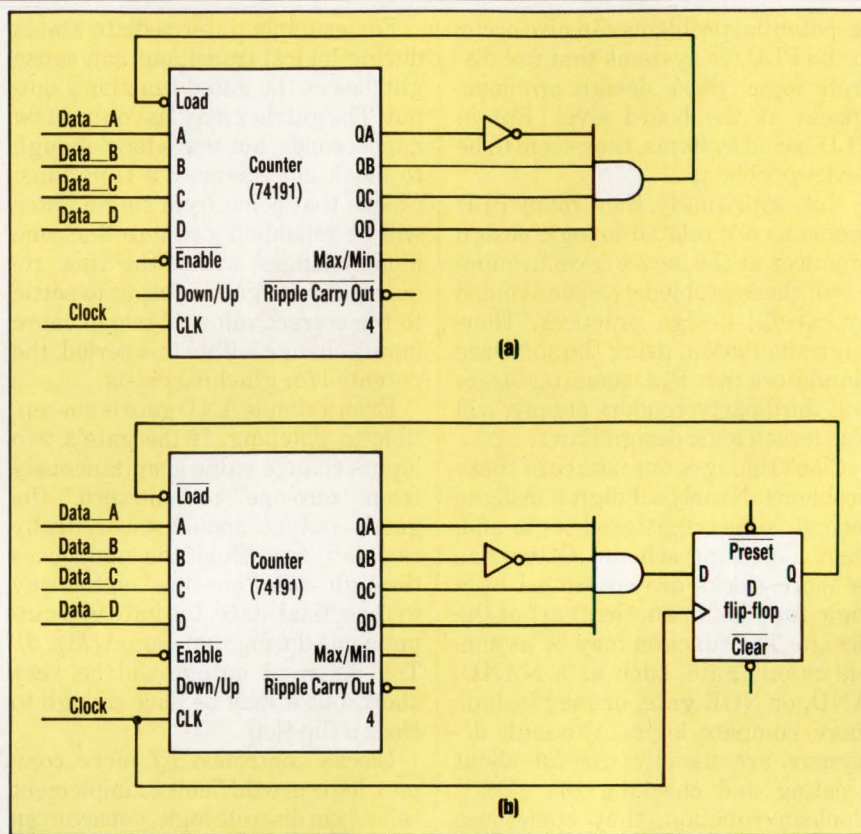

**4. TIMING PROBLEMS CAN ALSO OCCUR** when gated functions control register asynchronous preset or clear signals, especially in counter designs (a). One solution is to decode the load signal one count early. The signal is then fed through a D flip-flop clocked by the same signal used by the counter (b).

heavily on timing, should be avoided in programmable logic.

Synchronous state machines, however, are excellent candidates for programmable logic. There are only a few precautions that designers must be wary of. One is that the design should include all possible states allowed by the total number of state flip-flops (4 flip-flops have 16 possible states, for example). If all states aren't included, designers should include some logic to trap illegal states. One approach is to design a signal that's a logical True whenever the machine is in an illegal state. Then that signal's True polarity can force the machine to transition to a known state.

Any design with registers or feedback, including state machines, should also be properly initialized after power-up. Some PLDs, such as Altera's EP and EPM families of devices, include a power-on reset fea-

ture that clears all of the registers in the part automatically during power-up. Other devices have a dedicated reset line controlled by an external RC network or another device. For PLDs with neither feature, users must design a reset signal into the circuit. In any case, it may be important that the design be in a known state after power-up and before any inputs are applied. Otherwise, the device may sequence through (or get stuck in) illegal states and produce unexpected behavior.

*Charles Tralka, a senior applications engineer at Altera Corp., received a BSEE from the University of California at Davis.*

## HOW VALUABLE?

HIGHLY  
MODERATELY  
SLIGHTLY

## CIRCLE

541  
542  
543



AT&T is

packing it in.

**Packing 5 full watts of reliable power into a space-saving 1.1x2x.46" board-mount case.**

Imagine a Board Mounted Power Module (BMPM) this small with a full 5W output, equaling 4.9W per cubic inch. Think of the design flexibility and savings in board space. The reduced design time. The lower stocking, service and installation costs.

Designed to help you utilize AT&T Bell Laboratories' innovative distributed power architecture, our BMPMs incorporate reliability-enhancing product and system features. They operate at an efficiency rate surpassing 80% with ambient temperature tolerances up to 85°C, reducing heat dissipation and improving reliability.

Leading edge AT&T design and manufacturing techniques enable our entire line of catalog BMPMs to meet Bellcore standards, backed by a 3-year warranty.

All 5W to 20W components are pin-for-pin compatible with industry standards. Most are available with single and multi-output voltages and international input ranges.

Cut power down to size with AT&T BMPMs. Call for our catalog of 5W to 150W modules: **1 800 372-2447, ext. 591.**

The  
components  
of success.



**AT&T**  
The right choice.

# BOGGED DOWN IN SILICON VALLEY?

Copyright © 1989 TriQuint Inc. All rights reserved. Solid GaAs is a trademark of TriQuint Inc. TQA 101

## SWITCH TO SOLID GaAs.™

The road to silicon ASICs is safe. Well-traveled. Familiar. But it may not facilitate the high performance you need.

Fortunately, there's another solid and dependable alternative: TriQuint GaAs. TriQuint GaAs can give you the competitive edge you need, for applications requiring I/O speeds from 100 MHz to 2.5 GHz.

We have the proven track record you should demand of *any* design center or component vendor. We've been paving the way for high-performance ASICs—including higher speeds, greater integration, less power drain and more flexible packaging—for nearly a decade.

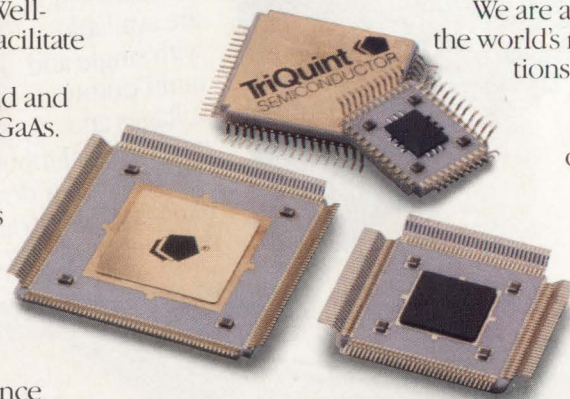

We are a preferred resource for many of the world's most respected telecommunications, instrumentation and computer companies.

Get the facts on our full range of GaAs ASIC components. All in full compliance with industry-standard I/O and power supply levels for ECL, TTL and CMOS. All supported by Daisy and Mentor. All backed by TriQuint's full spectrum of services.

Call TriQuint at 1-800-344-7641.

In Oregon 644-3535. We'll show you competitive advantages that can put you into the passing lane.

**TriQuint**   
SEMICONDUCTOR

S O L I D G a A s™  
DIGITAL/LINEAR PRODUCT DIVISION • MICROWAVE PRODUCT DIVISION • MLC PRODUCT DIVISION

CIRCLE 167

# UNDERSTAND EISA BUS-CYCLE TRANSLATIONS

CREATE FLEXIBLE  
 EISA-BASED SYSTEMS  
 BY MATCHING 8-, 16-,  
 OR 32-BIT EXPANSION  
 CARDS TO THE BUS

# T

he enormous popularity of the IBM personal computer, introduced in 1981, and its successor, the PC/AT in 1984, has led to the computer's expansion bus architecture as an accepted de facto industry standard. Billions of dollars have been invested by system and peripheral manufacturers

in hardware and software to duplicate and enhance what's commonly known as the Industry Standard Architecture (ISA) bus. For its time, the ISA offered system users a reasonable amount of expansion capability and performance, with a 24-bit address path, a 16-bit data bus, and an 8-MHz peripheral bus. Moreover, attachments for the bus were relatively simple to develop.

In 1988, a consortium of computer companies developed the Extended Industry Standard Architecture (EISA) bus (see "A Snapshot of the EISA bus", p. 86). The EISA bus, which is a superset of the ISA bus, gives designers a 32-bit architecture that has a 32-bit address path and uses an 8-MHz system bus clock. The bus architecture supports conventional slave-mode expansion boards and multiple-bus-master capability. Bus-master cycles and DMA operations achieve data-transfer rates of 33 Mbytes/s using a burst-mode feature included in the EISA definition.

EISA is fully backward compatible, which makes it possible to use old or new ISA add-in boards and software with the more powerful EISA-based systems. At the same time, the specification doesn't require that EISA boards comprehend ISA bus cycles. As a result, EISA card designs can be implemented more easily. The system motherboard hides the complicated details of interfacing to ISA devices from the EISA devices, and translates bus cycles between the two architectures for card-to-card transfers.

The EISA architecture enhances the interrupt scheme by allowing interrupt sharing. The interrupt lines can be individually programmed to the ISA-compatible, edge-triggered mode or EISA-sharable, level-triggered mode.

By thoroughly understanding the cycle translation mechanisms, EISA buses can be built to accept 8-, 16-, and 32-bit expansion boards. To keep the expansion-card design as simple as possible, the EISA bus logic incorporated on the system

AMARESH KUMAR

Intel Corp., 1900 Prairie City Road, Folsom, CA 95630; (916) 351-8080.



# UNDERSTANDING EISA BUS CYCLES

motherboard significantly eases the data transfer between devices of different data sizes. EISA bus masters don't need to run multiple cycles if the slave board's data bus is smaller; the data byte resequencing is handled by the system board. In the original 8-bit PC architecture, there was no provision for bus masters—the system-board CPU or DMA chips always controlled the bus. When the PC/AT arrived on the scene, it introduced the concept of asynchronous 16-bit bus masters and 8- or 16-bit slave cards.

And now that EISA has arrived, 32- and 16-bit synchronous slave modes are also defined. They have the option of supporting burst cycles.

## SMART BUS MASTERS

Bus masters can control the bus, then select the desired operation and control the cycles on their own. They don't require using the main system CPU as a controller during data transfers, as do less intelligent slave boards.

The system CPU can operate in parallel, resulting in increased system performance. Even more intelligent bus masters would have a local CPU that can preprocess data, further reducing the burden on the main CPU. Bus masters serve in various applications, such as graphic or network controllers.

In addition to supporting relatively low-transfer-speed asynchronous ISA bus masters, the EISA bus permits synchronous bus masters to burst-transfer data at 33 Mbytes/s. Such burst transfers are only possible if both the EISA master and slave cards support the burst mode, and the slave's data-path size is equal to or greater than that of the master. This would seem to rule out 32-bit EISA masters from running burst cycles to 16-bit EISA slaves. However, 32-bit bursting EISA masters can be designed to "downshift" their size. As a result, they would shift on-the-fly to appear as a 16-bit card, and then run burst cycles to a 16-bit slave.

Because the EISA bus talks to different sizes of both masters and

slaves, it must translate bus cycles if the master and slave types don't match. Furthermore, the bus controller on the system board must determine which master controls the bus by decoding the EXMASTER, MASTER16 and MSBURST signals (Table 1).

The control starts when the EXMASTER signal is generated by the system-board arbiter after an EISA master is granted the bus. In return, if the board is a 16-bit or EISA master, the MASTER16 signal is driven

by the board. (MASTER16 is also driven by 16-bit ISA masters when they control the bus.)

MASTER16 is usually valid before the start of the cycle. But, if the signal is sampled and is high at the beginning of the START signal and low at the end of START, the master is a 32-bit bursting master that will downshift to 16 bits if a 16-bit bursting slave responds.

The system board decodes the EISA and ISA slave-size signals (EX32, EX16, M16 and IO16) so that

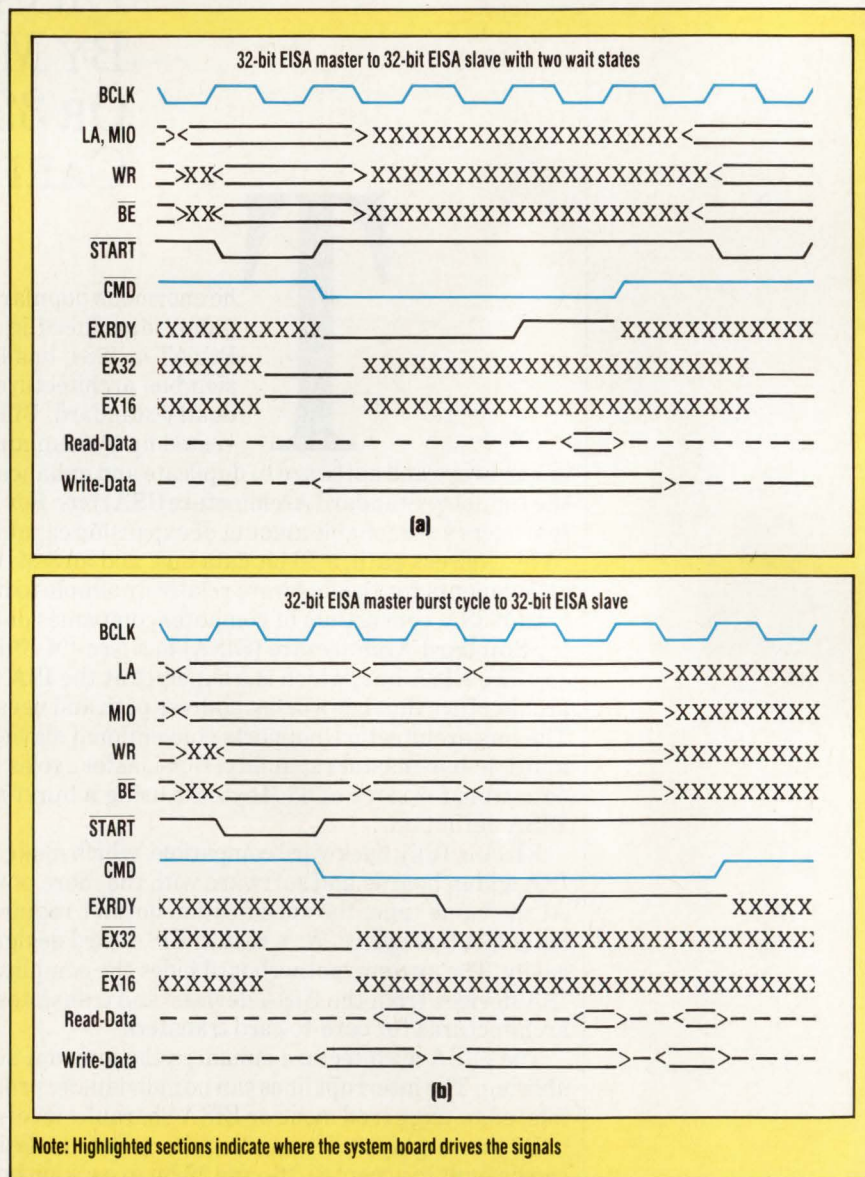

**1. WHEN A 32-BIT EISA MASTER** communicates with a 32-bit EISA slave, the system board keeps the CMD line active for the length of the non-burst transfer cycle, which requires two BCLK cycles (a). With a burst-cycle transfer, data can be read or written on every BCLK cycle, improving the system's overall data-transfer rate (b).

# Now! Up to 120,000 usable gates in a three-layer metal array.

117,000  
118,000  
119,000

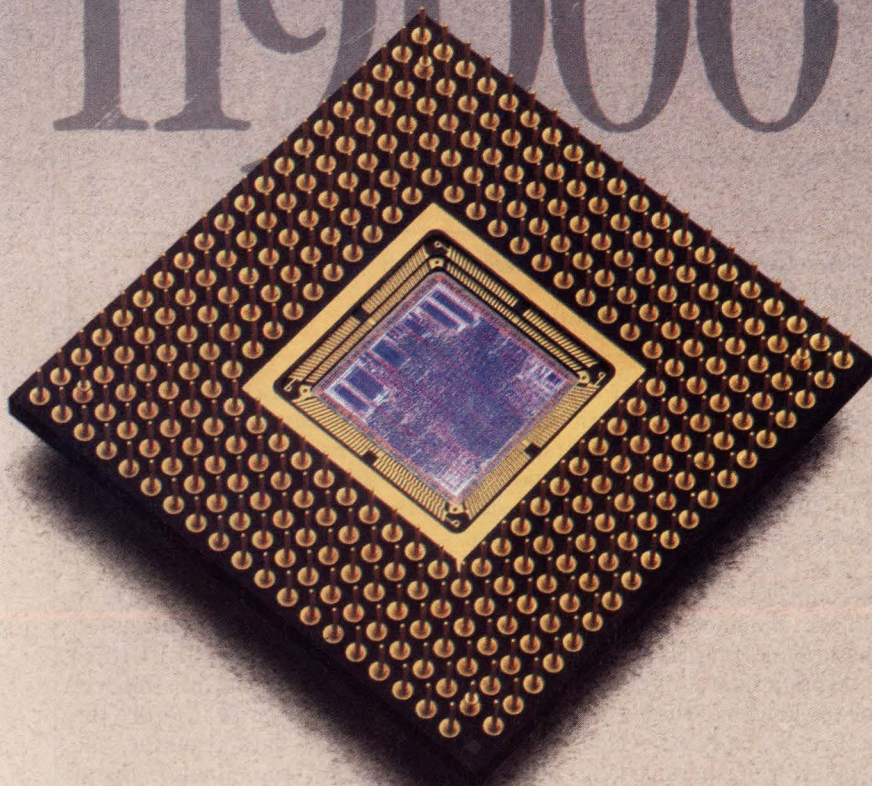

**Toshiba's 1-micron CMOS gate arrays provide the capability for a whole system-on-a-chip with gate delays of 0.4 ns.**

Toshiba's TC150G series of 1.0 micron CMOS gate arrays pack up to 120,000\* usable gates on a 172K master. The series uses our proven architecture combined with triple-layer wiring technology that makes highly efficient use of silicon.

The TC150G series is supported by a compatible library of more than 800 macrocells and over 150 macrofunctions. Our design environment covers the full CAD tool spectrum which includes high-level description language; design capture; design simulation; synthesis/design optimization ... and more! The Toshiba design environment is compatible with all major EWS including AIDA, Cadence, Dazix, HILO, HP, IKOS, Mentor, Synopsys, VALID, Verilog and Viewlogic.

Where design economy is a priority, Toshiba offers high pin-count plastic flat packs as a surface mount alternative to PGAs for many applications.

The series is available in 14 master array sizes ranging from 1,400 usable gates to 120,000, or up to 40,000 in plastic. And, you can depend on Toshiba to meet virtually any production quantity your business demands.

THE POWER IN GATE ARRAYS.		
SERIES	2-LAYER METAL TC140G	3-LAYER METAL TC150G
GATES	2,300 TO 172,000	2,300 TO 172,000
USABLE GATES	1,000 TO 68,000	1,400 TO 120,000
GATE LENGTH	1.0 $\mu$ . (drawn)	1.0 $\mu$ . (drawn)
GATE SPEED	0.4 ns	0.4 ns
OUTPUT DRIVE	up to 24 ma.	up to 24 ma.
PART NUMBERS	14	14
SECOND SOURCE	YES	YES
AVAILABILITY	NOW	NOW

There are five Toshiba design centers around the U.S. and one in Ottawa, Canada to help you. For technical literature, call 1-800-888-0848, extension 517 today. *Service is our key component.*

In Touch with Tomorrow  
**TOSHIBA**

TOSHIBA AMERICA ELECTRONIC COMPONENTS, INC.

\*Gate utilization is dependent upon architecture. AIDA, Cadence, Dazix, HILO, HP, IKOS, Mentor, Synopsys, VALID, Verilog and Viewlogic are registered trademarks by others.

© 1990 Toshiba America Electronic Components, Inc.

MAS-90-030

Toshiba semiconductor products are available from the following Toshiba offices: Deerfield, IL, (708) 945-1500; Burlington, MA, (617) 272-4352; Sunnyvale, CA, (408) 737-9844; Tustin, CA, (714) 259-0368; Richardson, TX, (214) 480-0470; Norcross, GA, (404) 368-0203.

CIRCLE 172



# UNDERSTANDING EISA BUS CYCLES

it can determine the type and size of the slave (Table 2).

The different masters and slaves result in varied combinations of cycles (Table 3). If the master and slave types don't match (the master and slave aren't both EISA or ISA), then the system board will translate control signals from EISA to ISA or vice-versa.

If an EISA master happens to be addressing a slave of smaller size, then the system board will copy the data between byte lanes and, if necessary, run multiple cycles.

The type of cycle executed by the bus master depends on the data width of the master and slave, and whether they're ISA or EISA compatible. Consider the case of a 32-bit EISA master. The master must first request control of the EISA bus by asserting its Master Request (MREQ) signal. The system board arbitrates between the different requests.

When its turn comes, the bus is granted to the master and its Master Acknowledge (MAK) signal is asserted. The master then drives the Unlatched Address (LA) lines and the Memory-I/O (MIO) signal. It then pulses Start low for one bus clock and drives the Byte Enable (BE) and Write-Read (WR) signals. Halfway through START, the system board copies the address on the LA lines onto the Latched System Address (SA) lines.

## DECODING

EISA and ISA slaves then decode the address, and the addressed slave responds. The 32-bit EISA master doesn't care which slave responded, it just samples EX32 to see if it found a matching-size slave. If a match occurred, the cycle proceeds without the need for any participation from the system board. A 16-bit master must sample both EX32 and EX16. If either one is active, it decodes a match. Consequently, a 16-bit master cycle to a 32-bit EISA slave is defined as a match. Moreover, the system board handles routing the data between the upper and lower word, if necessary.

In a 32-bit matched non-burst cycle,

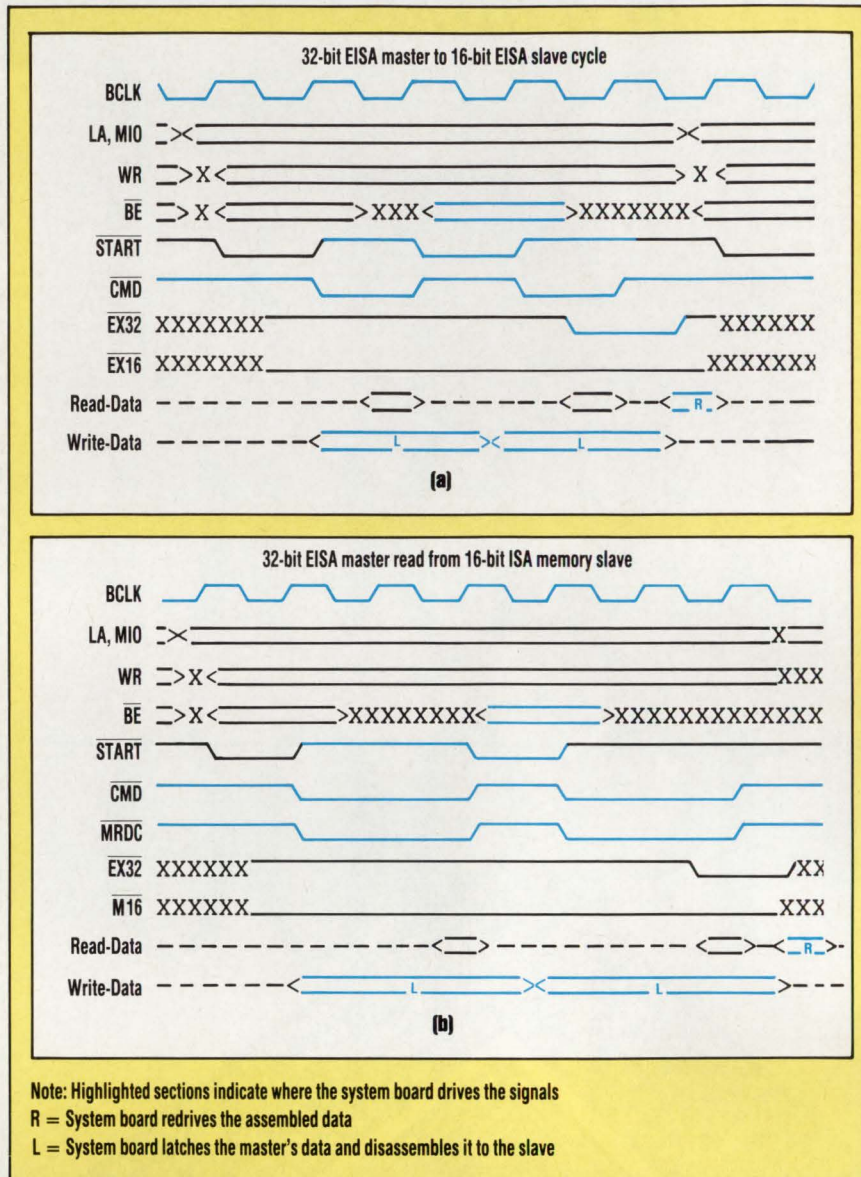

**2. THE DATA TRANSFER** between a 32-bit EISA master and a 16-bit EISA slave requires more signals to be driven by the motherboard. This is because the 32-bit data must be sent in 16-bit sections to the 16-bit card (a). When the same master exchanges data with a 16-bit ISA memory slave card, the operations require more time, as shown by the longer START, CMD, and MRDC signals (b). The system board must also do more work to translate the EISA bus cycles to ISA cycles and vice versa.

cle, the address, BE, MIO, and WR signals are pipelined (Fig. 1a). The Command (CMD) signal is generated by the system board and is kept active for the length of the cycle.

The fastest non-burst cycle is two Bus Clock (BCLK) periods long. If it turns out that the slave needs additional clocks, it can add wait states by negating the EISA Ready (EXRDY) signal.

The burst cycle starts similarly to a non-burst cycle. The addressed slave drives Slave Burst (SLBURST) active to indicate that it supports burst transfers (Fig. 1b). Before the end of the first data transfer, the master asserts the Master Burst (MSBURST) line to indicate that it wants to do a burst cycle. If the system board samples both MSBURST and SLBURST active, and if the mas-

**0.99 Power Factor Corrected Switcher With Universal Input**



1000 watt single and multiple output switch-mode power supplies operate from 120 VAC 15 Amp service, or as Universal Input from 90 to 264 VAC line without strapping. Units meet IEC 555-2 harmonic distortion and UL, CSA, VDE, EN, and FCC safety and EMI specifications. Other models operate from 48 VDC or 120/230 VAC.

Contact: **Qualidyne** (619) 575-1100

**Qualidyne** ▶ **CIRCLE 641**

**Compact, Modular Switchmode Supply Meets Class B EMI**



Compact power supplies can provide up to 400 watts with hundreds of volt/amp combinations of from 1 to 7 DC outputs. Units are available with in-line or side-mount I/O terminals and operate from 120/230 VAC. Options include Auto Current-Sharing with a isolated Power Supply Fail signal, ideal for N+1 use.

Contact: **Qualidyne** (619) 575-1100

**Qualidyne** ▶ **CIRCLE 642**

**Low Profile/Low Cost Supplies Are Only 2" to 3" High**



Compact switchers feature robust, high-current main and auxiliary outputs to suit OEM needs. Single and multiple output models provide from 250 to 1000 watts. Wide user-adjustment ranges, auto AC line select, integral fan-cooling, margining, and inhibit are among the features and available options.

Contact: **Qualidyne** (619) 575-1100

**Qualidyne** ▶ **CIRCLE 643**

**Modular 5" x 5" & 5" x 8" AC-DC Switchers & DC-DC Converters**

Hundreds of models with up to 9 independent outputs can be easily configured to meet custom requirements without delays. Providing 800 to 3000 watts, units operate from 48 VDC or 120/230 VAC. All meet EMI and safety specs from UL, CSA, EN, FCC and VDE. Wide adjustable and current sharing outputs available.

Contact: **Qualidyne** (619) 575-1100

**Qualidyne** ▶ **CIRCLE 644**

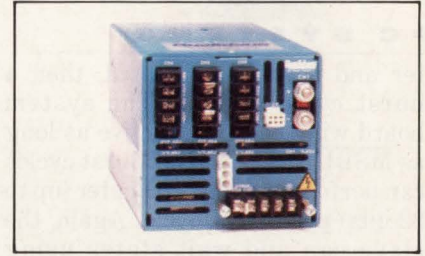

1990-91 CATALOG  
**SWITCHMODE POWER SUPPLIES**  
■ AC-DC ■ DC-DC CONVERTERS ■ 0.99 POWER FACTOR

- Low Cost
  - Low Profile Case
  - 250 to 600 Watts
  - 1 to 4 Outputs



- User-Configurable
  - 1 to 9 Outputs
  - Quick Customized Supplies
  - Modular Construction

- Feature-Intensive
  - Low Profile Cases
  - 1 to 9 Outputs
  - 500 to 1000 Watts

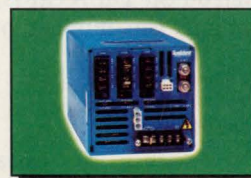

- Wide Adjustment Ranges
  - 600 to 1000 Watts
  - 2V to 56VDC Outputs
  - 1 to 7 Outputs

- 1KW to 3KW
  - 1 to 9 Outputs
  - N + 1 Redundancy



**Qualidyne**  
Lambda Group of Unitech plc



FREE NEW 66-PAGE CATALOG/BINDER

CALL OR WRITE: **QUALIDYNE**

3055 DEL SOL BLVD.

SAN DIEGO, CA 92154

PHONE: (619) 575-1100

FAX: (619) 429-1011

▶ **CIRCLE 645**



# UNDERSTANDING EISA BUS CYCLES

ter and slave sizes match, then a burst cycle results. The system board will keep  $\overline{CMD}$  active as long as  $\overline{MSBURST}$  is active. Burst cycles can perform one data transfer (up to 32 bits) per  $\overline{BCLK}$  cycle. Again, the slave can add wait states using  $\overline{EXRDY}$ .

If no matching slave responds (for example, the slave size isn't equal to or greater than the master's size, or the slave isn't an EISA slave), the master "backs off" the bus and enables the system board to complete the cycle. The system board takes over the  $\overline{START}$  signal and the Byte Enables ( $\overline{BE}$ ), and runs multiple cycles to the smaller slave. If the slave was an ISA slave, the system board also generates ISA control signals. For write cycles, the system board

**TABLE 1: MASTER SIZE AND TYPE DETERMINATION**

Master size	EXMASTER	MASTERT6	MSBURST
32-bit non-bursting EISA master	0	1	1
16-bit non-bursting EISA master	0	0	1
32-bit bursting EISA master	0	1	0
32-bit bursting EISA master (with downshift)	0	1-0 (pulse)	0
16-bit bursting EISA master	0	0	0
16-bit ISA master	1	0	X

Note: 1) X - signal not decoded  
2) EXMASTER is generated by the system arbiter when an EISA master controls the bus.

latches the data from the master before it backs off, and redrives the data onto the appropriate byte lanes to match the slave size. For read cycles, the system board latches the data from the slave in smaller pieces, and at the end redrives the assembled data for the master. After this

sequence is done, the system board signals the EISA master by driving  $\overline{EX32}$  active ( $\overline{EX16}$  for 16-bit masters).

The  $\overline{EX32}$  and  $\overline{EX16}$  lines thus serve dual functions: they provide the slave-size decode at the beginning of a cycle, and signal the end of

## A SNAPSHOT OF THE EISA BUS

**B**ecause the EISA bus is a superset of the signals on the popular ISA (PC/AT) bus, this overview of EISA assumes a basic knowledge of the signals on the standard ISA connector. The EISA connector is rather unusual, in that it contains two rows of contacts for each side

of the expansion card that slips into the connector. The upper set of connector contacts contains all of the ISA signals and is used when an ISA card is plugged into the connector. The lower rows of contacts mate to the new contacts included on the EISA cards, nearly doubling the number of con-

tacts.

The major signals on the EISA connector include a 32-bit data bus; a latched 20-bit address bus; a segmented, unlatched address bus; and many new control signals. The following is a simplified description of each signal and the bus it's associated with:

**BCLK (ISA signal)** Bus Clock. Signal frequency can range from 6 to 8.33 MHz. This clock synchronizes events on the bus. Its period can be extended (or "stretched") by the system board. This increases performance in some applications.

**D[15:0] (ISA signal)** Data bus. These are the lower 16 lines that duplicate the 16-bit ISA data bus.

**D[31:16] (EISA signals)** Data bus. These include the upper 16 bits that provide the EISA bus extension to 32 bits.

**SA[19:0] (ISA signals)** System Address. These are the lower-20 latched bits of the system address lines and are valid throughout a bus cycle.

**SBHE (ISA signal)** System Bus High Enable. This line indicates whether the upper byte of a word is involved in a transfer. Along with SA0, it allows ISA masters to do byte or word accesses. For example if SA0 = 0 and SBHE = 0, the master is accessing the entire word; if SA0 = 1 and SBHE = 0, only the upper byte is being addressed. Similar to the SA bus, SBHE is valid throughout the cycle.

**LA[31:24] (EISA signals)** Unlatched Address. In addition to the latched system LA[16:2] addresses, the ISA bus provides unlatched upper (EISA signals) address bits LA[23:17] (latchable address). The EISA bus extends the LA bus to the entire 32-bit-addressing range. The latchable addresses may be pipelined from one cycle to the next, and can be latched at the trailing edge of  $\overline{START}$ . Note that the upper 8

bits are inverted logic, making it possible for pull-up resistors to force their value to one. This results in the upper address being zero.

**LA[23:17] (ISA signal)** Unlatched Address. Upper ISA address bits.

**BE[3:0] (EISA signal)** Byte Enable. There are four signals, one for each byte in the data path. The signals access different portions of the 32-bit double word. For example,  $\overline{BE}[3:0] = 0011$  indicates that the upper word is being accessed. Byte enables are pipelined like the LA address bus.

**AENx (ISA signal)** Slot specific Address Enable signal for slot x. When this signal is low, it indicates that the I/O slave may respond to the bus cycle. The signal selectively addresses I/O cards in their slot-specific address range. During DMA cycles, it's driven high by the system board to prevent I/O slaves from responding to the I/O control strobes being generated for the DMA device.

**MSBURST (EISA signals)** Master and Slave Burst.  $\overline{MSBURST}$  is asserted by an EISA master to indicate that the master wants to do a burst cycle. If the slave can support burst cycles, it asserts  $\overline{SLBURST}$  before the end of  $\overline{START}$ . If both  $\overline{MSBURST}$  and  $\overline{SLBURST}$  are asserted and the master's data bus size is smaller than or equal to the slave's data bus, or if the master downshifts its size to match the slave size, then a burst cycle results. The burst cycle continues until  $\overline{MSBURST}$  is de-asserted.



DESIGN APPLICATIONS  
**UNDERSTANDING  
 EISA BUS CYCLES**

system board's handling of a mismatched cycle (Fig. 2).

In the case of a 32-bit master sending data to a 16-bit EISA slave, the change in the  $\overline{EX32}$  signal indicates that a 32-bit EISA card is finishing a transfer cycle to a 16-bit EISA slave (Fig. 2a). A 32-bit communication with a 16-bit ISA slave starts much the same, but the cycles are longer to meet the ISA slave requirements (Fig. 2b).

When a 16-bit EISA master communicates with a 16-bit ISA slave, the bus interfaces are considered to be mismatched even though the sizes match. This is done so that the EISA master doesn't have to drive ISA signals—the system board does the translation.

ISA masters arbitrate for the bus

**TABLE 2: SLAVE SIZE AND TYPE DETERMINATION**

Slave	EX32	EX16	M16	I016
32-bit EISA	0	X	X	X
16-bit EISA	1	0	X	X
16-bit ISA (memory cycle)	1	1	0	X
16-bit ISA (I/O cycle)	1	1	X	0
8-bit ISA (memory cycle)	1	1	1	X
8-bit ISA (I/O cycle)	1	1	X	1

Note: 1) X – signal not decoded

using the DMA Request ( $\overline{DRQ}$ ) signal, and the system board grants the bus by activating the corresponding DMA Acknowledge ( $\overline{DAK}$ ) signal. The master presents the SA and LA address, and then drives the ISA command strobe—Memory Read, Memory Write, I/O Read, or I/O

Write ( $\overline{MRDC}$ ,  $\overline{MWTC}$ ,  $\overline{IORC}$  or  $\overline{IOWC}$ ). The system board samples the slave signals to see what kind of slave responded.

If both  $\overline{EX32}$  and  $\overline{EX16}$  are inactive, the master is addressing an ISA slave. The only role the system board plays in this case is to copy the data

**EX32, EX16 (EISA signals)** EISA Slave Size. The system board uses these signals to determine the data width of the expansion card. It also uses them to signal the end of a cycle translation to an EISA master.

**M16, I016 (ISA signals)** ISA Memory, and I/O Slave Size signals. ISA slaves generate these signals without using MIO. The master or system board samples the appropriate signal.

**EXRDY (EISA signal)** EISA Slave Ready signal. Used by EISA slaves to add wait states to the standard 2-BCLK cycle, or to the 1-BCLK-per-data-transfer burst cycle.

**CHRDY ISA (ISA signal)** Ready signal. Used by ISA slaves to add wait states to the standard cycle length.

**NOWS (ISA signal)** No Wait State signal. Used by ISA slaves to remove the default wait states from an ISA cycle, and by EISA slaves to run 1.5 BCLK compressed cycles.

**START, CMD (EISA signal)** Start and Command - These are timing-control signals for EISA cycles. START is asserted for one BCLK after the LA bus becomes valid. CMD is asserted by the system board when START is negated and remains active for the length of the cycle.

**WR (EISA signal)** Write/Read. A status signal that identifies cycles as either Read or Write. It becomes valid after START goes active.

**MIO (EISA signal)** Memory-I/O. A status signal that indicates whether the cycle is Memory or I/O. It has the same timing as the LA address bus.

**IORC, IOWC, MRDC, MWTC, SMRDC, SMWTC, (ISA signals)** ISA Read and Write strobes.  $\overline{IORC}$  and  $\overline{IOWC}$  are I/O read and write strobes, while  $\overline{MRDC}$  and  $\overline{MWTC}$  are for memory read and writes.  $\overline{SMRDC}$  and  $\overline{SMWTC}$  are asserted only when the address range is in the 00000000 (h) to 000FFFFFF (h) range.

**LOCK (EISA signal)** Bus Lock. This signal is asserted by masters to gain exclusive access to memory or I/O resources.

Lock allows test-and-set operations on semaphores to be run as a unit, without another master gaining access in between.

**BALE (ISA signal)** Bus Address Latch Enable. This signal, which indicates that the LA bus is valid, is used by ISA slaves to latch the address. It's recommended that EISA slaves use START or CMD and not BALE to latch the address.

**MREQx, MAKx (EISA signals)** Master Request and Acknowledge lines for slot x. EISA bus masters use MREQ to request the EISA bus. The system board arbiter acknowledges that the bus was granted using MAK.

**DRQ[7:5][3:0], DAK[7:5][3:0] (ISA signals)** DMA Request and Acknowledge. The DRQ signals are used by DMA devices and ISA masters to request control of the EISA bus. The system board responds that the bus was granted using DAK.

**T-C (ISA signal)** Terminal Count. This signal is used in two modes. As an output, it's asserted by the DMA controller on the system board to indicate end of a DMA transfer count. As an input, it's used by the DMA device to terminate the DMA cycle.

**MASTER16 (ISA signal)** Master Size. This signal is asserted by EISA or ISA masters.

**REFRESH (ISA signal)** Refresh. This signal indicates that a refresh cycle is in progress.

**OSC (ISA signal)** Oscillator. A 14.31818-MHz clock for timing applications.

**RESDRV (ISA signal)** Hardware Reset. This signal resets all boards on the bus.

**IRQ[15:14][12:9][7:3] (ISA signal)** Interrupt Request lines. These lines can be used to interrupt the system CPU.

**I0CHK (ISA signal)** I/O Check. This signal is asserted by an EISA or ISA board to indicate a serious error.



# UNDERSTANDING EISA BUS CYCLES

between the two lower data byte lanes, if necessary. For example, if the 16-bit ISA master writes one byte to an 8-bit ISA slave at an odd address (SA0 = 1), then the system board will copy data from D[15:8] to D[7:0].

However, if  $\overline{EX32}$  or  $\overline{EX16}$  is active, the master is addressing an EISA slave and the system board translates the ISA command strobe into EISA signals,  $\overline{START}$  and  $\overline{CMD}$  (Fig. 3). The system board also drives MIO and WR to the appropriate value depending on which ISA command is active. While the translation is being done, the system board puts the ISA master on hold by pulling the Channel Ready (CHRDY) low. After the EISA cycle is done, CHRDY is released and the master terminates its cycle.

Intel's 82350 EISA chip set makes it easy to design a system board that performs the aforementioned cycle

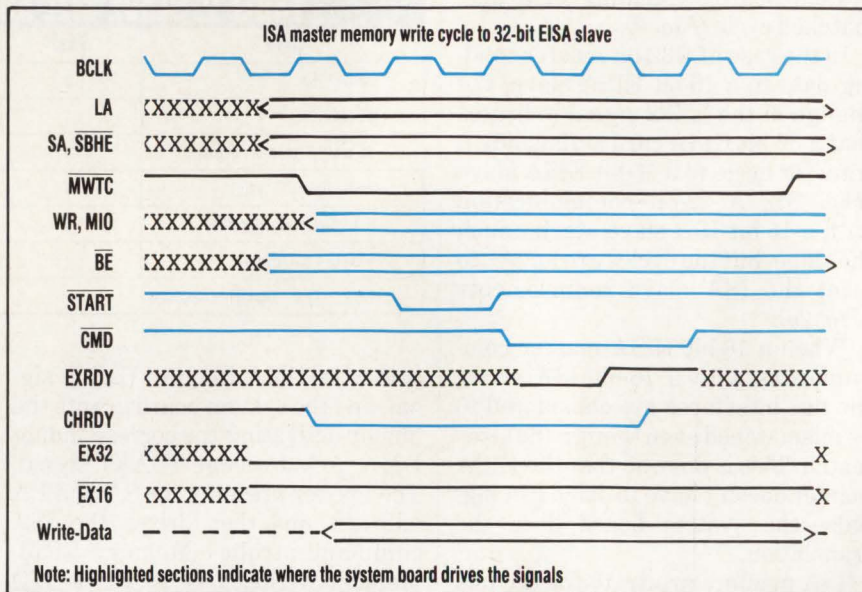

Note: Highlighted sections indicate where the system board drives the signals

**3. DURING THE TRANSFER OF DATA** from a 16-bit ISA memory master card to a 32-bit EISA slave card, the system board pulls the CHRDY line low to put the ISA master on hold until the cycle translation is finished. When the line is released, the master terminates the transfer cycle.

## MORE IN THE SERIES OF DESIGN ADVANTAGES



THE SHORTEST CONNECTION BETWEEN IDEA AND SILICON!

### Design Advantage #2

#### DESIGN VERIFICATION

Functional Design Verifier provides a waveform simulator that allows you to interactively confirm the behavior of the design *before* deciding on device or technology to be used.

### Design Advantage #9

#### VHDL SYNTHESIS

Our optional VHDL Synthesis tool not only allows you to combine your behavioral *and* hardware descriptions, but also gives you *automatic state assignment and state reduction!*

Contact ISDATA 1-800-777-1202 for complete details on these and other design advantages of LOG/iC.

Design tools that take your functional descriptions for optimal implementation into semicustom ASICs from PLDs to Gate Arrays.

**ISDATA**™ 800 AIRPORT RD.  
MONTEREY, CA 93940  
INCORPORATED 408 373-7359

translations. The chip set compresses most of the motherboard logic down to three basic chips—the 82352 bus buffer, the 82357 integrated system peripheral (ISP), and the 82358 EISA bus controller (EBC). A fourth chip, the 82355 bus master interface controller (BMIC), was designed for expansion cards and reduces the design complexity of bus master add-in cards (Fig. 4). The 82352 bus buffer chip could be used as many as three times in a system, buffering the address bus, data bus, and local DRAM storage.

The EBC is the bridge between different masters and slaves. It performs all of the cycle translations required to talk to ISA and EISA boards with different data widths. Furthermore, it can tie into either 80386 or 80486 CPUs and control the address and data bus buffers between the host bus and EISA bus. One special feature of the EBC is its ability to allow host slaves to stretch the bus clock period. As a result, slower host slaves responding to bus master cycles don't have to add full BCLK wait states, but can stall the master for periods in increments of the host CPU clock.

The ISP, like the standard PC chip

# Varta's rapid-charge power packs. Overchargeproof at high currents.

Do you want to open up new markets fast? Then guarantee minimum recharging time for your cordless tools and appliances. That's no problem at all with Varta-RSQ cells with their rated capacities of 600 mAh, 1.2 Ah and even 4 Ah. Fast charging, with conventional temperature cut-off, takes only 30 minutes, respectively 45 minutes for the RSQ 4 power pack. Then it's straight back to work at full capacity – to give your products an extra, powerful sales argument. Also you are able to recharge in only 10 minutes using special charging techniques.

And then there's the high reliability of the Varta-RSQ cells with their enormous overcharge-acceptance.

When it comes to NC technology, Varta is worldwide right at the front of the field. Call up your test batteries today – for fast proof of the Varta fast chargeables.

Varta: The world's largest  
battery only manufacturer.



# VARTA

Varta Batterie AG  
Daimlerstr. 1  
D-7090 Ellwangen (Jagst)  
W. Germany  
Tel.: (07961) 83-1  
Fax: (07961) 83475

Varta Batteries, Inc.  
300 Executive Boulevard  
Elmsford · N.Y. 10523-1202  
USA · Tel.: (914) 5922500  
Fax: (914) 5922667

Varta Batteries Pte. Ltd.  
P.O. Box 55  
Bedok North Post Office  
Singapore 9146  
Tel.: (0065) 2412633  
Fax: (0065) 4445036

CIRCLE 147

# Watt's Up™ from Semiconductor Circuits, Inc.

## New 40 Watt DC/DC Converter Handles Wide Input Ranges in a Small, Low-Profile Case.

The pioneering technology leader in encapsulated power converter modules, Semiconductor Circuits, Inc. introduces the K series for wide-input range applications.

In a case measuring just 3" x 3" x 0.4" high, the K series offers output power up to 40 watts, plus single, dual and triple output configurations. And the K series is available with input ranges of +19 to +35 and -35 to -63 Vdc.

### Key Features

Power	25, 30 or 40 watts
Inputs	+19 to +35 Vdc or -35 to -63 Vdc
Surge Protection	+42 Vdc (max.) or -75 Vdc (max.)
Short Circuit Protection	Continuous — Current limit
Package Size	3.0" x 3.0" x 0.4"
Isolation	500 Vdc
Efficiency	78% (min.)

Added features include parallel operation capability, remote on/off control, 385 KHz switching frequency and input surge protection.

To achieve these breakthroughs, the K series incorporates our extensive MOSFET and surface mount technology.

These technologies also allow us to achieve a high-reliability and power density up to 11.1 Watts/cubic inch.

With an input/output isolation of 500 Vdc, an operating temperature range of -25°C to +85°C, efficiencies of 78% (min.), and continuous short circuit protection, the K series is ideal for board-level power conversion applications with widely varying inputs. Including telecommunications, process control, medical systems and instrumentation.

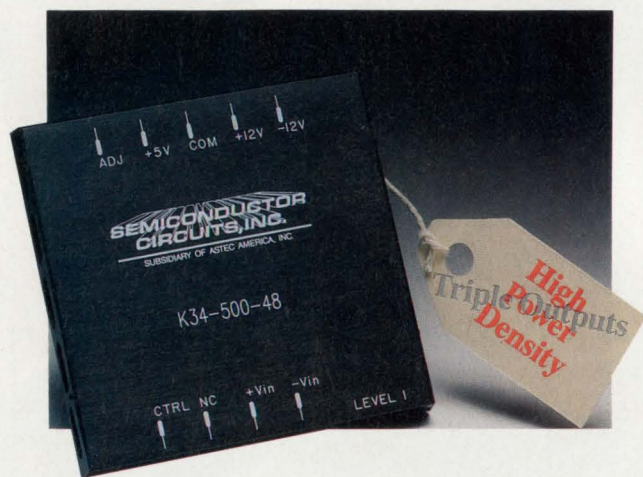

For more information on how to put the K series to work for you, please contact your nearest Semiconductor Circuits, Inc. distributor or representative. Or contact us directly in New Hampshire, telephone: (603) 893-2330 or FAX: (603) 893-6280. And be sure to ask for the latest edition of our Quick Selection Guide to Power Converters.



**SEMICONDUCTOR  
CIRCUITS, INC.**

SUBSIDIARY OF ASTEC AMERICA, INC.



49 Range Road • Windham, New Hampshire 03087 • (603) 893-2330 FAX: (603) 893-6280

CIRCLE 108

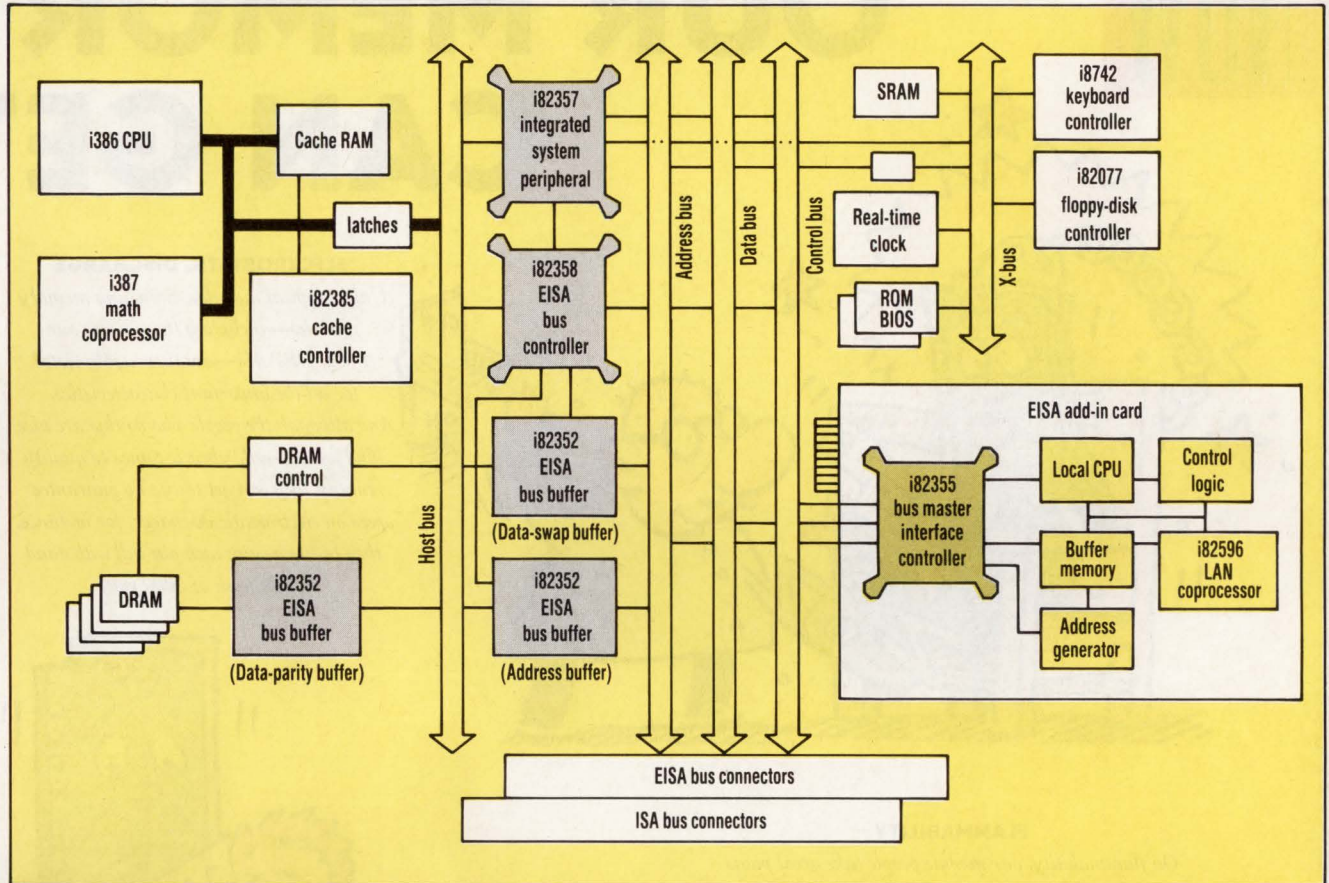

**4. A TYPICAL EISA-BASED SYSTEM** implemented with Intel's 82350 motherboard chip set enables either EISA- or ISA-compatible cards to plug into the expansion bus. Bus-master EISA cards, such as a smart LAN card, might typically use the 82355 bus-master interface controller.

sets, integrates the commonly required system resources. Those resources include seven 32-bit DMA

channels, two 8-channel interrupt controllers, five 16-bit timer/counters, and refresh control and ar-

bitration logic. The buffer chip includes bus buffers for a 32-bit path of the EISA bus. Lastly, the BMIC chip simplifies the design of bus-master expansion cards and has automatic downshifting to enable direct, burst transfers to occur with both 32-bit and 16-bit EISA slave cards. □

*Amaresh Kumar, the design project manager for Intel's EISA bus control products has been with the company for five years. He received a BSEE from the Indian Institute of Technology, Kanpur, India, in 1983 and an MSEE from Syracuse University in New York in 1985.*

**TABLE 3: ROLE OF THE SYSTEM BOARD BUS CONTROLLER**

Master type	Cycle type	Slave type			
		32-bit EISA	16-bit EISA	16-bit ISA	8-bit ISA
32-bit EISA (no downshift capability)	non-burst	—	BO, MC, DC	BO, MC, DC, CT	BO, MC, DC, CT
	burst	—	X	X	X
32-bit EISA (downshift capable)	non-burst	—	BO, MC, DC	BO, MC, DC, CT	BO, MC, DC, CT
	burst	—	—	X	X
16-bit EISA	non-burst	DC	—	BO, CT	BO, MC, DC, CT
	burst	DC	—	X	X
16-bit ISA	non-burst	DC, CT	CT	—	DC

BO = Master Backs Off, letting the bus controller complete the cycle  
 MC = The system board may have to run Multiple Cycles  
 DC = The system board may have to do Data Copying between byte lanes  
 CT = The system board performs Cycle Translations from EISA signals to ISA signals or vice versa  
 X = Cycle isn't possible

Note: 1) For compatibility, the system board doesn't translate a 16-bit cycle from an ISA master to two 8-bit cycles for an 8-bit ISA slave. The master takes care of this itself. The system board only does the necessary data copying.  
 2) ISA devices don't support burst cycles.

HOW VALUABLE?	CIRCLE
HIGHLY	547
MODERATELY	548
SLIGHTLY	549

# OUR MEMORY CAN GET

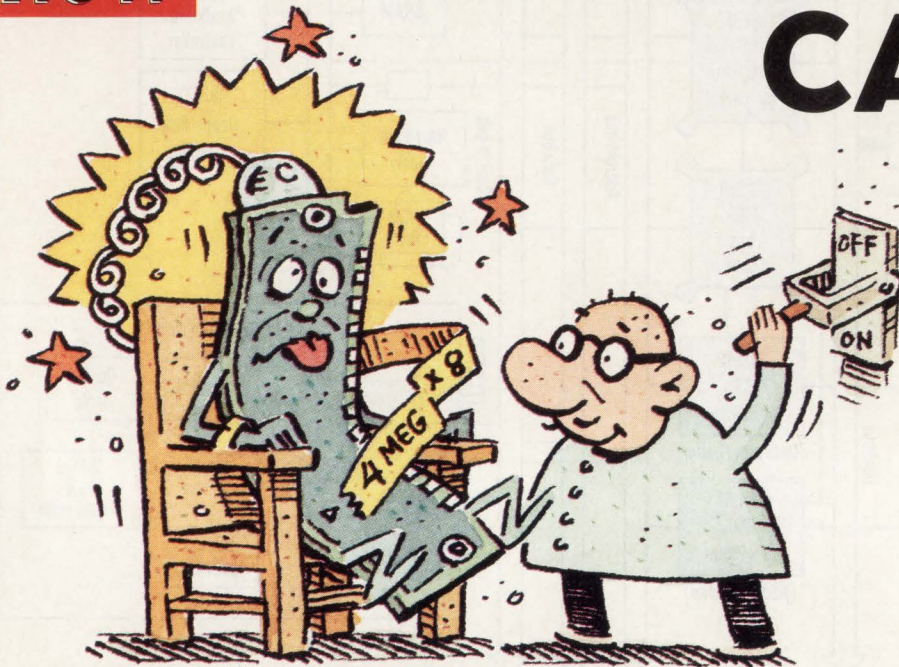

## ELECTROSTATIC DISCHARGE

Unlike typical modules, Samsung memory modules—including those using our 4-meg DRAMs—are thoroughly tested for all the important characteristics. And although the people who do this are nice, kind folks—well, when it comes to quality control they can get testy. To guarantee specs on electrostatic discharge, for instance, they test to assure each pin will withstand a minimum of 2000 volts.

## FLAMMABILITY

On flammability, our module people take great pains to assure that our products meet standards. As a result, we guarantee that every Samsung memory module meets or exceeds the 94V-0 Underwriters Laboratory flame classification.

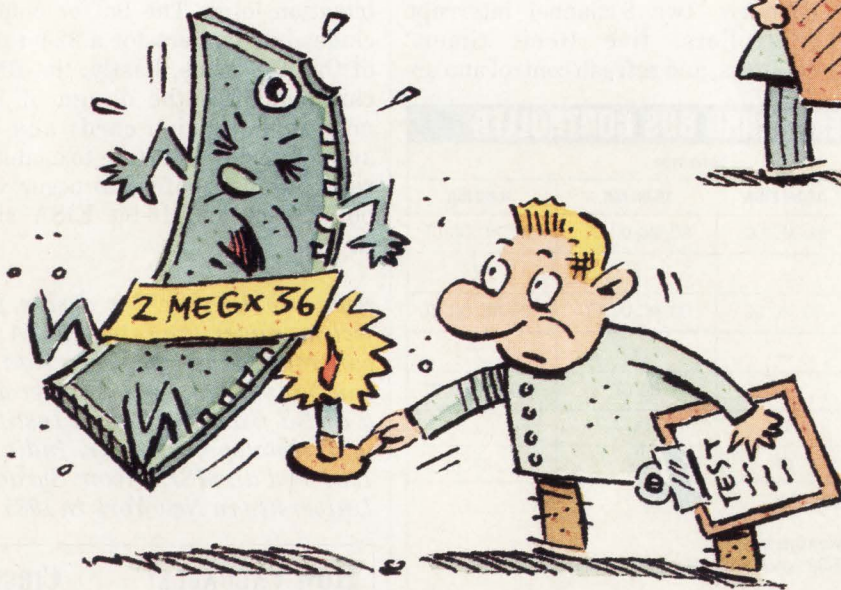

## LEAKAGE

Even in the era of the 4-meg DRAM, there's still such a thing as a module with leaky pins. Many manufacturers just don't inspect for leakage. You guessed it, our team does comprehensive tests. All pins on all modules are 100% tested to the data sheet leakage specification.

# MODULE PEOPLE A BIT TESTY.

## POWER CONSUMPTION

*In this day and age there are enough power-hungry things without your memory modules getting that way. You want them to consume what they say they will. Ours are thoroughly tested not to exceed the spec.*



## DIMENSIONAL CONTROL

*A too-big or too-small module isn't good for much. Samsung modules are tested to perfectly match JEDEC standard dimensions, including  $50 \pm 3$  mil thickness. Since they are, and are also tested on all the other features detailed here, we can't see why you'd ever buy from anyone else. For information on modules with our 4-meg DRAMs, or the rest of our line, write to the testy people at Memory Module Marketing, Samsung Semiconductor, 3725 North First Street, San Jose, CA 95134. Or call 1-800-669-5400, or 408-954 7229.*



**SAMSUNG**  
Semiconductor

CIRCLE 171

# You Can Only Go to a

## Oki's New 0.8 $\mu$ m ASICs

**I**f your ASIC vendor's 1.0 $\mu$ m product is at the end of its shrink, your anxieties are justified. When they'll get to the higher speeds and densities you need for next-generation products is a good question.

Oki's there now. Our new family of *true* 0.8 $\mu$ m drawn sea-of-gates offers the migration path you need to 0.6 $\mu$ m, 0.5 $\mu$ m, and beyond. With 200 ps to 400 ps gate delays and 500 MHz flip-flops, these new CMOS 5-Volt SOGs provide the high-speed performance your systems require now — and in the future. Manufactured on a proven, high-volume production line, they also provide the guaranteed quality and reliability your systems demand.

Choose from a range of products — 4K to 92K usable

gates — and JEDEC metric packages, including QFP and PGA. Our automatic test vector generation (ATVG) capability using scan macros allows you to achieve greater than 95% fault coverage. And it's easy to design with Oki ASICs. We support many popular industry-standard platforms and offer industry-standard in-house tools such as Verilog<sup>®</sup> and Explorer Rene.<sup>™</sup>

Start easing your ASIC anxieties today. Call 1-800-654-6994 and schedule a consultation. We'll analyze your ASIC needs and provide the complete design support you need for today's high-density systems — and for those even higher performance systems you've thought about, but couldn't design. Now you can — with Oki.



*Transforming technology into customer solutions*



# Shrink for So Long

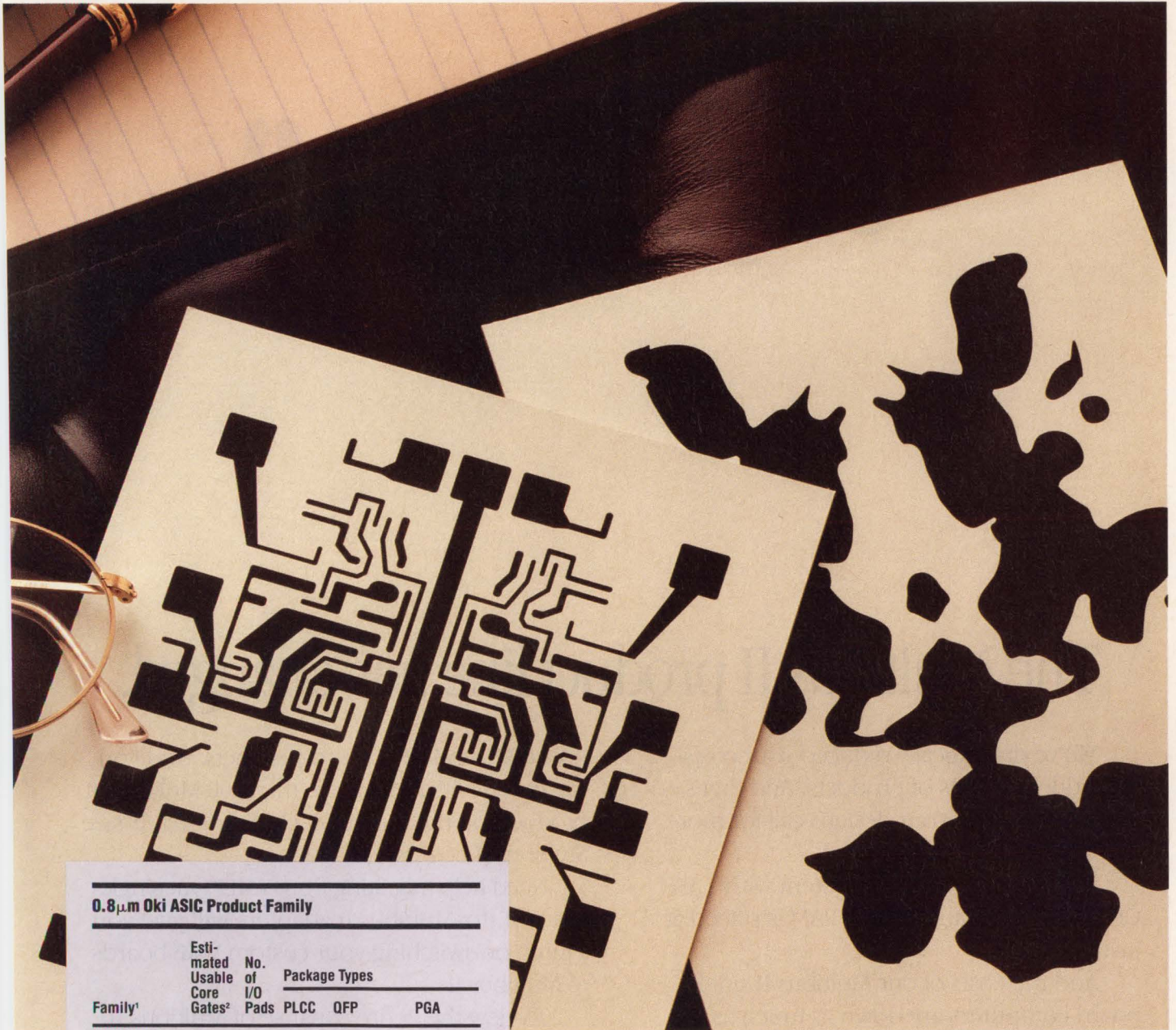

## 0.8 $\mu$ m Oki ASIC Product Family

Family <sup>1</sup>	Esti- mated Usable Core Gates <sup>2</sup>	No. of I/O Pads	Package Types		
			PLCC	QFP	PGA
MSM10S01XX	4K	100	68, 84	60 to 100	88 to 108
MSM10S03XX	12K	160	68, 84	80 to 144	88 to 132
MSM10S05XX	22K	208		120 to 208	108 to 208
MSM10S09XX	36K	272		144 to 272*	108 to 256
MSM10S11XX	47K	304		144 to 304*	132 to 301
MSM10S18XX	72K	384		144 to 304*	208 to 340
MSM10S23XX	92K	424		144 to 304*	240 to 340

<sup>1</sup>Other products are under development

<sup>2</sup>Up to 100% utilization increase with 3-layer metal, memory, and other regular blocks

\*JEDEC metric packages



**OKI**  
Semiconductor

785 North Mary Avenue  
Sunnyvale, CA 94086-2909  
Telephone 1-800-654-6994

Verilog is a registered trademark of Cadence Design Systems, Inc.  
Explorer Rene is a trademark of Mentor Graphics Corporation.

“~~expensive~~”

## The Multibus II product line has changed.

We've dramatically reduced your costs and added dozens of products. And that's great news when your designs call for more than a PC.

Today, our Multibus II system with a 386™ CPU, disk, tape, and 4MB of RAM is priced at just \$9,995.

And the costs of our Multibus II single board computers are down as much as 47%.

Now you can build the Multibus II discipline right into your system for the price of VME or EISA. Multibus II's new MPI bus interface chip is perfect for building simple analog, digital, or serial interface boards. It costs just \$40 in quantities over 100.

The Multibus II product line has expanded, too. In the last year alone, we've added over a

dozen I/O and CPU board products. And you can choose from the more than 500 Multibus II products on the market, including 150 full-size Multibus II boards.

Need help migrating from VME? Our single-slot VME-to-Multibus II adapters will give you a jump on switching your custom VME boards to Multibus II.

To view the entire expanse of Multibus II products — from over 100 vendors — call Intel at (800) 548-4725, Dept. AA60. Ask for a free copy of the *1990 Multibus II Product Directory*.

So don't delay. Call now, and start a change for the better.

**intel**®

# QUICKLOOK

## 1-MINUTE OPINIONS

*What do you think about the education that young engineers are getting these days? How strong a role should humanities courses play?*

**M**y opinion is that our engineers forgot the basics. The humanities courses represent in my opinion a very important subject in the social development of young engineers, based on the fact that we do not want to have robots. We want to have engineers with elastic minds, able to understand all aspects of life and production. In that way, they are able to develop systems and products that are more cost effective.

Yes, education is only a starting point. On-the-job training is the adhesive between theory and practical application. Therefore, I consider it necessary for new graduates to work directly in production for one or two years after college—not in the office—directly on the production line. In this way, when they get a job with responsibilities, they have production experience and are able to design products that are profit-oriented. **Ed Anghel, Amityville, N. Y.**

**A**re you aware of the technocratic, mercenary microchips that are coming from this country's engineering schools? A college education used to mean that the degree holder had at least a rudimentary idea of who he was, where he came from, and some fundamentals in living that come from those "excess" humanities classes.

When we decry the demise of ethics, empathy, and honesty in this country, let's first look at what we teach our students. Let's put the post-Sputnik paranoia to bed and help our students be good people first and good engineers second. If that takes five years, so be it. **Name withheld.**

**F**rom the starting gate, it is my feeling that many come out of school not ready—and in more ways than one. For many graduates, the fact that it is their first working experience doesn't help

much. Those initial steps are often most critical, for they indeed place individuals on tracks that they perhaps have a vague notion of. I have seen this utterly destroy the potential of many. Coupled with often inadequate interpersonal skills and the bottom-line driven nature of American business as a whole, and you wonder why anyone would pursue such a career.

For engineering to receive the respect it deserves, help must come from all quarters. The educational system might consider a revised degree system, differentiating various skill levels to a far greater granularity than currently exists. Industry can assist by recognizing this and by giving the various engineering titles only to those who are indeed engineers by training. There is a huge difference, but this often is ignored, and engineers get lumped in with all kinds of people who often do not even come close to them in terms of the rigorous education they have gone through.

Engineers themselves could use a dose of common sense as well. The attitude that being organized is beneath them has got to stop—it doesn't bother medical doctors one bit to be a part of the AMA. Engineers should recognize that being organized does not mean old style unions but does mean achieving the clout they deserve in the professional climate in which they should exist. It will only be under circumstances such as these that engineers achieve the stature they deserve and the recognition that they are often the backbone of many businesses. **John A. Nevin, Middle Village, N. Y.**

What's your opinion on the education of today's young engineers? Which areas are being under- or over-emphasized? What role should humanities courses play in engineering education? Are four years enough to give young engineers a good foundation? Send your opinions to our fax (201) 393-0637 or to CompuServe address 75410,3624. Or mail your responses to *Electronic Design*, Reader Opinions, 611 Route 46 W., Hasbrouck Heights, NJ 07604.

### How Can EMI Be Improved?

Cause	Action	Effect
1. High Speed Circuit Blocks.	Remove Divide-by-2 Portion of Oscillator	Reduces Crystal Frequency Noise
2. Output Buffer Slew Rates	Increase Gate Capacitance of Output Buffers	Slower Output Switching Edges
3. Large Current Pulses at Output	Increase on Resistance of Output Drivers	Limits Size of Output Current Pulses
4. Simultaneous Switching of Many Outputs	Stagger Output Switching	Limits Number of Outputs Switching Simultaneously
5. Long Ground/Vcc Paths	Reduce Path Lengths; Add Vec and Gnd Pins	Reduces Radiation From Long Paths

Companies visit *Electronic Design* to show us their latest technologies. Slides and charts make up a big part of these presentations. Since many have information designers can use, we'll present the best of the ones we've seen in Quick Look. Here are some tips on improving emi that come from Michael Hulme, director of data communication products at Zilog Inc., Campbell, Calif.

The V.42bis Modem Chip Set

# International negotiator.

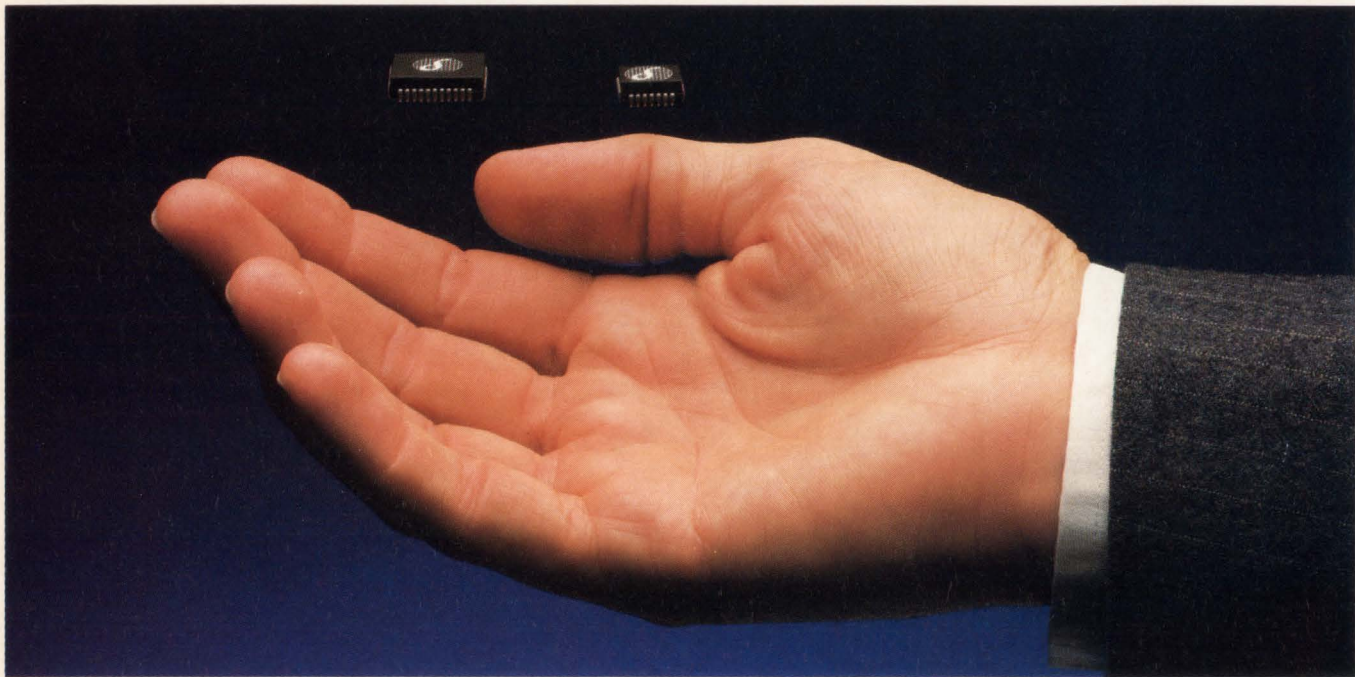

Getting your modem product accepted in the global marketplace just got a lot easier.

Our V.42bis Modem Chip Set cuts through considerable international protocol because it's compatible with error control and correction standards: V.42, MNP-5, and now, V.42bis. Automatically it senses receiving modem capabilities and "negotiates" the best possible connection.

This high-performing chip set

gives you data compression with an effective throughput improvement of 4:1. It saves you the time of having to customize your own software, and the extra cost associated with other multiple chip or discrete component designs.

The V.42bis Modem Chip Set. World-class capabilities now packaged and priced like a standard. To open negotiations, contact your nearest Silicon Systems representative or

CIRCLE 102 FOR PRODUCT INFO.  
CIRCLE 103 FOR CAREER INFO.

distributor. Or call us for literature package CPD-4.

**Silicon Systems, Inc.**  
14351 Myford Road, Tustin, CA 92680  
Ph 1-800-624-8999, ext. 151 Fax (714) 669-8814  
European Hdq. U.K. Ph (44) 79-881-2331  
Fax (44) 79-881-2117

*silicon systems*<sup>®</sup>

# WHAT'S ALL THIS NOISE STUFF, ANYHOW? (PART II)

To circumvent the noise-testing problems discussed in my last column, I decided to build up my own test fixture for measuring transistor base-current noise. First I made up a schematic (see the figure). As a sanity check, I showed it to a bunch of people. One guy did spot that I was violating the common-mode (CM) range of the LM627 main amplifier. So I told him *thank you* and added a couple of 1N914 diodes to bring the common-mode range down to a legal level (I could have bluffed and told him, I made that mistake on purpose, to see if anybody was paying attention, but I figured that this wasn't the right time to play that game, as it wasn't true....).

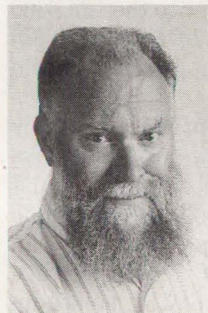

**BOB PEASE** OBTAINED A BSEE FROM MIT IN 1961 AND IS STAFF SCIENTIST AT NATIONAL SEMICONDUCTOR CORP., SANTA CLARA, CALIF.

People asked me, "Aren't you going to run it on batteries? You need low-noise supplies to see a low noise, don't you?" Answer, no. Modern power supplies are pretty quiet, and this balanced (differential) amplifier (Q<sub>1A</sub> and Q<sub>1B</sub>) doesn't need any more help than that. Also, it has a pretty good power-supply rejection ratio (PSRR). Then they said, "Aren't you going to put the fixture in a big sealed box?" No, that's not necessary. In fact, usually I just run it out in the open, without even a cover, right on my bench.

Usually, I do have to turn off the soldering iron to get decent results. I also have to move it away from vari-

ous instruments whose power supplies spray flux all around.

The first thing I did with this fixture was add a label that said you have to monitor the dc output level. That's to ensure that if the output pegs (hits the supply rail), you don't want to believe the output noise levels. The next disclaimer I added stated that the bandwidth is indeterminate and depends on the layout—even a fraction of a picofarad of stray capacitance has major effects.

We fired it up and it gave us pretty reasonable data. It told us that the transistors' base current noise was down around the theoretical levels, at least above 100 Hz. We've been too busy recently to devote time to getting the spectrum analyzer running down at 10 Hz, but that can wait. Then we checked on the high end of the frequency range. I started out with a feedback capacitor (C<sub>F</sub>) made out of about 2 inches of twisted pair, (around 2 pF) and unwound it.

As the capacitance decreased, the bandwidth got up above 10 kHz, up toward 20 kHz. That means our feedback capacitor is less than 1/3 pF. We worked to get that because we built the feedback resistor out of three 3.32-MΩ resistors, so their in-

TRANSISTOR CURRENT NOISE TESTER (IMPROVED)

- MAKE 10MΩ from 3.32MΩ x 3.
- MAKE 40 MΩ from 10 MΩ x 4.
- MAKE C<sub>F</sub> ≈ 0.2 pF of TEFLON.
- ALL WALLS ARE GROUNDED. WIRE.
- MAKE "SELECTOR SWITCHES" OUT OF MINI-GATOR CLIPS.
- SELECT R (+INPUT) = R<sub>1</sub> OR R<sub>2</sub> OR R<sub>3</sub>.
- SELECT R<sub>F</sub> = R<sub>3</sub> OR (R<sub>3</sub>+R<sub>4</sub>) OR R<sub>4</sub>.
- ALWAYS MONITOR V<sub>OUT</sub> (DC) to make sure output isn't pegged!!
- V<sub>OUT</sub> = (I<sub>INDC</sub> + I<sub>INNOISE</sub>) × (R<sub>1</sub> OR R<sub>2</sub> OR R<sub>3</sub>) PLUS (I<sub>INDC</sub> + I<sub>INNOISE</sub>) × (R<sub>3</sub> OR R<sub>4</sub>) PLUS V<sub>OS</sub> X 1, PLUS NOISE OF 20MΩ (negligible...)
- OPTIONAL, PUT THE WHOLE THING IN A BIG METAL BOX, KEEP FAR FROM ALL TRANSFORMERS.

# Make Tracks...

... to your nearest mailbox and send for the latest copy of the free Consumer Information Catalog.

It lists about 200 free or low-cost government publications on topics like health, nutrition, careers, money management, and federal benefits.

Take a step in the right direction and write today for the free Consumer Information Catalog. Just send your name and address to:

**Consumer Information Center  
Department MT  
Pueblo, Colorado 81009**



A public service of this publication and the Consumer Information Center of the U.S. General Services Administration.

## PEASE PORRIDGE

herent capacitances would be put in series and thus decreased. Also, we built "walls" out of copper-clad pc board to prevent any stray capacitance between the output and the input. Heck, the output can't even *SEE* the input. To connect a 0.5-pF capacitor from the output to the input, we require it to climb over one of those walls.

We haven't used the 50-M $\Omega$  feedback resistor yet (which is made out of five 10-M $\Omega$  resistors in series), but that approach will give us good resolution when the transistors run a mere 4 to 12  $\mu$ A of emitter current. Note, this circuit is just about the same as we would use to measure the base-current (bias current) noise of any op amp. But when you do that, the stray capacitance of the socket makes it pretty hard to get less than 0.5 pF from the output to the input, especially when you're using dual or quad amplifiers.

With an op amp, you may even have to run your test with one of the pins pulled out of the socket, for evaluation. For production, you make a pc-board layout with guarding between the pins. Refer to the LMC660 data sheet (printed after June 1990) for information on guarding techniques.

Therefore, we confirmed that it is possible to make low-noise measurements. If you're careful, you can just build up a simple circuit with a simple amount of shielding. And you can check at all times to see if there are 60 Hz or 120 Hz or 5 MHz noises intruding into your circuit.

One thing is certain, blind trust is definitely out of place here; thinking is required at all times. We also confirmed that the transistors really *were* low-noise. In fact, they were close to the noise floor, with fewer noisy ones than usual. So, that's encouraging.

All for now. / Comments invited! /  
RAP / Robert A. Pease / Engineer

**ADDRESS:**  
Mail Stop C2500A  
National Semiconductor  
P.O. Box 58090  
Santa Clara, CA 95052-8090



# We'll match our World-Class Line against anybody's

For designers of world-class products, Heinemann offers world-class circuit protection. Listings and approvals for our circuit breakers include UL, CSA, VDE, TUV, IEC and SEV. With our sister companies in Canada, Europe and Australia, we stay in constant touch with the requirements of such agencies world wide.

Choose ratings from 0.01A to 700A. Choose from magnetic and thermal breakers, compacts, snap-action, MIL-spec, single- or multi-pole, fast



CIRCLE 95

or delayed trip and the widest selection of multi-function internal constructions available anywhere.

For more information on the wide world of Heinemann circuit breakers, ask for a copy of our "Quick Guide to Overcurrent Protection." Write or call Heinemann Electric Company, P.O. Box 6800, Lawrenceville, NJ 08648-0800 • Tel: (609) 882-4800 • FAX: (609) 882-2183.

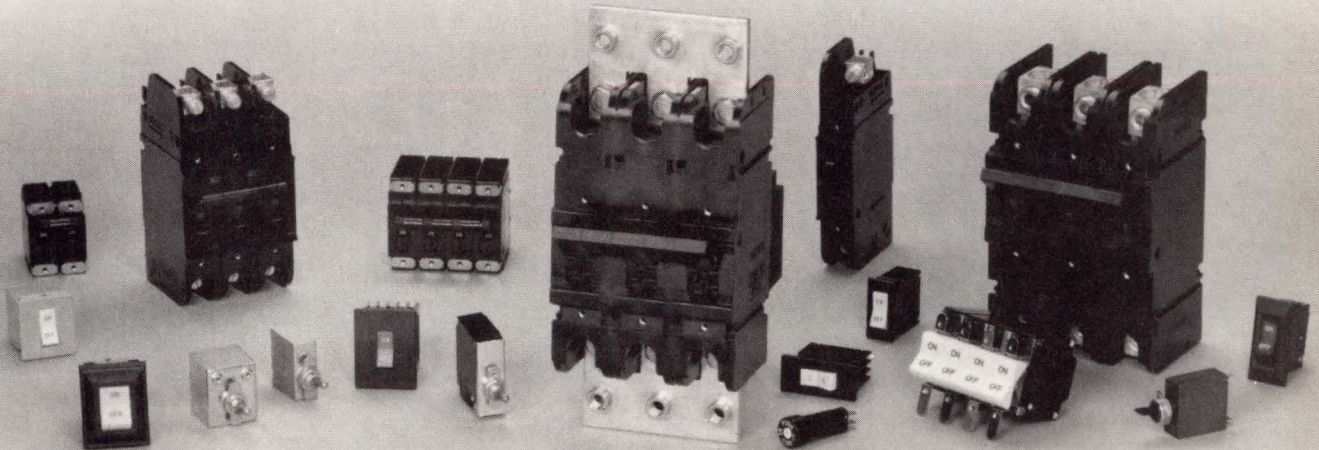

# How to stay ahead

Start with our high-performance standard products. Then add unique functional or performance capabilities with our semi-standard options. To get the ICs you want. And the competitive advantage you need. Quickly. Easily. With minimal risk.

*Want power factor correction?*

Don't just meet the standard. Beat the standard. With single-chip standard products that offer power factor correction of .99, in either boost or flyback (buck-boost) configurations. They're the first ICs designed to reduce harmonic currents to help you meet both existing and proposed regulations for switch mode power supplies. And help you reduce

your customer's power distribution problems.

*Or how about our complete family of high-frequency PWM controllers.*

They offer you a wide range of high-frequency, high-performance single chip solutions for state-of-the-art switching

power supplies with operating frequencies up to 1 MHz. With advanced

features like improved fault protection.

Added synchronization

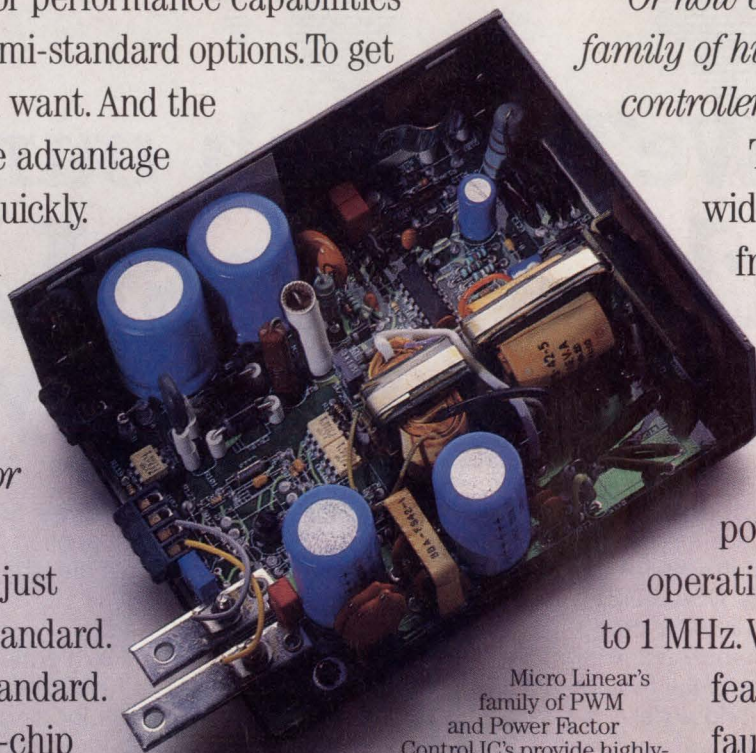

Micro Linear's family of PWM and Power Factor Control IC's provide highly-integrated solutions for a broad range of switching power supplies.

Product Category	Features
Power Factor Control	High Efficiency Flyback or Boost
PWM Controllers	1 MHz, Additional Fault Protection, Synchronization
Resonant Control	ZVS and ZCS to 3 MHz
Motor Control	BLDC Sensorless Commutation



# of the power curve.

capability. Even stability improvements.

*Looking for new techniques in motion control?*

Now you have some unique design options. With our new ML4410 sensorless motor controller, the first controller designed to automatically commutate brushless DC motors without the need for Hall-effect sensors. So you can eliminate the inherent alignment, torque ripple and flutter problems previously encountered with Hall-effect commutation. And design smaller, lower cost, higher reliability motors for any continuous speed application.

### **Semi-standard options.**

Since these standard products are based on our FB3480, FB3490 and FB3631 tile arrays, they can all be easily

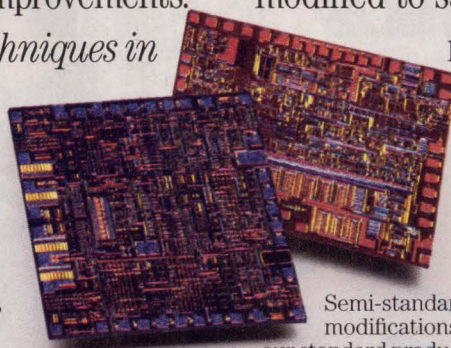

Semi-standard modifications of our standard products offer you better application fit, with lower risk.

**And we're not stopping there.**

We'll soon be introducing a new line of resonant controllers for ZVS and ZCS applications and a new soft-switching, phase modulation controller that will enable you to design smaller, more efficient power supplies.

### **Want some straight answers?**

Just call Jon Klein today at (408) 433-5200 and ask him about our complete line of power control products. And about our semi-standard capabilities. He'll show that the best way to stay ahead of the power curve is to take a straight line.

Straight to Micro Linear.

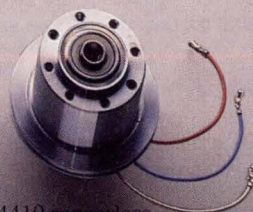

The ML4410 sensorless motor controller can control any wye or delta wound 3-phase brushless DC motor.

 **Micro Linear**

# SURFACE MOUNT MIXERS



**\$3.30**  
(1,000 qty)

**ULTRA-REL™**  
**MIXERS**  
5-YR. GUARANTEE

The opportunity for automated, low-cost assembly is a key benefit of surface-mount technology, but is often wiped out by the high price of surface-mount components. Now, Mini-Circuits offers a new series of mixers to meet the pricing demands of SMT... only \$3.30 in 1,000 quantity (\$3.95 ea. in quantity of 10)... at a cost even lower than most conventionally-packaged mixers.

The SCM-1 spans 1 to 500MHz and the SCM-2 covers 10 to 1,000MHz. Housed in a rugged, non-hermetic 0.4 by 0.8 by 0.3 in. high (maximum dimensions) plastic/ceramic package. Spacing between connections is 0.2 in. The mixer is offered with leads (SCM-L) or without leads (SCM-NL) to meet a wide range of pc board mounting configurations.

Each SCM is built to meet severe environmental stresses including mechanical shock/vibration as well as temperature shock. The operating and temperature storage range is -55°C to +100°C. Each SCM, designed and built to meet today's demanding reliability requirements, carries Mini-Circuits' exclusive 0.1% AQL guarantee of no rejects on every order shipped (up to 1,000 pieces).

When you think SMT for low-cost production, think of Mini-Circuits' low-cost SCM mixers.

SPECIFICATIONS	SCM-1L SCM-1NL (L=with leads) (NL=no leads)	SCM-2L SCM-2NL (L=with leads) (NL=no leads)
FREQ. RANGE (MHz)		
LO,RF	1-500	10-1000
-IF	DC-500	DC-500
CONVERSION LOSS (dB)		
Midband	6.3 dB	6.5 dB
Total Range	7.5 dB	8.0 dB
ISOLATION (dB)	(L-R)(L-I)	(L-R)(L-I)
Low-Band	60 45	45 35
Mid-Band	45 40	35 30
High-Band	40 35	25 20
PRICE	\$3.30 (1000 qty) \$4.25 (1-9)	\$4.15 (1000 qty) \$5.45 (1-9)

Units are shipped in anti-static plastic "tubes" or "sticks" for automatic insertion.

\*NOTE: L & NL suffix for ordering only  
Not marked on units.

**Mini-Circuits**

A Division of Scientific Components Corporation  
P.O. Box 350166, Brooklyn, New York 11235-0003 (718) 934-4500  
Fax (718) 332-4661 Domestic and International Telexes: 6852844 or 620156

# CIRCLE 521 CONNECT ADC TO PC'S I/O PORT

LIN JUN

University of Leicester, Dept. of Engineering, Leicester LE1 7RH, U.K.

A standard IBM PC isn't equipped with any obvious unallocated general-purpose I/O ports. Therefore, to connect an analog-to-digital converter (ADC) to a PC, a plug in a-d card must be placed in one of the

PC's expansion slots. However, it would be more convenient to connect the ADC to the PC without opening the machine, and imperative if either all of the slots are filled or it contains no slots.

Most PCs—from 8088-based lap-

tops to the latest 80386-based machines—are equipped with a parallel printer port, supplying a standard hardware interface and a place to connect an ADC. An a-d card using this approach requires only two ICs and is based on the PC/XT/AT 25-pin D-type socket (Fig. 1). The 12-pin a-d converter (AD7572, MAX162, or MAX172) is controlled by the PC's data-output port 378H, and the 12-bit conversion result is read through port 379H's status input lines.

Only five pins of the 25-way connector are connected to port 379H.

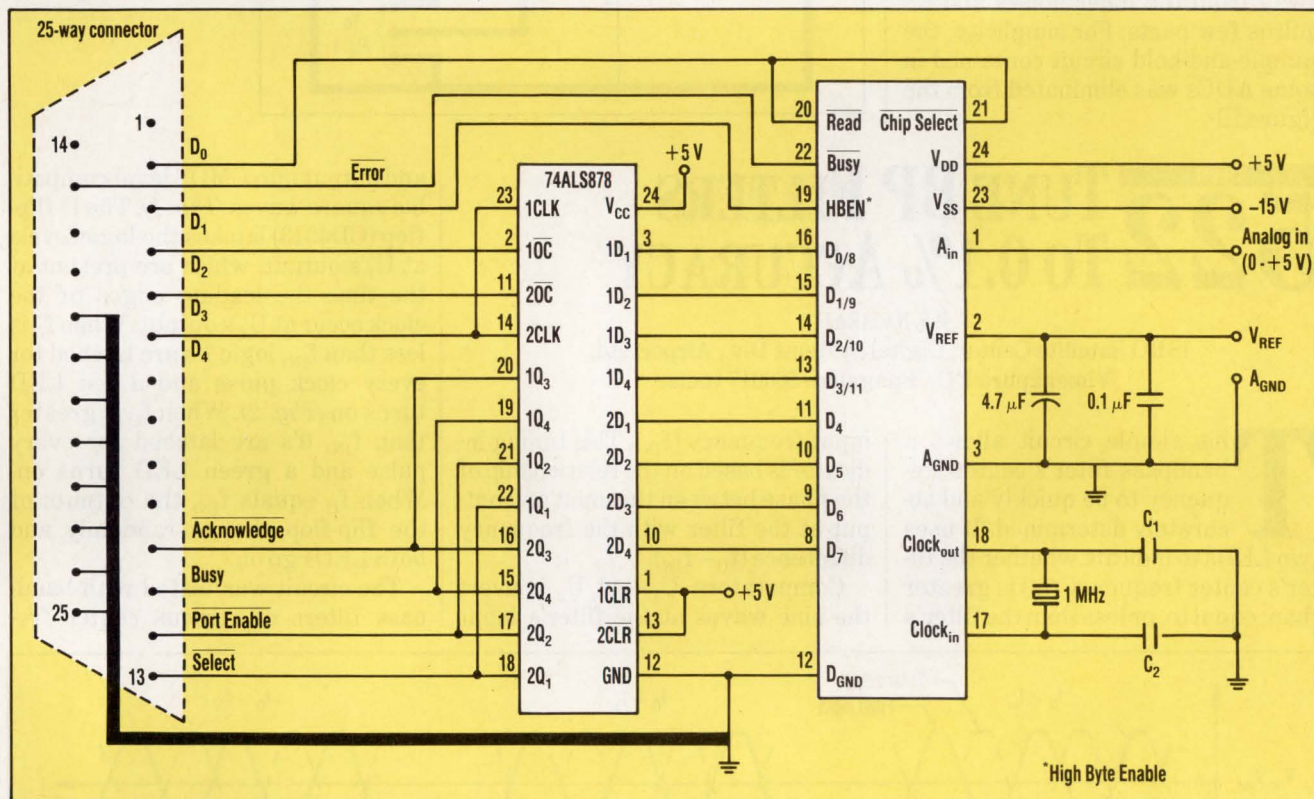

**1. ANALOG INPUT CAN BE SENT INTO A PC** by connecting an ADC and a D flip-flop to the PC's parallel port. The ADC is controlled by the output of the PC's port 378H.

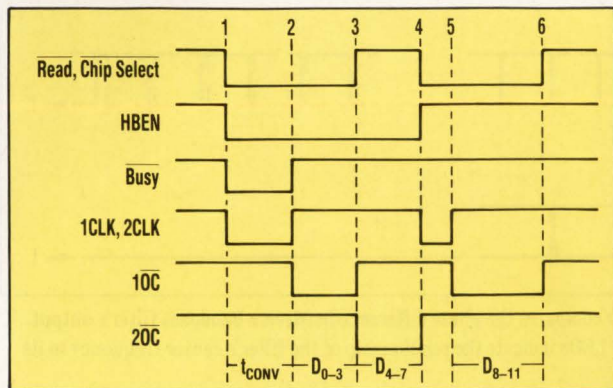

**2. SIGNAL  $d_0$**  from the 25-way connector controls the a-d converter's Read and Chip Select inputs, while  $D_1$  controls the High-Byte Enable.  $D_{2,4}$  are connected to  $10C$ ,  $20C$ , and  $1CLK$  and  $2CLK$ .

Therefore, 12-bit data must be read three times through the port. This can be done by controlling the D-type flip-flop, 74ALS878. All signals except the Busy signal are generated by port 378H's output (Fig. 2).

Connecting the a-d converter to the PC carries some flexibility—certain components can be substituted for others. For example, two 74HCT374's can take the place of the 74ALS878 and the 12-bit ADCs can be replaced by 10- or 8-bit parts. Fur-

thermore, an ADC with more than 12 bits can be connected. The unused bits of port 378H can be employed to control the multiplexer. In addition, eight channels can be easily expanded for this circuit.

If a printer is connected to the port at the same time as the a-d converter, use a 74LS157 to switch the input lines of port 379H (Fig. 3). Here, the select signal is connected to the SLCT IN of port 37AH.

If the speed isn't very high, the described method works better than a plug-in card because it's further away from the inner noises and requires few parts. For simplicity, the sample-and-hold circuit contained in some ADCs was eliminated from the figure. □

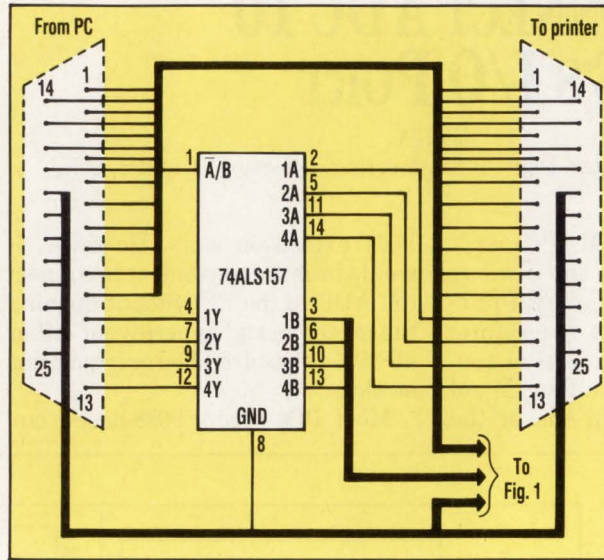

3. A printer can be connected to the port at the same time as the a-d converter. In this case, a 74LS157 is used to switch the input lines of port 379H.

## CIRCLE 522 TUNE BP FILTERS To 0.1% ACCURACY

M.S. NAGARAJ

ISRO Satellite Center, Digital Systems Div., Airport Rd., Vimanapura P.O., Bangalore 560017 India.

This simple circuit allows a bandpass filter's center frequency to be quickly and accurately determined. It uses two LEDs to indicate whether the filter's center frequency ( $f_0$ ) is greater than, equal to, or less than the filter's

input frequency ( $f_{IN}$ ). This tuning indicator is based on the relationship of the phase between the input and output of the filter with the frequency difference ( $f_0 - f_{IN}$ ).

Comparators  $U_1$  and  $U_2$  convert the sine waves at the filter's input

and output into CMOS level-compatible square waves (Fig. 1). The D flip-flop (CD4013) latches the logic levels at  $U_1$ 's output, which are present at the time the leading edges of the clock occur at  $U_2$ 's output. When  $f_0$  is less than  $f_{IN}$ , logic 1's are latched for every clock pulse and a red LED turns on (Fig. 2). When  $f_0$  is greater than  $f_{IN}$ , 0's are latched for every pulse and a green LED turns on. When  $f_0$  equals  $f_{IN}$ , the outputs of the flip-flop change randomly and both LEDs go on.

The circuit was tested with bandpass filters of various center fre-

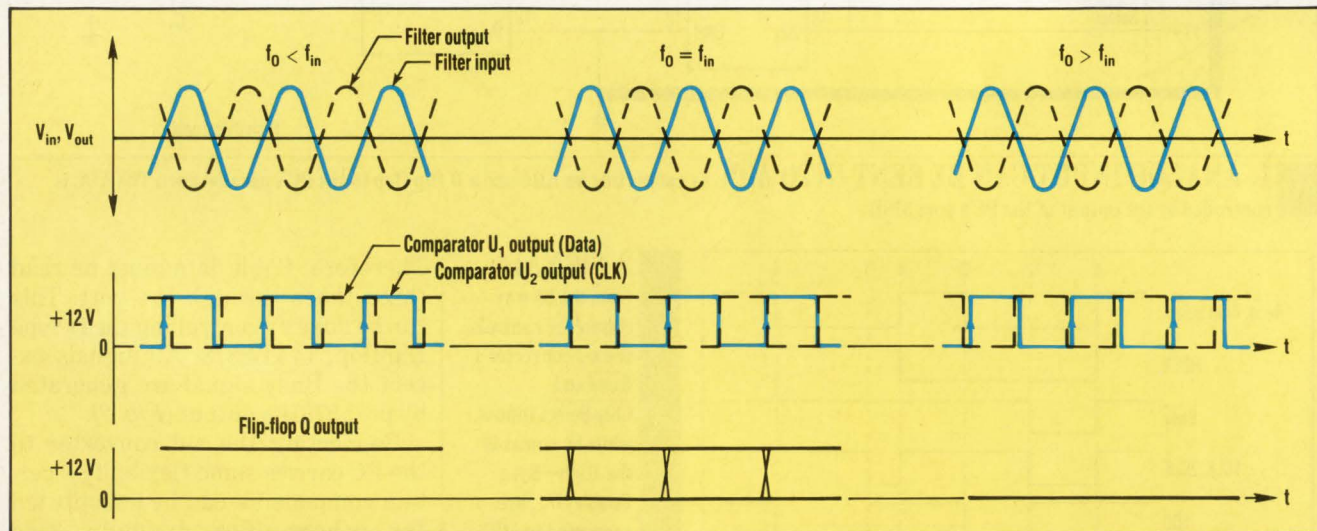

1. BASED ON A CD4013 D FLIP-FLOP, this tuning indicator compares the phase difference between a bandpass filter's output and input. The Q and  $\bar{Q}$  outputs drive red and green LEDs, respectively. The LEDs indicate the relationship of the filter's center frequency to its input frequency.



# NEW PRODUCT REVIEW

Fall, 1990

The more information you have, the better we look . . . Clearpoint.

Vol.1 No. 2

## Five reasons to buy a CPU for your memory-hungry VME-based system with limited memory

Graphics and image processing, MRI imaging, huge number crunching jobs— all typical VMEbus applications and all memory intensive. Designers of VME-based systems need to evaluate performance, features, and cost requirements of the overall system, not just the CPU. Adding minimal memory to the CPU and additional memory to the backplane offers several advantages, including:

### Improved System Performance

High speed processors that include memory are a poor utilization of hardware. Since memory is packed onto the CPU card, any access to memory from the VMEbus ties up the CPU, slowing system performance.

### Lower Cost

Most memory-intensive applications require more memory than is available on a CPU card. Users can cut system costs by buying the CPU and memory individually. Memory can be added as needed, and systems do not suffer because of CPU limitations.

CONTINUED ON PAGE 2

## Guaranteed by a Lifetime Warranty

All Clearpoint's memory products are backed by a fully-transferable, lifetime warranty. Clearpoint offers the most extensive warranty and service program available for VME-based open-architecture memory, including:

- 24-hour toll-free technical support hotline
- Next-day repair or replacement policy

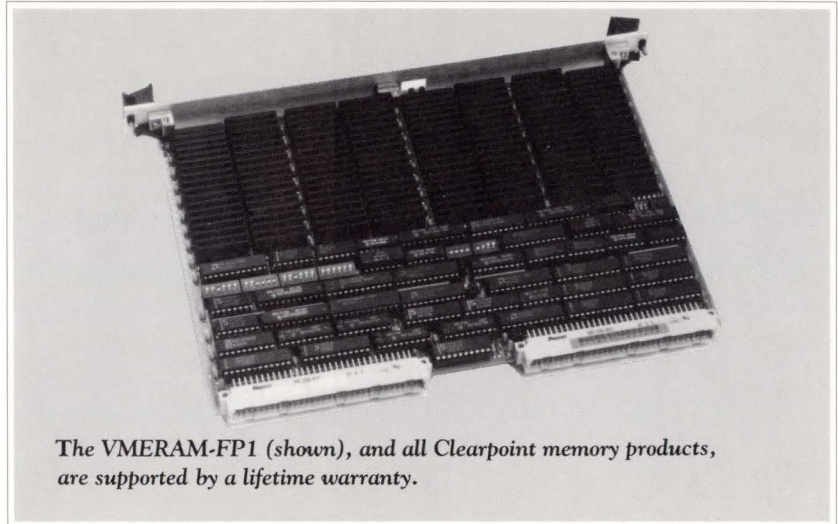

The VMERAM-FP1 (shown), and all Clearpoint memory products, are supported by a lifetime warranty.

## High density, fast VME-compatible memory . . . Guaranteed!

Hardware designer Leo Cierpial on memory design for the VMEbus: "The goal of the VMERAM-FP1 design was to make the fastest memory possible with today's technology. Equally important, we wanted to fully implement the many features and options of the VMEbus specification, and conform to all of its rules under worst-case conditions."

The VMERAM-FP1 is an engineering innovation from Clearpoint Research Corporation. Available in 4 to 64 MB densities, the VMERAM-FP1 boasts block transfer cycles of 100 ns for reads and 74 ns for writes. Increased performance is achieved using fast page-mode access of DRAMs during block-transfer cycles. Fast random access and cycle times are achieved, in part, by decoding the address in parallel with the start of the memory cycle. This technique increases the possible gains in system performance by VME MASTERS using address pipelining.

The 4, 8, 12, and 16 MB boards are designed with 70 ns, 1 megabit DRAMs; 32, 48, and 64 MB boards use 80 ns, 4 megabit DRAMs. When 4 megabit DRAMs become available in 70 ns speeds, our highest density

boards will use the improved technology.

The VMERAM-FP1 supports all VMEbus addressing and data transfer types—block mode (BLT), unaligned (UAT), and address only (ADO). Supporting 32-, 16-, and 8-bit data transfers, the VMERAM-FP1 can be configured for 32- and/or 24-bit addressing.

The VMERAM-FP1 offers byte-wide parity protection; if an error is detected during a read cycle, a VMEbus "BERR\*" may be issued over the bus. Control bits are provided in the control-status register (CSR) to enable or disable reporting of a parity error via the BERR\* signal line of the VMEbus.

The CSR is a Motorola-compatible, 8-bit hardware register, which allows users to control and access parity error status information. It is assigned a user-configurable address in the I/O page and may be accessed by system software. Other features include CAS-before RAS refresh, and battery back-up capability.

VMERAM-FP1 . . . the design engineer's memory choice!

# Speed vs. Specmanship: Data Transfer in the Fast lane

The VMEbus specifications allow system integrators to configure systems using products from various manufacturers. The specifications are said to describe a maximum data transfer rate of 40 MB/second. Some board manufacturers claim that this theoretical maximum is the actual data-transfer speed of their VME product. Unfortunately, it is not easy to judge these claims, either because all the needed product specifications are not made available, or they are not presented clearly. In short, there's a lot of room for "specmanship" when statements are made about the speed of a VMEbus product. A closer look at a real VME system data transfer will clear up some of the smoke surrounding the VME specs.

For the buyer of bus system devices, there are ways to avoid being misled by specmanship and to assure that your system is maximizing its data transfer rate potential.

- Examine every component in the system – All systems have a weak link, but the speed of your system can be seriously limited by an out-of-date device or by one which doesn't match the capabilities of your master devices. Swap out devices to isolate system bottlenecks. By trying various combinations of devices, you can find the optimum combination for your system.

- Get the real numbers – There can be a significant difference between minimum cycle times (the sum of which gives the maximum speed of the system) and actual cycle times. Adding up the timing of every part of the system will give you the speed of a configuration.

- Do software benchmarking – This will give you empirical evidence of system performance under actual operating conditions, and will also provide a standard for comparison.

CONTINUED FROM PAGE 1

## Getting the Right Memory

Memory installed on VME-based processors rarely offers the range of features required for today's applications. Buying memory separately allows you to choose the memory features you need – fast or slow, parity or EDC – without paying a premium for those options you don't require.

## Space Savers

Real estate on VME-based CPU cards is a valuable commodity. Memory installed directly on processor cards often takes space from processing functions which cannot be added elsewhere in a VME system. Buying a CPU with memory can mean sacrificing CPU functionality; adding memory separately leaves space for the functionality you need.

## Avoid the Double Whammy

In multiprocessor systems, memory on the CPU can cause significant loss of overall system performance. When one CPU needs memory information from the other processor, both get tied up performing a single bus cycle. Clearpoint's VMERAM-FP1 offers speed, density, and flexibility to meet your open-architecture needs.

## About Clearpoint

Clearpoint was founded in 1982 on the premise that memory is a unique component of a computer system, requiring a different set of capabilities for production. Since its inception, Clearpoint has focused first and foremost on engineering. Core product offerings include add-in memory for VME, DEC, Sun, HP/Apollo, IBM, Compaq, and Apple Macintosh.

In 1989 Clearpoint expanded this expertise to the storage market with its high performance SCSI-based storage subsystem. Memory or storage – Clearpoint's innovative designs provide compatibility, value, and performance now while laying the foundation to serve you well into the future.

*Our company-wide  
pledge to deliver  
reliability and  
performance*



Quality Commitment

## VME-Compatible EDC Memory

Clearpoint offers several single-bit error correction and double-bit detection memory boards for the VMEbus and the VSB subsystem bus. Our entire VME/VSB product line supports all VMEbus addressing (24- and 32-bit) and data transfer (8-, 16- and 32-bit) types – block mode (BLT), unaligned (UAT), and address only (ADO).

**VMERAM-EC1**—Providing from 2 to 64 MB in a single slot, the VMERAM-EC1 is the unsurpassed open-architecture solution. The enhanced EDC chip set supports Clearpoint's exclusive 'extra bit' technology. If the VMERAM-EC1 detects 16 single-bit errors in a location, the board automatically replaces the bad DRAM with the on-board spare DRAM. Registers in the chip set monitor the error count and re-map the array to include the new location.

**VMERAM**—VMERAM is the low-cost alternative for EDC memory, with pricing comparable to parity memory. The VMERAM features Clearpoint's original proprietary EDC chip set, and stands as the only VME Laboratories-certified memory board available. The VMERAM insures high reliability by correcting and removing bad data from the DRAM and replacing it with the correct data. The VMERAM is available in 2 to 16 MB densities.

**VSBRAM-EC1**—The VSBRAM-EC1, available in densities of 2 to 64 MB, offers true dual-porting and data transfers between the VMEbus and VSB subsystem bus. 64-bit data caches make simultaneous transfers a reality. Designed with the enhanced EDC chip set, VSBRAM-EC1 also features automatic bad-bit replacement. (See the description of VMERAM-EC1 for details.) VMERAM-EC1 is compatible with VSB subsystem bus specification Rev. C, and VMEbus specification Rev. C.1.

**VERSARAM**—The VERSARAM shows Clearpoint's commitment to advanced technology for the VERSA-bus. Available in 1 to 16 MB densities, the VERSARAM includes special-order "ruggedized" boards.

Clearpoint is a registered trademark of Clearpoint Research Corporation.  
© Copyright 1990 Clearpoint Research Corporation. Printed in USA.

Clearpoint Research Corporation • 35 Parkwood Drive • Hopkinton, MA 01748

(508) 435-2000 • (800) 253-2778 • FAX: (508) 435-7530

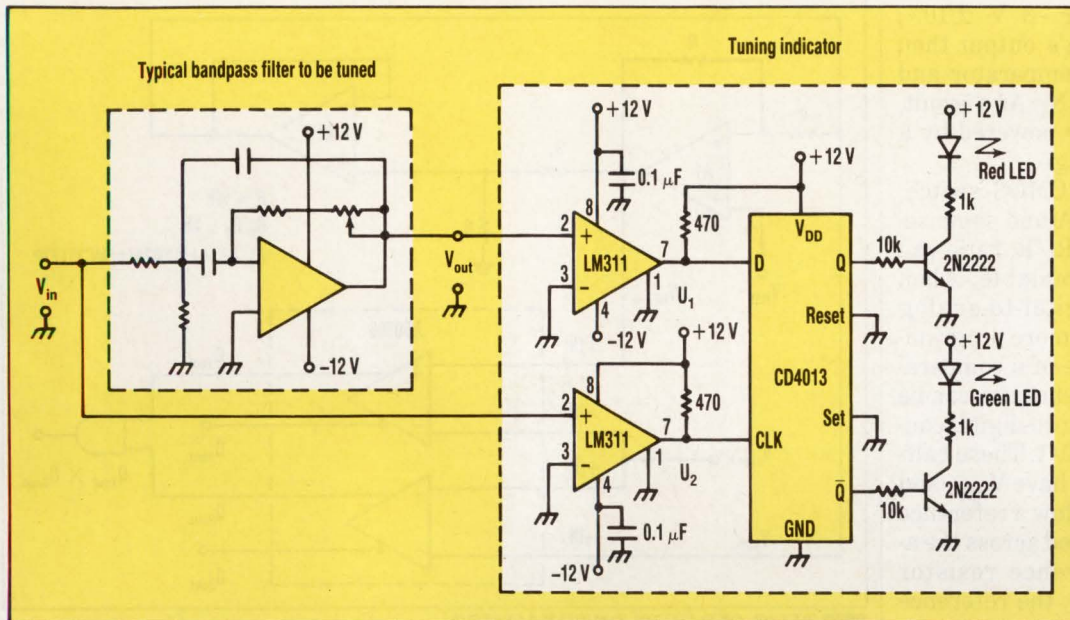

**2. WHEN  $F_o$  is less than  $F_{in}$ , logic 1's are latched at the output of comparator U1 and the red LED lights. The green LED lights when  $F_o$  is greater than  $F_{in}$  and logic are latched at U1's output. When  $F_o$  equals  $F_{in}$ , both LEDs flicker.**

quencies up to 128 kHz and the tuning indication was found to be better than 0.1%. The tuning indication is valid for all sine-wave input frequencies. Though the indication for square and triangular wave inputs

are misleading for a few cycles around the subharmonics of  $f_o$ , the tuning indication is better than 0.1% at  $f_o$ . Hence, this indicator is useful for tuning the filters that convert the square or triangular inputs to sine

waves.

The waveforms shown and LED indications mentioned are for inverting types of bandpass filters. For the noninverting bandpass filters, the two LEDs should be interchanged. □

## CIRCLE 523 WINDOW COMPARATOR TRACKS VOLTAGE

JOHN WYNNE

Analog Devices, One Technology Way, P.O. Box 9106, Norwood, MA 02062; (617) 329-4700.

In many applications, determining when a signal's voltage level falls within or outside a particular voltage range is essential. Automatic test equipment (ATE), communication receivers, and other equipment all require this type of information. To get this data, a simple tracking window comparator can be built that combines high speed, TTL compatibility, and wide versatility (see the figure).

Op amps A1 and A2 form an implicit feedback circuit that accepts a positive input reference voltage ( $V_{REF}$ ) and generates two positive reference voltages,  $V_{REF+}$  and  $V_{REF-}$ . The two generated voltages are equally spaced above and below the original input reference level. They're used as the upper and lower threshold

voltages by the AD9698 dual TTL comparator to establish a window for the signal. When the signal resides inside the window, the AND gate's output is high. When the signal is outside the window, the output is low. An indication of a signal above or below the reference levels can be monitored at the comparators' complementary outputs.

$$\overline{Q_{1out}} = 1 \text{ when } V_{signal} > V_{REF+}$$

$$Q_{1out} \times Q_{2out} = 1 \text{ when } V_{REF-} < V_{signal} < V_{REF+}$$

$$\overline{Q_{2out}} = 1 \text{ when } V_{signal} < V_{REF-}$$

The window's width is determined by the ratio of  $R_1$  to  $R_2$ . Its value is a fixed percentage of the input reference voltage, and stays the same percentage independent of the refer-

ence voltage's actual value. Consequently, the window tracks the reference value and can therefore be placed around an expected signal level of interest. If the width of the window,  $V_{window}$ , equals the difference between the threshold levels,

$$V_{window} = V_{REF+} - V_{REF-} \text{ Then } V_{window} = 2V_{REF} / [1 + 2(R_2/R_1)],$$

$$V_{REF+} = V_{REF} + V_{window}/2, \text{ and}$$

$$V_{REF-} = V_{REF} - V_{window}/2.$$

For example, assume that a signal level to be monitored is valid if it's between 2.7 and 3.3 V, or  $3.0 \text{ V} \pm 10\%$ . The required window would be 0.6-V wide with  $V_{REF}$  equal to 3.0 V. The required ratio of  $R_2/R_1$  is found by solving the equation containing that ratio. In this case,  $R_2/R_1 = 4.5$ ,  $V_{REF+} = 3.3 \text{ V}$ , and  $V_{REF-} = 2.7 \text{ V}$ . To monitor a different voltage—for instance,  $2.0 \text{ V} \pm 10\%$ —just change  $V_{REF}$  to 2.0 V. For a different tolerance, change the  $R_2/R_1$  ratio. Note that the circuit only requires a single supply.

The circuit can also monitor negative voltages. But, because  $V_{REF+}$  must always be more positive than  $V_{REF-}$ , the connections must be

## IDEAS FOR DESIGN

changed. To monitor  $-3\text{ V} \pm 10\%$ ,  $V_{\text{REF}}$  is now  $-3\text{ V}$ . A1's output then drives  $-IN_2$  of the comparator and A2's output drives  $+IN_1$ . As a result, the op amps must be powered by a negative supply voltage.

By using a quad CMOS switch, such as the ADG201A and some selected resistors, the  $R_2/R_1$  ratio can be digitally programmable. Also, adding a CMOS digital-to-analog converter gives even more programmable ratios. In place of a comparator, the  $V_{\text{REF}+}$ - $V_{\text{REF}-}$  generator can be used with such analog-to-digital converters as the AD7820/1. These half-flash 8-bit converters have  $V_{\text{REF}+}$  and  $V_{\text{REF}-}$  inputs, which allow a reference voltage to be impressed across the a-d converter's reference resistor string. Consequently, the reference generator circuit can generate programmable ratiometric levels to effectively increase the a-d converter's resolution. □

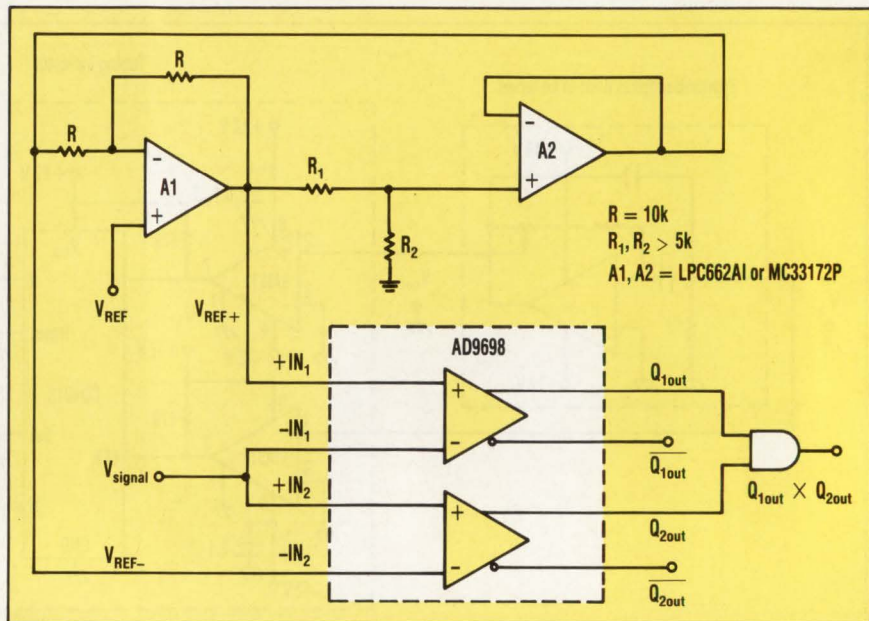

**THIS CIRCUIT DETERMINES** whether a signal voltage falls within a predetermined window around a reference voltage. If the output of the AND gate is high, then the signal falls within the range. The  $Q_{1\text{out}}$  and  $Q_{2\text{out}}$  outputs can determine whether the voltage is above or below the specified reference levels.

# Low Cost Laminates for Static Flex Applications are Just Around the Bend.

Design your static flex circuit with polyimide film and you're on the right track, but going in the wrong direction. Polyimide film static flex circuits are expensive and can't withstand autoinsertable component mounting without the addition of rigidizers.

Design it with BEND/flex® bendable circuit laminate material from Rogers and you can realize substantial savings in material and fabrication costs. Without sacrificing design flexibility or performance. In some applications, BEND/flex laminates

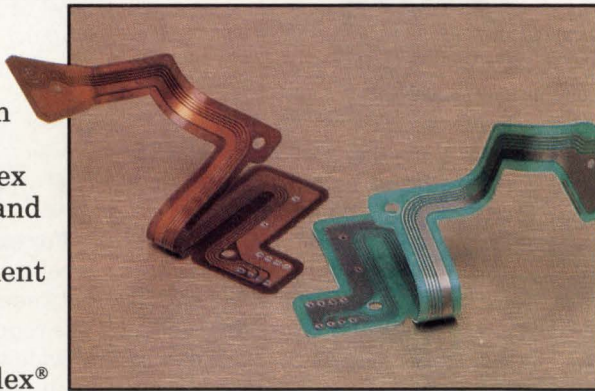

*BEND/flex laminates save costs compared to polyimide film circuitry.*

can actually increase overall product performance.

The future belongs to designers who can think small and save big. BEND/flex laminates can help make that happen.

For all the ways BEND/flex laminates can improve your design options write for a free test kit.

*Technology for tomorrow built on TQC today.*

**ROGERS**

Rogers Corporation  
Composite Materials Division  
One Technology Drive  
Rogers, CT 06263  
203 774-9605 FAX 203 774-1973

U.L. 94VO flame class rating.

BEND/flex is a registered trademark of Rogers Corporation. Also available through Mektron Europe, Ghent Belgium and Rogers Inoue Corp., Nagoya, Japan.

CIRCLE 107



# Monolithic Quad DAC's

**Because more is less...**

**More functionality in a single chip means less pc board real-estate, fewer components and a more reliable product.**

## **SP7584**

- Four DACs on a single chip
- 12-bit resolution
- Independent reference inputs
- Single +5V supply operation
- Double-buffered inputs
- 2 $\mu$ sec settling time
- Current outputs
- 5mW power dissipation
- Surface-mount or thru-hole package

## **SP9345**

- Four DACs on a single chip
- 12-bit resolution
- Double-buffered inputs
- Data latch clear function
- 15 $\mu$ sec settling time
- $\pm 10V$  outputs
- Surface-mount or thru-hole package

**For data sheets on our high performance Monolithic Quad DAC's, call 1-800-272-1772. Today.**

**SIPEX**

SIPEX Corporation  
6 Fortune Drive  
Billerica, MA 01821  
(508) 663-9691  
FAX: (508) 670-9001

## NEW DC/DC OFFERS 10:1 INPUT, 80...720W

The PSK Series offers nine single outputs of 5...42VDC at 16...20A (25A for 5V) with input ranges as wide as 8...80VDC and efficiencies from 82...94%. Standard features include input filtering, remote on/off, true current sharing, remote sense, and adjustable output from 0...110% of nominal. Line and load regulation is 0.5%, output ripple is as low as 30mVpp, and load transient recovery is 40µs. Available options include in-rush current limiting, output crowbar for OVP, and an output potentiometer. Units are suitable for chassis or 3U rack-mount. For more information, contact MELCHER at (508)881-4715 or FAX(508)879-8669

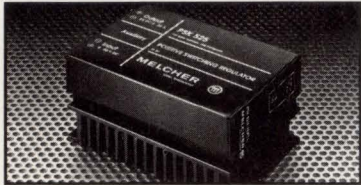

CIRCLE 129

## 3W, 4:1 INPUT DC/DC IN 24 PIN DIP

The new IPS family of 3 watt DC/DC converters offer single and dual output versions (5,12,15V) with a choice of 4:1 input ratios; 10...33VDC or 18...72VDC, all in a 24 PIN DIP! These units maintain a minimum 80% efficiency while providing input and output filtering, isolation of 500VDC, and continuous short circuit and overvoltage protection. The standard ambient temperature range is -25...71° C (full power) with remote on/off standard on all units. For more information, contact MELCHER at (508)881-4715 or FAX(508)879-8669

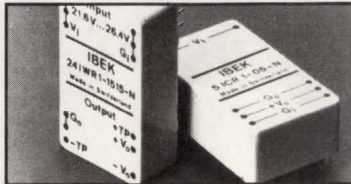

CIRCLE 132

## 50W DC/DC GIVES 5:1 INPUT

The M family (AM,BM,CM,DM,EM) of DC/DC converters provides up to 3 outputs at 50W with an input range of 5:1 (8...35V, 14...70, 28...140, 44...220, and 67...385VDC). They are suitable for any battery powered, telecommunication, SCADA, or transit system. Each unit offers protection against severe transients, continuous open and short circuits, input and output overvoltages, and 2500V isolation. Mechanically, each product is protected from shock and vibration per MIL STD 810D and offers an operating temperature range of -40...95°C (case) to withstand the most severe environments. For more information, contact MELCHER at (508)881-4715 or FAX (508)879-8669.

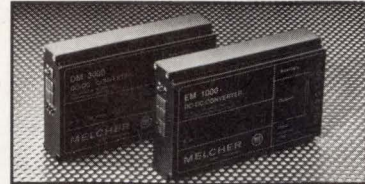

CIRCLE 133

## HIGH EFFICIENCY DC/DC FOR BATTERY BASED SYSTEMS

The PSR family is ideally suited to battery powered systems with its 90% conversion efficiency, ultra-wide input range (8...80 for 5V) and small size. Available in single outputs of 5,12,15,24 and 36V at 2.5,4,8, and 10A, these units can work from 12,24,36,48 or 60V batteries and provide complete protection against short and open circuits as well as step-load changes and harsh environments. They are suitable for PCB, chassis or rack-mounting and many options are available. For more information, contact MELCHER at (508)881-4715 or FAX(508)879-8669.

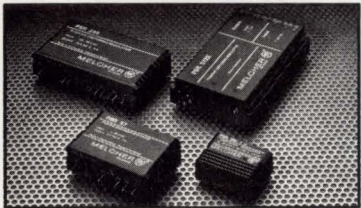

CIRCLE 130

## UNIVERSAL INPUT, 50 WATT CONVERTER

The 50 watt LM Series accepts any input voltage from 85...264VAC and provides up to 3 independently regulated outputs over the entire temperature range of -40...71° C (ambient). Standard features include remote on/off, short/open circuit protection, line and load regulation <1%, and output ripple below 70mV. The unit can be mounted in a 3U rack or chassis and meets MIL STD 810D for shock, bump, vibration and humidity. Many options are available including low leakage currents for medical apparatus (IEC601.1/UL544). For more information, contact MELCHER at (508)881-4715 or FAX(508)879-8669.

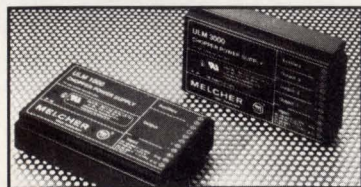

CIRCLE 131

# WHEN YOU GO WITH MELCHER, YOU GO FOR THE GOLD.

Melcher wears the gold medal of excellence for building power supplies that can take it. For over 18 years we've been one of the world's top suppliers of leading edge power conversion technology.

Designers looking to meet the tough spec's required by the most stringent applications look to Melcher for the performance and durability they need. All of our products are strong enough to withstand the most extreme electrical and environmental conditions, and at the industry's best cost/performance ratio. When you need a supply that you can "fit and forget", specify Melcher. The standard of excellence.



**MELCHER** 

MELCHER, INC. 200 Butterfield Drive, Ashland Massachusetts 01721  
Tel. 508-881-4715 Fax 508-879-8669

CIRCLE 134

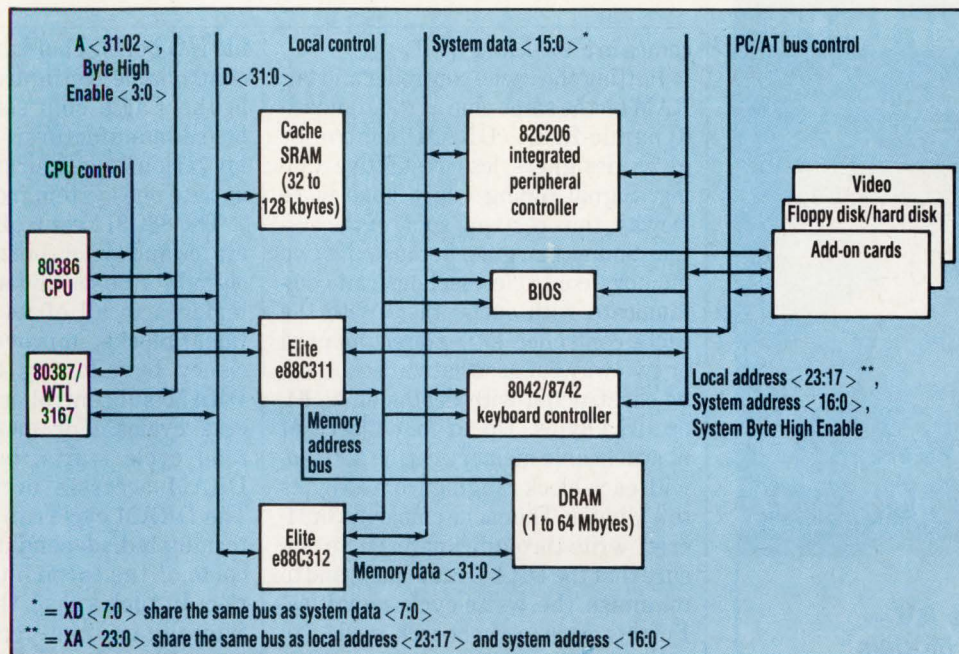

**THE EAGLE CHIP SET** reduces PC motherboard logic to less than 25 chips by merging the cache controller and cache tag RAM into the logic chip. Not only is the chip count cut down, but system efficiency is also improved because DRAM and cache access cycles can be overlapped.

# PC CHIP SET EASES DESIGN OF CACHE-BASED COMPUTERS

DAVE BURSKY

Currently, designers of PC-clone hardware can choose from over two dozen chip sets that allow systems to be built at a small cost with minimum functionality, such as the base-line PC/AT-class motherboard. However, as system CPUs get more powerful, the base-level of system features must increase so that users can take advantage of the enhanced performance with minimal additional hardware. This vision led designers at Elite Microelectronics Inc. to define the Eagle chip set, a pair of chips that enables system designers to build cache-based motherboards operating at clock speeds of up to 33 MHz.

With the Eagle chip set, an entire 80386DX-based PC motherboard can be built with as few as 25 components. The only other devices needed are the CPU, BIOS memory, keyboard controller, an integrated peripheral controller (such as the widely available 82C206), and a few TTL chips (*see the figure*). To round out the motherboard, just the cache RAMs and the main dynamic-RAM-based memory must be added. To make that possible, the two chips in the Eagle chip set include one key function that's usually optional chips in previous systems, such as a cache controller. The e88C311 is the main system logic chip and comes in a 184-lead plastic quad-sided flat package (PQFP). The e88C312 handles memory-transfer operations and

# High Voltage DC-DC Converters



ACTUAL  
SIZE

**.5" x .5" x .4" Ht.  
1000 VDC Output**

- **New Series AV—  
56 Standard Models**
- **100 VDC to 1000 VDC  
Output**
- **Ultra-miniature Size  
Weight: 4 Grams  
0.1 Cubic Inch Volume**
- **Standard Input Voltages  
5, 12, 24 and 28 Volts DC**
- **Operating Temperature  
Standard: -25°C to +70°C  
Optional: -55°C to +85°C**
- **MIL-STD-883  
Screening Available**
- **Isolated: Input to Output  
up to 1500 VDC**

PICO also manufactures over 800 regulated and isolated DC-DC Converters and AC-DC Power Supplies and over 2500 standard ultra-miniature Transformers and Inductors.

Delivery—  
stock to  
one week

SEE EEM,  
THOMAS REGISTER  
OR SEND DIRECT FOR  
FREE PICO CATALOG

## PICO Electronics, Inc.

453 N. MacQuesten Pkwy. Mt. Vernon, N.Y. 10552

Call Toll Free **800-431-1064**

IN NEW YORK CALL **914-699-5514**

CIRCLE 100

## CACHE-BASED PC MOTHERBOARD CHIP SET

comes in a 160-lead PQFP.

Putting the cache controller and tag RAM on the same chip as the standard dynamic-RAM (DRAM) controller gives designers less restrictive timing. Signal timing edges have more leeway, thus relaxing some of the system timing margins, because the two memory controller sections can communicate with each other. With the cache controller, either direct-mapped or two-way set-associative caches can be constructed with depths of 32, 64, or 128 kbytes. Up to four blocks of noncacheable memory can be defined, with each block ranging from 4 kbytes to 4 Mbytes. The cache employs a buffered write-through approach to ensure that the DRAM is updated, and to minimize the write-cycle penalties. Furthermore, a cache-lock mode can prevent new data from being written into the cache when frequently used program code is held in the cache.

The companion DRAM controller can address up to 64 Mbytes of system memory and DRAMs with capacities of 256 kbits and 1 or 4 Mbits. Both page and page-interleaved operating modes are possible. Three refresh schemes can keep data in the RAMs—hidden, burst, and PC/AT style. To ensure fast system operation at minimal cost, up to 256 kbytes of the DRAM are able to serve as shadow memory for BIOS information usually held in slow EPROMs. A sophisticated memory remapping technique allows designers to maximize the use of installed physical memory. Finally, the controller achieves zero-wait-state operation for both pipelined and nonpipelined cache misses or page hits.

The chip set has several similarities to other commercially available motherboard logic chips. It supports both the Intel 80387 and Weitek WTL3167 math coprocessors and provides the Fast GateA20 and Fast Reset signals needed for maximum OS/2 performance. Moreover, the chip set supplies a programmable PC/AT bus clock that permits both synchronous and asynchronous operation, and designers can select the system configuration for two serial and one parallel port, and chip-select logic for two software-programma-

ble I/O ports. There are 60 software-controllable configuration registers in the Eagle chip set that motherboard manufacturers can use to set up various configurations to differentiate one system from another.

The 88C311 controller, which generates and synchronizes each control signal for buses and manages the interfaces to all of its internal functional blocks, improves system efficiency by allowing the cache and DRAM subcontrollers to share access cycles. For instance, when a read cycle starts, both cache and DRAM accesses occur in parallel. The DRAM cycle can continue or be terminated, depending on the outcome of the cache hit-or-miss detection. In such a case, the time penalty typically encountered by a nonintegrated cache and DRAM architecture is reduced. This is because the DRAM need not wait for the hit/miss signal from the tag-RAM directory to start the DRAM operation.

Along with the DRAM and cache control blocks, the 88C311 includes reset and shutdown logic; CPU, local memory, cache, and AT-bus state machines; arbitration logic; address buffers and latches; and configuration registers. The 88C312, which controls the interface between the CPU data bus and the various board-level buses (AT-bus, local system bus, memory data bus, ROM interface, and so on), also implements the byte-alignment and byte-swapping logic needed when data transfers occur between boards of different data widths. Parity logic included on the 88C312 generates and writes parity into the DRAM array during main-memory write cycles. □

### PRICE AND AVAILABILITY

The Eagle chip set sells for \$168 in lots of 1000; samples and production quantities are available immediately. Evaluation boards are also available.

Elite Microelectronics Inc., 711 Charcot Ave., San Jose, CA 95131; Arun Kumar, (408) 943-0500. CIRCLE 516

### HOW VALUABLE?

HIGHLY	560
MODERATELY	561
SLIGHTLY	562

### CIRCLE

"The final design has the  
circuit board in the back,  
but the LEDs must be  
in the front.

Now what?!"

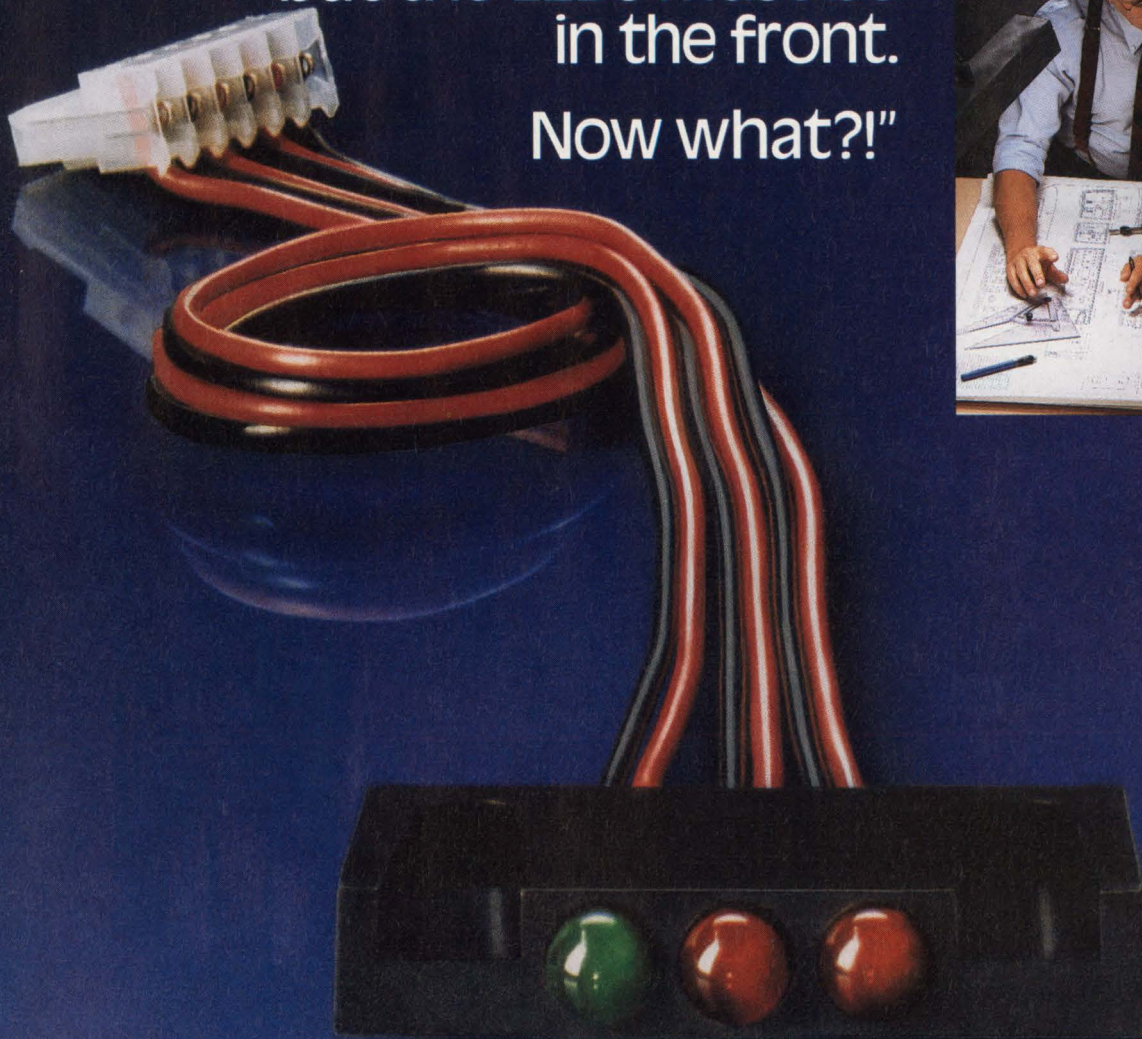

## All indications are Dialight.

Call it a problem that could have led to considerable expense. The customer thought he'd have to add several steps to his assembly process. Instead he called Dialight.

As the leader with over half a century of experience in every type of indicator light, for Dialight solving problems is standard operating procedure. Applying our engineering expertise in optoelectronics and utilizing state of the art CAD equipment, we rapidly proceeded to custom design the ideal solution – a totally integrated, remote LED indicator. Not only did it fit the unit perfectly, but it also saved the expense and effort of cumbersome wiring, soldering, and testing. Plus it added the reliability of a push-on connector for easy assembly. All while being low cost. And, thanks to our extensive in-house tool fabrication

and molding facilities, we delivered it virtually overnight.

Saving costs while solving problems is something we've long done with our panel mount and circuit board LEDs. Over the years customers have asked us to pair, gang, piggyback, right angle mount, recess, bicolor, tricolor, slant, standoff, snap-mount, bin, do whatever you can imagine to them and we haven't been stumped yet!

So, the next time you think there's a remote chance of finding the right solution to an indicator design issue, remember that no one has more solutions than Dialight.

**DIALIGHT CORPORATION**

A Cambridge Electronic Industries Co.

1913 Atlantic Avenue, Manasquan, NJ 08736 201-223-9400

# When It Comes to Data Acquisition We've Got All the Bases Covered

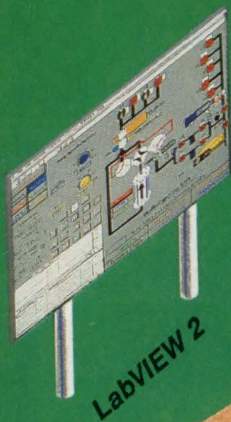

LabVIEW 2

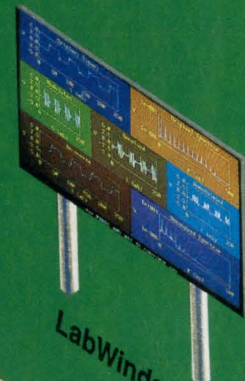

LabWindows



Macintosh



IBM PS/2



PC/XT/AT

*Why Play Ball  
With Anyone Else?*



EISA

#### Our lineup for the season:

- Boards for all PC platforms
- Self-calibration
- 8 to 16-bit resolution
- DMA on all computers
- Toll-free technical support
- 33.33 MFLOPS digital signal processing
- Signal conditioning and antialiasing filters
- Multiboard timing and synchronization with RTSI®
- LabVIEW® 2, LabWindows®, VisionScope™, and LabDriver® software

Many vendors can get you to first base with PC/XT/AT boards. We're the *only* company that will take you all the way home, with boards for the PC, Macintosh, PS/2, and EISA bus.

#### SCOREBOARD

Board	Computer	Analog In	Sample Rate	Resolution (Bits)	Analog Out	Digital I/O	Counter/Timers	DMA Direct to Memory
Lab-PC	PC/XT	8	62.5k	12	2	24	3	√
Lab-SE	Macintosh SE	8	125k	8	2	24	3	—
AT-MIO-16	PC/AT	16	100k	12	2	8	3	√
MC-MIO-16	IBM PS/2	16	100k	12	2	8	3	√
NB-MIO-16X	Macintosh II	16	55k	16	2	8	3	√
NB-A2000	Macintosh II	4	1M	12	—	—	—	√
EISA-A2000	EISA	4	1M	12	—	—	—	√

To see the rest of our data acquisition team, call for **FREE** catalog.

 **NATIONAL INSTRUMENTS®**  
The Software is the Instrument™  
6504 Bridge Point Parkway  
Austin, TX 78730-5039

Nihon National Instruments K.K. (Japan) (3) 788-1922  
National Instruments of France (1) 4865-3370  
National Instruments of Italy (2) 4830-1892  
National Instruments United Kingdom (06) 355-23-545

**(800) 433-3488 (U.S. and Canada) • (512) 794-0100**

# FIVE LOW-COST 10-BIT ADCS CONVERT IN UNDER 2.5 $\mu$ S

A QUINTET OF  
10-BIT ADC  
ICS SAMPLE AND  
CONVERT 5-V  
WAVEFORMS IN  
0.5 TO 2.5  $\mu$ S  
MAXIMUM, WITH  
NYQUIST RATES  
REACHING  
300 KHZ.

FRANK GOODENOUGH

**M**ove over 0820 8-bit 1.5- $\mu$ s ADC, because five new 10-bit devices have arrived. The venerable, standard 8-bit ADC, with its low-cost half-flash architecture in CMOS, has prevailed for over eight years. But overwhelming demand called for 10-bit ADCs with similar performance and price, for applications as diverse as disk drives and mobile radio. Unlike their 8-bit predecessor, several of the new 10-bit devices have Nyquist rates commensurate with their throughput rates thanks to a high-speed sampling capability. And all but one can sample 100-kHz sine waves to 9-bit accuracy.

Two of the converters, the ADC10061 and the ADC1061, are from National Semiconductor. The remaining three—the MAX151, ML2271 and MP7695—are from Maxim Integrated Products, Micro Linear, and Micro Power Systems, respectively. Minimum conversion times for the five run 0.8, 1.8, 2.5, 1.45, and 0.5  $\mu$ s, respectively. Micro Linear recently announced a drop-in for the 0820, which can sample a 250-kHz sine wave to 8-bit accuracy (ELECTRONIC DESIGN, April 12, 1989, p. 28 and 212).

Each ADC has its own set of features and specifications (see the table). All employ two-step architectures, except for the ML2271, which uses three steps. In addition, similar to its recent 8-bit sibling and unlike the other four, the ML2271 employs digital error correction. The

## 10-BIT ADC SPECIFICATIONS

Specifications <sup>1</sup>	MAX151A	ML2271B	MP7695	ADC10061B	ADC1061
1) Conversion time ( $\mu$ s)	2.5	1.45	0.5	0.9	1.8
2) Maximum input frequency for 10-bit performance (kHz)	40 t	300 t	10 t		60 t
3) Differential nonlinearity			(all, no missing codes at dc)		
4) Integral nonlinearity ( $\pm$ LSB)	na	1/2	1.25	1.1	1.5
5) Total unadjusted error ( $\pm$ LSB)	1	3/4	na	1.5	2
6) Signal-to-noise ratio (dB/bits)	55/8.8	60/9.7 t	na	60/9.4 t	na
7) ( $f_s/f_m$ ) (kHz)	40/300	150/600		512/160	
8) Total harmonic distortion (-dB/bits)	60/9.7	60/9.7 t	na	0.08% t/na	na
9) ( $f_s/f_m$ ) (kHz)	40/300	150/600		512/160	
10) Intermodulation distortion (dB)	na	-60 t	na	na	na
11) ( $f_s/f_{ina}, f_{mb}$ ) (kHz)		600/150, 148			
12) Full power bandwidth (kHz)	5 MHz t	na	na		na
13) Slew rate (V/ $\mu$ s)	na	4.7	na		2.5
14) Supply voltage, current (V, mA)	$\pm$ 5, 45	5, 32 mA	5, 6 t	5, 47	5, 47
15) Package(s) and features (see footnotes)	2,3,4	5,6,9	2	5, 6, 7, 8	5
16) Cost each in 100s	\$16.66	\$17.00	\$24.95	\$17.90	\$11.90

Footnotes: 1) All specifications minimums/maximums over temperature unless noted otherwise. t=typical, na=not available. 2)24-pin DIP 3)24-pin, wide-body SOIC. 4)Reference. 5)20-pin, DIP. 6)20-pin, wide-body SOIC. 7)ADC10062, two inputs, 24-pin DIP and SOIC. 8)ADC10064, four inputs, 28-pin DIP and SOIC. 9) A "C" grade with an INL of  $\pm$ 1 LSB and a total unadjusted error of  $\pm$ 1.5 LSB goes for \$11.80 each.

## SUB-2.5- $\mu$ S-CONVERSION-TIME, 10-BIT, IC ADCS

MAX151, on the other hand, laser-trims thin-film resistors in the flash ladders to achieve 10-bit accuracy.

All five CMOS ADCs guarantee "no missing codes" over their operating-temperature ranges. Each employs the autozeroed comparators that use switched-capacitor techniques, which are virtually mandatory for CMOS ADCs. The architecture of all but the MP7695 take full advantage of these circuits' inherent ability to sample fast-changing waveforms. However, this sampling ability doesn't come free. The ADCs' input circuits—the array of comparators forming the flash converters—look to the input signal like a rapidly-changing (at the sampling rate) capacitance. Therefore, if operated at high sampling rates, the analog input must be driven from a low-impedance source at high-frequencies.

The MAX151 is the only one with an on-chip reference—a buried Ze-

ner circuit with a drift of 60 ppm/°C. It's also the only device that needs both plus and minus 5-V supplies; the others require only +5 V. However, it can handle a 0-to-10-V input or  $\pm 5$  V, while the others are limited to 0 to 5 V. The MP7695 is the fastest of the group, converting in 0.5  $\mu$ s, a function of its 2- $\mu$ m, molybdenum-gate (rather than poly-gate) CMOS process. It's also the lowest in power consumption, typically just 25 mW. The others consume about ten times that, from 180 mW for the ML2271 to 275 mW for the MAX151.

Despite its speed, the MP7695 is limited to sampling signals accurately below 10 kHz or those slewing at less than 2 V/ $\mu$ s. With a high-speed multiplexer on the front end, it's ideal to digitize many slow signals at high speed, particularly in portable equipment.

In their 20-pin DIPs, the ML2271, ADC10061, and ADC1061 have functionally identical pinouts. Therefore,

they're theoretically interchangeable. And along with the MAX151, they interface with most microprocessors easily—their parallel three-state outputs appear as memory locations or I/O ports. In addition, while in larger packages, National ADC's 10062 and 10064 versions have two and four input channels, respectively, and an internal multiplexer (see table footnotes). Channels are selected through one- or two-bit input words for the two- or four-channel device, respectively. Both converters sport a speed-up pin. Putting a resistor between that pin and ground halves conversion time.

The dynamic specifications of these converters represent a major difference between these chips and their 8-bit forerunners. When handling ac signals, particularly in digital-signal-processing applications, the MAX151, ML2271, and ADC1006 take full advantage of their sampling ability. As a result, they're specified dynamically as well as statically, providing values for signal-to-noise ratio, total harmonic distortion, and intermodulation distortion specifications (see the table, again). Also, the MAX151 specifies a full-power bandwidth of 5 MHz. □

### PRICE AND AVAILABILITY

*Versions of the MAX151 and MP7695 are only available for the commercial-temperature range. Grades of the ADC1061 and ADC10061 can be had for both the extended-industrial and military temperature ranges. ML2271 grades are available for commercial, extended-industrial, and military temperature ranges. The devices specified in the table are for the highest-performance and lowest-temperature grades. Prices are given in the table.*

**Maxim Integrated Products, Inc., 120 San Gabriel Dr., Sunnyvale, CA 94086; Zia Boyacigiller, (408) 737-7600. CIRCLE 512**

**Micro Linear Corp., 2092 Concourse Dr., San Jose, CA 95131, Al Tremain. (408) 433-5200. CIRCLE 513**

**Micro Power Systems Inc., P.O. Box 54965, Santa Clara, CA 95054-0965; Tom Hardy, (408) 727-5350. CIRCLE 514**

**National Semiconductor Corp., P.O. Box 58090, Santa Clara, CA 95052-8090; Andy Jenkins, (408) 721-2273. CIRCLE 515**

### Just Published! A practical handbook to help you design today's sophisticated machines —

#### STANDARD HANDBOOK OF MACHINE DESIGN

By Joseph E. Shigley and Charles R. Mischke

1,632 pages, 929 illustrations, \$108.00

The entire subject of machine design is presented with emphasis on solving problems that arise daily in engineering design. The wide range of new materials, new components, new processes, and new analytical tools that have brought great changes in the way machines are designed have been covered to permit the design of machines in the future to meet more rigorous standards of reliability, safety, lighter weight, greater speed, and compactness. Use of computer-aided design methods as well as other machine-computation facilities are integrated throughout the handbook and presented in such a manner that future developments in computer hardware and software will not render the contents of the handbook obsolete.

47 GIANT SECTIONS fully cover every aspect of machine design.

To order your copy, complete the coupon below and mail to: Penton Education Division, 1100 Superior Avenue, Cleveland, Ohio 44114 or, for faster service, call 800-321-7003 (In Ohio, call 216-696-7000).

#### ORDER FORM

Please send me \_\_\_\_\_ copy(s) of STANDARD HANDBOOK OF MACHINE DESIGN. I understand that I can review it for 15 days and, if not satisfied, return it for full refund or credit.

- My payment is enclosed for postage-free shipment in the U.S. and Canada.  
 Bill my company and include shipping and handling charges. Company purchase order required.  
 Charge my:  MasterCard  Visa  American Express Card

Account No. \_\_\_\_\_ Exp. Date \_\_\_\_\_

Name \_\_\_\_\_

Company \_\_\_\_\_

Address (not P.O. Box) \_\_\_\_\_

City \_\_\_\_\_ State \_\_\_\_\_ Zip \_\_\_\_\_

Signature \_\_\_\_\_

Penton Education Division • 1100 Superior Avenue • Cleveland, Ohio 44114



#### HOW VALUABLE?

HOW VALUABLE?	CIRCLE
HIGHLY	557
MODERATELY	558
SLIGHTLY	559



# LOW POWER, LOW COST MULTICHANNEL A/D CONVERSION

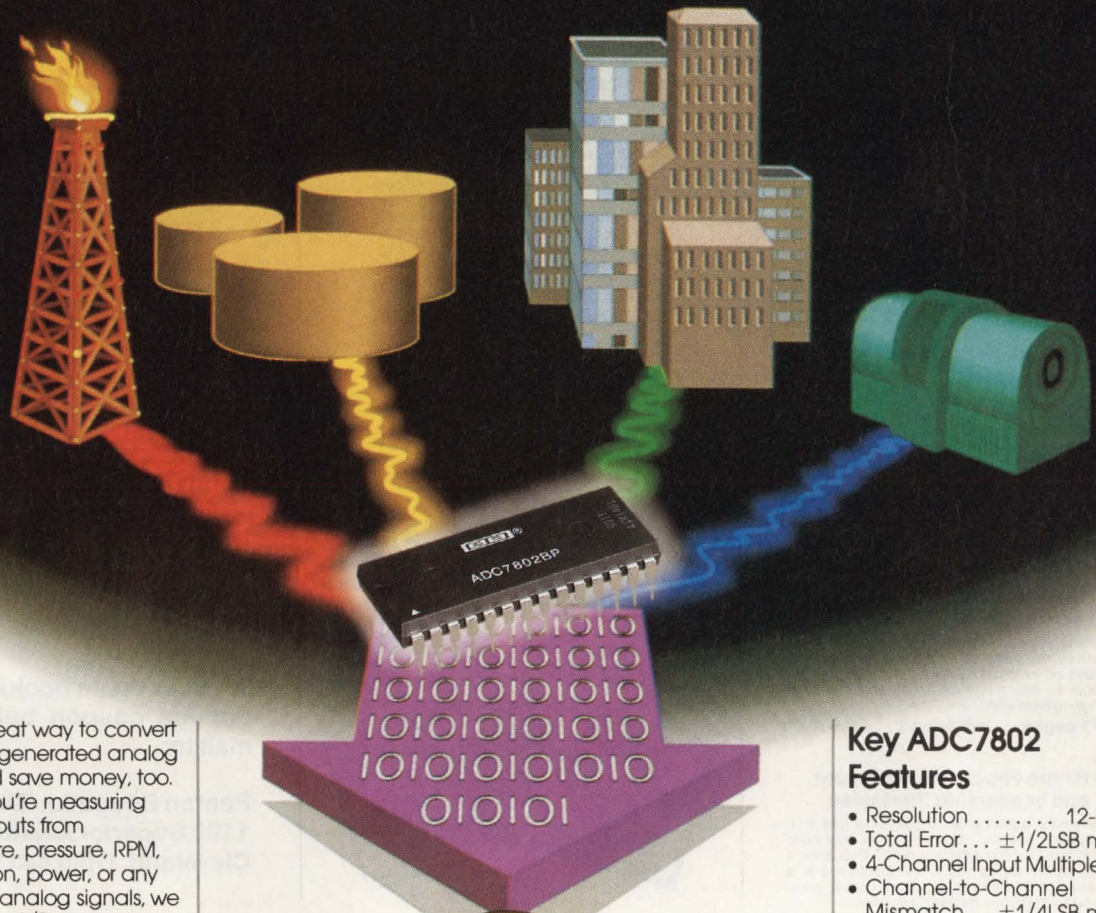

Here's a great way to convert those field-generated analog signals and save money, too. Whether you're measuring multiple inputs from temperature, pressure, RPM, flow, rotation, power, or any number of analog signals, we have a new A/D converter that you'll like. Our ADC7802 12-bit autocalibrating sampling A/D converter offers extremely high accuracy, and features an internal sample/hold and a 4-channel multiplexer to cut your signal conditioning costs. It's the ideal solution for a broad range of data acquisition and industrial process control applications.

## Accuracy and Low Power

Autocalibration guarantees a total error within  $\pm 1/2$ LSB over the extended  $-40^{\circ}\text{C}$  to  $+85^{\circ}\text{C}$  industrial temperature range without offset or gain adjustment. And to add to its versatility, the ADC7802's advanced CMOS design dissipates just 10mW and operates from a single 5V supply ... just right for those battery-backed or remote applications. Conversion time, including acquisition, is 17 $\mu\text{s}$ .



## Microprocessor Friendly

The ADC7802 also has an onboard clock and an 8-bit microprocessor interface. It has a 0V to 5V unipolar input range and offers standard  $\overline{\text{CS}}$ ,  $\overline{\text{RD}}$ , and  $\overline{\text{WR}}$  controls to simplify interfacing. Conversion results are available in two bytes through an 8-bit three-state output bus with "No Missing Codes" over temperature.

## Key ADC7802 Features

- Resolution . . . . . 12-bits
- Total Error . . .  $\pm 1/2$ LSB max
- 4-Channel Input Multiplexer
- Channel-to-Channel Mismatch . .  $\pm 1/4$ LSB max
- Conversion Time . . 17 $\mu\text{s}$  max
- Power Dissipation . . . 10mW
- Power Supply . . . Single 5V
- Operating Temperature . .  $-40^{\circ}\text{C}$  to  $+85^{\circ}\text{C}$
- Packages: 28-Pin plastic DIP or 28-lead PLCC

Low power, low cost, and available off-the-shelf. A *real* 12 bits for under \$5.00\* per channel. For complete information, write Burr-Brown Corp., P.O. Box 11400, Tucson, AZ 85734. Or, call **toll free 1-800-548-6132**.

\* U.S. OEM prices, in 100s start at just \$19.95



# The Management Collection

Books selected to help you approach difficult business situations more knowledgeably.

## LEADERSHIP

### R75 Surviving the Crisis of Change — Honing Your Management Skills

In today's fast-paced business world it is not always easy to find the best answers to difficult questions. This series of forty articles is a collection of Industry Week's best information dealing with change that affects managers' professional as well as personal lives. You'll learn how to gain control over difficult problems that you encounter every day. Articles include . . . Expand Your Career by Expanding Yourself; The Politic Game; Surviving a Takeover; When Values Collide; and many more.

124 page . . . softbound . . . \$22.50

### R85 How to be a Better Leader

Frederick Herzberg, Daniel Yankelovich, Charles Day, Perry Pascarella and others in classic articles about the changing expectations of today's workforce and how to deal with them. Included are: Selecting Your Management Style, Dealing With Your Subordinates, Motivating Your Workers, and more.

98 pages . . . softbound . . . \$17.50

### R09 Your Toughest Tests As A Manager

This book guides you in assessing your own management skills and helps you to develop the strong leadership capabilities you need to be a more effective manager. Articles include: Developing a Flexible Management Style, Motivating Without Manipulating, Handling Creative Staff Members, Dealing With Conflict, Delegating Without Losing Control, and many more.

57 pages . . . softbound . . . \$15.00

### R87 the Unhealthy Executive and Some Practical Cures

Managing in an age of anxiety can drive executives into dangerous responses. This book keys on emotional awareness. It shows you how to recognize potential problems and how to deal with them.

72 pages . . . softbound . . . \$16.00

### R89 Future Focus: Advancement and Leadership Strategies

Should you plan your career — or just let it happen? Are you using strategies that build success or deter advancement? These are a few of the topics you'll find discussed in a series of articles ranging from career planning to executive management skills.

117 pages . . . softbound . . . \$18.00

## MOTIVATION

### R88 Herzberg on Motivation

What can the manager do for himself and for his subordinates to overcome the "burnout" caused by the increasing abstraction of work and work relationships? Why is scientific management not the answer to increasing productivity? This book answers all these questions plus many more . . . from problems that might surface in trying to make participative management work to effective leadership in a period of psychological depression . . . this book has it all.

80 pages . . . softbound  
third printing . . . \$22.50

## LEGAL

### R80 Right Off The Docket

This book is an invaluable reference source of more than 140 industrial accident and occupational illness claims. The index provides a cross-reference for each case by type of injury and the judicial ruling set forth so that you can quickly turn to those cases of particular interest.

130 pages . . . softbound . . . \$10.00

Order your review copies now!

Call toll-free  
800-321-7003

(in Ohio 216/696-7000)

## MANUFACTURING

### R72 Strategic Manufacturing

This complete series of twenty-four articles analyzes some of the key issues management must face in developing effective strategies in the years ahead. The articles discuss "how" to link manufacturing with all of the functional departments of an organization so they work with a broad, corporate view of their goals. Articles include . . . Ten Ways to Mismatch Technology; Learning From Foreign Strategies; CIM . . . Walking Through Fire; Challenging Tradition; and much more.

94 pages . . . softbound . . . \$19.50



## FINANCE & ACCOUNTING

### X38 Managerial Accounting for Non-Financial Managers

You'll work as a company controller in this programmed learning course. You'll learn to properly record all the company's business transactions . . . sales, inventory purchases, operating expenses, depreciation, equity changes, disposal of assets. When the company's fiscal year ends, you'll prepare the annual report, balance sheet, income statement, and the statement of source and application of funds. When you've finished the course, you'll understand better the role of accounting and how to use the information accounting gives you to be a more effective manager.

Two volumes—course book and workbook . . . \$27.50

### X29 How To Read a Financial Report

Written in programmed learning format, this book will review the accounting process, tracing the steps from the actual sale to the appearance of the transaction on the financial statements. Then you'll learn how to assess financial position and performance of your company through the use of ratio analysis—analyzing liquidity, activity, profitability, and coverage ratios.

140 pages . . . spiral bound . . . \$19.50

## BUSINESS STRATEGY

### R70 Strategic Management

Getting a fix on your competitive position. Establishing a clear purpose for the corporation. Meshing the corporate purpose with the individual goals of your people, and Getting their commitment. This collection of ten articles will help show you ways to foster greater vision of your corporate purpose and techniques for combining the human and technological factors needed for good decision-making.

34 pages . . . softbound . . . \$7.00

To order these books, just fill out the coupon below and mail to:

Penton Education Division  
1100 Superior Avenue  
Cleveland, Ohio 44114

Please send the books indicated. I understand that I can review them for 15 days and, if not satisfied, return them for full refund or credit.

Item #	Quantity	Item #	Quantity
R09	_____	R87	_____
R70	_____	R88	_____
R72	_____	R89	_____
R75	_____	X29	_____
R80	_____	X38	_____
R85	_____		

Orders under \$15.00 must be prepaid.

- My payment is enclosed for postage-free shipment in the U.S. and Canada.  
 Bill my company and include postage and handling charges. My purchase order is enclosed.  
 Charge my  Mastercard  Visa  American Express Card

Account No. \_\_\_\_\_ Exp. Date \_\_\_\_\_

Name \_\_\_\_\_

Company \_\_\_\_\_

Address (not P.O. Box) \_\_\_\_\_

City \_\_\_\_\_ State \_\_\_\_\_ Zip \_\_\_\_\_

Signature \_\_\_\_\_

Penton Education Division  
1100 Superior Avenue • Cleveland, Ohio 44114

# TELECOM DC/DC CONVERTERS

**VICOR PROVIDES THE POWER FOR TELECOM APPLICATIONS**

## Central Office



## Customer Premises Equipment

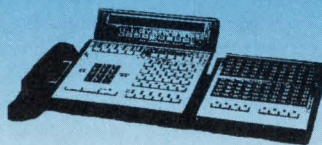

## Remote Cell Site

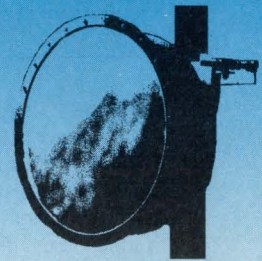

### VI-J00

- ▶ 2.28" x 2.4" x 0.5"
- ▶ 25-100 Watts

### VI-200

- ▶ 4.6" x 2.4" x 0.5"
- ▶ 50-200 Watts

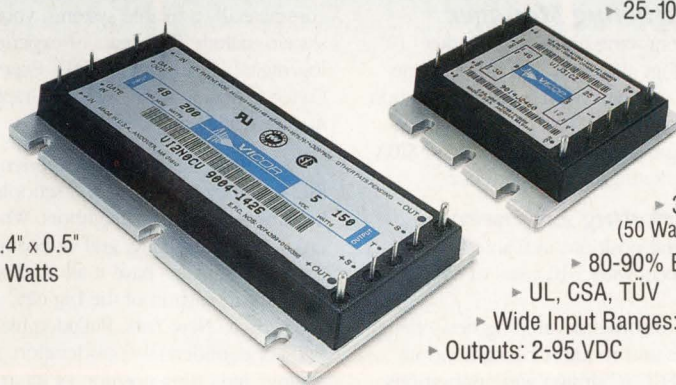

### Family features

- ▶ 36 Watts/in<sup>3</sup>  
(50 Watts/in<sup>3</sup>—SlimMod™ option)
- ▶ 80-90% Efficiency
- ▶ UL, CSA, TÜV
- ▶ Wide Input Ranges: 21 to 56 VDC
- ▶ Outputs: 2-95 VDC

From remote sites in Alaska and desert sites in Egypt to central offices in Oklahoma, agency approved Vicor converters have consistently demonstrated the ability to meet rigorous demands (Bellcore or British telecom) at competitive prices.

For immediate delivery of converters or for additional information call **VICOR EXPRESS** today at 1-800-735-6200

Component Solutions For Your Power System



CIRCLE 151

Common Stock traded on NASDAQ under "VICR"

# We're not handing you the same old line.



---

## *AT&T Microelectronics/Reading*

---

At AT&T Microelectronics in Reading, PA, you'll find a whole new attitude. More aggressive, tenacious and competitive. Our people have the authority and flexibility to help us compete in new markets, and our IC technology is unmatched in the industry. If you can excel in this environment, then match your qualifications to one of the following:

### ***New Product Line Manager***

Responsible for identifying new markets for high voltage IC products, you will need a BS and 5-7 years of experience with solid state relays, and business plan development; IC design and/or applications experience is desirable.

### ***Strategic Marketing Manager***

To develop long range power IC market position, technology direction and product line implementation, you will need product definition skills (power IC, supply design or field applications engineering background), a BSEE and MBA or equivalent marketing/sales experience.

### ***Product Marketing Engineers***

We have several positions available for Product Marketing Engineers with 5-10 years of experience and a BSEE.

One position involves developing new clients and product lines and requires background in DBIC, ASIC and ECL. IC design and applications engineering experience preferred.

The second position is responsible for linear product marketing to major telecommunications accounts and requires program and project management experience. You should be accomplished in major account development and be able to handle P&L responsibility.

The third position will interface with design, applications, process and product engineering, and requires linear bipolar expertise. Experience with custom and semi-custom IC development, proposal development, demand forecasting and pricing are required.

### ***Applications Engineer***

You will need a BSEE and 5-10 years of experience in linear bipolar, custom and semi-custom IC design and layout. Knowledge of instrumentation and measurement, ATE, cellular telephone and mass storage is essential.

### ***Senior CAD Engineer***

Responsible for supporting both internal and commercially available systems, your background should include 5-10 years of experience with analog/digital (ECL) bipolar CAD. Experience with the Cadence Analog Artist, Mentor Graphics or Valid Analog Workbench desirable.

Join us in Reading and experience the best of the American lifestyle. Good schools, affordable housing and friendly neighbors. Whether you enjoy camping, skiing, golf or boating, the nearby Pocono Mountains have it all. And when you're ready for the action of the big city, we're just a short trip to New York, Philadelphia or Washington. For confidential consideration, send your resume, indicating position of interest, to: P.E. Henderson, Dept. 1000/ED, AT&T Microelectronics/Reading Works, P.O. Box 13396, 2525 North 12th Street, Reading, PA 19612-3396. An equal opportunity employer.



# SALARY SURVEY

PAY INCREASES ARE HARDER TO COME BY THIS YEAR

BY SHERRIE VAN TYLE

Engineers are making more money than ever. But this year's salary picture is far from rosy. Raises earned in the past 12 months were skimpier than in the preceding 12-month period. And better than one in three engineers thinks that his salary has hit a plateau. Most engineers also say their salaries are comparable to those of others in the same field.

These findings come from a survey of 1500 *Electronic Design* readers in August. Here's the picture that emerges from tabulating the survey's 354 responses: the average reader is male, 39.7 years old, and makes \$51,646 a year. He has 13.7 years of engineering experience. His salary increased 6.08% in the past 12 months compared with 6.73% in the previous 12 months. With the title of design engineer, he works for a company that does \$380 million worth of business annually. On the average, he supervises three other engineers.

With almost 14 years in the profession, the average engineer has plenty to say about career issues—especially salary plateaus, the survey finds. Entry-level salaries for engineering graduates are often higher than for other professionals. After a decade in the workforce, though, the initial salary advantage erodes. And with an equal years number of years in their professions, engineers tend to make less than lawyers, doctors, and scientists.

As one reader put it, "Due to the high level of continuing education required, salary ceilings for engineers are having a negative impact on morale and productivity, causing many

engineers to leave the technical field for the higher paid management and business fields."

About 38% of the readers surveyed believe that their salary has hit a ceiling. These readers fixed that plateau at an average of \$59,492.

Of these respondents, 65 commented on salary plateaus. One engineer remarked, "We would like to delude ourselves that ceilings, like age discrimination, don't exist. They both do, unfortunately."

Salary ceilings, some readers pointed out, could push some engineers out of the profession. Ceiling pressure hits older engineers hardest. And one quarter of readers surveyed (24%) have 21 or more years of engineering experience. In the words of one engineer: "I'm worried that I will hit [a salary ceiling] soon. It may lead to a career change." Another engineer wrote, "Salary ceilings force older, experienced engineers out of the field. It is a nervous, insecure feeling being at, or near the ceiling." Along similar lines, another engineer warned, "If you're over 45, get out of the profession."

Still, 62% of the engineers surveyed didn't feel their salaries have hit a ceiling. But just a handful commented. One reader attributed a lack of salary limits to his industry: "Salary ceilings are not a problem for good engineers in the disk-drive industry." For another reader, merit helps lift salary ceilings: "I don't believe ceilings exist for good engineers."

Questions of merit aside, average raises shrank from 6.73% for the previous 12-month period to 6.08% for the most recent 12 months. That 0.65% difference, on a \$50,000 salary,

## WOULD YOU DESCRIBE YOUR SALARY AS:

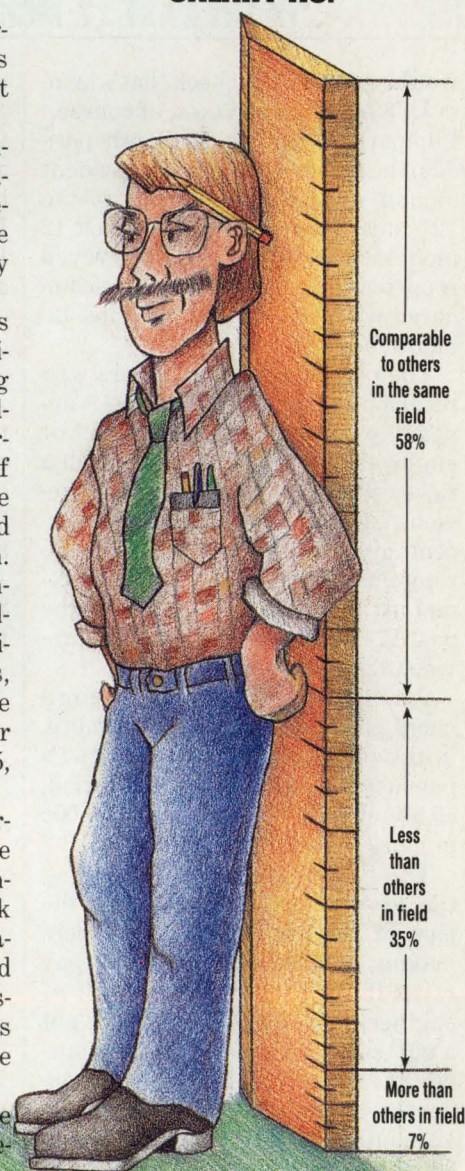

# SALARY SURVEY

## WHAT PERCENTAGE RAISE DID YOU RECEIVE . . .



would mean a raise check that's leaner by \$325—before taxes, of course. Comparing the two 12-month periods, the smaller raise is most evident among engineers receiving 9% to 12% salary increases. In the past 12 months, 9.7% of engineers surveyed reported that range of increase compared with 16% for the previous 12-month period.

The percentage of engineers who received scant raises of 1% to 4% appears to be on the rise. About 35% of engineers surveyed reported such a raise compared with 30% for the previous 12-month period. Still, the percentage of engineers receiving mid-range pay increases of 5% to 8% remained about the same: 48.6% for the past 12 months vs. 48.3% for the previous 12-month period.

Among the highest paid engineers, those making \$60,000 or more, in the past 12 months, 79.1% got a pay increase. In the previous period, 89.3% of engineers making \$60,000 or more got a raise.

This trend was reversed among the lowest paid engineers. In the past 12 months, 76.9% of engineers making \$40,000 or less got a pay raise. In the previous period, 68% of engineers making \$40,000 or less got a pay raise. Among all readers surveyed, the percentage of respondents who got raises in the previous 12 months was 80.4% compared with 80.7% for the preceding period.

Defense cutbacks and a slowing economy augur even smaller wage increases. For the first time since 1980, salary increases in 1991 may

trail inflation, reports *The Wall Street Journal*. For instance, a survey of 3,000 companies shows an average 5.4% pay raise in 1991, down a bit from an average of 5.5% in 1990. In comparison, the Consumer Price Index rose 4.4% in 1988; 4.6% in 1989; and 5.9% in 1990 (through August)

For the most part, engineers with many years of experience clustered at the top of the salary range. For instance, among those surveyed making \$70,000 or more, 44% had 21 or more years of experience. Of the engineers making \$65,000 to \$69,999, 38% had 21 years in the field, with another third having 17 to 20 years. And among engineers making \$60,000 to \$64,999, 38% had 21 or more years of experience while 24%

had 17 to 20 years in the field.

One way to break through the salary ceiling is to become a manager, said survey respondents. One engineer noted, "It is difficult to advance—i. e., have increased recognition and salary—while staying in a strictly technical career track." Another reader said, "Non-management engineers have a definite top-end salary." Along similar lines, another reader wrote, "The engineering salary levels off after about \$40,000, but the manager's path goes to \$60,000." Another respondent set the plateau higher—"For a design engineer, it's about \$50,000 without being a manager." And the survey bore out this finding—the top of the salary ladder has many more managers than in the lower salary rungs. Among highly paid engineers, those making upward of \$70,000, 31% supervise 10 or more engineers. Another 23% of these engineers supervise 6 to 10 engineers. And 29% supervise one to five people.

Nearly two-thirds of engineers making \$45,000 to \$49,999 aren't supervisors. The salary edge for managers starts to show up in the \$50,000 to \$54,999 range—here, 46% of respondents supervise one to five engineers while 43% aren't managers.

Higher salaries may propel some engineers to move into management—but not all of them are happy about it. And several engineers pointed to lack of career advancement for engineers who stay on the technical track:

• "There is not enough career growth

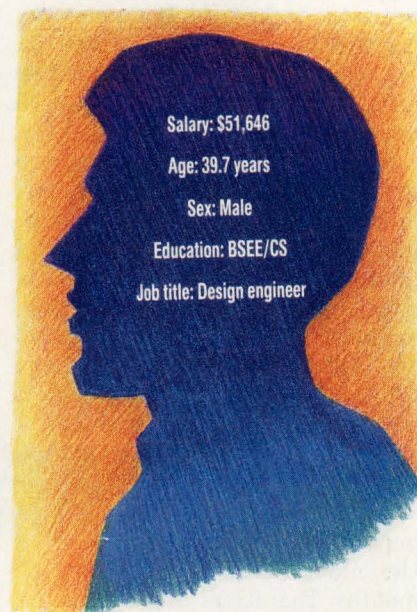

## CLASSIFIEDS

### EMPLOYMENT OPPORTUNITIES

#### ENGINEERING MANAGER

Strong technically minded person needed by New England based producer of printed circuitry. Someone equally versed in PCB design and in mechanical aspects of electronic product design for high volume applications is desired. If you know SMT and CAD, that is a plus. Customer interface and departmental supervision require exceptional communication skills. BSEE and 10 years experience are minimum. If you want a ground floor opportunity in the exciting Additive Polymer Circuit field, please call Jeff Jacquart at 401-463-3180 or fax your resume to me at 401-463-9841.

**DIRECTOR OF QUALITY ASSURANCE:** \$80,000 range. High/Low Voltage Power Supplies. Mil-Std 2000.  
**SALES/MARKETING/PRODUCT MANAGER:** B.S.E.E. Passive Components with technical expertise in hybrids/thick/thin film. Automotive and Commercial Applications.

Contact: J.C. Banks, Excel Associates, P.O. Box 520, Cordova, TN 38018 or call (901) 757-9600 or FAX (901) 754-2986.

**ELECTRONIC-ELECTRICAL ENGINEERS. Nationwide Design/Project/QC/Mfg., Power, Software/Systems, Controls, Circuits, Equipment, Test, Communications, etc.** Contact: John Longberry, Longberry Employment, 913 Main Place, P.O. Box 471, Niles, OH 44446. (216) 652-5871.

#### ENGRS/MGRS

Position available nationwide for experience in Machine Design, Tooling, Automation, Controls, Mfg Engineering etc. Please send confidential resume including current & desired salary, geo. preferences to: Bob Crumpton

**EXECUTIVE RECRUITERS AGENCY**  
P.O. Box 21810  
Little Rock, AR 72221-1810  
(501) 224-7000 (501) 224-8534 (Fax)

### QUALIFIED CANDIDATES

Recruit the Best and the Brightest Talent. Advertise in the Classified section of this publication. For rates and closing dates, call Melinda Ryan at

**(216) 696-7000**

## Bridging today's technology...

Brooktree Corporation is the industry leader in the design, test, and marketing of electronic data conversion and signal processing integrated circuits serving the computer graphics, ATE, and imaging industries. Our DACs, RAMDACs, ADCs, and related products have received wide recognition in the industry for innovation and quality.

### SEMICONDUCTOR/IC OPPORTUNITIES IN SAN DIEGO

We currently have excellent career opportunities in the following areas for semiconductor professionals experienced in CMOS/BiPolar technologies:

#### TEST ENGINEERING MANAGER

Responsible for the test development of new products. High speed digital or mixed signal background desired.

#### TEST ENGINEER

Requires experience with Trillium/LTX, or other mixed signal tester.

#### PRODUCT ENGINEER

Requires industry experience with development and/or manufacturing in a high-volume production environment with experience in characterization or yield analysis.

#### DIGITAL DESIGN ENGINEER

Needed for image signal processing. Must have experience designing CMOS VLSI circuits.

#### ANALOG DESIGN ENGINEER

Will design high performance analog and digital BiPolar products. Must have experience using high performance BiPolar processes.

#### IC LAYOUT DESIGNER

Responsible for planning, layout and verification of custom integrated circuits, in BiPolar or CMOS, from engineering schematics. Must have experience in a full custom design environment using CAD layout verification tools.

#### PACKAGING ENGINEER

Will design and control packaging processes and package materials. Must have experience in a manufacturing and/or assembly environment.

#### APPLICATIONS ENGINEER

Will respond to technical needs of customers. Must have experience with component level design/application in imaging and/or graphics systems.

#### SECTION MANAGER, QA

Coordinate QA support to Brooktree manufacturing operations via implementation of defect prevention systems and monitors. Must have supervisory/management experience with a strong knowledge of QA systems and statistics.

#### PRODUCT MARKETING ENGINEER

Will provide tactical product marketing support. Must be able to maintain technical knowledge of products and develop "sales sensitivity" through direct field exposure.

The above positions require a BSEE or related degree (MSEE preferred) and three plus years' directly related experience.

Brooktree offers a highly competitive compensation and benefits package, including stock participation. More importantly, we provide a work environment where creativity, individual achievement and teamwork are encouraged and rewarded.

If you possess the qualifications for any of these positions and want to join a winning team, please mail your resume and salary history to: **BROOKTREE CORPORATION, Professional Staffing, Dept. ED, 9950 Barnes Canyon Road, San Diego, CA 92121-2790.** We are an Equal Opportunity Employer. M/F/V/H. Principals only, please.

with tomorrow's  
breakthroughs.

**Brooktree®**

## SALARY SURVEY

potential for an engineer who remains in a technical capacity as opposed to an engineering management path."

- "It seems that once an engineer reaches the salary ceiling, he must move into management. I enjoy engineering."

- "You must get into management to increase your salary above the \$60,000 or \$70,000 range, which may be a problem if one really enjoys design work."

- "Companies need to provide more non-management career paths for engineers."

- "The best engineers make less than mediocre managers. It is unfortunate that engineers who create market opportunities for their employers must quit engineering to progress in salary."

- "It is a shame that the management side tends to earn more for what I believe is less skill."

- "I've never seen a 2:1 difference in pay at the same level, but I have seen 2:1 differences in quality and productivity. Ceilings are a crutch for uncomprehending managers."

- "It seems that the farther away one works from the 'hands-on' of a product, the more money one earns. For example, engineers design and develop the hardware/software and mechanical aspects of the product. However, the marketing, sales, and accounting people seem to draw bigger paychecks. Engineering must start paying more to keep engineers in the important design role."

### UPDATING THE RESUME

Besides moving into management, another way to avoid hitting salary or career plateaus is to change jobs. Says one respondent, "I recently got a \$6,000 salary increase by quitting the company I worked for for 11 years and going elsewhere. Companies always seem more willing to pay higher wages to hire people than they are to keep them."

Some job changes aren't voluntary, of course. One respondent said, "Engineering is one of the few professions where you can have too much experience. Most companies hire few (or no) experienced engi-

neers to eliminate highly paid engineers."

Another singled out foreign owned corporations as having "generally low ceilings." Yet another engineer wrote that "supply and demand dictates supply. I see rollbacks in salary because of excess supply."

Another way to lift salary ceilings is to link salaries to profits engineers generate for the company. Along these lines, one respondent said, "I feel that engineers as a whole need to organize and push for salaries commensurate with the profit-making potential of the products they create—including but not limited to guaranteed royalties and residuals enjoyed by artists and writers."

A reader wrote, "I think engineers should be given a small percentage of the profits they generate through the products they create." Another said, "Engineers should be paid more directly for their proven abilities rather than their credentials. My efforts have a tremendous effect on company profitability, yet I am paid considerably less than degreed engineers of comparable experience."

Some engineers surveyed had no complaints about their salaries. In the words of one engineer: "I'm not concerned about money. If they knew how much fun I have at work, they would likely charge me for the privilege of working here." One respondent said, "For the work that I do, I am ridiculously overpaid."

For some, other career concerns overshadowed salary issues. For example, one engineer said, "I have accepted a lower salary to obtain a position I believe I have learned more from." Another wrote, "The more I learn about our own [U. S.] engineering history and the present condition of foreign engineers, the more convinced I am that most of us may be overpaid for what we do."

### A MATTER OF DEGREE

Yet another way to break through the salary ceiling for engineers is to earn an advanced degree. And the survey showed a predictable correlation between post-graduate work and higher salaries. One-third of those surveyed had BSEE/CS de-

grees; nearly 11% have taken post-graduate engineering courses; 9% have an MA/MS degree; about 17% have an MSEE/CS degree; and nearly 4% have a doctorate. In contrast, engineers with BSEE degrees make up 44% of those in the \$40,000 to \$44,999 range and 48% of those in the \$45,000 to \$49,999 range. Among engineers earning \$60,000 to \$64,499, 17% have a doctorate, 24% have master's degrees, 17% have done post-graduate work, and 28% have a BSEE/CS.

Most survey respondents thought their salaries are on a par with others in the field. Overall, 57.6% of respondents felt their salary was comparable to others in the same field with 35% saying their salary was lower; just 7% felt they earned more. Not surprisingly, most of respondents making less than \$35,000 described their salary as being less than others in the same field.

A turning point comes at about \$35,000; respondents at that salary responded more positively—62% of those in the \$35,000 to \$39,999 salary believe that they are paid comparably to others in the same field. Among engineers making \$40,000 to \$44,999, the belief that one is being paid comparably drops to 45.8%, with 50.0% feeling that they are paid less than others in the same field.

Of the engineers surveyed, the most common job description is design engineer (17.3%), followed by senior engineer (15.6%), and project engineer (14.5%). The number of respondents involved with computers and peripherals was 45.4%; test and measurement and instruments, 31.4%; military/aerospace, 30.8%; and components and subassemblies, 29.1%; communications equipment, 22.7%; and industrial controls and equipment, 17.1% (total is more than 100% because respondents could indicate more than one category).

Only 11 women participated in the salary survey, accounting for 3% of the respondents. Among engineers employed, women make up about 6% of the workforce. With so few responses from women, no solid conclusions about salary based on gender can be drawn. □



## CLASSIFIEDS

### CONSULTANTS

#### CONTROL SYSTEM CONSULTING

- Servo design, high performance motion control, synthesis, system performance, simulation, specs, integration, testing
- Electrical, mechanical, hydraulic
- Defense, aerospace, industrial experience

30 East Gate Road                      A.R. Hazelton  
Danbury, Conn. 06811                      (203) 743-7002

#### ELECTRONIC ENGINEERING

- COMPLETE SYSTEM DESIGN
- PLC SYSTEM INTEGRATION
- CONCEPT TO PRODUCTION

**CREATONE**                      128 W. 1st. AVE.  
ROSELLE, NJ 07203  
(201) 241-7373                      FAX (201) 241-7374

#### CONSULTING & PROTOTYPES

##### ELECTRIC MOTORS

BRUSHLESS MOTORS    SWITCHED RELUCTANCE  
STEPPING MOTORS    AC INDUCTION

MAGNA PHYSICS CORP.                      JAMES R. HENDERSHOT  
P.O. Box 78                      TEL: 513-393-9835  
HILLSBORO, OH 45133                      FAX: 513-393-9836

#### ELECTRO-MECHANICAL PRODUCT DEVELOPMENT SERVICES

Design, FEA Analysis, Engineering  
Consulting, Prototypes

Actuators, Alternators, Motors, Solenoids,  
Valves, Voice Coils, Mechatronic Systems

##### EM DEVELOPMENT CO.

1743 Havemeyer, Redondo Beach, CA 90278  
(213) 374-3494

**Increase Your Profits  
By Advertising Your  
Consulting Services in**

**ELECTRONIC DESIGN**

RATES: 6x \$125    12x \$115

For more information, contact:

**Penton Classifieds at  
(216) 696-7000,  
ext. 2520.**

### EMPLOYMENT OPPORTUNITIES

## Is Your Job Too Rigid?

**A**t Texas Instruments, we are identifying highly motivated, talented professionals to drive our expansion in Semiconductors for Rigid (Hard) Disk Drives. You will join a \$6.5 billion company manufacturing and delivering products and services through over 75,000 employees and 50 manufacturing sites worldwide. Current hard disk drive specific products include DSP's, Read/Write Channel IC's, Read/Write Preamplifiers, digital ASIC's, LinASIC(tm)'s, and Memories. Openings currently exist for:

**Hard Disk Drive System/Application Engineering:** - Employ experience designing hard disk drives or semiconductors for hard disk drives to define new product road maps for TI hard disk drive specific semiconductors. Work closely with our customers and field sales support to understand market trends and translate those trends into innovative, leading edge products. Provide system engineering consulting to IC design engineers.

**Hard Disk Drive Marketing:** - Utilize experience in semiconductor marketing to drive product development activities and market standard, semi-custom, and custom products. Conduct market research and competitive analysis to support new product business plans. Execute market communication and positioning plans.

**Apply Today!** - All positions require a minimum Bachelor's degree in Electrical Engineering with a preference for Master's or MBA's. At least three years direct experience with the hard disk drive market is needed. Candidates must also possess excellent oral and written communication skills. Send resume to: **Roger G. Coker, Texas Instruments, P.O. Box 655303, M.S. 8333, Dept. ED/9, Dallas, Texas 75265.**

An Equal Opportunity Employer M/F/H/V

**TEXAS**   
**INSTRUMENTS**

# CUSTOM ICs SHRINK A 1-GHz SCOPE TO A PORTABLE, AFFORDABLE SIZE

JOHN NOVELLINO

**T**hanks to a handful of custom ICs, the size and cost of 1-GHz digital oscilloscopes need no longer be intimidating. The HP 54510A packs two channels, each with a 1-Gsample/s digitizing rate and 8-bit vertical resolution, into a portable package 16.75 by 14.3 by 7.65 in. Price is less than \$11,000.

The scope has a horizontal (timing) accuracy of 100 ps and a vertical (voltage) accuracy of 1.25% of full scale. Record length is 8 ksamples. In accordance with HP policy, front-end filters limit the one-shot bandwidth to 250 MHz, one-fourth the sample rate, to avoid aliasing.

For high-throughput applications, the HP 54510A uses a segmented-memory scheme called the successive single-shot mode. In this mode, the instrument automatically captures, stores, and labels a waveform, then re-arms the trigger. The scope can capture 300 512-point waveforms at rates up to 400 waveforms per second. When it has captured and stored the specified number of waveforms, the 54510A transfers the data to an external computer.

Each channel has its own flash analog-to-digital converter. These custom bipolar devices were chosen because they offer lower noise, higher vertical accuracy, and better linearity than the charge-coupled devices commonly used in very fast scopes, HP says. Six other custom ICs replace whole boards full of components in memory, time-base, triggering, processing, and other circuitry. The analog-to-digital memory IC, for example, reduces board space for that function by 98% and cost by 50%. And the 25,000-device time-base IC slashes space and cost for that function by 90% and 85%, respectively.

As a result, one board holds all the scope's acquisition and processing circuitry. Overall, the HP 54510A takes up one-tenth the board space that would be needed by conventional circuitry. The drastic reduction in

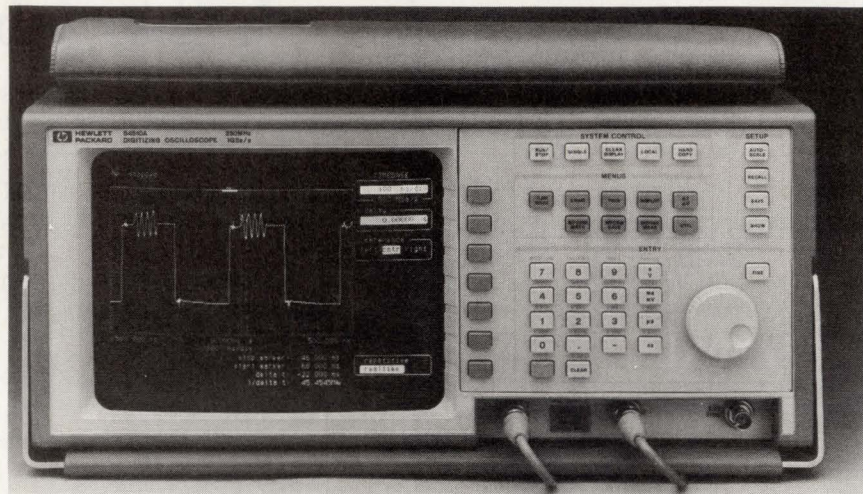

component count should greatly increase reliability, with HP estimating a 30,000-hr. mean-time-between-failure rate. The company provides a three-year warranty.

Instead of a peak-detection circuit for glitch capture, the HP 54510A employs a time-qualified trigger that can grab even one-shot glitches down to 1.75 ns. The trigger specifies a "pattern present less than..." statement. The user selects a time slightly smaller than the nominal length of the pulse being studied.

The instrument's advanced logic triggering, including state triggering, helps designers uncover complex digital problems. For instance, the user can specify a pattern on any two of three inputs, with the third input used as a clock. The qualification may call for a trigger on the rising or falling edge of the clock input, and when the pattern is or is not present, as desired.

Another trigger option is event-delayed mode, in which the user qualifies the trigger by an edge, pattern, time-qualified pattern, or state. The delay can be a number of occurrences of a rising or falling edge of any of the three inputs (channels 1 and 2 and the external trigger). The delay can be from one to 16 million occurrences, and the maximum edge counting rate is 70 MHz. TV trigger-

ing is also available.

The HP 54510A contains the features designers have come to count on in digital scopes. Autoscaling sets up the instrument with one keystroke. The unit makes 17 automatic pulse-parameter measurements, including peak-to-peak voltage, pulse width, period, and delay. The results can be displayed as a snapshot, or can be continuously updated, or continuously updated with statistics. In the statistical mode, the display shows the maximum, minimum, average, and most recent values.

Users can choose from two forms of limits testing. They can create waveform templates in a controller and store them in the scope's memory for later recall and comparison against live waveforms. Or they can set numerical limits on any three selected parameters. The scope will compare input waveforms to the preset limits, without the need for an external controller. If a discrepancy occurs, the unit will save the waveform, output the screen to a hard-copy device, or flag a controller.

The HP 54510A sells for \$10,950, with availability estimated at 8 weeks after receipt of an order.

Hewlett-Packard Co., Colorado Springs Div., P.O. Box 2197, Colorado Springs, CO 80901-2197; (800) 752-0900.

CIRCLE 331

## NEW PRODUCTS

INSTRUMENTS

### SCSI-TO-GPIB INTERFACES FOR SUN-3, VAX 3100

Two IEEE-488 interface kits let users control up to 14 IEEE-488 instruments through the SCSI ports of the Sun-3 or the DEC VAXstation 3100 and Micro-VAX 3100 workstations. The GPIB-Sun3-S kit includes the NI-488M multi-tasking software package, a set of fast, high- and low-level functions that are installed in the operating system as a Unix device driver. Similarly, the GPIB-VAX3100-V kit includes the GPIB11 software, which is installed in the VAX operating system. Both interfaces come with the GPIB-SCSI con-



troller box with a 64-kbyte RAM buffer. This external box is an 8-bit micro-computer that implements the full range of IEEE-488 controller functions. The buffer stores data from the SCSI port so the SCSI bus is free to do other tasks while the box communicates with another device. The GPIB-Sun3-S kits costs \$1420. The GPIB-VAX3100-V package sells for \$1420 with driver software on a 3.5-in. diskette, and \$1520 with software on a TK50 cartridge tape.

*National Instruments, 6504 Bridge Point Pkwy., Austin, TX 78730-5039; (800) 433-3488 or (512) 794-0100.*

**CIRCLE 332**

### BENCHTOP ASIC TESTERS FEATURE 50-MHZ CLOCKS



A pair of benchtop ASIC verification systems offer 50-MHz clock rates, 16 programmable timing generators with 500-ps resolution, per-pin programmability, and 2-ns pin-to-pin skew. The ETS 200 (to 192 pins) and the ETS 270

(to 512 pins) handle multiple formats, including window and edge compare, and allow continuous edge placement with no dead zones. Users can program split-cycle I/O operation on all pins. Standard vector memory is 16 kwords, with 64 kwords optional. The units are available 60 days after receipt of an or-

der. Prices vary with pin count and options. A 128-pin ETS 200 with 16-kword vector memory, programmable power source, DUT board, and software interface simulators, costs less than \$39,000.

*Hilevel Technology Inc., 31 Technology Dr., Irvine, CA 92718; (714) 727-2100. **CIRCLE 333***

# I G B T

## BUILT TO SURVIVE EASY TO USE

Performance Proven Tough

- Maximum Short Circuit Capability Insures "Latch Free" Operation
- The Best VCE(sat) Switching Loss Trade-Off
- Square Switching SOA Minimizes "Snubber" Cost
- Reduces Operating Power Losses
- Testing Proves That Powerex IGBT The Toughest On The Market
- 15-20 Khz/600A-1200V
- Lower Overall System Design and Manufacturing Costs
- Higher Efficiency
- Voltage Drive Reduces Design And Manufacturing Costs
- The Newest Technology Available
- Faster Switching
- Smaller Packaging

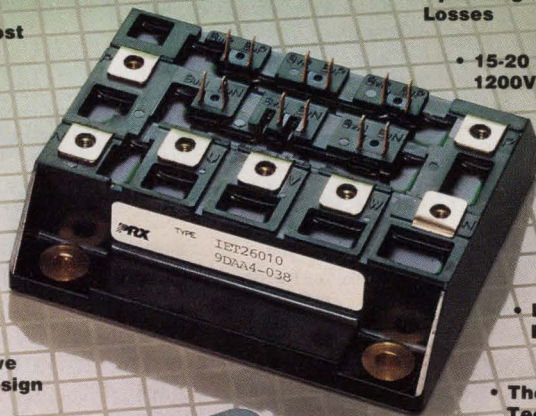

A continuing investment for the advanced products of tomorrow.

Call THE POWER LINE at 1-800-451-1415.

# POWEREX

Joint Venture Corporation of Westinghouse, General Electric, and Mitsubishi Electric  
Hillis Street, Youngwood, PA 15697  
FAX 412-925-4393

CIRCLE 127

## TOOL MONITORS, MANAGES COMPANY'S ACTIVITIES

**B**y combining graphics, text, and an object-oriented database on a PC, the Mind's Eye software tool lets users monitor such activities as financial modeling, statistical analysis, and drafting and engineering activities. The tool, from Mind's Eye Inc.,

runs on an IBM-compatible PC with a minimum of 512 kbytes of RAM and 5 Mbytes of hard-disk space.

The computer-aided management (CAM) tool fulfills all the functions of a support manager. It stores information in its database that helps to make man-

agement decisions, either at the time of entry or at some later date. Any information entered can be used for all operations. Hence, data never has to be re-entered in other parts of the program.

An example of how the tool can be used is in a manufacturing plant. Assume that a compound is the result of mixing some ingredients. The percentage of each ingredient is fixed, but each has a little leeway. Mind's Eye can monitor the percentage of each ingredient and, if any falls outside its allowable range, the tool could either stop the process or signal a manager to let him know about the situation.

The same tool can be used to keep track of all the employees in a company. It can keep a hierarchical tree of all employees so the manager knows what all the employees' job functions are and who they report to. It can also keep track of the company's financial information. By entering the costs of certain data, whether it's materials, labor, or something else, Mind's Eye makes sure that the manager is always on top of the situation.

Mind's Eye uses standard interface methods to select functions. The first method is through a border menu. This menu typically invokes a pop-up menu or dialogue box to carry out commands. The dialogue box lets the user enter data prior to invoking the function. Then the information can be reused without being retyped. A user-programmable hot-key can also invoke a command.

Mind's Eye contains an extensive set of context-sensitive, on-line help functions. These can be invoked at any point in the system by simply hitting one of the function keys. It will retrieve help information pertaining to the task from which it was called.

Data, including macros, can be imported from other programs such as Lotus 1-2-3 and dBase. Images can be drawn directly in the tool's editor with a mouse and a built-in component library.

Minimum system requirements include an 80286-based PC running at 12-MHz, MS-DOS 3.3, a color EGA monitor, and a two-button mouse. Most printers and plotters are supported. Mind's Eye is available in either custom or shrink-wrap versions. The shrink-wrap tool costs \$995 and will be available in the first quarter of 1991.

**Mind's Eye Inc., 36 Commerce Way, Woburn, MA 01801; (617) 935-2679. **CIRCLE 334****

■ RICHARD NASS



## BUGS IN YOUR SCASI?

*We'll help you find those little critters.*

You can look for them all by yourself, and eventually find them. It might take you two or three days, though. Or, you can do what our customers have done, and use the SCASI analyzer from Pacific Electro Data to find them in a matter of minutes.

Our newest product, the PED4500, is a laptop portable SCASI bus analyzer. It guides you through the menu-driven setup, capture and display. SCASI bus changes are time-stamped and stored in the 32,768 word SRAM buffer. Captured data is displayed as a signal listing,

timing wave form, or as easy-to-understand SCASI commands, status and messages.

With optional emulation installed, you can use the PED4500 as SCASI initiator or target.

The PED4500 laptop analyzer features a 16Mhz 286 processor, 40 MB hard drive, VGA-compatible gas plasma display, and 101-key keyboard. Or, if you wish, you can buy the analyzer as a drop-in card and software and install it in your own PC. The choice is yours!

Yes, we have just the tool to find those little critters. In fact, the PED4500 can locate the bugs easier and more cost-effectively than anything else around. And you can carry it everywhere you go.



Call For  
FREE  
SCASI  
Reference Guide

**PACIFIC  
PACIFIC  
PACIFIC  
PACIFIC ELECTRO DATA**

14 Hughes, Suite B205, Irvine, CA 92718

Tel: (714) 770-3244 1-800-676-2468 Fax: (714) 770-7281

CIRCLE 138

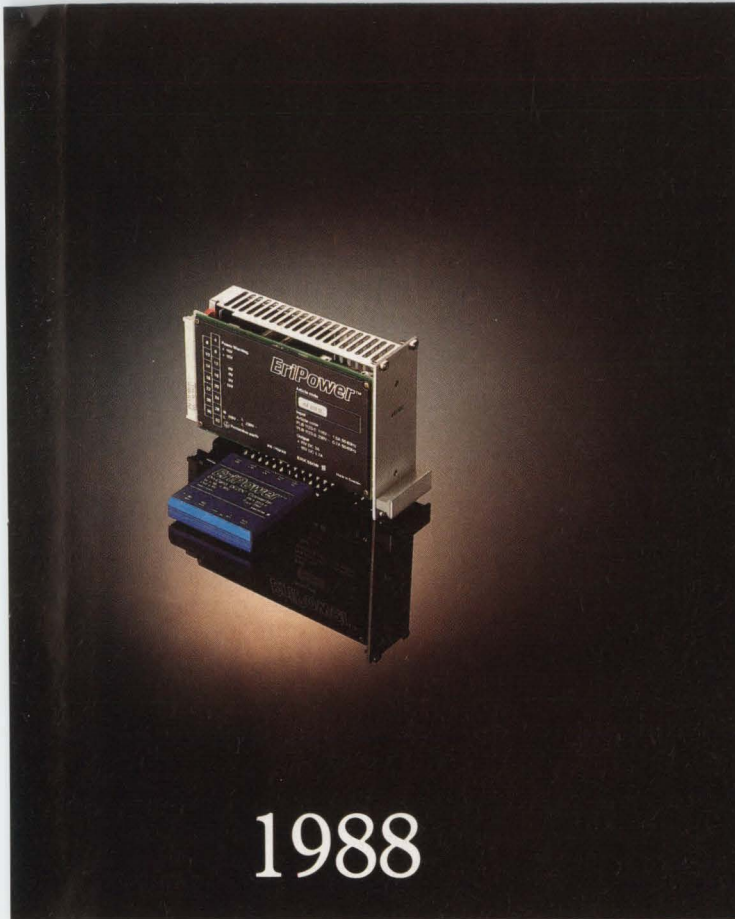

1988

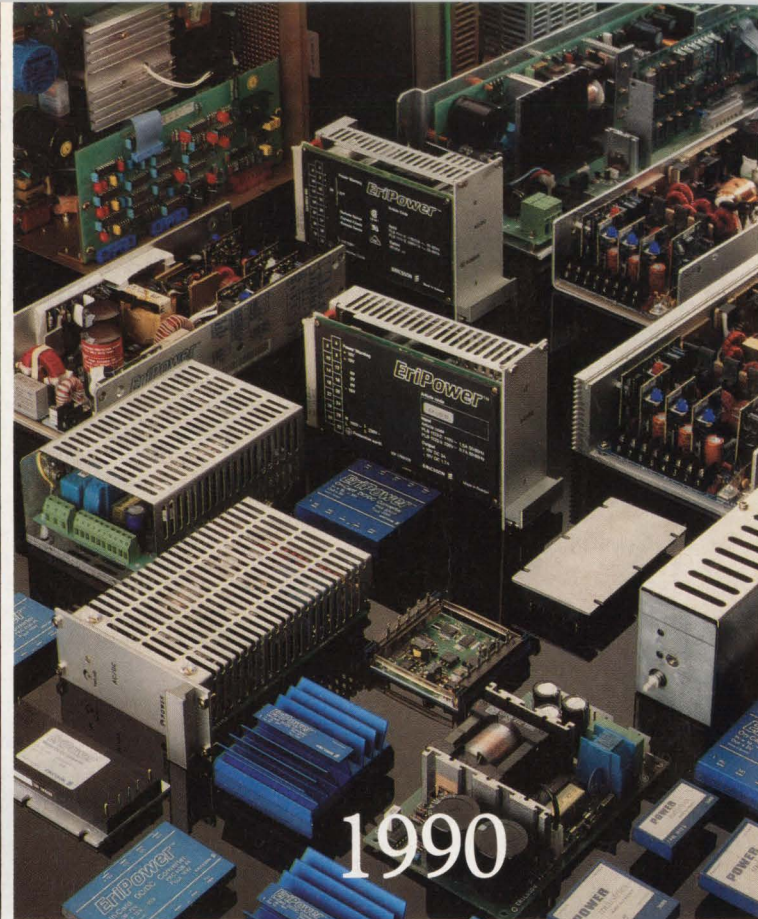

1990

# The power product range from Ericsson has been putting on weight recently

Right up to 1988, the Ericsson range of high reliability power supplies was limited - Eurocard PLB switchers, and the remarkable PKA miniature, high frequency DC/DC converters. Remarkable, because they marked the advent of the power component concept as complete modules

which can be used to realize distributed power architecture.

Since then things have changed.

Today the EriPower™ range includes DC/DC

converters from 0.3Watts to 200Watts. And most of them are also designed to be paralleled for system upgrading.

What's more, the AC/DC power supply range covers 60 Watt to 400 Watt requirements with Eurocard

and open frame power supplies. When necessary, there's even a full custom design facility for high volume users.

In short, the EriPower™ range has put on a lot of weight, and there's now a product for almost every need.

But one or two things haven't changed. For example, EriPower™ power supplies still meet or exceed international standards for safety and RFI/EMI emission. They all represent the very latest technology of their kind. And they all feature the demanding MTBF performance you'd expect of products from Ericsson - over 200 years in some cases. After all, as a part of one of the world's leading telecommunications companies, reliability is a vital part of our culture.

As you've probably realized, the EriPower™ range is expanding fast. Simply get in touch and we promise to keep you up to date, as we continue putting on weight.

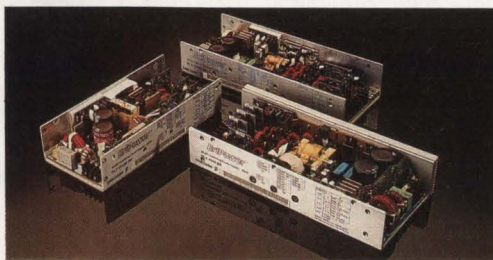

The new PLY: versatile 150-400W open frame switchers



PKY: 30-200W modules have standard pinning/footprint (Note: Only available in Europe)

- |               |  |
|---------------|--|
| Sweden        | Ericsson Components AB, Stockholm, Tel: (08) 721 70 59 Fax: (08) 721 70 01         |
| Australia     | Ericsson Components Pty Ltd, Victoria, Tel: (03) 480 12 11 Fax: (03) 484 36 45     |
| France        | Ericsson Composants SA, Gyancourt, Tel: (01) 30 64 09 00 Fax: (01) 30 64 11 46     |
| Hong Kong     | Ericsson Components AB, Wanchai, Tel: (05) 756 756 640 Fax: (05) 834 5369          |
| Great Britain | Ericsson Components AB, Coventry, Tel: (0203) 553 647 Fax: (0203) 225 830          |
| Italy         | Ericsson Components Srl, Milano, Tel: (02) 551 81 597 Fax: (02) 545 97 31          |
| Norway        | Ericsson Components A/S, Oslo, Tel: (02) 6 50 190 Fax: (02) 644 138                |
| United States | Ericsson Components Inc, Richardson, TX, Tel: (214) 480 83 00 Fax: (214) 680 10 59 |
| West Germany  | Ericsson Components GmbH, Engen, Tel: (07733) 500 10 Fax: (07733) 5927             |

CIRCLE 104

**ERICSSON** 

# IEEE-488



Control any IEEE-488 (HP-IB, GP-IB) device with our cards, cables, and software for the PC/AT/386, EISA, MicroChannel, and NuBus.

## VGA SOFTWARE IN PUBLIC DOMAIN

Software that compares the performance of VGA adapters fitted to IBM PC AT and compatible computers has been placed in the public domain by New Dimension International Ltd. The program was created using the firm's "Superscape Alternate Realities" 3D and "walk-through" image-generation system, and presents an automated 3D sequence of color images that rotate and move independently on screen. While the 100-s sequence is running, a timer determines the screen refresh rate, and at the end of the cycle calculates the average number of screen updates the computer system has achieved in one second. The result is presented in frames/s—the higher the number the better the system's performance. The company hopes its "3D-Bench" program will be adopted as a standard benchmark. It says that the benchmark is dependent on a number of factors, including the processor type such as 80286, 80386 or 80486, its clock speed, the use of cache memory, the internal architecture of the PC, whether an 8- or 16-bit bus is used, and the efficiency of the VGA card. The presence of a floating-point co-processor doesn't affect the result. The program is non-interactive, thus the reference point used to create the benchmark is fixed. No restrictions have been placed on use of the program which may be bundled with hardware or used by manufacturers to provide a continuous display during exhibitions or in showrooms. New Dimension also offers to write customized demonstrations and environments to order.

*New Dimension International Ltd., Zephyr One, Calleva Park, Aldermaston, Berkshire, RG7 4QW, United Kingdom; 44 734 810077. CIRCLE 335*

## NEW PRODUCTS

SOFTWARE

## ROMABLE OS SIMPLIFIES EMBEDDED PC DESIGN

Providing MS-DOS 3.2 functionality, a ROM-DOS operating system, ROM-DOS, can operate from within ROM or boot a system from a floppy- or hard-disk drive. The software can easily be modified to optimize the package for a particular application and includes support for ROMable EXE files. The RXE option allows users to take EXE files generated by most software languages and place the file in ROM and execute from within the ROM; only the program data is loaded into RAM. Since

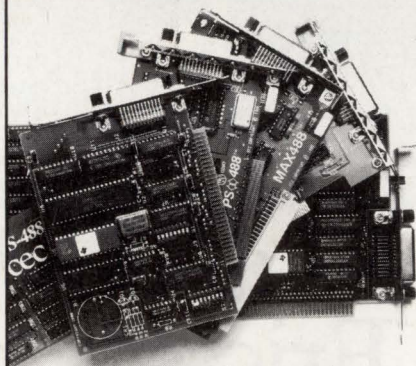

You get fast hardware and software support for all the popular languages. A software library and time saving utilities are included that make instrument control easier than ever before. Ask about our no risk guarantee.

most DOS programs are composed of 80 to 90% code, running a program as an RXE file uses much less RAM than running standard EXE programs. The ROM-DOS ROMable operating system requires minimal memory space. For example, with all functions included, it takes about only 34 kbytes of ROM; and when running, it needs just 14 kbytes of RAM. A mini-BIOS that requires just 3 kbytes of ROM is also available for embedded-systems applications. The mini-BIOS provides support for a remote console (via a serial port). It also features a hardware timer and serial ports. A ROM-DOS developer's kit is also available from Datalight. The developer's kit sells for \$495. Unit prices for the ROM-DOS ROMable operating system are \$6 per copy in quantities of 5000.

*Datalight Inc., 17505 68th Ave NE, Suite 304, Bothell, WA 98011; Roy Sherrill, (206) 486-8086. CIRCLE 336*

## ADA DEBUGGER JOINS FORCES WITH EMULATOR

Merging debugging and emulation into one package, the TEKDB/Ada source-level debugger has been integrated with the Tektronix MV6820 emulator and TekDB monitor. This integration now makes it possible for the product to provide a real-time execution environment for testing and debugging Ada software. With all of the emulator's features incorporated into TekDB/Ada, extensive monitoring and control of the target environment is now possible. One of TEKDB/Ada's most powerful features, the Performance Analyzer can be used to quickly pinpoint hot spots in the Ada run-time code. Each performance run is summarized with a histogram showing the relative amount of execution time for each Ada module or memory range. Since the program executes in real time, modifications can be made quickly and evaluated. TekDB/Ada uses the IEEE-695 common-object format to transfer object modules that are output from a cross compiler. The TEKDB/Ada source-level debugger is available on VAX/VMS, VAX/Ultrix, and Sun-3 host-computer systems. Prices for the VAX version of TEKDB/Ada range between \$3850 and \$7900. The Sun version of the TEKDB/Ada source-level debugger is priced at \$3850. Delivery takes two weeks after receipt of order.

*Tektronix Inc., Microprocessor Development Products, P.O. Box 12132, Portland, OR 97212; (800) 245-2036. CIRCLE 337*



Free:  
Informative  
catalog 800-234-4232  
Applications help (617) 273-1818



**Capital Equipment Corp.**  
Burlington, MA. 01803

CIRCLE 90

CIRCLE 97 →

## SPEEDY MILITARY DRAM ACCESSES IN 70 NS

Compliant with Mil-Std.-883C, the EDI44256Cxxx and 411024Cxxx dynamic RAMs offer the shortest access times of any military-grade CMOS DRAM. The 44256 comes in a 256-kword-by-4-bit organization, while the 411024 versions are 1-M-by-1 devices. Both can access in as little as 70 ns. Additional speed grades of 80-, 100-, 120- and 150-ns access times are also available.

The by-4 memory can be housed in either a 20-pin 300-mil sidebraced ceramic DIP or a ceramic small-outline J-leaded package. Double the number of package options are available for the by-1 version of the CMOS DRAM—in addition to the 20-lead SOJ package, the chip can be had in an 18-lead sidebraced ceramic DIP, 20-pin ceramic zig-zag in-line package, or a 20-lead ceramic flatpack.

Both versions of the megabit chip include three refresh modes—row-address-strobe (RAS) only, hidden refresh, and column-address-strobe before RAS. The DIP-housed version of the by-1 memories also offers a test-en-

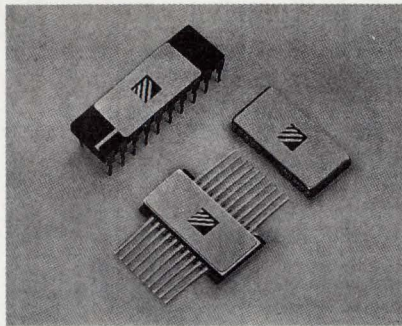

able function that reduces chip test time.

When the function is activated, the memory array is divided into four quadrants that can be tested in parallel. All inputs and outputs are TTL-compatible. The chips operate from a standard 5-V power supply.

Samples of all versions are available from stock. Prices for the military units start at \$253 in 100-unit lots.

*Electronic Designs Inc., 42 South St., Hopkinton, MA 01748; Kay Ritter, (508) 435-2341* **CIRCLE 338**

■ DAVE BURSKY

## CHIP SET TRIMS BOARD SPACE FOR MIPS CPU

Aimed at replacing 40 or more standard logic circuits, a five-chip set provides most of the support logic required by the R3000 CPU from Mips Computer Systems to implement a workstation-like motherboard. The MIPSET chips from LSI Logic operate at clock frequencies of either 20 or 25 MHz and directly support the LR3000 CPU and its associated 3010 floating-point math unit.

Included in the chip set are the LR3201 reset and interrupt controller, the LR3202 bus controller, LR3203 DRAM controller, LR3204 DRAM data controller, and the LR3205 block-transfer controller. Although there are five basic chips, multiple copies of the 3204 DRAM data controller are required since each of the chips contains only an 8-bit slice of the data bus. The DRAM controller supports from 2 to 64 Mbytes of 80-ns memory and 2-way interleaving.

The block-transfer controller includes a 16-bit direct-memory-access channel for an Ethernet support chip. It also includes three 8-bit channels for SCSI, parallel, and floppy-disk-drive I/O support.

Each channel includes an 8-word by 32-bit bidirectional FIFO for data buffering. By separating the direct CPU control from the rest of the system, LSI has created a local expansion bus it calls the L-bus, to which the memory and various I/O functions can be attached.

Additional support chips are required to add serial I/O ports and a real-time clock. A complete 10-chip set—the five chips plus three additional 3204s as well as the R3000 CPU and 3010 FPU—sells for \$704 (20-MHz) or \$1097 (for the 25-MHz version) in 1000-set lots.

*LSI Logic Inc., 551 McCarthy Blvd., Milpitas, CA 95035; Brian Halla, (408) 433-8000.* **CIRCLE 339**

■ DAVE BURSKY

## 1- AND 2-KBIT EEPROMS OFFER 10-YR GUARANTEE

A guarantee that data will be retained for ten years after 1,000,000 read-write cycles per word is offered by SGS Thomson Microelectronics (STM) for its ST93CS56 and ST93C46A serial EEPROMs. They have capacities of 1 kbits and 2 kbits, respectively. The devices are made with STM's specially developed CMOS-F3, a 1.5- $\mu$ m, single-metal, single-polysilicon process. Extra process stages are added to allow implementation of non-volatile memory cells. The 8-pin-packaged chips include built-in electro-static protection, with all inputs designed to withstand 2 kV as prescribed by test method 3015 of MIL-STD 883. Operation is from a single 5-V supply. Suggested applications include TV and radio tuners, telephone dialer memories, and cordless-phone sets.

*SGS Thomson Microelectronics Ltd., Planar House, Globe Park, Marlow Bucks, SL7 1YL United Kingdom.*

**CIRCLE 340**

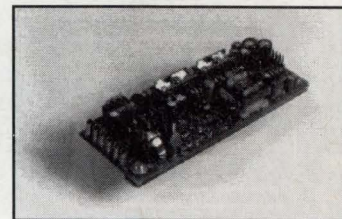

### LapTop Power Supply

- Extremely Small Size
- Multiple Output Volts
- 3 Step Batt. Charger
- High Efficiency-80%
- Light Weight - 110 gm



For Information call  
1 - 800 - 233 - 9973

CIRCLE 144

Systems/USA

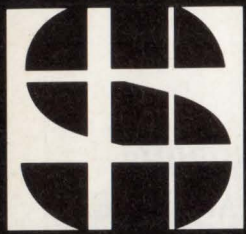

Conference & Exposition

# Find the latest design solutions you need at Systems/USA

## The OEM Computer Technology Conference & Exhibition for Systems Design and Integration

### Design Solutions

Find the design and integration solutions you need to keep up-to-date with the latest technological advances. Systems/USA is the only show dedicated to getting technical and engineering professionals together with original equipment manufacturers (OEMs) of subsystems... all under one roof.

### State-of-the-Art Technology

Participate in the interactive technology conference where systems integration experts will provide you with vital information on technological advances and trends. Session topics include:

- High-Performance ICs
- Input Technologies
- Software Developments
- Storage Technologies
- Display Technologies
- Power Sources
- Buses & Boards
- Military Electronics
- Output Technologies

### New Product Announcements

See new products, technologies and applications introduced by both leading and emerging-growth companies within the computer technology industry.

### 150+ Exhibitors

Active displays from 150+ companies will coincide directly with the topics being addressed in the conference sessions.

### Management Issues

Industry leaders will address business developments within the systems integration industry, with emphasis on total quality in the workplace.

## Systems/USA

February 11-13, 1991  
Anaheim Convention Center  
Anaheim, California

Sponsored by the  
**American Electronics Association**  
5201 Great America Parkway, Santa Clara, CA 95054

*Mail this coupon, or fax it to  
(408) 970-8565, today!*  
**For more information or to  
register by telephone,  
call (800) 873-1177 ext. 300.**

CIRCLE 159

**YES! I want to find design solutions at Systems/USA.**

- Please rush me complete details and attendee information.
- Please rush me complete exhibitor information.
- Please send \_\_\_\_\_ FREE tickets for me and my colleagues.

Name \_\_\_\_\_ Title \_\_\_\_\_

Company \_\_\_\_\_ Address \_\_\_\_\_

M/S \_\_\_\_\_ City \_\_\_\_\_ State/Zip \_\_\_\_\_

Telephone (\_\_\_\_\_) \_\_\_\_\_ Fax (\_\_\_\_\_) \_\_\_\_\_

Return this coupon to: **Systems/USA**, American Electronics Association, 5201 Great America Parkway, Santa Clara, CA 95054 or fax it to (408) 970-8565.



## NEW PRODUCTS

PACKAGING & PRODUCTION

### HIGH-DENSITY SOCKETS EASE PQFP HANDLING

Two-piece sockets for plastic quad flat-pack (PQFP) ICs feature 0.025-in. contact centerline spacing and a low 0.375-in. profile above the board. The PQFP is easily inserted into the cover, which contains protective slots for aligning

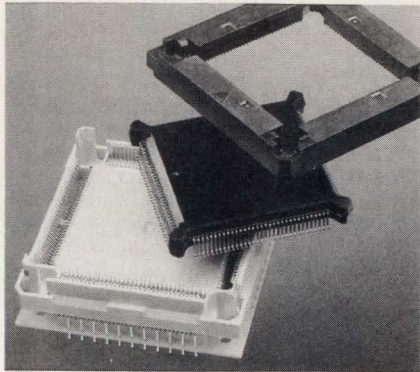

and separating IC leads. The cover sub-assembly is then snapped into place over the housing. Sockets come in 100- and 132-position sizes. A 100-position socket costs about \$8.62 in lots of 1000. The 132-position version costs about \$10.35 in similar quantities. Delivery is in four to six weeks.

AMP Inc., P.O. Box 3608, Harrisburg, PA 17105-3608; (800) 522-6752.

**CIRCLE 341**

### SMART COOLING FAN VARIES RPMs WITH TEMP

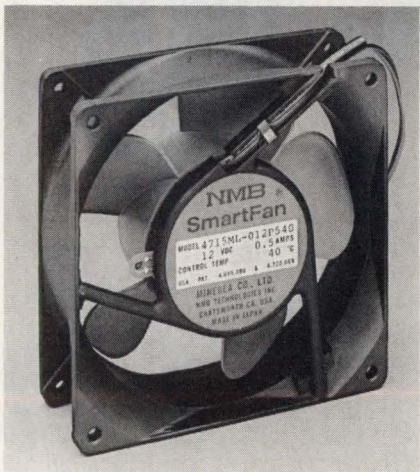

Containing a closed-loop temperature-regulating system, the SmartFan automatically controls the cooling air flow. That lets the fan hold the temperature within an equipment enclosure relatively constant against fluctuations in room temperature, system power dissipation, flow resistance, and altitude.

Since most systems, especially computers, are rarely packed to maximum capacity, the fans would typically run at less than maximum speed, and thus last longer and produce less noise. De powered, the SmartFans can be had in four sizes—4.7-in.<sup>2</sup> by 1.5-in. thick, as well as others that are 3.1-, 3.6- or 4.7-in.<sup>2</sup>, all with a thickness of 1 in. Price for the 4.7-in.<sup>2</sup> by 1.5-in. unit is \$15 in quantities of 5000. Delivery is from stock.

NMB Technologies Inc., 9730 Independence Ave., Chatsworth, CA 91311; (818) 341-3355. **CIRCLE 342**

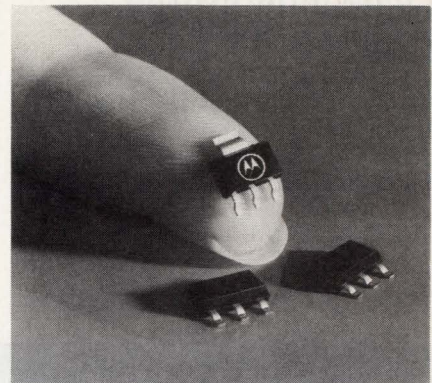

### FLEX-CIRCUIT MATERIAL WITHSTANDS HARSH USES

Harsh, high-temperature environments are no match for R/flex 1100 flexible-circuit material. The polyimide-based circuits reduce space and

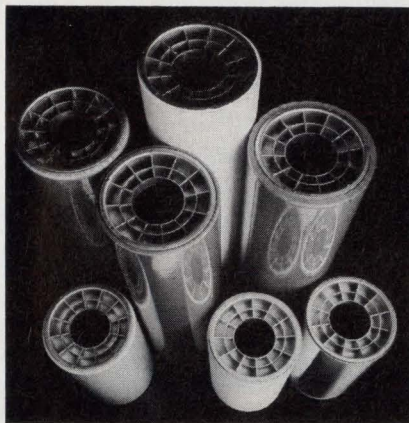

weight requirements as well as improve system reliability in many applications. Thanks to their high chemical resistance, low moisture absorption, and good dimensional stability, the materials withstand very adverse conditions. Two roll widths—24 in. by 250 ft. and 500 mm by 250 ft.—are available. Typical availability is three weeks. Pricing is based on configuration and quantity.

Rogers Corp., Circuit Materials Div., Box 4000, Chandler, AZ 85244; (602) 786-8284. **CIRCLE 343**

### PACKAGE BOOSTS SMT FOR POWER TASKS

With the addition of a surface-mounted package with medium-power capability, Motorola hopes to accelerate the use of surface-mounted technology in applications such as small motors, disk drives, switching-power-supply drivers, and others. The SOT-223 package is

capable of 800-mW power dissipation on an FR-4 glass-epoxy pc board, and up to 1.6 W on ceramic substrates or aluminum-backed boards. The package ensures level mounting, which means better thermal conduction. Several small-signal transistors are planned for the package now, with more by 1991. Call the company for pricing and delivery.

Motorola Inc., MD Z201, 5005 E. McDowell Rd., Phoenix, AZ 85008; (602) 244-3742. **CIRCLE 344**

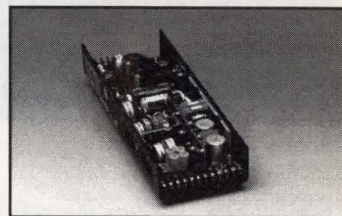

**acdc electronics**

#### RMC Series

- One to Four Outputs
- High Reliability
- Two Year Warranty
- No Minimum Loads
- Optional Auto-Select

**ASTEC**

For Information call  
1 - 800 - 233 - 9973

CIRCLE 145

## NEW PRODUCTS

PACKAGING & PRODUCTION

### LIGHTGUIDE SYSTEM PROTECTS OPTICS

Fiber-optic cable can now be routed and protected properly with the use of the Lightguide enclosure system that is available from the Tyton Corp. The Lightguide enclosure system prevents

accidental cuts and kinks of the cable as well as the signal losses that result from such cuts and kinks. Included with the enclosure system are connectors with the correct bend radii and various horizontal and vertical transitions. These included connectors ensure effective signal transmission while using

minimum space. The connectors feature quick-release covers. This handy feature provides users with simple re-entry into the system. Call the manufacturer for pricing and availability.

**Tyton Corp., P.O. Box 23055, 7930 N. Faulkner Rd., Milwaukee, WI 53223; (414) 355-1130** **CIRCLE 345**

PLDesigner V1.2 - Partitioning Solution Menu

System Name : CPU EXIT

Possible Solutions:                      Attempted : 35692                      Found : 165

⇒ 1	2 x P300, P20RP6, 3 x P16R8	560ma	60ns	\$20.84
2	2 x P300, P20RP4, 3 x P16R8	560ma	60ns	\$20.84
3	2 x P300, P20RP8, P16R4, 2 x P16R8	560ma	60ns	\$20.84
4	2 x P300, P20R6, 3 x P16R8	455ma	60ns	\$21.29
5	2 x P300, P20R4, 3 x P16R8	455ma	60ns	\$21.29
6	2 x P300, P20XRP6, 3 x P16R8	530ma	60ns	\$21.36
7	2 x P300, P20XRP10, P16R4, 2 x P16R8	530ma	60ns	\$21.36
8	2 x P300, P20XRP4, 3 x P16R8	530ma	60ns	\$21.36
9	2 x P300, P320, 3 x P16R8	390ma	60ns	\$21.45
10	2 x P300, P320, P16R4, 2 x P16R8	390ma	60ns	\$21.45

Possible Devices:

P16R8 P16R6 P16R4 P16U8R P20RP8 P20RP6 P20RP4 P20RP10 P16RP8  
P16RP6 P16RP4 P20X8 P20X4 P20X10 P20R8 P20R6 P20R4 P20XRP8  
P20XRP6 P20XRP4 P20XRP10 P320 P20U8R P300 P300C P119R6 P119R4  
P119R8 P119R6 P119R4 P119R8 P22V10R P600 P20RA10 P16R8 P20RS8  
P20RS4 P20RS10 P331 P32UX10R P900 P330X P330 S39V18X S39V18 ...

PLDesigner uses your design philosophy when scanning its library of over 2500 different parts. Possible devices have architectures appropriate to implement the design. Attempted solutions are the combinations of possible devices. Of these combinations, 165 viable solutions were found. You can then choose from the top ten implementations displayed. Power consumption, propagation delay and estimated cost given for each solution ensure that the final implementation you select is the most rigorous solution for your design problem.



## PLD Solutions – As Easy As Multiple Choice.

**Only PLDesigner automatically generates multiple solutions for your design.**

Whether you're new to PLD design or not, you'll benefit from PLDesigner's exclusive Architecture Mapping.

First enter, synthesize, and simulate your design using any combination of Minc's high-level language, schematic entry, or unique timing diagram entry. PLDesigner then automatically optimizes your design and selects the optimal device architectures, giving you solutions you may not have considered. Pick from the top ten solutions and PLDesigner will automatically

make pin assignments and, if required, automatically fit your design into multiple devices.

The intelligence of PLDesigner lets you concentrate on your design, without becoming an expert on hundreds of device architectures.

To make PLD design as easy as multiple choice, call for your free PLDesigner demo disk now.



6755 Earl Drive  
 Colorado Springs, CO 80918  
 719-590-1155 FAX 719-590-7330

CIRCLE 98

## HIGH-LEVEL 4-20-MA XMTR OFFERS 0.25% ACCURACY—EXTRA FEATURES

The process-control industry will not abandon its love for the 4-20-mA analog data and control signal loops. As a result, Analog Devices is adding the AD694 high-level 4-20-mA IC transmitter to complement the AD693. The AD694 takes a high-level control signal (0-to-2 V or 0-to-10 V), usually from a computer-driven DAC, and converts it to a 4-20-mA current loop. Typically, in these applications, it will be transmitting a control signal to a linear actuator. Its mate, the AD693, takes millivolt-level signals from sensors and transmits them as 4-20-mA signals to a host processor's analog front-end data-acquisition system. (By letting 4 mA equal signal-zero, the host can differentiate between no-signal and signal-zero.)

Total error—over temperature—as a percent of span runs a maximum of 0.45% for the premium B grade, twice that for the A grade. Maximum nonlinearity runs 0.005% and 0.015% for the two grades, respectively. The chip offers a number of features not previous-

ly available on an IC transmitter. They include the ability to run off single or split supplies from a minimum of 4.5 V to a maximum of 36 V—and output compliance voltage is within 2 V of the supply. An input amplifier buffers the signal and can provide gain or convert the output current (from a current-output DAC) to a voltage. The chip's reference can provide either 2 or 10 V via pin-strapping. Internally, the chip creates the 4-mA offset which may be turned off for those who prefer 0-to-20-mA operation. In addition, the transmitter's open-collector alarm circuit warns of open-loop conditions or noncompliance of the output voltage. While not mandatory, the IC may be operated with an external pass transistor to minimize self-heating. Depending on performance grade, and whether for the commercial- or industrial-temperature range, the price each in 100s runs between \$3.50 and \$7.85 each.

Analog Devices Inc., 181 Ballardvale St., Wilmington, MA 01887; (508) 658-9400. **CIRCLE 346**

■ FRANK GOODENOUGH

## FASTEST ANALOG MUX SETTLES IN 30 NS

The MX-850 analog multiplexer from Datel is 12 times faster than any other available device. Although most designers take multiplexers pretty much for granted, Datel saw a demand for fast precision devices—with guaranteed specifications—in applications ranging from imaging to multi-channel analog I/O boards. Their MX-850 is a hybrid, and switches 20-V pk-pk input signals at up to 10 MHz and settles the output to within 0.1% of final value in 35 ns maximum. Crosstalk at 10 and 1000 kHz for 20-V pk-pk signals runs -100 and -92 dB maximum, respectively. It drops to -71 dB for 10 MHz with 5-V pk-pk inputs, and -62 dB for a 3-V pk-pk 20-MHz signal. Large-signal 3-dB bandwidth is 80 MHz minimum and nonlinearity is 0.001% of full scale. Power dissipation is a linear function of switching rate: 300 mW at 2 MHz and 1500 mW at 10 MHz. In quantities of 100, the commercial-grade MX-850MC goes for \$90 each. The military grade is \$15 more.

Datel Inc., 11 Cabot Blvd., Mansfield, MA 02048; Bob Leonard. (508) 339-3000. **CIRCLE 347**

## DUAL COMPARATOR RESPONDS IN 14 NS

Aimed for use as a dual-line receiver for system backplanes, the LT1015 dual high-speed comparator sports a propagation delay of just 10 ns with 20 mV of overdrive. However, this device in its 8-pin DIP also lends itself to other fast comparator applications such as high-speed differential line receivers, pulse-height/pulse-width discriminators, and timing and delay generators. It can also operate as a window comparator. The chip's output-stage design virtually eliminates power-supply glitching during transitions, minimizing instability and crosstalk in multiple-line use. A true latch-pin, with a setup time of only 2 ns, lets the comparators capture data much faster than the actual flow-through response time. Moreover, unlike earlier TTL-output comparators, it can slew slowly. The LT1015 uses 70 mA maximum from a single 5-V supply. In quantities of 100, the commercial-grade device in a plastic DIP goes for \$4.20 each.

Linear Technology Corp., 1630 McCarthy Blvd., Milpitas, CA 95035-7487; Bill Reutelhuber (408) 432-1900. **CIRCLE 348**

## LVDT/RVDT CONVERTER FITS IN UNDER 1 IN<sub>2</sub>

A 12-bit, tracking LVDT or RVDT (linear variable differential transformer or rotary variable differential transformer) to digital converter has been squeezed into a 26-pin hermetically sealed package just 0.8 in. by 1.0 in. From ILC Data Device Corp. (DDC), the DTC-19305 will handle either type of transducer in the feedback loop of position-control systems. Accuracy runs 0.15% of fullscale + 1 LSB, and repeatability and differential linearity are maximums of 1 and 0.5 LSB, respectively. Closed-loop bandwidth is 47 Hz and settling time for a half-scale step is 120 ms max. The converter interfaces easily with microprocessors, provides an output flag for converter malfunction as well as over and underrange conditions. Power drain is 15 mA max. from  $\pm 5$ -V. In quantities of 1-9, the commercial-grade unit is \$245.

ILC Data Device Corp., 105 Wilbur Pl., Bohemia, NY 11716; Bill Cullum (516) 567-5600. **CIRCLE 349**

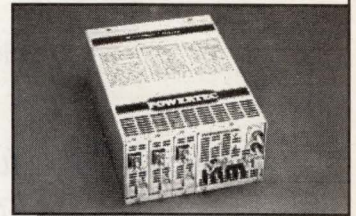

### POWERTEC

#### 6A,B,C Series

- Compact Size
- (5" x 8" x 11")
- Auto Current Sharing
- 210 W Auxiliary
- UL, CSA & VDE



For Information call  
1 - 800 - 233 - 9973

CIRCLE 146

# Electronic Design

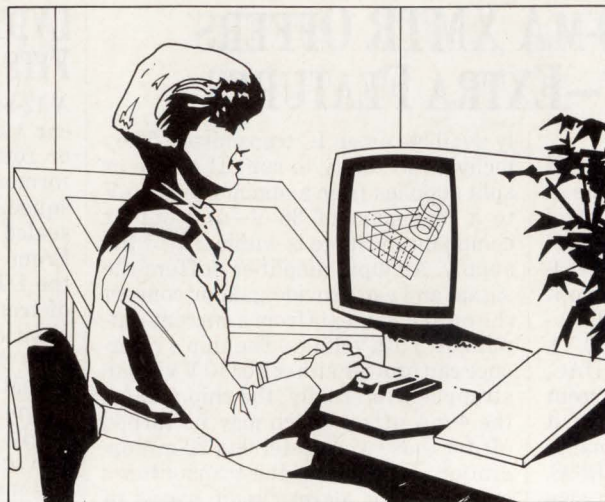

## **targets your mailings to 150,000 design and development engineers**

Highly-educated engineers and managers in the electronics original equipment market.

*Select by: Job function, type of industry, project responsibility, purchasing influence, employment size, and geography.*

**Guaranteed 99% deliverable 100% BPA audited  
circulation**

*Ideal prospects for your next direct mail campaign*

**Penton  
Lists**

**CALL LITA PATTON AT 216/696-7000  
(ext. 2525) FOR YOUR FREE CATALOG.**

# ELECTRONIC DESIGN

## DIRECT CONNECTION ADS

New Products/Services Presented By The Manufacturer.  
To Advertise, Call JEANIE GRIFFIN At 201/393-6080

**FREE  
Demo Disk**

## SCHEMA III

### MOST POWER OF ANY PC SCHEMATIC CAPTURE PACKAGE

Unlimited hierarchies, ASCII input, 7000+ unique parts, library customization, user defined manager, color selections, online HELP, many nelist formats, TIFF, AutoCAD block, & PostScript outputs and much more!  
**ONLY \$495**

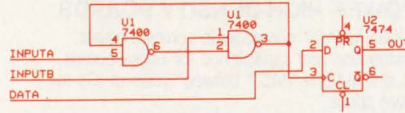

**1-800-553-9119**

Free 800 Support

30 Day Guarantee

FAX: (214)783-9072 BBS# (214)231-1350  
OMATION CIRCLE 284

## Again, "Best Value" in PCB Design.

Tango sets the pace in PC-based circuit board design with an easy-to-use, pop-up menu interface and powerful features including: 1 mil resolution; full SMT support; DRG; PostScript™ output; fast, high-completion auto-routers; and photoplot previewing. Configure your personal PCB design station from our selection of entry-level and expert tools, starting at just \$595.

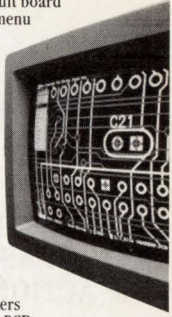

## Tango™

For the second year in a row, engineers have rated Tango the "Best Value" in PCB design at CAD Showdown '90. Rich functionality, one year's updates, free tech support and BBS, plus our 30-day guarantee. Call today.



**FREE EVALUATION PACKAGE**

**800 433-7801** 619 554-1000 619 554-1019 Fax

ACCEL™ Technologies ■ 6825 Flanders Drive ■ San Diego, CA 92121 USA  
International prices may vary. Contact us for the distributor nearest you.  
**ACCEL TECHNOLOGIES CIRCLE 271**

SEE US AT WESCON BOOTH 423

## FREE MAXI/PC DEMO DISK

**\$995  
PCB CAD  
SOFTWARE**

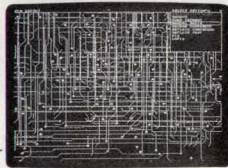

MAXI/PC integrated software includes schematic capture, layout, autorouting, and outputs. 30 day, money back guarantee.

For your free demo disk and brochure, call today or circle the reader service number.

**1-508-692-4900** PCB CAD SOFTWARE

**RACAL RACAL-REDAC**

238 Littleton Road, P.O. Box 365  
Westford, MA 01886-9984

RACAL-REDAC

CIRCLE 251

☆☆☆☆  
"The Best 8051 Emulator"

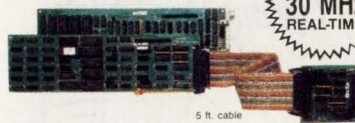

**NEW  
30 MHz  
REAL-TIME**

## 8051

SEE EEM 89/90  
Pages D 1324-1326  
See us at Wescon  
Booth 1762

PC based emulators for the 8051 family

8031, 8032, 8051, 8052, 80C152/154/321/451/452/51FA/51GB/51S/517/53S/537/552/562/652/851, 80532, 83C451/552/652/751/752/851, 8344, 87C451/552/751/752, 8751, 8752, DSS000 + CMOS ... more.

- PC plug-in boards or RS-232 box.
- Up to 30 MHz real-time emulation.
- Full Source-level Debugger w/complete C-variable support.
- 48 bit wide, 16K deep trace, with "source line trace."
- "Bond-out" pods for 8051, 83C552, 83C451, 83C652, 83C751, 80C515/80C517, 83C752.

Prices: 32K Emulator 8031 \$1790; 4K Trace \$1495\*

CALL OR WRITE FOR FREE DEMO DISK!

Ask about our demo VIDEO

**NOHAU** CORPORATION (408) 866-1820  
51 E. Campbell Avenue  
Campbell, CA 95008  
FAX (408) 378-7869

NOHAU

CIRCLE 256

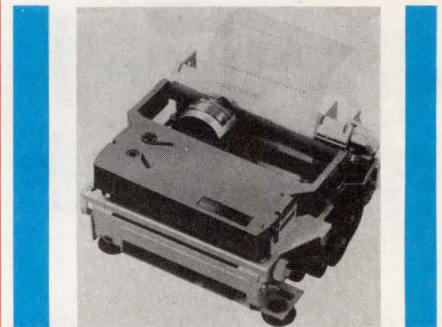

## PRINTERS WITH IMPACT

Citizen dot matrix impact printer mechanisms provide for the perfect low-cost solution for point-of-sale, data logging, etc. Avail. in 23, 28 or 40 columns, serial or parallel, w/sprocket feed, auto-cutter & journal winder options. Fast (120 cps) & reliable (over 50 million char. head life). Also avail. in stand-alone versions.

**MELFESS FIVE, INC.**  
12304 Santa Monica Blvd., #121, Los Angeles,  
CA 90025. 800/533-2297.

MELFESS FIVE

CIRCLE 278



## Custom Molded Plastic Parts

- Competitive prices — long or short runs
- Custom close tolerance molding to 3.5 ounces
- Insert and threaded parts a specialty
- Complete mold design and tooling facilities

FAX BLUEPRINTS OR CALL  
FOR A FREE CATALOG

**JACO**  
JACO MANUFACTURING

468 Geiger Street  
Berea, OH 44017  
Ph: (216) 234-4000  
FAX: (216) 234-7007

CIRCLE 252

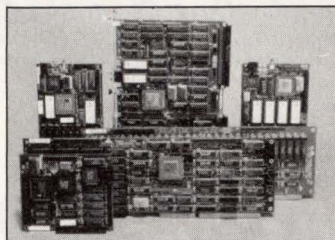

## SC/FOX™ Embedded-System Computers

SC/FOX VME SBC (Single Board Computer) 18 MIPS, 60 MIPS burst, general-purpose, slot-1 Master/Slave System Controller. Up to 640K bytes 0-ws static RAM, 1 SCSI, 1 ptr. 2 serial ports. Uses 16-bit Harris RTX 2000.

SC/FOX PCS (Parallel Coprocessor System) 15 MIPS, 50 MIPS burst, general purpose PC/AT/386 plug-in board, 32K to 1M byte 0-ws static RAM, multiple PCS operation, SCSI option. Uses Harris RTX 2000.

SC/FOX SBC (Single Board Computer) 18 MIPS, 60 MIPS burst, Stand-alone operation. Eurocard size, 1 ptr, 1 serial port, up to 512K bytes 0-ws static RAM, 2 50-pin user connectors, SCSI option. Uses Harris RTX 2000.

SC/FOX PCS32 (Parallel Coprocessor Systems) 32 15 MIPS to 70 MIPS, general-purpose PC/AT/386 32-bit plug-in board with 64K to 1M byte 0-ws static RAM. Uses 32-bit SC32 Forth microprocessor.

Ideal for embedded real-time control, data acquisition, or high-speed processing. Forth software and utilities included, C optional. OEM pricing.

**SILICON COMPOSERS INC.** (415) 322-8763  
208 California Avenue, Palo Alto CA 94306

SILICON COMPOSERS

CIRCLE 291

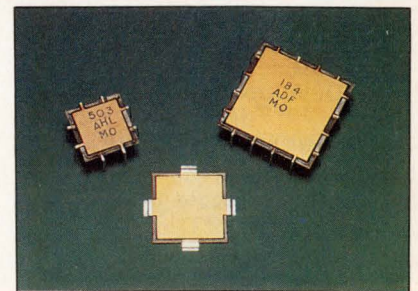

## CUT PGA/PLCC NOISE

MICRO/Q® 3000 capacitors reduce noise associated with PGA and PLCC devices. Designed to be mounted under the device, take no extra board space. Can be used under MPUs, Gate Arrays, and ASICs. Choose from 25V, X7R, and P3J dielectrics. Available in both thru-hole and surface mount versions. Several sizes available to fit all devices.

**ROGERS CORP.**  
2400 South Roosevelt St., Tempe, AZ 85282  
Telephone: (602) 967-0624

ROGERS

CIRCLE 264

**FREE SAMPLE**

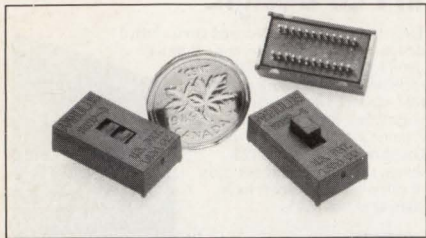

**8PDT "BYTE WIDE" SWITCH  
HIGH DENSITY .050" PINOUT  
SNAP ACTION GOLD CONTACTS**

Circle reader service number for free sample and complete information about Annulus High Density Switches.

**ANNULUS**  
HIGH DENSITY SWITCHES

ANNULUS TECHNICAL INDUSTRIES, INC.  
1296 Osprey Drive, P.O. Box 7407, Ancaster  
Ontario, Canada L9G 4G4  
Phone: (416) 64808100. Fax: 648-8102

ANNULUS TECHNICAL INDUSTRIES CIRCLE 260

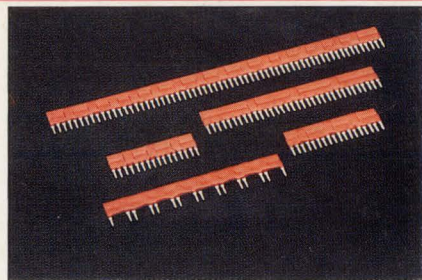

**SUPPRESS NOISE,  
POWER HIGH DENSITY BOARDS**

MAGNA/PAC™ components combine power distribution and capacitance for dense boards. Mount MAGNA/PAC™ between rows of ICs to save space.

- Effective decoupling ZIP arrays
- Capacitance up to 3.0 μF per linear in.
- Reduce noise over a wide frequency range
- Equalize voltage on dense boards

**ROGERS CORP.**

2400 S. Roosevelt St., Tempe, AZ 85282  
Telephone: (602) 967-0624

ROGERS CIRCLE 270

**IEEE 488**  
*Easiest to use,  
GUARANTEED!*

- IBM PC, PS/2, Macintosh, HP, Sun, DEC
- IEEE device drivers for DOS, UNIX, Lotus 1-2-3, VMS, XENIX & Macintosh
- Menu or icon-driven acquisition software
- IEEE analyzers, expanders, extenders, buffers
- Analog I/O, digital I/O, RS-232, RS-422, SCSI, modem & Centronics converters to IEEE 488

**Free Catalog & Demo Disks**  
(216) 439-4091



IOtech • 25971 Cannon Rd. • Cleveland, OH 44146

IO TECH CIRCLE 268



**'488 CONTROL FOR YOUR MACINTOSH II**

- Control any instrument in minutes.
- Supports BASIC, Pascal, C and Hypertalk.
- HyperCard utilities included.
- Software library. Risk free guarantee.



Capital Equipment Corp.  
Burlington, MA. 01803

Informative catalog 800-234-4232  
Applications help (617) 273-1818

CAPITAL EQUIPMENT CIRCLE 272

*There is a Difference.  
Lifetime Free Updates*

**EP-1  
\$349**

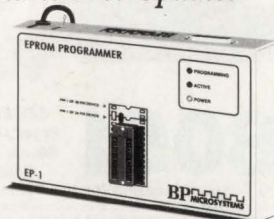

A programmer is not just another programmer. That is why BP Microsystems is committed to bringing our customers the highest quality programmers at an affordable price. A good example of this commitment is the EP-1 EPROM Programmer. The EP-1 supports virtually every 24- or 28-pin E/EPROM. And, all of our programmers include lifetime free software updates and an unconditional money back guarantee.

**BP MICROSYSTEMS**  
1-800-225-2102

BP MICROSYSTEMS CIRCLE 275

**X.25 SDLC  
QLLC HDLC  
ADCCP PAD**

- C source code
- ROM-able
- Full porting provided
- No OS required



**GCOM, Inc.**  
41 E. University  
Champaign IL 61820  
(217) 352-4266

Specialists in Computer Communications  
FAX 217-352-2215

GCOM CIRCLE 273

**Cross-Assemblers** from \$50.00  
**Simulators** from \$100.00

**Cross-Disassemblers** from \$100.00  
**Developer Packages**  
from \$200.00 (a \$50.00 Savings)

**Make Programming Easy**

Our Macro Cross-assemblers are easy to use. With powerful conditional assembly and unlimited include files.

**Get It Debugged--FAST**

Don't wait until the hardware is finished. Debug your software with our Simulators.

**Recover Lost Source!**

Our line of disassemblers can help you re-create the original assembly language source.

**Thousands Of Satisfied Customers  
Worldwide**

PseudoCorp has been providing quality solutions for microprocessor problems since 1985.

**Processors**

Intel 8048	RCA 1802.05	Intel 8051	Intel 8096.196k
Motorola 6800	Motorola 6801	Motorola 68HC11	Motorola 6805
Hitachi 6301	Motorola 6809	MOS Tech 6502	WDC 65C02
Rockwell 65C02	Intel 6800.65	Zilog Z80	NSC 800
Hitachi HD64180	Mot. 68k.8.10	Zilog Z8	Zilog Super 8

• All products require an IBM PC or compatible.

For Information Or To Order Call:

**PseudoCorp**

716 Thimble Shoals Blvd, Suite E  
Newport News, VA 23606

(804) 873-1947 FAX:(804)873-2154

PSEUDOCORP CIRCLE 274

**Don't Get Zapped!**

High inrush current can **destroy** your sensitive VAX CPUs and peripherals in **less time** than it takes to flip a switch.

**THE SOLUTION?**

Power up with **Z-LINE TPC 115-10 MTD™** the **smallest** power distribution and control system available.

**POWER UP WITH ---**

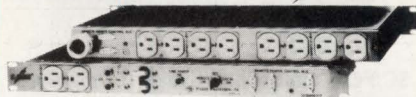

Our proprietary **Multiple Time Delay™** circuitry **sequences** your power-up to **protect** your systems from the spikes and surges, EMI & RFI, that **destroy** your hardware and **erase** your data. And our remote on/off and emergency shutdown **gives** the power control back to you.

All Pulizzi Engineering MTD™ controllers are compatible with DEC and UPS systems.

**PRICES FROM \$453 TO \$317**

**DON'T WAIT UNTIL IT HAPPENS, CALL TODAY!**

**PULIZZI ENGINEERING INC.**  
3260 S. Susan Street, Santa Ana, CA 92704-6865  
(714) 540-4229 FAX (714) 641-9062

PULIZZI ENGINEERING CIRCLE 257



**FREE!**  
**120  
Page  
Catalog**  
-----  
**"Optics  
for  
Industry"**

**ROLYN OPTICS** supplies all types of "Off-the-Shelf" optical components. Lenses, prisms, mirrors, irises, microscope objectives & eyepieces plus hundreds of others. All from stock. RolyN also supplies custom products & coatings in prototype or production quantities. Write or call for our free 120 page catalog describing products & listing off-the-shelf prices. **ROLYN OPTICS CO.**, 706 Arrowgrand Circle, Covina, CA 91722, (818) 915-5707 & (818) 915-5717. TELEX: 67-0380. FAX: (818) 915-1379.

ROLYN OPTICS CIRCLE 261

## Compact and Reliable



E-T-A's PC Mountable Circuit Breaker is available for vertical or horizontal mounting. This Full Feature breaker is trip free/foolproof and 100% tested and calibrated. Ratings from 0.1A to 10A. Snap-in or panel mount available.

**E-T-A** CIRCUI**T** BREAKERS

7400 N. Croname Rd., Chicago, IL 60648  
Phone: (708) 647-8303 Fax: (708) 647-7494

E-T-A<sup>®</sup> CIRCUI**T** BREAKERS

CIRCLE 254

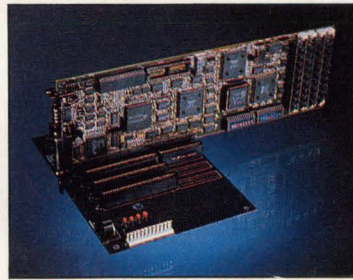

### 20 MHz 286 CPU CARD — \$595

- 2 Serial/1 Parallel Ports
- Up to 4 Meg DRAM: 0/1 WS
- Low Power 6-layer PCB
- Award BIOS — Norton SI 21.1
- Optional 287 Co-Processor
- Small Size (XT-Form Factor)
- User Replaceable Battery
- Made in USA
- \$595 qty 10 w/OK



295 Airport Road  
Naples, FL 33942  
TEMPUSTECH

**TEMPUSTECH, INC.**  
1-800-634-0701

CIRCLE 256



### LOW COST INTERFACE CARDS FOR PC/XT/AT

#### RS-485/422 Card [PC485] \$95/125

- Serial Async. Communication up to 4,000ft; 2 or 4 wires; NS16450 UART;
- COM1-4; Max. Baud Rate 56KB. High speed version (256KB) - \$165.
- Dual drivers/receivers; Handles 64 devices; Compatible with most comm. S/W.
- DB9 or phonejack. Sample programs included. Optional S/W (w/ source) - \$150

#### IEEE-488 Card [PC488A] \$145

- Includes DOS Device Driver and sample Communication program in BASIC.
- Additional sample programs in C, Pascal & Assembly - \$ 50.
- Selectable IRQ (1-6). DMA channel 1 or 2. Up to four boards per computer.
- Compatible with most IEEE-488 Software packages for IBM-PC.
- I/O Addresses and Control registers compatible with NT's GPIB-PCIIA.

#### IEEE-488 Card [PC488C] With Built-In Bus Analyzer \$445

- Software Support for BASIC, QuickBASIC and GWBASIC.
- Additional libraries for C, Pascal, FORTRAN, Assembly available - \$50 (all)
- Powerful menu-driven BUS ANALYZER runs in the background while 488 programs or commands are executed. Features Program Stepping, Break points, real time bus data capture (4K buffer), instant screen toggling.
- Complete Controller / Talker / Listener capability. Based on NEC-7210.
- Compatible with NT's GPIB-PCII card. (TMS-9014 based card - \$345).

#### Stepper Motor Card [PCL738] \$395

- Capable of independent and simultaneous control of up to 3 stepper motors.
- Programmable speed from 3.3 PPS to 3410 PPS; Built-in acceleration control.
- Step Position Read-back; Opto-isolated outputs; Crystal based timing.
- Pulse/Direction or CW/CCW pulse output. Includes 8 bit digital I/O port.



**B&C MICROSYSTEMS INC.**  
750 N. Pastoria Ave., Sunnyvale, CA 94086 USA  
TEL: (408) 730-5511 FAX: (408) 730-5521

B&C MICROSYSTEMS

CIRCLE 259

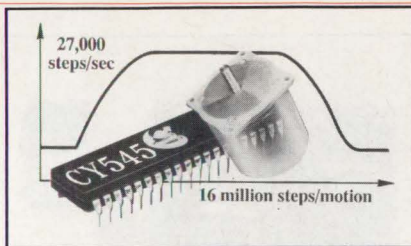

### STEP MOTOR CONTROL

27K steps/sec! 16 Million steps!

New CY545. Rates up to 27K steps/sec, up to 16 million steps per single motion. Separately programmable start rate, accel/decel rate, and max rate. Pulse & direction output. External jog mode and limit switch detection. Serial or parallel interface, LED/LCD & Thumbwheel interface lines, and more. ASCII commands. Supports 64K external memory. CMOS 40-pin DIP. \$75 each (\$25/1000). Credit Cards OK.



**Cybernetic Micro Systems**  
PO Box 3000, San Gregorio CA 94074  
(415) 726-3000 • Fax: (415) 726-3003

CYBERNETIC MICRO SYSTEMS

CIRCLE 276



### UNIVERSAL PROGRAMMER IS DEPENDABLE AND SOFTWARE UPGRADABLE

Sailor-PAL is S/W driven by PC/XT/AT/PS2 or laptops; fast interface thru std parallel printer port; supports thousands of devices including CMOS and EE erasables:

- |              |           |                 |
|--------------|-----------|-----------------|
| ■ 5ns PALs   | ■ EPLDs   | ■ Test Vectors  |
| ■ 10ns GALs  | ■ PEELs   | ■ 4-MEG EPROMs  |
| ■ EP900/1200 | ■ ECLs    | ■ Bipolar PROMs |
| ■ EP1800     | ■ 874X/5X | ■ CMOS PROMs    |
| ■ 87C751/752 | ■ EEPROMs | ■ Xilinx PROMs  |

Other models available.

**ADVIN SYSTEMS, INC.**

1050L East Duane Ave., Sunnyvale, CA 94086  
800-627-2456; 408-243-7000 Fax: 408-736-2503

ADVIN SYSTEMS

CIRCLE 263



### RS232 EE/EPROM, MICRO & MEMORY CARD PROGRAMMER \$345/495

- Programs EE/EProms, Flash EProms, ZPRams, Intel Micros, Memory Cards.
- Stand-Alone Mode for EE/EProms and Memory Card Duplication / Verify.
- All 242832 pin EE/EProms to 8 MBits (upgradable to 32 Megabits).
- Micros: 8741/A, 2/A, 4, 8, 9, 51, CS1, CS1A/B, 52, 53, 55, CS21, CS41, 9761, Fujitsu) - \$145. Eraser/Timer Module - \$50. Gang Module (4 sockets) - \$145. Simultaneously duplicates up to 5 devices in stand-alone mode (with Gang).
- Can be operated with any computer containing an RS-232 serial port.
- User friendly Menu-Driven Interface Program for IBM-PC or Macintosh.
- Full 1 year warranty. Customer support via voice line, fax or dedicated BBS.

### INTELLIGENT ROM EMULATOR \$395

- Emulates 2716 through 27512 EProms with a single unit. Access time 120ns.
- Connects to the standard parallel printer port via a standard printer cable.
- User friendly software. Command set includes: Load(data), Write(data), Display(memory), Type(of EProm), Edit(memory), Fill(memory), Calculator, Reset(target system), Activate(debugging feature), Monitor(selected feature).
- Address Compare with Halt output. Address Snapshot. Trigger input.
- Fast data loading via parallel printer port (64k bytes in less than 10 sec).
- Cascadable up to 8 units. Includes target cable with Trigger/Reset/Halt clips.
- CMOS (stand-alone) model with rechargeable NiCad battery backup: \$495



**B&C MICROSYSTEMS INC.**  
750 N. Pastoria Ave., Sunnyvale, CA 94086 USA  
TEL: (408) 730-5511 FAX: (408) 730-5521

B&C MICROSYSTEMS

CIRCLE 265

## Cross Assemblers

Universal Linker, Librarian

PC/MS DOS, micro VAX, VAX VMS UNIX  
targeting 30 microprocessors

- ★ High speed
- ★ Compatible with chip manufacturer's assemblers
- ★ Powerful macros
- ★ Absolute or relocate code
- ★ Conditional assembly
- ★ \$295 up for MS DOS Packages



811 W. Fifth St.  
Lansdale, PA 19446 U.S.A.

telephone: 215-362-0966  
telex: 4948709 ENERTEC

CROSS ASSEMBLERS

CIRCLE 269

## ELECTRONIC DESIGN SERVICES

- Initial concept through prototype and production
- Design of advanced digital and analog electronics
- Approved programmable gate array design center
- Real - time embedded software - DSP code
- 7,000 square foot facility with fully equipped labs
- 12 year track record of successful product designs
- Designs are warranted Defect Free Forever

**PRESCO** (203) 397-8722

PRESCO

CIRCLE 267

## Analog Circuit Simulation

Completely Integrated CAE from \$95

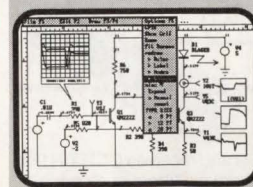

From Schematic Entry through SPICE

Simulation to Post Processing

IsSPICE \$95, the complete SPICE program, runs on all PC's.

IsSPICE/386 \$386, The fastest PC based SPICE program available. Has virtually no circuit size limitations.

SPICENET \$295, a schematic editor for any SPICE simulator. Generates a complete SPICE netlist.

INTUSCOPE \$250, a graphics post processor that performs all the functions of a digital oscilloscope.

PRESPICE \$200, extensive model libraries, Monte Carlo analysis, and parameter sweeping.



Please Write or Call  
P.O. Box 6607 (213) 833-0710  
San Pedro, CA 30 Day Money  
90734-6607 Back Guarantee

INTUSOFT

CIRCLE 262

# RS-422

- RS-422/485
- Selectable Address/IRQ
- Two/Four Wire Operation
- One/Two/Four Port Versions
- Delivery From Stock

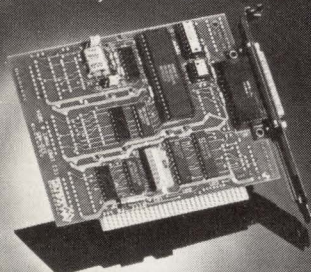

SEALEVEL SYSTEMS INC.  
PO BOX 1808  
EASLEY, SC 29641  
(803) 855-1581

SEALEVEL SYSTEMS

CIRCLE 279

# Design:

Industry-standard language for PLDs



With new ABEL-PLD at just \$895\*.

- 150 PLD architectures supported (over 4000 devices).
- Uses ABEL™ Hardware Description Language (AHDL).
- Intelligent synthesis and optimization.
- Upgradable to full-featured ABEL.

Call for your FREE ABEL-PLD demonstration diskette.  
1-800-247-5700

\*U.S. list price only.



DATA I/O

CIRCLE 275

# Program:

16L8, 20V8, 22V10, 27C020, and 450 other CMOS devices



PLDs and memories with the low-cost 212.

- Memory cards for easy updates.
- Extensive editing capabilities.
- Compatible with JEDEC standard programming files.

Call for your FREE 15-day trial AND ABEL-PLD demonstration diskette.

1-800-247-5700



DATA I/O

CIRCLE 277



## CROSS-32 V2.0 META ASSEMBLER

■ Table based absolute macro cross-assembler using the manufacturer's assembly mnemonics.

■ Includes manual and MS-DOS assembler disk with tables for ALL of the following processors:

1802	64180	6801	8048	TMS320	Z8
37700	6502	6805	8051	TMS340	Z80
50740	65816	6809	8085	TMS370	Z180
7500	COP400	6811	8086	TMS7000	Z280
SUPERR	COP800	68000	8096	TMS9900	MORE...

■ Users can create tables for other processors or ask us, we have many more!

■ Generates listing, symbol table and binary, Intel, and Motorola hexcode.

■ Free worldwide airmail shipping & handling.

US\$199.00 CDN\$239.00



UNIVERSAL CROSS-ASSEMBLERS  
P.O. Box 6158  
Saint John, N.B.,  
E2L 4R6 Canada  
Voice/Fax: (506)847-0681



UNIVERSAL CROSS-ASSEMBLERS

CIRCLE 280

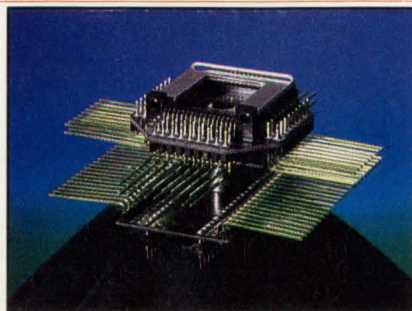

## Quick, Fast Socket Conversion

- Convert-A-Socket™ makes it a snap to convert a production socket to a test socket and vice-versa.
- Complete line of male/female sockets for LCC, PLCC, PGA, PQFP, and DIP circuits.
- A must if you're inserting circuits repeatedly in low insertion force sockets.
- Quick turnaround on custom engineering services, if needed. For a free catalog, contact:



Emulation Technology, Inc.  
2368-B Walsh Ave. Santa Clara, CA 95051  
Phone: 408-982-0660 FAX: 408-982-0664  
EMULATION TECHNOLOGY

CIRCLE 255

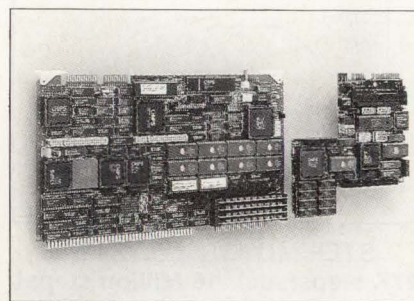

## MULTIBUS™ AT-COMPATIBLE SBC

Multibus 1 is now IBM PC/AT™ compatible with MAT286™, our newest single board solution. MAT286 includes all of the functions of a 10 MHz AT motherboard, plus 2 serial ports, a parallel port, two SBX expansion-module interfaces, up to 512K EPROM/EEPROM/DRAM, and up to 4M of parity-checked, dual-ported DRAM. A piggy-back card, MATxSYSIO™, adds EGA, floppy, and SCSI interfaces. Embed all the guts of an AT, two SBX modules, and more, into Multibus slots!

Phone (408) 253-0250 or write for more information.

Single Board Solutions, Inc.  
20045 Stevens Creek Blvd, Cupertino, CA 95014

Multibus is a registered trademark of Intel Corp.  
MAT286 and MATxSYSIO are trademarks of Single Board Solutions, Inc.  
IBM and PC/AT are trademarks of International Business Machines Corp.

SINGLE BOARD SOLUTIONS

CIRCLE 282

## NEW NEW NEW NEW NEW

# Telecom Design!

MF (R1) or MFC (R2)

TRANSCIVER

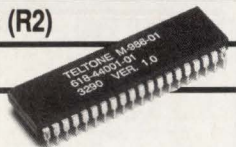

**M-986** transmits and receives CCITT R1 or R2 forward and backward multifrequency signals. For trunk adapters, test equipment, and other applications.

- Single or dual channel versions available
- Versions for North American (R1) or International (R2) toll signals
- Binary or 2 of 6 input/output format
- Complete microprocessor interface
- 40 pin IC, 5 volt power, crystal time base

For more info call: 1-800-426-3926

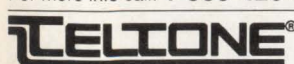

10801-120th Avenue NE, Kirkland, WA 98033  
Phone: 206-827-9626 Fax: 206-827-6050

TELSTONE

CIRCLE 285

Now, you can afford the high precision you really need.

With new YSI Precision Machine-Insertable Thermistors. Tape and reel packaging reduces manufacturing costs and YSI precision gives you the edge in circuit accuracy and reliability. Call 800 343-4357 for information. In Ohio, call 513 767-7241.



YSI Incorporated  
Yellow Springs, Ohio 45387 USA



YSI, INC.

CIRCLE 253

# Little Giant™

C Programmable Controller

This shirt pocket sized computer interfaces directly to the outside world. Use it to control anything. Instantly programmable using your PC with Dynamic C. ROM and battery backed RAM to 1024k bytes. 8 Channel, 10/12 bit, A/D with conditioning. High voltage and current drivers. Battery backed time and date clock. Watchdog and power fail. 4 serial channels. 24 parallel I/O lines. Timers. Integral power supply. Terminations for field wiring. Expansion connector. Plastic or metal field packaging available. OEM versions from \$199.00.

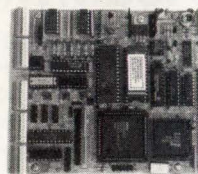

See Us At Wescon '90 — Booth 458  
Z-World Engineering  
1340 Covell Blvd., Davis, CA 95616  
(916) 753-3722  
Fax: (916) 753-5141

Z-WORLD ENGINEERING

CIRCLE 283



# INDEX OF ADVERTISERS

<b>A</b>	
ACCEL Technologies .....	149
Actel Corp. ....	67-70
Advin Systems.....	151
Aerospace Optics.....	41
Aldec .....	16
AMD .....	10-11
American Electronics Association.....	144
AMP .....	58-59
Ampro .....	80
Ancot.....	66
Annulus Technical Industries .....	150
Apex Microtechnology .....	25
Astec .....	143, 145, 147
AT&T .....	51, 79, 126
<b>B</b>	
B&C Microsystems .....	151
Bourns Trimptot.....	153
BP Microsystems .....	150
Burr-Brown .....	123
<b>C</b>	
Capital Equipment Corp. ....	136, 150
Cirrus Logic.....	43
Clearpoint Research.....	29, 111-112
Coilcraft.....	148
Comlinear .....	72-73
Cybernetic Micro Systems .....	14, 151
Cypress Semiconductor .....	Cover IV
<b>D</b>	
Data I/O .....	57, 63, 152
Dialight.....	119
<b>E</b>	
ECM for Wescon.....	154
Emulation Technology .....	152
Enertec .....	151
Ericsson .....	135
E-T-A® Circuit Breakers .....	151
<b>F</b>	
Fenner Industrial Control .....	8
John Fluke Mfg. ....	48
<b>G</b>	
GCOM .....	150

GE Plastics .....	36-37
GigaBit Logic .....	128
<b>H</b>	
Heinemann Electric.....	105
Hewlett-Packard Co. ....	1, 9, 26-27
<b>I</b>	
IBM .....	12-13
Integrated Device Technology .....	35
Intel.....	96
Intusoft.....	151
IOtech .....	150
Isdata .....	88
<b>J</b>	
Jaco Manufacturing Company .....	149
JW Miller Div. of Bell Industries .....	8
<b>L</b>	
Lambda Electronics .....	137-142
Logic Devices .....	65
<b>M</b>	
Melcher .....	116
Melfess Five .....	149
Mentor Graphics.....	6-7
Micro Linear .....	106-107
Micron Technology .....	30
Minc, Inc. ....	146
Mini-Circuits Laboratory, a Div. of Scientific Components Corp.....	15, 18-19, 108, Cover III
Motorola Computer Group.....	20-21, 99-100
Motorola Semiconductor Products .....	2-3
<b>N</b>	
National Instruments .....	120
NCR Microelectronics .....	44-45
Nohau Corp. ....	149
<b>O</b>	
OKI Semiconductor .....	94-95
Omaton .....	149
<b>P</b>	
Pacific Electro Data .....	134
Performance Semiconductor .....	22
Pico Electronics, Inc. ....	53, 118
Powerex .....	132
Presco .....	151
PseudoCorp .....	150
Pulizzi Engineering.....	150

<b>Q</b>	
Qualidyne.....	85
<b>R</b>	
Racal-Redac.....	149
Rogers Corp. ....	114, 149, 150
Rolyn Optics .....	150
<b>S</b>	
Samsung .....	92-93
Sealevel Systems.....	152
Selco Products .....	66
Semiconductor Circuits.....	90
Silicon Composers .....	149
Silicon General.....	155
Silicon Systems.....	102
Simucad .....	38
Single Board Solutions.....	152
Sipex .....	115
S-MOS .....	46-47
Standard Microsystems .....	17
Stanford Research .....	Cover II
<b>T</b>	
Telton .....	152
Tempustech .....	151
Texas Instruments .....	32-33
Toshiba America.....	83
Triquint Semiconductor .....	80
<b>U</b>	
Universal Cross Assembler .....	152
UTMC .....	64
<b>V</b>	
Varta Batteries AG.....	89
Vicor .....	130
ViewLogic Systems.....	54
<b>X</b>	
Xilinx .....	52
<b>Y</b>	
YSI.....	152
<b>Z</b>	
Zenith Data Systems .....	74
Z-World Engineering.....	152

The advertisers index is prepared as an extra service. Electronic Design does not assume any liability for omissions or errors.

## FREE SAMPLE OFFER

- Miniature 3mm Design
- Meets EIA/EIAJ Footprint
- Wave/Reflow Solderable
- High Volume Assembly Compatible
- Industrial, Commercial, Consumer Applications



THERE'S STILL NO EQUIVALENT

BOURNS, INC., 1200 Columbia Avenue  
Riverside, California 92507-2114  
(714) 781-5500

3mm size meets  
EIA/EIAJ standard  
trimmer footprint

Special coating on resistive  
element protects trimmer from flux,  
solder and cleaning processes

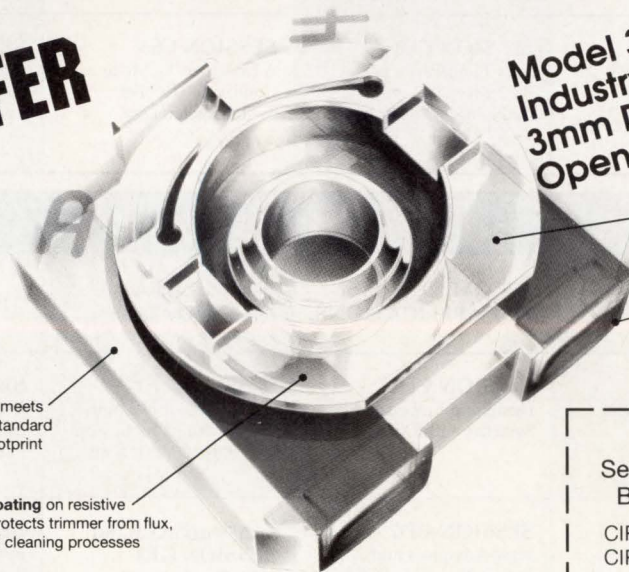

## Model 3363 Industry's Smallest 3mm Design Single-Turn Open Frame Trimmer

Rotor design compatible  
with pick and place and  
automatic adjustment equipment

Lead termination and geometry  
were designed for compatibility  
with all SMT processes

### BROCHURE AND SAMPLE OFFER

Send Me the Free Model 3363  
Brochure and Sample Offer

CIRCLE 116 CALL ME NOW  
CIRCLE 117 SEND LITERATURE



# Wescon

DISCOVER WHAT'S NEW IN DESIGN.  
 SHORTEN YOUR LEARNING CURVE.  
 LEARN FROM INDUSTRY EXPERTS.  
 PLAN NOW TO ATTEND.

Where World Markets Meet

## TUESDAY ■ NOVEMBER 13, 1990

	COMPONENTS/ MEMORIES	COMPONENTS/ BUS	ELECTRONIC DESIGN AUTOMATION/ASICS	COMPONENT MICROPROCESSORS	SPECIAL PLD DAY W/DEMOS
9 a.m. - 11 a.m.	<b>SESSION CM1</b> Advances in Smart Memories Boost System Performance	<b>SESSION CB1</b> BiCMOS Technology – a Process for System Bus Interface Requirements	<b>SESSION EA1</b> The Realities of ASICs	<b>SESSION MP1</b> Floating Point Processing Techniques	<b>SPECIAL SESSION 1A</b> Needs and Implications for Very High Speed PLDs for Next Generation Microprocessor System Designs
Noon - 2 p.m.	<b>SESSION CM2</b> Designing High Performance Memory Systems for the 1990s	<b>SESSION CB2</b> Integrated Systems Solutions to Futurebus+ (IEEE 896)	<b>SESSION EA2</b> ASIC Prototyping Alternatives for Systems Level Design Validation	<b>SESSION MP2</b> New Developments in 8/16 Bit Microcontrollers	<b>SPECIAL SESSION 1B</b> Recent Advances in Innovative, High Density PLD Architectures and Their Benefits for System Designs
3 p.m. - 5 p.m.	<b>SESSION CM3</b> Advanced Cache Architectures	<b>SESSION CB3</b> FDDI (Fiber Distributed Data Interface) A 100Mb/s Fiber Optic Local Area Network	<b>SESSION EA3</b> VLSI Testable Design and Fault Coverage	<b>SESSION MP3</b> Making Practical Use of Microprocessor Benchmarks	<b>SPECIAL SESSION 1C</b> DEMONSTRATIONS Development Tools for High Density PLDs 2 p.m. - 5 p.m.

## WEDNESDAY ■ NOVEMBER 14, 1990

	CAE DAY	COMPONENT/ EMBEDDED SYSTEMS/CONTROLLERS	COMPONENT/ SEMICONDUCTOR	INTERNATIONAL	SPECIAL SESSIONS
9 a.m. - 11 a.m.	<b>SESSION CA1</b> EDA Directions in the 90s: The Enabling Technology for Competitive Electronics Systems	<b>SESSION CE1</b> Embedded Systems Design Considerations	<b>SESSION CS1</b> Utilizing Reprogrammable PROMs in System Designs	<b>SESSION IN1</b> Industrial Strength-Education and Training in the 1990s	<b>SPECIAL SESSION 2</b> Neural Networks
Noon - 2 p.m.	<b>SESSION CA2</b> VHDL in all Phases of the Design Cycle	<b>SESSION CE2</b> Software Disciplines for Embedded Systems	<b>SESSION CS2</b> Monolithic Microwave Integrated Circuits (MMICs) and Subsystems	<b>SESSION IN2</b> Protecting and Marketing in a Competitive International Market	<input type="checkbox"/> Send me more information about WESCON  NAME _____ TITLE _____ COMPANY _____ ADDRESS _____ CITY _____ STATE _____ ZIP _____
3 p.m. - 5 p.m.	<b>SESSION CA3</b> Designing with PCs or Workstations: Where to Draw the Line	<b>SESSION CE3</b> Very High Performance Processors for Embedded Control	<b>SESSION CS3</b> A Designers Guide to Conductive Rubber Switch Technology	<b>SESSION IN3</b> Internationalization of O/S and Languages	

## THURSDAY ■ NOVEMBER 15, 1990

	CAE DAY	COMPONENTS/ DSP APPLICATIONS	GENERAL/ POWER	INTERNATIONAL	
9 a.m. - 11 a.m.	<b>SESSION CA4</b> Software Development Environments	<b>SESSION CD1</b> Designing Embedded Systems with DSPs	<b>SESSION GE1</b> Compliance for Commercial Electromagnetic Compatibility Requirements	<b>SESSION IN4</b> Issues of Privacy, Security and Safety Part I	Mail to: WESCON Attn: Alexes Razevich 8110 Airport Blvd. Los Angeles, CA 90045 Fax 213/641-5117
Noon - 2 p.m.	<b>GENERAL/ COMMUNICATIONS</b> <b>SESSION GE2</b> Emerging New Rules for Mil-Std Communication Boards	<b>SESSION CD2</b> New Advances and Future Trends in DSP ICs and Development Systems	<b>GENERAL/PACKAGING</b> <b>SESSION GE3</b> High Density Packaging and Interconnect	<b>SESSION IN5</b> Issues of Privacy, Security and Safety Part II	

# SPACE QUALIFIED, RAD-HARD CUSTOM CIRCUIT, 14 WEEK DESIGN.

## WAS ~~SECRET~~ CRAZY OR WHAT?

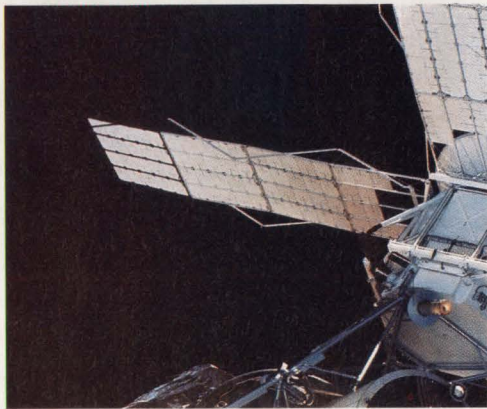

Some stories can't be told.

We're going to try anyway and still respect confidentiality.

A major aerospace company wanted a RAD-HARD, space-qualified stepper-driver for positioning the solar array of a highly sensitive military satellite. They wanted fail-safe performance plus adherence to a set of intimidating specs.

And they wanted it fast. "We're in a bit of a hurry," they said.

That was enough for the incumbent. They stepped out of the picture.

Which is just when we stepped in.

You see, few companies in the U.S. can build custom circuits like Silicon General can—quickly, reliably and profitably. That's because in over 20 years of solving problems in silicon, our files are bulging with thousands of IC solutions. We've developed an encyclopedia of circuit design and manufacturing solutions that lead us around the problems and pitfalls that plague less experienced vendors.

We work in partnership with your engineering department through every stage of design and manufacturing and will often assign a full-time project manager to oversee your job, as we did with this customer.

In the case of the stepper-driver, our drop-in replacement not only met form, fit and function, our specs gave the customer a little more latitude to meet his own price/performance requirements.

And to cap it off, we even delivered ahead of schedule.

If you need a partner to design and manufacture power IC's, someone who can meet "impossible" specs and deadlines, remember, nothing is as crazy as it sounds.

Not when you call in the General.

To hear more, contact Silicon General,  
11861 Western Avenue, Garden Grove,  
CA 92641. TWX: 910-596-1804.  
FAX: (714) 893-2570. Phone  
(714) 898-8121.



*Solutions...  
that's the general idea.*

# Coilcraft Data Line Magnetics

Precision components for signal filtering,  
network interface and EMI reduction

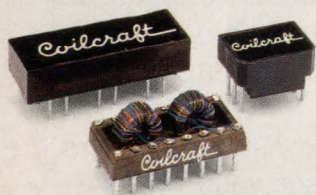

## LAN Transformers

We can provide everything from complete sets of 10BaseT interface magnetics to individual isolation transformers for Token Ring, StarLAN, Arcnet, Ethernet or compatibles. All have fast rise times, excellent common mode rejection and meet international safety requirements.

Call for free evaluation samples.

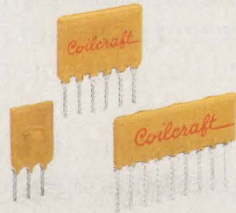

## LC Filter Networks

Choose from low, high, and bandpass filters in a variety of alignments. We offer 3, 5, or 7 pole filters in SIP, DIP or surface mount configurations. Plus our tight-tolerance chip inductors permit easy customization of cutoff frequency, rolloff, insertion loss, passband impedance, and delay.

Designer's Kit D102 contains 4 each of our 3, 5 and 7 pole low pass filters (18 MHz cutoff). \$50.

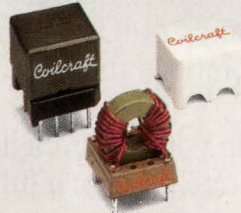

## Telecom Magnetics

Our family of telecommunication products includes transformers for T1, T3/DS-3, ISDN S and U Interface and impedance matching. They're compatible with most chip sets or we can customize to meet your specifications. We also offer common mode filters for "tip and ring" circuits.

Call for free evaluation samples.

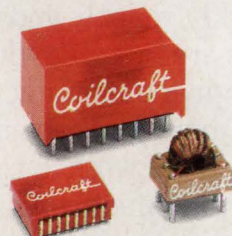

## EMI Filters

These board-mount filters virtually eliminate the problem of conducted EMI in data lines. They provide both differential and common mode noise attenuation from 1 MHz to over 500 MHz in a compact, easy to install package. Choose from 2, 3, 4 or 8-line versions, or we'll custom design parts to meet your specific EMC requirements.

Designer's Kit D101 contains 4 samples each of 2, 3, 4 and 8-line filters. \$65.

*Coilcraft*

ECM/electronic engineers master See our catalog in Vol. A, Section 1800

1102 Silver Lake Rd., Cary IL 60013 800/322-COIL Fax 708/639-1469

# Electronic Design

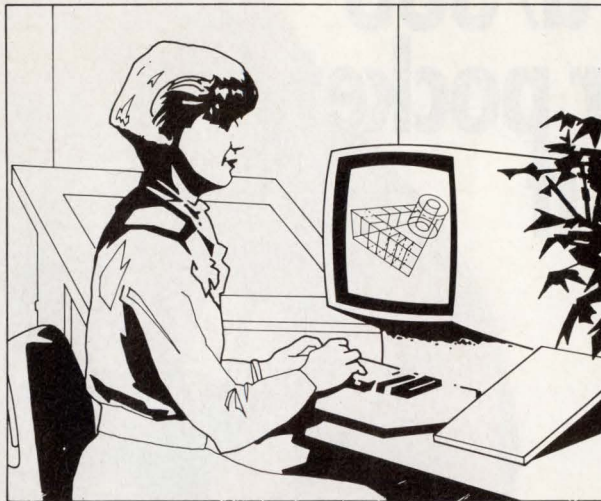

## targets your mailings to 150,000 design and development engineers

Highly-educated engineers and managers in the  
electronics original equipment market.

*Select by: Job function, type of industry, project responsibility, purchasing  
influence, employment size, and geography.*

**Guaranteed 99% deliverable 100% BPA audited  
circulation**

*Ideal prospects for your next direct mail campaign*

**Penton  
Lists**

CALL LITA PATTON AT 216/696-7000  
(ext. 2525) FOR YOUR FREE CATALOG.

# If the new Little Board/386 fits in your pocket, think how it would fit in your product.

**Big power. Small package.** Little Board/386 is a complete, 32-bit, 20MHz, 80386 computer which occupies just 5.75" X 8". It's perfect for embedded applications such as instrumentation, telecomm, network servers, data acquisition, CAM and others. Anywhere that you need big power in small space.

**A complete 386.** 1 or 4 Mbytes DRAM. Dual serial ports and parallel port. Floppy and SCSI controllers. Plus solid state disk (EPROM or NovRAM), and an expanding list of MiniModule™ expansion modules. You can even add standard PC and AT form factor boards.

**Priced right.** Little Board/386 can jump-start you in 386-based, embedded-processor product development. Little Board/386 is shipping now. In quantity. And, we can deliver at prices that are more than competitive.

**Answers. Now.** Little Board/386 is the newest in our complete family of IBM PC and AT-compatible, single board systems. If you embed microcomputers in your products, call today for complete information on Little Boards, MiniModules and the name of your nearest Ampro representative. Worldwide.

Call Toll Free:

**1-800-966-5200**

**AMPRO**  
SINGLE BOARD SYSTEMS

Ampro Computers, Inc., 990 Almanor Avenue, Sunnyvale, CA 94086

TEL: (408) 522-2100. FAX: (408) 720-1305. TLX: 4940302

All trade marks are the property of their respective owners.

See us at Electronica, Hall 16 Stand No. 16E and  
COMDEX/Fall, Caesar's Palace, Booth C728

CIRCLE 80

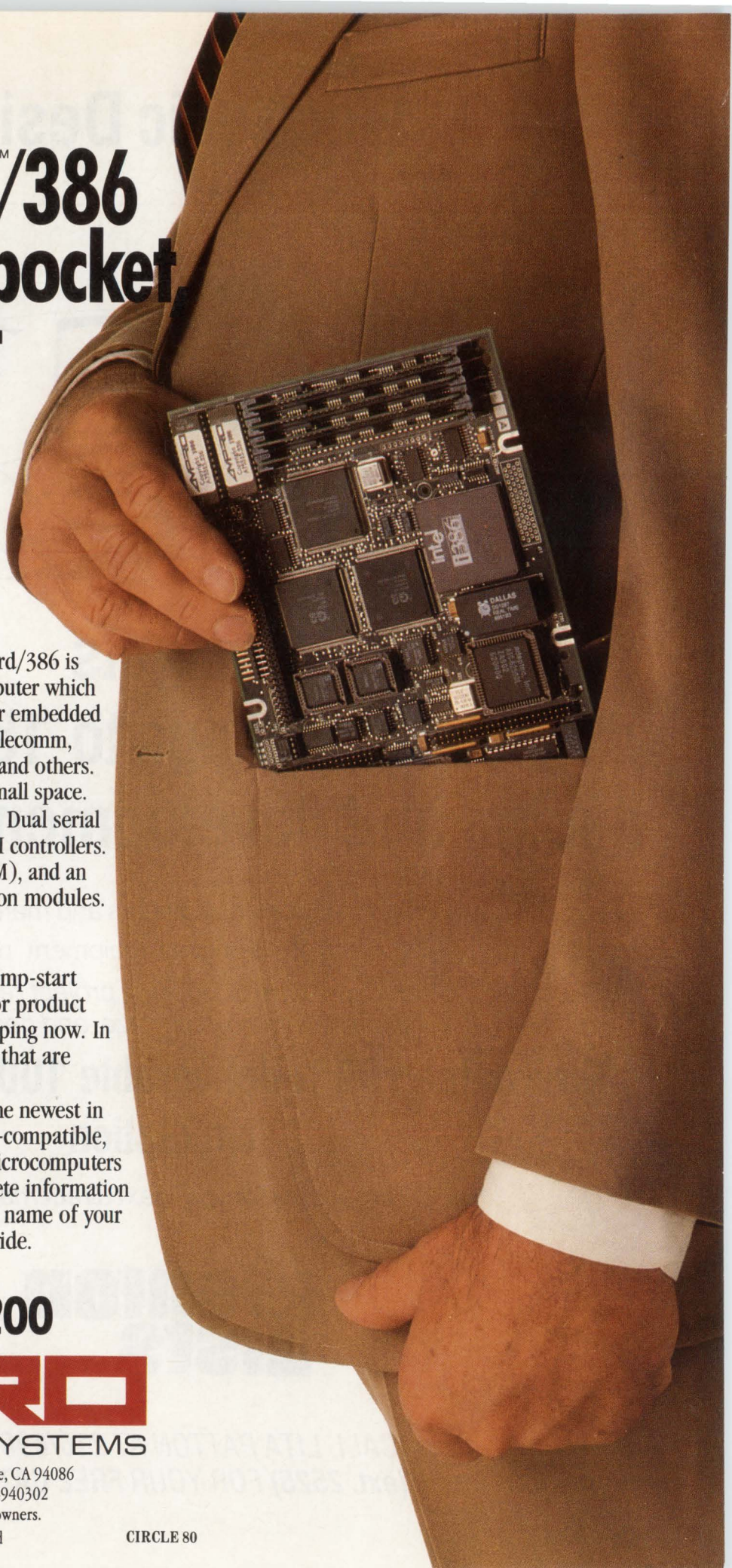

# 99¢

from



## dc to 2000 MHz amplifier series

### SPECIFICATIONS

MODEL	FREQ. MHz	GAIN, dB				• MAX. PWR. dBm	NF dB	PRICE \$ Ea.	Qty.
		100 MHz	1000 MHz	2000 MHz	Min. (note)				
MAR-1	DC-1000	18.5	15.5	—	13.0	0	5.0	0.99	(100)
MAR-2	DC-2000	13	12.5	11	8.5	+3	6.5	1.50	(25)
MAR-3	DC-2000	13	12.5	10.5	8.0	+8□	6.0	1.70	(25)
MAR-4	DC-1000	8.2	8.0	—	7.0	+11	7.0	1.90	(25)
MAR-6	DC-2000	20	16	11	9	0	2.8	1.29	(25)
MAR-7	DC-2000	13.5	12.5	10.5	8.5	+3	5.0	1.90	(25)
MAR-8	DC-1000	33	23	—	19	+10	3.5	2.20	(25)

NOTE: Minimum gain at highest frequency point and over full temperature range.

- 1dB Gain Compression
- +4dBm 1 to 2 GHz

**designers amplifier kit, DAK-2**  
5 of each model, total 35 amplifiers  
only **\$59.95**

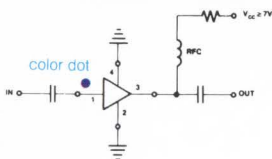

Unbelievable, until now... tiny monolithic wide-band amplifiers for as low as 99 cents. These rugged 0.085 in. diam., plastic-packaged units are 50ohm\* input/output impedance, unconditionally stable regardless of load\*, and easily cascadable. Models in the MAR-series offer up to 33 dB gain, 0 to +11dBm output, noise figure as low as 2.8dB, and up to DC-2000MHz bandwidth.

\*MAR-8, Input/Output Impedance is not 50ohms, see data sheet. Stable for source/load impedance VSWR less than 3:1

Also, for your design convenience, Mini-Circuits offers chip coupling capacitors at 12 cents each.†

Size (mils)	Tolerance	Temperature Characteristic	Value
80 × 50	5%	NPO	10, 22, 47, 68, 100, 220, 470, 680, 1000 pf
80 × 50	10%	X7R	2200, 4700, 6800, 10,000 pf
120 × 60	10%	X7R	.022, .047, .068, .1μf

† Minimum Order 50 per Value

- Designers kit, KCAP-1, 50 pieces of each capacitor value, only \$99.95

finding new ways ...  
setting higher standards

## Mini-Circuits

A Division of Scientific Components Corporation  
P.O. Box 350166, Brooklyn, New York 11235-0003 (718) 934-4500  
Fax (718) 332-4661 Domestic and International Telexes: 6852844 or 620156

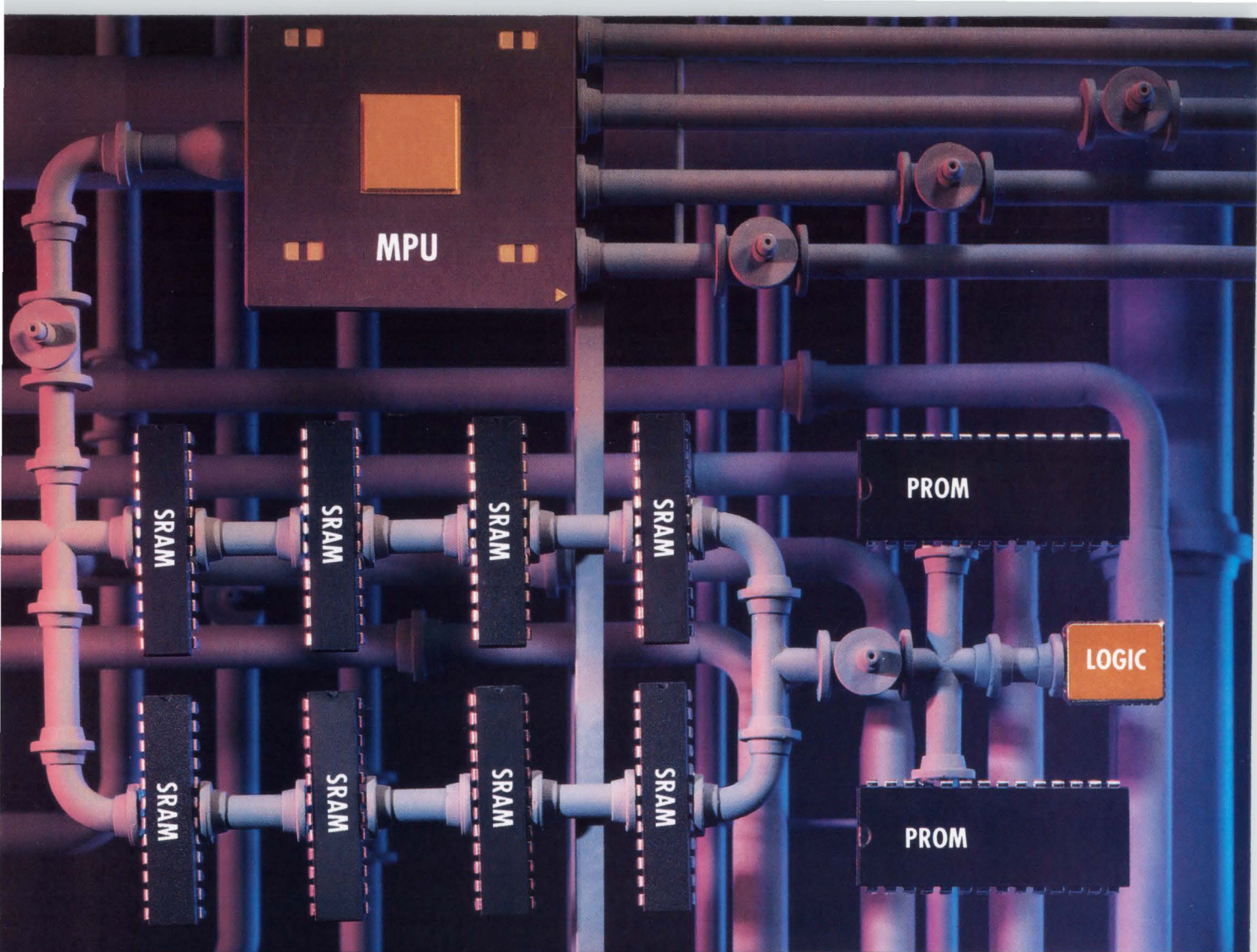

# There's a much faster way around all this.

For applications such as embedded control, where space is at a premium, these new high density, high

## 256K PROM.

performance PROMs let you build a smaller system, or pack

more functions into your existing space.

You save on more than space and SRAM part costs.

You save on power, because all these PROMs are in our proven, high performance, low power CMOS.

They are available in a wide variety of packaging, including plastic DIP, CERDIP, and PLCC.

They are erasable. That lets us test every part 100% before shipping, and lets you specify windowed, reprogrammable versions.

So if you need more memory in less space with less power, go direct with our ultra-fast 256K PROMs.

### New Ultra-Fast 256K PROMs:

At 35 ns, these 300-mil parts are so fast you can run code right from PROM, eliminating SRAM and logic expense. You cut space and cost requirements significantly.

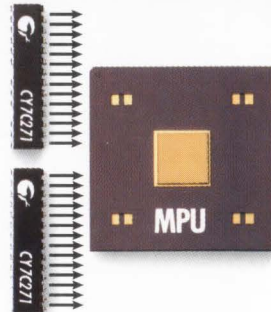

256K Registered CMOS PROM. 30 ns.



256K Registered CMOS PROM. 35 ns.

Call the Hotline for your free Data Book and get the full info on all our PROMs. 1-800-952-6300. Ask for Dept. C3H

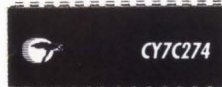

32 K x 8 Power Switched CMOS EPROM. 35 ns.



256K Power Switched CMOS PROM. 35 ns.



CYPRESS SEMICONDUCTOR

\*1-800-387-7599 in Canada. (32) 2-672-2220 in Europe. ©1990 Cypress Semiconductor, 3901 North First Street, San Jose, CA 95134. Phone: (408) 943-2600, Telex: 821032 CYPRESS SNJ UD, TWX: 910-997-0753.