

CHILTON'S **THE ELECTRONIC ENGINEER**

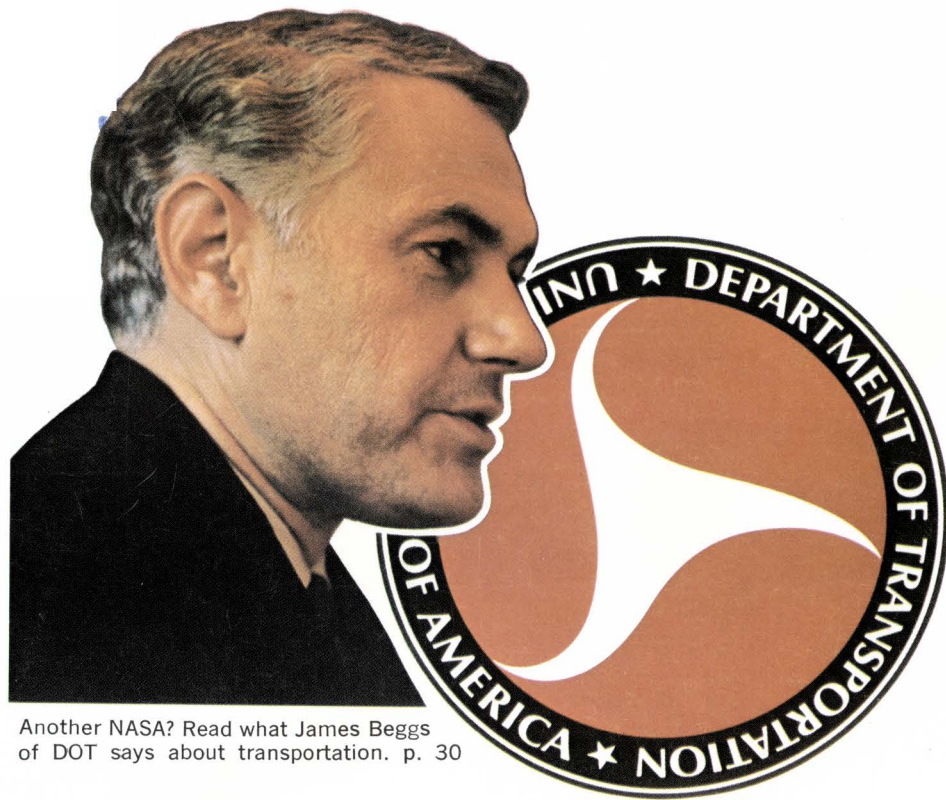

Another NASA? Read what James Beggs
of DOT says about transportation. p. 30

Course on MOS ICs, part 4
ICs simplify microwave frequency dividers
How to select a time-sharing service
Where to buy computer time

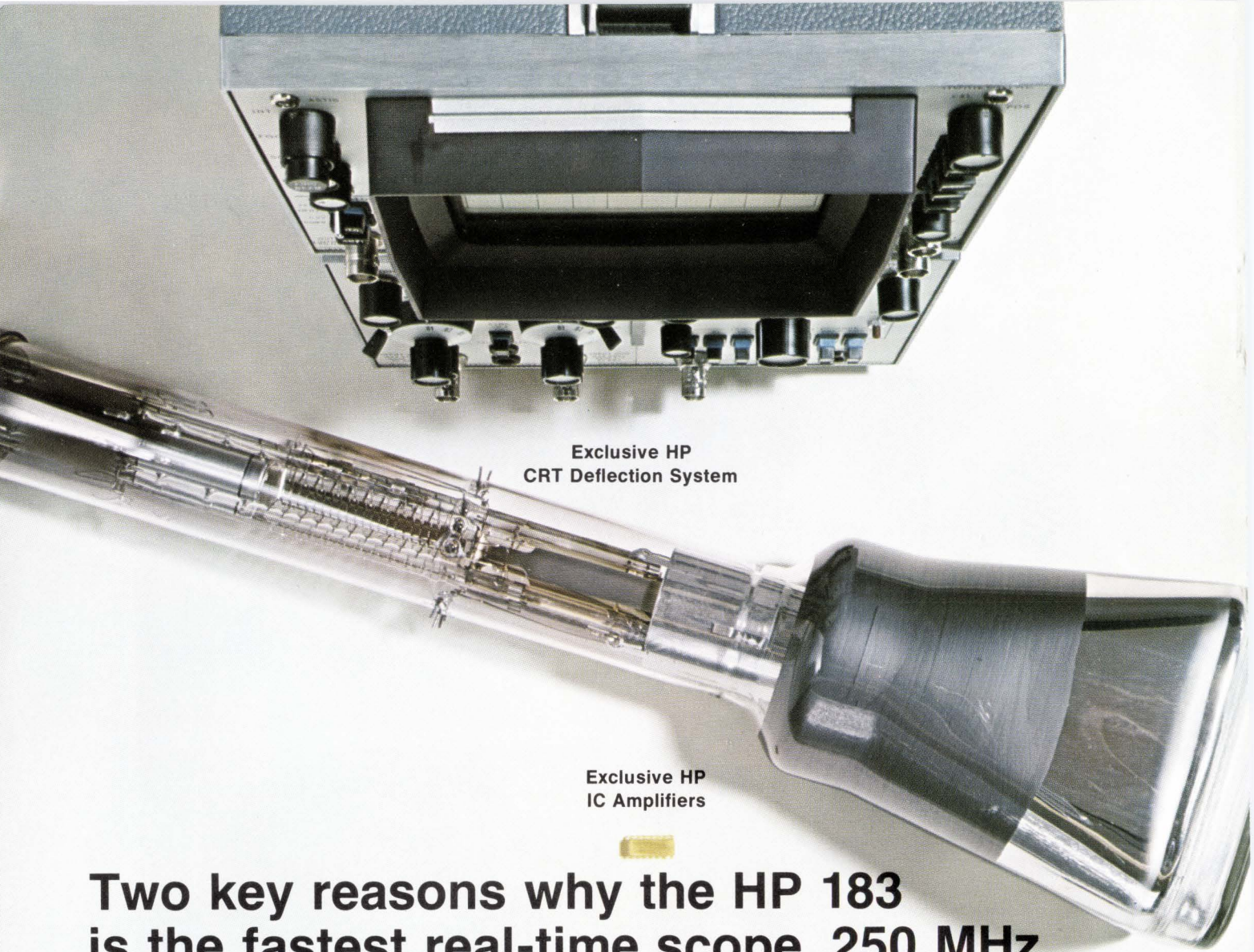

Exclusive HP
CRT Deflection System

Exclusive HP
IC Amplifiers

Two key reasons why the HP 183 is the fastest real-time scope, 250 MHz ...today's performance champ!

080/7

Here is today's undisputed leader in scope performance: DC to 250 MHz bandwidth, 10 mV sensitivity, less than 1.5 ns risetime, 4 cm/ns writing speed and 11 compatible plug-ins.

Here are some of the tasks performed by this new, DC-to-VHF real-time window—display intermittent pulse trains with nanosecond risetime, capture fast transients, take a look at amplitude-modulated carriers ahead of a detector.

This is a **big jump in real-time waveform displays**. HP's technical leadership, covering a wide area of disciplines, has made it possible. An in-house IC capability has produced **monolithic transistor arrays** for the vertical amplifier—key factor in achieving **good transient response with 250 MHz bandwidth** and high-fidelity reproduction of waveforms.

Use of micro-circuitry also has reduced the number of high frequency calibration adjustments—to only two for the vertical amplifier, instead of typically up to 30 or 40.

HP's step-ahead CRT technology produced a unique CRT to display fast signals. It utilizes two transmission lines for the vertical deflection system. They provide distributed deflection of the electron beam, **giving the CRT a cutoff frequency well beyond 500 MHz**. Other features of this exclusive CRT are a low deflection factor, high brightness and fast writing speed.

Because the vertical deflection system of this CRT is directly accessible to the vertical plug-in, the **183A mainframe can accept any of the 180 series plug-ins**—to make it a true, general-purpose scope. Since the 183A is **not mainframe limited** you can take advantage of HP innovations in higher frequency plug-ins as they become available.

This is the year of the big change for the oscilloscope industry. You'll be making a buying decision that you will have to live with for some time to come. It stands to reason that the step-ahead thinking exemplified in the HP 250 MHz scope also exists in all HP scopes. **If you are not now convinced** Hewlett-Packard is best, try a side-by-side comparison with any other scope. Call your HP field engineer to arrange a comparison.

The HP 183 is only one of a family of high performance scopes—including sampling and storage. Write, Hewlett-Packard, Palo Alto, California 94304. Europe: 1217 Meyrin-Geneva, Switzerland. Price, HP 183A with 250 MHz plug-ins: \$3150.

HEWLETT  PACKARD
OSCILLOSCOPE SYSTEMS

Circle 1 on Inquiry Card

...like more capacitance in aluminum 'lytics?

Get SPRAGUE Type 36D POWERLYTIC[®] CAPACITORS



INFORMATION RETRIEVAL NO. 4

- Large cylindrical electrolytic capacitors for use in digital computer power supplies, industrial control equipment, energy storage applications, etc
- Low impedance construction
- Largest case (3" dia. x 8 5/8" high) provides 650,000 μ F at 3 volts!
- Can be operated at +85 C
- Tapped No. 10-32 terminals simplify filter bank assembly
- Available with or without outer plastic insulating sleeves
- Request Engineering Bulletin 3431C

45C-9153R2

...want high volume efficiency in tubular 'lytics?

Use SPRAGUE Type 39D POWERLYTIC[®] CAPACITORS

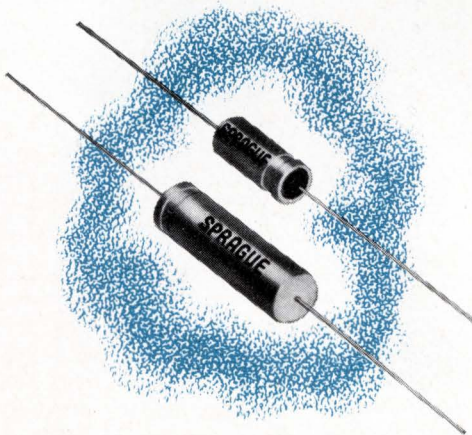

INFORMATION RETRIEVAL NO. 5

- Provide maximum capacitance in smaller cases with axial leads
- No internal riveted or pressure connections
- Welds at critical anode and cathode terminals
- Molded end covers
- Life expectancy of 10 years or more in normal service
- Very low effective series resistance and leakage current
- Request Engineering Bulletin 3415

45C-9154R2

For Engineering Bulletins as noted above, write to:
Technical Literature Service, Sprague Electric Co., 233
Marshall Street, North Adams, Massachusetts 01247.



Sprague and ® are registered trademarks of the Sprague Electric Co.

THE BROAD-LINE PRODUCER OF ELECTRONIC PARTS

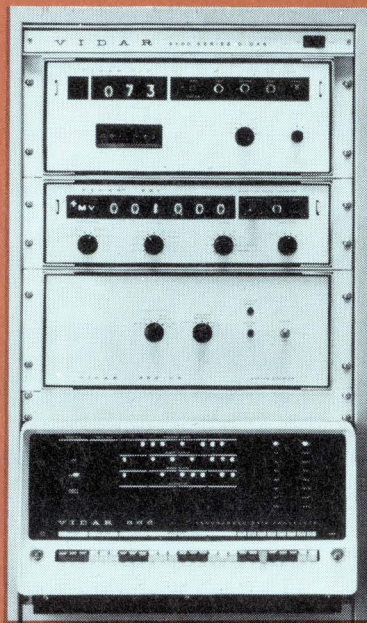

MISSING LINK

Link your scientific or general-purpose computer with transducers and contact closures and get real-time data and analysis. You've probably been stymied with no economical way to connect thermocouples, RTD's, load cells, flow meters and contact closures to your computer.

VIDAR's 5206 is the "missing link" which translates multiple transducer outputs (volts, ohms, Hertz, and contact closures) into computerese and interfaces them to your computer. As an intelligent "front-end" with a built-in mini-computer, the VIDAR 5206 can monitor and manage continuous processes, even when your big computer is down. It saves big computer time by pre-processing data. Efficiencies and trends are displayed only when required. Your people can interrogate it through remote displays to keep track of how things are proceeding.

Whether you want to use your computer for dynamic testing — or need a stand-alone process manager and data logger, get all the facts about VIDAR's wares (hard and soft).

VIDAR®

77 Ortega Avenue, Mountain View, Calif. 94040 (415) 961-1000

the automatic-measurement people

Circle 6 on Inquiry Card

Editorial	9
It happened last month	10
Up-to-date	12
Forefront	17
Speak up	22
Calendar	26
Seminars	29
Careers	30
Courses	40
Welcome	46
Books	48
Microworld	61
IC Ideas	67
Abstracts	77
New Product Feature	81
Microworld New Products	84
Lab Instruments	89
Systems New Products	92
New Products	94
Literature	102
Ad Index	111
Product Index	112

You can't get there from here! 30

With modern technology, the electronic engineer can get transportation moving and prevent yesterday's classic line from becoming tomorrow's tragic reality.
By John Mc Nichol

MOS integrated circuits . . . part four 51

This issue includes the Fourth installment of a six-part course on integrated circuits made with metal-oxide semiconductors (MOS).

Complementary MOS logic and applications 52

Combining p- and n-channel devices on the same chip gives you a unique kind of MOS.
By S. S. Eaton

Design shortcuts for microwave frequency dividers 61

By using parametric diodes and simple microwave techniques you can design and build dividers that work into the GHz range. The dividers are very attractive for digital frequency synthesizers.
By Willie Goldwasser

IC Ideas 67

- Binary number comparator by C. Hall, Jr.
- Triflop—A three-state memory element by Anatole Turecki
- Digital frequency doubling by David L. Sporre
- Dual bootstrapping improves amplifier performance by Basil T. Barber

Report on time-sharing services 88

following page

How to select a time-sharing service C2

There are many time-sharing systems, offering diverse capabilities, only a phone call away. Here's help in selecting the proper one.
By A. G. Hammersmith

Available time-sharing services C5

The line-up; a rundown of computer time-sharing services plus available languages and programs.

COVER

Our CHALLENGE subject, James M. Beggs, Under Secretary of the Department of Transportation, discusses the need for communications and control systems for this nation's transportation needs. Pictured here with a background showing DoT's seal, Beggs describes opportunities for the electronic engineer in all aspects of transportation. (Cover photograph: John DiJoseph, Jr., Wash., D. C.)

A SMALL ROTARY SWITCH



with TREMENDOUS features

- 30° Angle of Throw (12 Positions)
- 0.7" Behind Panel, 0.562 Diameter
- One, Two or Four Poles
- Shorting or Non-Shorting
- PC or Solder Lug Terminals
- Sealed or Unsealed
- Adjustable or Preset Stops
- Commercial or Military Styles

To Make and Break 50 MA for 25,000 cycles,
200 MA for 10,000 cycles (rated at 115 VAC resistive)

REQUEST YOUR ENGINEERING DATA SHEET 157



543 Hillgrove Avenue
LaGrange, Illinois 60525
Area Code 312, Phone 354-1040

... the Difference Between Excellent and Adequate

Circle 7 on Inquiry Card

Over 15,000 Pressure-Sensitive Electronic Component Drafting Aids

Exciting innovations in pressure-sensitive electronic component drafting aids and techniques are detailed in the new 1970 edition of the combined Bishop Technical Manual and Catalog 104A.



FREE CATALOG

FREE SAMPLES

- Over 15,000 multi-pad configurations, symbols, tapes, sequential reference designations, targets, etc.
- Hundreds of time-and-money saving hints in making artwork for PC boards.
- Make artwork for two-sided boards in perfect registration with the industry's only photographically-compatible red and blue tape system.
- Eliminate photography in making negatives for prototype circuit boards with Bishop's "B" Neg Negative Drafting System (Pat. Pend.).

Send for your FREE Catalog, FREE Samples.

Bishop Graphics, Inc.
7300 Radford Avenue, North Hollywood, California 91605
(213) 982-2000 TELEX: 674672

©1969 Bishop Graphics, Inc.

Circle 8 on Inquiry Card

THE ELECTRONIC ENGINEER

Vol. 29 No. 5

May 1970

K. Robert Brink, *Publisher*

Alberto Socolovsky, *Editor*

John E. Hickey, Jr., *Managing Editor*

Smedley B. Ruth, *Associate Editor*

Sheldon Edelman, *Western Editor S.F.*

Stephen A. Thompson, *Western Editor L.A.*

Arthur J. Boyle, *Technical Editor*

John McNichol, *Assistant Editor*

Dr. O. M. Salati, *Consultant*

Anne Axe, *Editorial Assistant*

Alice C. Bach, *Editorial Assistant*

Lynda Rothstein, *Editorial Assistant*

Deborah P. Wilkins, *Editorial Assistant*

Mae Moyer, *Editorial Reader Service*

Andrew Mittelbrunn, *Chilton Art Director*

Phaue Featherston, *Artist*

George Baker, *Washington News Bureau*
Neil Regeimbal,

Chilton BPA

Executive and Editorial Offices:
One Decker Square, Bala-Cynwyd, Pa. 19004
Tel. (215) SH 8-2000

Address Mail to: 56th & Chestnut Sts.
Philadelphia, Pa. 19139

Western Offices:
Stephen A. Thompson, 1543 W. Olympic Blvd., Los Angeles, Calif. 90015
Tel. (213) DU 7-1271

Sheldon Z. Edelman, 199 First St. Rm. 335
Los Altos, Calif. 94022
Tel. (415) 941-6655

Chilton Officers & Directors: Chairman of the Board: G. C. Buzby; President: R. E. McKenna; Financial Vice-President: S. Appleby; Senior Vice-Presidents: J. Kofron, L. King; Publishing Vice-Presidents: C. W. Hevner, W. A. Barbour, R. H. Groves, K. Robert Brink; Treasurer: James Miades; Secretary: J. A. Montgomery, Jr.; Other Directors: T. J. Casper, S. H. Callmann, R. Rimbach, Jr., J. P. Kushnerick, R. O. Nelson; Asst. Secretary: I. C. Holloway.

Monthly publication of Chilton Company, Chestnut & 56th Sts., Phila., Pa. 19139. (Area Code 215) SHerwood 8-2000. Controlled circulation postage paid at Philadelphia, Pa. \$1 a copy. Subscription rates U. S. and U. S. Possessions: 1 yr. \$12.00; 2 yrs. \$20.00. Canada 1 year \$14.00; 2 yrs. \$25.00. All other countries 1 yr. \$20.00; 2 yrs. \$35.00. © Chilton Company 1970. Title Reg. U.S. Patent Office. Reproduction or reprinting prohibited except by written authorization.

The Chilton Electronics and Instrumentation Group •
The Electronic Engineer ■ Instruments and Control Systems ■ Instrument & Apparatus News ■ Medical Electronics News ■ Electronic Component News

The Electronic Engineer • May 1970

LOGIC DESIGNERS

Alice

MAKES EVERY
KEYBOARD A
BREADBOARD

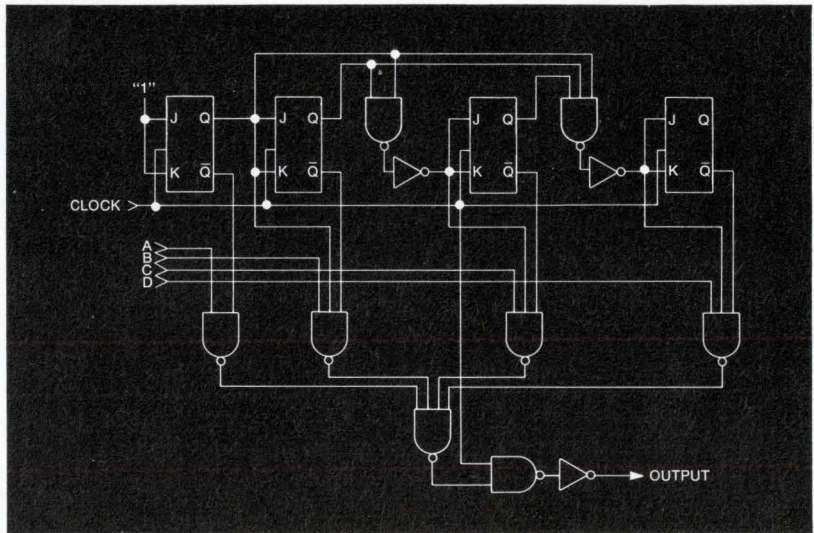

Alice (Applicon's Logic Simulator) can perform simulations ranging from a quick checkout to a detailed analysis of timing problems. With **Alice** you can simulate circuits implemented in any form, from completely asynchronous designs to synchronous two and four phase MOS designs. Just describe your circuit to **Alice** using manufacturers' designations directly from your logic diagram. Then use the flexible simulation control commands to exercise your design and observe its behavior.

Alice Network Description

- Convenient and flexible input
- Catalogs of standard logic families
- User defined building blocks
- Full editing capability
- Synchronous logic elements
- Independent rise and fall delays

Alice Simulation Control Commands

- Periodic and nonperiodic input sequences

- Specify inputs and internal logic values at any time
- Flexible control over printing
- Observe any signals or functions of signals

Additional Features

- Three-valued simulation (0, 1 and undefined)
- Automatic spike and hazard detection
- Signal cross reference listings

Alice is an interactive program that speaks your language. It's as near as your Teletype. Write now for a brochure describing how **Alice** can help you make the most of your design time.

APPLICON 
INCORPORATED

83 Second Avenue
Burlington, Massachusetts 01803
(617) 272-7070

Design Assistance for Design Engineers

Decimals: Autopoint and scientific notation.

Automatic entry of e and π .

Ten directly addressable
storage registers

Programming: Up to
128 steps. Conditional
branching and
automatic entry of
programs with card reader.



Model 1655. Size: 13" x 13½" x 6½".

Announcing an important break-through for engineers and scientists. Calculators based on the latest MOS/LSI technology. In both printing and display models. Available in over 350 cities coast to coast. Supported by more than 3,300

Dynamic range: 10^{-99} to 10^{+99}

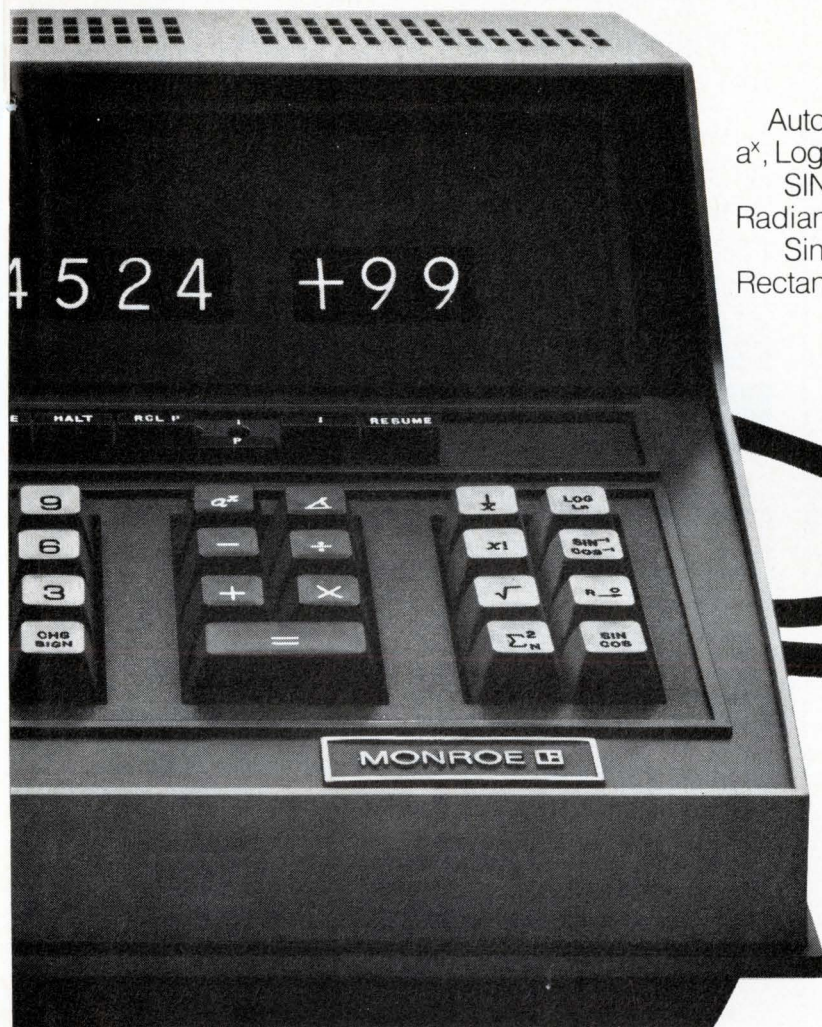

Automatic special functions:
 a^x , $\text{Log}_{10}/\text{Log}_e$, SIN/COS,
 $\text{SIN}^{-1}/\text{COS}^{-1}$, $x!$, $\frac{1}{x}$,
Radians to Degrees,
Single key Σx , Σx^2 , N,
Rectangular to Polar Conversion.

Just plug in
and put it to work.

Weight: Twelve pounds.

**sales and service technicians.
Monroe men who know everything
there is to know about calculators.
Because calculators are our only business.
That's how we got our name.
Monroe. The Calculator Company**

A DIVISION OF LITTON INDUSTRIES

550 Central Avenue, Orange, New Jersey 07050

Circle 10 on Inquiry Card

Why National Semiconductor buys Teradyne J259's by the dozen

National Semiconductor can trace its considerable success as an IC manufacturer to many factors. One of the most important is the productivity of its testing facility, built around a lineup of 12 Teradyne J259 computer-operated test systems. "The Teradyne systems," according to Jeff Kalb, National's TTL product manager, "give us the economy of testing that is so important to profitable high-volume production."

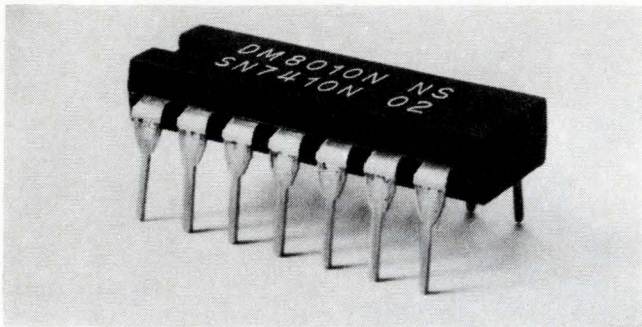

National, along with most other major IC producers, has found that the J259 boosts productivity in many ways. No other test system, for example, gives its user as much multiplexing freedom as does the J259, which lets National leverage its investment by making each J259 support several test stations doing several different jobs.

Reliability is another all-important key to productivity. National experiences minimal downtime with its J259's. This is as it should be; we design and build our equipment to work shift after shift, year after year, in *industrial* use. Teradyne systems are right at home on production lines like National's, where the workload is heavy and continuous. And operation never has to be interrupted for calibration; the J259 has no calibration adjustments.

The J259's great versatility is also put to good use at National. The same systems that test wafers and packages also generate the distribution and end-of-life data that engineers need to control production processes and ensure high device reliability. Production, engineering, QC, and final test – all share simultaneously in the benefits from National's J259's.

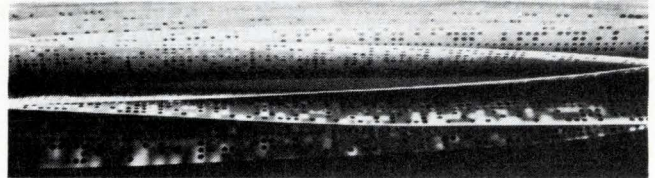

A computer-operated system is only as good as its software, which in the case of the J259 is the best there is. National's J259's are orchestrated by Teradyne-supplied master operating programs for datalogging, classification, and evaluation. As Teradyne updates and improves its software, National is kept fully informed.

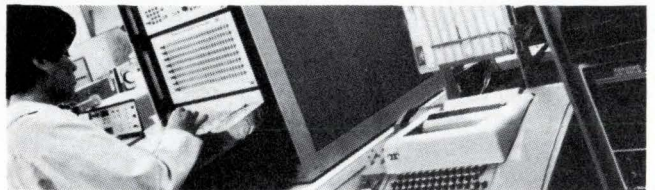

National's array of J259's handle the testing of its digital IC's smoothly and economically. For its linear-IC testing, National has turned to Teradyne's J263 computer-operated linear-IC test system.

Teradyne's J259 makes sense to National Semiconductor. If you're in the business of testing circuits – integrated or otherwise – it makes sense to find out more about the J259. Just use reader service card or write to Teradyne, 183 Essex St., Boston, Mass.

Teradyne makes sense.

Circle 11 on Inquiry Card

The majority carriers need your help

Their transport times are measured, not in nanoseconds, nor even in microseconds, but in hours. There is certainly an avalanche mechanism, and their recovery time may take years, with your help. In short, we are not talking about semiconductor mechanisms, but about transports for people.

These were our conclusions after talking with the Honorable James M. Beggs, Under Secretary of the Department of Transportation, about the contribution electronic engineers could make to the problem of transporting people. Take, for example, the problem of air traffic control, which has been plaguing our airports in recent months. You know the arguments—the air traffic controllers say they are overworked, that their equipment is antiquated.

The real problem, says Under Secretary Beggs, is that most of the air traffic control is based on a labor-intensive system, such as the one used to communicate between the control tower and cockpit. Most of the messages exchanged are routine commands or reports that are transmitted by voice—a good way to waste both time and bandwidth.

This is where you come in, to develop computers that can interpret and produce the routine messages, and electronic displays to communicate them. Who will pay for the system, you ask? Read the article that starts on page 30.

Alberto Socolovsky
Editor

Where—and how— to dial for computer power

Do you believe in computer power? The kind of power that gives you the thrill of mastering a mass of data or cracking a long problem in seconds?

That power is available right at your fingertips, with a time-sharing outlet. Even if your company has a computer, it may still pay for you to look into time-sharing services. Or, if you are using one, it may pay to look at some of the newer services. You can read all about time-sharing services in our wrap-up following page 88.

The passing of a colleague

Maybe it used to reach your desk every month. Even if it didn't, you could still find out about its more important articles in the ABSTRACTS section of our magazine. But you will not be able to find it in either place any more, because *Electro Technology* magazine is no more—this March it published its final issue.*

Founded in 1930 under the name *Electrical Manufacturing*, the magazine served the field of electrical control until 1960—when it changed its name to *Electro Technology*. From its pages, renowned editors such as Frank Oliver and Alex Javitz brought us the first published elementary diagrams for electrical control circuits, the latest standards by the Joint Industrial Conference (JIC Standards), the newest insulations approved by the National Electrical Manufacturers Association (NEMA).

Now both names—*Electro Technology* and *Electrical Manufacturing*—are numbers on library cards, rather than live sources of information on readers' desks. And we are all poorer for that.

*Starting this month we will add technical articles by *Computer Design* magazine.

IT HAPPENED LAST MONTH . . .

The editors of THE ELECTRONIC ENGINEER have sifted through the various technical and significant happenings of the past month and selected the items that would be of the most interest or use to you.

Relay comments . . . Heard in Los Angeles, at Ohmite's recent "Relay Think-in": "We're trying to eliminate make/break contacts in aircraft power distribution systems. Our goal is a completely solid-state systems with long life, improved performance and reliability, plus low power dissipation and considerably reduced space requirements." (Lee Dickey and Clyde Jones of LTV Aerospace) "The ER (established reliability) specifications for electromechanical relays seem to be losing favor among government and aerospace people." (Rudolph Steiner of North American Rockwell) "Contact bifurcation doesn't guarantee double the reliability; it's really more like 20%. In fact, it might be even less. It would probably be more accurate to describe the main advantage of bifurcation as longer life, even at the expense of reliability." (J. P. Sykes of Redcor Corp.)

Easing operation requirements . . . The National Association of Broadcasters (NAB) has petitioned the Federal Communications Commission to relax first-class operator requirements for a-m directional, a-m non-directional, and fm broadcast stations. The NAB feels that such a move would eliminate a major obstacle standing in the way of greater employment opportunities for minorities. They ask that third-class operators be allowed to handle the same jobs at up to 50 kW that they now handle at up to 10 kW. Left unsaid was the possible reaction of current first-class operators whose jobs might be downgraded.

Selective plating . . . Using a new process, NASA's Mississippi Test Facility has saved \$344,000 in one year through salvage of printed circuit boards. Normally, the boards' gold-plated contact surfaces would eventually wear to a degree that the only alternatives were either reworking or discarding. A simple method developed by Selectrons, Ltd., of New York and implemented by General Electric Co., remedied this wasteful situation.

Engineers' salaries . . . There is evidence of a sharp upward trend in engineers' salaries. Figures just released by the Department of Labor for the period June 1968 to June 1969 show an increase of 6.2% as against a general increase of 5.8% in average salary for all professional, administrative, and technical support jobs. By way of contrast, the 6.2% rise (and the 5.4% figure for 1967-68) is significantly higher than the eight year average (1961-69) of 4.1%. On the question of whether or not this is related to overall economic expansion or is rather an indi-

cation that engineers' salaries are moving upward independently, the jury is still out. The Administration's anti-inflation, "cooling-off" measures have recently shown signs of taking hold, so this year's figures should be the most interesting of all.

Polycrystallin material developed . . . Sponsored by the Air Force, Tyco Laboratories of Waltham, Mass., has for the past year been conducting an evaluation of cadmium telluride, a new, high-quality semiconductor material. Although CdTe has been known about for some time, Tyco's contribution is the development of a method of fabricating high-quality single crystals. High counting efficiency, temperature capability, and simplicity of detector combine to make the material useful in gamma-ray detection applications; also, because of its good transparency, it can be used in infrared optics. Other potential uses point in the directions of high temperature semiconductor devices—transistors that operate at over 200°C—and power-generating solar cells.

Tape services offered . . . IEEE's Information Services Department is presently offering magnetic tape services—designated IEEE REFLECS (Retrieval From the Literature on Electronics and Computer Sciences). The monthly service, begun this April, consists of machine-readable magnetic tapes that are produced in various character codes and tape formats, depending on customer requirements. The tapes contain indices and abstracts of papers pertaining to the electronics, computers and control, and applied physics fields. Also under consideration is a service titled IEEE Annual Index Tapes containing a listing of IEEE's publications for 1968 and 1969. The two tapes will cover 16,000 papers from various IEEE publications. Each tape will be available for \$700; if both tapes are ordered, the price is \$1200. This service will be available in 1971.

Direct leasing . . . For quite some time now, you have been able to rent instruments for laboratory use from independent leasing firms. But now, one instrument manufacturer offers a direct-to-the-user leasing program. Telonic Industries, in an extension of its marketing policies, will rent you their instruments. For example, you can have the company's 2003 sweeper with a 201 tri-color display—a system which normally sells for \$6400—for \$165/mo. on lease. Can this be the start of a trend? Remember, leasing gives you up-to-date test gear without capital investment and offers accounting and tax benefits as well.

400 Hz Solid State Relays

for military & commercial aircraft

Originators



TO-5 Relays

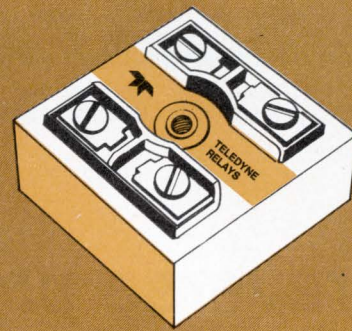
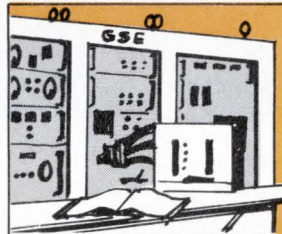
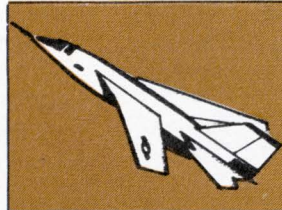
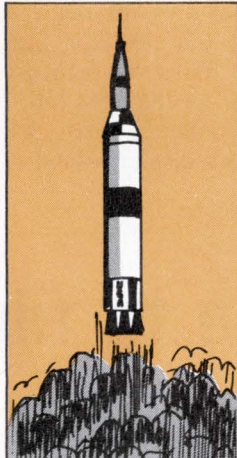

Solid State Relay

The originators of TO-5 relays announce another first! Solid state relays that meet or exceed all categories of MIL-STD 704A. Transient protected on input and output. Features include an ultra-sensitive "coil" (compatible with 5 volt logic systems, such as TTL), and a zero-voltage switching option to minimize RFI. They can switch over 5 KW, resistive or inductive loads (50-500 Hz). Extremely high reliability and maintenance-free operation

make them ideal for aircraft control and power system applications. Three input "coil" ranges are available, 3-8 VDC, 7-85 VDC and 90-230 VAC. Features include low contact resistance (50 milliohms typical) and contacts capable of withstanding overloads 1000% above ratings. Lack of moving contacts prevents arcing, permitting switching in explosive atmospheres, controlling motors, solenoid valves, actuators, transformers, etc.

The high contact surge rating is ideal for lighting control systems (5000 watts of tungsten lamps can be switched). For complete technical data on our 400 Hz Series 6 Solid State Relays and solutions to your 400 Hz power switching problems, contact

**TELEDYNE
RELAYS**

3155 West El Segundo Blvd. Hawthorne, Calif. 90250
Telephone (213) 679-2205

Silverless electrophotography

Varian Associates has demonstrated a prototype microfiche reader/primer which produces dry, permanent, 8½- x 11-in. enlargements from microfilm. The operator can scan microfilmed information on a viewing screen and quickly get a hard copy of any one frame. Each letter-size copy costs only about a third as much

as one made with a conventional photo system.

The reader/printer is the first practical application of an electrophotographic process announced by Varian last year. Instead of using silver, the light-sensitive element is a photoconductive plate. The exposure consists of projecting the image to be photographed onto that photoconductor. A transfer voltage, applied during exposure, creates a corresponding charge image on a special paper. Then, carbon-particle toners cause the latent electrostatic image to appear.

In most applications, there is no need for a mechanical shutter, because the paper is not light sensitive before or after exposure. And exposure times—between 10 and 100 ms—are shorter than those of conventional electrophotography. The company claims that the process is panchromatic across the visible spectrum and has a resolution better than 8- to 10-line pairs per millimeter.

The process should be adaptable to a wide variety of hard-copy applications. For instance, COM (computer-output-to-microfilm) equipment manufacturers have a need not only for reader/printers of the type demonstrated, but also for high-speed production printers. Varian thinks their process, because of its high sensitivity, will fill the COM bill, and they look to other fields such as data terminals—where the need is for hand copy from CRT displays—and micropublishing.

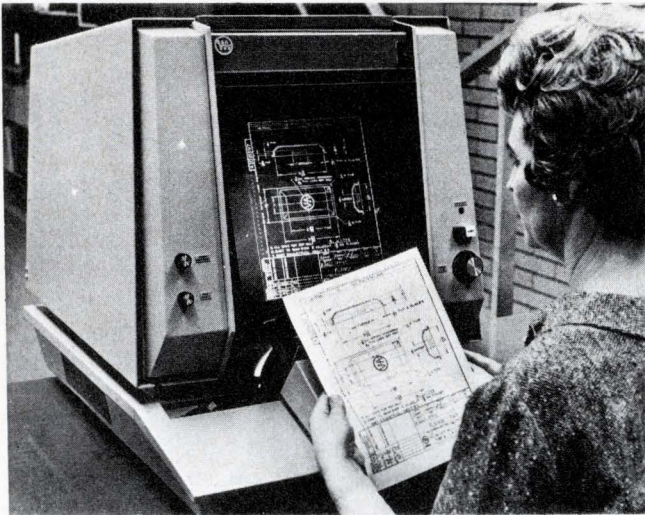

Microfiche reader/printer produces dry, permanent 8½ x 11-in. enlargements quickly. The paper used is not sensitive to natural light.

A reverse process—tape to film

During the past year we have seen several developments in the video recording area. Here is one that is a reverse process, converting video taped material to film. It was developed by the 3M Company of St. Paul, Minn.

The 3M "Chromabeam" system for converting NTSC color video to 16-mm motion picture film is composed of an electron beam TV recorder specifically designed for the system, and a newly developed color printer.

The recorder is similar to the 3M EBR-100, which converts video signals into black and white photographic film, with the addition of a color decoder and a color field switcher.

The encoded color signal from either video tape or a TV camera is decoded into its separate red, green and blue components. These color signals are then recorded

(continued on page 16)

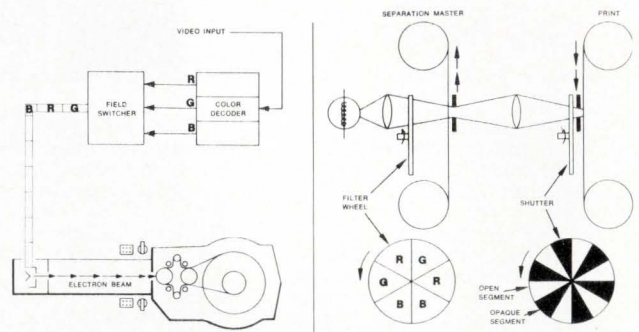

Chromabeam color recorder (left) converts color video tape information to color film. The color is decoded into its three basic colors and printed on black & white film. This B & W film is then sent through a separation master to "reconstruct" the color. From this film a special unit makes color prints or negative for normal movie projector use. The system was developed by 3M Co.

Save money and get tighter specs.

Still using conventional components in your circuit design? Get out your pencil and start your next design with Ferroxcube ferrite pot cores. Now you can produce circuits that deliver better electrical performance at lower cost.

Here's how. Pot cores are completely self-shielding. They are rugged. They deliver high Q, high stability of inductance, plus small size. And they

can meet exceptionally tight tolerances with utter reliability. They come pre-adjusted or adjustable. These characteristics can help you make cost-savings throughout all associated circuitry. Ferroxcube pot cores are ideal for automated production, too, including automatic PC board insertion.

Explore the pot core design approach with Ferroxcube.

It's the broadest line in the industry...97 types in 12 sizes and 5 materials. Plus prototype production quantities off-the-shelf from eight Stocking Centers nationwide. No one else makes pot cores so instantly available.

Send for our latest Linear Ferrite Catalog now. Once you've used pot cores you'll know why so many magnetic component designers are going to pot.

Ferroxcube 
Saugerties, New York

A NORTH AMERICAN PHILIPS COMPANY



STOCKING CENTERS: Boston—(817) 449-1406; Burbank, Calif.—(213) 849-6631; Chicago—(312) 833-4020; Dallas—Gillett Industries, (214) 363-0107; New York—Kahgan Sales, (516) 538-2300; Philadelphia—Eastern Components, (215) 927-6262; San Francisco—Wm. J. Purdy Corp. (415) 347-7701; Woodstock, N.Y.—Elna Ferrite Labs, (914) 879-2497; Toronto, Ont.—Phillips Electron Devices, Ltd., (416) 425-5161.

SALES OFFICES: Baltimore—Eastern Components, (301) 322-1412; Cedar Rapids, Ia.—Thomas & Modricin, (319) 377-6261; Columbus, Ohio—Mulligan & Mathias, (614) 486-2976; Denver—Wm. J. Purdy Corp., (303) 794-4283; Huntsville, Ala.—Cartwright & Bean, (205) 852-7670; Kansas City—Thomas & Modricin, (913) 432-2131; Minneapolis—(612) 920-1830; Orlando—Cartwright & Bean, (305) 425-8284; Phoenix—(602) 264-3129; Rochester, N.Y.—R. P. Kennedy Co., (716) 271-6322; Saugerties, N.Y.—(914) 246-2811; St. Louis—Thomas & Modricin, (314) 338-6446.

Now get the best of both . . .

- The logic flexibility and low cost of DTL
- The speed and capacitive drive of TTL

with

"THE COMPATIBLES"

(More popularly known as the MC9300/8300 MSI Series)

MC9300/8300 Universal 4-Bit Shift Register / *Functions Available* / Shift left, shift right, serial-to-serial, parallel-to-parallel, serial-to-parallel, and parallel-to-serial conversion. Comes complete with a

master reset which sets all outputs to the logic "0" state (regardless of other input states), a parallel enable, and J and \bar{K} inputs which provide full input logic capability for serial data.

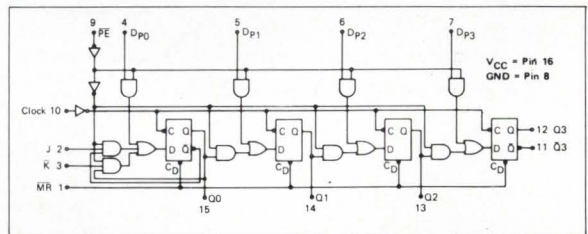

MC9301/8301 BCD-To-Decimal Decoder / *Applications* / Convert the output of a BCD counter to a single line to turn on a light, switch a relay, or "enable" a logic gate to perform a particular function in some predetermined sequence. With the addition of a few external gates, additional functions can be performed. For example, EXCESS-3 to one-of-ten decoders, gray code decoders and digital demultiplexers. For prime application in industrial control and data distribution.

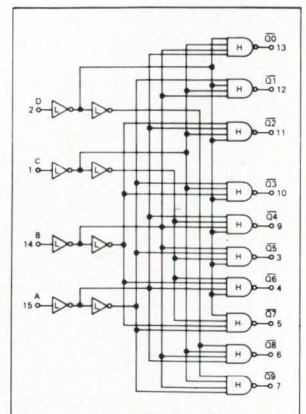

MC9304/8304 Dual Full Adder

/ Features / The device consists of two independent, high-speed, binary full adders, with complementary outputs. Adder two has provisions for both active high and active low inputs as well as a complementary arrangement on

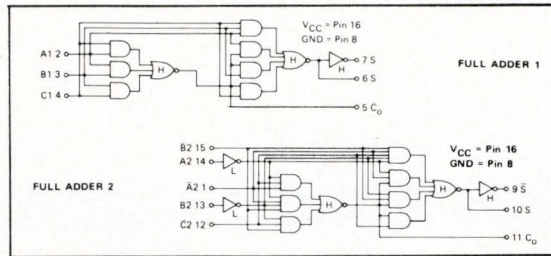

Carry in and Carry out. This input choice and minimum package count.

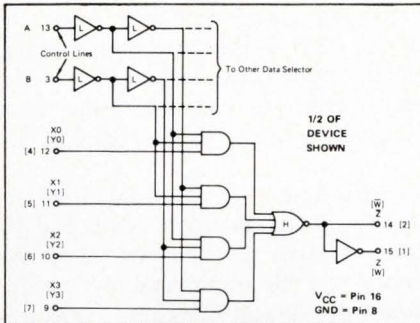

MC9309/8309 Dual 4-Channel Data Selector

/ Applications / Contains two four-channel data selectors with common input select logic and complementary outputs. Selects data present on one of four input lines according to logic states of the select inputs, and routes that information to the output. Useful anywhere digital data is to be routed from one of several locations to another location for processing.

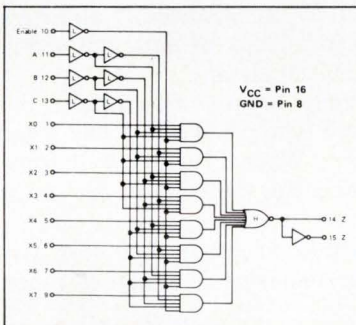

MC9312/8312 8-Channel Data Selector

/ Characteristics / This 8-bit data selector/multiplexer is controlled by three select lines and an "enable" input. The "enable" input allows selection from one of eight inputs when in the low state only. When the "enable" input is in the high state, the Z output will be low and \bar{Z} high, regardless of the select line or input data states. The MC9312/8312 is recommended for application in routing data from one of eight sources, such as a bank of

memories, where the memory address is presented to the select inputs.

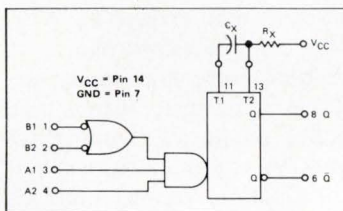

MC9601/8601 Retriggerable Monostable Multivibrator

/ Function and Application / Designed to produce an output pulse of high accuracy. Will trigger on either the positive or negative edge of the input pulse depending upon which inputs are used. The MC9601/8601 will retrigger when in its active timing state and establish its timing cycle

from the last input received. Output pulse width may be varied from 65 ns to infinity by selection of appropriate values of R_x and C_x . Ideal for application in pulse generators, FM demodulators, and digital filters.

Whether you are designing with DTL or TTL, consider these "compatibles" and how they can increase system flexibility and lower package count. All available from Motorola in limited and full temperature ranges, and your choice of ceramic or low cost plastic dual in-line packaging, plus more on the way.

For complete specifications on the MC9300/8300 series write to us at P. O. Box 20912, Phoenix, Arizona 85036. We'll also include details on Motorola's comprehensive DTL line. And for immediate evaluation units call your local Motorola distributor. He'll show you what true DTL/TTL compatibility can do.

- where the priceless ingredient is care!



MOTOROLA
Digital Integrated Circuits

Memory uses solid magnetic wire

Developed by Hughes Aircraft Co., a new mass memory for computers, the "Dynabit," stores information on magnetic wire.

By positioning the magnetic wire on a cylindrical substrate, the memory element is formed in the shape of a helix. Information is entered into the memory element by a stationary write head that controls the state of the magnetic domain at the input end of the wire. Information is strobed statically and is shifted only upon command.

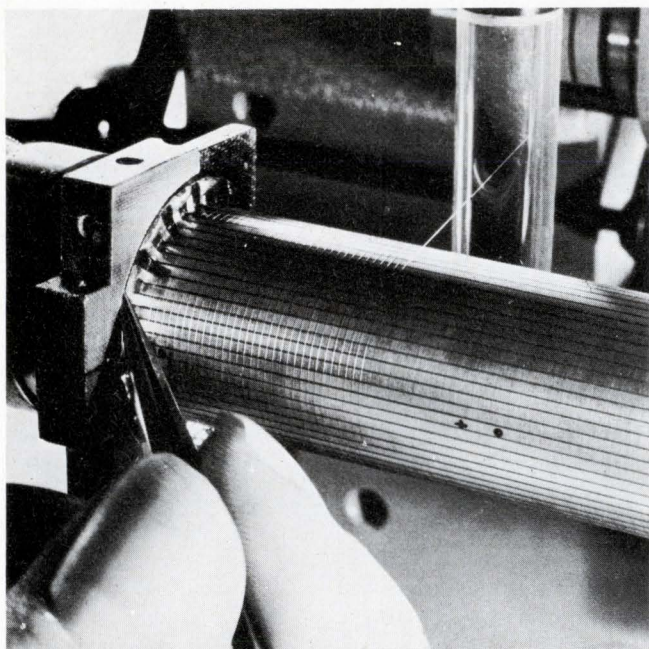

Magnetic wire is wrapped around a "Dynabit" memory element, of a new, all-electronic mass memory system. The device has no moving parts. Storage capacity of the basic element is proportional to the length of wire wound on its supporting tube. At present, this is 1,500 bits of information per cubic inch.

Tape to film (cont'd)

on black and white film in a special field sequential color format.

The color components are fed into an electronic switcher which selects fields of each color and provides an output of color fields in a green-red-blue-green-red sequence. This color sequence allows five color separation images to be printed as two color frames, permitting the conversion of the 60-field/s TV rate to the 24-frames/s rate required for motion picture film.

A continuous motion film transport in the EBR enables recording of 60 frames/s without lost time for film pulldown. The recording electron beam scans horizontally, while the film motion itself provides the verti-

cal scan.

Logically controlled two-phase currents in a pair of adjacent "propagation" windings shift information toward the output end of the wire.

A "read" head, located along the wire from the "write" head, senses the state of the magnetic domains as they pass beneath it. Information is restored to the element in its proper sequence by connecting the sense amplifier at the read head to the write amplifier at the write head.

The latency of the information is determined by the spacing between write head and the read head, and by the propagation time. Unlike a drum or disc, the latency in this memory can be minimized by careful organization, since the information does not move unless directed to do so.

Memory elements generally are arranged in an array, providing random access to a block of data and serial, asynchronous access within the block.

The element is extremely rugged. Essentially, the only way it can be damaged is to physically break some portion with a direct blow. When installed in its protective package, the device can operate in the most severe environment.

Dynabit can be fabricated to produce almost any desired organization, while requiring only half as much electronics to operate.

The mass memory reduces and simplifies computer peripheral equipment, while at the same time increasing the system's reliability and efficiency. It can eliminate the need for buffering equipment, and reduce by 70% the size and complexity of the computer controller.

Primary applications are both large and small secondary memories, competitive with disc, drums and special tape techniques; buffer memories, competitive with core-memory techniques in communications systems; applications where information streams must be transformed in time and space domains; and in pipeline computers, where sequential access is desired.

cal scan.

The black and white color separation film is processed after exposure by conventional developing methods.

After development, the separation film is loaded into the printer, in which each frame of the color film is exposed in sequence to the red, green and blue images, from the black and white master film through appropriate color filters. The printer employs a continuously rotating filter wheel and shutter, with intermittent film motion in both the projector and the camera.

Standard European 50 field/s color video also may be recorded.

FOREFRONT

The EE Forefront is a graphical representation of the practical state of the art. You will find here the most advanced components and instruments in their class, classified by the parameter in which they excel.

A word of caution

Keep in mind the tradeoffs, since any parameter can

be improved at the expense of others. If there is no figure-of-merit available, we either include other significant parameters of the same products, or we provide additional bar graphs for the same products.

Do not use these charts to specify. Get complete specifications first, directly from the manufacturers.

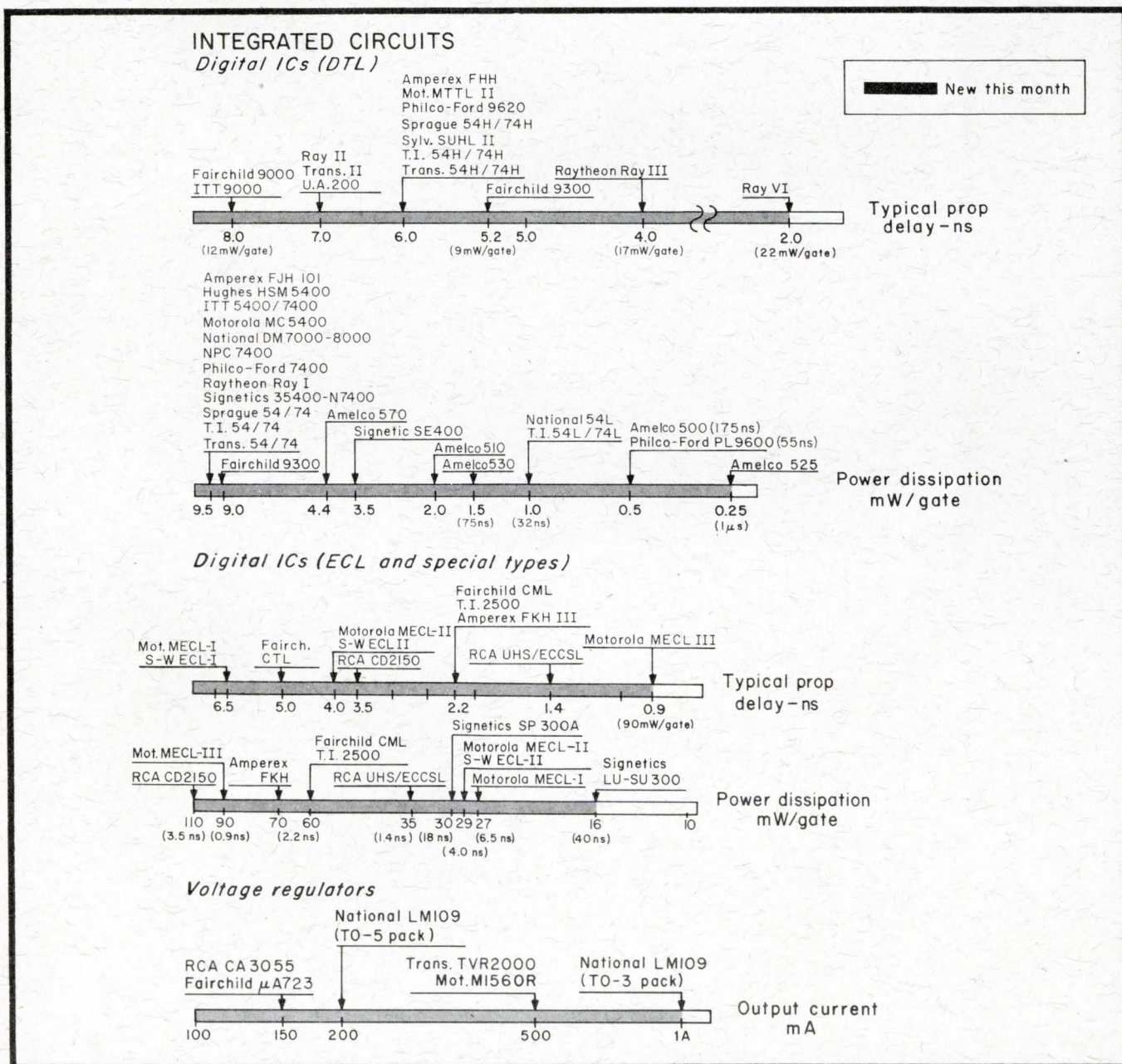

SEMICONDUCTORS

Silicon power transistors (npn)

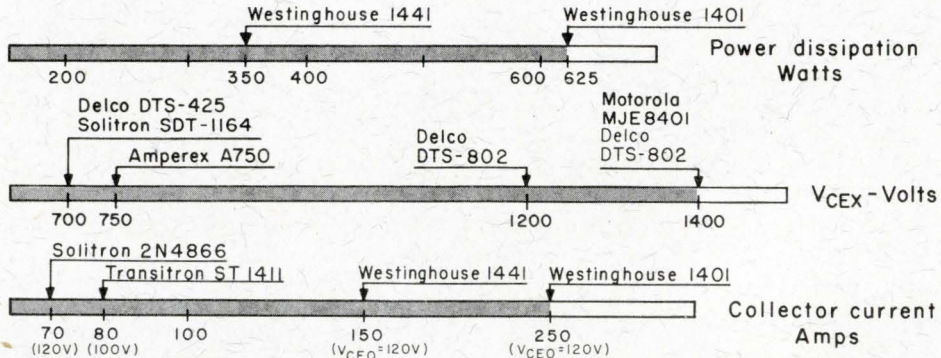

Dual bipolar transistors

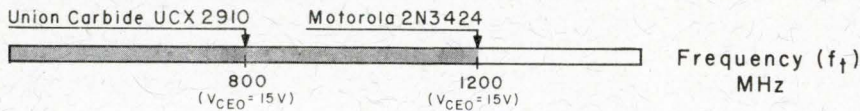

Thyristors

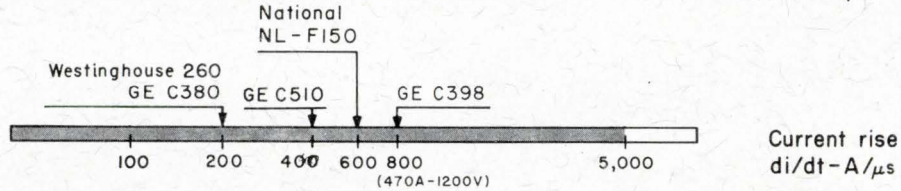
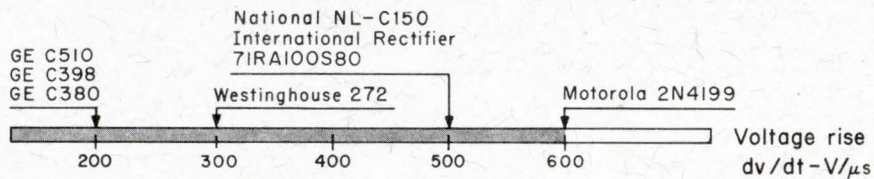
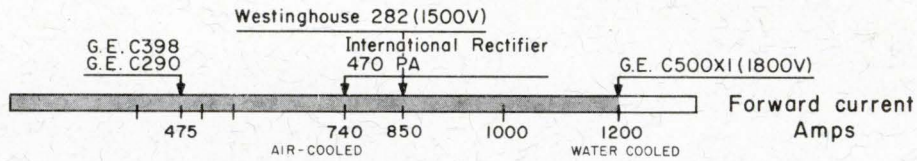

Microwave semiconductors (low noise)

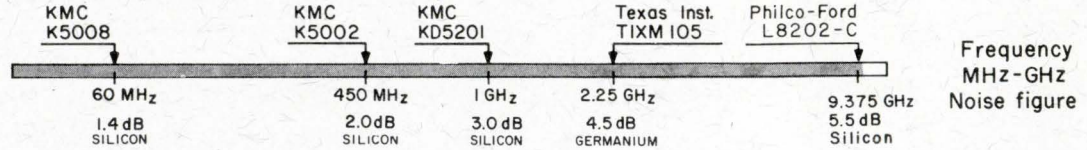

Microwave semiconductors (power)

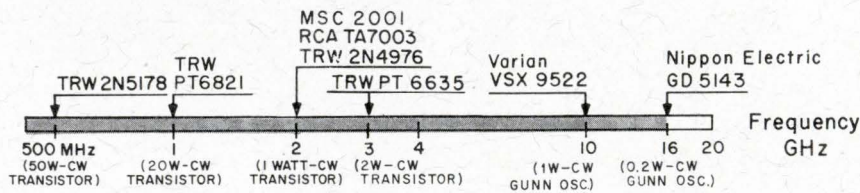

Microwave multiplier diodes

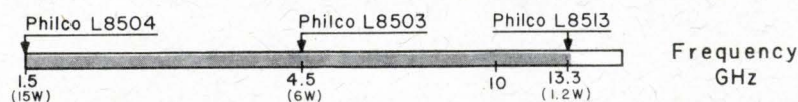



**Behind this disguise
are 1001 ways to
build a more precise
timing circuit at
no extra cost**

The D13T1 Series

PUT

PROGRAMMABLE UNIJUNCTION TRANSISTOR

**Typical Unitorde reliability
in a hermetically-sealed
package suitable for
military use at only
90¢ each in lots of 100.**

■ Functionally equivalent to standard unijunction transistors with the advantage that external resistors can be used to program η , R_{BB} , I_p , and I_v , depending on the designer's needs.

■ Completely planar passivated, hermetically sealed TO18 type package.

■ Even long time-delay designs are more precise, because the PUT's low guaranteed I_p of 150 nA allows use of larger timing resistors and smaller capacitors.

■ For pulse and timing circuits, SCR trigger circuits, relaxation oscillators, and sensing circuits.

IN STOCK, READY TO DELIVER NOW • SEND FOR YOUR FREE SAMPLES AND CIRCUIT DESIGN GUIDE

For fast action call Pete Jenner collect . . . today!



A product of the wide ranging semi-conductor technology of

UNITRODE

580 Pleasant St., Watertown, Massachusetts 02172 • (617) 926-0404

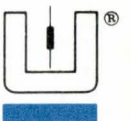

When you're really serious about MSI family planning,

To make a Quad Latch that's both R/S and D compatible,



Fairchild's new MSI 9314 Quad Latch is a versatile, high-speed device that can be used in any application requiring a single-input D-type latch or an R/S-type latch. It has no undefined states in the R/S mode. Its unique multi-function capabilities make it useful in a number of applications:

four-bit storage latches, contact bounce eliminators, multi-input active high set/reset latches, counting and holding display systems, eight-bit addressable latches, A/D conversions, zero and ones catching storage.

The addition of this device to our MSI family gives you everything you need for just about any latching application you could name. Use the new 9314 for maximum function versatility. Or the 9308 Dual Four-Bit Latch when minimum package count is most important. Your Fairchild Distributor has complete specs on both MSI devices.

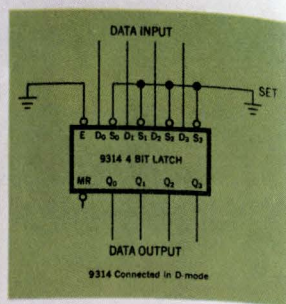

To order the 9314, ask for				To order the 9308, ask for			
PART NUMBER	PACKAGE	TEMPERATURE RANGE	PRICE (100)	PART NUMBER	PACKAGE	TEMPERATURE RANGE	PRICE (100)
14MS9314AN	DIP	-55°C to +125°C	\$19.80	14MS9308AN	DIP	-55°C to +125°C	\$20.00
14MS9314DN	DIP	0°C to +75°C	9.70	14MS9308DN	DIP	0°C to +75°C	\$2.50
14MS9314FN	DIP	0°C to +75°C	21.30	14MS9308FN	DIP	0°C to +75°C	27.00
14MS9314AN	Flat	-55°C to +125°C	19.20	14MS9308AN	Flat	0°C to +75°C	13.50
14MS9314DN	Flat	0°C to +75°C	8.55	14MS9308DN	Flat	0°C to +75°C	3.20

you have to get serious about MSI family planning.

We put together a family plan by taking systems apart. All kinds of digital systems. Thousands of them.

First we looked for functional categories. We found them. Time after time, in a clear and recurrent pattern, seven basic categories popped up: Registers, Decoders and demultiplexers. Counters. Multiplexers. Encoders. Operators. Latches.

Inside each of the seven categories, we sifted by application.

We wanted to design the minimum number of devices that could do the maximum number of things. That's why, for example, Fairchild MSI registers can be used in storage, in shifting, in counting and in conversion applications. And you'll find this sort of versatility throughout our entire MSI line.

Finally, we studied ancillary logic requirements and packed, wherever possible, our MSI devices with input and output decoding, buffering and complementing functions.

That's why Fairchild MSI reduces—in many cases eliminates—the need for additional logic packages.

The Fairchild MSI family plan. A new approach to MSI that's as old as the industrial revolution. It started with functional simplicity, extended through multi-use component parts, and concluded with a sharp reduction in add-ons. Simplicity. Versatility. Compatibility.

Available now. In military or industrial temperature ranges. In hermetic DIPs and Flatpaks. From any Fairchild Distributor.



Nobody makes MSI the way Fairchild does.

FAIRCHILD SEMICONDUCTOR, A Division of Fairchild Camera and Instrument Corporation, Mountain View, California 94035, (415) 962-5011, TWX: 910-378-6400

Fairchild's MSI family plan started with the 9300 Series. Highly versatile, highly compatible devices in seven functional categories: Registers. Decoders and demultiplexers. Counters. Multiplexers. Encoders. Operators. Latches. A minimum number of devices that do a maximum number of things. (Like a register that shifts, counts, stores and converts.)

you don't stop at one family.

Now Fairchild has a new family. Low power MSI. The 9200 Series. All the versatility of the 9300s at 1/4 the power. But low power doesn't mean low speed. Fairchild's new family operates at 5MHz — ideal for military, avionics and industrial low-power, minimum-space applications.

The 9200 family typically features 2mW/gate with 20nsec/gate delay for the optimum trade-off between speed and power. Devices come in both DIPs and Flatpaks. The first six of the economical low-power devices are already in inventory. You can get them today at any Fairchild Distributor.

Here are the first six:

- + 9200 — 4-Bit Register
- 9208 — Dual 4-Bit Latch
- 9209 — Dual 4-Bit Digital Multiplexer
- 9211 — 1-of-16 Decoder
- 9212 — 8-Input Digital Multiplexer
- 9228 — Dual 8-Bit Shift Register

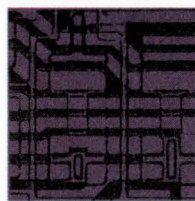

OPERATORS

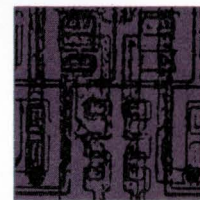

REGISTERS

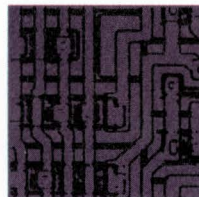

DECODERS AND DEMULTIPLEXERS



COUNTERS

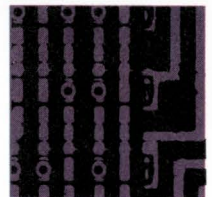

MULTIPLEXERS



ENCODERS



LATCHES

FAIRCHILD
SEMICONDUCTOR

FAIRCHILD SEMICONDUCTOR A Division of Fairchild Camera and Instrument Corporation Mountain View, California 94040, (415) 962-5011 TWX: 910-379-6435

The ingenious engineers

The propriety of calling the group of people who are engaged in the practice of engineering sciences by a term relating to engines has been the subject of repeated questions. (References a, b, c, d.)

Admittedly, there are engineers who are contented with this noun because they deal with engines, such as boilers, heat plants, and locomotives. There are also engineers who, while not dealing with steam plants, are, by virtue of their repetitive and limited application of skill, contented to live with this traditional designation because of inertia, or because their task is one of a perfunctory nature.

The majority of engineers, however, do not deal with engines, and are usually engaged in non-repetitive activities. Calling these people by the noun so closely related to "engine" is an error, a false assumption which came about by accident and not by right.

If we are to believe in Webster (reference e), the name "engineer" derives from old French words, "enginier" or "engineour," which were assimilated by old English as "engynour." The advent of the steam engine produced the term "engineering," which defined the art of managing engines, later—"military engineering," or the art of making and using military engines, and subsequently there evolved the term "civil engineering" and related misnomers.

According to dictionaries, the term is synonymous with fireman, stocker, conductor, motorman (reference f), as well as with: (1) designers or constructors of engines; (2) drivers of engines; (3) builders of military or naval forts, bridges, etc.; (4) anyone who is engaged in or who follows, as a calling, any branch of engineering, etc. (references e, g).

In a classical sense, "engineering" is the art and science which utilizes the properties of matter and the sources of energy in nature to provide structures, machines, and manufactured products for the benefit of mankind (reference e).

It should be understood that in today's usage the term "engineer" denotes at least two groups of practitioners: (1) those who maintain or operate engines or, in general, the sub-professionals, and (2) those who are trained to apply themselves in a professional capacity as ingenious people. The vast difference between the two groups should be recognized by the use of nonsynonymous terms, e.g.,

(Continued on page 24)

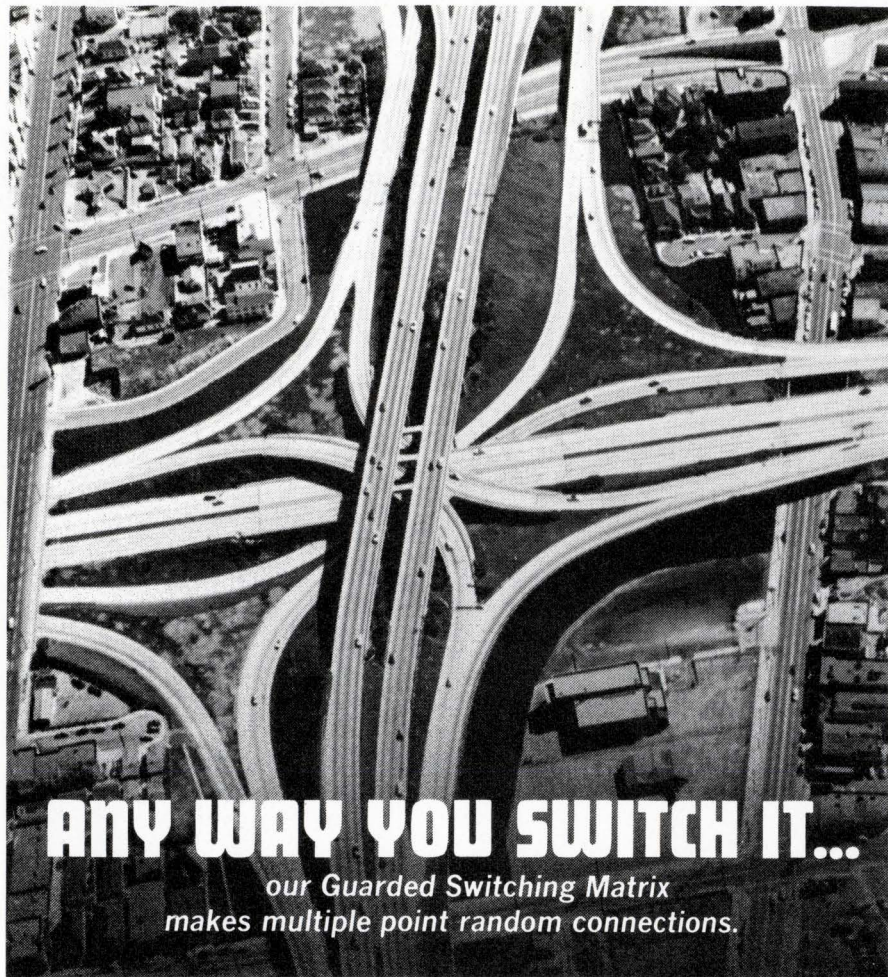

ANY WAY YOU SWITCH IT...

our Guarded Switching Matrix makes multiple point random connections.

The new 3M 3990 Guarded Switching Matrix is the ideal solution for many switching problems in wide applications in automatic test, communication, data acquisition and related systems.

And for good reason. This random access, two-dimensional reed relay switching matrix is designed for applications requiring individual contact memory to enable interconnect of any or all of the inputs or outputs on one side of the matrix to any or all inputs or outputs on the second side of the matrix.

What's more, the 3990 series features solid-state integrated circuit memory for each crosspoint. Programming is in 8-4-2-1 BCD format with TTL logic levels and may be accepted at 100 micro-seconds per switch closure.

Complete guarding techniques make the 3990 ideal in system applications requiring high CMR.

So when connecting a unit under test to various stimuli and measurements, rely on the new 3990 Guarded Switching Matrix by 3M for total systems capability.

For more information, write for our 3990 Series brochure today.

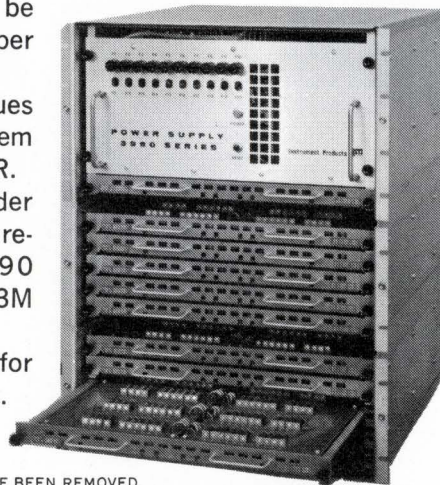

COVERS HAVE BEEN REMOVED.

Instrument & Data Products 3M COMPANY
 300 SO. LEWIS RD., CAMARILLO, CALIF. 93010 • TEL. (805) 482-1911 • TWX 510.866.7099

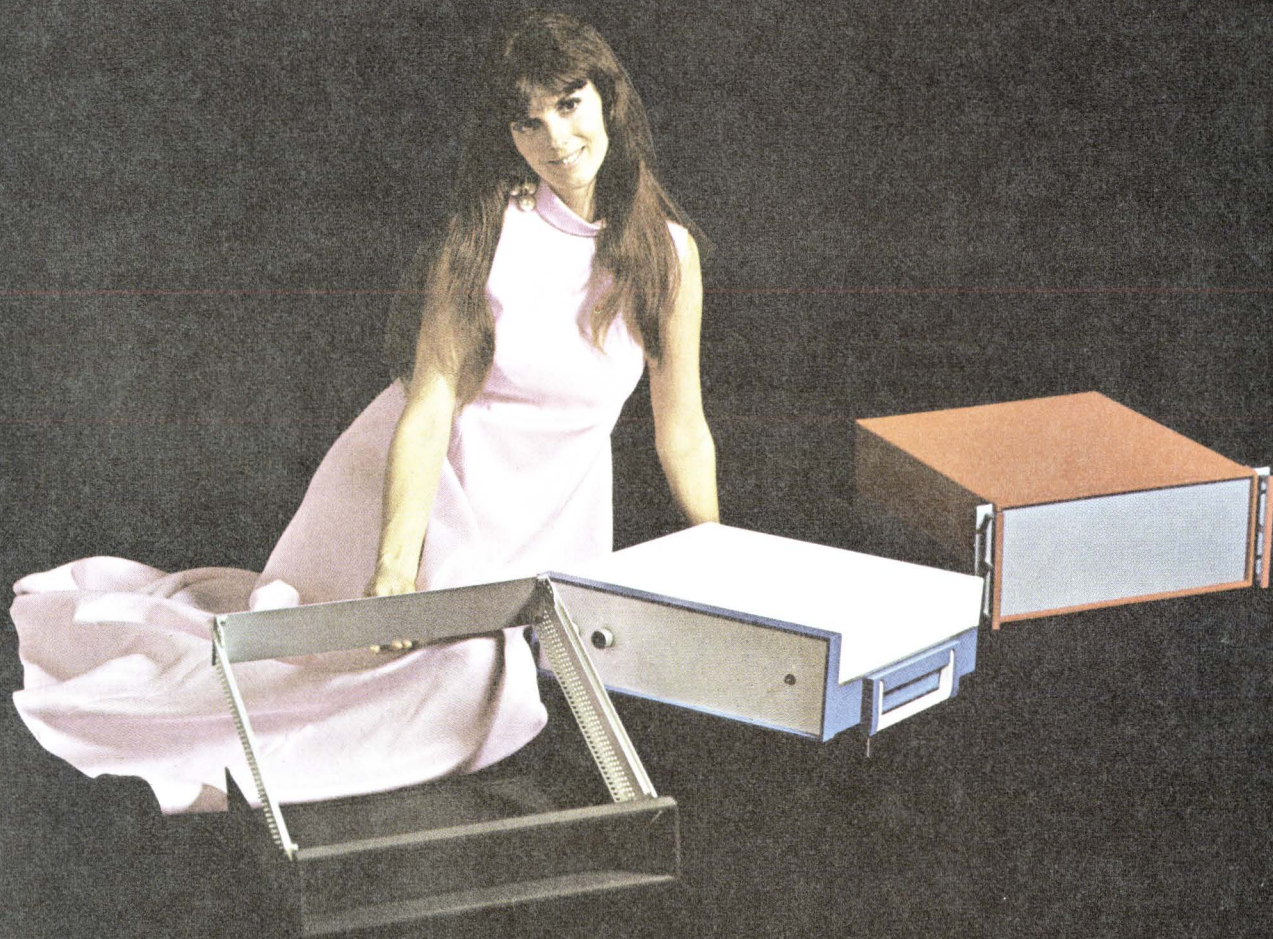

Optima 17
an elegant combination of chassis and case. Rackable.

Optima enclosures, a division of Scientific-Atlanta, Inc. P.O. Box 13654, Atlanta, Georgia 30324. Telephone 404-939-6340

Now it costs less to own the best VOM you need.



The New RCA WV-510A Solid-State Master VoltOhmyst®

The best you need is the new solid-state RCA WV-510A Master VoltOhmyst®. The most functional VOM we've ever produced, the 510A has all the features you'll ever need no matter what your requirements may be.

And we've added some extra features you won't find in any competitive VOM, at any price... features designed to make your work easier, help you get the job done faster.

For example: The RCA WV-510A operates from batteries or AC. Remove the detachable AC line cord while you're taking a measurement and the batteries take over immediately without a flicker of the pointer. And you'll get maximum life from the batteries because they're always on trickle charge during AC operation. Stability? Switch from range to range and watch a whole series of measurements without constantly having to zero-adjust the meter.

Some statistics:

Current:

0.01 milliampere to 1.5 amperes in 8 ranges.

Resistance:

0.02 ohm to 1000 megohms in 7 ranges.

DC Volts:

0.01 volt to 500 volts in 8 ranges.

AC Volts:

0.2 to 1500 rms AC volts in 7 ranges plus peak-to-peak voltages of complex waveforms.

21 megohm resistance on all DC ranges.

And it's only \$128.† complete with DC/AC ohms probe and flexible shielded input cable with BNC connector, and removable AC line cord.

Some statistics! For complete details, contact your local RCA Distributor.

RCA | Electronic Components | Harrison, N. J. 07029

RCA

*Inexpensive Quality

†Optional Distributor Resale Price

SPEAK UP

(Continued from page 22)

"engineer." denoting the nonprofessional or trade level, and "ingeneer" (with the reconstructed spelling), denoting the professionals.

The proposed reform should be undertaken by the respective professional associations, which could, for a starter, correct their own corporate names (e.g., *Ingeneer's* Joint Council, Institute of Electrical and Electronic *Ingeneers*, etc.).

The definition of engineering is, indeed, broad, as was asserted by W. E. Wickenden, the late president of the Case School of Applied Science, who said, "... an engineer is asked not only to be an expert in the technique and economy of materials and energy, of structures and products and utility services, but also to guarantee that society will reap the fruits of scientific advance and technical progress in general well-being." (Reference h.) The dictionaries should, therefore, say that "ingeneering involves:

- (1) the organization and direction of the human effort needed to accomplish the technical objectives of providing materials, products, and services on a sound economic basis for the betterment of the environment of man;
- (2) an ingenious and creative application and exploitation of knowledge, and
- (3) an understanding of the physical environment, man's needs and his relationships with the world, and his inter-relationships with mankind."

In recognition of these broad and taxing activities, let it suffice to say "we, ingeneers, consider ingenuity our maxim, and that we strive to work with, for, and through people, who are and will be our greatest problem."

Leo T. Grinius
The Aerospace Corp.
San Bernardino, Calif.

- a. P. G. J. (Jacobs, P. G.), "All Kinds of Engineers," *Electrical Manufacturing*, June 1957.
- b. Elijah, L. M., "Of Engines and Engineering," *Research and Development*, April 1966.
- c. Berube, R. H. "Define Title of 'Engineer,'" *IEEE Spectrum*, Nov. 1966.
- d. Gilbert, B., "Electronic or Electronics," *The Electronic Engineer*, Oct. 1966.
- e. *Webster's Collegiate Dictionary*, Second Edition, 1953.
- f. *Roget's Pocket Thesaurus*, Pocket Books, Inc., 12th Printing, July 1950.
- g. *Webster's 3rd New International Dictionary*, 1961.
- h. Wickenden, W. D., "Goals in Engineering Education," *Electrical Engineering*, Vol. 64, #2, p. 67, 1945.

Now in the Potter & Brumfield family!

Parelco R10 and SLIMLINE[®] relays give you many design options

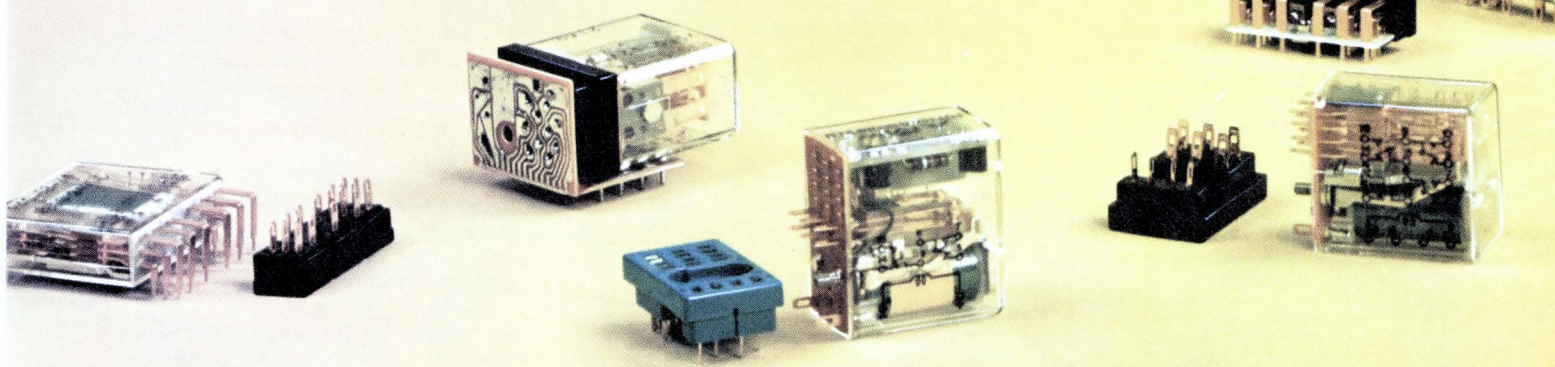

Reliable R10 relay switches up to 8 poles from dry circuit to 10 amperes

Compact, versatile, dependable . . . these features have won for the R10 relay wide recognition in a host of critical applications such as computers, data processing equipment and precision instruments.

Contact arrangements up to 8 PDT (AC relays up to 4 PDT) are available. Six contact styles including single or bifurcated may be specified for switching currents from dry circuit to 10 amperes.

Mechanical life is rated at 100 million operations with electrical life ranging from 100,000 to 100 million operations, depending on load and voltage.

Design innovations, resulting in the optimum distribution between the magnetic core, the pole piece cross sections and coil volume, with a low reluctance armature bearing produce a large force-displacement product. The result: high contact pressure and generous over-travel.

Designers are given many options of terminals and sockets for a wide variety of mountings. A new, right-angle socket (shown above) allows for the R10 to be mounted on a PC board at minimum height.

High density PC board stacking is practical with SLIMLINE[®] relays



The Slimline (R40) has the lowest profile of any industrial relay available anywhere (dry reeds excepted)! When mounted flat on a printed circuit board, its 0.43" height allows for board spacing on 0.60" centers.

Two or four Form C contacts are available in a package measuring only 1.200" x 1.40" x 0.43". Select from five different contacts with switching capacities ranging from true dry circuit to 10 amperes. For low levels, bifurcated contacts may be specified.

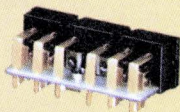

Choose from solder or printed circuit terminals . . . or specify sockets having straight or right-angle terminals. Coil voltages range from 3.0 VDC for IC interfacing to 115 VDC. Mechanical life is rated at 100 million operations. Write or call today for complete information.



Small, variable time delay will switch 4 PDT at 10 amperes

Here is the only solid state variable time delay capable of switching (with a choice of contacts) 4 Form C from dry circuit to 10 amperes. Our R12 Series utilizes the field proved R10 relay plus a high quality solid state circuit. Features include: no false operation, small size, high resolution 15-turn potentiometer, timing ranges from 0.1 to 120 seconds (to 300 seconds on special basis).

SPECIFICATIONS

Repeatability	±2%
Timing	Adjustable with 15-turn potentiometer.
Reverse polarity	Protected.
Timing capacitor	Mil type.

For complete information about the full line of Parelco and Potter & Brumfield relays, call your nearest P&B representative or write direct: Potter & Brumfield Division of American Machine & Foundry Company, Princeton, Indiana 47570. 812/385-5251.

West Coast states, call or write Parelco Operations, 26181 Avenida, Aeropuerto, San Juan Capistrano, California 92675. 714/493-4507.

STANDARD PARELCO RELAYS ARE AVAILABLE FROM P&B DISTRIBUTORS

AMF

POTTER & BRUMFIELD

More Aces for the Bridge Game

VOLTAGES 50 THRU 600 PRV

1.5 AMPERE



Type W
Body: .375" Dia x 9/32" High

3 AMPERE



KBPC — Thru-hole mounting
Body: .75" Sq x .25" High
KBPC2 — Threaded insert
Body: 1.0" Sq x .5" High

5 AND 10 AMPERE



5A — Type **KBH5**
10A — Type **KBH**
Thru-hole mounting for #8 screw
Body: 1 1/8" Sq x 7/16" High

THREE-PHASE
5 AND 10 AMPERE

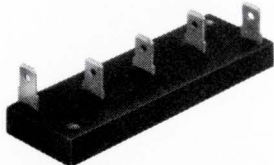

5A — Type **3KBH5**
10A — Type **3KBH**
Two thru-holes for mounting #8 screw
Body: 3" L x 1" W x 5/16" H

1.5 and 3 Amperes immediately available from your authorized General Instrument Distributor.

Write for GI's "Full House" Condensed Catalog and detail bulletins to: General Instrument Corporation, Semiconductor Assembly Division, 65 Gouverneur Street, Newark, New Jersey 07104.



Circle 21 on Inquiry Card

CALENDAR

MAY

10	11	12	13	14	15	16
17	18	19	20	21	22	23
24	25	26	27	28	29	30
31						

May 11-13: NEW Show, Hilton Hotel, Chicago, Ill. Addtl. Info.—Show Office, 100 South Wacker Drive, Chicago, Ill. 60606.

May 11-13: 24th Annual Technical Conf. and Exhibit, Pittsburgh Hilton Hotel, Pittsburgh, Pa. Addtl. Info.—The Show Co., 1605 Cahuenga Blvd., Los Angeles, Calif. 90028, Attn: Wm. R. Brand, Sales Mgr.

May 11-14: International Microwave Symposium, Newporter Inn, Newport Beach, Calif. Addtl. Info.—R. H. Duhamel, Granger Association, 1601 California Ave., Palo Alto, Calif. 94304.

May 13-15: Electronic Components Technical Conf., Statler Hilton Hotel, Washington, D. C. Addtl. Info.—Darnell Burks, Sprague Elec. Co., Marshall St., N. Adams, Mass. 01247.

May 14-15: Southeastern Textile Industry Technical Conf., Marriott Motor Hotel, Wash., D.C. Addtl. Info.—C. R. Williams, West Pt. Mfg. Co., Lanedale, Alabama 36864.

May 17-30: International Electrotechnical Commission (IEC), Washington Hilton Hotel, Wash., D.C. Addtl. Info.—Dorothy Hogan, (212) 683-3058.

May 19-21: IEEE Packaging Industry Technical Conf., Cherry Hill Inn, Cherry Hill, N.J. Addtl. Info.—IEEE, Inc., 345 East 47th St., New York, N.Y. 10017.

JUNE

	1	2	3	4	5	6
7	8	9	10	11	12	13
14	15	16	17	18	19	20
21	22	23	24	25	26	27
28	29	30				

June 8-9: Chicago Spring Conf., Marriott Motor Hotel, Chicago, Ill. Addtl. Info.—Tucker Matzek, Warwick Electronics, Inc., 7300 N. Lehigh Ave., Chicago, Ill. 60648.

June 8-9: First Eastern Electronics Packaging Conf., Mass. Institute of Technology, Cambridge, Mass. Addtl. Info.—Alan Postlethwaite, Sylvania Electric Co., Microelectronics Operation, 100 First Avenue, Waltham, Massachusetts 02154.

June 8-10: International Conference on Communications, San Francisco Hilton Hotel, San Francisco, Calif. Addtl. Info.—A. M. Peterson, Stanford Research Institute, Menlo Pk., Calif. 94025.

June 16-18: NEPCON '70 EAST, New York Coliseum, N.Y. Addtl. Info.—M. S. Kiver, Conf. Chairman, Industrial & Scientific Conf. Management, Inc., 222 West Adams St., Chicago, Illinois 60606.

June 16-18: IEEE International Computer Conf., Washington Hilton Hotel, Washington, D.C. Addtl. Info.—G. L. Tucker, Off. of Sect'y of Defense, Rm. 3E1014, The Pentagon, Washington, D.C. 20301.

June 17-19: PMA Conference, Washington's Sheraton-Park Hotel. Addtl. Info.—PMA, Box 156, Palos Verdes Estates, California 90274.

June 24-26: Joint Automatic Control Conf., Georgia Inst. of Tech., Atlanta, Ga. Addtl. Info.—D. Lyons, Dept. of Textile Sci., Clemson Univ., Clemson, S. Carolina 29631.

'70 Conference Highlights

WESCON — Western Electronic Show and Convention, Aug. 25-28; Los Angeles, Calif.

NEC—National Electronics Conference, Oct. 26-28; Chicago, Illinois.

NEREM—Northeast Electronics Research Engineering Meeting, Nov. 4-6; Boston, Mass.

Call for Papers

Nov. 4-6: 1970 Nuclear Symposium on "Nuclear Instrumentation for Research and Development," New York City, N. Y. Submit 50-word abstract and 500-word summary, due June 15, 1970 to W. W. Managan, Program Chairman, Argonne National Laboratory (D818) 9700 S. Cass Ave., Argonne, Ill. 60439.

Dec. 14-16: IEEE International Symposium on Circuit Theory, Sheraton-Biltmore Hotel, Atlanta, Georgia. Submit two copies of an abstract of 100 to 250 words by June 1. Four copies of regular and short papers must be submitted before July 1, 1970. Address them to I. T. Frisch, Network Analysis Corp., Beechwood, Old Tappan Rd., Glen Cove, N. Y. 11542.

Now! A smaller* Digivac S/GTM display with important new features

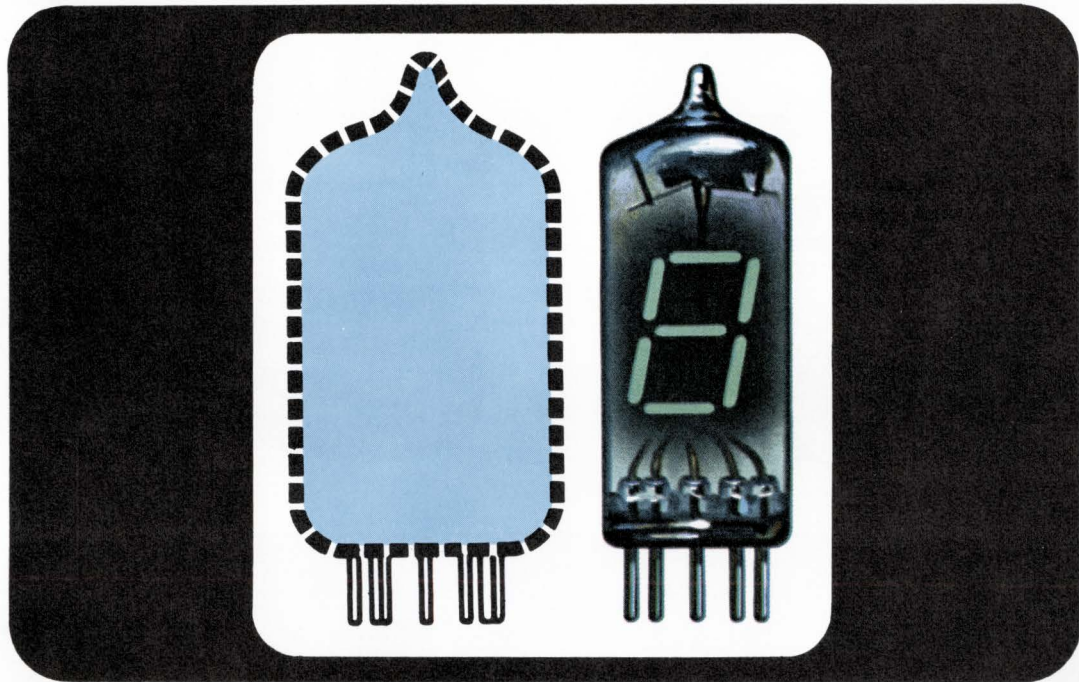

NEW—Requires less space.....NEW—MIL spec construction...
NEW—Electrostatically stable.....NEW—Solderable leads optional

Electrically and optically identical to and interchangeable with the original types... but substantially smaller. Same driver and low power requirements. Rugged construction meets MIL specs for shock and vibration. Impervious to electrostatic influences. No reduction in size of the single-plane, high-legibility, 7-segment character. Eye-ease green can be filtered to provide unlimited colors. Regular 9-pin miniature basing, or 10-pins where decimal is required. Solder-in leads reduce seated height of Digivac S/G displays.

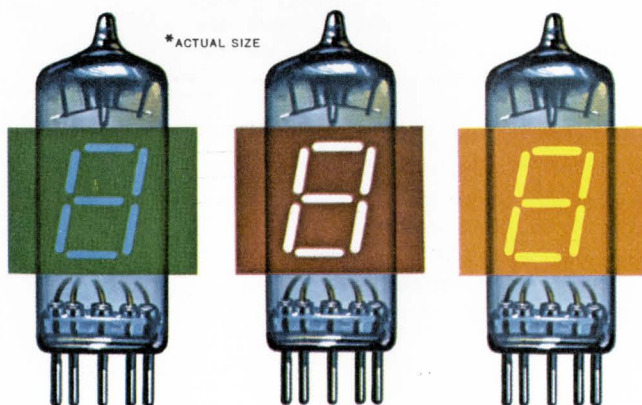

FILTERING PROVIDES COLOR OPTIONS

DIGIVAC S/GTM

VACUUM FLUORESCENT DISPLAY

TUNG-SOL DIVISION
WAGNER ELECTRIC CORPORATION

630 W. Mt. Pleasant Avenue

Livingston, N.J. 07039

TWX: 710-994-4865

Phone: (201) 992-1100; (212) 732-5426

Trademark TUNG-SOL Reg. U.S. Pat. Off.
and Marcas Registradas

NEW! CONDUCTIVE PLASTIC POTS...

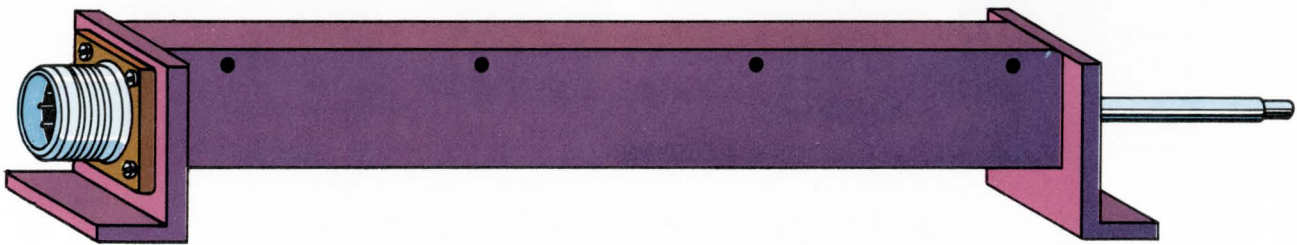
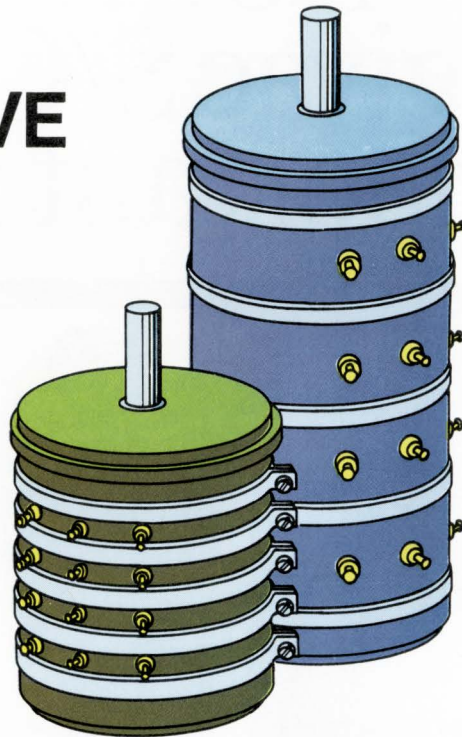
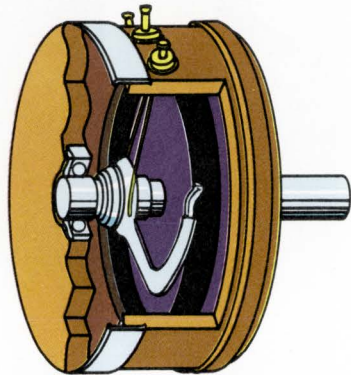

from the leading producer of High Precision Wirewounds

FACT: Over the past 15 years Spectrol has become the leader in high precision wirewound potentiometers. FACT: Spectrol has recently expanded its own precision pot capability to include low-cost industrial cermet and conductive plastic potentiometers. FACT: Now, Spectrol has acquired the highly advanced precision conductive plastic potentiometer capability of Perkin-Elmer in both rotary and linear motion designs. CONCLUSION: Spectrol can now meet your most demanding conductive plastic requirements with the same excellence that has made them the leader in precision wirewound potentiometers.

Standard and Special Rotary Potentiometers Highly advanced co-molded conductive plastic elements enable Spectrol pots to meet high-accuracies in severe environments. Complete capability is available in conductive plastic, as well as wirewound and cermet elements, in any rotary configuration with linear or non-linear functions. Cups with three different kinds of elements can even be ganged into the same pot!

Linear Motion potentiometers We now also offer complete capability in conductive plastic linear motion pots, with the same precision co-molded element technology used in our rotary models.

Miniline Potentiometers And for space savers, we offer our new conductive plastic Miniline multigang pots with cups that measure only .2 inch instead of the usual .5 inch.

More About Our Total CP Capability So whether you are looking for low-cost, industrial CP pots, or high precision units, Spectrol's total capability in conductive plastic potentiometers will serve you best. For more information, circle the reader service card or contact us directly.



PRODUCT SEMINARS

This column lists product seminars that electronic companies offer to users of their products.

Fundamentals of Thick Film Technology: May 18-22, State College; \$500. If you're a non-expert in the field, you'll find this an informative treatment through classroom participation and laboratory work on circuit design, cost analysis, and paste and processing technology. Individual lab experience is offered in screen printing, resistor trimming, microsoldering, and chip and wire bonding. State of the Art Inc., 1315 S. Allen St., State College, Pa. 16801.

Circle 496 on Inquiry Card

Printed Circuit Technology: May 25-28, Washington, D.C.; \$345. The technology involved in the design, fabrication, assembly, and production of PC boards is brought to you in this course. Sylvania, 63 Second St., Waltham, Mass. 02154.

Circle 497 on Inquiry Card

Industrial Noise Control: May 27-29, Cleveland; \$100. The purpose of this seminar is to provide you with information on the fundamentals of noise control methods, materials, and measurements for use in industrial noise control. B & K Instruments Inc., 5111 W. 164th St., Cleveland, Ohio 44142.

Circle 498 on Inquiry Card

Operation and Maintenance 1806 Visicorder: June 1-5, Denver; \$180. The fundamentals of fibre-optic circuits, circuit analysis, modular disassembly, and electrical and optical calibration are covered to prepare you for the operation and application of this instrument. Honeywell, Inc., Test Instruments Div., Box 5227, Denver, Colo. 80217.

Circle 499 on Inquiry Card

Application of Instruments and Instrument Systems to Dynamic Analysis: June 8, Orlando area. The purpose of this seminar is to help you get the best mileage from your SDC instruments and systems. Spectral Dynamics Corp., Box 671, San Diego, Calif. 92112.

Circle 500 on Inquiry Card

Circle 24 on Inquiry Card →

If it's pulser programmability you're after, it's right here, right now.

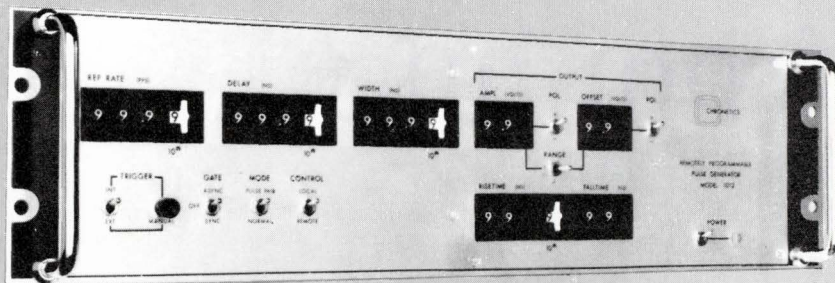

Chronetics' Model 1012. Full digital programmability. Simple current sinking DTL, TTL compatible logic. All parameters programmable. All parameters.

Rep rate to 20 MHz; Risetime 5 ns to 10 ms, typically 3.5 ns at 10 volts into 50 ohms. Amplitude $\pm 10V$ ($\pm 20V$ open circuit); option $\pm 15V$ ($\pm 30V$ into high impedance, e.g., MOS). Offset $\pm 10V$ independent of output polarity, into 50 ohms. Source impedance, 50 ohms.

In stock.

From \$3250*

Model 1012. From Chronetics. The only fully programmable, digitally controlled pulser now available. And its wide acceptance proves it.

You can have an evaluation pulser in your lab, at once, on request. Please request. Put it on your program.

Model 1012—only one of a very complete line of Chronetics' pulsers.

Write now for new Applications Bulletin: Automatic Dynamic Test Systems.

*Model 1012R; \$4000. with manual digital override or local control.

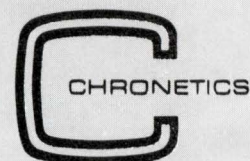

U.S.A.: 500 Nuber Avenue, Mt. Vernon, New York (914) 699-4400 TWX 710 560 0014
Europe: 39 Rue Rothschild, Geneva, Switzerland (022) 31 81 80 TELEX 22266

CHALLENGE

You can't get there from here!

With modern technology,
the electronic engineer
can get transportation
moving and prevent
yesterday's classic line
from becoming tomorrow's
tragic reality.

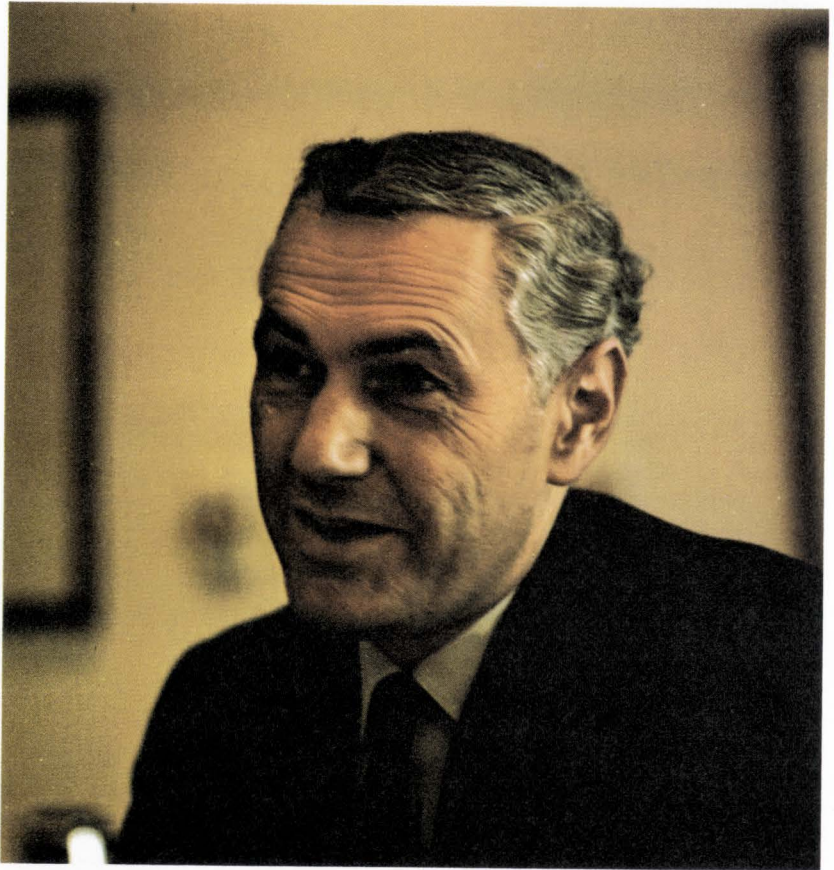

"The challenge . . . is comparable to that faced by NASA a decade ago."

Challenger: James M. Beggs of DoT

“The greatest problem facing transportation systems is communications and control.”

John McNichol, Assistant Editor

Whether it's a trip to the drugstore or clear around the world, today's traveler has to fight missed schedules, overcrowded highways, broken-down equipment and poor service. New developments and inventions don't alter the situation; they only alleviate it for a time and in turn become new crisis areas as ever-increasing demands are made upon them.

It is a small consolation to know that you're not alone when you're stacked up over Kennedy airport for an hour, caught in an interminable traffic jam on the Long Island Expressway, or wondering if the IRT subway will ever start again, and if so, will the doors be frozen shut? But you don't even have to be a New Yorker to feel the problem: nearly 80% of all Americans now live in the cities; by the year 2000 nearly 90% will live in urban areas with an additional 100 million (nearly all city dwellers) in our national population.

The transportation problem is full of contradictions: we move at greater speeds, but a trip may take longer; we have a greater need for public transportation, but it has declined in service and availability; we are more safety conscious, but travel is more dangerous. (The proportion of traffic accidents may be maintained at the so-called “Death Plateau” of 5.3-5.5 deaths per million miles traveled, but the sheer volume of vehicles and trips makes travel a more dangerous proposition.)

The large numbers

If you look at some of the statistics and their projections, the transportation situation becomes awesome, especially when you consider how it touches on such controversial catchalls as congestion, noise and air pollution, and aesthetic values.

- Transportation of people and goods in the United States accounts for more than 20% of our Gross National Product every year, or \$170 billion. Expenditures are predicted to be \$320 billion per year by the end of the 70s.

- Some 235 bus and transit companies have gone out of business in recent years.

- There are 80 million cars in use now in the United States, double the number registered in 1950. By the year 2000, this number will double again.

- Ten-thousand more vehicles appear on our highways every day.

- Domestic airlines will triple passenger miles in 10 years.

- Approximately one-quarter of our population has no access to a car.

- More than 150 million people will travel this year by a U.S. airline.

And as the statistics, projections and predictions continue on and on, you'll hear enough horror stories of deaths, crippling accidents, lost business, subway muggings, law suits and so forth to fill a book. At least there's one bright spot in an otherwise bleak picture—the almost universal recognition that there is a problem and it must be solved.

No traffic jam on the moon

Coming from NASA, where he was Associate Administrator for Advanced Research and Technology, is James M. Beggs, Under Secretary of Transportation. As Secretary John A. Volpe's right-hand man at the Department, he faces the massive task of moving the nation quickly, efficiently and safely. A thoughtful, forceful man, Under Secretary Beggs talks enthusiastically of projects that DoT is sponsoring today, of future programs, and of the electronic engineer's involvement in transportation. Beggs states that “there is a great need for the electronic engineer's contribution throughout the entire transportation situation. The greatest problem facing most transportation systems is communications and control. The electronic engineer must work in this area whether it be for air traffic control, ocean navigation, mass transit systems, public highways or other transit needs.”

Green light for EEs

Calling air traffic control—the problem that snarled our airports last month—“our most pressing problem,” Beggs asserts that “this country is trying to cope with a system that has been expanding at a rate of 10 to 15% a year and will continue in the next decade to grow at a projected yearly rate of 5 to 10%. Against that, we have continued to rely on a labor-intensive system when we should have designed a capital-intensive system.”

What would such a system consist of? Under Secretary Beggs describes it as a system heavily based on modern electronic techniques, such as electronic data processing. For example, he says, “The air traffic controller is still communicating with the aircraft by voice—a very inefficient way to use both the frequency spectrum and time. Imagine, we're controlling all the major functions of the aircraft—takeoff, en-route control, and landing—largely by men pushing little pieces of paper across a board!

“We've automated to some extent certain factors such as the basic computations and the basic switching network, but we've got a long way to go before applying

CHALLENGE

The **FLASH System**, developed by Cutler-Hammer's AIL Division, is an electronic system designed to aid drivers in distress. Located on a 25-mile stretch going east and west on Florida's Interstate and between Lakeland and Orlando, the FLASH (Flash Lights And Send Help) system is initiated by the passing motorist blinking his low beams to high beams three times at a roadside detector placed a short distance before each exit ramp. That roadside detector, activated by the series of light flashes, transmits an identifying tone signal to the central monitoring station whose operator will dispatch aid to that particular stretch of road.

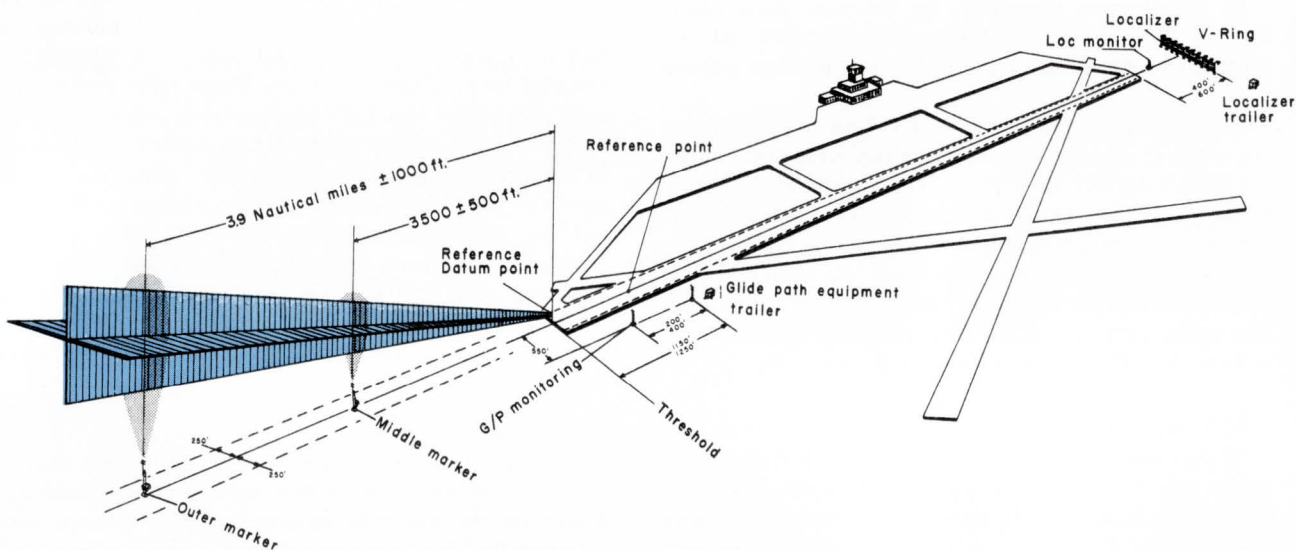
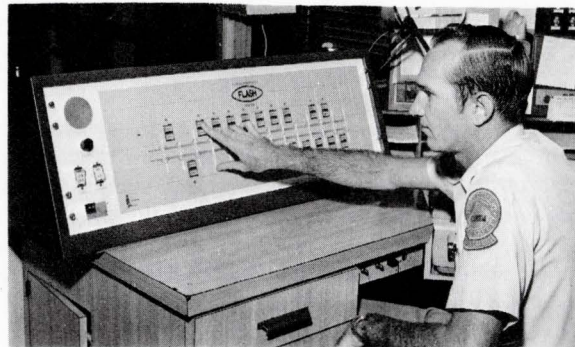

Installed in Tampa, Fla., this solid-state Instrument Landing System (ILS) aids the pilot in landing his aircraft, especially under adverse weather conditions when visibility is limited. By using ILS even during good weather, the optimum glide angle can be achieved thus reducing complaints of noise pollution because of a very low flight path. The Mark I (seen above), manufactured by the Wilcox Division of American Standard, generates and transmits radio patterns to delineate the approaching aircraft's ideal flight direction and angle of descent. Three basic components comprise the system. The vhf localizer equipment, with associated antennas, monitor and remote central/status equipment, provides final

approach azimuth information to the aircraft. The uhf glide path equipment, with the same type of setup as the vhf localizer localizer grouping, provides final approach elevation information to the aircraft and equipment operational status to the remote control point. The vhf marker beacons, with associated monitor and remote control/status equipment, indicate to the pilot his distance from threshold or the beginning of the runway and provide equipment operational information to the remote control point. Wilcox Labs is also developing a Collision Avoidance System (CAS).

AIL, a division of Cutler-Hammer, is also very active in the ILS field, having sold 110 systems to the FAA.

the available techniques and automation to the total air traffic control system.

"We would like to reach a point where, having studied the controller's job, a digital communications system could be developed to telemeter the output of the instruments directly to the ground. Most computations could be handled by the computer and the controller would see only a display of pertinent information; he would act as an overseer. The challenge of developing such a system and implementing it is comparable to that faced by NASA a decade ago.

"It's an enormous job. For the next decade, it will require about \$250 million a year for equipment, mostly electronic, and another \$60 million for research and development for a more highly automated system. The Airport/Airways bill—which has already sailed through Congress—should break loose some money for this fiscal year and certainly for next year."

Working with the FAA in air traffic control are IBM, ITT, Cutler Hammer's to AIL, the Wilcox Electric division of American Standard, Univac, Raytheon and Burroughs. Other companies are working on collision avoidance, turbulence detection, instrument landing systems, and other problems.

Urban mass transit

According to Under Secretary Beggs, the most widespread problem, although not as pressing as air traffic control, is urban mass transportation. "Many of the cities are just running out of highway room, so we can't lay down more highways. We do need comfortable, convenient mass transportation. The difficulty is getting people out of their automobiles and into such a system. Most of our mass transportation systems are not economical, uncomfortable, inconvenient, and they have a bad reputation, especially with women. In the last 20 years, some 235 transit systems have gone out of business. At the same time, the New York subway system raises its fares as complaints multiply. These are all problems that the engineer must give some thought to. He must be able to conceive and design a system that will give the public convenience at a reasonable cost. Again, the answer lies in the automation of communications and control. For instance, present bus systems are not efficient because the companies don't know where the individual buses are. They lose riders and revenue. Most people just won't walk the two or three blocks to wait for a bus.

"In addition, we have the problem of automobiles moving through the cities. The automobile has not had its day, but in the future we'll have a dual mode system where the personal automobile will not be necessary. You may be able to ride into the city by driving a vehicle through your neighborhood and then plugging into a guideway when you reach the city line. Of course, there are many technical, not to mention insurance, problems involved in this kind of system."



"There is a great need for the electronic engineer's contribution throughout the entire transportation situation."

In spite of the failure of present-day transit systems and the glut of automobiles on our roads, Beggs stresses that there is cause for optimism. Mass transit experiments and studies are continuing at this time. In addition, these systems do exist now or will in the near future:

- BART (Bay Area Rapid Transit)—A rapid transit, automated system in San Francisco using the conventional wheels on rails. The cars, for \$66.7 million, were made by Rohr Corp., an aerospace corporation.

- An experimental air cushion system, on a track 20 km in length, is being demonstrated south of Paris, France, by *Societe de L'Aerotrain* and *Bertin et Cie*. The system, which has been clocked at speeds of 265 mph, will be marketed in the U.S. and Mexico by *Aerotrain* and Rohr Corp. DoT has awarded a contract to Grumman Aerospace Corp. to design an air cushion vehicle. A British firm, Hovercraft Co. is also working on air cushion vehicles.

- The linear induction motor (LIM)—Still in the development stage, and with technical problems, this is potentially a highly efficient system for all rapid transit. The British, French, Japanese and U.S. (Garrett Corp. and DoT) are experimenting with it. Current induced in the rail (which acts as armature) thrusts the car forward. Two problems are that the motor needs a variable frequency speed control, and that the power pickoff must work at speeds of 200 mph.

The mobile society

Looking at the next two decades, Beggs cites the need for a high-speed transit system that would run distances up to 300 miles within the population corridors. This system would be linked to a regional airport serving,

As any electronic engineer knows, his profession is not a static one. Instead, it is a dynamic, growing profession with more than its share of growing pains. This growth implies change, and change is what CHALLENGE is all about.

These pages will bring you the trend makers, the policy makers, the men that observe these changes at first hand and, most importantly, that may be able to predict what these changes will mean in the years to come to the electronic engineer. As in preceding installments of our series, our CHALLENGER this month, James M. Beggs, Under Secretary of the Department of Transportation, is an engineer deeply involved in projects that may change the direction of your career within the next decade.

The Department of Transportation, founded in 1966, is responsible for six major agencies, including the U.S. Coast Guard, the Federal Highway Administration, the Federal Railroad Administration, the Federal Aviation Administration and the Urban Mass Transportation Administration. All of these functions, as Under Secretary Beggs makes clear, require the services of the electronic engineer to solve the pressing problems of land, sea, and air transit.

Under Secretary Beggs, who joined the Department of Transportation in March 1969, brings a full and varied background to his present assignment which may be even more complex and difficult than the Apollo mis-

sions. As an Associate Administrator for Advanced Research and Technology at NASA, Beggs was responsible for planning, conducting, documenting and disseminating the results of all NASA research and technology efforts related to space and aeronautics. Another area of his responsibility was the overall management of the Ames, Langley, Lewis and Electronics Research Centers, as well as the Flight Research Center at Edwards Air Force Base. Beggs also coordinated NASA's total program for the supportive research and technology necessary to carry out specific flight missions.

Between 1955 and 1968, Under Secretary Beggs held various executive positions at Westinghouse Electric Corp. including general management of the Underseas Division, Systems Operations, and Surface Division, in addition to vice-president of the Defense and Space Center. While at Westinghouse, he was responsible for the overall management of a number of electronic defense and space systems.

An Annapolis graduate with an MBA from Harvard, Beggs has served as a line officer in various types of ships, including cruisers, destroyers and submarines. In 1954, he resigned his commission as a Lieutenant Commander.

Under Secretary Beggs' memberships include the American Institute of Aeronautics and Astronautics, the American Society of Naval Engineers, and Sigma Tau, an honorary engineering society.

for instance, Washington, Baltimore, Philadelphia and New York City.

The high-speed ground transportation could be a rail type (such as the Metroliner or the Japanese *Tokaido* line, limited past speeds of 160-180 mph), tube-type systems, vacuum systems, magnetic systems, or an air-cushion system, which Beggs regards as the most promising because of its high-speed potential. These systems might be combined with STOL or VTOL.

Land, sea and air

Under Secretary Beggs and his colleagues are taking a hard look at other transportation needs. Among them are highway traffic, coastal and navigation problems, and the upcoming SST.

- In 1969, over 56,000 people, half of them under 25, were killed on our highways. Three and one-half million people were injured. Property damage was estimated between \$13 to 14 billion. With such costly, gory details, obviously the Department of Transportation takes a great interest in highway safety. Under Secretary Beggs voices the Department's concern and

suggests some solutions. "An electronic control scheme for getting people and their vehicles onto and off our highways safely would help a lot. We also need some kind of system to give the driver advance information on what to expect ahead. Most people involved in accidents are in the wrong lane; signs really don't help.

"Another problem area is alcohol. Approximately 50% of the accidents causing fatalities involve alcohol—not just the social drinker, but the problem drinker. Blood tests have indicated that drunken drivers have taken as much as ten 1-ounce shots in one hour. Perhaps some sort of sensing system could be developed that would indicate a certain degree of intoxication on the part of the driver and prevent the car from starting."

- As on land, DoT is very concerned with the transit situation for coastal and ocean waters, since more cargo tonnage goes by sea than by any other mode of transportation. But this accelerated growth, says Beggs, "has become a problem, so navigation and control, in turn, become problem areas. At DoT, we are particularly interested in the collection of data. For instance,

Continued on page 39

Sylvania ushers in the Golden Age of connectors.



With two new off-the-shelf

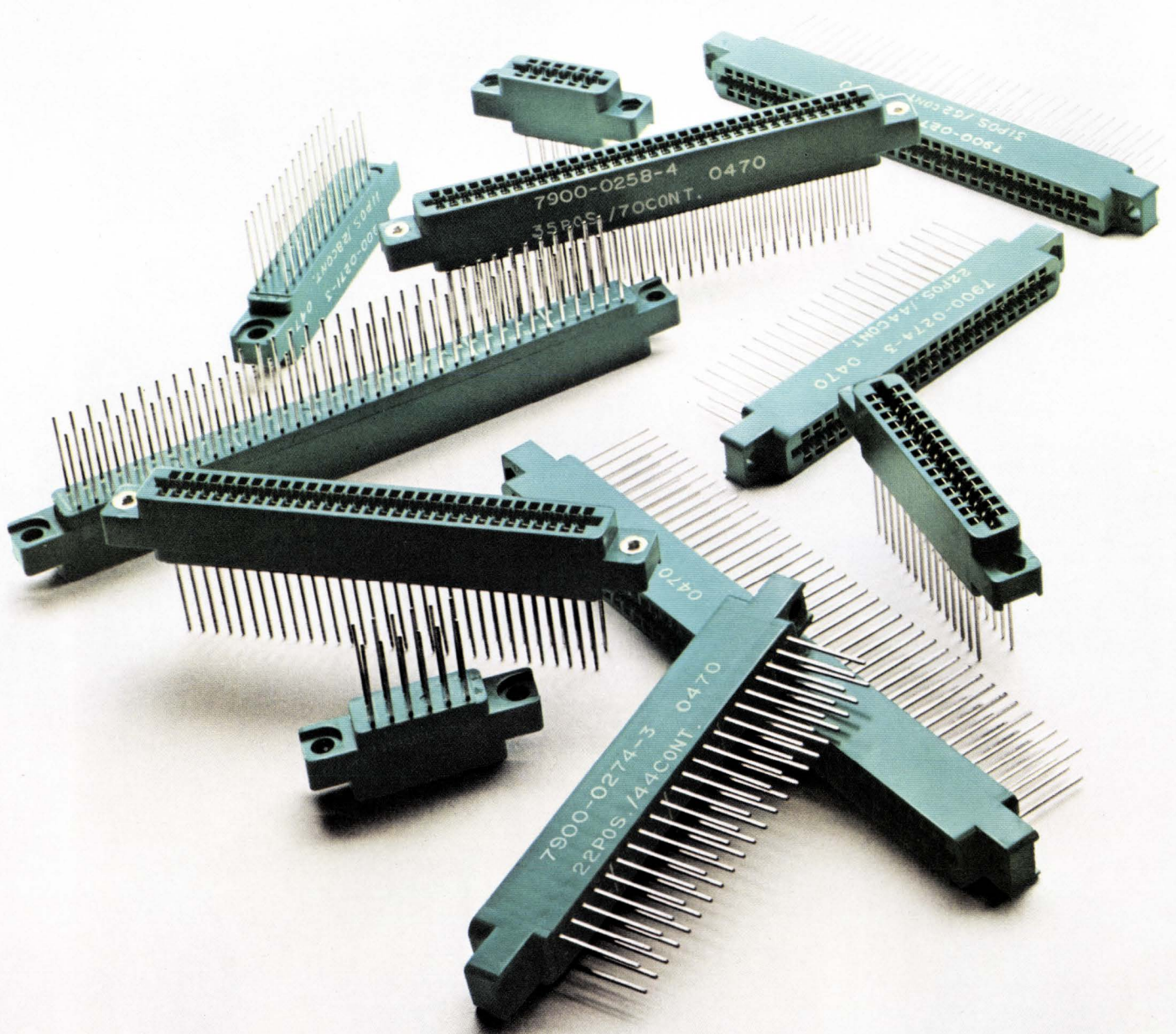

Now we can give you quick delivery even on connectors that used to be considered custom jobs.

Our first new line of PC-card edge connectors runs from 12 to 100 contacts with .125" contact spacing.

Our second gives you 36 to 100 contacts with .100" contact spacing.

For any connector in these lines, you can choose either gold-plated bellows contacts or gold-dot contacts which we've been making reliably for years.

No other manufacturer gives you this freedom of choice of contacts throughout a complete line in the same moldings.

With these connectors, we even manage to save

custom lines.



you money. Tooling costs are on the house. And if you choose gold-dot contacts, they'll cost you less.

Our new connectors—including the gold-dot types—are designed to meet Mil Spec C21097B. Which means they're designed to give you 500 or more trouble-free insertions. We're able to hold the locus point on contact tails within .010" radius

of true position, so you won't have any trouble with your programmed wiring machines.

The main thing is—we've speeded up the process of getting you good connectors.

And that's as good as gold.

Even the oddballs are conventional.

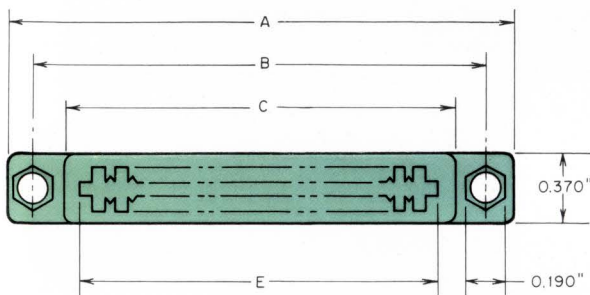

.125" Contact Centers
(Rated for 800 volts DC)

Number of pairs/contacts	Dimensions					
	A	B	C	D	E	F
6/12	1.555	1.295	1.035	.875	.875	.625
10/20	2.055	1.795	1.535	1.375	1.375	1.125
14/28	2.555	2.295	2.035	1.875	1.875	1.625
15/30	2.680	2.420	2.160	2.000	2.000	1.750
18/36	3.055	2.795	2.535	2.375	2.375	2.125
22/44	3.555	3.295	3.035	2.875	2.875	2.625
28/56	4.305	4.045	3.785	3.625	3.625	3.375
31/62	4.680	4.420	4.160	4.000	4.000	3.750
35/70	5.180	4.920	4.660	4.500	4.500	4.250
40/80	5.805	5.545	5.285	5.125	5.125	4.875
44/88	6.305	6.045	5.785	5.625	5.625	5.375
49/98	6.930	6.670	6.410	6.250	6.250	6.000
50/100	7.055	6.795	6.535	6.375	6.375	6.125

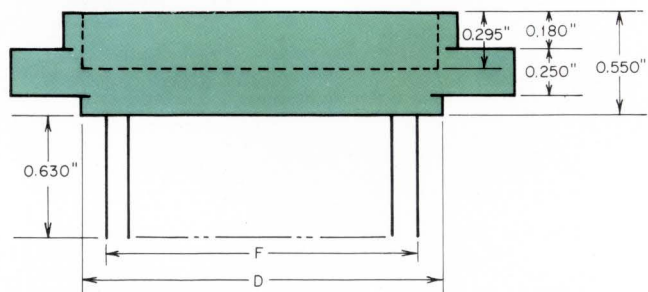

.100" Contact Centers
(Rated for 600 volts DC)

Number of pairs/contacts	Dimensions					
	A	B	C	D	E	F
18/36	2.635	2.375	2.060	1.950	1.900	1.700
20/40	2.835	2.575	2.260	2.150	2.100	1.900
22/44	3.035	2.775	2.460	2.350	2.300	2.100
25/50	3.335	3.075	2.760	2.650	2.600	2.400
28/56	3.635	3.375	3.060	2.950	2.900	2.700
30/60	3.835	3.575	3.260	3.150	3.100	2.900
31/62	3.935	3.675	3.360	3.250	3.200	3.000
35/70	4.335	4.075	3.760	3.650	3.600	3.400
36/72	4.435	4.175	3.860	3.750	3.700	3.500
40/80	4.835	4.575	4.260	4.150	4.100	3.900
43/86	5.135	4.875	4.560	4.450	4.400	4.200
44/88	5.235	4.975	4.660	4.550	4.500	4.300
49/98	5.735	5.475	5.160	5.050	5.000	4.800
50/100	5.835	5.575	5.260	5.150	5.100	4.900

Some technical details

Read between the lines for oddball connectors, such as 19/38 or 46/92. We supply these, too.

Connectors are designed for use with .062"-thick printed circuit cards. They are rated at 3 amps, voltage drop not to exceed 30 mV at rated current. Temperature range: -65 to +125°C.

Connector bodies of diallyl phthalate. Choice of bifurcated gold-plated bellows or gold-dot contacts. Choice of mounting holes: with or without bushing. Choice of plastic or metal polarizing keys.

For more information, write to: Sylvania Precision Materials, Parts Division, Warren, Pa. 16365.

SYLVANIA
GENERAL TELEPHONE & ELECTRONICS

Continued from page 34

the Coast Guard has instituted a procedure, much like an air traffic control system, where ships entering the Chesapeake are assigned different lanes at the entrance.

"We are also deeply involved in the development of a better ocean navigation system to provide capability in coastal waters and in updating a computerized system (AMVER—Automated Merchant Vessel Report) that at present can locate any ship in the Atlantic and will eventually expand to include the world."

- Under Secretary Beggs speaks confidently of Boeing's SST, slated to fly in early 1973, and its impact on world trade and travel. Beggs states that "electronics will obviously play a great part in its design. We will need an efficient and effective navigation system and a stability augmentation system, which are very important in a ship of its type. We feel that this ship will be extremely effective as a transport and at its speed of Mach 3, twice as fast as the French and Russian planes. It has been said that if you reduce the travel time between any two points to six hours or less, you increase travel almost asymptotically. That's what we hope for from the SST."

Pollution

The Under Secretary is also concerned with pollution. His department is responsible for controlling noise pol-

lution. "The acoustics engineer," Beggs asserts, "will have to help develop regulations to monitor noise. He will be in great demand but, unfortunately, we don't have many in the United States. Most acoustic engineers come from England, where their educational curricula include these subjects. We also need an electronic monitoring system to detect major oil spills off our coasts."

Opportunities

DoT's Under Secretary James M. Beggs has taken on a big job, probably the biggest one of his career. But the very size means opportunity—a very broad-gauge opportunity for industry and especially for electronic engineers. As Jim Beggs reiterated again and again, the need is for control, navigation and communications, whether for land, sea or air transit. Whether or not he succeeds will depend in large measure on how well you respond to the challenge of transportation.

INFORMATION RETRIEVAL
Careers

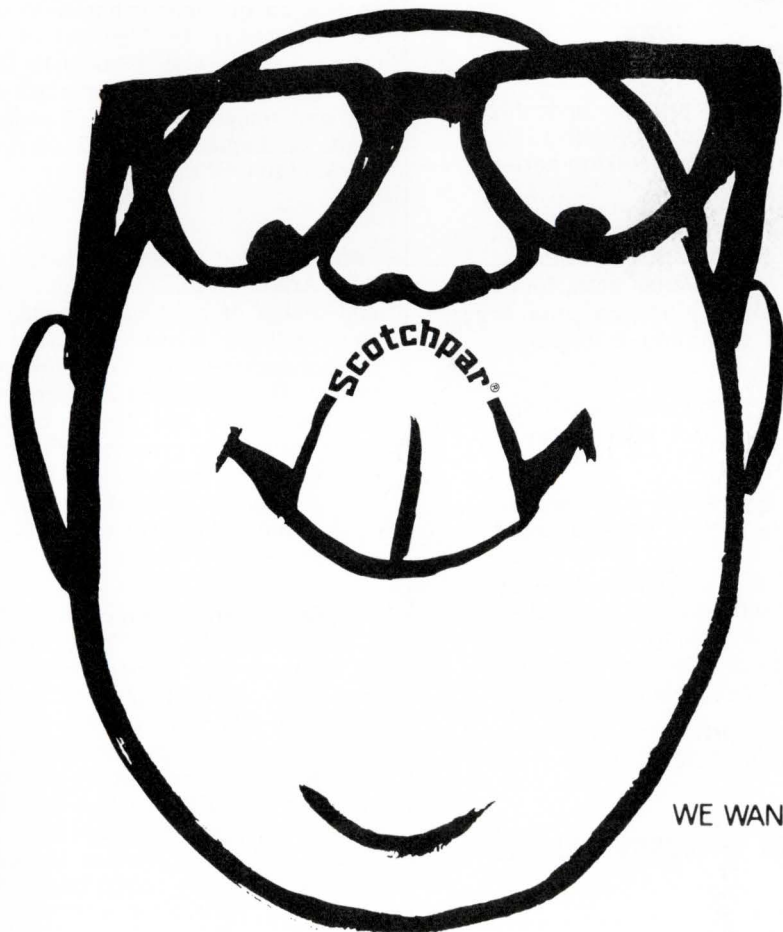

WE WANT OUR NAME ON THE TIP OF YOUR TONGUE!

Scotchpar 3M
BRAND POLYESTER FILM COMPANY



Matheson's NEW and BETTER way to etch silicon

Chemically speaking, E-GAS® is Matheson's new, specially prepared gas for etching silicon. It displaces Hydrogen Chloride as the "NOW" etching method. Practically speaking here's why:

E-GAS gives more effective etching. It enables you to etch through oxide holes with no oxide deterioration or etching of back seal. What's more, E-GAS gives a planar etch, forms flat bottom and holes, is ideal for etching junctions prior to mesa passivation and requires a lower operating temperature (200°C. less than HCl).

E-GAS stands for economy. In addition to the many operating economies accrued, only 1/5 as much E-GAS is required to do the job as compared with HCl.

E-GAS is easier and safer to handle. It's nontoxic, noncorrosive and does not contaminate. As a result, there's no equipment damage.

You can order E-GAS in No. 1A or No. 3 cylinders. Because of its high etching rate, E-GAS is also being offered in mixtures for lower etch rate applications such as etching silicon prior to thermal or pyrolytic oxidation. These mixtures have a 10% concentration of E-GAS in a choice of background gases.

Ask to see our etching engineering report! Write Matheson Gas Products, P.O. Box 85, East Rutherford, N. J. 07073



MATHESON GAS PRODUCTS

A Division of Will Ross Inc.
East Rutherford, N. J.; Cucamonga, Calif.;
Gloucester, Mass.; Joliet, Ill.; LaPorte, Texas;
Morrow, Ga.; Newark, Calif.;
Matheson of Canada, Ltd., Whitby, Ont.

10-69GR

COURSES

Real-Time Digital Filtering and Spectrum Analysis: May 17-20, St. Charles, Ill.; \$390. An understanding of the theory, familiarity with design techniques, an introduction to applications and methods of implementation both today and in the future are what you'll receive in this updated course. NEC Office, Oakbrook Exec. Plaza #2, 1211 W. 22nd St., Oak Brook, Ill. 60521.

How to Make Money With ICs: May 18-21, Phoenix; \$500. As an independent consulting company, ICE is able to present the pros and cons of processing and fabricating techniques as practiced throughout the IC industry. With this knowledge, you may relate these practices to those of your company and apply the most desirable practices effectively. ICE Corp., 4900 East Indian School Rd., Phoenix, Ariz. 85018.

Control Computers: May 21-22, Madison; \$70. An in-depth discussion of the trade-offs, advantages, limitations and alternatives encountered in the application of minicomputers to control projects is the highlight of this course. You'll also participate in a detailed evaluation of interface design and analysis. Univ. of Wisconsin, Dept. of Engineering, 432 N. Lake St., Madison, Wis. 53706.

Semiconductor Circuits: June 1-5, Ann Arbor; \$225. Tools for analysis and design of modern electronic circuits utilizing transistors and other semiconductor devices are introduced to you. Device properties, representative applications and the use of computer analysis are presented. Engineering Summer Conferences, Chrysler Center, North Campus, Univ. of Mich., Ann Arbor, Mich. 48105.

Integrated Circuit Processing: June 1-12, Phoenix, \$3,000. You'll develop an intensive and efficient familiarization with detailed processing techniques for silicon monolithic ICs. The importance of process advantages and limitations, and production yields reveals the potential of effective utilization of IC technology imperative for success in building modern electronic systems. ICE Corp., 4900 East Indian School Rd., Phoenix, Ariz. 85018.

(Continued on page 44)

TI's quiet
revolution in
MSI

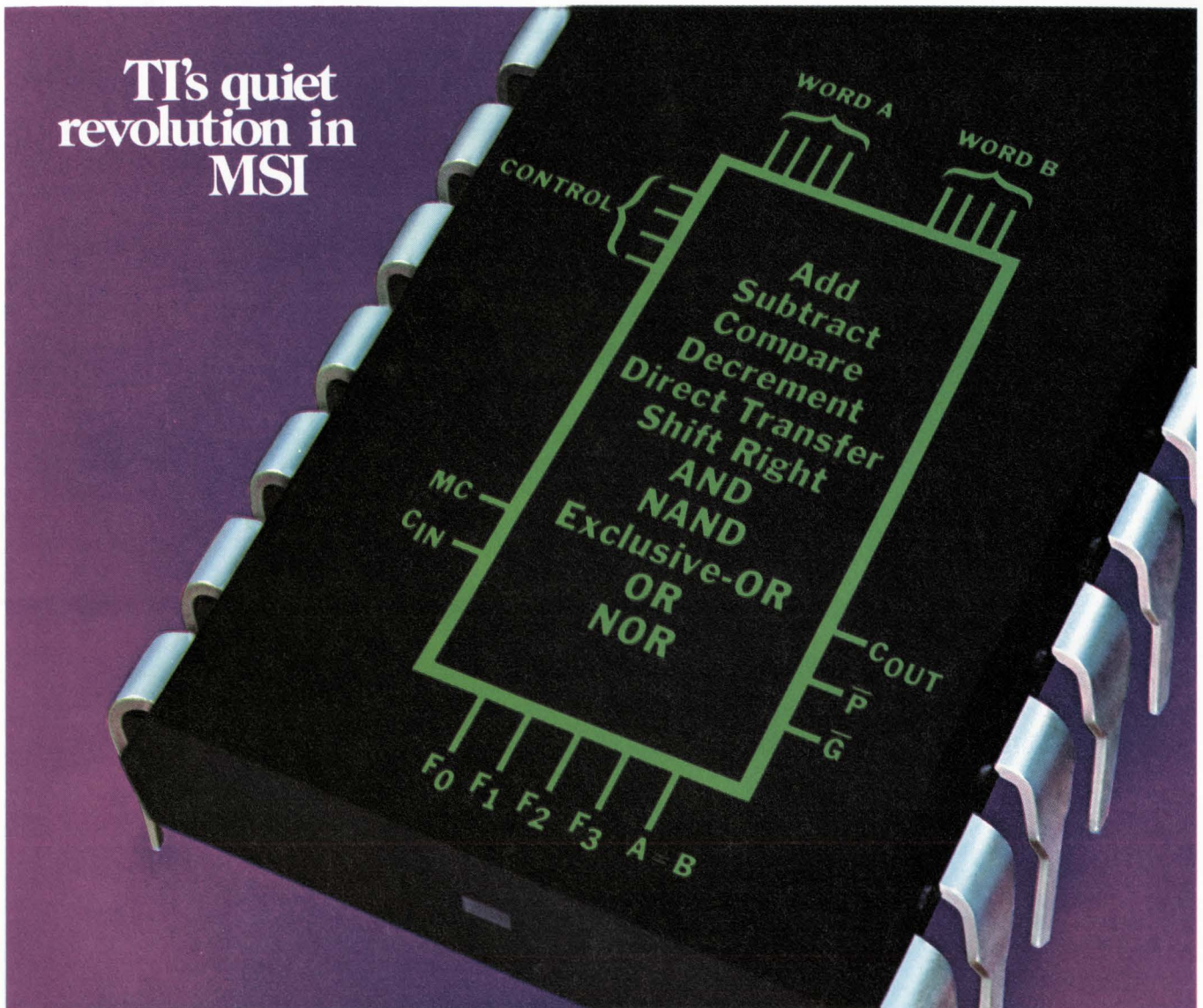

CPU in a 24-pin package:

TI's new SN54/74181 arithmetic logic unit.

Equivalent to 75 TTL gates, TI's new MSI arithmetic logic unit is the closest thing yet to a 4-bit CPU in a package.

The SN54/74181 performs 16 arithmetic binary manipulations on two 4-bit words—including add, subtract, compare, decrement, direct transfer and shift right. It will also perform all possible 16 logic functions of two Boolean variables—including AND, NAND, exclusive-OR, OR and NOR. It's the most complex arithmetic integrated circuit available today.

As for speed, four SN54/74181s can be teamed with one new SN54/74182 carry look-ahead generator to add/subtract two 16-bit words in 36 ns typ.

All of which means that with TI's Series 54/74 MSI, the arithmetic section of your processor has more built-in versatility and flexibility for higher level performance. Economically.

In 100-999 quantities, the dual-inline plastic SN74181 is \$16.50; the SN74182, \$3.63.

Of course, digital processors can be

built with small-scale integrated devices. But as many as 25 may be necessary to duplicate all the performance of just one SN54/74181.

To get your CPU under way this new way, you should have the 184-page supplement to our TTL catalog. Circle 149 on the Reader Service Card or write Texas Instruments Incorporated, P.O. Box 5012, M.S. 308, Dallas, Texas 75222. Or your authorized TI Distributor has copies.



TEXAS INSTRUMENTS
INCORPORATED

microtopics

If you can wait 10 nanoseconds we can save you a bundle.

If you don't need all the speed of TTL, we can save you money with Philco® DTL. It depends upon whether you can tolerate the extra 10-ns propagation delay.

You save money with DTL because you need fewer types to do the job.

The "totem pole" output of TTL doesn't permit wired-OR connections; therefore you have to buy and stock more types to make up different logic functions. With DTL, however, you buy a few basic types, connect their outputs, and get a variety of functions.

DTL is compatible with all popular MSI as well. But if you *do* need the speed of TTL and the functions of MSI, we've got that too... 9600, 7400, and 9300. Ask the better idea people to analyze *your* logic requirements.

CIRCLE 121 ON READER SERVICE CARD

Here's a 256-bit MOS RAM you can get today.

That's what's different about ours... we can *really* deliver it off the shelf.

It's a *complete* read-write memory system on a chip: 256-bit storage, read-write control logic, sense amplifier, and chip-select logic... with speed and total installed cost comparable to a core memory. And it *needs no peripheral electronics*.

Each bit is a bistable flip-flop that permits nondestructive readout. But pattern is 256 1-bit words—expandable to 4096 bits by stacking. Access time? Typically 1 μ s.

CIRCLE 122 ON READER SERVICE CARD

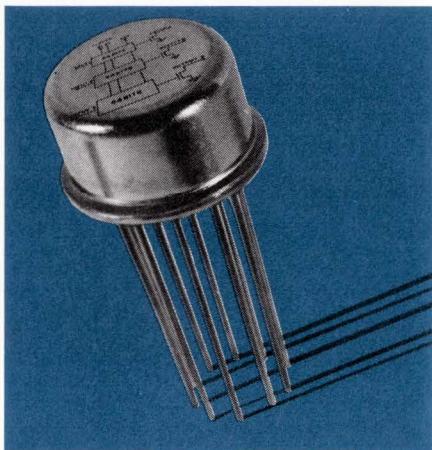
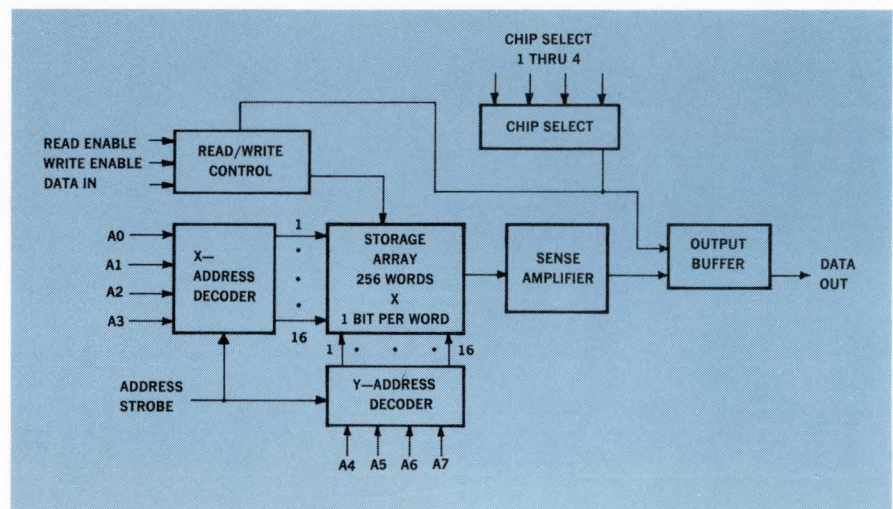

TRIPLE-66 BIT...another MOS shift register from Philco-Ford.

This newest Philco® dynamic shift register is designed to keep your package count down. By using a common power supply, common clock, and common ground, we also minimize the number of wired connections.

This "3-in-1" shift register stores 64 bits of information plus 2 bits of parity on each channel. Shift fre-

quency ranges from 10KHz to 1MHz. Input logic levels are -3 volts for a "0"; -9 volts for a "1." Output capability of each register is 2 ma load current at -3 volts.

Try the pL5R198C for applications like temporary storage, digital rate conversion, precision delays, signal processing correlation.

CIRCLE 123 ON READER SERVICE CARD

We make an impressive array of silicon photodetectors.

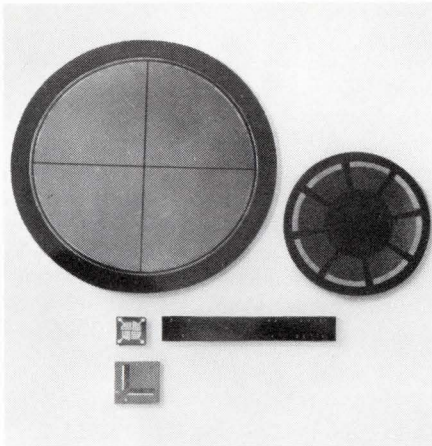

With field-proven performance that's based on 15 years' experience in silicon technology. It all adds up to a broad capability in custom photodiodes, monolithic linear arrays and mosaics—n on p (including guard ring) and p on n structures.

Sophisticated application? We make things like star tracking detectors and sun sensors, high-speed laser detectors and photomixers, flash and explosion detectors, optical fuzes, missile guidance devices, and nuclear radiation monitors.

Want facts and figures? Philco® visible and near-infrared photo devices have specs like these: spectral range of 0.3 to 1.1 microns; sensitivities to 0.60 amp/watt @ 0.9 micron; leakage currents as low as 10^{-13} amp; detectivities $> 10^{12}$ cm-Hz^{1/2}/watt; linear arrays of over 150 elements, each as small as 0.001" square; and array cross talk $< 0.01\%$.

Interested in two-color detection? We combine silicon with InSb to achieve visible and far-infrared detection.

CIRCLE 124 ON READER SERVICE CARD

New, high-bit capacity static MOS ROMs:

You can get Philco® 2048-bit static ROMs custom-made for your application in just 6 weeks. For micro-programming, look-up tables, code conversion, control logic... you name it.

Select the bit organization that fits your needs: 8-bit, 4-bit, 2-bit, or 1-bit words. Need a large memory? Just stack these ROMs for any bit capacity, in multiples of 2048.

Because the pMS2048C is a static device, output data remains valid as long as an address is present... and

the output is compatible with both bipolar and MOS circuits.

Some Philco static ROMs are available off the shelf. The pMS2240C, for example, is a 2240-bit MOS device configured as a character generator. It's preprogrammed and, when addressed by the standard ASCII code, generates 64 alphanumeric display symbols... to create all the characters on a conventional teletypewriter. Access time for first-row bits is 1 μ s, 0.7 μ s for successive bits.

CIRCLE 125 ON READER SERVICE CARD

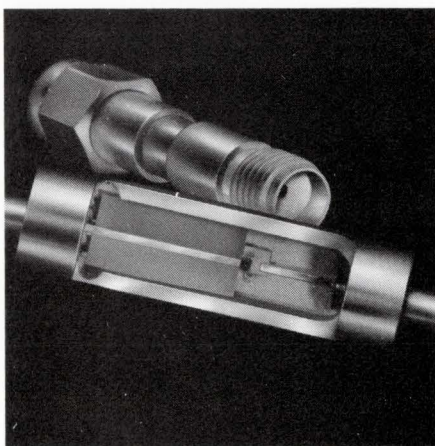
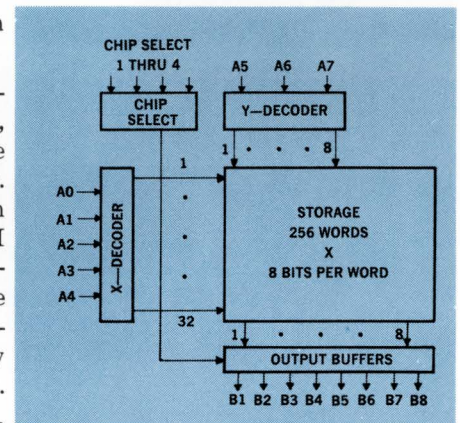

Broadband mixer-detectors... with new mod modules.

Our P5100 Series mixer-detector assemblies are state-of-the-art in the true sense. They're designed with highly efficient Schottky-barrier or backward diode chips in integrated circuit modules for broadband performance from uhf to Ku band.

How? The hermetically sealed module eliminates the package parasitics which limit the broadband per-

formance of conventional semiconductor diodes.

You get performance characteristics like these: 7 db noise figure in mixer applications; 12 db noise figure in Doppler mixers; -55 dbm sensitivity without a requirement for external bias in detector applications.

CIRCLE 126 ON READER SERVICE CARD



There's a lot more to Triad than transformers.

True, there's no one better qualified and equipped to help you solve your transformer problem than your local Triad distributor.

But that isn't his only line. He can also assist you with an arsenal of specialized aerosols, such as motor cleaners, cutting fluids, rust inhibitors, flux removers, mold release sprays, sealants, degreasers, and more.

And besides, your Triad man can serve you with many low cost integrated circuit cards for breadboarding and testing — universal types, cards for flat packs, TO-5's, dual in-line packages, with or without connectors. And any time you need an extractor or a lead bending gauge, you can count on Triad to deliver.

So whether your electronics needs are large or small, direct or peripheral, your local Triad distributor is the one-stop shop that can fill them. Ask for our Triad catalog that tells you more about products and savings. Write Triad Distributor Division, 305 N. Briant St., Huntington, Ind. 46750.

T Triad Distributor Division
of Litton Industries

COURSES

(Continued from page 40)

Integrated Circuits: June 8-12, Ann Arbor; \$225. Emphasizing the point of view of the circuit designer and application engineer, this course will describe integrated circuit fabrication, design, evaluation, and application. Engineering Summer Conferences, Chrysler Center, North Campus, Univ. of Mich., Ann Arbor, Mich. 48105.

Data Communications I: June 9-10, New York; \$165. This course is for you if you have experience in the design of batch-type data-processing systems and want an introduction to data communications, fundamental technical concepts, equipment and service, message control concepts, and software principles. ACM Professional Development, 1133 Avenue of the Americas, New York, N.Y. 10036.

Data Communications II: June 11-12, New York; \$165. This introduces you to the problems of planning for data communications, including determination of service requirements, selection of hardware to fit applications, building adequate controls, and evaluation of proposals and software packages. ACM Professional Development, 1133 Avenue of the Americas, New York, N.Y. 10036.

Automated Circuit Design: June 15-19, Logan; \$300. Theoretical background for automated electronic circuit analysis, design, and optimization will be presented to you and will help you to develop techniques for modeling circuit components for automated analysis, build proficiency in the application of major programs, and survey and apply modern nonlinear optimization techniques. Dept. of Electrical Engineering, Utah State Univ., Logan, Utah 84321.

Electronics Research and Development: June 15-19, Syracuse; \$350. As more engineers enter new research and development assignments in electronics, more engineers move into management positions within this field. Here you will learn to function effectively within the electronics R & D structure. Continuing Engineering Studies Program, University College, 610 East Fayette St., Syracuse, N.Y. 13202.

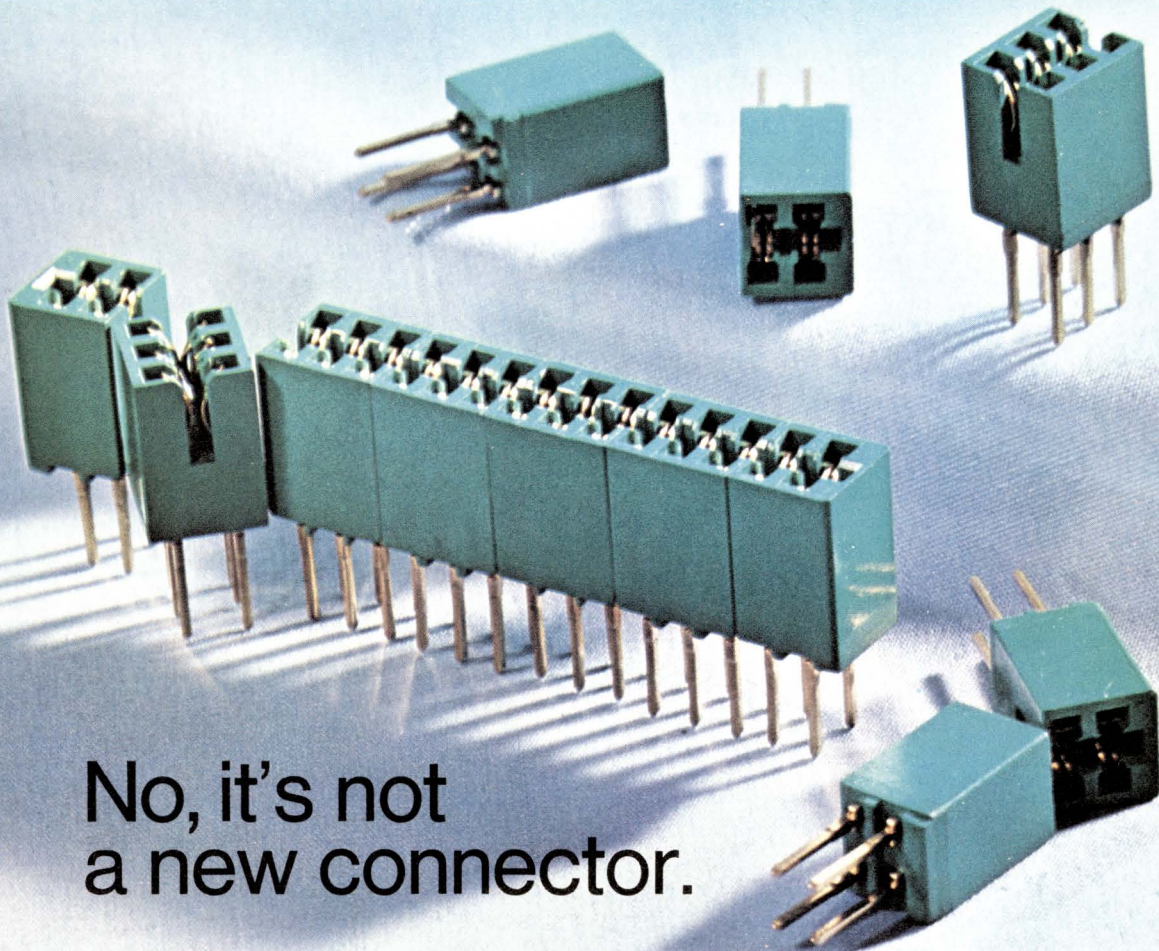

No, it's not
a new connector.

It's a new kind of connecting.

The little connectors above are really one connector. You take as many pieces as you need, mix them together, and use them to connect any size of p.c. board to a mother board.

That's not spectacularly new. Connector modules for use in bread-boarding have been around for a while.

But these new Mojo™ Series 6308 p.c. connector modules* are not just for bread-boards and prototypes.

Not hardly.

When used with plated-through holes on the mother board, they are one of the slickest production tricks to come along in quite a while. Contact tails combine a square wire-wrapping post with a specially designed locking feature which, when press-fitted into a plated-through hole, provides a gas-tight and reliable electrical connection.

No, you don't have to solder.

Yes, you can wire-wrap if you want.

And, yes, you'll save time and money in moving from prototype into production. Because connectors

of virtually any size can be built up economically from just two sizes of modules, you don't need a large inventory. Or custom connectors. And you only have to insert modules where connectors are required, saving a few more pennies.

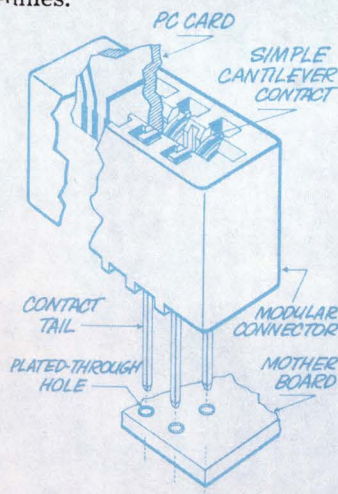

And, no, you don't give up a bit of connector reliability. The exclusive swaged single-beam design of the dual-readout contact provides optimum spring rate and deflection characteristics. A preload applied

to the contact nose in the insulator makes sure that the contact really holds on to the card, while keeping the contacts well apart when the card is removed from the connector.

Mojo™ p.c. connector modules:
Specs in brief

Material

Glass-filled DAP

Contacts

Cantilevered-beam, dual read-out, bifurcated nose. .150" centers. Center modules have 6 contacts. End modules have 4 contacts, molded-in card guide.

Tails

.031" square wire-wrapping type

Mounting

Press fit, in .048" dia. plated-through holes, 3/32" to 1/8" thick board.

For more information, write, wire, call, or TWX us for our Mojo™ p.c. connector module data sheet. Elco Corporation, Willow Grove, Pa. 19090. 215-659-7000; TWX 510-665-5573.

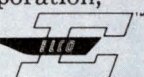

This column welcomes new companies or new divisions in the electronics industry.

Iomec: Big memories come in little packages

Iomec Inc. offers a mass memory system for minicomputers for systems plagued by short memories running only 1,000 to 4,000 words. How? Iomec has solved the problem with its dual disc drive design featuring the Iodisc 1012 and 1011 drives and including provisions for varying word sizes, data formats, command structures and I/O channel signal sequences.

The company was started last year by a team of IBM engineers who developed disc storage from its infancy. Harold Eden, president of Iomec, was responsible for planning, development and market planning of all IBM direct access storage subsystems. Prior to this he supervised the development of the entire 2314 disc storage system. Raymond Herrera, vice president of engineering, was responsible for all direct access and recording technology at IBM, and contributed to the development of the 2311 magnetic head, the most frequently used drive and pioneering device in random access equipment. Donald Johnson, vice president and general manager of the Colorado division, is credited with having achieved the highest recording density on a disc. His inventory includes a magnetic disc coating, a large capacity storage device, and the single-disc removable cartridge.

Iomec's first product, the Series 1000 Data Storage System, includes both disc drives and controllers. The drives employ single disc removable cartridges and are used for access to larger volumes of data, on-line storage extension for lower use programs, and fast access storage for high activity programs.

Components for the system include the Iodisc 1012 and 1011 drives. The Iodisc 1012 drive stores up to 2.2 million bits of information and is used with a removable or non-removable disc. The Iodisc 1011 provides additional storage capacity and may be installed using a single 11 million bit removable disc.

Avery Blake, marketing manager for Iomec, finds his company's strong-point in three product characteristics: first, the unique configuration of removable and non-removable discs; second, the mechanical design in terms

of access mechanisms; and third, a self-contained positive filtration air system. Iomec can save its customers costs in using a single spindle to drive two discs, rather than the usual twin-

spindle disc drive.

Iomec is a privately held corporation, founded in 1968 with the backing of such notable names and investments as EDP Resources, Laurance



MODEL	NE-A	NE-B	NE-C	NE-CC	NE-D	NE-E	NE-EE	NE-F	NE-G
HEIGHT	3 3/8"	3 3/8"	3 3/8"	4 1/8"	4 1/8"	4 1/8"	4 1/8"	3 1/2"	5 1/4"
WIDTH	3 3/8"	4 1/8"	4 1/8"	4 1/8"	7 1/2"	7 1/2"	7 1/2"	19"	19"
DEPTH	6 1/2"	6 1/2"	9 3/4"	9 3/4"	9 3/4"	11 3/4"	16 1/2"	16 1/2"	16 1/2"
VDC	AMPERES								
3.6	2.0	3.8	5.2	11.0	13.1	21.0	32.0	48	85
5.0	2.0	3.7	5.1	10.5	12.6	20.0	31.0	48	80
6.0	2.0	3.2	4.8	9.0	12.4	19.0	30.0	47	80
12.0	1.2	2.5	4.0	7.3	10.0	15.0	21.0	33	56
15.0	1.2	2.2	3.5	6.0	9.0	14.0	19.0	25	45
24.0	0.80	1.4	2.5	4.0	6.7	11.0	14.0	20	32
28.0	0.66	1.3	2.3	3.5	6.0	10.0	13.0	19	28

NOTE: PACKAGES A, F, & G AVAILABLE AFTER JUNE 1, 1970.

NORTH ELECTRIC ELECTRONETICS DIVISION / GALION, OHIO 44833

Rockefeller, Small Business Enterprises Company of the Bank of America and Hornblower & Weeks-Hemphill, Noyes. It began with a five-man staff and grew to over 100 employees

within one year.

The company is located at 345 Mathew St. in Santa Clara, Calif., the site of its 12,000 sq. ft. facility and western regional sales office. An ad-

vanced development laboratory is located in Boulder, Colo., and an eastern sales office in Waltham, Mass.

Circle 493 on Inquiry Card

These **New** standardized power modules were designed the hard way...

The advanced engineering and unequalled reliability you'll find in North's new standard power modules didn't just happen . . . these were developed through 37 years' experience in custom power systems design. Yes, North went the hard way to bring you the exceptional quality and versatility of its new standard power line . . . but it was for good reason . . . to make your choice of standard power supplies easier.

Send for North's new Standardized Power Catalog and start buying your custom power and standard power from one great source . . . NORTH.

Call 419/468-8244 (or TWX 419/464-4860) for immediate service. Attention Product Mgr., Standard Power Equipment.

through 37 years of custom power engineering and problem solving.

A Subsidiary of UNITED UTILITIES, INCORPORATED



Circle 29 on Inquiry Card

A new approach to an old problem

In response to a need in the traveling wave tube field for greater frequency ranges and durable power supplies, a new generation of microwave TWT amplifiers with frequency ranges from 1 to 18 GHz and with rf power outputs of 1, 10, 20 or 100 W has been introduced by Semi/Dyne Electronics Corp., 44 Bennington Ave., Freeport, New York. In addition to TWT amplifiers the new company has been making custom power supplies since its formation in March 1969.

The TWT amps include an all solid state, highly efficient power supply, a half rack-sized unit that weighs approximately 15 lb. In addition, the use of solid state components allows these TWTs to operate under greater environmental stress, as in the aerospace field. Military as well as commercial units are being produced.

The decision to form Semi/Dyne Electronics Corp., was a result of the recognition of growing areas in the electronics industry. The company's founders, A. Harold Wallach, president, Arthur S. Levine, vice president, and Leonard Michaels, operations manager, incorporated their abilities into the field of microwave tubes. The major purpose of the new firm, then, originated as one of designing a new generation of TWT amplifiers and power supplies for TWTs.

According to Mr. Levine Semi/Dyne has recently begun shipping against orders.

Circle 494 on Inquiry Card

Special offer

A "Guide to Thick-Film Hybrid Design" wall chart, 14 by 22 inches, in full color, is available from Sylvania Electric. The chart contains important information about active devices, inks and passive components, along with useful packaging information. For your free copy,

Circle 495 on Inquiry Card

SENSITIVE MERCURY WETTED CONTACT RELAYS

Ultra-reliable, highest quality Sensitive Relays with mercury wetted contacts are ideal for critical applications, such as digital and analog computers, telecommunication systems, multiplex, industrial control equipment and power control devices. New type MWK (center off—SPST) is ideal for multiple channel switching.

ELECTRICAL (Type AWCM):

- Contact Arrangements: Form C and D
- Insulation Resistance: 1000 Megohms minimum
- Current Rating: Up to 2 amps or 500 VDC
- Contact Resistance: 50 milliohms maximum
- Life: 1 billion operations
- Contact Bounce: NONE
- Contact Rise Time: 10 nano seconds or less
- Operating Speed: To 200 operations/second

PACKAGING (Type AWCM):

- Environmental Protection: Hermetically sealed contacts, potted metal case
- Shielding: Internal shielding available
- Shock and Vibration: Withstands all normal handling/transportation effects
- Mounting: Printed Circuit

Advanced manufacturing methods and stringent quality control procedures assure highest quality. Many types available directly from stock. Engineering and applications assistance available. Surprisingly short delivery schedules.

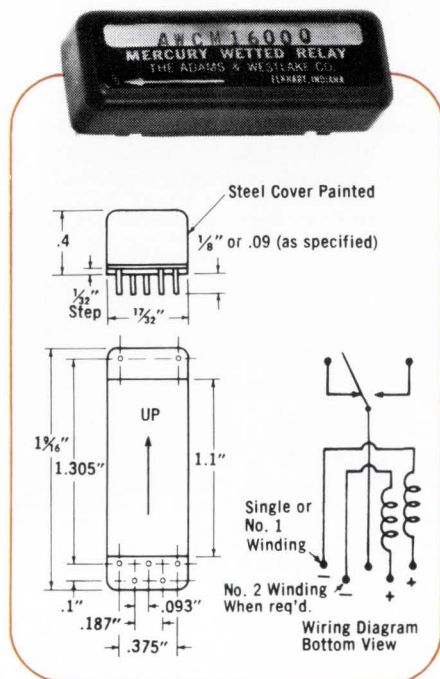

MERCURY DISPLACEMENT RELAYS

Time delay and load relays meet the toughest, most demanding switching applications. Non-adjustable time delay relays offer contact forms A and B with delays up to 1/2 hour, current ratings to 15 amps. Load relays switch from 30 to 100 amps with contact forms A and B.

DRY REED RELAYS

Miniature, intermediate, and standard sizes offer A and B contact forms with from 1 to 4 poles of switching. Typical life is 20×10^6 operations (rated load) or 500×10^6 operations (dry circuit).

USE READER-SERVICE NUMBER FOR COMPLETE INFORMATION



THE ADAMS & WESTLAKE COMPANY

Elkhart, Indiana 46514 • (219) 264-1141 • TWX (219) 522-3102 • TELEX 25-8458 • Cable ADLAKE

SUBSIDIARY OF
ALLIED PRODUCTS CORPORATION

READ THESE BOOKS

The new electronics

By Bruce H. Shore. Published 1970 by McGraw-Hill Co., 330 W. 42nd St., New York, N.Y. 10036. Price \$10.00. 254 pages.

This is a non-technical book which can be read for pleasure and which offers a broad view of electronic evolution. Well illustrated, it has a reading time of from two to three hours.

Instead of tackling all of electronics at once, the author wisely breaks it down into many separate fields, such as electronic memories, superconductivity, holography, and the like. This approach endows each area with a clear perspective, linking earlier discoveries to the events of the present. The way in which simple concepts gave rise to important new directions is repeatedly well-documented. The reader does not have to sift through myriad unrelated events to feel the momentum in each area. Pertinent new techniques and equipment are also covered.

Taken as a whole, the book provides an excellent stimulus for reflecting upon the many forces currently at work throughout the field, and offers a broad view of the continuing progress from vacuum to solid-state technology, from surface to bulk effects, and from radio waves toward light.

A History of Electrical Power Engineering

By Percy Dunsheath. Published 1969 by The MIT Press, 50 Ames St., Cambridge, Mass. 02142. Price \$2.95. 368 pages including index.

Doping and Semiconductor Junction Formation

By Marshall Sittig. Published 1970 by Noyes Data Corporation, Park Ridge, N. J. Price \$35.00. 318 pages.

Introduction to Powder Metallurgy

By Dr. Joel S. Hirschhorn. Published by the American Powder Metallurgy Institute, 201 E. 42 St., New York, N. Y. 10017. Price \$15.00. 341 pages.

Directory of Testing Laboratories Commercial and Institutional

Compiled and published by the American Society for Testing and Materials, 1916 Race St., Phila., Pa. 19103. Price \$3.00. 28 pages.

Radio Handbook

Eighteenth Edition. By William I. Orr, W6SA1. Published 1970 by Editors & Engineers, Ltd., New Augusta, Indiana. Price \$13.50. 896 pages.

Microelectronics

Compiled and published by the Research and Education Association, 342 Madison Ave., New York, N. Y. 10017. Price \$15.75. 448 pages.

Calculus for Electronics

By Albert Paul Malvino. Published 1969 by John Wiley & Sons, Inc., 605 Third Ave., New York, N. Y. 10016. Price \$9.95. 304 pages including index.

Electrons in Metals and Semiconductors

By Denis Greig, Ph.D. Published 1970 by McGraw-Hill Book Company, 330 W. 42 St., New York, N. Y. 10036. Price \$13.50. 167 pages.

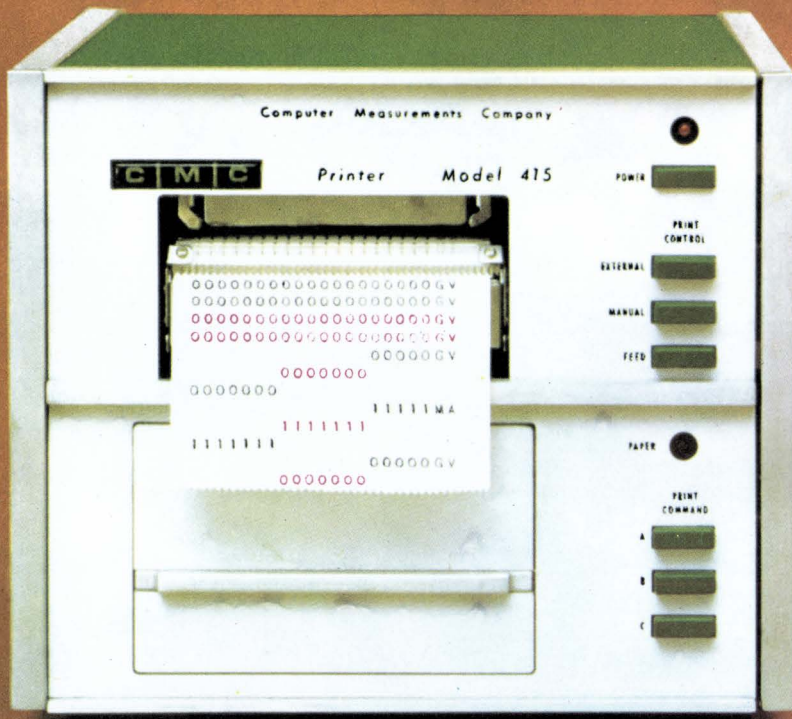

*Now take a peek
at the world's
greatest printer...*

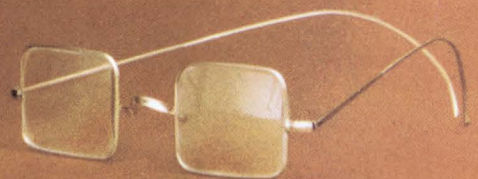

Outclasses the competition ten ways!

This new CMC Model 415 Printer is so good, we don't want to obscure the facts with advertising rhetoric, so here are ten reasons why the 415 is your best buy:

1. The mechanical printing mechanism is good for more than 5,000,000 cycles without an adjustment, is replaceable in the field, and provides legibility of an electric typewriter.
2. Floating decimal point and automatic zero suppression are standard features.
3. Line capacity from 7 to 21 columns is offered; and red/black printing with color selection by numerical field is provided.
4. Internal programming is included to allow printing any input data character into any printed column.
5. Controls can be programmed remotely.
6. Unique "print-command" feature allows priority control over the 3 input channels
7. Prints 3 lines-per-second—more speed than needed for

most applications—and allows use of either paper tape or fan-fold stock.

8. Full IC design provides accurate reliable performance, and IC sockets make maintenance easier.

9. Measuring only 8½" w x 7½" h x 17½" d, this handsome, lightweight instrument is designed for a vast diversity of data logging applications.

10. And to top it all—this great little printer sells for as low as \$1295!

For the full specs, circle the reader service number; and for a demonstration, contact your local CMC representative.

COMPUTER MEASUREMENTS



A DIVISION OF NEWELL INDUSTRIES

12970 Bradley / San Fernando, Calif. 91342 / (213) 367-2161 / TWX 910-496-1487

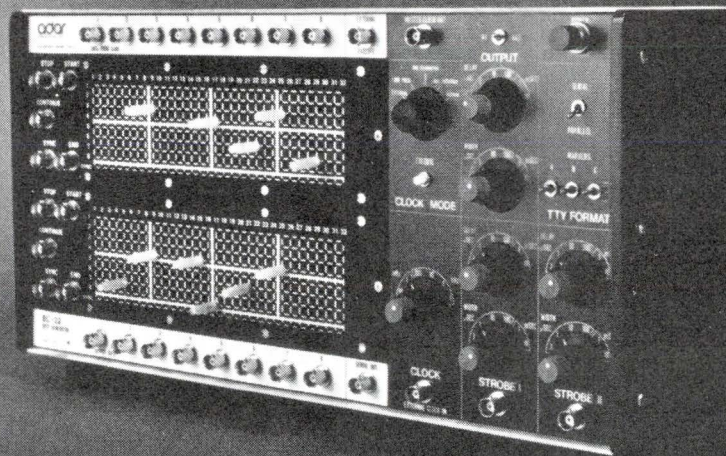

The 1970 Economy Compact EC-22 Byte Generator.™

The versatile, low-cost, EC-22 Byte Generator is unique in all the world. It's a compact, plugboard-loaded, easily-programmable pattern generator that can be yours for only \$2,500.*

Standard equipment features of the EC-22 include: 32 eight-bit bytes;** serial or parallel output; variable "Master/Slave" stacking units; up to 8MHz bit or byte rate.

Breakaway from the dull, ordinary lab testing routine with the new EC-22. It really makes it. Use it for testing IC's, LSI's, and PC's . . . for simulating computer output and telemetry . . . for generating analog functions.

If you use an oscilloscope at your lab or production facility, you could be EC-22 material. Find out. Write to us today for more information about the EC-22 Byte Generator. Move up to Adar.

Adar Associates, Inc., 85 Bolton Street, Cambridge, Mass. 02140. (617) 492-7110. Call Bill Noren, collect.

*Manufacturer's suggested retail price. State and local taxes additional, if applicable.

**Optional 64 eight-bit byte double-plugboard model \$1,000 extra.

MOS course—Part 4

Complementary MOS

Complementary MOS
logic and applications p. 52

This month's installment of the course on MOS integrated circuits concerns a different type of MOS—complementary or c-MOS. Up to now, our discussions have been about single polarity MOS devices; in almost all cases p-channel.

They're not the same

Complementary circuits differ from their single polarity cousins in a variety of ways. To start with, complementary circuits are constructed differently. The more familiar p-channel transistor has the p+ source and drain regions diffused into a crystal of n-type silicon. In complementary MOS, however, the basic building block is not a single transistor, but is instead two transistors in series—one p-channel and one n-channel. To manufacture a c-MOS device, you start with the same n-type silicon, but besides diffusing the p+ source and drain regions for the p-channel transistor, you must also diffuse a large p-type region to act as the substrate for the n-channel transistor. Then, into this p-type region are diffused the n+ source and drain regions for the n-channel transistor.

Complementary MOS offers some unique advantages over single polarity devices. Probably the most notable of these is in the area of power dissipation. Because they have two transistors in series, complementary circuits consume very little quiescent power. In either logic state, one transistor or the other is off. This means that there is no dc path to ground in the circuit and the only power dissipated is due to the leakage through the off transistor. This feature makes c-MOS

particularly well suited for aerospace applications and in battery-operated equipment.

Low power dissipation, however, is not the whole story of c-MOS. The article that begins on page 52 also details such features as simplified clocking, single power supply operation, and high-noise immunity.

The Price you pay

As is always the case, the advantages of c-MOS come with a price tag attached. In this case the penalties are two—packing density and cost.

The problem of packing density is fairly obvious. Complementary MOS uses two transistors to do the same job that one does in many p-channel circuits. For a relatively complex function, a c-MOS chip is on the order of 25 to 30% larger than an equivalent p-channel chip. This reduced packing density also contributes to increased cost since the price of any integrated circuit is directly related to the chip size. As chips get bigger, yields go down and costs go up.

One other factor that contributes to higher costs is processing complexity. A complementary MOS circuit goes through more steps because of the additional diffusion steps required. Each step in the manufacturing process adds its own increment to the total cost.

Complementary MOS then occupies its own unique slot in the integrated circuit world. It is there for those special applications which require its special advantages and which can pay the price of increased cost and reduced packing density.

MOS Course—Part 4

Complementary MOS logic and applications

Combining p- and n-channel devices on the same chip gives you a unique kind of MOS.

By S. S. Eaton

RCA Electronic Components, Somerville, N.J.

Conventional MOS circuits are constructed with single polarity MOS devices—in most cases p-channel, enhancement mode transistors. Basically, the devices consist of a single crystal of n-type silicon which has p-type drain and source regions diffused into it.

Complementary MOS, on the other hand, combines devices of both polarities on the same chip. In this case, the basic building block is not one, but two MOS transistors—one n-channel, enhancement mode, and one p-channel, enhancement mode.

Complementary-symmetry MOS (COS/MOS) logic circuits offer micropower quiescent operation, high-noise immunity, single-phase clocking, large fan-out capability, stability over a wide temperature variation, and operation from a single supply over a wide voltage range. These circuits are useful in a wide variety of medium-speed (dc to 5 MHz) digital applications ranging from aerospace and military use to industrial communications and control functions.

At present, all COS/MOS integrated circuits are constructed using two basic building blocks—the inverter and the transmission gate. The basic inverter forms all NAND and NOR gates. Combined with transmission gates, the inverter forms more complicated circuits such as D-type flip-flops, counters, shift registers, arithmetic blocks, and memories.

The basic inverter

The basic inverter consists of one p-channel and one n-channel enhancement-type MOS transistor. When 0 V

is applied at the input of the inverter (logical 0), the gate-to-source voltage (V_{GS}) for the p-channel device equals the supply voltage ($+V_{DD}$); therefore, the p-channel unit is on. For the n-channel unit, V_{GS} equals zero, and therefore the n-channel unit is off. In this case the output voltage is equal to V_{DD} and is a logic 1. Similarly with an input voltage of $+V_{DD}$ (logical 1), the output voltage swings from $+V_{DD}$ to essentially zero.

In either logic state, one MOS unit is on while the other is off. As a result, the quiescent power consumption is extremely low, equal to the product of the supply voltage and the off-unit leakage current. With a supply voltage of +10 V and assuming typical off-unit leakage of 1 nA, the quiescent power consumption is typically about 10 nW in either logic state.

During switching, however, more power is dissipated. Both p-channel and n-channel units are partially on during this time, and any output and load capacitance must be charged through the p-channel transistor as the output switches high. The stored energy must also dissipate through the n-channel unit during the transition to a low output. Because power is equal to energy per unit time, the power dissipated during switching, if the load is assumed to be capacitive (e.g., another COS/MOS inverter), is equal to $C_o V_{DD}^2 f$, where C_o is the output and load capacitance, V_{DD} is the supply voltage, and f is the operating frequency in Hertz.

The voltage transfer characteristics of a typical inverter for three different supply voltages are shown in Fig. 4. The noise immunity shown on the curve (about 5 V for both the 1 and 0 state) for a supply voltage of 10 V illustrates the high noise immunity of this type

n-channel characteristics

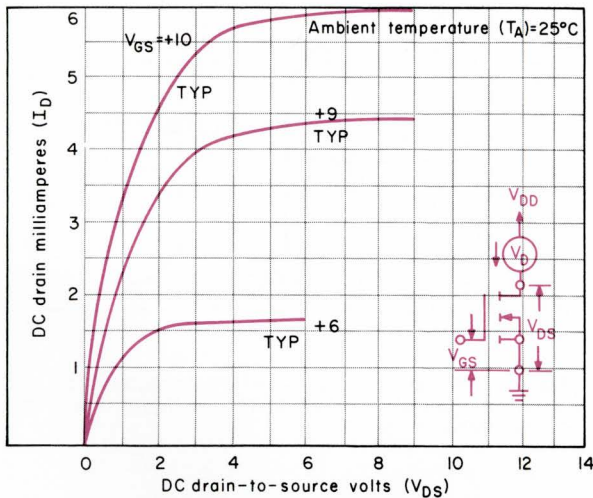

p-channel characteristics

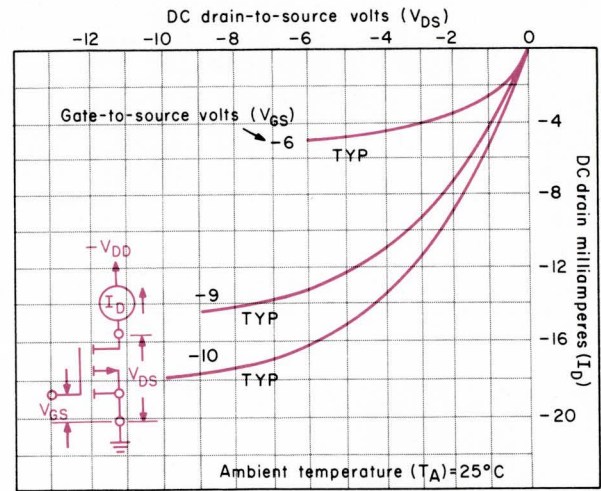

Fig. 1. Typical characteristic curves of n-channel and p-channel MOS transistors used in COS/MOS inverters.

of logic circuit. The shape of the transfer characteristics, caused by the inherent threshold voltages of MOS transistors, also contributes to the high noise immunity. Neither logic level begins to change until the change in input voltage equals the threshold voltage of the off transistor. Complementary MOS circuits also exhibit exceptionally high crosstalk and ac noise immunity because of the high dc noise immunity, medium-speed operation, and relatively low output impedances (when on) of both n-channel and p-channel units (typically 1000Ω).

Another characteristic of COS/MOS circuits is their ability to operate with unregulated power supplies. The circuits can maintain a logical 0 of 0 V and a logical 1 of V_{DD} volts with a supply voltage ranging from 6 to 15 V.

Loading rules for complementary logic are fairly simple. Because the input impedance of a typical inverter is on the order of $10^9 \Omega$, you can achieve large fanouts without a significant increase in power consumption. Although no dc restriction limits the fanout capability, speed decreases because of the capacitive loading. In practice, fanout capabilities greater than 50 are possible.

Transmission gates

A perfect switch may be characterized as having zero forward and reverse resistance when closed and infinite resistance when open. The low, on impedance and the off impedance of about $100 M\Omega$ are used to advantage in the transmission gate, which is essentially a voltage-controlled switch.

Consider first, a single n-channel unit driving a capacitive load. With 0 V applied to the gate

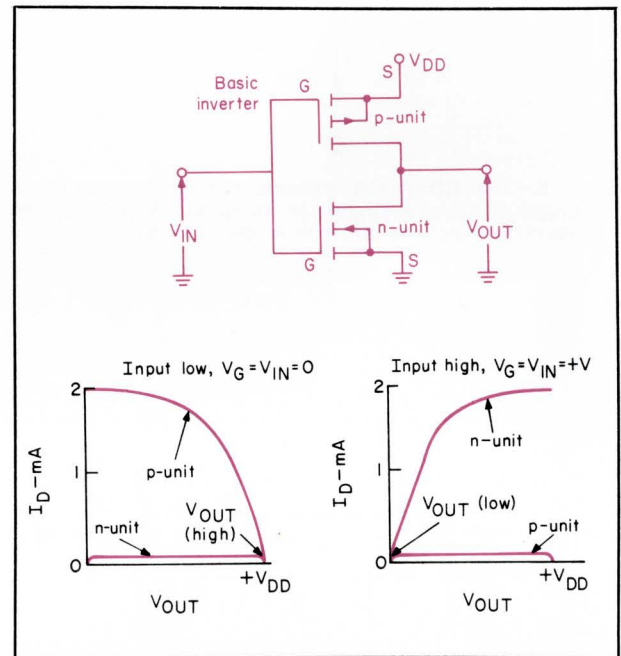

Fig. 2. The basic COS/MOS inverter. The intersection of the n-channel characteristic curve for $V_{GS} = 0$ with the p-channel load line for $V_{GS} = +V_{DD}$ shows the output voltage level for a logic 0 input. You can also see that with a logic 1 input, the output voltage is essentially 0 V.

The inverter output voltage is practically independent of any variations in the characteristic curves of fig. 1. Because the slope of the on unit is always relatively steep and the drain current in the off unit is small, the intersection of the two curves is always either near 0 V or V_{DD} and is usually within a few millivolts of either one or the other.

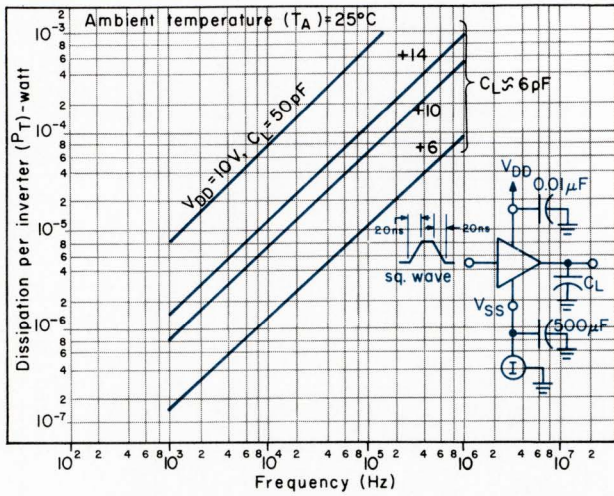

Fig. 3. Typical power dissipation vs frequency characteristic of the basic inverter.

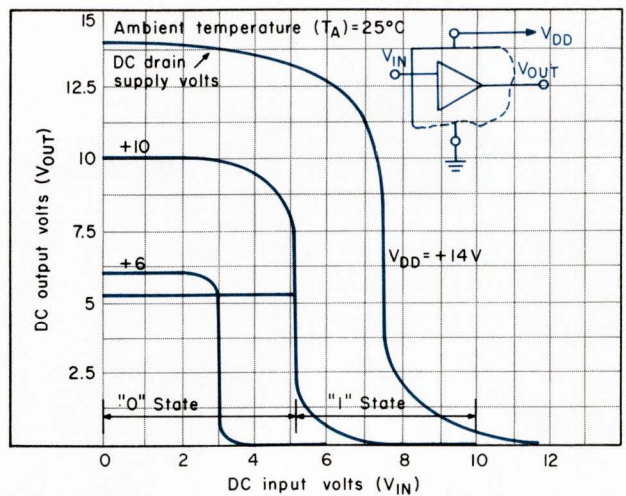

Fig. 4. Typical voltage transfer characteristics for the basic inverter. The curves show the high noise immunity of the logic.

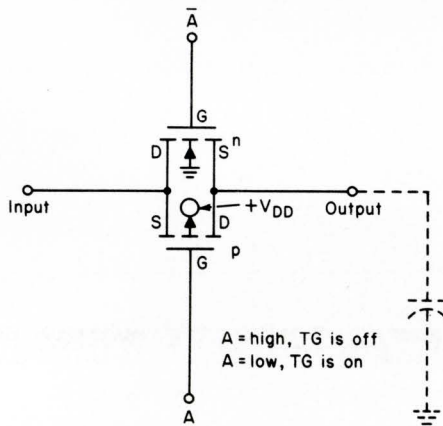

Fig. 5. The COS/MOS transmission gate with control voltages of A and \bar{A} applied to the gates. With A high, the transmission gate is off; with A low, it is on.

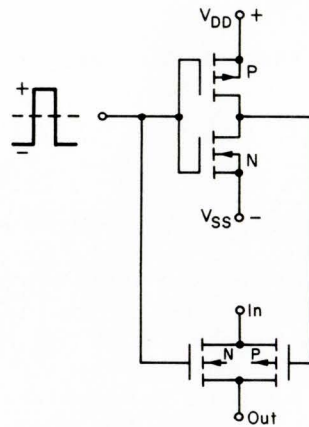

Fig. 6. An analog switch is formed by combining the transmission gate with an inverter. Because the inverter supplies the \bar{A} level, only one control voltage is required.

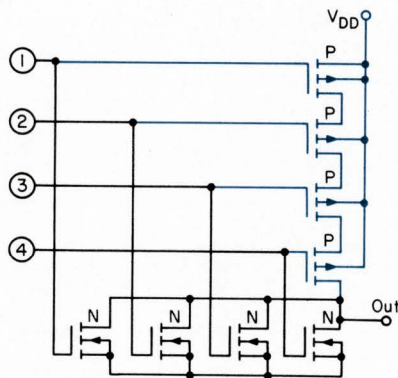

Fig. 7. The four-input NOR gate has all the p-channel transistors connected in series and the n-channel transistors connected in parallel. Because the output is high only when all p-channel transistors are on and all n-channel transistors are off, the circuit gives you positive NOR logic.

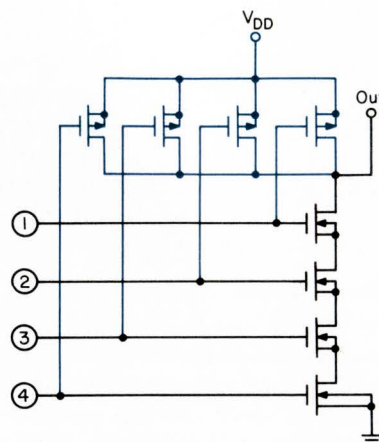

Fig. 8. A four-input NAND gate. In this circuit, the n-channel transistors are in series and the p-channel transistors are in parallel. All inputs must be high to establish a path to ground; this gives you the positive NAND function.

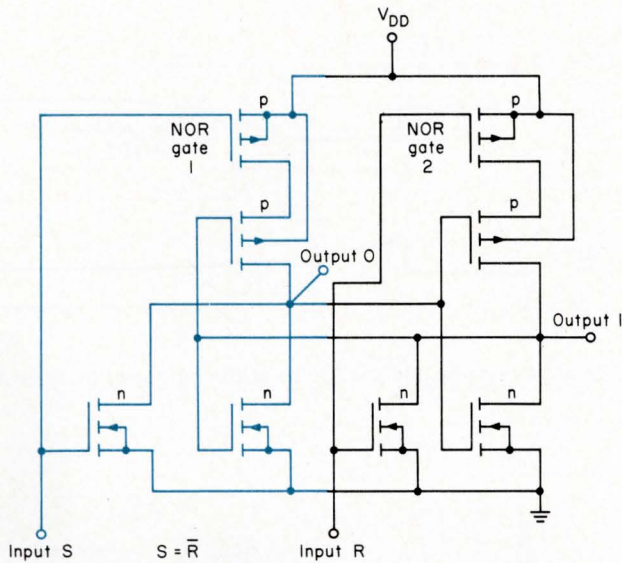

Fig. 9. You can form a set-reset flip-flop by cross-coupling two NOR gates as shown here.

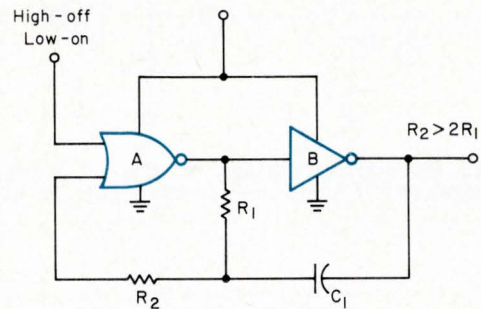

Fig. 10. An astable multivibrator constructed from COS/MOS logic gates.

of the n-channel unit, a positive gate-to-source voltage can never occur (if we assume that all inputs are positive); therefore, the unit remains off. As the gate voltage is increased, increasingly higher input voltages can be switched. With a positive gate potential and an infinite-impedance load, the output equals the input voltage for input potentials ranging from 0 to $V_G - V_{TH}$, where V_G is the gate voltage and V_{TH} is the threshold voltage of the MOS transistor used. When a single MOS device is used as a switch, therefore, a gate potential of 0 V turns the unit off and a positive gate potential allows a certain range of input voltages to be switched.

This switch, however, has a few disadvantages. Because current can flow in either direction, the device operates either as a source-follower or a drain-loaded stage. As a result, you are penalized with slow speed operation in large-signal applications. Also, because the device cannot switch input voltages greater than $V_G - V_{TH}$, premature cutoff can occur.

On the other hand, the COS/MOS transmission gate consists of parallel n- and p-channel MOS transistors. Let us assume that each MOS unit has a 3-V threshold voltage and that we apply 0 V to the gate of the p-channel unit and 10 V to the gate of the n-channel unit. Under those conditions, an input rise > 7 V (10 V $- 3$ V) cannot be fully switched through the n-channel unit. Proper switching can occur, however, because the magnitude of the voltage from gate to source of the p-channel unit (0 V $- 7$ V $= -7$ V) is greater than the p-channel threshold (-3 V). As a result, the switch does not shut off prematurely because the gate-to-source voltage of both the n- and p-channel units never equals the threshold voltage of any one device. The transmis-

sion gate can therefore switch the full V_{DD} to V_{SS} voltage range. Improved speed is possible also because one unit always operates as a normal drain-loaded stage.

The transmission gate may also be combined with the basic inverter circuit to form a single switch. Only one control voltage is then required because the inverter provides the control voltage necessary for the complementary unit. This circuit is useful in a variety of analog and digital multiplexing applications.

Logic gates

In a COS/MOS four-input NOR gate, all p-channel units are in series and all n-channel units in parallel. The output of the gate is high only when all p-channel units are turned on and all n-channel units are off. This condition occurs only when all inputs to the NOR gate are low and gives you positive NOR logic.

Conversely, in a four-input NAND gate, all n-channel units are in series and all p-channel units are in parallel. A low output occurs, therefore, only when all n-channel units are turned on so that the path to ground is closed. Because this condition occurs only when all inputs are high, positive NAND logic is obtained.

Transmission gate and inverter applications

You can combine transmission gates with inverters to form D-type flip-flops (flip-flops that switch to the logic state present on the D input during a clock-pulse transition). A complete D-type flip-flop consists of two identical bistable elements of the type shown in fig. 12. The circuit uses two transmission gates and two inverters.

One major disadvantage of this type of flip-flop is

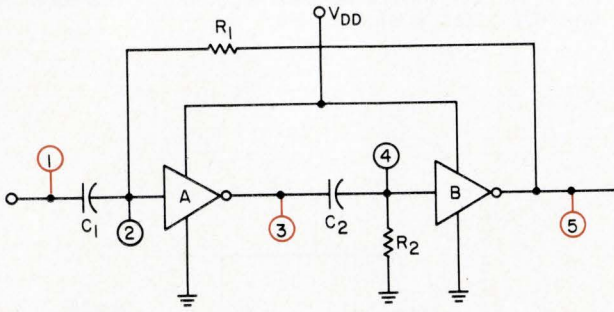
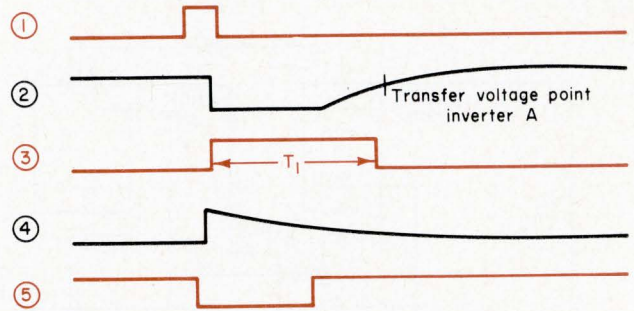

Fig. 11. Monostable multivibrator. This circuit triggers on the negative-going transition of the input and gives you



a positive-going one-shot pulse at the output of inverter A.

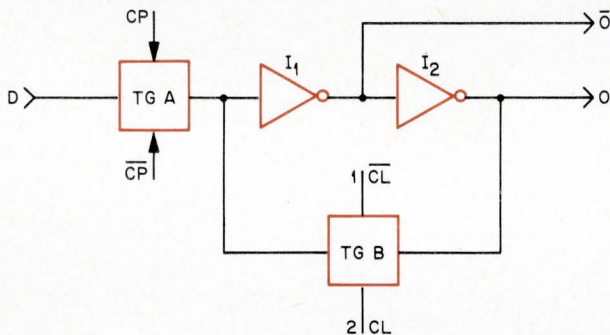

Fig. 12. One of two identical bistable elements in a D-type flip-flop. The Q and \bar{Q} outputs lock in a state that is determined by the initial input level. Transmission gate A insures that the information on the D-input is transferred to the input of the flip-flop only when a clock pulse occurs. Transmission gate B isolates the Q output from the D-input (otherwise the two would be shorted when transmission gate A is on.)

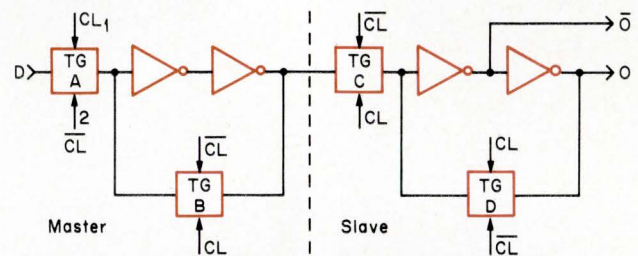
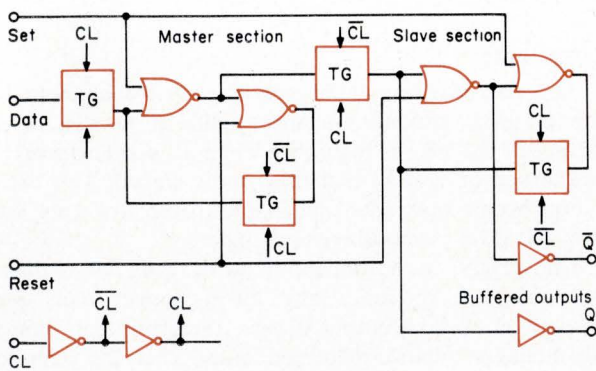

Fig. 13. A Complete D-type flip-flop. This circuit uses two bistable elements connected in series to form master and slave sections. The corresponding transmissions gates in each element are inversely clocked. When the clock is low, information on the D-line is transferred to the master section. However, because transmission gate C is off, the slave section remains in its previous state. The information in the master section is transferred into the slave section only at the positive transition of the clock. Neither section is affected by further transitions of the D-line, because transmission gate A remains off as long as the clock pulse is present.



Truth table

CL*	D	R	S	Q	\bar{Q}
—	0	0	0	0	1
—	1	0	0	1	0
—	x	0	0	Q	\bar{Q}
x	x	1	0	0	1
x	x	0	1	1	0
x	x	1	1	*	*

- ▲ = Level change
- x = Don't care case
- * = Invalid condition

No change

Fig. 14. The D-type flip-flop with set and reset capability added.

that the D-line may change states during the presence of a clock pulse. If this happens, the state of the flip-flop also changes. The state of a D-type flip-flop should be determined only by the state of the D-line at the occurrence of a positive or negative transition of the clock pulse. The circuit in fig. 13 shows one way to accomplish this function. Set and reset capability may be added to this circuit by replacing all the inverters with NOR gates. In fig. 16, you will see the complete COS/MOS flip-flop circuit, together with its truth table.

COS/MOS applications

The unique characteristics of COS/MOS circuits make them useful in many applications where other types of logic would be unsuitable or simply not applicable at all. For instance the extremely low-power operation is useful in applications which require high packing density and in battery-operated equipment in which the life of the battery determines the total operating time.

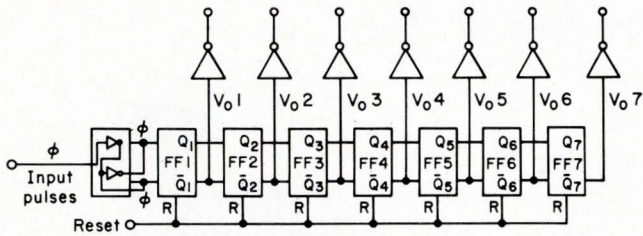

Fig. 15. A 7-stage COS/MOS binary counter. Each stage consists of one D-type flip-flop. The Q and \bar{Q} outputs of each flip-flop provide the clock and inverse clock for the following stage. For proper operation, each \bar{Q} output is connected back to the D-input of the same flip-flop. The output buffer stages provide isolation and fanout capability.

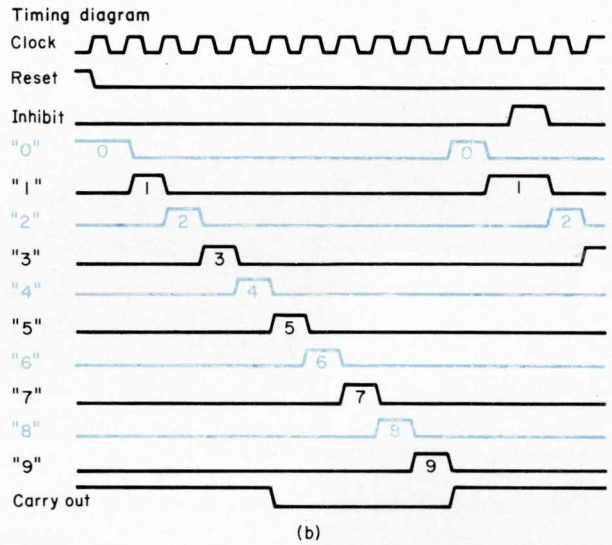
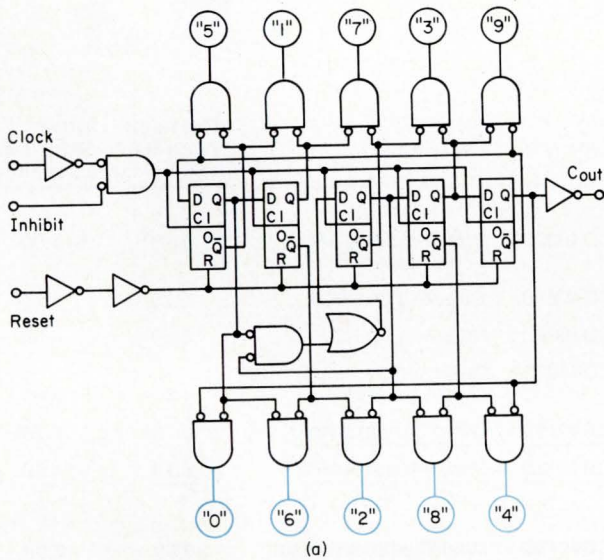

Fig. 16. A 5-stage decimal-decoded Johnson counter formed with COS/MOS flip-flops. The flip-flops have a

common clock and the Q output of each stage is connected to the D-input of the following stage.

Because these circuits operate over a wide range of supply voltages, the battery voltage may fall significantly below its nominal value before any failure occurs.

Counters made with COS/MOS circuits find widespread use in timing circuits. You could use four IC 14-stage binary counters, clocked by a 1-MHz oscillator, to provide one pulse every 2300 years. A whole era could be divided into μ s intervals. Battery-operated wrist-watches could use fewer stages counting at a faster rate. Present-day technology can easily incorporate the required number of stages into a size smaller than a wrist-watch.

Many logic applications require operation in noisy environments where relays, solenoids, and other devices create electromagnetic fields which may cause false switching. Because of their high-noise immunity, COS/MOS logic circuits are especially useful in such environments.

Some applications require large numbers of gates to be incorporated into small area. A 146 x 155 mil

chip containing 775 MOS transistors has been manufactured. This 4-bit "parallel processor," which was designed for NASA space applications, has the basic arithmetic capabilities of a medium-size, medium-speed computer. Standby power consumption is <0.0001 W.

Applications for COS/MOS circuits, then, range from the basic inverter to complex computers. New applications continue to arise with advancing technology. Present-day work includes the development of higher-speed circuits operating up to the 50-MHz range and the new low-threshold processes that permit the use of lower supply voltages for even lower power consumption.

INFORMATION RETRIEVAL
Integrated circuits, Computers and
peripherals, Computer design

Where's the excitement in digital IC's today?

RCA's expanding COS/MOS line.

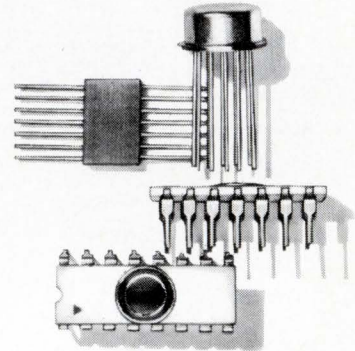

Circuit designers and component engineers, in increasing number, are taking advantage of the unique performance features of RCA COS/MOS IC's. They are attracted by the immediate availability of production quantities and the economics of these devices; and RCA's continued leadership in expanding the number of circuit types in this exciting line. Today, there are COS/MOS IC's to satisfy most of your commercial, industrial, aerospace and military logic-system design requirements.

Look at these COS/MOS IC advantages:

- Extremely low quiescent power dissipation gates— $P_T=10$ nW/pkg (typ) @ $V_{DD}=10$ V
MSI circuits— $P_T=5$ μ W (typ) @ $V_{DD}=10$ V
- Speed gates—propagation delay (t_{pd})=50 ns (typ) @ $V_{DD}=10$ V, $C_L=15$ pF
MSI circuits—clock pulse frequency (f_{CL})=2.5 MHz (typ) @ $V_{DD}=10$ V
- Excellent dc and dynamic noise immunity—4.5 V (typ) @ $V_{DD}=10$ V
- High dc fanout (e.g. > 50)
- Simple circuit and subsystem design
- Compatible gate level and MSI functions
- Operation from one unregulated power supply—6 to 15 V
- Full military operating-temperature range— -55°C to $+125^\circ\text{C}$
- Stable performance over wide ranges of supply voltage and temperature

They all add up to a big plus for circuit engineers: lower system design and production costs.

For further information on COS/MOS integrated circuits, see your local RCA Representative or RCA Distributor. Ask for the following COS/MOS application information: "Counters and Registers", ST 4166; "Noise Immunity", ICAN 6176; "Astable and Monostable Oscillator Designs", ICAN 6267; "COS/MOS Reliability", RIC 101. Or write: RCA Electronic Components, Commercial Engineering, Section ICJ-5 / CD34, Harrison, N. J. 07029. In Europe: RCA International Marketing S.A., 2-4 rue du Lièvre, 1227 Geneva, Switzerland.

Flat Pack Type No.	DIC Type No.	Description	Flat Pack Price-Each (1000 or more quantities)	DIC Price-Each
Gates				
CD4000	CD4000D	Dual 3-input NOR plus inverter	\$ 5.00	\$ 4.00
CD4001	CD4001D	Quad 2-input NOR	5.75	4.75
CD4002	CD4002D	Dual 4-input NOR	5.50	4.50
CD4007	CD4007D	Dual complementary pair plus inverter	4.00	3.00
CD4011	CD4011D	Quad 2-input NAND	5.75	4.75
CD4012	CD4012D	Dual 4-input NAND	5.50	4.50
Flip-Flops				
CD4013	CD4013D	Dual-D with set/reset capability	9.00	8.00
Hex Buffers/Logic-Level Converters				
—	CD4009D	Inverting	—	7.00
—	CD4010D	Non-inverting	—	7.00
Memories—MSI				
CD4005	CD4005D	16-bit NDRO	11.00	10.00
Static-Shift Registers—MSI				
CD4006	CD4006D	18-stage	18.25	17.25
—	CD4014D	8-stage synchronous parallel-input/serial-output	—	13.60
—	CD4015D	Dual 4-stage serial-input/parallel-output	—	13.60
Counters—MSI				
CD4004	—	7-stage ripple counter/freq. divider	11.00	—
—	*CD4004T		—	10.00
Adders—MSI				
—	CD4008D	4-bit full adder with parallel carry out	—	16.00

*TO-5 package

(COS/MOS IC's listed in bold-face type are recent additions to the line.)

RCA Integrated Circuits

NOW... A NEW AND EXPANDED MANUFACTURING SYSTEM FOR HIGH TECHNOLOGY INDUSTRIES

...by Hamilton Precision Metals

• COMPUTER • INSTRUMENT • TELECOMMUNICATION • BUSINESS MACHINE

The Precision Metals Division of Hamilton Watch Company is now geared to meet the requirements of computer, instruments, telecommunication and business machine manufacturers—as well as other high technology industries—with high-quality precision strip, foil and wire processing, precision Photoforming® and parts assembly.

Hamilton's metals technology includes precision rolling of ultrathin strip and foil and wire drawing in pure metals, commercial alloys and proprietary metals with highly specialized properties. This facility also includes heat-treating and annealing to provide the physical or magnetic properties required.

Photoformed parts are produced from the precision-rolled strip and foil in high volume, meeting the most rigid shape and dimensional specifications. Parts are manufactured by modern, high-production equipment in the most advanced chemical etching facility featuring "ultraclean" production conditions.

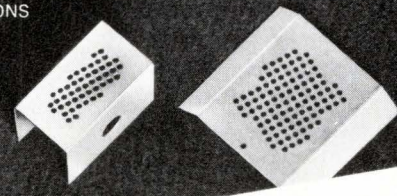
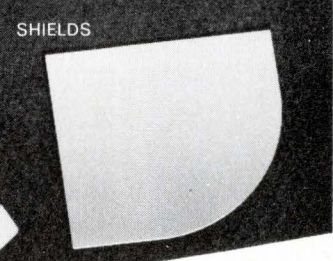
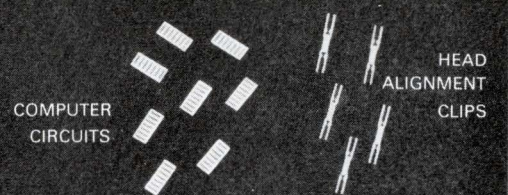
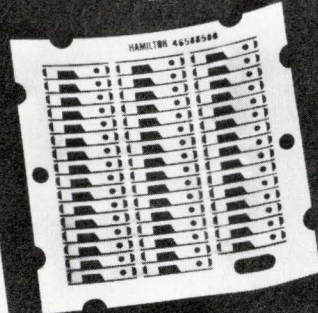
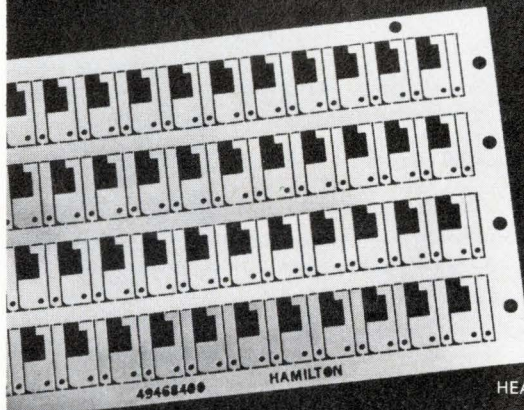
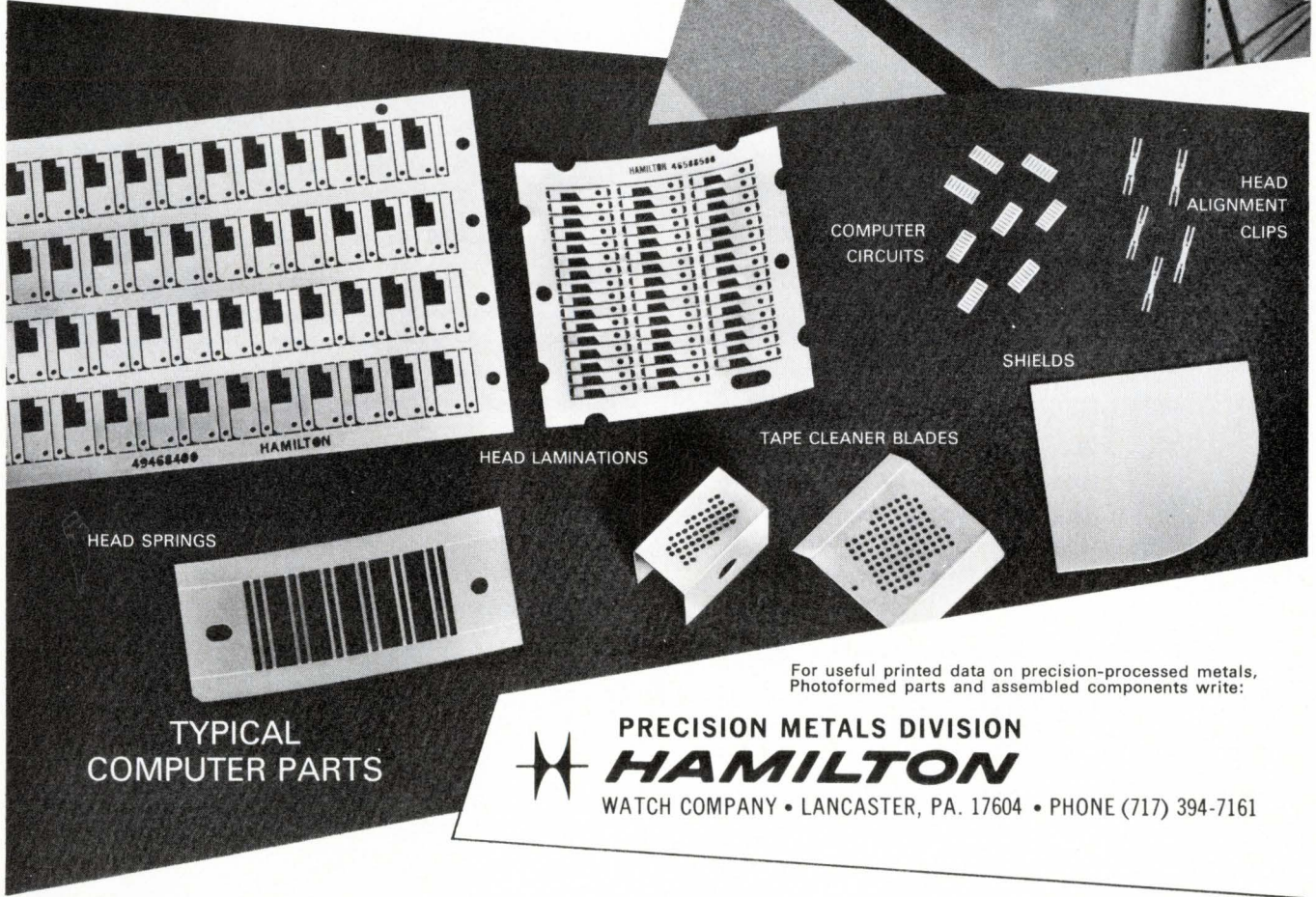
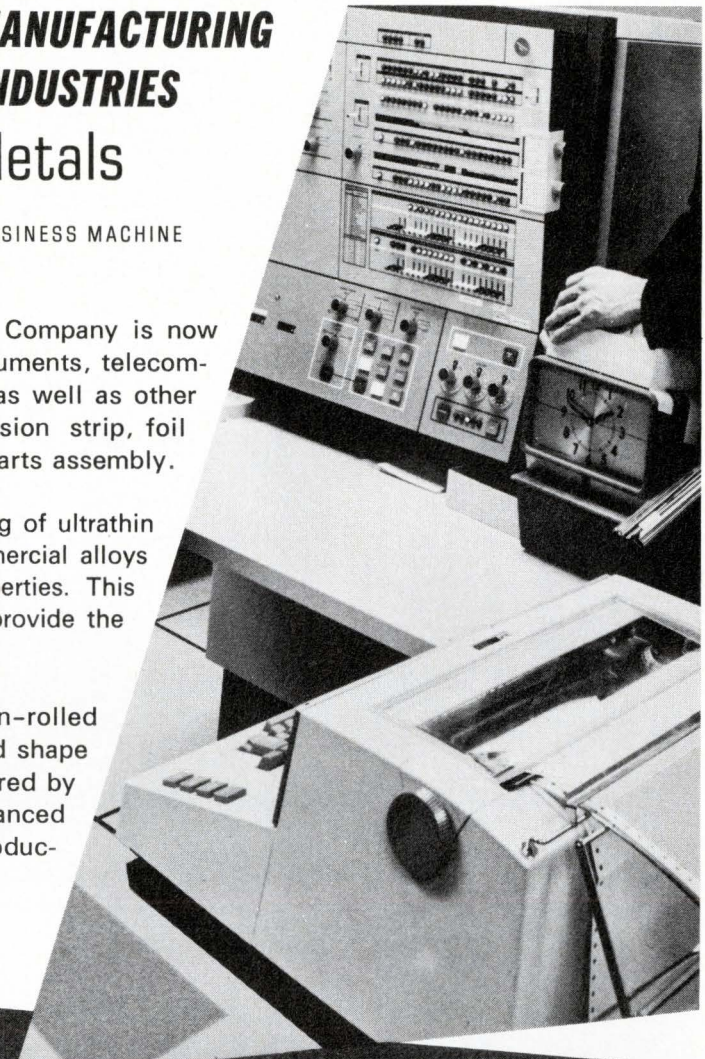

TYPICAL COMPUTER PARTS

HEAD LAMINATIONS

COMPUTER CIRCUITS

HEAD ALIGNMENT CLIPS

SHIELDS

TAPE CLEANER BLADES

For useful printed data on precision-processed metals, Photoformed parts and assembled components write:



PRECISION METALS DIVISION
HAMILTON
 WATCH COMPANY • LANCASTER, PA. 17604 • PHONE (717) 394-7161

DUAL-MODE (CW or PULSED)

TWTs

for

Advanced Systems Applications

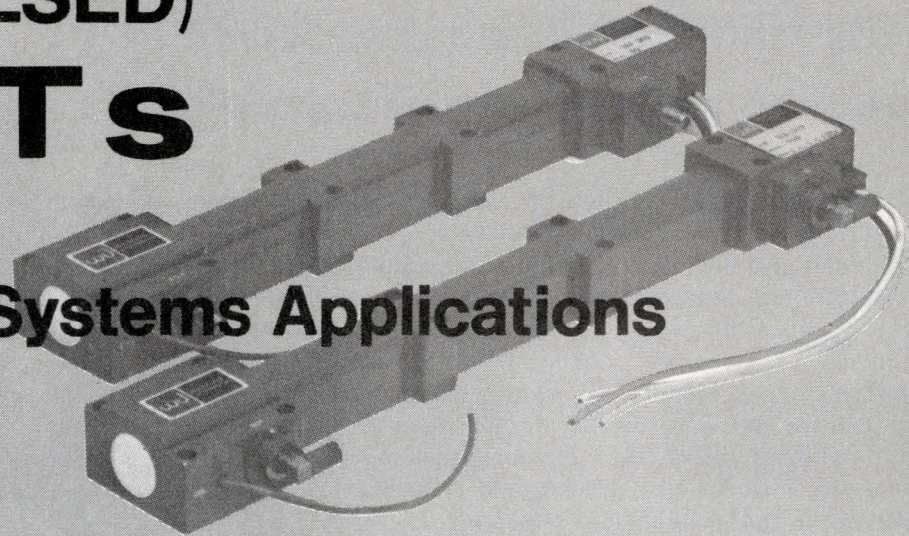

With hundreds of hours of environmental testing on record, the WJ-368 and WJ-369 TWTs are ready for CW and Pulsed operation in the most demanding environments.

Designed for stringent airborne applications, these second generation TWTs are ready to serve as high gain drivers/transmitters for ECM equipment, as transmitters for radar transponders, and as amplifiers for AM and FM communications systems.

The dual-mode advantage is achieved by means of a simple beam voltage adjustment and Hi-mu switching grid. Users can expect the same long life and high reliability found in all W-J tubes, plus full performance in 100°C operating temperature, small size and weight, and conduction cooling.

WJ-368 Series

Spec A

Frequency Range: 2 to 4 GHz
Saturated Power Output: 40 W (CW) or
80 W (Pulsed at 25% duty)
Gain at Rated Power Output: 35 dB

Spec B

Frequency Range: 2.6 to 5.2 GHz
Saturated Power Output: 50 W (CW) or
100 W (Pulsed at 25% duty)
Gain at Rated Power Output: 35 dB

WJ-369 Series

Spec A

Frequency Range: 4 to 8 GHz
Saturated Power Output: 40 W (CW) or
80 W (Pulsed at 25% duty)
Gain at Rated Power Output: 35 dB

Spec B

Frequency Range: 4.5 to 6.5 GHz
Saturated Power Output: 50 W (CW) or
125 W (Pulsed at 25% duty)
Gain at Rated Power Output: 35 dB

Weight, either unit: 2.5 pounds maximum



WATKINS-JOHNSON

3333 HILLVIEW AVE., STANFORD INDUSTRIAL PARK, PALO ALTO, CALIF. 94304 • (415) 326-8830

Design shortcuts for microwave frequency dividers

By using parametric diodes and simple microwave techniques you can design and build dividers that work into the GHz range. The dividers are very attractive for digital frequency synthesizers.

By Willie Joseph Goldwasser,
Member, Tech Staff, RCA, Burlington, Mass.

In 1959, three articles^{1, 2, 3} described a parametric subharmonic oscillator for use in digital computers. These oscillators were capable of dividing frequencies up to several GHz by a factor of two. Originally intended to be used as phase storage elements for digital computer memory circuits, these oscillators can also serve as frequency and phase dividers.

This article describes the operation of, and gives detailed design information for parametric dividers, devices which will divide frequencies into the GHz range while keeping the divided signals phase locked to the input. The ability to keep the output locked to the input phase makes these devices very attractive for digital frequency synthesizers. However, the design information given here will work equally well for any divider application.

The parametric subharmonic oscillator, or parametric divider, consists of a varactor diode. As shown in Eq. 1, the instantaneous junction capacitance, C_i , varies with the instantaneous voltage, V_i , applied across the diode. A typical voltage-capacitance characteristic is shown in Fig. 1. In Fig. 1, θ is the diode's contact potential, 0.7 V for silicon, C_0 is the zero bias capacitance, and C_1 is the capacitance at a reverse bias voltage of V_i . n is about one-half for abrupt junction diodes and about one-third for graded junction diodes⁴.

$$C_i = \frac{C_0}{\left(1 - \frac{V_i}{\theta}\right)^n} \quad (1)$$

Basic considerations

When a varactor diode is driven by a source of rf energy at a radian frequency of $2\omega_0$, a negative conductance starts and sustains an oscillation at the subharmonic radian frequency of ω_0 . These subharmonic oscillations are phase stable and phase locked to the driving signal. Although division by numbers other than two is possible with idler circuits, it is not recommended because of reduced efficiency and poor phase stability.

To use the subharmonic energy generated by the diode's oscillations at ω_0 , the ω_0 signal must be isolated from the $2\omega_0$ source while passing it to the load, and

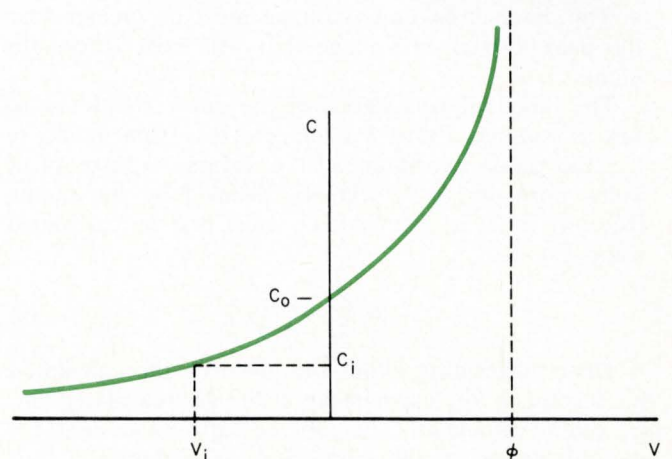

Fig. 1: Typical voltage-capacitance characteristic for a varactor diode. Instantaneous diode junction capacitance C_i varies with the instantaneous voltage V_i applied.

at the same time assuring that maximum $2\omega_o$ energy is passed from the source to the diode. The tuned circuits of Figs. 2 and 3 provide the isolation.

If ω_p is set equal to $2\omega_o$, in Fig. 2, the tank circuit provides a short circuit at ω_o and an infinite impedance at $2\omega_o$. Hence, it's suited as an input tuning circuit to our divider. Likewise, setting ω_p equal to ω_o in Fig. 3 would provide a circuit with an infinite impedance at ω_o and a short circuit at $2\omega_o$. Combining the two tanks with our diode and a simple self bias circuit results in the circuits of Figs. 4 and 5.

Component selection

Inductor L_2 in Figs. 4 and 5 is chosen to resonate with the total diode capacitance, C_T . C_T is the sum of the diode package capacitance, C_p , and the diode capacitance C_i , which exists at the fixed bias voltage V_i , at the median frequency of interest, or at

$$\omega_{med} = \frac{2\omega_o}{2} + \frac{\omega_o}{2} = \frac{3\omega_o}{2}$$

Capacitor C_1 offers a minimum ac impedance at $2\omega_o$ and C_5 offers a minimum ac impedance at ω_o .

C_1 and R_1 form the self bias circuit. On the first positive swing of the rf drive signal, C_1 appears as a short circuit. Therefore, CR_1 is forward-biased, drawing current through C_1 and charging it to the peak value of the drive signal. However, C_1 can not discharge through CR_1 during the rest of the drive cycle because the diode is back-biased. C_1 , therefore, acts as a bias source for the diode, back-biasing it at $1.414 (E_{gen})$. R_1 is chosen to make the product R_1C_1 equal to about $100/(\omega_o)$. R_1 provides a high impedance discharge path for C_1 . R_2 is 10 k and is used to prevent parasitic oscillation of the diode.

The ac steady-state equivalent circuits of Figs. 4 and 5, shown in Figs. 6 and 7 respectively for both $2\omega_o$ and ω_o , demonstrate how maximum power is transferred to the diode at $2\omega_o$ and to the load at ω_o .

Choosing the diode

The only component remaining to be chosen is the diode. The varactor diode choice for the divider is based on three parameters,—the breakdown voltage, the junction capacitance, and the quality factor.

The diode breakdown voltage must be greater than the peak-to-peak rf voltage that will exist across the diode.

The junction capacitance of the diode should be as low as possible. Either C_o , the zero bias capacitance, or C_x , the diode capacitance at a reverse voltage of X volts, normally 6 V, will be specified by the manufacturer. If C_x is specified, C_o must first be calculated using Eq. 2.

$$C_o = C_x \left(1 - \frac{V_x}{\theta}\right)^n \quad (2)$$

Then substituting either the given or the calculated C_o into Eq. 1, the capacitance at the desired bias point, C_i , can be calculated. The value of capacitance used for the calculation of the circuits' series inductor, L_2 , is the value of C_i plus the diode's package capacitance C_p .

$$C_T = C_i + C_p \quad (3)$$

Glass bead and pill type diodes have a package capacitance of about 0.2 pF. Low values of C_T will permit L_2 to exist in a physically realizable form.

The diode quality factor, Q_D , is a function of the desired operating frequency, 2ω , and the diodes maximum operating frequency

$$Q_D = \frac{\omega_{max}}{2\omega} = \frac{f_{max}}{2f} \quad (4)$$

The maximum operating frequency

$$f_{max} \approx \frac{1}{t_t} \quad (5)$$

where t_t is the diodes transition time. For the divider to function, $Q_D > 6$ for abrupt junction diodes and $Q_D > 4$ for graded junction diodes⁵.

Design example

Let's suppose that we want a divider for the phase-locked loop of a 400-to-500-MHz digital frequency synthesizer having an output of 100 mW. It is desired to have 50 channels spaced 2 MHz apart.

In the phase-locked loop of a digital frequency synthesizer, see Fig. 8, a portion of the final output signal, f_o , from a voltage controlled oscillator, VCO, is fed back to its input through a variable frequency divider. The divider is programmed to divide by a given number, N . The output of the divider, f_o/N , is then compared in a phase detector with the output of a stable source, normally a crystal oscillator. The phase detector's output is a signal which is a function of the phase or frequency difference between the two inputs. This signal is converted to a dc ramp by a low pass filter, and this ramp voltage supplies bias to a variable capacitance diode in the VCO tank circuit. The change in diode capacitance causes a frequency output which is now passed through the divider back to the phase detector. When f_o/N is equal to f_x , a constant output voltage, rather than a ramp, is produced by the phase detector and low pass filter which keeps the VCO on the desired frequency.

To supply the 50 channels, we need a variable divider with 50 steps. There are no commercial dividers available which operate to 500 MHz. But, if we first use a parametric divider to divide the output by 2, we can then use integrated circuits to divide the 200-to-250-MHz resultant signals by 200 to 250. Using a 1-MHz crystal oscillator, the final divider output, f_o/N must be 1 MHz to keep our loop "locked."

In other words, if the variable divider is set to 200, the total divide ratio will be 400, and the VCO's output must therefore be 400 MHz for a locked condition to exist. At $N = 225$, f_o must be 450 MHz, and for $N = 250$, f_o must be 500 MHz. This system gives us 50 channels spaced 2 MHz apart.

The parametric divider to divide from 400 to 500 MHz will now be designed with the procedure in Table 1.

1. The median input frequency is 450 MHz. With an available signal level of 100 mW, there will be 6.2 Vpp across our 50-ohm circuit.

2. A Hewlett-Packard 0182 step recovery diode with a specified C_o of 2.0 pF, a breakdown voltage of 35 V, and a transition time of 200 ps is chosen.

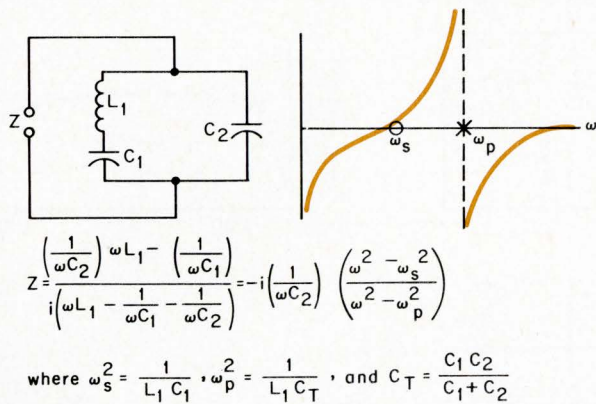

Fig. 2: The subharmonic generated ω_p must be isolated from source, $2\omega_s$, while passing it on to the load. (This also applies to Fig. 3.) Here the tank circuit provides a short circuit at ω_s and infinite Z at $2\omega_s$.

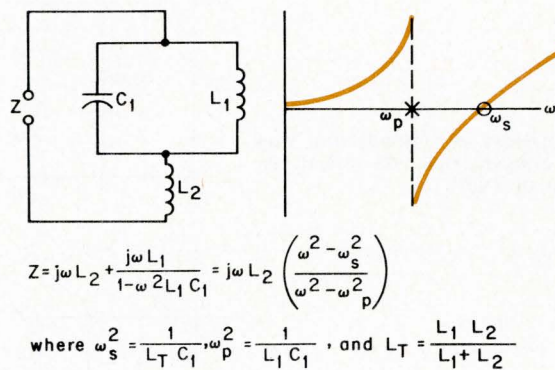

Fig. 3: Letting ω_p equal $\omega_s/2$ provides a circuit with infinite Z at $\omega_s/2$ and a short circuit at $2\omega_s$.

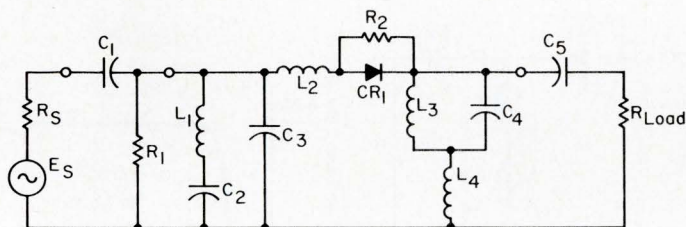

Fig. 4: Pi-coupled parametric divider combines circuits in Figs. 2 and 3.

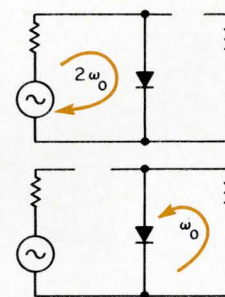

Fig. 6: This is the dc steady state for circuit in Fig. 5.

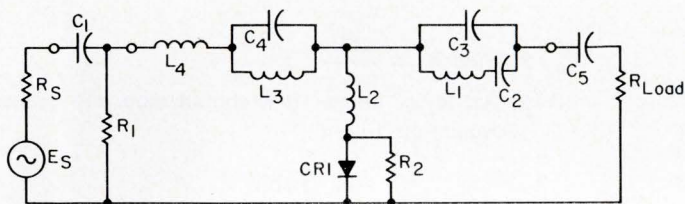

Fig. 5: T-coupled parametric divider using the circuits of Figs. 2 and 3.

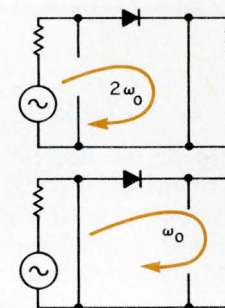

Fig. 7: Here is the dc steady state for the circuit in Fig. 4.

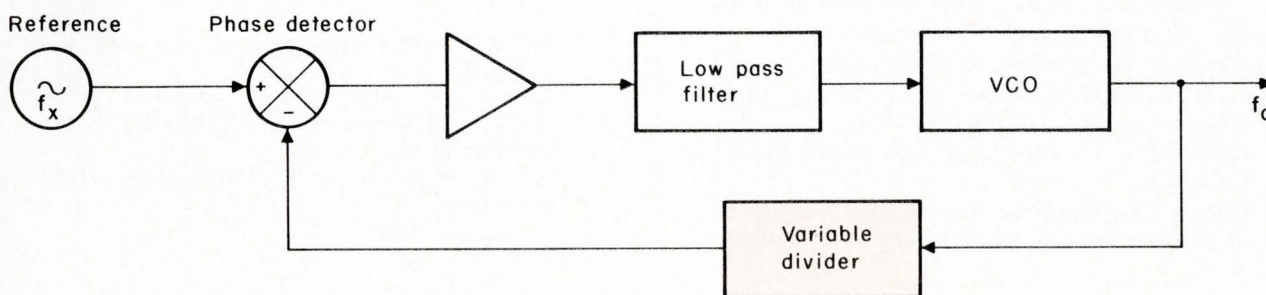

Fig. 8: The variable frequency divider is programmed to divide by N.

Fig. 9: Here is a circuit that was built and worked. Its output is shown on right.

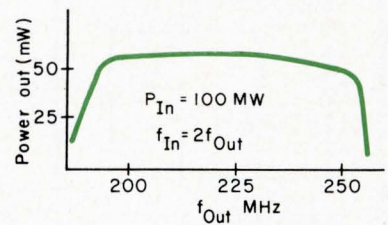
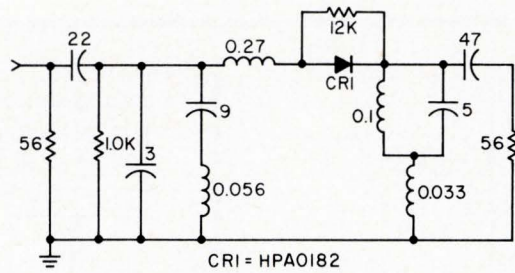

Fig. 10: Working out the design example we arrive with this circuit which works.

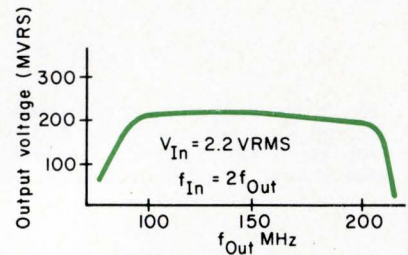
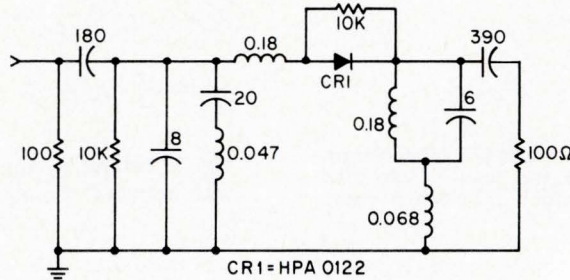

Fig. 11: In this working circuit the tank circuits are pieces of coax—one shorted, one open.

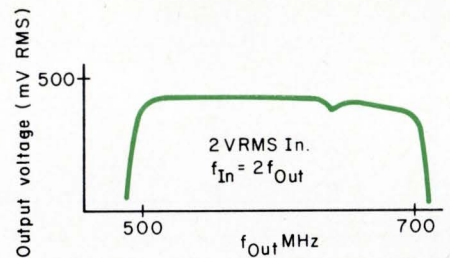
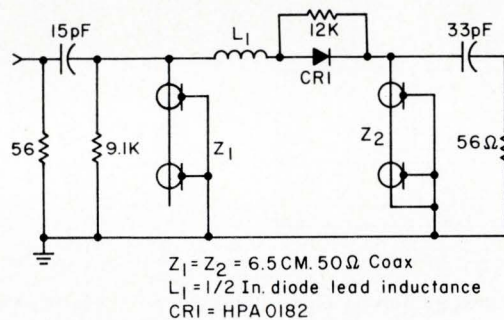

Table 1

Design procedure for discrete coupled parametric dividers (Refer to Figs. 4 & 5)

1. Determine the required operating frequency range and the maximum peak-to-peak voltage available to drive the circuit.
2. Choose a varactor diode considering its breakdown voltage, zero bias capacitance, and quality factor.
3. Compute C_T and choose an L_2 which will resonate at ω_{med} .
4. Choose an L_1 and a C_2 which will resonate at ω_o , the center of the output frequency range.
5. Compute C_3 necessary to resonate with L_1 and C_2 at $2\omega_o$, the center of the input frequency range.
6. Choose L_3 and C_4 to resonate at ω_o .
7. Compute the L_4 required to resonate with L_3 and C_4 at $2\omega_o$.
8. Choose a C_1 which will appear series-resonate at $2\omega_o$, and choose a C_5 which will be series-resonate at ω_o .

9. Find $R_1 = \frac{100}{\omega_o C_1}$

10. An R_2 of about 10 k should stop any parasitic oscillations.

Table 2

Design procedure for distributed element parametric dividers

Steps, 1, 2, and 3 same as Table 1 above

4. Calculate the length of Z_1 , a half-wave length of open-circuited transmission line or microstrip at $2\omega_o$ taking into effect the velocity constant of the line.
5. Make Z_2 the same length as Z_1 , only short circuited.
6. Choose a C_1 which will appear series resonate at $2\omega_o$ and choose a C_5 which will be series resonate at ω_o .
7. An R_2 of about 10 k should stop parasitic oscillations.
8. Find $R_1 = \frac{100}{\omega C_1}$

$$f_{max} = \frac{1}{t_i} = \frac{1}{200 \times 10^{-12}} = 5 \times 10^9$$

therefore,

$$Q_D = \frac{2f}{f_{max}} = \frac{500 \text{ MHz}}{5 \text{ GHz}} = 10 > 6$$

3. With a 6.2 Vpp input level, the diode's C_i will be

$$C_i = \frac{C_o}{\left(1 - \frac{V_B}{\theta}\right)^n} = \frac{2.0}{\left(1 - \left(\frac{-6.2}{0.7}\right)\right)^{1/2}} = 0.64 \text{ pF}$$

$$C_T = C_p + C_i = 0.2 + 0.64 = 0.84 \text{ pF}$$

$$f_{med} = \frac{2f_o + f_o}{2} = \frac{450 + 225}{2} = \frac{675}{2} = 337.5 \text{ MHz}$$

therefore

$$f_{med} = \frac{1}{2\pi \sqrt{L_2 C_T}} \text{ or } L_2 = \frac{1}{4\pi^2 f_{med}^2 C_T}$$

$$L_2 = \frac{1}{4\pi^2 (337.5 \times 10^6)^2 0.84 \times 10^{-12}} = 0.265 \mu\text{H}$$

4. Choose $L_1 = 0.05 \mu\text{H}$. To resonate at the median output frequency of 225 MHz, $C_2 = 9 \text{ pF}$.

5. Therefore, the required total capacitance to resonate with $0.056 \mu\text{H}$ at 450 MHz is $C = 2 \text{ pF}$. Hence, $2 \text{ pF} = C_2 C_3 / (C_2 + C_3)$ or $C_2 = 3 \text{ pF}$.

6. Choose $L_3 = 0.1 \mu\text{H}$. This required C_4 to be 5 pF to resonate at 225 MHz.

7. To resonate with 5 pF at 450 MHz required an $L = 0.023 \mu\text{H}$. Therefore, $0.023 = 0.1 L_4 (0.1 + L_4)$ or $L_4 = 0.030 \mu\text{H}$.

8. At 450 MHz, a 22 pF capacitor with 0.25-in. leads is approximately a short circuit, and at 225 MHz, a 47 pF capacitor is approximately a short circuit. $C_1 = 22 \text{ pF}$, $C_5 = 47 \text{ pF}$.

$$9. R_1 = \frac{100}{\omega C_1} = \frac{100}{2\pi \times 450 \times 10^6 \times 22 \times 10^{-12}} \approx 2 \text{ k}\Omega$$

The final circuit is shown in Fig. 9.

Several dividers operating from 100 MHz to 2 GHz were built using the design procedure given in Tables 1 and 2. The circuits for these, along with the output waveform for each, are given in Figs. 10 and 11. Note in Fig. 11 that the input tank and the output tank of the Pi divider have been replaced with a transmission line. Z_1 is an open-circuited transmission line about a half wavelength long at 1200 MHz, the median input frequency, and, therefore, a quarter wavelength long at median output frequency. Z_1 acts as an open circuit at $2\omega_o$ and a short circuit at ω_o . Z_2 is a short-circuited transmission line which is the same length as Z_1 . It appears to be an open circuit at ω_o and a short circuit a $2\omega_o$. Z_1 and Z_2 can be made with microstrip transmission line techniques.

Other circuit versions

Parametric design is not limited to the Pi and T coupled versions only. Other types may also be built. A transistor with a high F_T may be used in a parametric divider with its collector base capacitance as the non-linear subharmonic oscillator element. Inserting the tank circuit of Fig. 2 between the base and ground, the tank circuit of Fig. 3 between the output and ground, and tuning C_{CB} to ω_{med} with an inductor in the

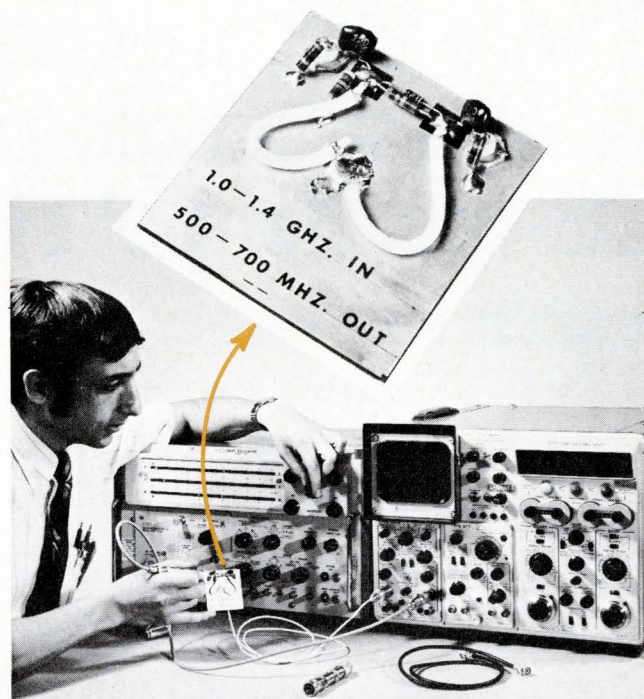

Author Willie Goldwasser is checking one of his divider circuit designs. The inset shows an enlarged view of the circuit. Note how little room is required on a PC board.

base lead, a divider with a limited bandwidth and low loss can be built.

For operation above 600 MHz, the discrete elements used in the input and output tank circuits become extremely small and distributed elements should be used. The input tank can be replaced with an open-circuited length of transmission line that is $\lambda/2$ at the input frequency, $2\omega_o$. The output tank which is the same length as the input line, is short circuited. The input tank, therefore, appears as an open circuit to $2\omega_o$ and a short circuit to ω_o and the output tank appears as an open circuit to ω_o and a short circuit to $2\omega_o$. When calculating the length of the two stubs, the velocity coefficient of the conductor must be considered.

Parametric dividers can divide by numbers such as 3, 4, 3/2, 7/2, etc.—however, idler circuits and power required make them undesirable for the present.

References

- Hilbrand, J. and Bean, W. R., "Semiconductor Diodes in Parametric Subharmonic Oscillator," RCA Review, June 1959, pp. 229-253.
- Sterzer, Fred, "Microwave Parametric Subharmonic Oscillators for Digital Computing," Proceedings of the IRE, August 1959, pp. 1317-1324.
- Goto, E., "The Parametron, A Digital Computing Element which Utilizes Parametric Oscillation," Proceedings of the IRE, August 1959, pp. 1304-1316.
- Penfield, Paul, Jr. and Rafuse, Robert P., Varactor Applications, The MIT Press, 1962.
- Rouche, N., "Steady Oscillations of Parametric Subharmonic Oscillator," IRE Transactions on Circuit Theory, March 1962, pp. 7-12.

INFORMATION RETRIEVAL
Microwave frequency dividers, synthesizers,
parametric diodes

There isn't another like it. A 1/4-inch, single-pole, six position, 28-vdc. Helipot switch for PC boards.

Beckman® INSTRUMENTS, INC.

HELIPOT DIVISION

Fullerton, California 92634

INTERNATIONAL SUBSIDIARIES: AMSTERDAM; CAPE TOWN;
GENEVA; GLENROTHES, SCOTLAND; LONDON; MEXICO CITY;
MUNICH; PARIS; STOCKHOLM; TOKYO; VIENNA



Model 374H \$3.00 (1-9 pieces)

Model 374 \$2.75 (1-9 pieces)

IC IDEAS

This month's Ideas	Page
No. 911: Binary number comparator	68
No. 912: Triflop—A three-state memory element	68
No. 913: Digital frequency doubling	70
No. 914: Dual bootstrapping improves amplifier performance	73

Vote for the one you like best.

Write the number of the Idea you like best in the box on the Inquiry Card, and send to us.

Send us practical, reproducible ideas that are original with you and have been implemented with linear or digital ICs.

- If we publish your idea you win a check for \$25.00.
- If our readers vote yours the best of the issue in which it appears, you have your choice of a Simpson 270 or a Triplet 600 multimeter.
- After 12 issues our readers will vote on the best

idea for all 12 issues. The winner gets his choice of either a Hewlett-Packard 1206A or a Tektronix 310A oscilloscope.

Submit your IC Ideas to:
Alberto Socolovsky
Editor
THE ELECTRONIC ENGINEER
Chestnut & 56th Sts.
Philadelphia, Pa. 19139

Here's how you voted

The winning Idea for the November 1969 issue is, "One video amplifier: three oscillators."

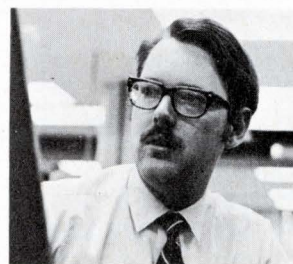

Michael English, our prize-winning author, is an applications engineer at Fairchild Semiconductor in Mountain View, Calif. Mr. English has chosen the Simpson Model 270 multimeter as his prize.

911 Binary number comparator

C. H. Hall, Jr.

EMR Telemetry, Sarasota, Fla.

Very often, you run into the situation where you want to compare two binary numbers to determine if $A < B$, $A = B$, or $A > B$. An easy method of accomplishing this uses one or more of the currently available MSI adders.

The procedure is to sum one of the numbers with the complement of the other. If you get a 1 at the adder output stage that is one bit more significant than the most significant bit of the inputs, then A is greater than B . If this bit is a 0, then A is equal to, or less than B . If the rest of the bits are 1's, then $A = B$; if not, $A < B$.

The figure shows a comparator for two 3-bit numbers. If you were comparing two 4-bit numbers, then

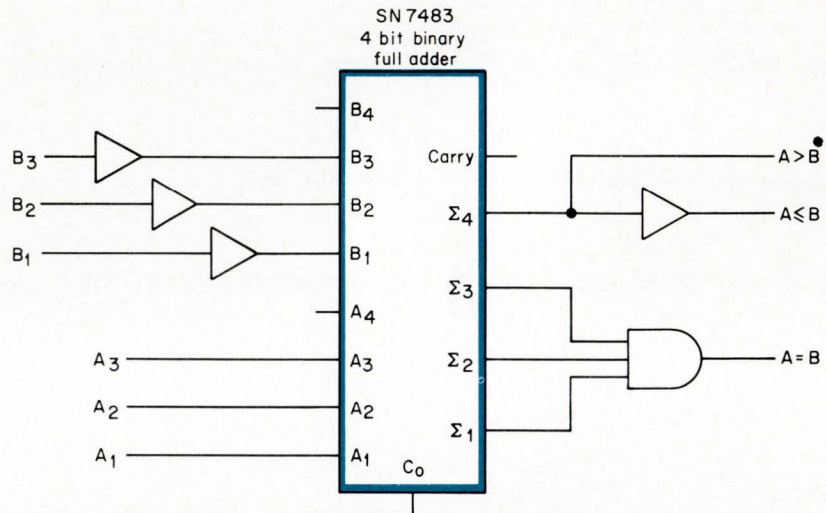

the carry output of the adder would indicate $A > B$. By cascading the

adders, you can extend this procedure to any number of bits.

912 Triflop—A three-state memory element

Anatole Turecki

RCA Information Systems Div., West Palm Beach, Fla.

You can build this 3-state memory element out of two cross-coupled gates. The circuit shown uses $1\frac{1}{2}$ of a Fairchild TT μ L 9004, a dual, 4-input gate chip.

When all three inputs to the circuit are high, one of the outputs is low. Applying a momentary low to one of the inputs causes the corresponding output to go low.

Two obvious applications for the Triflop are as a storage element for the result of a comparator (=, +, or -) or as a selector for a 2-channel switch (neutral, channel 1 or channel 2). In these applications, the circuit replaces at least two flip-flops and some associated logic.

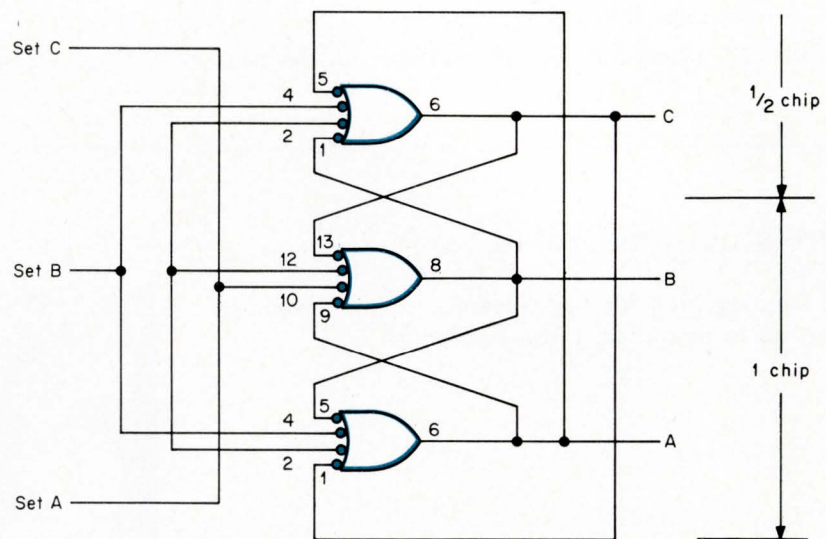

Now! New automated diagnostic tools for detecting digital faults.

A new service! Mellonics offers three fast, reliable and economical computer programs for detecting functional logic faults in sequential digital circuits. Tested, proven, and in use today they meet your design needs for:

LOGIC SIMULATION

to certify design correctness.

TEST SEQUENCE VALIDATION

to verify that all potential functional faults in a logic design will be detected by your test procedure.

AUTOMATIC TEST SEQUENCE GENERATION

to produce a test procedure assuring that all testable functional faults in a logic design will be detected.

And they're easy to use. A qualified engineer/analyst supervises processing, with full data security. Details promptly on request. Contact Test Systems Marketing.

MELLONICS SYSTEMS DEVELOPMENT DIVISION
LITTON INDUSTRIES
1001 WEST MAUDE AVE., SUNNYVALE, CALIFORNIA 94086 (408) 245-0795



913 Digital frequency doubling

David L. Sporre

Electronix Products Co., Westport, Conn.

Here's a circuit that will double the frequency of an input square wave. Gate G_1 inverts the signal and the input of G_2 charges to the gate's threshold voltage through R_1 and C_1 . When the output of G_2 goes to logic 0, C_2 is discharged.

When the input signal returns to 1, C_1 is discharged through the current sinking transistor of G_1 and the output of G_2 charges through R_2 and C_2 . When waveform 3 reaches the threshold voltage of G_3 the output of G_3 goes to 0.

NAND gates G_5 , G_6 , G_7 and G_8 form an exclusive-OR function. This circuit compares waveform 1 and waveform 5 and the resultant output is twice the input frequency.

Since the SN15844N gates have an open collector output, you need pull-up resistors R_1 and R_2 to provide the charge path for C_1 and C_2 . Choose resistors R_1 and R_2 so that their values are low when compared with the input impedance of the next stage.

If the output waveform is not quite symmetrical, you can adjust R_1 and R_2 slightly to obtain symmetry. You can also repeat the circuit to double the frequency as often as desired up to a limit. This limit is established by the propagation delay of gates G_1 - G_4 since they must provide a 90° phase shift between waveforms 1 and 5.

Using the phase shift network means that the width of the output pulse will vary as a function of the input frequency. As frequency in-

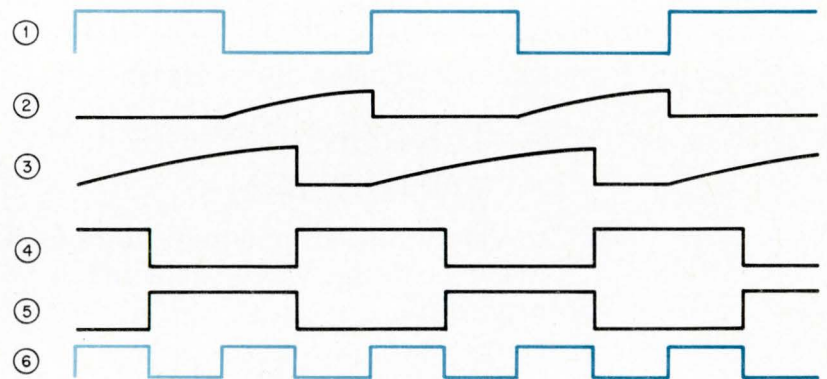
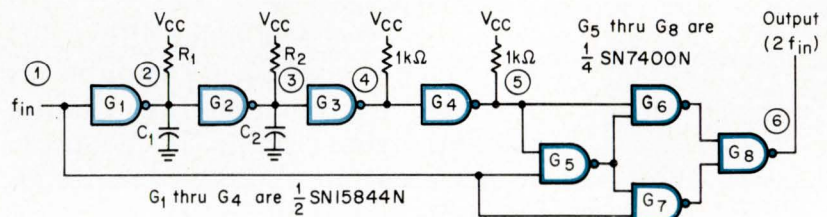

Input	R_1	R_2	C_1	C_2	Output
10kHz	1k Ω	1k Ω	0.1 μ F	0.1 μ F	20kHz
100kHz	1k Ω	1k Ω	.01 μ F	.01 μ F	200kHz
1MHz	100 Ω	100 Ω	.01 μ F	.01 μ F	2MHz
5MHz	1k Ω	1k Ω	0	0	10MHz

creases, the duty cycle of the output increases.

In addition, the delay due to charging the capacitors varies with the threshold voltage of the gates over the temperature range. Threshold voltage variations over a wide temperature range can change the delay by 25% or more.

Adjusting resistor values to compensate for capacitor tolerances and threshold voltage variations can give you a stable circuit for a specified temperature. The table shows

typical values for several different frequencies.

Because the maximum current sinking capability of the SN15844 gate is 150 mA, you must select the resistor so as not to exceed this value. When using large capacitors, you can add a small resistor in series with the outputs of G_1 and G_2 . This provides a small time constant for the capacitor discharge instead of dumping the dI/dT charge into the collector of the output transistor.



MOS AND BIPOLAR COMPATIBILITY—FACT OR FICTION

Now that MOS has been accepted into the design engineers bag of tricks, its compatibility with other forms of logic is the main issue. In the beginning, MOS and bipolar devices were not compatible at all; negative power supplies of 27 and 13 volts, threshold levels of -3 to -6 volts, slower speed, electrically fragile, etc. Sometimes the objections are more against MOS than the compatibility of the two families. Now, process refinements and design expertise have minimized these differences. Any designer that wants to intermix devices can do it if he really chooses. When linear circuits were first made available, the objection was that -6 and +12 volts or ±15 volts were not standard power supplies, MOS can use these same supplies if we manipulate the data sheet requirements.

LEVEL TRANSLATION

There is only one thing to remember about working with any logic element: it doesn't matter what the supply voltages are as long as the absolute magnitude across the device is maintained. A TTL element can operate between 25 and 30 volts or -10 and -5 volt busses because there are only 5 volts across the device. The only restriction is that the ground pin, being the reference point, must always be *more* negative than the V_{CC} pin.

This freedom of power supply levels is also a feature of MOS integrated circuits. Since it is normal procedure to bias the ground pin, it has been renamed the V_{SS} pin. It is the reference point and, for the P channel technology, must always be more positive than any other pin. Let's review why this is true. Consider the structure of an MOS device. A cross sectional view shows two diffused junctions in an N-type substrate. A channel is

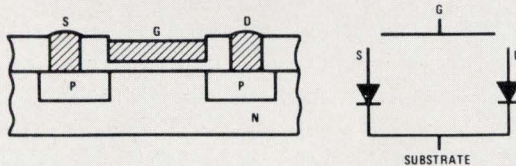

induced between these two junctions to cause operation. The electrical symbol shows the device to be no more than two diodes with a common cathode. The junctions are used merely as contact points for the Source and Drain. If forward biasing occurred without current limiting, the junctions would be destroyed. As long as the substrate remains more positive, the diodes never become forward biased. The gate is electrically isolated by a thin oxide layer.

Process innovations, as stated before, have provided the designer with a method of achieving compatibility between MOS and bipolar IC's. The use of 1-0-0 crystal orientation silicon has yielded threshold voltages in the -1.8 to -2.5 volt range. These levels allow operation with +5 and -12 volt power supplies. Typical voltage levels for several different design configurations are shown below.

SHIFT REGISTER OPERATION

Most all low threshold voltage devices have characteristics like those shown under "existing register voltages" below. The National Semiconductor dynamic and static registers numbered MM400/500 through MM407/507, for example, fit this category. Newer designs such as the MM4015/5015, MM4050/5050, MM4051/5051 and many more to come will be designed with the "newer designs" logic levels shown.

	INPUT LEVELS		OUTPUT LEVELS		POWER SUPPLIES			
	V_{IL}	V_{IH}	V_{OL}	V_{OH}	V_{DD}	V_{GG}	V_{SS}	V_{ϕ}
Existing register voltages	-2.5	-7.0	-1.5	-8.0	-10	-16	GND	0 to -16
Newer designs register voltages	-2.5	-4.0	-1.5	-6.0	-10	-16	GND	0 to -16

These voltage values can be shifted to any convenient level as long as all voltages are shifted by the same potential. To make the "newer designed" registers shown above operate in a bipolar system, the levels can be shifted positive by +5.0 or +10.0 volts with the following results.

V_{IL}	V_{IH}	V_{OL}	V_{OH}	V_{DD}	V_{GG}	V_{SS}	V_{ϕ}
-2.5	-4.0	-1.5	-6.0	-10	-16	GND	0 to -16
+2.5	+1.0	+3.5	-1.0	-5	-11	+5	+5 to -11
+7.5	+6.0	+8.5	+4.0	GND	-6	+10	+10 to -6

Since these power supply voltages shown are nominal supplies, the device could operate satisfactorily between +5 and -12 volts, standard power supply values. This example shows that the popular misconception that MOS operates on negative voltages should be put to bed. They can be operated in the manner indicated: +5 and -12 volts, or +10 and -6 volts. A resistive pull-up on the input and a current sinking resistor on the output provides bipolar compatibility as shown. Second generation shift register designs such as the MM5050 will eliminate the resistors.

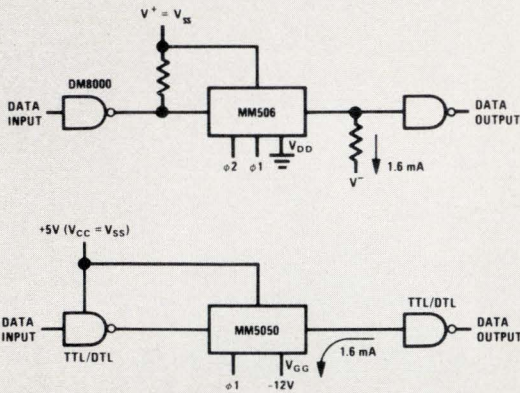

This form of interface can even be used to improve the operating frequency of MOS devices. When the MOS shift register is driving TTL, the total signal swing from a logic "0" to a logic "1" is reduced, hence the delay time is minimized. A long serial delay line, consisting of 1 MHz operating frequency shift registers, can be made to operate at 2.0 MHz by this method.

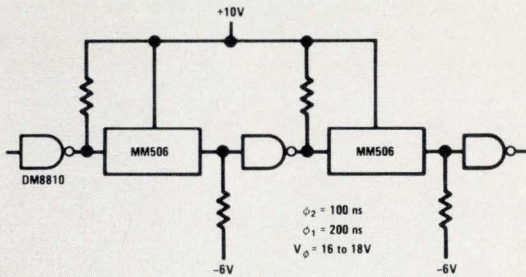

COST PROJECTIONS

Improved circuit design and process innovations are continually pushing aside objections to the MOS/bipolar hybrid system. The cost advantage and systems size reduction realized by utilizing long MOS shift registers in memory applications have come of age. Long shift registers compete favorably in price with magneto-strictive and glass delay lines. Price projections show 1970 pricing for long registers to achieve a penny a bit. The price coupled with the handling ease and smaller size of MOS registers will make replacement of delay lines a necessity during 1970.

READ ONLY MEMORY OPERATION

The read only memory designs have been made around ± 12 volt operation. The rules, however, remain the same. MOS transistor threshold voltage is between -1.8 to -3.0 volts and bipolar compatibility is again maintained. The series 54/74 or DM8810 devices have the ability to hold off 12 volts on their output. The DM8810 Quad Gate and DM8812 Hex Inverter have an output break-

down specified at 14 volts. The interface between these elements is again a pull-up resistor on the input and a current sinking resistor on the output as shown.

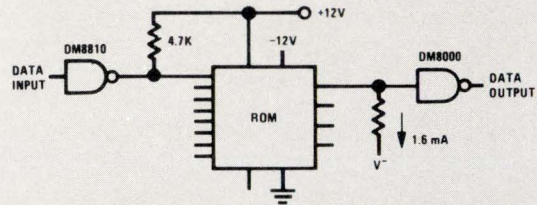

Application briefs have been written to describe a character generator system or a delay line application that mixes the two worlds. By using a ROM for micro-programming, code conversion, character generation, table lookup and so forth, a system becomes fewer and fewer components. In fact, any random logic function that can be expressed in a truth table can be programmed into a ROM. Just try it.

CLOCK DRIVERS

The shift registers must be clocked and the clock must be generated from some source that will provide clock pulse amplitudes of 10 to 18 volts. Clock drivers that provide proper level translation have been developed by National. The NH0007 is a single phase clock driver capable of driving about 800 pF of clock line capacitance at 1.0 MHz and the NH0009 and NH0013 are two phase clock drivers capable of driving 1600 pF per line at 1.0 MHz. Another driver, the NH0012 has been developed for those clock driver applications requiring 10.0 MHz operation. The limiting parameter for these devices is power dissipation. The NH0007 is in a TO-5 can and is capable of dissipating about 300 milliwatts of power. The NH0009, NH0012 and NH0013 are in TO-8 cans and are capable of dissipating about 1.5 watts of power. The transient power for the driver is a function of speed, voltage amplitude, and load capacitance. The drive capability must be restricted so that the maximum power rating is observed. To calculate the power dissipated, the AC power is given by $P_{AC} = CV^2f$. The standby power is a small percentage of the total power dissipated. For further details, refer to MOS Brief 9.

CONCLUSION

Our goal is to provide complete systems capability. We have achieved this with the availability of our MOS product line; bipolar logic for data manipulation, and MOS shift registers and read only memories for memory and micro-programming applications.

National Semiconductor Corporation

2900 Semiconductor Drive, Santa Clara, California 95051
(408) 732-5000 / TWX (910) 339-9240



3-70 PRINTED IN U.S.A.

914 Dual bootstrapping improves amplifier performance

Basil T. Barber

Sperry-Rand Corp., Great Neck, N.Y.

Using linear integrated circuits with a single power supply in high impedance implementations generally results in bias networks of equal or higher resistance values than the input impedance. In very low noise level applications in the sub-audio frequency range, the thermal noise generated by this equivalent bias resistance can become the limiting factor in attaining a wide dynamic range.

By using dual bootstrapping, you can increase the input impedance, lower the equivalent bias resistance and generate the proper dc bias levels and feedback ratios simultaneously. The final Z_{in} is the combination of the four terms shown, with the values of R_1 and R_2 determined by the input current and bias level requirements of the $\mu A730$.

The second term shown is a potentiometric feedback, increasing the amplifier's input impedance by its closed loop gain.

$$Z_{in} (1 + kG) = 1.4 M\Omega$$

The third term indicates the effect of the bootstrapping on the value of R_2 .

$$\frac{R_2}{1 - k/1 + kG} = 71 R_2 = 2.7 M\Omega$$

The fourth term, Z_{cm} , is the common-mode input impedance of the $\mu A730$ and is in the vicinity of 10 M Ω . Combining the four terms to

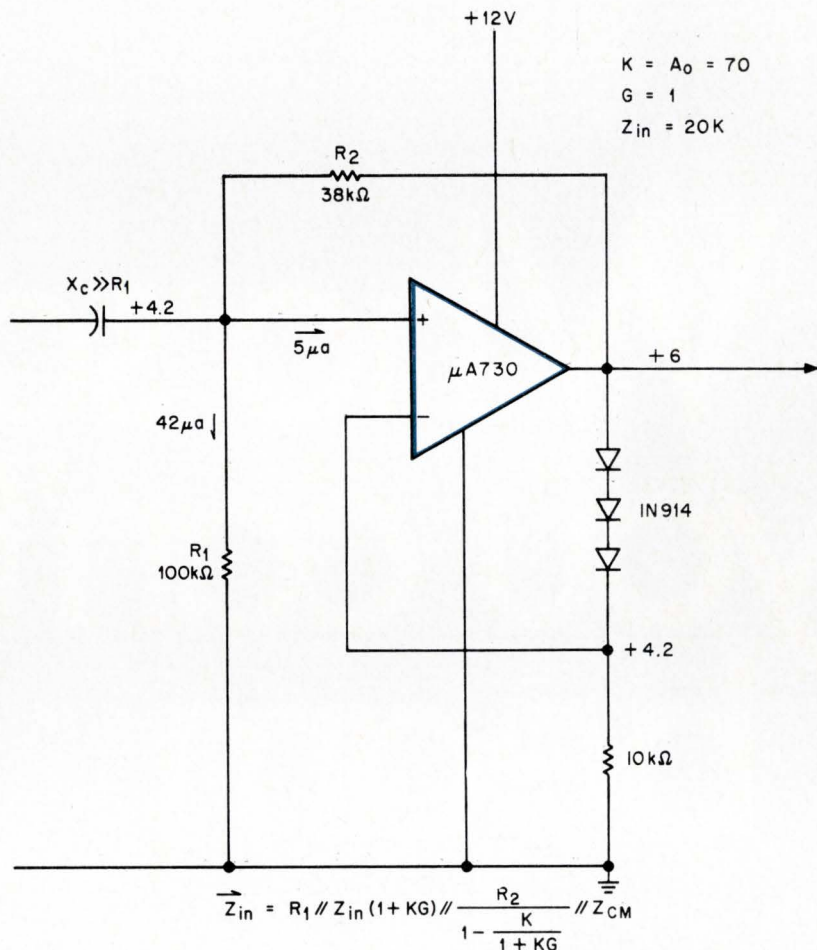

$$\begin{aligned} K &= A_o = 70 \\ G &= 1 \\ Z_{in} &= 20K \end{aligned}$$

find Z_{in} gives:

$$Z_{in} = 100k // 1.4M // 2.7M // 10M = 90k$$

The equivalent bias resistance is

$$R_b = 38k // 100k \approx 28k$$

Compared to R_b levels of 90k, a reduction in thermal noise of

$$\sqrt{\frac{4kT \cdot BW \cdot 28k}{4kT \cdot BW \cdot 90k}} = 5dB$$

is possible.

Who says you can't get beam lead?

Raytheon beam lead devices
available now in chip form,
in standard or custom packages,
or in hybrid assemblies.

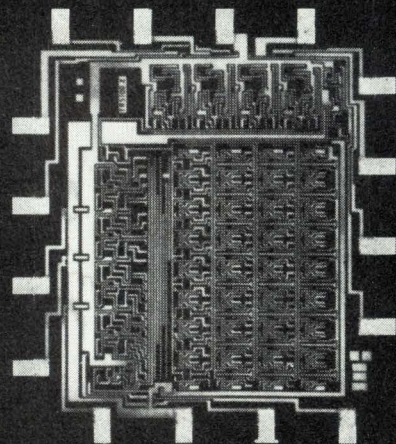

Help! We're up to our ears in beam lead semiconductor devices. All kinds. And more coming every day.

Hybrids, cans, dips or chips

Buy the chips. Take them in TO-18 cans or DIPs. Get them in custom packages. Or take advantage of our capability to design, assemble and completely test them in custom hybrid assemblies.

Any way you need them, we'll sell them. Now.

So don't just stand there. Send orders.

To the company that gets the ideas and delivers the goods.

Raytheon Semiconductor,
350 Ellis St.
Mountain View,
California
94040.
Phone (415)
968-9211.

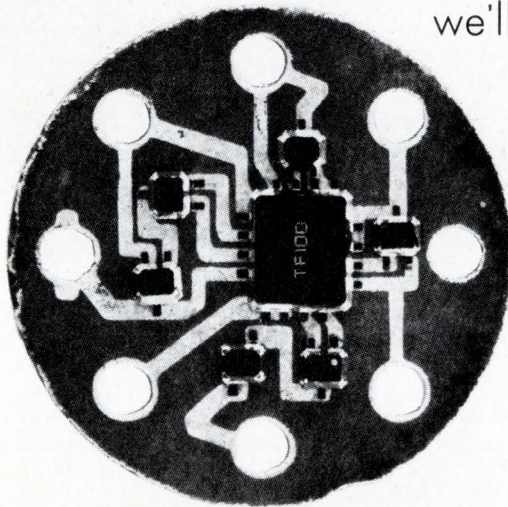

Raytheon custom beam lead hybrid assembly

Come and get them

Beam lead T²L RAY I & II series

RG130, 1, 2, 3: Dual 4 input line driver	Now
RG200, 1, 2, 3: Expandable single 8 NAND gate	Now
RG220, 1, 2, 3: Quad 2 input NAND gate	Now
RG230, 1, 2, 3: Quad 2 input AOI expander	Now
RG240, 1, 2, 3: Dual 4 input NAND gate	Now
RG250, 1, 2, 3: Expandable quad 2 AOI gate	Now
RG310, 1, 2, 3: Exp. dual output, dual 2 input AOI gate	Now
RG320, 1, 2, 3: Triple 3 input NAND gate	Now
RG380, 1, 2, 3: Hex inverter	Now
RF100, 1, 2, 3: Dual J-K flip-flop (separate clocks)	Now
RF110, 1, 2, 3: Dual J-K flip-flop (common clock)	Now
RF200, 1, 2, 3: J-K flip-flop (AND inputs)	Now
RF210, 1, 2, 3: J-K flip-flop (OR inputs)	Now
RF9601/8601: Retriggerable monostable multivibrator	Now
RL10, 1, 2, 3: Fast full adder	Now
RL20, 1, 2, 3: Dependent carry fast adder	Now
RL30, 1, 2, 3: Independent carry fast adder	Now
RL40, 1, 2, 3: Carry decoder	Now
RL60, 1, 2, 3: Four bit storage register	Now
RL70, 1, 2, 3: Four bit storage register	Now

Beam lead T²L RAY III series

RG3380, 2: Hex inverter	Now
RG3390, 2: Dual 4 input AND gate (split outputs)	Now
RG3410, 2: Quad 2 input NOR gate	Now
RF3200, 2: J-K flip-flop (AND inputs)	Now

Beam lead linear circuits

RM709: Operational amplifier	Now
RM741: Operational amplifier	Now

Beam lead transistors

BL1000: 2N930 equivalent. TO-18 cans 6/15. Chips	Now
BL1001: 2N2484 equivalent. TO-18 cans 6/15. Chips	Now
BL1002: 2N918 equivalent. TO-18 cans 6/15. Chips	Now
BL1003: 2N2221 equivalent. TO-18 cans 6/15. Chips	Now
BL1004: 2N2221A equivalent. TO-18 cans 6/15. Chips	Now
BL1005: 2N2222 equivalent. TO-18 cans 6/15. Chips	Now
BL1005QD: Quad DIP 2N2222	Now
BL1006: 2N2222A equivalent. TO-18 cans 6/15. Chips	Now
BL1007: 2N2906 equivalent. TO-18 cans 6/15. Chips	Now
BL1008: 2N2906A equivalent. TO-18 cans 6/15. Chips	Now
BL1009: 2N2907 equivalent. TO-18 cans 6/15. Chips	Now
BL1010: 2N2907A equivalent. TO-18 cans 6/15. Chips	Now
2N929: Available in chips only	Now
2N2369: Available in chips only	Now
2N2483: Available in chips only	Now
2N2604: Available in chips only	Now
2N2605: Available in chips only	Now
2N2894: Available in chips only	Now
2N2945: Available in chips only	Now

Beam lead diodes

IN914: Available in chips only	Now
IN3600: Available in chips only	Now

Beam lead memories

RR6100: 64 bit bipolar RAM (0° to 75°C)	6/15
RR5100: 64 bit bipolar RAM (-55° to 125°C)	6/15
RR6110: 256 bit bipolar RAM multi-chip array	6/15



SUPPLIED THE ECONOMICAL WAY
... THRU DISTRIBUTORS

BUSS QUALITY

FUSES

SMALL DIMENSION

FUSES and FUSEHOLDERS

For dependable protection of all types of Electronic and Electrical Circuits and Devices.

The complete line of BUSS quality fuses includes fast-acting and slow-blowing types, visual-indicating/alarm-activating types, miniature and subminiature sizes, and Tron rectifier fuses for the protection of various solid state devices. Ratings range from 1/500 to 1000 amps.

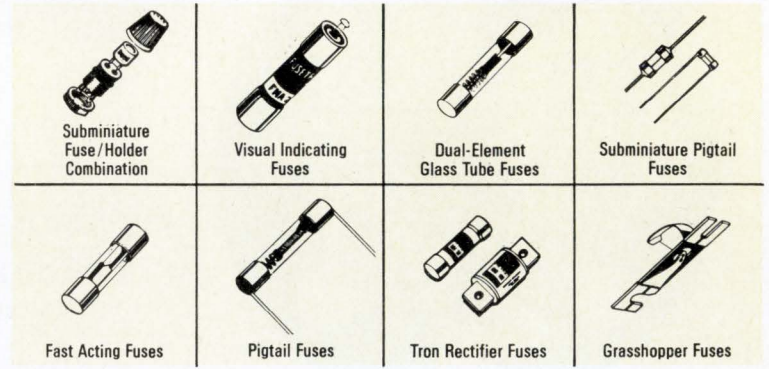
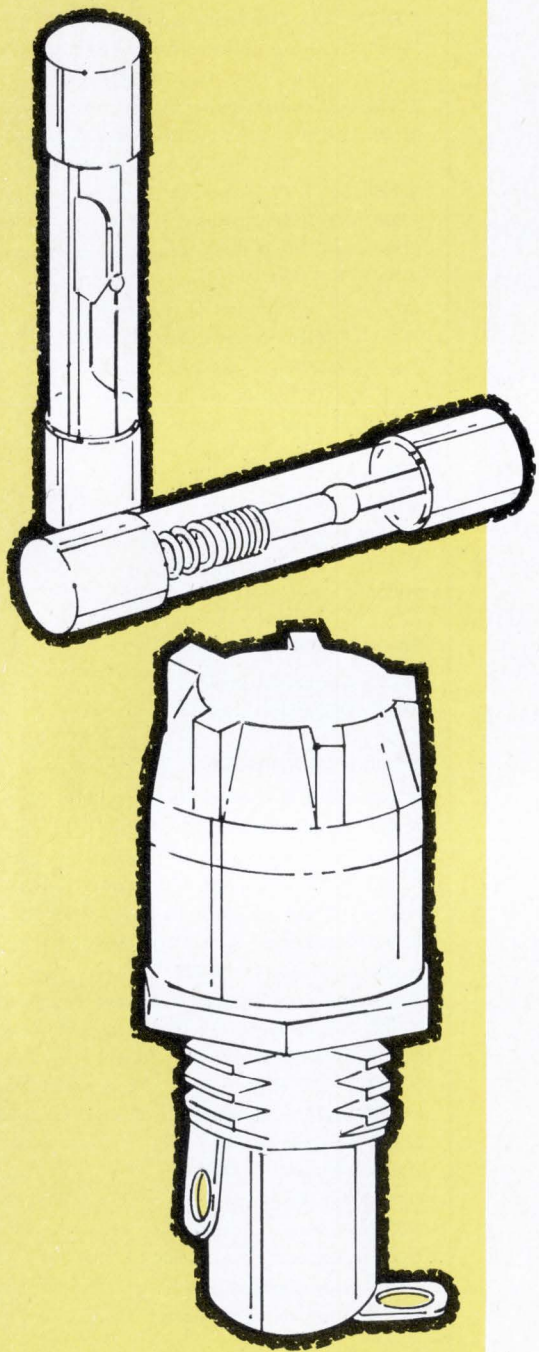

The comprehensive line of BUSS quality fuseholders includes in-line and panel-mounted types, available in standard or space-saving sizes, and covers lamp-indicating, alarm-activating, and RF interference-shielded types. There is also a full line of fuse-blocks and related mounting hardware, available with solder, screw, or quick-connect terminals.

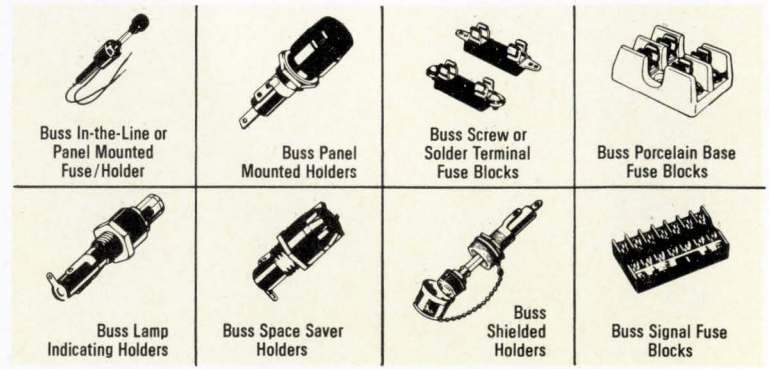

Write for BUSS Bulletin SFB.

BUSSMANN MFG. DIVISION, McGraw-Edison Co., ST. LOUIS, MO. 63107

Feature article abstracts

Published information is vital to your job.

To save time in finding this information,
we have abstracted the important technical features
from eight electronic engineering publications.

Should any of these articles interest you, contact the magazine—
names and addresses are listed below.

Reprints of articles with an asterisk are available free.

Save this section for future reference.

Amplifiers

The low-power-drain microelectronic VHF amplifier, S. Cho and A. G. Thiele, Motorola Inc., "IEEE Spectrum," Vol. 7, No. 3, March 1970, pp. 49-53. The discrete approach may be the answer when working with VHF micropower device applications. Thin-film, thick-film and monolithic techniques do not offer the advantages that the microdiscrete technique does.

Charts and Nomographs

Check peak fm deviation the easy way, J. Tary & T. Livingston, Environmental Science Services Administration, Electronic Design, Vol. 18, No. 5, March 1, 1970. A graph that saves conversion of Bessel functions into decibels when calculating fm spectra is presented. It plots $20 \log_{10} J_n(\beta)$ vs β . The modulation index (β) can be found if spectrum line and the change relative to the unmodulated carrier, in dB, are known.

Circuit Design

Program designs active filters, Frederick Shirley, Sanders Associates, Inc., Electronic Design, Vol. 18, No. 6, March 15, 1970, pp. 188-195. A basic program for designing Butterworth or Chebyshev RC band filters is given. A Butterworth bandpass filter and a Chebyshev band-stop filter are used as design examples.

Try an active crystal filter, Dr. Paul Gheorghiu, VP, Lory Electronics, Inc., "Electronic Products," Vol. 12, No. 12, March -5, 1970, pp. 29 & 48. This article shows you how to combine a crystal and an active circuit to give you a filter with the high rejection normally associated with a twin-T notch. Included is a schematic diagram of a 100 kHz filter built with discrete components.

Communications

Man-machine conversational data communications systems, Hideo Ohigashi, Electro-technical Laboratory, Tokyo, "IEEE Spectrum," Vol. 7, No. 3, March 1970, pp. 77-82. A survey of recent work in the man-machine conversational data communications field is presented by the author. He includes descriptions of two of his inven-

tions—a data communication system and a conversational information-processing system—and calls for improved international standards for the conversational mode.

Components

Wire or cable has many faces—know them all before choosing—Part II, Frank Timmons, Belden Corp., "EDN," Vol. 15, No. 5, Mar. 1, 1970, pp. 49-55. Mr. Timmons concludes his discussion of wire and cable selection with a description of shielding, jacketing, and general construction. The author tells us that we should use a standard cable if possible, but not to be afraid of specifying custom designs.

Chip capacitors, Irwin Sherry, Western Editor, "Electronic Products," Vol. 12, No. 12, March 15, 1970, pp. 23-28. The growth of hybrid circuit technology has given a big boost to one segment of the passive component industry—chip capacitors. This report looks at some of the materials that the ceramic people are using and reports on the competition between ceramics and tantalum in the $1 \mu\text{f}$ range. Also discussed are tantalum films and MOS chips for the low capacitance applications.

Computers and Peripherals

A serial input/output scheme for small computers, John D. Meng, University of California, "Computer Design," Vol. 9, No. 3, March 1970, pp. 71-75. Transmitting data to and from a computer serially has certain advantages. The I/O scheme described here, for example, uses only four coaxial cables, plus one for each terminal as opposed to over 200 or so wires that would be required in a parallel installation. Inexpensive, but relatively fast shift registers make it possible.

An efficient way of transferring synchronous sequential data, Julian S. Loui, Codex Corp., "Computer Design," Vol. 9, No. 3, March 1970, pp. 77-83. Here is a fast, systematic method of transferring synchronous sequential data from a state table to Karnaugh maps. It uses augmented flip-flop transition tables and octal numbers. The augmented table functions as a

Magazine publishers and their addresses

Computer Design

Computer Design Publishing Corp.
Prof. Bldg., Baker Ave.
W. Concord, Mass. 01781

EDN

Cahners Publishing Company
3375 S. Bannock Street
Englewood, Colo. 80110

EEE

Mactier Publishing Co.
820 Second Avenue
New York, N. Y. 10017

Electronic Design

Hayden Publishing Co.
850 Third Avenue
New York, N. Y. 10022

Electronic Products

United Technical Publications
645 Stewart Avenue
Garden City, N. Y. 11530

Electronics

McGraw-Hill, Inc.
330 W. 42nd Street
New York, N. Y. 10036

IEEE Spectrum

Institute of Electrical & Electronics
Engineers
345 East 47th Street
New York, N. Y. 10017

The Electronic Engineer

Chilton Company
56th & Chestnut Streets
Philadelphia, Pa. 19139

*Reprints available free. Request them on your company letterhead.

fast vehicle between the state table and the maps. It also provides a useful record for checking purposes. The octal numbers are used to code the states and cells in the transition table and maps.

Digital Design

Synchro-to-digital converters, Hermann Schmid, General Electric Co., *Electronic Design*, Vol. 18, No. 6, March 15, 1970, pp. 178-185. This is part I of a series adapted from Mr. Schmid's book "Electronic Analog/Digital Conversion." A brief review of the conventional methods for converting the ac outputs of electromechanical sensors into digital form precedes a section on improved techniques. The three standard conversions for encoding ac signals are single-phase ac-to-digital conversion, synchro/resolver-to-digital sine/cosine conversion, and synchro/resolver-to-digital angle conversion. Each is discussed in detail, and several schematics are provided.

EMI

Electromagnetic interference worry you?, John Steenburgh, IBM Corp., *Electronic Design*, Vol. 18, No. 6, March 15, 1970, pp. 199-201. The construction of a small computer is illustrated step-by-step as an example of how to design good shielding. Good shielding protects the circuit from outside interference and contains internally generated energy that could contaminate other equipment.

Integrated Circuits

***How to select a time-sharing service**, Alan G. Hammersmith, Time-Sharing Enterprises, "The Electronic Engineer," Vol. 29, No. 5, May 1970, pp. C2-C3. The time-sharing field, which has exploded recently with new vendors offering a wide spectrum of systems and capabilities, is assessed by the author. Suggestions for the new user as well as the established user who is shopping around are listed, including how to judge a system, whether to go batch or time-sharing, and what to do and what not to do when you select a time-sharing service.

*** Complementary MOS logic and applications**, S. S. Eaton, RCA Electronic Components, "The Electronic Engineer," Vol. 29, No. 5, May 1970, pp. 52-57. This article is the fourth part of a course on MOS integrated circuits. In this installment, the author describes logic circuits constructed with complementary-MOS (as opposed to the more familiar single-polarity circuits). Also included is a description of the unique characteristics of these C-MOS circuits and how they are particularly suited for certain applications.

LPRTL—the new panacea?, Clark Davis, National Semiconductor Corp., "Electronic Products," Vol. 12, No. 12, March 15, 1970, pp. 36-39. Here is a report on the new low power TTL circuits—those that dissipate 1 mW/gate. You will also find a comparison with two other types of low power digital circuits, LPRTL and MWRTL.

Dual monolithic FET's for tight tracking applications, Jim Phalan, Intersil, Inc., "Electronic Products," Vol. 12, No. 12, March 15, 1970, pp. 30-32. This is basically a report on the Intersil IMF3954 series of monolithic dual J-FETs. You will find a discussion of the device construction and its superior tracking characteristics when compared to matched units.

Materials

Use piezoelectric ceramics, J. G. Copland & C. T. Durham, General Electric Co., *Electronic Design*, Vol. 18, No. 5, March 1, 1970, pp. 60-64. There is a large variety of ceramic transducers commercially available that have superior design flexibility over naturally occurring crystals. A tabulation of these, containing strain constants, voltage constants, and electromechanical constants is presented. Several practical applications are outlined.

Microwaves and Microwave Products

Ballistic-missile defense radars, Charles M. Johnson, U. S. Army Safeguard System Office, "IEEE Spectrum," Vol. 7, No. 3, March 1970, pp. 32-41. Problems and a solution are discussed on the feasibility of a defense ICBM network subjected to a "high traffic environment." Advances in phased-array technology coupled with all solid-state design are proposed as the answer to a more effective, low maintenance Safeguard system.

Power Supplies

Step up power-supply efficiency, Frederick Wolf, Westinghouse Electric Corp., *Electronic Design*, Vol. 18, No. 5, March 1, 1970, pp. 66-68. To get high efficiency and good regulation in a high-voltage supply, the author suggests using a highly efficient unregulated supply to provide most of the power, with a well regulated supply handling only the fraction necessary to adjust for line and load variations. The design of a 15-kV, 2-kW supply is considered and schematics are given.

Semiconductors

The metal-semiconductor contact: an old device with a new future, A. Y. C. Yu, Fairchild Semiconductor, "IEEE Spectrum," Vol. 7, No. 3, March 1970, pp. 83-89. Because of improvements in Schottky-barrier diodes, the author looks for these devices to be used much more than in the recent past, both as discrete devices and as a component in ICs. He also discusses various fabrication techniques and applications.

Can you build a system with off-the-shelf LSI?, Elizabeth de Atley, West Coast Editor, *Electronic Design*, Vol. 18, No. 5, March 1, 1970, pp. 46-51. In the second of two articles the possibilities for building a system out of standard or custom LSI are discussed by seven semiconductor experts. ROMs, universal registers, and microprogrammed LSI are aired. There is a lot of optimism about improvements in semiconductors, but no conclusions about just how far progress will go and still be economical.

Systems

Diagram sequential logic on a cube., Gerardo Fiedler, Texas Instruments, *Electronic Design*, Vol. 18, No. 5, March 1, 1970, pp. 54-58. The cube diagram graphically presents the states of memory elements in a sequential system. A control module for an interface between a computer and a DVM is used to illustrate the technique. A block diagram of the interface determines the sequence of control module functions and is the design starting point. The information is transferred to the cube diagram, which allows visualization of the logic operation and keeps track of successive operations.

The direct function processor concept for system control, Saul B. Dinman, GRI Computer Corp., "Computer Design," Vol. 9, No. 3, March 1970, pp. 55-60. This inexpensive approach to system control lets you directly address all internal and external elements by using a compiler-like functional language rather than a mathematically oriented one. Thus, it's not necessary to develop complex command sequences that translate process data into a language that the computer can understand and then back again into instructions that the equipment can react to. The result is a flexible machine with true modularity and expandability.

Test and Measurement

Working with subnanosecond pulses, Earle Dilatash, Tech. Ed., "EDN," Vol. 15, No. 5, Mar. 1, 1970, pp. 33-46. Here's a discussion of what is happening in the world of fractional nanosecond pulses. Mr. Dilatash describes the problems in generating and transporting such pulses, as well as the difficulties of calibrating test equipment to measure them. The author also describes some applications of these pulses in TDR, navigation, and so forth.

Miscellaneous

The Burndy Library: window on the history of science, Gordon D. Friedlander, Staff Writer, "IEEE Spectrum," Vol. 7, No. 3, March 1970, pp. 54-64. The rich diversity of this library-museum for scientific treasures is presented by the author. Situated in Norwalk, Conn., the Burndy is a veritable treasure trove of electrical instruments, books and manuscripts.

Underground transmission in the United States, Charles F. Avila and Andrew F. Corry, Boston Edison Company, "IEEE Spectrum," Vol. 7, No. 3, March 1970, pp. 42-48. More problems than excessive cost are at present interfering with conveying large blocks of electric energy underground. The authors survey the field today and present possible solutions.

Infrared and microwave communication by moths, Henry S. Hsiao and Charles Susskind, University of California, Berkeley, "IEEE Spectrum," Vol. 7, No. 3, March 1970, pp. 67-76. Bioengineers engaged in research on moths cannot unequivocally state that electromagnetic communication exists among moths, but neither can they exclude the possibility of some response to infrared radiation. A definite proof of such a hypothesis would allow less harmful means of pest control than that available now.



BETTER QUALITY AND RELIABILITY THROUGH CONTROL

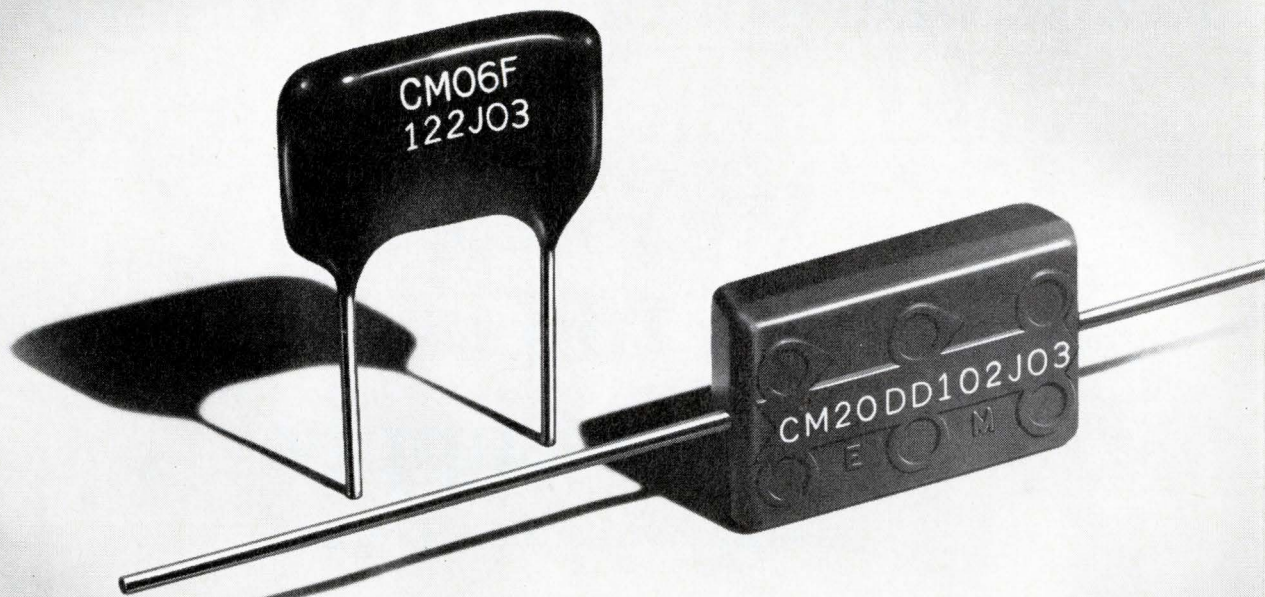

Shown 2½ x Actual Size

Capacitor Problems That Require A Lot Of Self-Control...Chemically Speaking

Problem 1: How to make sure the silver paste composition used for electrodes provides the best results for each electrical parameter in a given capacitor design?

Problem 2: How to improve the recognized moisture reliability of our dipped mica capacitors without adversely affecting life reliability?

Problem 3: How to upgrade the reliability of molded mica capacitors to equal that of dipped mica capacitors so designers can take advantage of body uniformity and axial lead design?

Solution: Chemical self-control! To do this we operate our own chemical manufacturing plant where we formulate silver pastes, phenolic dipping compounds, and epoxy molding compounds — all under strict controls.

Result: Dipped mica capacitors and molded mica capacitors of equally high reliability that operate up to 150°C. Send for technical literature and always insist on El-Menco brand capacitors . . . your assurance of better quality and reliability through control.

THE ELECTRO MOTIVE MFG. CO., INC.

WILLIMANTIC, CONNECTICUT 06226

Dipped Mica • Molded Mica • Silvered Mica Films • Mica Trimmers & Padders
Mylar-Paper Dipped • Paper Dipped • Mylar Dipped • Tubular Paper

West Coast Manufacturers contact: COLLINS & HYDE CO., 900 N. San Antonio Rd., Los Altos, California 94022
5380 Whittier Blvd., Los Angeles, California 90022

ALSO SOLD NATIONALLY THROUGH ELECTRONIC PARTS DISTRIBUTORS

**The best power supply
to tuck into impossible spaces
is the one specifically designed
to tuck into impossible spaces.**

We make it.

**We call it our Impossible Space
Power Supply.**

(also known as the JR series)

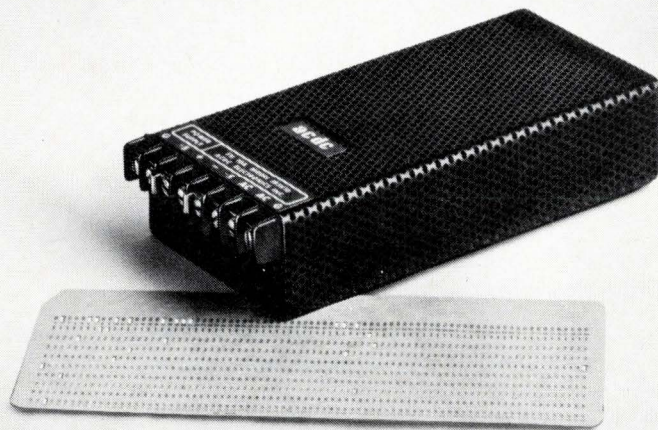

Weighing in at a mere 1.5 pounds and measuring only $1\frac{3}{8}'' \times 3\frac{1}{8}'' \times 6.5''$, ACDC's new JR offers more watts per unit volume than any other miniature power supply on the market. It's so small that you can put five of them in the same space normally occupied by one of "theirs"...so efficient (80%) that it requires no internal heat sinks...and so noise-free that you can use it anywhere.

Three JR models are available in continuously adjustable output voltage ranges from

3.0 to 30 volts (0.1% regulation) and in current ratings from 2.0 to 10 amps. And most important, it operates from conventional 60 or 400 cycle input.

Of course, the JR costs a little more than conventional power supplies (\$285 in small quantity), but if space and efficiency is your problem, the JR is your only answer.

Get one today...or ten...or a hundred. They're on the shelf.

acdc electronics inc.

Oceanside Industrial Center, Oceanside, California 92054, (714) 757-1880

NEW PRODUCTS

New plastic behaves like metal

A new plastic which functions at temperatures over 600°F, has high dielectric and mechanical strengths and is self-lubricating, has been demonstrated by The Carborundum Co.

Known as "Ekonol," it can be plasma-sprayed as well as formed by high-speed metallurgical techniques. Since it is formed under conditions used for fabricating many metals, it creates a new class of materials—metal-polymer blends.

The new plastic, which will be available in powder form and basic shapes, is known generically as p-oxybenzoyl polymer. The monomer is derived from phenol and carbon dioxide—readily available and inexpensive materials. Test data indicate that it has about twice the stiffness of any other polymer. It also has higher dielectric properties and thermal conductivity, and combines these properties with ease of machining and self-lubricating characteristics.

Electronic applications are expected to be in the areas of data processing equipment, circuit boards, substrates, relay actuators, dielectric parts, terminals, strips, sockets, coil forms, high-heat components, and plasma-sprayed metal parts.

It can be engineered to serve as an insulator or a controllable conductor, properties that have not been previously achieved in either a metal or a polymer.

Initial pricing of Ekonol powder is forecast at \$35/lb. in 1 to 50 lb.

Physical properties of high-temp plastics (unfilled)

	Ekonol	Commercial Polyimide	Commercial Fluoro-Carbon
Density (g/cc)	1.44-1.48	1.40	2.13
Flexural Strength (psi)	10,700	11,800	—
Elastic Modulus (psi)	1.03 x 10 ⁶	0.6 x 10 ⁶	0.09 x 10 ⁶
Load Carrying Capacity	Ex.	Ex.	Poor
Machinability	Ex.	Fair	Good
Water Absorption (%):			
24 hr @ 73°F	0.02	0.3	0.01
500 hr @ 212°F	0.4	—	—
Coeff. of Thermal Expansion (in./in./°F 10 ⁻⁵)	2.8	2.4	5.5
Thermal Conductivity (cal/s/cm ² /°C/cm x 10 ⁻⁴)	18.0	3.5	6.0
Dielectric Strength (V/mil) (molded shapes)	660	430	620
Dielectric Constant	3.8	3.62	2.1
Diss. Factor (x 10 ⁴)	1.98	34	3.0
Volume Resistivity (Ω/cm)	10 ¹⁵	10 ¹⁵	10 ¹⁵

quan.; \$25 in 50 to 100 lb. lots, and \$15 in 100 to 1000 lb. quan. Substantial price reductions are expected as

production increases. The Carborundum Co., Niagara Falls, N. Y. 14302
Circle 219 on Inquiry Card

Monolithic alphanumeric display

Continuing the trend to light-emitting, solid-state displays, Monsanto Co. has introduced the MAN-3—a totally monolithic 7-segment display.

Monsanto forms the active, light-emitting areas of the display by diffusing zinc into n-type gallium-arsenide, phosphide wafers. The resultant light output is in the 6300 to 7000-Å range (red light).

These displays include all the well known advantages of solid-state devices—including low power consumption. For example, each segment dis-

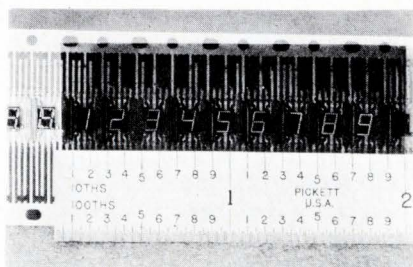

sipates 8 mW (1.6 V at 5 mA). So, even with a row of 8's you'll only be using 56 mW per digit.

The MAN-3 measures 0.116 x 0.067 in. and is cast in clear epoxy for

protection. The package measures 0.24 x 0.163 in. and the connecting leads project from the package sides. You can buy the units individually or pre-assembled on a printed circuit board. With the PC assemblies, you get a choice of individual addressing or multiplex operation.

The MAN-3 costs \$12.45 ea, in 1-9 quantities. In lots of 1000, the price drops to \$7.55. Monsanto Electronic Special Products, 10131 Bubb Rd., Cupertino, Calif. 95014.

Circle 220 on Inquiry Card

Counters feature 10-ns resolution

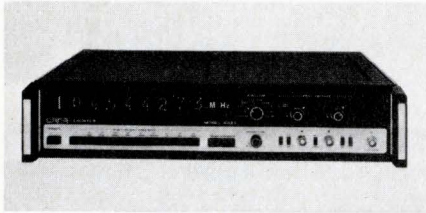

MODEL	Price	TIME INTERVAL FREQUENCY TO:			
		100 ns	10 ns	120 MHz	500 MHz
8010	\$1495	X		X	
8015	\$2095		X	X	
8020	\$2295	—	—		X
8030	\$2595	X			X
8035	\$3095		X		X

The High Frequency Division of Dana Labs recently introduced its 8000 Series of digital counters. All models measure frequency directly up to 120 MHz, with 50 mV sensitivity. Period, multiple period average, totalize, and frequency scaling are standard. All units also feature an eight digit display, a TTL compatible systems interface, and an internal reference oscillator with an aging rate of 3×10^{-9} per day. Because a temperature compensated crystal oscillator is used, a 30-second warmup time is achieved.

Also available is 10- or 100-ns time interval resolution. Some models have a prescaled rf range from 10 MHz to 500 MHz, with a sensitivity of $500 \mu\text{V}$. A fast-acting automatic gain control provides constant performance for signal fluctuations between $500 \mu\text{V}$ and 300 mV. Full accuracy is maintained with up to 99% amplitude modulation on the rf signal. Models with rf capability also have an error prevention feature that will display all zeros any time the input signal is discontinued during the measurement cycle.

The table below shows prices, and which time interval and frequency capabilities are available in the five models.

Annoying readjustments of trigger levels are virtually eliminated because of high stability input amplifiers for each channel. Trigger levels drift less than 5% of full scale in 200 hours, over the temperature range of 20-30°C.

Dana Laboratories, Inc., High Frequency Division, 2401 Campus Drive, Irvine, California 92664.

Circle 221 on Inquiry Card

Disc system expands IBM 1130 capacity

Users of IBM's 1130 computer can now expand their system's capability economically and, at the same time, protect their investment in user programs and education. Memorex's Model 3610—designed specifically for the 1130—is a disc storage system that rents for \$750/mo. This is about 60% of the rental cost of comparable systems, and yet reduces compile, assembly, and sort times. The rental includes maintenance and an integrated

control unit.

The 3610's ten disc surfaces carry 2.56 million, 16-bit words. This means that you have five times as much storage capacity as that of a single IBM 2310 disc drive, and a ten-times faster access. (The average access time of the 3610 is 50 ms; that of the IBM 2310 on the 1130 system is 520 ms.)

You need not reprogram the 1130 computer when you replace the 2310

disc file with Memorex's 3610 and its built-in controller. The 3610 interfaces directly with the computer on SAC (storage access channel), or with an IBM 1133 multiplexer on SAC II channel.

Memorex Corporation/Equipment Group, San Tomas at Central Expressway, Santa Clara, Cal. 95052. (408) 246-6200.

Circle 222 on Inquiry Card

Wafer handling system

This system for handling and transporting silicon wafers is based on the coordinated use of rectangular TFE and quartz carriers.

Rated to 250°C, the TFE carriers are constructed without any foreign components or adhesives. You can use them for etching, washing, drying and photoresist baking operations. The standard carrier capacity is 25 wafers

and they come with standard spacings of 0.120, 0.125 and 0.1875 in. The matching quartz carriers have the same spacings.

The open construction of the carriers facilitates the flowthrough of processing fluids. Transfer of wafers from one carrier to another or from the TFE to the quartz carriers is a simple operation. The rectangular car-

riers are adaptable for use with currently available equipment for photoresist application and spin drying. According to the manufacturer, the carriers will greatly reduce wafer breakage and scratching. Emerson Plastics Corp., 1383 Seabury Ave., Bronx, N. Y. 10461. (212) 792-4400.

Circle 223 on Inquiry Card

*AUTOMATIC TIMING DEVICE
FOR SYNCHRONIZING
QUICK STARTS ②*

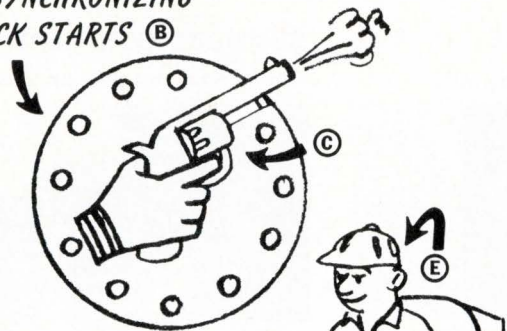

*TANTALUM CHIP
CARRYING TRAYS ①*



TANTALUM CHIP CARRYING TRAY ① MOVES INTO POSITION WHEN AUTOMATIC TIMING DEVICE ② FIRES STARTING GUN ③ AND RUNNER ④ TAKES OFF LIKE A RABBIT. CRANE OPERATOR ⑤ WAKES UP, MOVES DELICATE ARM ⑥, PICKS UP TANTALUM CHIP ⑦ AND DEPOSITS IT, IN PROPER POLARITY, UNTOUCHED BY HUMAN HANDS OR TWEEZERS, IN PRECISE POSITION ON SUBSTRATE ⑧. CRANE OPERATOR ⑤, BECAUSE IT'S SO MUCH FUN, KEEPS MOVING TANTALUM CHIPS UNTIL CHIP CARRYING TRAY ① IS EMPTY, THEN PROMPTLY FALLS ASLEEP. AUTOMATIC TIMING DEVICE ② FIRES STARTING GUN ③ ...AND THIS CAN GO ON FOR HOURS!

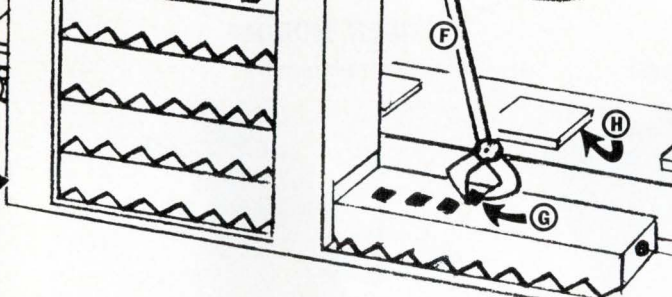

**T411 CHIPS (KEMET® SOLID TANTALUM CAPACITORS FROM UNION CARBIDE)
FOR HYBRID CIRCUIT APPLICATIONS
CAN MAKE YOUR CRAZIEST PRODUCTION DREAMS COME TRUE**

Eliminate hand assembly, improve reliability, save time, and substantially reduce assembly costs! KEMET T411 Series tantalum chip capacitors are specially designed for solder reflow assembly, and they are ideal for your mass market, low cost, consumer type hybrid circuit applications.

They're available in a UNION CARBIDE developed automated dispensing system that can be easily synchronized with your standard pick-and-place equipment. A manually operated automatic placing system is also

available, if you do not require a fully automated system.

Standard capacitance values from 0.1 to 68 μ F (higher values on special order). Voltage range from 4 to 50 V DC. And a UNION CARBIDE developed copper coating process permits assembly temperatures as high as 300°C for a maximum of 3 minutes, continuous operating temperatures to 175°C when derated linearly.

Contact your local UNION CARBIDE representative for complete information...and make your craziest production dreams come true.

Circle 44 on Inquiry Card

COMPONENTS DEPARTMENT

P. O. Box 5928, Greenville, S. C. 29606. Tel: (803) 963-7421 TWX: 810-287-2536



THE DISCOVERY COMPANY



MIL-SPEC POWER SUPPLIES

*with guaranteed
3-day shipment*

In the design of MIL-spec equipment, you want power supplies that meet MIL-specs—and you probably want them in a hurry. Acopian can help on both counts.

Acopian offers over 4,000 AC to DC power modules that meet requirements of MIL-STD-810B, MIL-E-5272C and MIL-I-6181D. You'll find full details in our catalog.

And you can depend on Acopian for quick availability, too. Like all Acopian power supplies, your MIL-spec units will be on their way to you 3 days after receipt of your order. We guarantee it.

Do you have the latest Acopian catalog? To get your copy, write Acopian Corp., Easton, Pa. 18042 or call (215) 258-5441. And remember, every Acopian power module is shipped with this tag...



Circle 45 on Inquiry Card

NEW MICROWORLD PRODUCTS

Ka-BAND SS SOURCE

Min. power output is 10 mW.

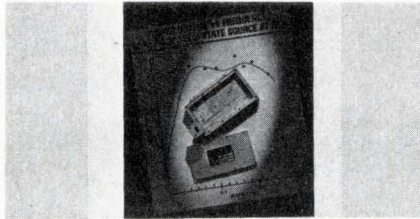

The MIC 100 functions as a signal source, or as a local oscillator with an AFC loop, in the 32 to 33 range. The source has a L-band vco and a two stage power amplifier that drives a x6 and a x4 frequency multiplier chain. Price is \$2400 in 1-9 quantities. Texas Instruments Inc., Box 5012, M/S 16, Dallas, Tex. 75222.

Circle 210 on Inquiry Card

A/D CONVERTER

Converts 10 bits in 30 μ s.



Model 501 has an input signal range of from 0 to +10 V or, with an external trimming resistor, you can make it ± 5 V. The unit is self-contained, including references, clock and all the logic required. \$195 ea. with delivery from stock to 4 weeks. Hybrid Systems Corp., 95 Terrace Hall Ave., Burlington, Mass. 01803

Circle 211 on Inquiry Card

METALLIZED PATTERNS

On 95% alumina substrates.

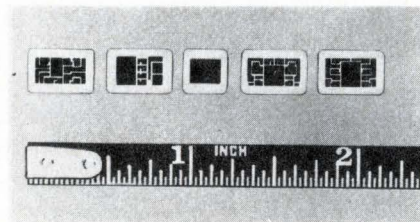

This proprietary process gives you thicker than typical gold deposits for microcircuit applications. The process provides for minimum lines and gaps of 0.010 in. (± 0.002 in.) on runs greater than 0.1 in. long and 0.008 in. (± 0.002 in.) on shorter runs. Centralab Electronics Div., 5757 N. Green Bay Ave., Milwaukee, Wis. 53201. (414) 228-2769.

Circle 212 on Inquiry Card

SUMMING AMPLIFIERS

For special purpose applications.

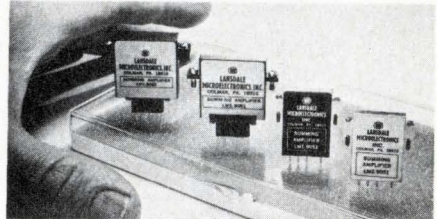

This family of hybrid devices sums the output of vcOs and provides a drive signal to external instrumentation. The units are electrically identical but come in four different mechanical configurations. Prices start at \$166 with delivery in 4 weeks. Lansdale Micro-electronics Inc., Advance Lane and Rte. 309, Colmar, Pa. 18915.

Circle 213 on Inquiry Card

DECODER MODULE

Binary to quaternary.

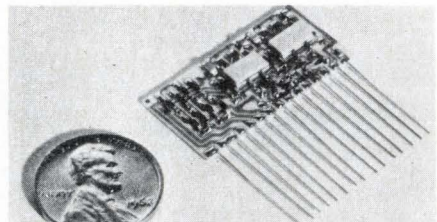

This unit decodes binary logic inputs and gives you OR, AND or exclusive-OR output functions. The module uses the manufacturer's pulse-coupled complementary logic (PCCL), which is similar to diode-transistor logic without the dc coupling. Spacetac Inc., One Garfield Circle, Burlington, Mass. 01803. (617) 272-6161.

Circle 214 on Inquiry Card

TRIPLE OP AMP

On a single monolithic chip.



This circuit, the Model KA-10, operates from dc to 10 kHz and draws 5.4 mW of power at ± 15 V under worse case conditions. Other key features include a maximum voltage gain of 86 dB at ± 15 V, a slew rate of 0.3 V/ μ s and an input range of ± 2 to ± 12 V. Kinetic Technology Inc., 3393 De La Cruz Blvd., Santa Clara, Calif. 95051.

Circle 215 on Inquiry Card

QUAD TWO-INPUT MULTIPLEXER

Operates at high speed.

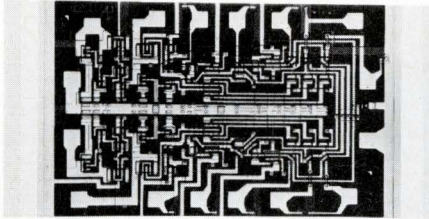

The MSI 9322 consists of four multiplexing circuits with common select and enable logic. Each circuit has two inputs and one, fully buffered output. Typical switching speed is 20 ns. \$15.80 ea. (military) and \$7.90 (industrial) for 1-24 pcs. Fairchild Semiconductor, 313 Fairchild Dr., Mountain View, Calif. 94040.

Circle 216 on Inquiry Card

PHOTO SENSOR

For visible and near-IR.

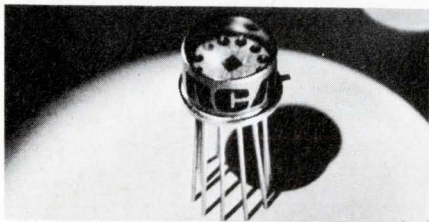

This monolithic circuit, the CA3062, combines a photo detector and a power amplifier to give you a complete photo switch. It is packaged in a fully hermetic, 12-lead TO-5 package and costs \$2.95 ea. in lots of 1000. RCA/Electronic Components, Commercial Engineering Dept., 415 S. Fifth St., Harrison, N.J. 07029.

Circle 217 on Inquiry Card

GAUSSIAN CRYSTAL FILTER

Monolithic unit is in a TO-8 can.



Model 6354MB is a 3-pole filter with a center frequency of 10.7 MHz (± 0.25 kHz), a -3 dB bandwidth of 2.5 ± 0.25 kHz, and a -40 dB BW of 17.5 kHz max. Insertion loss is 4 dB max. and the unit has a source impedance of 500 Ω resistive and a load imp. of 2 k Ω resistive. Electronics Div., Damon Corp., 115 Fourth Ave., Needham Heights, Mass. 02194.

Circle 218 on Inquiry Card

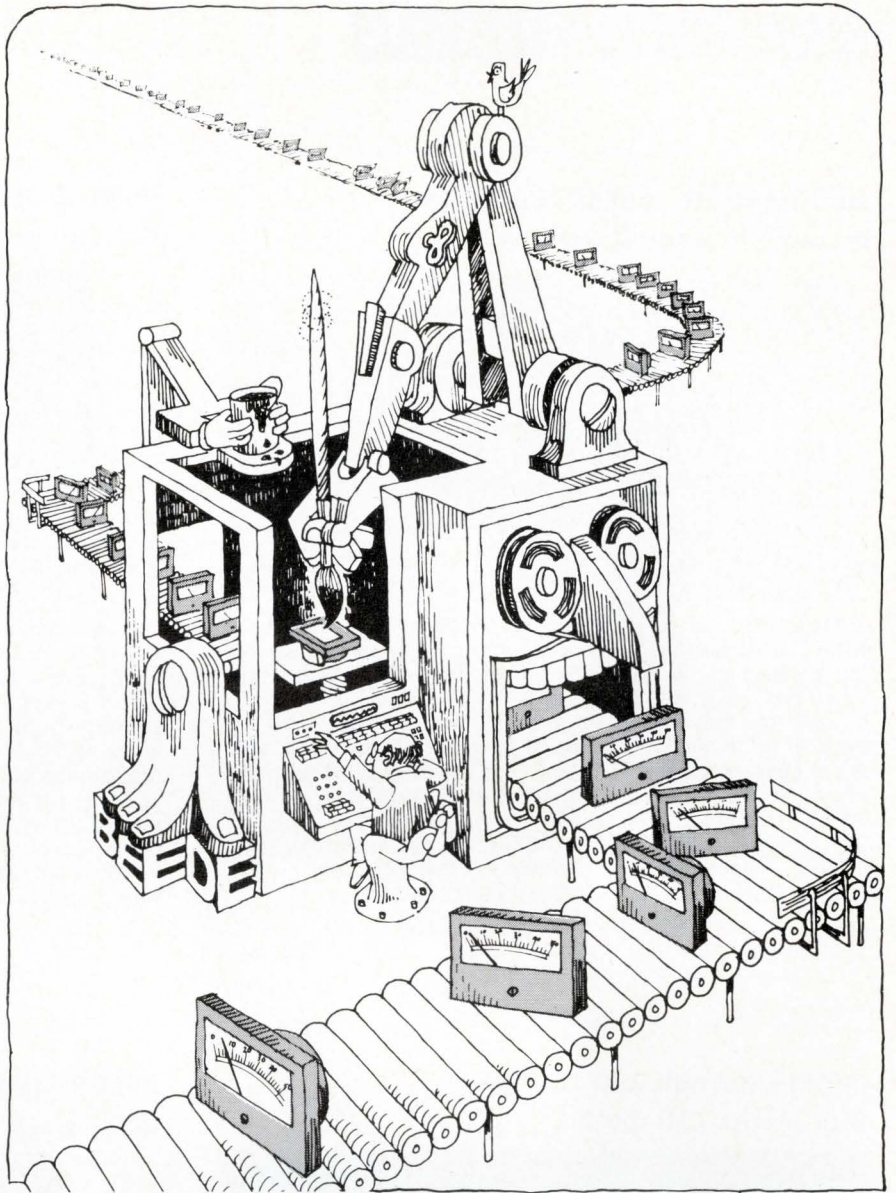

COMPUTER DRAWN DIALS FOR TRUE* 1/2% METERS

Using automatic equipment to individually draw the dials for each 1/2% meter provides our customers the highest accuracy for the most reasonable cost!

* Beede draws each division on the dial to fit the specific meter, as opposed to less accurate methods such as selecting scales or manipulating the magnetic circuit.

BEEDE

INDIVIDUALLY CALIBRATED METERS

Penacook, N.H. 03301
(603) 753-6362

NEW MICROWORLD PRODUCTS

MOS RANDOM ACCESS MEMORY

Features 400 ns typical access time.

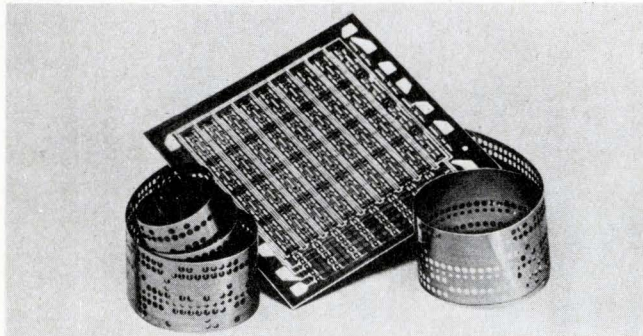

Organized as sixteen words of four bits each, the MC1170L uses 4-input binary addressing with full decoding performed on the chip. An enable input is also provided for easy address expansion. The read/write buffer circuits on the output bit lines allow as many as 20 bit lines to be wire-ORed. Power dissipation is about 325 mW when operating from -30 and -15 V sources. The memory comes in a 14-pin ceramic DIP for operation from 0 to 75°C . Available immediately from stock, the price is \$13.70 ea. in 100 to 999 quantities. Technical Information Center, Motorola Semiconductor Products Inc., Box 20924, Phoenix, Ariz. 85036. (602) 273-5567.

Circle 224 on Inquiry Card

BIPOLAR 256-BIT ROM

Organized into 32, 8-bit words.

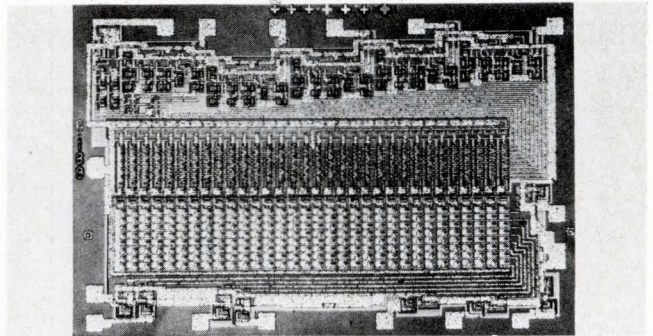

A five input address code allows random selection of any of the 32 words stored in this unit, the SM320. Also included is a chip enable line that allows you to select individual packages when the outputs are wire-ORed. The ROM operates from a nominal power supply of 5 V and typical access time is in the 30 ns range. Applications include micro-programming, character generation, table look-up, code conversion, parity generation and indicator lamp decoding. It is available in a 16-lead DIP and is rated for operation over the industrial temperature range of 0 to 75°C . Sylvania Electric Products Inc., 1100 Main St., Buffalo, N.Y. 14209.

Circle 226 on Inquiry Card

CHOPPER-STABILIZED OP AMP

With inherent EMI shielding.

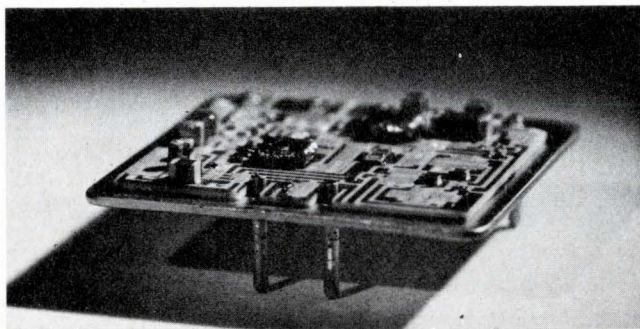

Model 1412 combines a unique electronic chopper circuit with the latest microcircuit construction. It's in a $1.125 \times 1.125 \times 0.2$ in hermetically sealed package and has internal frequency compensation and power supply bypassing. Internal protection also guards the inputs against over-voltage and the output against short circuits to ground. Among the specs you'll find min. output is 5 mA at ± 12 V, offset voltage is $\pm 25 \mu\text{A}$ (max) and voltage and current drift are $\pm 0.25 \mu\text{V}/^{\circ}\text{C}$ and $\pm 2 \text{ pA}/^{\circ}\text{C}$ (typ). In addition, you can operate it over a power supply range of ± 8 to ± 20 V. Price is \$125 ea. in 1-9 quantities. Small quantity delivery is from stock. Teledyne Philbrick Nexus, Allied Dr. at Rte. 128, Dedham, Mass. 02026.

Circle 225 on Inquiry Card

PROGRAMMABLE RANDOM LOGIC ARRAYS

Combine MOS and bipolar technologies.

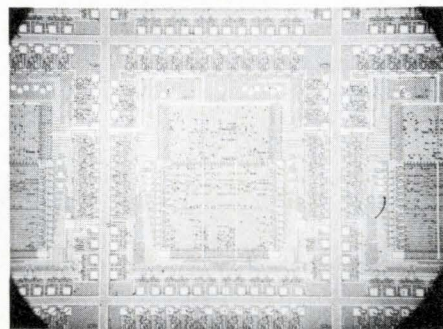

These two units, the TMX-2000JC and the TMX-2200JC, are the first in a series of arrays. Both devices offer a complexity of 130 gates and are TTL/DTL compatible. The TMX-2000JC combines 17 inputs and 8 flip-flop outputs into 60 product terms. These terms are then combined into 16 lines for inputs into 8 JK, master-slave flip-flops, and into 18 external outputs. One clock and common reset input control flip-flop operation. Output buffers are NPN bipolar transistors for direct interfacing. The TMX-2200JC gives you 72 product terms and 10 JK flip-flop outputs; it offers 13 inputs and 10 outputs. Texas Instruments Inc., Inquiry Answering Service, Box 5012, M/S 308, Dallas, Texas. 75222. (214) 238-3741.

Circle 227 on Inquiry Card

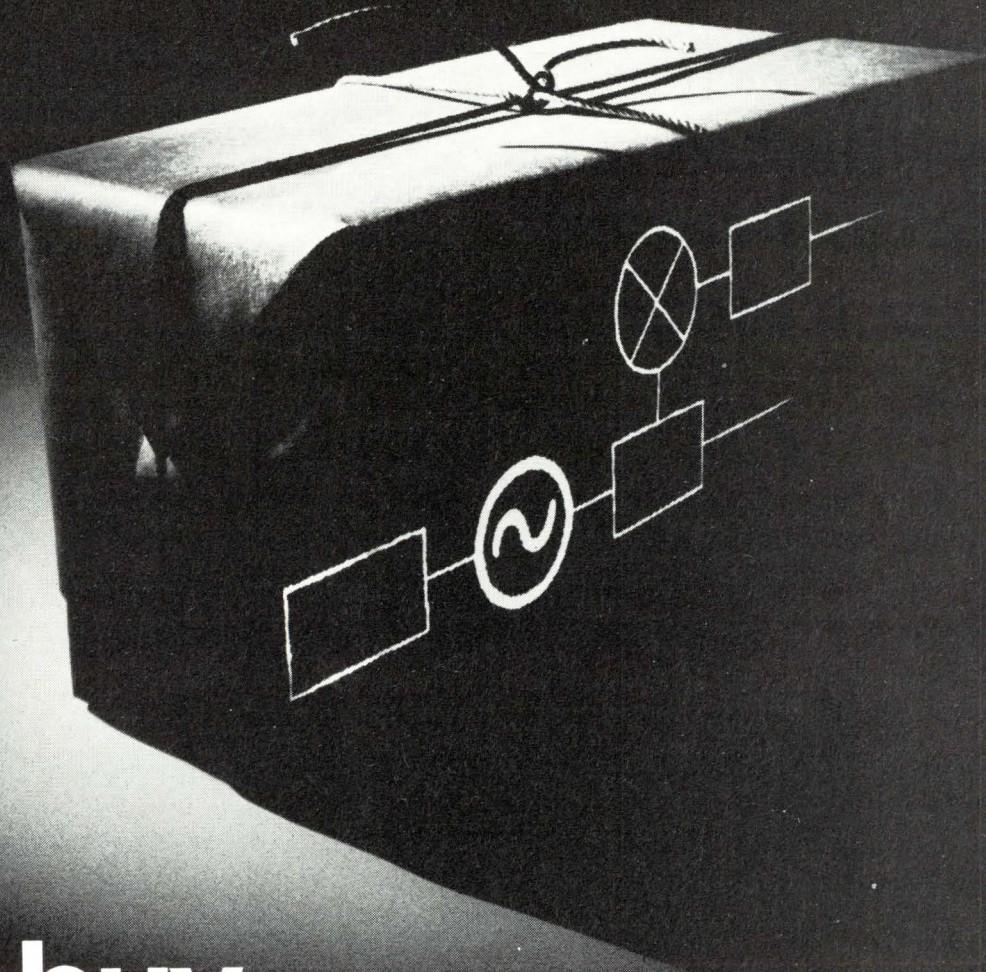

Why buy just an oscillator when you really need the works?

If you're in the market for a solid-state oscillator, you probably know by now Varian's the company to see, with a line of fixed frequency and electronically tunable Impatt and Gunn-Effect oscillators second to none in the industry.

But why stop with just the oscillator?

Varian can package a pre-engineered, fully interfaced subsystem that includes not only your oscillator, but practically everything from power supply to waveguide.

No other company can match our line of stabilizing cavities, power supplies, up-converters, mixers, preamps, IF and RF amplifiers, discriminators, levelers, circulators, limiters, TR tubes, switches . . . and so on and on.

And no other company has the wealth of engineering talent and production know-how to put together a package that saves you so many hours and dollars.

So get what your system really needs from the company that puts it all together. Varian. At more than 30 Solid State Sales Offices around the world, or at our Solid State Division, Salem Road, Beverly, Massachusetts 01915. Phone (617) 922-6000. Other facilities at Copiague, L.I., New York and Palo Alto, California.



varian
solid state division

Computerized Design For Better Printed Circuit Boards

Here's how to reduce both cost and lead time in converting a circuit design to production-ready printed circuit board artwork. At Electronic Graphics, Inc., we call it our photomask service. Using a computerized system we design single-, double- and multi-layer printed circuit board layouts and provide supporting engineering and assembly documentation. With this system we provide for you in one to four weeks photo masters and documentation that require as much as six months to produce using conventional manual layout techniques.

Electronic Graphics' photomask service utilizes a highly sophisticated software program which our engineers and programmers have developed. Operating through our IBM 360-44 computer, this program provides the logic required to design well-ordered PC layouts. The output of this computer system is input to a Seaco 1500A CRT artwork generator to create the photomask master negative. From this negative we process your photo master. It can be either negative or positive on either film or glass.

In addition to the latest computer and artwork generator systems, facilities at the Garland plant include: An auto-trol digitizer, extensive photo lab facilities, and precision microscope inspection equipment.

The photomask service gives you more than just automated artwork. It's a turnkey service that includes the following:

1. Computerized design of the printed circuit board layout. Placement of components and interconnection routing is in full compliance with your engineering specifications (e.g. component location, test points, circuit paths, etc.).
2. Automated translation of the computerized layout design into precision production photo masters by an electronic graphic generator. The final verified photomask is accurate to $\pm .001''$ point to point, with repeatability of $\pm .0005''$. (Accuracy of this magnitude results in higher yields on production runs of your circuit board.)
3. Engineering documentation consisting of a bill of material list, a point-to-point wire list, a component location list, and a drill plan showing hole locations.
4. Assembly drawings showing component location and orientation.
5. Production-ready numerical control tapes for any drill, router, or component insertion machine. (Available on request.)
6. An optional customer file storage service which facilitates rapid engineering changes and duplication of photo masters or documentation.

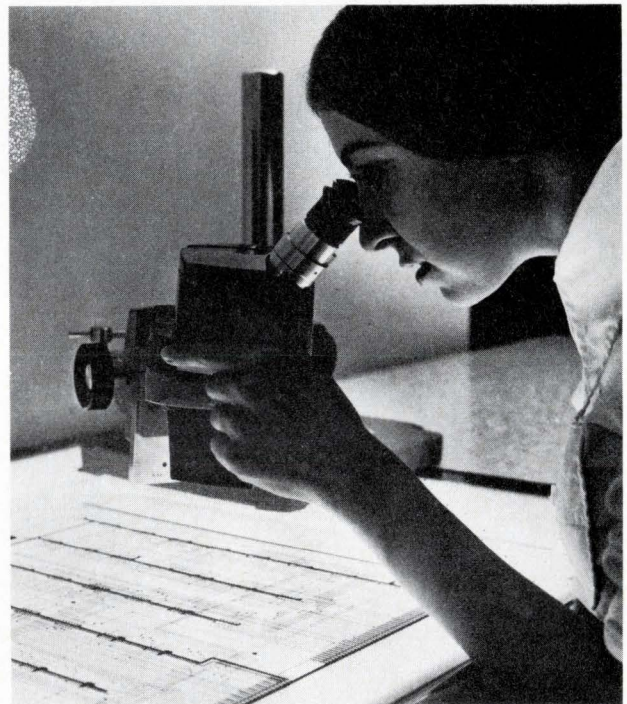

Investigate our service, facilities, and capabilities and you will find that Electronic Graphics, Inc. can do a better job of producing precision photo masters, deliver them faster, and provide you with measurable savings in both time and money.



electronic graphics, inc.

2834 W. Kingsley Road • Garland, Texas



A special report

TIME SHARING

How to select a time-sharing service
Available time-sharing services

How to select a time-sharing service

There are many time-sharing systems, offering diverse capabilities, only a phone call away. Here's help in selecting the proper one.

By Alan G. Hammersmith,

Time-Sharing Enterprises, King of Prussia, Pa.

"Which service should I select?", ask new users without time-sharing experience. "Am I using the right service for my application?", wonders the experienced user. The points and suggestions we make in this article may not contain all the answers to these questions, but will help you evaluate and select a time-sharing service.

A user's market

A vendors' market until a few years ago, time-sharing is now definitely a users' market thanks to the many new services that have come into the field, which offer a wider choice of systems and capabilities.

Time-sharing services cannot be compared directly on the basis of cost alone. Some systems may appear to be more expensive than others, but the additional capabilities they offer may greatly simplify the design and programming of your application, therefore reducing your total job cost. On the other hand, if a service is expensive because it has power and special features that you

Mr. Hammersmith is President of Time-Sharing Enterprises, King of Prussia, Pa. His company publishes the Time-Sharing Industry Directory and the Time-Sharing Applications Directory.

don't need, it's wasteful to buy them.

Following is a list of the reasons why it is misleading to judge systems solely on cost:

Response times: different systems provide different response times. While waiting for the computer to answer his call, the programmer sits idle at the terminal, and you may be paying a connection cost. This "terminal thumb-twiddling time" can be very annoying to the programmer, and may cost you more than the vendor's connect charge.

System loading: as a new system gets more users, the connect time gets longer because the increased number of users—especially sophisticated ones—load the system. Assuming your vendor ordered a new machine to take care of the new load, the "sluggishness" will last until he receives it.

CPU charge for swapping: some services charge their users central processor (CPU) time to swap them in and out of core. This practice is more common among those systems that do not have a high-speed disc (or drum). In some cases, the user can be paying up to 5 or 6 seconds of CPU time for each second his program actually uses. As the system load increases, it requires more swaps, therefore costing the user more to run a program at one time than to run the same program at another time when the load is lighter.

Telephone line charges: try to use a service that has local (or IN-WATS) lines available. Long distance phone calls to a computer can become expensive—especially if the response time is long.

Terminal costs: make sure your vendor allows Teletypes in their systems. These terminals (especially the Model 33) are probably the cheapest general purpose terminals available today.

Try time-sharing first

Both of these terms, time-sharing and batch, are defined elsewhere in this article. While there are no easy rules to assist you in this article. While there are no easy guidelines to decide which one to use:

- If you suspect that time-sharing may have a place in your company, the best thing to do is to try it for awhile.
- If you have never used computers before, try a time-sharing system first.

There is probably someone within your company that has used time-sharing or remote batch—consult him for advice. Or, you can call on an independent consultant to assist you in evaluating your need for such a service and the right vendor for it. You can also call one of the vendors in your area for a demonstration.

What to do

First, identify all the available services within your geographical area, for both time-sharing and remote batch systems. If there are only one or two services in your area, your task will be relatively simple. If, on the other hand, you are in a major metropolitan area, there may be many more services from which to select. In this case, it would be cheaper to call in an independent consultant to assist you in the evaluation. The consultant must be familiar with all of the systems, rather than just be a casual user.

If you select the service, follow these steps:

- Separate the available services into **time-sharing** and **remote batch**. Decide which type suits your needs. Call in a vendor from each type to assist you in the selection.

- The next step is to select a **computer** that best suits your needs. List all the services that use that computer, then select the best one. Again, you may have to call in a few vendors to decide which computer is best for you.

- Next, compare the relative **costs** of those vendors who have that computer. Even though such a comparison is not easy, it will be greatly simplified because you are now selecting from only a few services. When talking to vendors about costs, ask them if there are "other" costs, not obvious from their data sheets.

What to avoid

There are three things to beware of when selecting a system:



... avoid the 'terminal thumb-twiddling time' ...

Benchmarks—sample programs that test a system—can give you an idea about the cost of a particular system, but can also be very misleading. An experienced salesman can prove almost anything he wants to with a benchmark. For example, both turnaround time and cost depend on the number of people using a system at a given time, and on what they were doing when your program was executed.

Unique features, such as special programming languages, are favorite selling points. You may find, however, that they may lock you in with one vendor. If you decide later to change services, your programming conversion costs may be very expensive because of those "unique features" that you were told would save you money.

Library and applications packages are the wrong reason to select a service. When you will try to use them, you may find them not general enough to solve your particular problem. It is oftener easier to write your own package than to figure out the documentation on the service's package.

What to expect . . .

. . . and what not to expect from your time-sharing service.

Time sharing and remote batch

A **time-sharing system** functions as follows: If a user runs a program that requires 2 minutes of central processor time, the time-sharing or time-slicing system will allocate small portions of the processor to run the job. After each time slice or "shot" at the processor, it swaps the program out of core and into a drum or disc or may leave it in unused portions of core. The amount of processor time allocated for each "shot" varies anywhere from a fraction of a second to 1 or more seconds. For example, if a computer system allows 1 full second of central processor time per slice, the user's 2-minute program would be divided into 120 shots at the processor.

A time-sharing system, therefore, allows the user a high degree of interaction with the computer. While he is connected to the system, he can create and change files and programs and can interrupt and restart executions. Some systems even allow sophisticated debugging, whereby a user can stop the execution of the program and examine the contents of counters to trace his program step by step.

Some computers for time-sharing applications are B-5500, CDC 3300, CDC 3600, PDP-10,

Time-Share 8, GE-265, GE-400's, GE-635, HP-2000, H-1648, Spectra 70/46, XDS 940, Sigma 7, 360/50, and 360/67.

A **remote batch system** operates in one of two different ways.

- Uninterrupted run to completion. A job enters the system and the processor runs it until completed, without operating on any other jobs.

- Interrupted run to completion. The job enters core and the system allocates fixed or variable blocks of time for it. For example, there may be three jobs in core. The processor would work on them then until one job was completed. Another job would then enter the system.

Remote batch is becoming more and more popular, mostly for large production runs where program interaction and fast response time are not necessary. Also, where high-speed telephone lines are available, the user can install a high speed printer at his location.

Some computers for remote batch applications are CDC 6600, GE-635, 360/65, Spectra 70/46, U-1108 and Sigma 7.

A **free trial period**—one to two weeks of free computer time—depending on the potential amount of time-sharing your company can use. Most vendors will lend you a portable Teletype during this period. You will, however, pay the phone bill.

Training for one person in your location, and programming classes your vendor may offer at his location.

Periodic assistance, when unusual problems arise, plus **additional training** to learn new features your vendor may add to his system.

Updating. The vendor should notify you as soon as he updates and introduces changes to his system. Always ask what kind of a system will he use to keep you informed.

Downtime. It happens to every computer, and may not exceed 1 or 2 minutes. Sometimes, however, a service may be out for 1 or 2 hours.

Loss of files. During certain types of "crashes," your programs and data files can be lost, either temporarily or permanently. Your vendor should recover them, at his expense, but with your help.

Credit for lost time. It may be credited against your bill, or allowed as an equivalent amount of free time.

Help in programming. Your vendor will not write your programs. If he has that capability, he may charge you for it.

Should you change services?

Although changing vendors is not an easy task, and can be quite expensive, you should periodically evaluate the many new services and systems that come into the field. Many of them offer attractive CPU and connect rates, and, particularly, low storage charges. If you find some new vendors' services and costs attractive, consider the following factors before changing.

Conversion of programs from one system to another.

Retraining, particularly if many people use time-sharing within your organization.

Loading. The new system may be lightly loaded, and you may be impressed by its quick response. You can expect it to worsen as it gets more customers.

Availability of telephone lines.

Control characters, which allow editing of programs. They save time to experienced programmers.

In-house system. If your company is a large user of time-sharing, the new system to consider may be in-house, rather than another outside system.

INFORMATION RETRIEVAL
Computer and peripherals, Data
acquisition and processing

Available time-sharing services

The line-up: a rundown of computer time-sharing services plus available languages and programs.

Since time sharing represents a contemporary, growing interest of the electronic engineer, the following time-sharing services chart has been compiled for our readers. Those services selected for a position in the chart offer programs or capabilities representing the needs of an electronic engineer. Selection for placement on the chart was based on the following criteria:

- A company was selected if its capabilities reached 5,000 or more of our readers.
- The company must offer engineering languages, either FORTRAN IV or BASIC, or both.
- The company must offer special electronic programs such as ECAP, SCEPTRE, CIRCUS, or programs for filters, microwaves or logic design.

Within this list it was not possible to mention all of the types of terminals each service offers, so attention was limited to the generic types of terminals that are useful to electronic engineers—teletype, plotters and graphic CRT displays. Where teletype is mentioned it is likely that the service offers a more sophisticated terminal such as the IBM 2741.

The following map illustrates the geographical distribution used in the chart. You will note that when a state is abbreviated in caps, toll-free calls are free for the entire state. If you'd like more information on any of the included services, just circle the reader service number located in the lower right-hand corner.

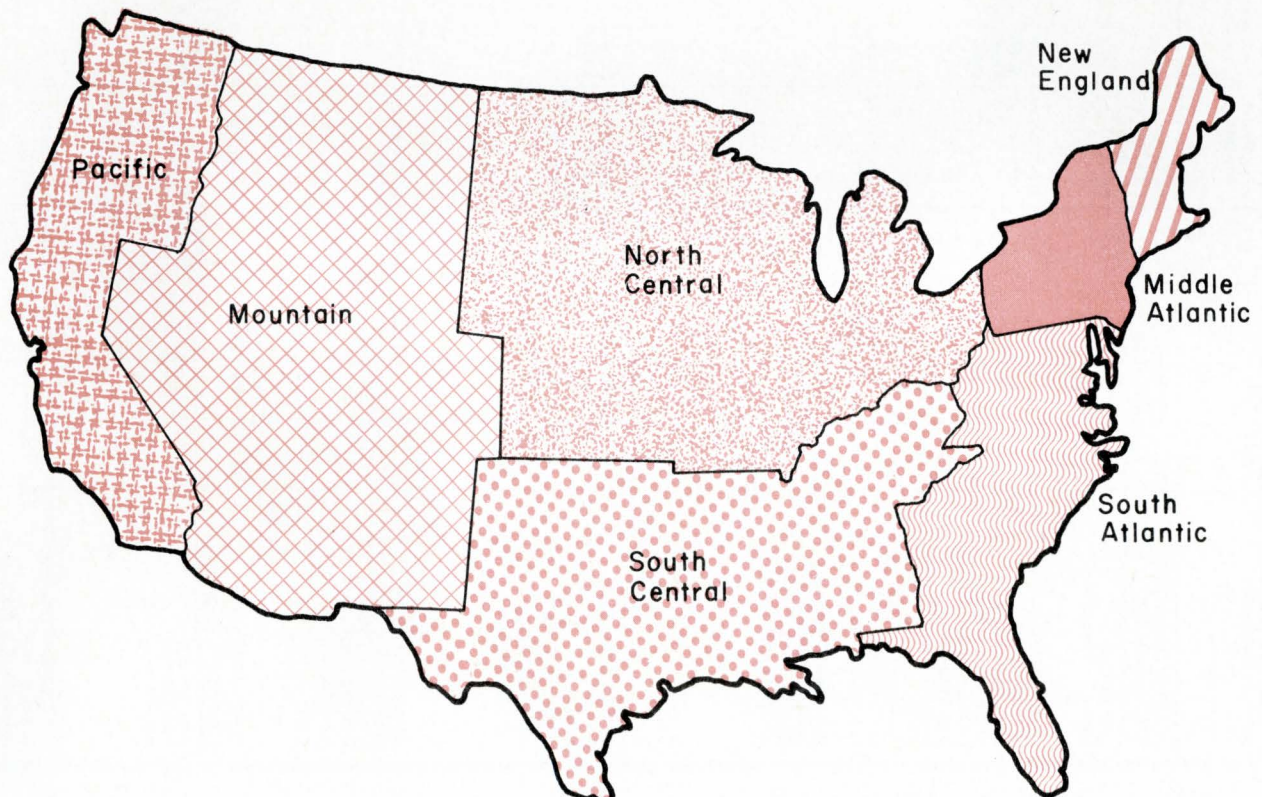

Time sharing services (cont'd)

Computing services*	PRICES				SERVICES		HARDWARE		TOLL-FREE CALLS							
	names and addresses and Inquiry card No. . . .	Initial	Min.	Connection charge	CPU	Engineering languages	Electronic programs	Computers and size of available core	Engineering terminals	Pacific States	Mountain States	North Central	South Central	New England	Middle Atlantic	South Atlantic
ACADEMY COMPUTING CORP. 5005 N. Lincoln Blvd. Oklahoma City, Okla. 73105 (405) 528-2861 Edward J. Hardebeck, Pres. 335	\$50	\$100/ mo.	\$7 to \$10/mo.	\$0.02 to \$0.09/ sec.	BASIC FORTRAN IV Ext. BASIC BASIC III		GE-255 GE-420 GE-430	TTY	CALIF.	Phoenix, Ariz.	KANS. MO.	TEX. OKLA. LA. ARK. MISS.			Washington, D.C.	
ALLEN-BABCOCK COMPUTING, INC. Century City, Gateway E 1800 Ave. of the Stars Los Angeles, Calif. 90067 (213) 277-1600 James D. Babcock, Chairman 336				\$8.25 to \$21.50/ min.	FORTRAN IV PL-1	ECAP NASAP Filter design	IBM 360/50 128 k (32-bit word)	TTY CRT Plotter IBM 2741	WASH. ORE. L.A., Calif. San Diego, Calif.	NEV. UTAH ARIZ. N.M.	Chicago, Ill. MINN. IOWA MICH. MO. IND. OHIO	KY. TENN. Houston, Tex.	VT. R.I. MASS. CONN. N.H.	N.Y. PA. N.J.	VA. W. VA. DEL. MD. Atlanta, Ga.	
APPLIED COMPUTER TIME-SHARE INC. (ACTS) 18304 James Couzens Hwy. Detroit, Mich. 48235 (313) 345-7700 Harold Van Amem, Pres. 337			\$5 to \$10/hr.	\$0.04 to \$0.15/ sec.	FORTRAN IV BASIC	Network analysis	GE 265 GE 435 IBM 360/67 16 k words (20-bit word) 64 k words (24-bit word) 512 bytes (8-bit word)	TTY Plotter			Detroit, Mich. Southfield, Mich. Jenison, Mich. Toledo, Ohio Dayton, Ohio Cincinnati, Ohio Indianpls., Ind.	Louisville, Ky.		New York, N.Y.		
APPLIED LOGIC CORP. (AI/Com) Box 124 Princeton, N.J. 08540 (609) 924-7800 Richard M. Colgate, Chmn. of the Board 338	none	\$100/ mo	\$10/hr.	\$0.10/ core unit	FORTRAN IV BASIC AID LIST 1.6	ECAP NASAP	Dual AL-10 32 k words (32-bit word)	IBM 2741 Datel TTY CRT Plotters (CalComp) Dura	S.F., Calif. L.A., Calif. San Jose, Calif.		Chicago, Ill.		Boston, Mass.	Princeton, N.J. Pennsauken, N.J. Buffalo, N.Y. New York, N.Y. Pittsburgh, Pa. E. Orange, N.J.	Washington, D.C.	
AXION SYSTEMS INC. 615 Winters Ave. Paramus, N.J. 07652 (201) 262-8200 Richard Wilson, Pres. 339			\$10/hr.	\$1000/ hr.	FORTRAN IV BASIC	ECAP	U-1108 70 k words (36-bit word)	TTY CRT						Great Neck, N.Y. New York, N.Y. Paramus, N.J. Princeton, N.J.	Washington, D.C.	
BASIC TIMESHARING 415 Clyde Ave. Mountain View, Calif. 94040 (415) 969-1900 (408) 738-0330 Paul H. Schmidt, V.P. 340	none	none	\$5/hr.	\$500 to \$700/ mo.	Ext. BASIC	Complex numb. On-line instr. monitor Simulation	H-P 2000A 15 k char.	TTY Plotter (HP 7200) Datapoint 3300 Data acquisition On-line control	S.F., Calif.							
BOLT, BERANEK AND NEWMAN 50 Moulton St. Cambridge, Mass. 02138 (617) 491-1850 Samuel Labate, Pres. 341			\$12 to \$18/hr.	\$0.20/ sec. to \$3.50/ min.	FORTRAN IV BASIC	Plotting	PDP 7/8 PDP 10 XDS 940 32 k	TTY						Cambridge, Mass.	E. Orange, N.J. New York, N.Y.	Arlington, Va.

<p>CALL-A-COMPUTER Div. of Pillsbury Occidental Co. 1500 S. Lilac Dr. Minneapolis, Minn. 55416 (612)330-4096 Jim Gerber, Mgr. of Applications</p> <p>342</p>			\$4.50 to \$9/hr.	\$0.02 to \$0.03/sec.	BASIC FORTRAN II		GE-265 6 k	TTY CRT	L.A., Calif.	Phoenix, Ariz.	Chicago, Ill. Minneapolis, Minn. Indianapolis, Ind. Cincinnati, Ohio	Louisville, Ky. Birmingham, Ala.	Boston, Mass. Providence, R.I.	New York, N.Y.	Richmond, Va. Washington, D.C. Atlanta, Ga. Raleigh, N.C.	
<p>C-E-I-R 5272 River Rd. Washington, D.C. 20016 (301) 652-2268 Mr. Robert Burgess, Dir.</p> <p>343</p>	none	\$100/mo.	\$8/hr. to \$10/hr.	\$1 to \$2/min.	BASIC Ext. BASIC FORTRAN IV		GE-265 GE-420 CDC-3300 10 k words	TTY						New York, N.Y. Philadelphia, Pa.	Washington, D.C.	
<p>CODON COMPUTER UTILITIES 400 Totten Pond Rd. Waltham, Mass. 02154 (617) 891-1700 Bernell K. Stone, Pres.</p> <p>344</p>	\$100		\$9/hr.	\$0.01/sec.	FORTTRAN IV BASIC		PDP-10 50 k	TTY CRT					Boston, Mass.	New York, N.Y.		
<p>COMPUTER COMPLEX, INC. 6400 Southwest Fwy. Suite 150 Houston, Tex. 77036 (713) 785-3100 Robert W. Westerhouse, Pres.</p> <p>345</p>	none	none	\$15 to \$30/hr.	none	BASIC FORTRAN IV XTRAN CAL	Coded-CAP ECAP Filters Bode plots S-plane Complex poles Roots CIRC-DC Wiring	XDS-940 64 k words	TTY CRT Plotter (CalComp, Houston Inst.) Typagraph	L.A., Calif. Orange Co., Calif. Palo Alto, Calif. Oakland, Calif.	Denver, Colo.	St. Louis, Mo. Chicago, Ill.	Houston, Tex. Dallas, Tex. San Antonio, Tex. Tulsa, Okla. New Orleans, La. Baton Rouge, La. Lafayette, La.		New York, N.Y.	Tampa, Fla. Orlando, Fla. Melbourne, Fla.	
<p>COMPUTER INNOVATIONS 10225 S. Western Ave. Chicago, Ill. 60643 (312) 445-0626 Joseph Mill, Pres.</p> <p>346</p>	\$100	none	\$15/hr.	none	APL	ECAP (Conversational) Matrix Complex func. Nonlinear Logic design Fourier trans. Dig. filters	IBM 360/50	Plotter IBM 2741 Datel DURA BM 1050	L.A., Calif.		Chicago, Ill.					
<p>COMPUTER RESPONSE CORP. 1100 17th St., N.W. Washington, D.C. 20036 (202) 659-4630 Robert S. Wiggims, Pres.</p> <p>347</p>			\$10/hr.	\$0.20 to \$0.40/sec.	FORTTRAN V BASIC		Univac 1108 135 k words	TTY IBM 1130					Knoxville, Tenn.	Boston, Mass.	New York, N.Y. Philadelphia, Pa. Pittsburgh, Pa.	Washington, D.C.
<p>COMPUTER SOFTWARE SYSTEMS INC. 460 Summer St. Stamford, Conn. 06901 (203) 327-9100 Robert H. Bernard, Pres.</p> <p>348</p>			\$6/hr.	\$0.38/sec.	FORTTRAN IV BASIC		IBM 360/67 100 k words (8-bit word)	TTY Plotter	S.F., Calif. L.A., Calif.		Cincinnati, Ohio			Boston, Mass. Stamford, Conn.	New York, N.Y.	

Time sharing services (cont'd)

Computing services'	PRICES			SERVICES			HARDWARE		TOLL-FREE CALLS								
	Initial	Min.	Conne- tion charge	CPU	Engineering languages	Electronic programs	Computers and size of available core	Engineering terminals	Pacific States	Mountain States	North Central	South Central	New England	Middle Atlantic	South Atlantic		
names and addresses and Inquiry card No. . . .																	
COMP/UTILITY, INC. 84 State St. Boston, Mass. 02109 (617) 523-2113 J. R. Burley, V.P. Mktg.	349	none	\$5.00 to \$9.00/hr	\$0.03 plus \$0.01/ sec.	FORTRAN IV BASIC	EZ/CAP Filter anal.	PDP-10 64 k words (36-bit word) 96 k words (36-bit word)	TTY Plotter Interactive graphic plot Compu- circuit				Houston, Texas	Boston, Mass.	Philadelphia, Pa. New York, N.Y.	Washington, D.C.		
COM-SHARE, INC. 2395 Huron Pkwy. Ann Arbor, Mich. 48105 (313) 761-4040 Robert F. Guise, Pres.	350	0 to \$400/ mo.	\$16/ hr.	\$0.03/ sec.	BASIC FORTRAN Ext. FORTRAN IV Ext. BASIC	Coded-CAP Non-linear	XDS-940 64 k words (24-bit word)	TTY Plotter (CalComp, Houston Inst.) CRT	S.F.,Calif. L.A.,Calif.		Chicago, Ill. Minneap., Minn. St. Louis, Mo. Ann Arbor, Mich. Cincinn., Ohio Columbus, Ohio Cleveland, Ohio Detroit, Mich.		Boston, Mass.	New York, N.Y. Williamsville, N.Y. Pittsburgh, Pa. Philadelphia, Pa.	Washington, D.C.		
CONTROL DATA CORP. Data Services Div. 4550 W. 77th St. Minneapolis, Minn. 55435 (612) 920-8600 Robert O. Young, Dir. of Mktg.	351			\$180 to \$1200/ hr.	FORTRAN IV		CDC 6600 CDC 3300 131 k (60-bit word)		Seattle, Wash. S.F.,Calif. L.A.,Calif.	Phoenix, Ariz.	Omaha, Nebr. Minneap., Minn. Detroit, Mich. Cincinn., Ohio Cleveland, Ohio Chicago, Ill.	Huntsville, Ala. Houston, Tex. Dallas, Tex.	Boston, Mass. Hartford, Conn.	New York, N.Y. Melville, N.Y. Philadelphia, Pa.	Washington, D.C. Atlanta, Ga.		
CYPHERNETICS CORP. 333 Maple Village Ctr. Ann Arbor, Mich. (313) 769-6800 Kenneth M. Lochner, Jr., Exec. VP	352	\$100	none	\$10/hr.	\$0.02/ sec. per 1 k words	FORTRAN IV Ext. BASIC	ECAP Schematics Plot generator	PDP-10 32 k	TTY Plotter (CalComp) CRTs						Pittsburgh, Pa.		
DATA NETWORK CORP. One Bala Ave. Bldg. Bala Cynwyd, Pa. 19004 (215) 667-1700 John G. Scarry, Exec. VP	353	\$100		\$10/hr	\$2.50/ min.	BASIC FORTRAN IV CAL PL-1	ECAP CIRC AC/DC Matrix Plotting	XDS-940 64 k words (24-bit word) IBM 360/67 512 k bytes	TTY CRT Plotter (CalComp)	L.A.,Calif.			MICH. OHIO IND. ILL.	KY. TENN. TEX.	ME. N.H. VT. MASS. CONN. R.I.	New York, N.Y. PA. N.J.	DEL. MD. Wash., D.C. VA. W. VA. N.C. S.C. GA.

<p>DIAL-DATA, INC. 1001 Watertown St. West Newton, Mass. 02165 (617)-969-1800 Lewis C. Clapp, Pres.</p> <p>354</p>			\$12/hr.	\$3/min.	Ext. BASIC FORTRAN	<p>Coded-CAP Analog simulator LaPlace trans. invert FOURIER STATISTICAL MICAP (micro-wave) FILSYN (filters) DIGILOG (logic circuit analysis)</p>	XDS-940 64 k words (24-bit word)	TTY Plotter (CalComp) CRT							<p>Boston, Mass. Hartford, Conn.</p> <p>New York, N.Y.</p> <p>Washington, D.C.</p>
<p>EDP CENTRAL, INC. 1006 S.E. Grand Ave. Portland, Ore. 97214 (503) 233-7661 J. C. Brotherton, Pres.</p> <p>355</p>			\$2	\$4/min.	FORTRAN IV BASIC	ECAP	<p>IBM 360/50 IBM 360/65 64 k bytes</p>	TTY Plotter	<p>Seattle, Wash. Portland, Ore. S.F., Calif. L.A., Calif.</p>	<p>Denver, Colo.</p>					
<p>FULTON NATIONAL BANK 55 Marietta St. Atlanta, Ga. 30303 (404) 577-3500 Michael B. Martin, Asst.</p> <p>356</p>	\$100		\$7/hr.	\$0.03/unit	BASIC FORTRAN IV		<p>GE-430 32 k words</p>	TTY				<p>LA. MISS. ALA. TENN. KY.</p>			<p>FLA. GA. S.C. N.C.</p>
<p>GENERAL ELECTRIC CO. Information Serv. Dept. 7735 Old Georgetown Rd. Bethesda, Md. 20014 (301) 654-9360 Paul R. Leadley, Dept. Gen'l Mgr.</p> <p>357</p>	\$10	\$10/mo.	\$7.50 to \$11/hr.	\$0.30/sec.	BASIC FORTRAN IV	<p>LOGIC (digital simulation) NLNET (non-linear) ACNET-DCNET ECAP ANALG (analog computer simul.) TRANS (inversion of La Place transform)</p>	<p>GE-265 GE-635 GE-605 16 k words (20-bit word)</p>	TTY Plotter (CalComp)	<p>WASH. ORE. CALIF.</p>	<p>MONT. IDAHO Salt Lake City, Utah Phoenix, Ariz. Denver, Colo. Albuquerque, N.M.</p>	<p>MINN. IOWA MO. KANS. WIS. ILL. MICH. IND. OHIO Omaha, Nebr.</p>	<p>OKLA. TEX. ARK. LA. KY. TENN. MISS. CONN.</p>	<p>N.Y. N.J. PA.</p>	<p>W. VA. VA. Washington, D.C. N.C. S.C. GA. FLA. MD. DEL.</p>	
<p>GRAPHIC CONTROLS CORP. 189 Van Rensselaer St. Buffalo, N.Y. 14210 (716) 853-7500 Norman M. Schueckler, V.P. and Div. Gen'l Mgr.</p> <p>358</p>	\$100	\$10/mo.	\$5.50 to \$7/hr	\$0.10/sec	BASIC FORTRAN IV	<p>ECAP GCAP (Generalized CAP) Fast-Fourier trans.</p>	<p>GE-265 PDP-10 16 k words (32-bit word)</p>	TTY Plotter CRT			<p>WIS. ILL. MICH. IND. OHIO</p>	<p>KY.</p>	<p>ME. VT. N.H. MASS. R.I. CONN.</p>	<p>N.Y. N.J. PA.</p>	<p>W. VA. VA. Wash., D.C. GA. N.C. S.C.</p>
<p>HONEYWELL, INC. Information Services Div. 2701 4th Ave. So. Minneapolis, Minn. 55408 (612) 332-5200 Claude H. Smith, V.P. & Gen'l Mgr.</p> <p>359</p>					BASIC FORTRAN IV		<p>H-1648 16 k words</p>	TTY Plotter	<p>L.A., Calif. S.F., Calif.</p>		<p>Minneap., Minn. Clayton, Mo. Cleveland, Ohio Southfield, Mich. Chicago, Ill.</p>	<p>Dallas, Tex. Houston, Tex.</p>	<p>Wellesley, Mass.</p>	<p>New York, N.Y. Philadelphia, Pa.</p>	<p>Atlanta, Ga. Tampa, Fla. Arlington, Va.</p>
<p>INTERACCESS CORP. 1076 E. Meadow Cir. Palo Alto, Calif. 94303 (415) 327-8900 Tod Morcott, Pres.</p> <p>360</p>				\$350 to \$750/hr.	FORTRAN IV SUPERBASIC		<p>CDC 3800 98 k words (48-bit word)</p>	TTY	<p>S.F., Calif. L.A., Calif.</p>						

Time sharing services (cont'd)

Computing services'	PRICES				SERVICES		HARDWARE		TOLL-FREE CALLS							
	names and addresses and Inquiry card No. . . .	Initial	Min.	Conne- tion charge	CPU	Engineering languages	Electronic programs	Computers and size of available core	Engineering terminals	Pacific States	Mountain States	North Central	South Central	New England	Middle Atlantic	South Atlantic
INTERACTIVE SCIENCES CORP. 60 Brooks Dr. Braintree, Mass. 02184 (617) 848-2660 Hammond Ladd, Pres. 361	none	\$100	none	\$100/ mo.	Ext. BASIC FORTRAN IV		PDP 10-8 32 k words (36-bit word)	TTY CRT	S.F., Calif.					Boston, Mass.	New York, N.Y. Pittsburgh, Pa.	
INTERNATIONAL TELECOMPUTER NETWORK CORP. 7315 Wisconsin Ave. Bethesda, Md. 20014 (301) 654-2335 Roger B. Gregory, Pres. 362	none	none	\$7.50 to \$25/hr.	\$0.01/ 1024 words/ sec.	BASIC Ext. BASIC FORTRAN IV		GE-615 222 k words (36-bit word)	TTY Plotter CRT Data- point			ILL. MICH. Cleveland, Ohio IND.	KY. TENN.	N.H. VT. MASS. R.I. CONN.	Rome, N.Y. Philadelphia, Pa. N.J.	DEL. Baltimore, Md. Wash., D.C. VA. W. VA. N.C. S.C. GA.	
INTERNATIONAL TIME SHARING CORP. ITS Bldg.-Jonathan Industrex Chaska, Minn. 55318 (612) 445-4700 Albert M. Sheldon, Jr., Pres. 363	none	\$100/ mo.	\$10/ hr.	\$0.08/ sec.	BASIC FORTRAN IV	ECAP	CDC-3300 32 k words (128 k chars.)	TTY Datapoint 3300	L.A., Calif. S.F., Calif. San Diego, Calif.		Minneap., Minn. Chaska, Minn.			New York, N.Y.		
INTRANET INDUSTRIES, INC. 9841 Airport Blvd. Los Angeles, Calif. 90045 (213) 644-3232 Arthur E. Speckhard, Pres. 364	\$100	\$100	\$10/ hr.	\$10/ min.	BASIC FORTRAN IV FORTRAN V		Univac 1108	TTY Datapoint CRT Plotter	L.A., Calif.	Denver, Colo.						
ITS INFORMATION NETWORK INC. 3838 S. Main Salt Lake City, Utah 84115 (801) 262-6491 Gordon N. Selby Jr., Pres. 365			\$6/hr.	\$6/5k core/ min.	FORTRAN IV BASIC		PDP-10 24k max. (36 bits)		L.A., Calif. Santa Ana, Calif. Portland, Ore.	Salt Lake City, Utah	Chicago, Ill.				Ft. Lee, N.J.	
ITT DATA SERVICES Div., ITT Corp. P.O. Box 402, Route 17 & Garden State Pkwy. Paramus, N. J. 07652 (201) 262-8700 Roy N. Colin, V.P. 366		\$150/ mo.	\$12/hr.	\$7 to \$20/ min.	FORTRAN IV BASIC		IBM 360/50 IBM 360/65	TTY	S.F., Calif. L.A., Calif. San Diego, Calif.	Denver, Colo.	Chicago, Ill.	Houston, Tex. Clayton, Mo.	Boston, Mass.	New York, N.Y. Pittsburgh, Pa.	Washington, D.C.	
THE MATRIX CORP. Comp. Service Div., W. 931 S. Douglas St. El Segundo, Calif. 90245 (213) 679-8211 Ronald L. Serandos, Mgr. of Mktg. 367			\$10/hr.	\$18/ min.	BASIC FORTRAN IV		IBM 360/65 GE 635 100k words (36-bit word)	TTY	L.A., Calif.					Boston, Mass.		

McDONNELL AUTOMATION CO. P.O. Box 516 St. Louis, Mo. 63166 (314) 232-8021 W. R. Vickroy, Mgr., Mktg.	\$100	none	\$8/hr. to \$22.50/hr.	\$0.10 to \$0.20/ sec.	BASIC FORTRAN IV	ECAP Network reduction	IBM 360/20 IBM 360/25 IBM 360/30 IBM 360/40 IBM 360/50 IBM 360/ 65/75 IBM 1130 XDS Sigma 7 10 or 20k (24-bit words ea.)	TTY	L.A., Calif.	Denver, Colo. Houston, Tex.	St. Louis, Mo.			E. Orange, N.J.	Richmond, Va. Washington, D.C.	
	368															
MULTICOMP INC. 36 Washington St. Wellesley, Mass. 02181 (617) 237-2910 Chas. P. Kerber, Pres.	\$100		\$8/hr.	\$0.20/ sec.	BASIC FORTRAN IV	ECAP STRESS NASAP LaPlace FFT BODROT	CDC 3600 PDP-81 (Up to 16k words)	TTY Datapoint 3300 (display)	L.A., Calif.					Boston, Mass.	New York, N.Y.	Washington, D.C.
	369															
ON-LINE SYSTEMS, INC. 4721 McKnight Rd. Pittsburgh, Pa. 15237 (412) 931-7600 John T. Godfrey, Pres.	\$100	\$100	\$10/hr.	\$0.05 ea.	BASIC FORTRAN IV		PDP 10-8 64k words (36-bit word)	TTY Datapoint 3300			Chicago, Ill			New York, N.Y. Buffalo, N.Y. Pittsburgh, Pa.	Baltimore, Md.	
	370															
PRYOR COMPUTER TIME SHARING CORP. 400 N. Michigan Ave. Chicago, Ill. 60611 (312) 644-5650 Robert B. James, V.P.	\$50	\$50/ mo.	\$8/hr.	\$0.05/ sec.	BASIC FORTRAN IV X BASIC		GE-430 18k (24 bits ea.)	TTY			Chicago, Ill.					
	371															
RAPIDATA 20 New Dutch Lane Fairfield, N.J. 07006 (201) 227-0035 Stewart B. Gold, Pres.	\$100	\$100/ mo.	\$11/hr. 0-75 hrs.	\$0.05/ sec.	Ext. BASIC FORTRAN IV	RECAL ECAP LOGIC MTBF	GE-437 20k	TTY Plotters						Boston, Mass. CONN.	New York, N.Y. Newark, N.J. Philadelphia, Pa.	
	372															
REALTIME SYSTEMS INC. 866 Third Ave. New York, N.Y. 10022 (212) 421-2250 Jack C. Lindley, Pres.	\$100	\$500/ mo.	\$15/hr.	\$8.35/ min.	BASIC FORTRAN IV		B-5500 32k words (256k chars)	TTY Plotter CRT							New York, N.Y.	
	373															
REMOTE COMPUTING CORP. 1 Wilshire Blvd., Suite 1400 Los Angeles, Calif. 90017 (213) 629-2532 Joseph T. Hootman, Pres.	\$25		\$5/hr.	\$0.10/ sec.	BASIC FORTRAN IV		B-5500 256k chars (48-bit words)	TTY Datapoint	L.A., Calif. S.F., Calif. San Diego, Calif. Sacramen- to, Calif. Seattle, Wash. ORE. NEV. ARIZ.	COLO. N. M. TEX. UTAH WYO. IDAHO						
	374															

Time sharing services (cont'd)

Computing services'	PRICES				SERVICES		HARDWARE		TOLL-FREE CALLS							
	names and addresses and Inquiry card No. . . .	Initial	Min.	Conne- tion charge	CPU	Engineering languages	Electronic programs	Computers and size of available core	Engineering terminals	Pacific States	Mountain States	North Central	South Central	New England	Middle Atlantic	South Atlantic
<p>SERVICE BUREAU CORP. 1350 Ave. of Americas New York, N. Y. 10019 (212) 262-5000 John Williams, Pres.</p> <p style="text-align: right;">375</p>	none	\$100/ mo.	\$11/hr.	\$9/ min.	FORTRAN IV BASIC	ECAP AC circuit design Simulation Oscillator des.	IBM 360/50 512k byte	TTY Plotters CRTs	Seattle, Wash. L.A., Calif. S.F., Calif. San Diego, Calif. San Jose, Calif.	Denver, Colo.	St. Paul, Minn. Milwaukee, Wis. Chicago, Ill. St. Louis, Mo. Detroit, Mich. Columbus, Ohio Indianap. Ind. Cleveland, Ohio Akron, Ohio Cincinnati, Ohio	Dallas, Tex. Houston, Tex.	Boston, Mass. Hartford, Conn. Providence, R.I.	Buffalo, N.Y. New York, N.Y. Philadelphia, Pa. Pittsburgh, Pa. Trenton, N.J.	Baltimore, Md. Wilmington, Del. Alanta, Ga. Washington, D.C.	
<p>SHARED COMPUTER SYSTEMS CORP. 176 W. Adams St. Chicago, Ill. 60603 (312) 372-5350 G. J. Haller, Pres.</p> <p style="text-align: right;">376</p>	none	none	\$11/hr.	\$0.18/ sec.	FORTRAN IV BASIC	EXTECAP (Ext. ECAP)	B-5500 32k (48 bits)	TTY			Chicago, Ill. Indianap., Ind.					
<p>TECHNOLOGY FOR INFORMATION MGT., INC. 1654 Central Ave. Albany, N. Y. 12205 (518) 869-0480 John Fitzgerald, Pres.</p> <p style="text-align: right;">377</p>	\$50	none	\$11	none	BASIC BASIC EXT FORTRAN IV		GE-420 Up to 60k chars.	TTY			Chicago, Ill. Cincinnati, Ohio			Rome, N.Y. Albany, N.Y.		
<p>TIMESHARE CORP. Box 683 Hanover, N. H. 03755 (603) 643-3640 Richard T. Beuschel, Pres.</p> <p style="text-align: right;">378</p>	none	0 to \$90	\$6 to \$8/hr.	none	Ext. BASIC	Matrix inv.	HP-2000A 8k words (16-bit word)	TTY Plotter					Boston, Mass.	New York, N.Y. North N. J.		
<p>TIMESHARE NETWORK CORP. 228 N. LaSalle Chicago, Ill. 60601 (312) 641-2040 James L. Ungar, Pres.</p> <p style="text-align: right;">379</p>	none	none	\$8/hr.	none	FORTRAN IV Ext. BASIC		H-1648 16k words		Seattle, Wash. L.A., Calif. S.F., Calif.		Minneapolis, Minn. Chicago, Ill.	Houston, Tex. Dallas, Tex.	Boston, Mass.	New York, N.Y. Philadelphia, Pa.	Washington, D.C.	
<p>TRANSNET CORP. 60 English Plaza Red Bank, N. J. 07701 (201) 747-1300 John J. Wilk, Pres.</p> <p style="text-align: right;">380</p>	none			none	BASIC FORTRAN FOCAL		DEC TSS-8 4k (12 bits ea.)	TTY Datapoint CRTs						Red Bank, N.J. New York, N.Y. Northern and Central N. J.		

<p>TYMSHARE, INC. 525 University Ave. Palo Alto, Calif. 94300 (415) 328-5990 Thomas J. O'Rourke, Pres.</p> <p>381</p>	none	\$390/ mo.	\$13/ hr.	\$0.04/ sec.	SUPER BASIC BATCH FORTRAN FORTRAN IV SUPER- FORTRAN	ECAP Coded-CAP CIRC LADDER FILSYN Filter MICAP MICRO LOGSIM LOGMIN LOGIC DIGILOG BODE PLOT LaPlace CSMP FOURIER	XDS 940 64k words	TTY Plotters CRT	Seattle, Wash. S.F., Calif. L.A., Calif. San Jose, Calif.	Reno, Nev.	Chicago, Ill.	Dallas, Tex.	Boston, Mass. Hartford, Conn.	New York, N.Y.	Washington, D.C. Arlington, Va. S. Petersburg, Fla.
<p>U.C.C. COMPUTER UTILITY NETWORK 1949 N. Stemmons Fwy. Dallas, Tex. 75207 (214) 741-5781 L. J. Mott, Pres.</p> <p>382</p>	none	none	\$7.50/hr.	\$1200/ hr.	FORTRAN V	ECAP SCEPTRE TRAC CIRCUS DAP (dc worst case) FAP (failure analysis) MIMIC (diff'l eg's)	U-1108 51-k words (36-bit word)	TTY CRT Plotters Datel	L.A., Calif. S.F., Calif.		Chicago, Ill.	Dallas, Tex. Houston, Tex. Tulsa, Okla. New Orleans, La.	Boston, Mass.	New York, N.Y. Princeton, N.J.	
<p>UNITED COMPUTING SYSTEMS INC. 3130 Broadway Kansas City, Mo. 64111 (816) 753-4500 Earle T. Crawford, Mktg. Mgr.</p> <p>383</p>	\$100	none	\$6.50 - \$15.00/hr.	\$0.00 - \$0.60/ sec.	BASIC FORTRAN IV	ECAP	GE-265 CDC-6000 (5.6k words)	IBM 2741 TTY CRT Datel DURA	L.A., Calif. S.F., Calif.	Denver, Colo.	Wichita, Kans. St. Louis, Mo. Kansas City, Mo. Chicago, Ill. Cleveland, Ohio	Dallas, Tex. Houston, Tex. Tulsa, Okla. Ft. Worth, Tex.	Philadelphia, Pa. Washington, D.C. New York, N.Y.	Atlanta, Ga. Birmingham, Ala. Jackson, Miss.	
<p>U.S. TIME-SHARING INC. 1831 Michael Farady Dr. Reston, Va. 22070 (703) 471-9000 W. Porter Stone, Pres.</p> <p>384</p>	none	none	\$10/hr.	\$10/ min.	FORTRAN IV BASIC	ECAP	IBM 360/65 1000k (8 bits ea.)	IBM 2741 TTY Datapoint 3300 CRT Typograph Plotter DURA 1021, 1041							Washington, D.C. (metropolitan area) Baltimore, Md.
<p>VIRTUAL COMPUTER SERVICES INC. 1119 Springfield Rd. Union, N. J. 07083 (201) 688-0020 Jack M. Hargiss, Pres.</p> <p>385</p>	none	none	0 to \$9	\$0.20 to \$0.67/ sec.	FORTRAN IV	ECAP CIRCUS LISA (linear circ. analysis) PANE (worst case)	IBM 360/67 256k char.	TTY			Chicago, Ill. Detroit, Mich.		Boston, Mass.	New York, N.Y. North N.J. Allentown, Pa. Bethlehem, Pa.	
<p>WESTINGHOUSE TELE-COMPUTER SYSTEMS CORP. 2040 Ardmore Blvd. Pittsburgh, Pa. 15221 (412) 255-3851 Steve C. Mullé, V.P. Mkt'g</p> <p>386</p>	none	\$100/ mo.	\$10/hr.	\$3/ min.	BASIC FORTRAN IV	ECAP	U-1108 RCA Spectra 70/46 IBM 350/ 50/65/75 (1024k bytes)	TTY CRT Datapoint 3300			Chicago, Ill. Detroit, Mich. Cincinnati, Ohio Indianap., Ind. Cleveland, Ohio		Boston, Mass.	New York, N.Y. Philadelphia, Pa. Pittsburgh, Pa. Union, N.J. Buffalo, N.Y.	Atlanta, Ga. Baltimore, Md. Washington, D.C.

NEW PRODUCTS

Digitizer encodes graphics for processing

Designed as input devices for time-share terminals, these data digitizers encode graphics for transmission to a computer central.

You attach the chart, IC mask, or whatever you wish to digitize for filing or processing, to the tracing bed. Then you trace the subject matter with a stylus. As you trace, the machine digitally encodes the stylus movements and transmits them through your terminal to the computer.

Both models, which differ only in the size of their tracing beds, resolve to 0.001 in., and are resettable to

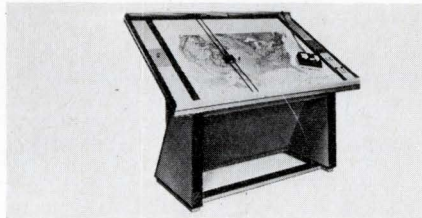

0.005 in.; maximum absolute error is 0.01 in. or 0.1%. You can select line-mode digitizing in octave increments from 0.008 to 0.512 in.

A floating keyboard gives you manual data entry with 64-character alphanumeric; the digitizer's output inter-

faces to most data terminals and medium-sized computers. You can manually tilt the formica-covered tracing bed from its level position through 40°.

The Model 280, with a 32- x 42-in. tracing area, is \$18,500, while the 48- x 60-in. Model 285 costs \$19,500. Options include a backlighted tracing area for \$1000 and, for the 280 only, the Model M projector at \$7500. All prices are fob Sunnyvale. Calma Company, 707 Kifer Rd., Sunnyvale, Ca. 94086. (408) 245-7522.

Circle 327 on Inquiry Card

Graphics at your leisure

A new digital data plotter draws graphs, from numbers or from algebraic equations, without special programming. Hewlett-Packard's Model 7200A uses standard EIA ASCII inputs directly from a teletypewriter terminal, either on-line or off-line.

The plotter draws graphs, handles scaling and curve fitting, and performs other basics of plotting. It uses a simple input format, so you can develop graphs directly using any source language such as BASIC or FORTRAN; no special software is needed. You are thus free of any tedious procedures in creating a graph, and you can concentrate solely on your problem.

You can draw irregular curves, circles, ellipses, contours, straight lines, any shape in fact, including bar and pie charts for business use.

The 7200A plots points (resettable to within 0.007 in.), straightline vectors up to 3 in. long in any direction, or both, under program control. It uses single sheets of paper up to 11 x 17

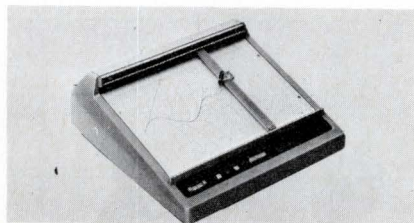

in.; you can adjust the size of the graph and use any preprinted grid.

Data points are not the end result of a long train of increments, but are defined by specific coordinates. This means that if there is an error in data transmission, the plot is corrected at the next point; data is not totally lost as with purely incremental plotters.

Software is available as user utility routines to help you create your graphics; programming skill is not required. Convenience routines do all scaling, coordinate transformation, and composition. They determine the graph's optimum size on the paper, position it, rotate it, and so forth.

With the Model 7200A, your time-share terminal can produce graphics in addition to its usual data tabulations. The plotter's interface is exactly the same as that of a teletypewriter, so you can use it on-line or as a time-sharing, remote terminal. And you never need special systems-driver software.

As a companion unit to a teletypewriter, the 7200A offers two interface options. With the first, you wire the plotter directly into the teletype. This lets you plot while the teletype itself is off. It also lets you plot off-line, from the teletypewriter keyboard. The second interface option lets you run the plotter with Bell-System-modified teletypes.

The Model 7200A graphic plotter sells for \$3300. For more information, contact Inquiries Manager, Hewlett-Packard Co., 1501 Page Mill Rd., Palo Alto, Ca. 94304. (415) 326-7000.

Circle 328 on Inquiry Card

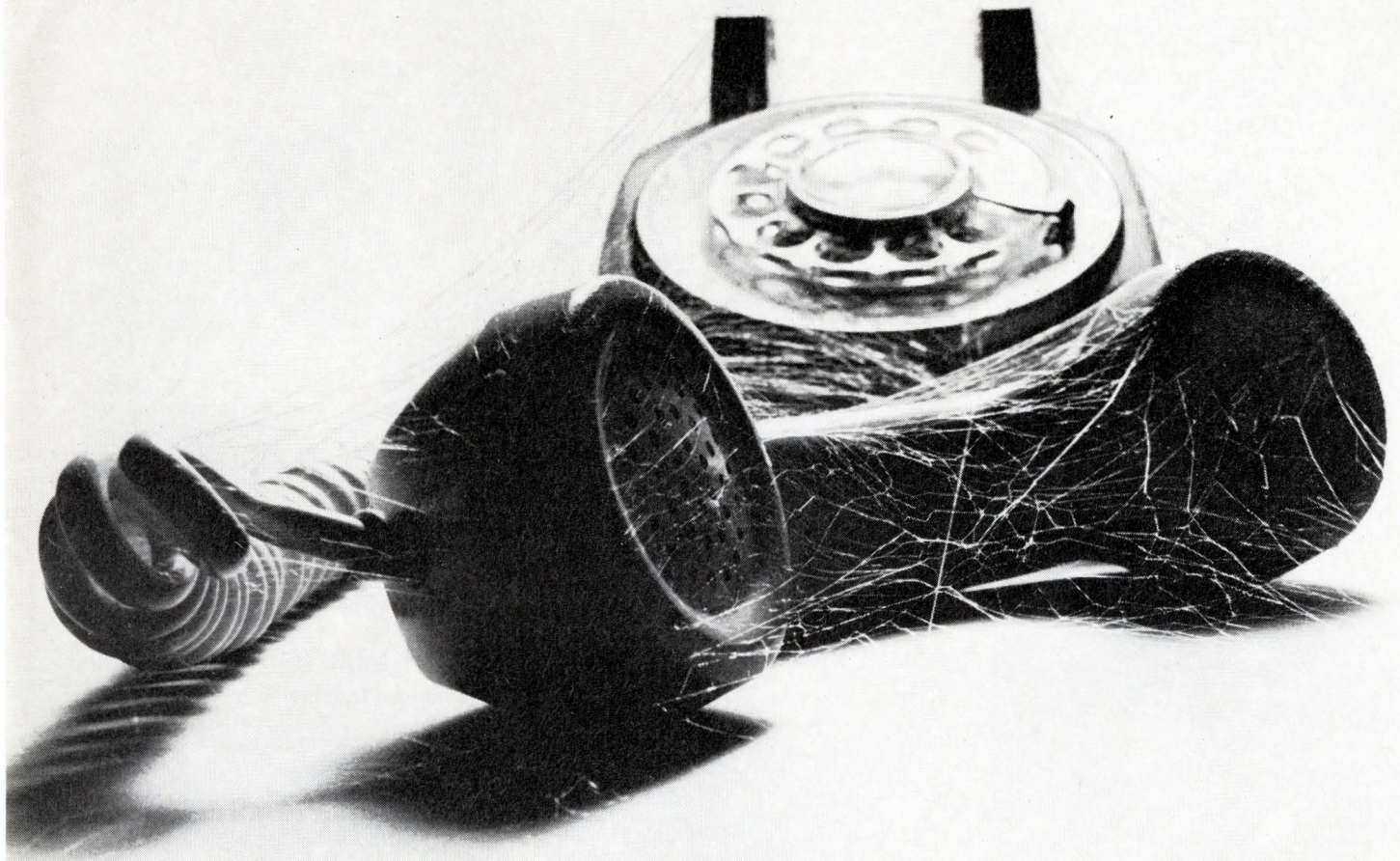

Time-sharing is like renting your very own busy signal.

If your service bureau keeps you waiting, it's probably because somebody else is getting served first.

But now there's a different kind of time-sharing that only you can use.

It's called the Interplex System I. It's an in-house system with a 12K general-purpose computer, hard-wired to as many as 16 specially designed terminals. So you don't need phone lines. And because it's your own in-house system, you can use it

as much as you want without paying an extra cent for it.

It's easy.

Our new time-sharing terminal is the first to combine BASIC language programming with an electronic calculator in a single desk-top unit. So you can do up to 90% of your time-sharing jobs in BASIC without leaving your desk. And for a lot less than you're paying now.

You won't need any more equipment, because the terminal's also an electronic calculator. So you can even stop in the middle of

your own program to run your calculations. And you don't have to wait for anybody else.

The Interplex System I. It's a different kind of time-sharing. You share it with yourself.



Interplex Corporation
400 Totten Pond Road
Waltham, Mass. 02154

280 380 580 680 780

285 385 585 685 785

NEW MODEL 280 & 285 DIGITIZERS FOR GRAPHIC DATA INPUT THROUGH DIRECT INTERFACE TO A COMPUTER OR DATA TERMINAL



DIGITIZING IN THE 70's

The Model 280 and Model 285 are the first models of a new family of ten graphic data digitizers to be introduced by CALMA Company in 1970. Each of the new models will be tailored to a specific digitizer application, and will be provided with systems software.

TWO SIZES

Equipped with 32x42 inch tracing bed, the Model 280 is designed for fast and accurate input of such graphic data as oscillograms, photographs, and projected film images (with optional projector). The Model 285, illustrated above, is equipped with a 48x60 inch tracing bed for digitizing large charts and maps. Both digitizers are designed for direct on-line operation through an electronic interface to your computer or data terminal.



COMPANY

707 Kifer Road • Sunnyvale
Calif. 94086 (408) 245-7522

Circle 171 on Inquiry Card

NEW PRODUCTS

DIGITAL PLOTTER

For timeshare terminal use.

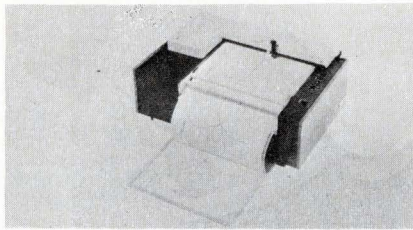

Model 150 is designed specifically for computer graphics. Plotting speeds go to 270 increments/s at 0.005 and 0.010 in./step. The plotter is self-contained and needs no external control unit. Conversational utility software is available from most timesharing services. \$5850. Eldorado Electrodata Corp., 601 Chalomar Rd., Concord, CA 94520. (414) 686-4200.

Circle 329 on Inquiry Card

COMMUNICATIONS TERMINAL

Runs at 10, 15, 30, or 60 char/s.

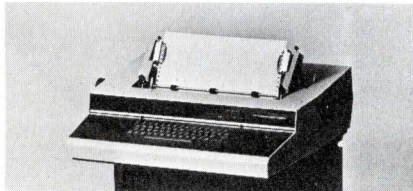

Model 1240 gives fast, remote print-out of computer-generated data, and expands your timeshare terminal capabilities. The unit has 94 printable graphics, multipart form printing, 120-character lines, changeable type-font, full- and half-duplex modems. Rentals start at \$115/mo. Memorex/Equipment Gp., San Tomas at Central Expwy., Santa Clara, CA 95052. (408) 247-1000.

Circle 330 on Inquiry Card

CRT DISPLAY SYSTEM

With flicker-free display.

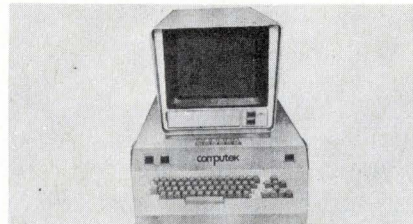

Series 400 is a graphic and alphanumeric man-machine communication terminal. Configurations range from a dedicated computer display to a self-contained, full-graphic remote terminal. Features include function keys for flexible interaction, data compression and asynchronous operation for speeds up to 2000 characters/s. Computek Inc., 143 Albany St., Cambridge, Mass. 02139.

Circle 331 on Inquiry Card

DATA CONCENTRATOR

For interactive timeshare systems.

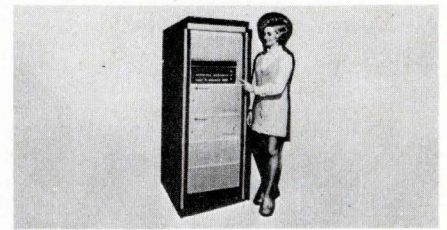

The 520/DC services up to 64 full-duplex data lines. As a pre-processor, it organizes data for direct entry into, or dispatch from, a computer. Lines can be 110 to 4800 baud, synchronous or asynchronous, with odd or even parity checks. \$32,500 for a 32-full-duplex-line system. Varian Data Machines, 2722 Michelson Dr., Irvine, CA 92664. (714) 833-2400.

Circle 332 on Inquiry Card

OUTPUT PRINTER

For remote terminal use.

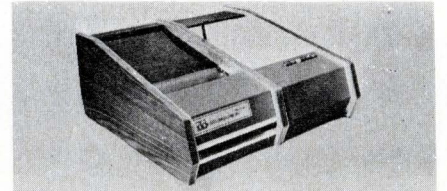

Typeliner is a 100-line/min. multiple print-out unit with either 80- or 132-column capacity. Standard 64-character set with lower-case alphabet optional. Also suitable as output device for CRT terminals. Uses EIA RS-232-B interface. Paper advances 24 lines/s. Available on rental for \$245/mo. Data Computing, 2219 W. Shangri La Rd., Phoenix, Ariz. 85029. (602) 944-4491.

Circle 333 on Inquiry Card

GRAPHICS PLOTTER

Self-contained desk-top unit.

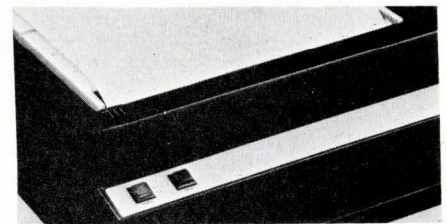

Model 57 can print 8000 alphanumeric/min., 400,000 dots/s, or 10,000 dots/in.² electrostatically. Uses character generator interface to decode ASCII from TTY. Digital logic positions each dot to draw alphanumerics, contours, engineering drawings, etc. Asynchronous mode expands compressed data. Info-Max, 470 San Antonio Rd., Palo Alto, CA 94306. (415) 327-5470.

Circle 334 on Inquiry Card

NEW LAB INSTRUMENTS

K_u BAND SWEEPER PLUG-IN

Frequency accuracy is ± 56 MHz.

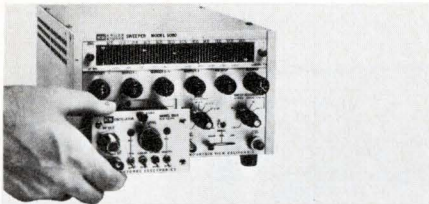

Model 5016 has a usable frequency range of 12.3 to 18.1 GHz. Used with the manufacturer's Model 5000A microwave sweep generator the unit provides a minimum power output of 4 mW. Frequency stability is $\pm 0.03\%$ / °C. Cost is \$2850 with delivery in 90 days. Kruse Electronics, 790 Hemmeter Lane, Mountain View, Calif. 94040. (415) 967-2299.

Circle 228 on Inquiry Card

AMPERE HOUR METER

For accurate process control.



Designed for use with standard 50 and 100 mV shunts, Model EMAM-129 accepts inputs up to 300 mV. Over-voltage protection withstands transients up to 10 V. The unit includes an SPDT output signal for alarm or control that you can preset at any meter reading. Gulston Industries, Engineered Magnetics Div., 13041 Cerise Ave., Hawthorne, Calif. 90250.

Circle 229 on Inquiry Card

DC CURRENT SOURCE

Holds output current to $\pm 0.005\%$.



Model 225 gives you an output current that is adjustable from 10^{-7} to 10^{-1} A. The unit maintains the terminal voltage for the selected current within the compliance range (selectable from ± 10 to ± 100 V). You can also modulate the current with an external ac signal. \$595. Keithley Instruments, Inc., 28775 Aurora Rd., Cleveland, Ohio 44139.

Circle 230 on Inquiry Card

STANDARD CAPACITOR

Calibrates capacitance meters.



The Model 71-1A is a three-terminal standard that you can set for Q greater than 100 and Q equal to 3 at 1 MHz. It is set to 100 pF $\pm 0.25\%$ at 1 MHz, traceable to NBS, and calibrates the manufacturer's capacitance meter for both capacitance and phase. \$75. Boonton Electronics Corp., Rte. 287 at Smith Rd., Parsippany, N.J. 07054.

Circle 231 on Inquiry Card

DATA ANALYZER

For communications systems.

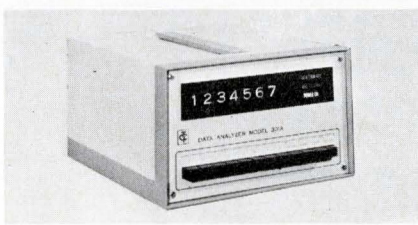

You can use the Model 301-A to monitor the various devices and communications lines that make up data communication systems. This solid state unit includes a regulated dc supply plus all circuitry and connections necessary to attach directly to the data terminal, modem or system. Technical Concepts, Inc., 580 Jefferson Rd., Rochester, N.Y. 14623.

Circle 232 on Inquiry Card

DIGITAL PRINTER

With floating point.

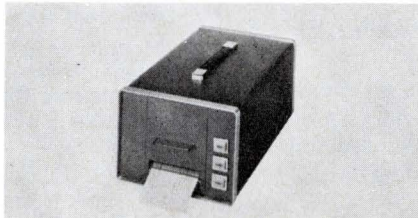

These printers, Models 2014 and 2020, are designed for low-speed data recording systems. You can use them for recording data from counters, digital voltmeters and other instrumentation. They can record up to 20 columns with the decimal point floating over the entire range. Digitron Corp., 2544 W. Main St., Norristown, Pa. 19401. (215) 277-5800.

Circle 233 on Inquiry Card

STRAIN INDICATOR

With 1% accuracy.

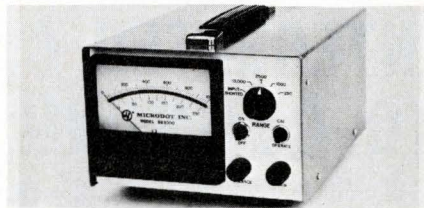

You can use the Model SG-3000 with most types of strain gages and strain gage transducers. The unit includes a bridge power supply, bridge completion and balance components, amplifier and panel meter readout. It comes in ac or battery operated models. Microdot Inc., Instrumentation Div., 220 Pasadena Ave., South Pasadena, Calif. 91030.

Circle 234 on Inquiry Card

SWEEP-SIGNAL GENERATOR

From 5 MHz to 2350 MHz.



Model VS-90 has three overlapping bands: 5 to 800 MHz, 750 to 1300 MHz and 1250 to 2350 MHz. Each band can be swept up to its full width while having sufficient stability for narrow band circuit testing. Output power is 10 mW in both the cw and sweep modes. \$2495. Texscan Corp., 2446 N. Shadeland Ave., Indianapolis, Ind. 46219.

Circle 235 on Inquiry Card

FREQUENCY METER

For 10 Hz to 200 MHz.

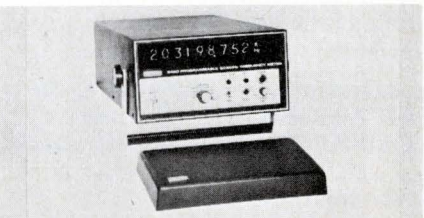

Since the Model 6420 measures frequency by direct counting techniques, it requires only a single input connection. The instrument has an input dynamic range of -7 dBm (100 mV rms) to 33 dBm (10 V rms). \$1050, 90 day delivery. Electronic Instruments Div., Beckman Instruments, Inc., 2200 Wright Ave., Richmond, Calif. 94804.

Circle 236 on Inquiry Card

now available... **7** INNOVATIVE APPLICATIONS OF INTEGRATED CIRCUITS TO COMMUNICATIONS

In response to popular demand, we are making available the proceedings of the recent seminar and workshop on the "APPLICATIONS OF INTEGRATED CIRCUITS TO COMMUNICATIONS" which was sponsored by *The Electronic Engineer*.

Moderated by J. Lightsey Wallace of the Atlantic Research Corporation, the seminar included a series of papers which included 7 innovative approaches to practical applications of the new families of ICs to communications and consumer products.

The papers cover the following 7 subjects:

AGC—It's the Old Dynamic-Range With Good Signal-to-Noise Trick

Jack MacIntosh
Tom Mills
Fairchild Semiconductor

The Phase-Locked Loop

Arthur Fury
Signetics Corp.

AM/FM Receivers with ICs

Ronald W. Lutz
Sprague Electric Co.

Large-scale Integration of TV Circuits

S. Gertzis
Amperex Electronic Corp.

Applications of a Low-Power Operational Trans-conductance Amplifier (OTA) IC Array in Communications Systems

H. A. Wittinger
RCA Electronic Components

Integration of Complex Functions

Ted Hanna
National Semiconductor Corp.

Modulation, RF/IF Amplification, and Multiplexing

Roy Hejhall
Motorola Semiconductor Products, Inc.

These innovative and practical approaches have attracted so much attention in the technical community that they are now being made available to those who were unable to attend the seminar. Your copy is available now. To get it send the coupon below with your check or money order for \$6.00 to *The Electronic Engineer*. Your copy will be forwarded to you by return mail.

Yes, I want _____ copy(ies) of the papers on the "APPLICATIONS OF INTEGRATED CIRCUITS TO COMMUNICATIONS." My check in the amount of \$_____ for _____ copy(ies) is enclosed. Send to me at the following address:

Make check or money order payable to Communications ICs
The Electronic Engineer Magazine
Chestnut & 56th Streets, Phila., Pa. 19139 E-5

Name _____ Title _____

Company _____ Division _____

Street _____

City _____ State _____ Zip _____

NEW LAB INSTRUMENTS

LINE NOISE GENERATOR

Simulates power line interference.



You can use the Model 3020 to generate a controlled line transient similar to rectifier or SCR noise on the ac line. The instrument will also measure the line noise up to 1 kV peak. You can continuously adjust noise amplitude and position (phase) and the unit has a sweep mode for scanning the noise pulse over the full 360° of line cycle. Because it can create virtually any line-noise condition, the unit is particularly suited for testing the line-noise rejection of instruments and systems using integrated circuit logic. \$495; delivery in 90 days. Technical Information Section, Electronic Instruments Div., Beckman Instruments Inc., 2200 Wright Ave., Richmond, Calif. 94804.

Circle 272 on Inquiry Card

FUNCTION GENERATOR

Has up to 20 V pk-to-pk output.

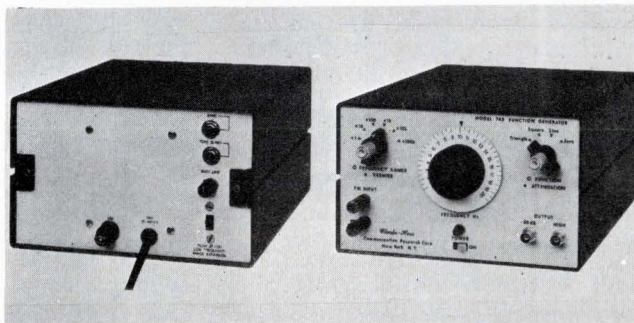

Model 743 gives you low distortion sine, square, and triangular waves over six ranges from 1 mHz to 2 MHz. In the vcg or fm mode the top frequency range may be swept from 1 kHz up to 4 MHz with sinusoidal amplitude variations of $< \pm 0.15$ dB. As unique features in its price range, the unit has both tone burst and synchronization capabilities. The generator also has a zero signal output position and an internal dc offset control. It will handle sweep or fm modulation rates up to 200 kHz with a nominal voltage control of frequency sensitivity of (4 Hz/V) times the RANGE setting. \$365 with immediate delivery. Clarke-Hess Communication Research Corp., 43 W. 16th St., New York, N.Y. 10011. (212) 255-2940.

Circle 273 on Inquiry Card

SMALL SIZE DIGITAL PANEL METER

Incorporates fluorescent readout.

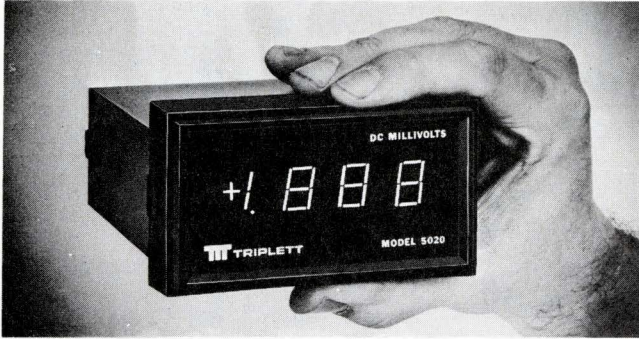

Model 5020 is a low power, 3½ digit panel meter that measures 2.359 x 4.140 x 4.846 in. The fluorescent readout is in a single plane, is non-blinking and has a 1 s response. Standard features include a sensitivity of 10 mV, an input resistance of 100 MΩ and 100% over-range. The unit uses dual slope integration to convert an unknown analog voltage to a digital number. The basic operation consists of converting an unknown voltage to a precise current and integrating for a fixed period of time. The integrator then integrates a reference current of the opposite polarity until it returns to its starting point. Price of the basic instrument is \$240, or you can get it with BCD outputs for \$265. Triplet Corp., Bluffton, Ohio 45817.

Circle 274 on Inquiry Card

The Family Friend

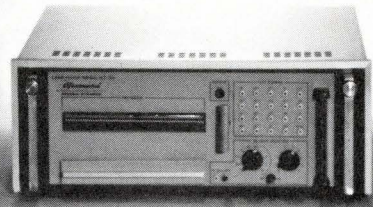

DYNATRONICS ICT-100 is a universal IC Card Tester for maintenance of all integrated circuit logic families. Simple to operate, it is digitally programmed with standard IBM punched cards. Controls, test jacks and a visual NO/GO indicator are conveniently located on the front panel. A complete line of integrated circuit cards is also offered.

GENERAL DYNAMICS

Electronics Division - Dynatronics Operation

P. O. Box 2566, Orlando, Florida 32802

Circle 48 on Inquiry Card



The cleaner/solvent that couldn't be cleaner

When you have important cleaning jobs, can you afford to take chances on solvents made with reclaimed materials? If not, rely on MS-180 Degreaser—it's formulated entirely from virgin fluorocarbons and meets Government specs for cleaning solvents.

Reclaimed materials are cheaper, but we want to solve problems, not create new ones. So, for the critical jobs use the cleaner that's 100% clean to start with—MS-180 Degreaser.

Prices: 1-11 doz. 16 oz. cans, \$2.60/can; 1 gross, \$2.00/can; 4 gross, \$1.90/can; 7 gross, \$1.80/can. Trial order: 4 cans @ \$3.70/can



miller-stephenson chemical co.,inc.

ROUTE 7, DANBURY, CONNECTICUT 06810

For magnetic research and testing

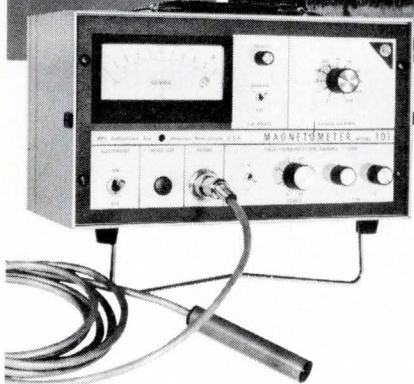
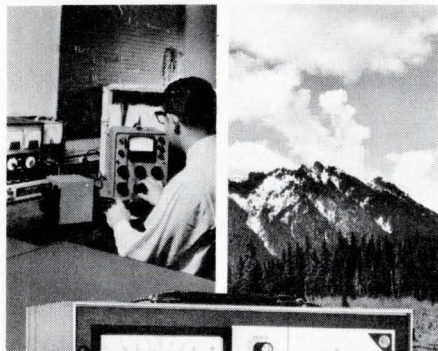

RFL Model 101 Magnetometer

In the lab or field, RFL's Model 101 fluxgate magnetometer is ideal for measuring low value magnetic flux density.

Use it for geophysical exploration, paleomagnetism, terrestrial magnetic experiments, locating ferrous materials, non-destructive testing, and measuring.

Measures 1 to 100,000 gamma in 10 ranges. Built-in field compensation enables 0.5 gamma sensitivity/resolution up to 70,000 gamma.

Rugged, all solid-state design. Operates on 115-230V or mercury batteries. Calibration check built into unit. Weight: 11 lbs. Write for literature.

RFL Industries, Inc.

Instrumentation Div. • Boonton, N.J. 07005
TEL: 201-334-3100 / TWX: 710-987-8352 / CABLE: RADAIRCO, N. J.

Circle 50 on Inquiry Card

SYSTEMS EQUIPMENT

MODULAR A/D CONVERTERS

Only 2 x 4 x 0.4 in.

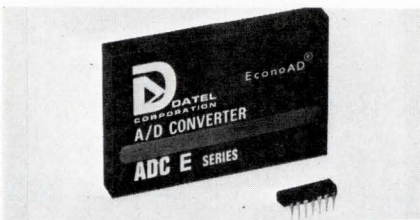

ADC-E series converters have digitizing rates to 3 kHz and can be operated asynchronously or synchronously. Full scale input is ± 1 V with optional ranges of ± 100 mV, ± 10 V or ± 100 V at input imp. of 100 M Ω . Overall accuracy is $\pm 0.05\%$ with a TC of ± 50 ppm/ $^{\circ}$ C and a CMR ratio of 80 dB at 60 Hz. Output coding can be binary or BCD. Datel Systems Corp., 943 Turnpike St., Canton, Mass. 02021. (617) 828-1890.

Circle 237 on Inquiry Card

TAPE MEMORY SYSTEM

Computer compatible.

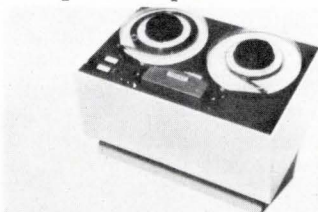

New digital tape memory features bi-directional programming and read-after-write operation. The TMX has packing densities of 200, 556, and 800 bits/in. on std. 1/2-in. computer tape. Maximum tape speed is 12 1/2 ips. It is for use in keyboard-to-tape terminals, tape-to-hard-copy printout stations, mini-computers, and so forth. From \$2,000 to \$2,500. Ampex Corp., 9937 W. Jefferson Blvd., Culver City, Calif. 90230. (213) 836-5000.

Circle 238 on Inquiry Card

MULTI-CHART RECORDER

All records on one sheet.



Model 400 records analog information from 48 to 96 process variables on one sheet of paper which remains stationary and in full view. With it you can time share each signal conditioner between several points. Two or four records may be printed in two or four colors on each of 24 individual charts, located on a single sheet of paper. Telmar, Inc., 810 W. Third Ave., Columbus, Ohio 43212.

Circle 239 on Inquiry Card

PAPER TAPE SPOOLER

Operates to 1000 char./s.

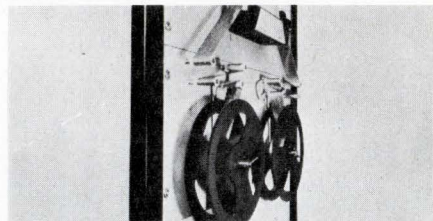

New high speed, bi-directional paper tape spooler accommodates 5-8 track paper or mylar tape at bi-directional speeds to 1000 char./s. and rewind speeds to 1000 char./s. They are particularly well suited for N/C, ground support systems, test equipment machine control, digital data handling, automatic test systems and computer input. Datascan, Inc., 1111 Paulison Ave., Clifton, N.J. 07013. (201) 478-2800.

Circle 240 on Inquiry Card

DATA RECORDING SYSTEM

Handles decimal or BCD data.

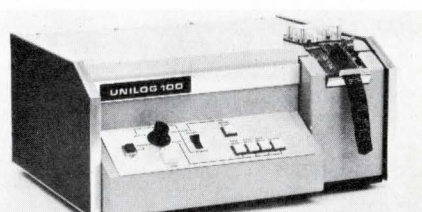

Unilog 100 offers a programmer, code converter and paper tape perforator in one package. All control functions and the word format are arranged by simply jumper-wiring the output connector. Data can be decimal or BCD form (interchangeably). Any 5, 6, 7, or 8 chan. output code can be produced. Sixteen different characters are selectable. \$3,495. Eldon Associates, Inc., 918 Industrial Ave., Palo Alto, Calif. 94303. (415) 321-8641.

Circle 241 on Inquiry Card

HELIUM-CADMIUM LASER

With adjustment-free internal mirror.

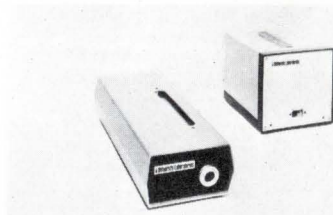

This laser has an output wavelength in the deep blue at 4416 Å. Output power is over 2 mW in the TEM₀₀ mode with a beam dia. of 0.9 mm and a divergence of 1.0 milliradian. Model 416 operates from a dc plasma discharge containing vaporized metal Cd in an atmosphere of He gas. Only 175 W input power is needed. University Laboratories, 733 Allston Way, Berkeley, Calif. 94710. (415) 848-0491.

Circle 242 on Inquiry Card

The Electronic Engineer • May 1970

READ-WRITE MEMORY

Can be altered as desired.

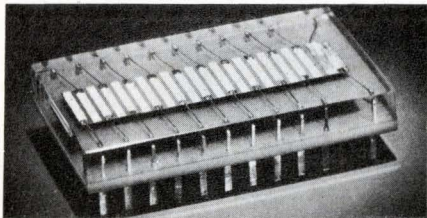

Features of this new digital memory include inherent non-destructive read-out, inherent non-volatility, and high output voltage capable of driving high impedance, low level ic digital logic directly. Typical performance ranges: Write volt.—90 to 360 V; write time—several microseconds and up, and 1 to 4 V output. Poly-Scientific Div. of Litton Industries, 1111 N. Main St., Blacksburg, Va. 24060. (703) 552-3011.

Circle 243 on Inquiry Card

ACQUISITION SYSTEM

Includes memory.

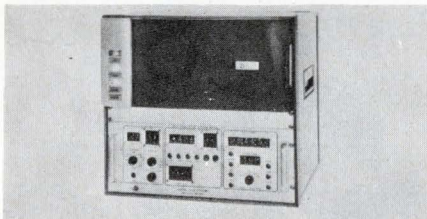

DDS 113 Data Acquisition System, accepts bipolar analog voltages up to ± 10 V. The data is converted into a 12 bit binary value and recorded in either a binary or BCD format on a synchronous IBM compatible tape. System includes memory for data collection prior to recording onto tape. Thus, it operates equally as well at 1 sample/s or slower as it does at 50,000 samples/s. Digital Data Systems, 18819 Bryant St., Northridge, Calif. 91324.

Circle 244 on Inquiry Card

DIGITAL COMPUTER

Full cycle time of 1 μ s.



The DC 6024/3 with a fixed word length of 24 bits has five 24-bit general-purpose registers, an 8,192 word memory (with parity), (expandable to 65,536 words) hardware multiply/divide/sq. root, four levels of priority interrupt and a std. software package. A console ASR-33 typewriter can be used as the basic i/o device. Datacraft, Box 23550, Ft. Lauderdale, Fla. 33307. (305) 933-2651.

Circle 245 on Inquiry Card

ALL THE AVAILABLES

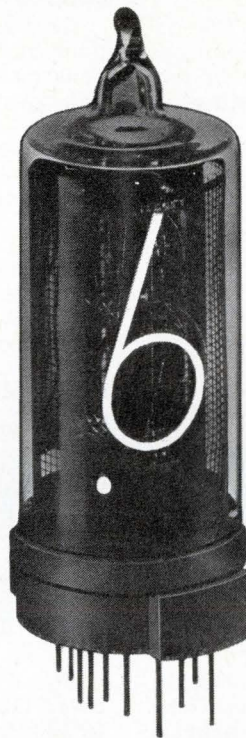

NL-950 Readout Tube

available in quantities you need

- also for immediate delivery NL-940
a direct replacement for the B-5750.
- made in U. S. A. (Geneva, Illinois)

For additional information and application assistance, write or call National Electronics, Inc., a varian subsidiary, Geneva, Illinois 60134, Phone (312) 232-4300.

NATIONAL ELECTRONICS, INC.
a varian subsidiary

NEW PRODUCTS

POWER SUPPLY

Can power about 100 ics.



Model IC 5-5A delivers 5 Vdc at 5 A. It is small enough to mount on a PC card as an integral part of the system, yet is completely self-contained. It operates from 105 to 125 Vac, 50 to 1000 Hz. Line and load reg. is held to ± 5 mV max. with ripple and noise held to 5 mV rms max. It has an after warm-up stab. of ± 5 mV and a τ_c better than 2.5 mV/ $^{\circ}$ C. \$185. Elasco-Eastern, Inc., 5 Northwood Rd., Bloomfield, Conn. 06002. (203) 242-0708.

Circle 201 on Inquiry Card

OP AMP POWER SUPPLY

Dual output of ± 15 V at 25 mA.



ZM 1525 low-cost modular supply powers hybrid, IC and discrete-component op. amps. It is short-circuit proof (infinite period of time) and will operate from -25° to 71° C without derating. Input voltage is 105 to 125 Vac (50 to 400 Hz), reg. (line and load) is 0.2% (typ.) and ripple and noise is 2 mV pk-pk. \$23.50 (1-9). Zeltex, Inc., 1000 Chalamar Rd., Concord, Calif. 94520. (415) 421-3555.

Circle 202 on Inquiry Card

CHIP RESISTORS

With extra protection.

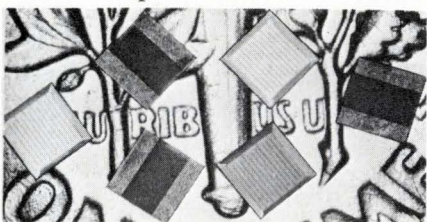

Stable leadless metal film resistors are given extra protection by a deposited glass film overlay. They also have thick wrap-around gold termination, suitable for eutectic or wire bonding to thin or thick film conductors. Size is 75 mils sq., resistance range 100 Ω to 50 k Ω , TCR is 25 ppm/ $^{\circ}$ C and tol. is 0.1%. Airco Speer Electronic Components, Niagara Falls, N.Y. 14302.

Circle 203 on Inquiry Card

TUNING VARACTORS

For use in microwave ss systems.

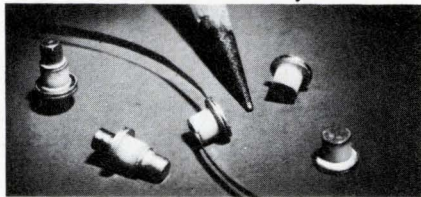

These varactors feature high Q, low inductance packaging and tuning capability over a wide freq. range. The 90 V silicon dioxide passivated devices with guaranteed Q at 1 GHz provide leakage current typ. below 10 nA out to the specified breakdown voltage. Capacitance ranges from 1-31 pF and capacitance ratio is 8.6 to 1. Applications include freq. tuning of Avalanche and Gunn oscillators and filters. Microwave Associates, Burlington, Mass. 01803.

Circle 204 on Inquiry Card

FREQ. TO DC CONVERTERS

Plug-in units.

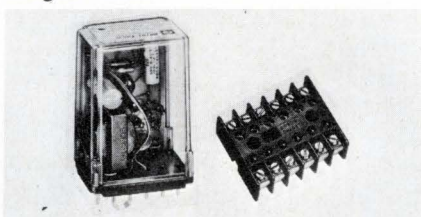

This series of 8 Mini-Tach models covers the complete range from 100 to 20,000 Hz. All have ss circuitry for an accuracy of $\pm 0.5\%$ of FS. Entire series accepts the inputs from magnetic sensors, proximity switches and digital devices and produce 0-5 V, or 0-1 mA. They have an analog signal capability that is easily adapted to computer applications. Electro Products Laboratories, Inc., 6125 Howard, Chicago, Ill. 60648. (312) 647-8744.

Circle 205 on Inquiry Card

DIGITAL PANEL METER

Full 4-digit meter.



VT 200 offers either 10 μ V or 10 nA resolution. Accuracy is 0.05% of reading $\pm 0.05\%$ of FS over the ranges of either 100 mV or 100 μ A. Features include: non-blinking display; automatic polarity; BCD logic output; end of measurement signal output; trigger input; automatic zero, and an int. calibration ref. volt. \$330. Dixon, Inc., Box 1449, Grand Junction, Colo. 81501. (303) 242-8863.

Circle 206 on Inquiry Card

VOLTAGE REGULATOR

Accommodates thermal drift.

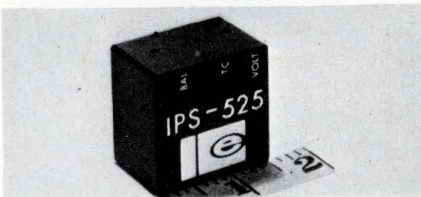

This precision regulator lets you program the τ_c of the ref. supply to accommodate the thermal drift of components. Model IPS-525 provides independent adjustment of output voltage and τ_c controls—controls that produce a reg. output voltage which varies linearly with temp. Output voltage range is 5 to 25 V. Regulation is 0.01%. The τ_c is variable from 0 to $+2.5$ mV/ $^{\circ}$ C or 0 to -2.5 mV/ $^{\circ}$ C. Inter-Computer Electronics, 1213 Walnut St., Lansdale, Pa. 19446.

Circle 207 on Inquiry Card

BREADBOARDING KIT

Deck is about 5 x 10 in.

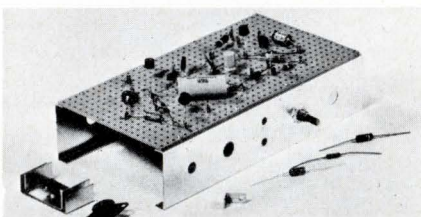

Kit consists of a phenolic breadboarding deck, metal base, solder-type feed-thru terminals, switch and pot brackets, universal "Z" brackets, right angle brackets, smaller pieces of phenolic board and assembly hardware. Feed-thru terminals accommodate six or more wires on the top of the deck, and four or more wires can be easily attached on the underside. Houle Mfg. Co., Box 276, Santa Susana, Calif. 93063. (805) 526-8118.

Circle 208 on Inquiry Card

X-BAND VSWR BRIDGE

Replaces slotted lines.

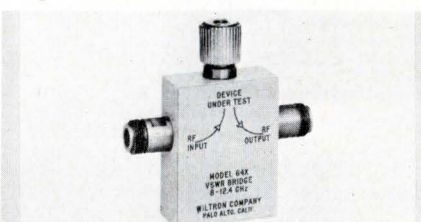

Resistive rf vswr bridge method has now been extended to X-band (7 to 12.4 GHz). With a directivity of 36 dB and an output vswr of $< 1.25:1$, accurate swept freq. vswr displays can be made from 1.03:1 to 20:1. This measuring technique replaces slotted lines and provides swept freq. display of vswr. Model 64X costs \$495. Wiltron Co., 930 E. Meadow Dr., Palo Alto, Calif. 94303. (415) 321-7428.

Circle 209 on Inquiry Card



**Weight watchers!
Here's the slimmest
20 position rotary
switch...**

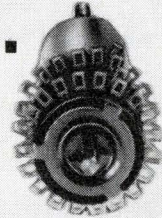

only 9/16" diam.

Smaller than a dime in diameter, Daven's new Series "S" Switch comes in 1 pole 2 to 20 positions to 4 poles 2 to 5 positions; spacing of 18°, 22½°, 36°, and 45°, shorting and non-shorting; and, with as many as ten decks, it is less than 3 inches long. Series "S" is by far the greatest development in subminiaturization since Daven's Series "G" rotary selector switches, which have proved their reliability under all conditions.

Write for Bulletin SS88.

DAVEN



Manchester, N.H. 03101 (603) 669-0940
TWX 710-220-1747

NEW PRODUCTS

P-N GaAs LIGHT SOURCES

Compatible with Si sensors.

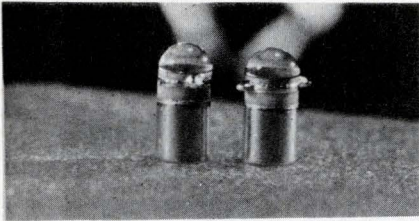

TIL23 and TIL24 light sources are economical versions of high power GaAs emitters and are designed to emit near-IR light when forward biased. At $I_f = 50$ mA, min. power output for the TIL24 is 1 mW. Minimum power output for the TIL23 is 0.4 mW at $I_f = 50$ mA. Both sources feature a narrow light beam emission at an angle of 35° and at the half power points. TIL23 is \$2.68 (100 piece quan.) and TIL24 \$3.70 (100 piece quan.). Texas Instruments Incorporated, Box 5012, M/S 308, Dallas, Texas 75222.

Circle 246 on Inquiry Card

SILICON IMPATT DIODES

Generate > 0.5 W in X-band.

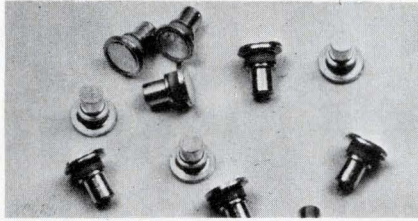

Two new ss diodes are the type 5082-0400, optimized for frequencies between 8.0 and 10.0 GHz, and the type 5082-0401 for 10.0 to 12.4 GHz. Both are guaranteed to generate more than 500 mW within their respective freq. bands with better than 5% eff. Thermal resistance of the new diodes is $< 17^\circ\text{C/W}$, as compared to the more than 20°C/W commonly found in earlier Impatt diodes. Hewlett-Packard Co., 1501 Page Mill Rd., Palo Alto, Calif. 94304. (415) 326-7000.

Circle 247 on Inquiry Card

CARD MOUNTING RELAYS

IC compatible.

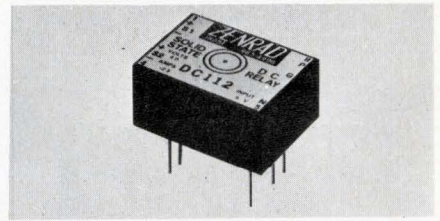

Both dc and ac ss switches, available in a PC card mounting module, have complete isolation of poles and control. The dc models switch to 150 V, 2 A for fast, bounce-free operation. Double pole units may be connected for ac/dc switching. The ac models control 10-230 V rms to 4 A from low level signals. They are available with zero-axis switching and time delay for noise free motor starting to $\frac{1}{2}$ hp. From \$7.80/1000. Zenrad Controls Co., 232 E. Gutierrez St., Santa Barbara, Calif. 93101. (805) 965-4996.

Circle 248 on Inquiry Card

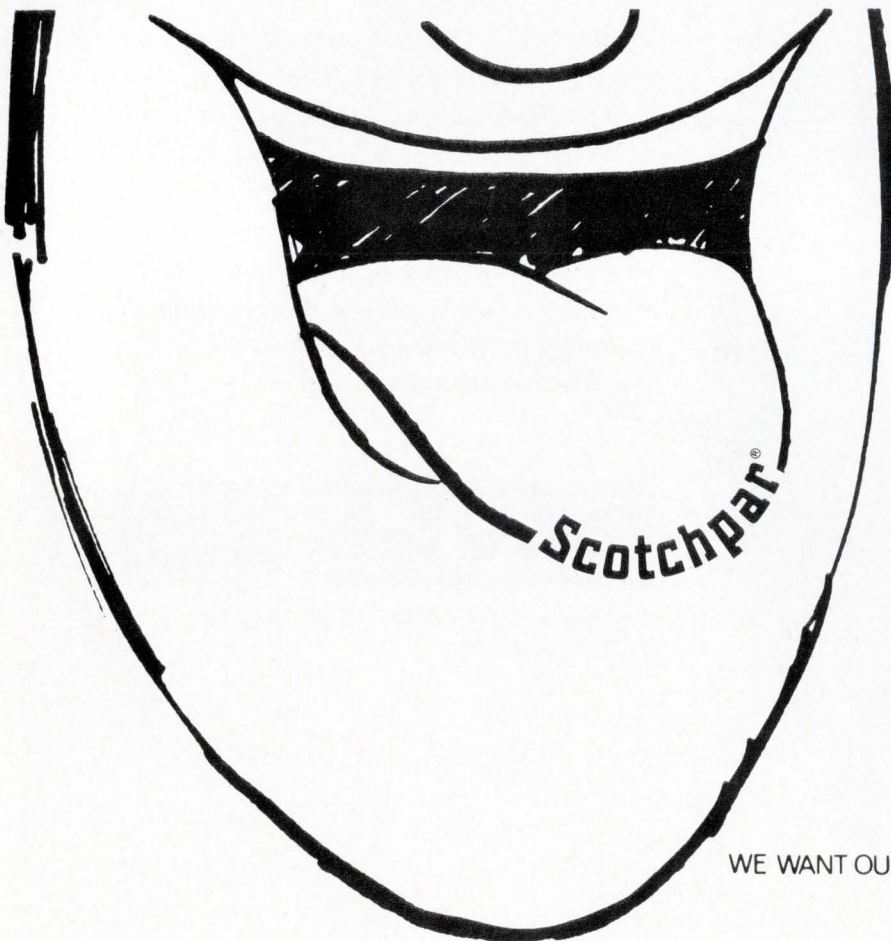

WE WANT OUR NAME ON THE TIP OF YOUR TONGUE!

Scotchpar 3M
BRAND POLYESTER FILM COMPANY

FAST SETTLING OP AMP

Settles to 0.01% in $<0.9 \mu\text{s}$.

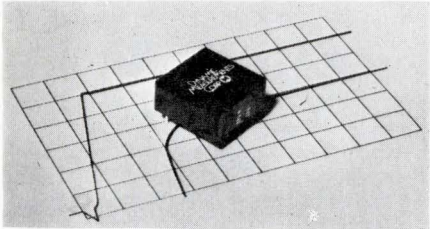

FST-102B features single element phase compensation for fast slewing rate and settling time. Its low input current drift suits it to many uses formerly requiring FET amplifiers. Features are: clean inverting and non-inverting response; true 6 dB/octave stabilization; 25 V/ μs slewing rate; 250,000 gain; 90 dB CMR; 12 MHz BW; 5 $\mu\text{V}/^\circ\text{C}$ voltage offset drift; 100 pA/ $^\circ\text{C}$ input bias current drift. \$33. Dynamic Measurements Corp., 108 Summer St., Arlington, Mass. 02174. (617) 648-3610.

Circle 249 on Inquiry Card

PCB ASSEMBLY SYSTEM

Computer controlled.

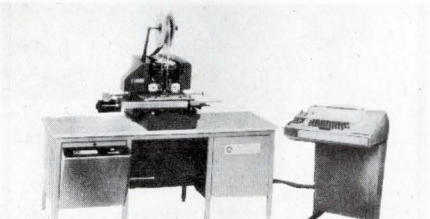

This pc board assembly system can increase assembly rates by as much as 5% over N/C rates. It can control insertion of sequenced components on up to 999 different center distances with one handling of the PCB. Furthermore, the same computer can asynchronously control up to 10 machines. Universal Instruments Corp., E. Frederick St., Binghamton, N.Y. 13902. (607) 772-1710.

Circle 250 on Inquiry Card

TIME DELAYS

Range of 0.5 to 300 s.

Designed for on-operate and on-release, these delays provide an output of 10 A res. 115 Vac, 50-60 Hz and operate on inputs of 115 Vac, 50-60 Hz, 24 Vac, 50-60 Hz or 24 Vdc, polarity protected. Accuracy is $\pm 10\%$ of nom. setting over voltage and temp. range, repeatability to 1% within fixed conditions, a single turn pot and a time delay of 0.5 to 100 and 100-300 s over a temp. range of 0° to $+55^\circ\text{C}$. Guardian Electric Mfg. Co. of Calif., Inc., 5755 Camille Ave., Culver City, Calif. 90230. (213) 870-4642.

Circle 251 on Inquiry Card

MOS Clock Driver System

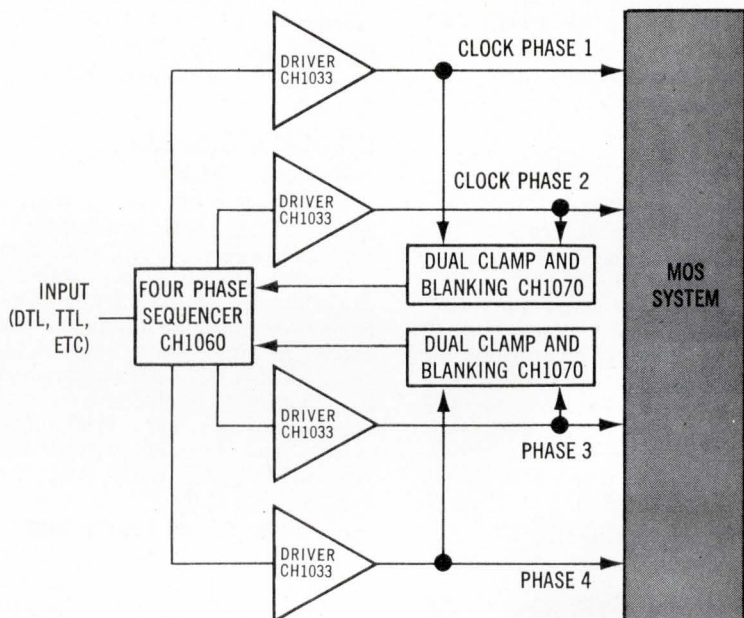

The four phase system shown uses a CH1060 FOUR PHASE SEQUENCER, four CH1033 HIGH SPEED CLOCK DRIVERS and two CH1070 DUAL CLAMP AND BLANKING CIRCUITS.

The SEQUENCER generates four clocks from a single input which minimizes package count. Sequencers can be interconnected to provide 1, 2, 3, 4 or more phases.

The HIGH SPEED CLOCK DRIVER swings -27V into 600 pf in 20 nanoseconds, thereby reducing power consumption at high frequencies.

Other output swings are attainable, including $+5\text{V}$ to -15V , $+13\text{V}$ to -13V and $+13\text{V}$ to 0V . Contact us for details.

CLAMP AND BLANKING CIRCUITS eliminate overshoot and capacitively coupled crosstalk which can produce unreliable MOS operation. They also prevent clock overlap. The amount of non-overlap can be externally adjusted.

We also have data communication circuits, teletype interface circuits, lamp and relay drivers, and a circuit development capability for your custom requirements.

OFF-THE-SHELF HYBRID CIRCUITS FROM



660 National Avenue, Mountain View, California 94040, (415) 969-9433

NEW PRODUCTS

POWER OSCILLATORS

10 MHz to 400 MHz.

PS series oscillators are available to cover the vhf-uhf freq. bands with output power levels to 5 W. Voltage and mechanical tuning are available for bws from 10% to a full octave. An afc control option is also available to lock the power source to an ext. ref. Units operate on -28 Vdc and are about 1 x 1 3/8 x 3 in. Prices start at \$150. EMF Systems Inc., Box 1009, State College, Pa. 16801. (814) 237-6022.

Circle 252 on Inquiry Card

LABEL PRINTER

Prints vinyl cloth labels.

"Mini-labeler," prints repeated numerical codes on self-sticking labels. It offers immediate on-the-spot custom marking in small or large quantities. It can easily be set for printing up to six characters across. Depressing the print lever feeds pre-cut labels printed with the desired codes to identify cables, wires, components, tools, parts and the like. W. H. Brady Co., 726 W. Glendale Ave., Milwaukee, Wis. 53201. (414) 332-8100.

Circle 253 on Inquiry Card

POWER SUPPLY MODULES

Overvoltage protected.

TDM high performance power supply modules and TDMD dual output power supply modules feature built-in over-voltage protection, front panel adjustments, test points and indicator lamps. Uniform dimensions permit rapid fabrication of multiple output power supplies on a single front panel without the need for racks or inter-wiring. Transistor Devices Inc., 85 Horsehill Rd., Cedar Knolls, N.J. 07927. (201) 267-1900.

Circle 254 on Inquiry Card

INSULATING SPRAY

Withstands 30 kV.

New, improved No Arc high voltage insulating spray, is available in an 8 oz. can, leaves a tough, thick, smooth protective red insulating coating that can withstand up to 30,000 V. Thus, it is good for stopping arcing and corona shorts in hv circuits, especially on color chassis. It is also recommended for "potting" components, as well as water-proofing and insulating pc boards and exposed wiring. Chemtronics Inc., 1260 Ralph Ave., Brooklyn, N. Y. 11236.

Circle 255 on Inquiry Card

CLOCK OSCILLATOR

Drives TTL or DTL logic.

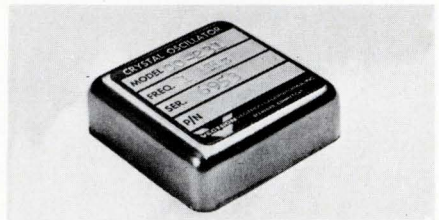

CO-231 Crystal Controlled Clock Oscillator operates from 5 Vdc. It has a stab. of $\pm 0.0025\%$ over 0-70°C for any freq. between 4 kHz and 25 MHz. While the oscillator is factory set to within 0.001% of the specified freq., an optional tuning adjustment lets you set it to within 0.0001%. Designed for PCB mounting it is 1.5 x 1.5 x 0.5 in. Vectron Laboratories, Inc., 121 Water St., Norwalk, Conn. 08854. (203) 853-4433.

Circle 256 on Inquiry Card

CARD PACKAGING SYSTEM

For solderless wrap techniques.

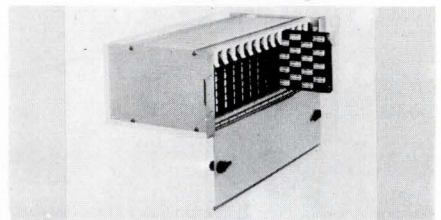

With "Wrap Rack," DILs and discrete components may be integrated into std. card file systems using solderless wrap methods on both the cards and the back panel connectors. Wrap Rack contains 14 circuit cards housed in a std. 5 1/4 in. EIA rack. Cards have 40 16-pin sockets with 0.125 in., three level, "wrap" terminations. Scanbe Mfg. Corp., 35 Fletcher Ave., El Monte, Calif. 91731. (910) 587-3437.

Circle 257 on Inquiry Card

TURNS-COUNTING DIAL

Takes less panel space.

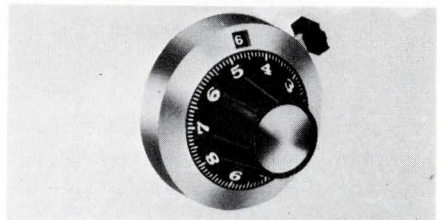

New 10-turn turns-counting dial, principally for use with precision pots has a 1 3/8 in. dia. die-cast housing with only four moving parts. A new dial linkage prevents changeover fouling. The H-510 mounts directly on 1/4 in. and 1/8 in. shafts. Protrusion from the panel is 0.91 in. A brake is std. equipment. \$3.99 (1000-lot quan.). Bourns, Inc., 1200 Columbia Ave., Riverside, Calif. (714) 684-1700.

Circle 258 on Inquiry Card

HIGH DENSITY IC PACKAGING PANEL Modular Type

INCREASES FLEXIBILITY
IN PROTOTYPING,
PRODUCTION AND
FIELD SERVICE.

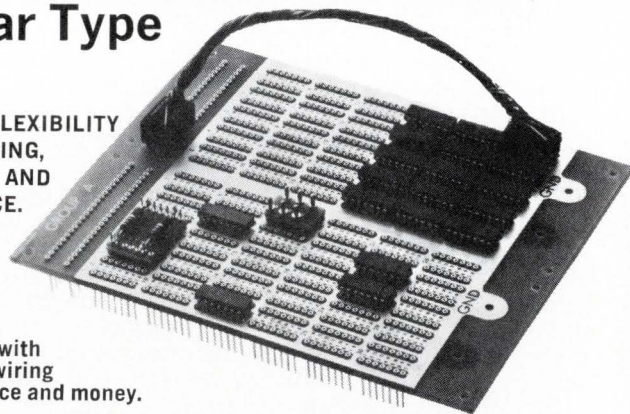

P Series Panel with
Point to Point wiring
saves time, space and money.

- Available in multiples of 30 IC pattern sections up to 180 patterns.
- Two pins of each pattern tied directly to power and ground planes. Different numbers available for different pin assignments.
- IC pattern also accepts I.O. plugs and adaptor plugs for discrete components.
- Excellent contact retention and low contact resistance.
- Wire Wrap terminations with Tri-level connection length.

Request Complete IC Folder

AUGAT INC.

Tel: 617-222-2202
39 Perry Ave., Attleboro, Mass. 02703

MINIATURE SWITCH

For printed circuits.

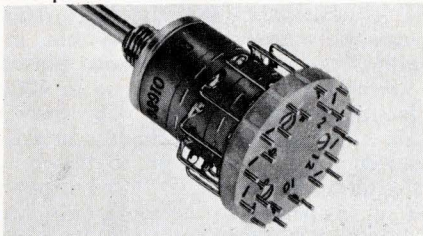

True PCB mounting is now available for miniature rotary switches with more than one deck. This multi deck switch can be plugged directly into a rear mounted PCB since all terminals are axial and at the rear of the switch. Basic envelope is only slightly increased from 0.750 in. dia. to 0.900 in. dia. Life expectancy is 200,000 mechanical operations. RCL Electronics, Inc., 700 S. 21 St., Irvington, N.J. 07111.

Circle 259 on Inquiry Card

LIGHT-EMITTING DIODE

Mounts directly into PC boards.



New OP-100 GaAs diodes, used as discrete devices in light emitter arrays provide the radiant energy for corresponding light-sensor arrays. Radiant pwr. out (P_o) is typ. 2.5 mW/cm² at 50 mA. Peak emission is at 9100 Å. Operating temp. is from -65 to +125°C. \$6.60 ea. (1-99); \$4.40 ea. (100-999). Optron, Inc., 1201 Tappan Circle, Carrollton, Tex. 75006. (214) 242-6571.

Circle 260 on Inquiry Card

COAXIAL SWITCH

High isolation between ports.

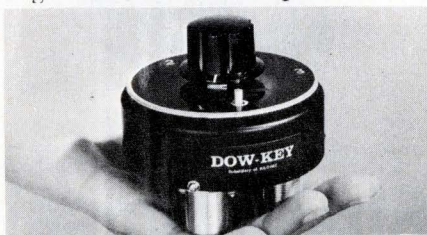

New Series 78 multi-position, single-pole switch, which is manually operated, is usable to 1000 MHz. At 400 MHz, isolation between terminals is 100 dB, min., and vswr is 1.15:1, max. The switch shown (SP3T model) is type #78-0356. Other contact arrangements available are SPDT, SP4T and SP6T. Dow-Key Co., Box 348, Broomfield, Colo. 80020. (303) 466-7303.

Circle 261 on Inquiry Card

hybrids
from
amelco



Now available, our latest hybrid operational amplifier—2741—improves your system's performance by offering the superior quality of the 741 plus:

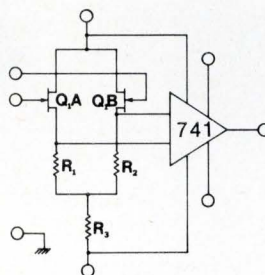

- Low input bias current—40 pA
- Low input offset current—15 pA
- High input impedance—100 KΩ
- Low power dissipation—50mW

For further information contact your nearest Amelco office.

Quality in Quantity
in Hybrids

TELEDYNE
AMELCO SEMICONDUCTOR
1300 Terra Bella Ave., Mountain View, California (415) 968-9241 ■ Westwood, Massachusetts (617) 326-6600 ■ Des Plaines, Illinois (312) 439-3250 ■ Anaheim, California (714) 635-3171 ■ Wiesbaden, Germany 372820.

GRC[®] Intermold[®]



die cast
ZINC ALLOY



molded
PLASTICS

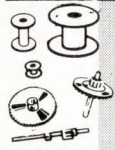

Coil Bobbins
Gears & Pinions

Samples Show How
**NEW MOLDING PROCESS
JOINS 2 DIFFERENT
PLASTICS IN A
SINGLE SMALL PART**

- Combine different colors, physical, chemical properties of different plastics in a single tiny component.
- Movable-element parts, separable parts, two-color parts, numbered and lettered parts, combination-of-materials parts.
- Saves assembly costs, enhances appearance, performance of your product.

Write today for "inter-mold" samples and detailed bulletin.



GRIES REPRODUCER CO.

Division of Coats & Clark Inc.

World's Foremost Producer of Small Die Castings

165 Beechwood Ave., New Rochelle, N.Y. • (914) 633-8600
Plants in: New Rochelle, N.Y.; Warren, R.I.; Toecoa, Ga.

Circle 57 on Inquiry Card

NEW PRODUCTS

RELAY SOCKETS

Track-mounted assemblies.

PC board construction has two four-pole GB-series barrier-type screw terminal blocks and an 8-pin receptacle to accept 2PDT relays with two coil leads. RS16 socket assemblies snap in-or-out of prepunched vinyl track vertically, without disturbing adjacent units. Four foot lengths of track hold up to 22 sockets. \$1.70 ea. with track in lots of 1000. Curtis Development & Mfg. Co., 3250 N. 33rd St., Milwaukee, Wis. 53216.

Circle 262 on Inquiry Card

POWER SUPPLIES

With high current outputs.

"L" Series provides high efficiency with full over voltage and over current protection. Typical of the rating is a 5.0-5.5 V unit rated at 75 A, packaged in a rack panel configuration 3½ in. high. Standard voltages available in five case sizes will be the 5.25 V nom. output, listed above, along with 12.5 and 15.5 V units. \$525. Dynage Inc., 1331 Blue Hills Ave., Bloomfield, Conn. 06002. (203) 243-0315.

Circle 263 on Inquiry Card

CRIMPING SYSTEM

Makes 1000 crimps/hour.

A new packaging concept, which uses the auto/feed crimp system, involves the use of bowl-shaped plastic Vibrapak inserts that hold up to 4000 pin and socket contacts. The inserts are filled with the proper contacts, sealed, labeled, and sent to the user. Contacts are pneumatically fed through a small opening to the tool's crimping system. Buchanan Electrical Products Corp., 1065 Floral Ave., Union, N.J. 07083. (201) 289-8200.

Circle 264 on Inquiry Card

CW TWT AMPLIFIERS

High power out.

These two amplifiers are for use in ground-based communication and radar systems. The VTU-6390A1 operates between 15.0 and 17.2 GHz delivering a min. output of 750 W cw over its operating range. The VTX-6280A1 delivers a min. of 1 kW cw over its operating range of 8.4 to 9.8 GHz. Drive power is 5 W max for both models. Varian, TWT Div., 611 Hansen Way, Palo Alto, Calif. 94303.

Circle 265 on Inquiry Card

Templates

that assure utmost accuracy

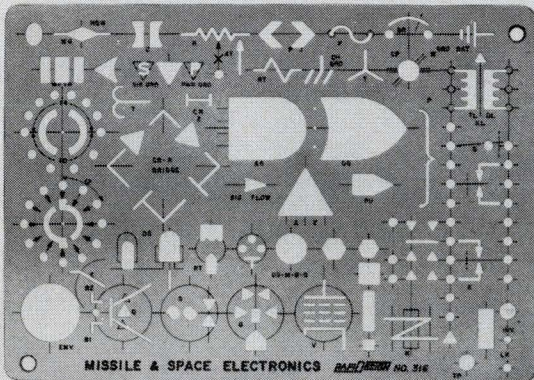

All RapiDesign templates are cut with special equipment and have a 1/64" pencil allowance to assure absolute uniformity and the utmost accuracy. There are nearly 200 different kinds, for electrical, engineering, computer, architectural, and many other uses, including 30 new metric templates. We also make custom designs to order. Send today for your free copy of our 1970 catalog.

RAPIDESIGN INC., P.O. BOX 6039, BURBANK, CALIF. 91505
A SUBSIDIARY OF BEROL CORPORATION

BEROL

RAPIDESIGN[®]
the template for professionals

Circle 58 on Inquiry Card

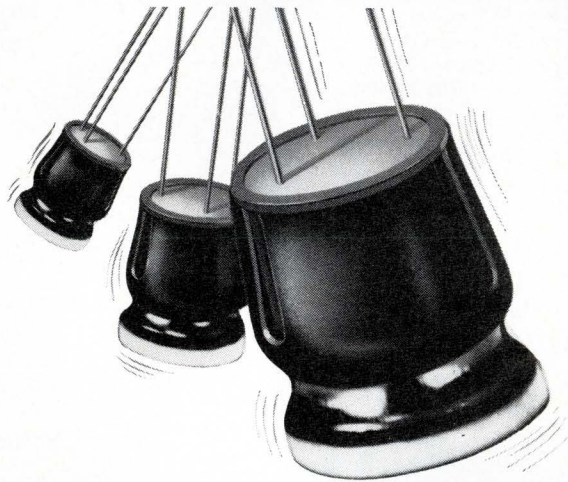

WAKEFIELD CLIP-CUP HEAT SINKS

Won't Shake Loose!

TO-5 and TO-18 case styles are firmly held in position regardless of shocks or vibration. Specially designed beryllium copper fingers provide maximum thermal contact where it counts — near the flange! Available with epoxy or beryllium oxide insulation (for low capacitance requirements) or non-insulated. Stud, tapped or plain are stocked. Noninsulated TO-5 tapped base type 26¢ ea. in 100 lots. Send for Bulletin 260.



DELTA DIV.

WAKEFIELD

ENGINEERING INC., Wakefield, Mass. 01880 • 617-245-5900

Circle 59 on Inquiry Card

PRECISION HV DIVIDERS

For use to 20 kVdc.

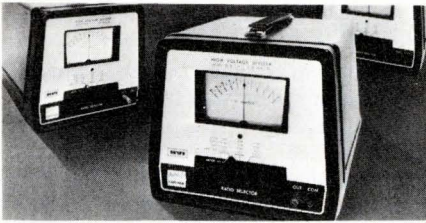

Model HVI voltage dividers have a division ratio accuracy of 0.1% or 0.01% and max. source current drain of 25 to 100 μ A (depending on model). Back-panel input taps are also available for 15, 10, and 5 kVdc. A monitoring meter indicates polarity and approximate magnitude hv input. For accurate measurements a front-panel output tap can be used with a precision pot. Capatron Div. of AMP Incorporated, 155 Park St., Elizabethtown, Pa. 17022.

Circle 266 on Inquiry Card

THUMBWHEEL SWITCH

Only 10 mm wide, houses components.

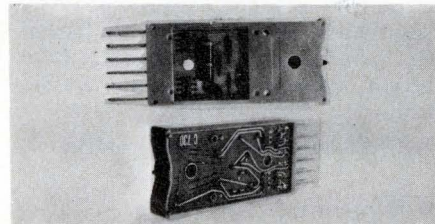

Style C series provides PC card on which you can mount components and IC modules in a variety of useful configurations providing complete logic functions. In a typical setup a total of 16 diodes, resistors, and transistors are used to create an active BCD-coded character generator, programmed decimally by the thumbwheel. Style C can be provided in up to 128 different logic codes. Interswitch, Inc., 770 Airport Blvd., Burlingame, Calif. 94010.

Circle 267 on Inquiry Card

FET OP-AMP

General purpose unit.

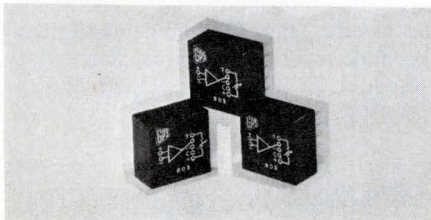

New Model 803 FET differential op amp has bias current of $< 15\text{pA}$, input imp. of $10^{11} \Omega$ and τ_c of $10 \mu\text{V}/^\circ\text{C}$. It also has a slewing rate capability of $10\text{V}/\mu\text{s}$, 20mA output, and the ability to drive a heavy capacitance load without instability. \$60. GPS Corp., 14 Burr St., Framingham, Mass. 01701. (617) 875-0607.

Circle 268 on Inquiry Card

IR SOLID STATE LAMP

Low current operations.

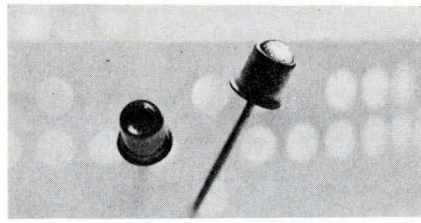

New GaAs light-emitting diode can produce 1 mW infrared output at 20 mA input current. The SSL-315 peaks at 9400°A and with its low current operation is well suited for use with ics in applications including paper tape and card readers, and end-of-tape and begin-of-tape sensing. The IR emitter comes in a package with a diameter of < 0.1 in. \$7.79 (1-9), \$2.79 (10,000 +). General Electric Co., Nela Park, Cleveland, Ohio 44112.

Circle 269 on Inquiry Card

"SNAP-IN" SWITCH

Panel mount, pushbutton style.

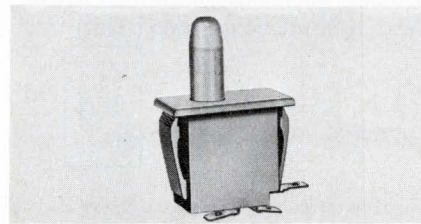

The E69-00A basic momentary action switch comes in SPDT or SPST, either normally open or normally closed. Maximum operating force is 15 oz. It is rated at 10 A, 125/250 Vac. It features the company's coil spring snap-action mechanism and rock-wipe contact action. Samples available on request. Cherry Electrical Products Corp., 1650 Old Deerfield Road, Highland Park, Ill. 60035. (312) 831-2100.

Circle 270 on Inquiry Card

ABSORBER MATERIALS

For microwaves.

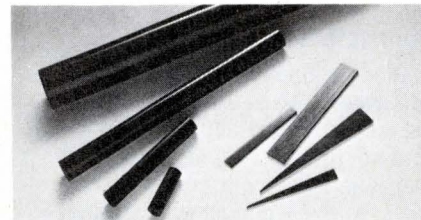

High power and high temp. (over 500°C cont. duty) capabilities and uniformly reproducible electrical characteristics are features of these materials. A std. line of strips to 10 in. and cylinders to 24 in. long is being offered. The Carborundum Co., Electrical and Electronics Branch, Box 367, Niagara Falls, N.Y. 14302.

Circle 271 on Inquiry Card

GLASS ENCLOSED Thermostatic DELAY RELAYS

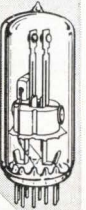

by
AMPERITE

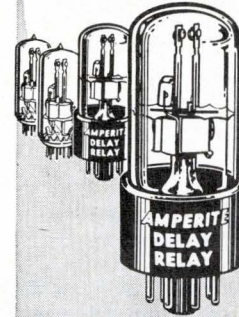

Offer true hermetic sealing — assure maximum stability and life!

Delays: 2 to 180 seconds

Actuated by a heater, they operate on A.C., D.C., or Pulsating Current... Being hermetically sealed, they are not affected by altitude, moisture, or climate changes... SPST only — normally open or normally closed... Compensated for ambient temperature changes from -55° to $+80^\circ\text{C}$... Heaters consume approximately 2 W. and may be operated continuously. The units are rugged, explosion-proof, long-lived, and inexpensive!

TYPES: Standard Radio Octal and 9-Pin Miniature... List Price, \$4.00

PROBLEM? Send for Bulletin No. TR-81.

AMPERITE

BALLAST REGULATORS

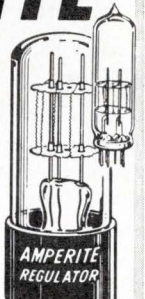

Hermetically sealed, they are not affected by changes in altitude, ambient temperature (-50° to $+70^\circ\text{C}$), or humidity... Rugged, light, compact, most inexpensive.

List Price, \$3.00

Write for
4-page
Technical
Bulletin
No. AB-51

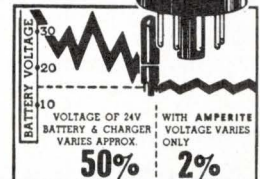

AMPERITE

600 PALISADE AVE., UNION CITY, N.J. 07087

Telephone: 201 UNION 4-9503

In Canada: Atlas Radio Corp., Ltd.,
50 Wingold Ave., Toronto 10

PDP-11 handbook

DEC's newest computer, the PDP-11, as small as the PDP-8, but incorporating a 16-bit word instead of a 12-bit word, is discussed in a 104-page handbook. An overview of the sys-

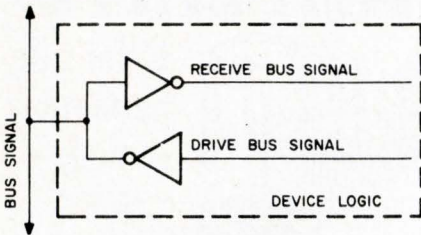

Bidirectional nature of the PDP-11's Unibus

tem's structure is covered, as is input-output programming, peripherals, general interfacing, software and console operation. Digital Equipment Corp., 146 Main St., Maynard, Mass. 07154.

Circle 390 on Inquiry Card

Msi pocket guide

You'll find that you can save a lot of research time when you refer to this handy 100-page pocket guide for easy-to-find data on MSI circuit functions, pin-out and loading rules. The index lists 56 devices covering the company's entire range of MSI building blocks in the 9300 series and MSI support functions in the 9000 and 9600 series. Fairchild Semiconductor, Box 880, Mountain View, Calif. 94040.

Circle 391 on Inquiry Card

Relays

A comprehensive 36-page catalog contains a listing of hundreds of different in-stock types of microminature, subminiature, mercury wetted, differential, stepping and other relays. And most types are available in production quantities. Universal Relay Corp., 42 White St., New York, N.Y. 10013.

Circle 392 on Inquiry Card

Design guide

Now available is a 24-page design guide to show packaging and cable designers how to use flexible etched cables in component and system designs. Graphic examples illustrate good high-density, low-volume interconnection and cable designs. Electro-Mechanisms, 29 Crown St., Nashua, N.H. 03060.

Circle 393 on Inquiry Card

Hybrid Publication

"Hybrid Microelectronics Review" has announced publication of its first monthly newsletter designed to condense the flow of thick/thin film microcircuit information for administrative, marketing, engineering and production managements involved in the hybrid field. The new publication will provide a scanning service, under the direction of a technical review board, summarizing current technical, marketing, financial and production information concerning this exploding technology. \$36.00 annual subscription. Review, Box 11685, Phila., Pa. 19116.

1970 catalog

In addition to giving you a complete, up-to-date listing of this company's products, this 32-page catalog includes technical information on phase measurements, swept frequency

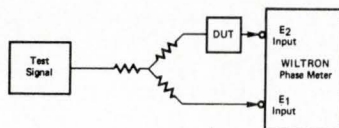
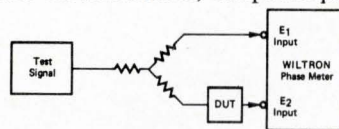

Cancelling effect of distorted test signals

measurements, automatic measurements of vswr, signal generator background information and voice band testing of telephone circuits. Wiltron Co., 930 E. Meadow Dr., Palo Alto, Calif. 94303.

Circle 394 on Inquiry Card

Connectors

Blue Ribbon and Micro Ribbon connectors are the subject of this 12-page brochure. It tells you of a ribbon contact principle used in both types that eliminates bent contacts and provides a self-wiping, self-cleaning action on both contact members. You'll find information on 8- to 32-contact Blue Ribbon units and 14- to 50-contact Micro Ribbon units, including electrical and mechanical specs and performance characteristics. Cinch Mfg. Co., 1501 Morse Ave., Elk Grove Village, Ill. 60007.

Circle 395 on Inquiry Card

Applications

Typical wave analyzer applications are illustrated for you in this 20-page booklet. In each instance, the purpose of the application is stated, the instrument set-up is diagrammed, and the procedure is explained. On the opposite page to all this, you'll find an X-Y graphical recording of the result. Applications include measuring harmonic amplitudes, determining distortion, and comparing filter characteristics. Hewlett-Packard Co., 195 Page Mill Rd., Palo Alto, Calif. 94304.

Circle 396 on Inquiry Card

Computers catalog

Computers available from Raytheon are covered in bulletin SP-335. The company's 700 series, which offers the choice of a central processing unit with either 900-ns, 1.5- μ s, or 1.75- μ s cycle time, is software compatible. Descriptions of conversion equipment are included in the literature. Raytheon Computer, 2700 S. Fairview St., Santa Ana, Calif. 92704.

Circle 397 on Inquiry Card

Triacs

Here's a new line of triacs for ac power control and switching circuits from 1 to 40 A for 50 through 600 V. They're shock- and vibration-proof, available in a wide range of voltage and current and feature static power switching with no contact bounce, arcing or replacement. Hunt Electronics Co., 2617 Andjon Dr., Dallas, Tex. 75220.

Circle 398 on Inquiry Card

Solid state modules

More than just a list of the numerous solid state modules this company has to offer, this 32-page catalog gives thorough specs and performance information on all models and includes

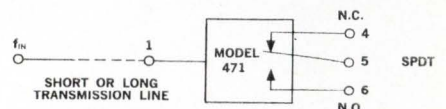

Frequency sensitive control

notes for several significant applications. Application notes are fully illustrated by schematics, and diagrams accompany every model described. Solid State Electronics Corp., 15321 Rayen St., Sepulveda, Calif. 91343.

Circle 399 on Inquiry Card

Teledyne Philbrick Nexus introduces its combination "Hole-in-One" Chopper Stabilized Operational Amplifiers. The 1412 "Mini-Chopper" that is hermetically sealed and the 1701 Low Cost Discrete Chopper Amplifier, both individually designed to meet your most exacting requirements. Looking for a better than par score? Read the card below.

MODEL 1412 "Mini" chopper-stabilized operational amplifier.

- Miniature Size
- Extremely Low Voltage and Current Drift
- Hermetically Sealed Package
- Low Initial Offset Voltage
- High Gain
- Wide Power Supply Range
- Input/Output Protected
- Cost (\$104 in hundreds)

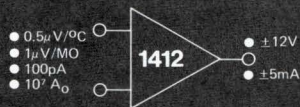

MODEL 1701 Low cost, chopper-stabilized operational amplifier.

- Very Low Voltage and Current Drift
- Low Initial Offset Voltage
- High Gain
- Wide Power Supply Range
- Input/Output Protected
- Low Flicker Noise
- Low Cost (\$49 in hundreds)

Now add up your score card and you'll find that you're a winner when you team up with Teledyne Philbrick Nexus' Analog-State-of-the-Art.

Write today for your free copy of the new 1970 Teledyne Philbrick Nexus Catalog.

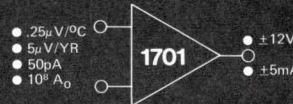

For further information, contact your local Teledyne Philbrick Nexus representative or Teledyne Philbrick Nexus, 67 Allied Drive at Route 128, Dedham, Massachusetts 02026. Telephone: (617)329-1600. Prices F.O.B. Factory U.S.A.



TELEDYNE PHILBRICK NEXUS

No. 1 should do more . . . you expect us to.

Teledyne Philbrick Nexus chopper-stabilized Op Amps reduce your handicap

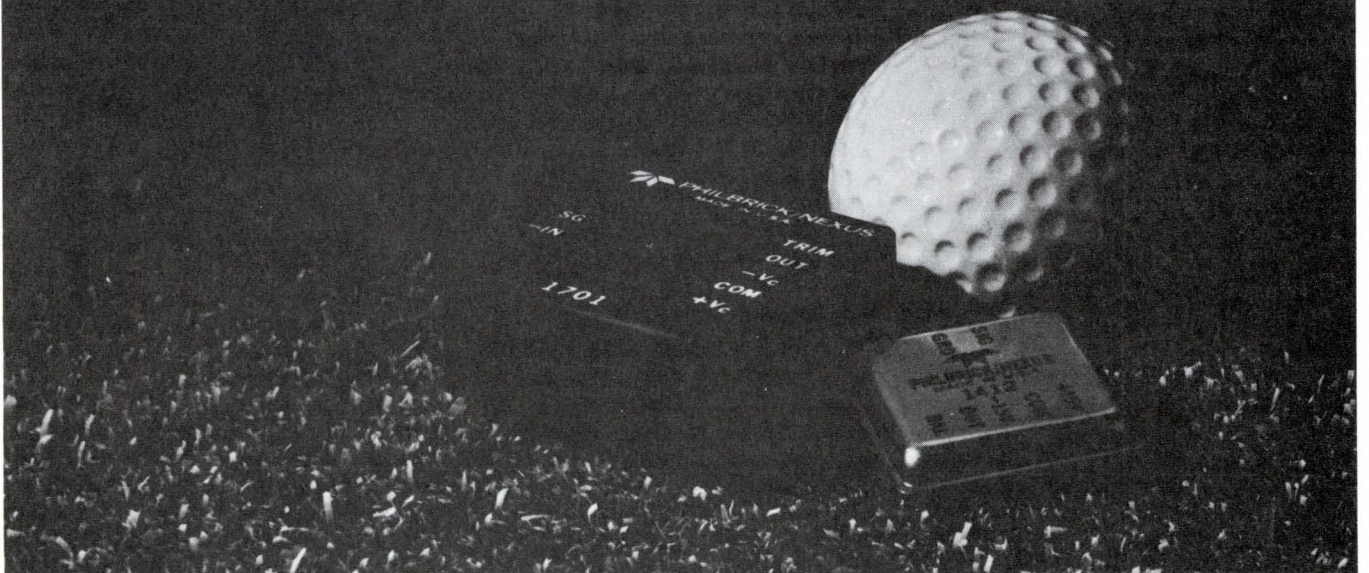

Applications manual

If you're a circuit designer you'll find this 33-page applications manual an excellent reference to circuit structure. It includes sample coupling and blocking oscillator designs, and a nomograph to assist you in selecting

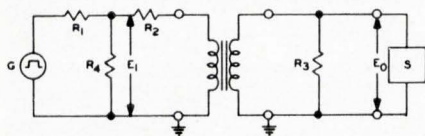

the proper pulse transformer. Inductors and delay lines are shown in circuit illustrations. A spec guideline helps to document your choice. Pulse Engineering Inc., 560 Robert Ave., Santa Clara, Calif. 95050.

Circle 400 on Inquiry Card

Connector chart

This is the follow-up to the resistor selector chart published earlier by this company. It covers PC edge connectors, interconnectors, combination and high-density connectors. It includes information on the varieties of body and contact material, contact and termination styles, contact spacing, the number of connections and the shape of contact springs. Mepco Inc., Columbia Rd., Morristown, N.J. 07960.

Circle 401 on Inquiry Card

Active filters

A data package consisting of data sheets, application notes and general information on the design and selection of active filters has been assembled for you. Three application notes detail the basic analysis of the state variable filter, estimating filter complexity and normalized section tuning for lowpass and highpass filters. Varadyne Inc., 2330 Michigan Ave., Santa Monica, Calif. 90404.

Circle 402 on Inquiry Card

Capacitors

All types of capacitors—polyester film, metalized polyester film, polystyrene and polycarbonate—are described for you in a 16-page catalog. Case types are listed, and photos, dimensional drawings and performance charts supplement the listings with tolerance, temperature range ratings and lead specs where applicable. Standard Condenser Corp., 1065 W. Addison St., Chicago, Ill. 60613.

Circle 403 on Inquiry Card

Design manual

This design manual shows you how to use solid state converter modules to interface a digital systems design with the synchro, resolver and dc analog systems. The 6-page manual illustrates 12 applications of such conversions for you. Transmagnetics Inc., 132-25 Northern Blvd., Flushing, N. Y. 11354.

Circle 404 on Inquiry Card

Correed handbook

"A Guide to Dry Reed Switching" is the title of a 60-page correed handbook designating the advantages of correeds when applied within their specified ratings and with a recognition of their characteristics and limitations. Automatic Electric, Dept. 578, Northlake, Ill. 60164.

Circle 405 on Inquiry Card

Amplifier applications

In addition to the complete characterization of a new series of video amplifiers, this 6-page bulletin provides you with applications for their use. Another set of technical bulletins (16

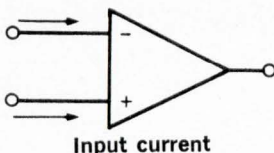

pages in all) gives you complete information on four new voltage comparators. And all information is clearly illustrated with graphs and schematics. Silicon General Inc., 7382 Bolsa Ave., Westminster, Calif. 92683.

Circle 406 on Inquiry Card

Resistors and rheostats

A line of wire-wound resistors and rheostats are discussed in a new 18-page catalog. Complete specs are provided for the entire range of products, and a section discussing a new dual-power rating system is included. Ward Leonard Electric Co., 31 South St., Mt. Vernon, N.Y. 10550.

Circle 407 on Inquiry Card

Applications bulletin

A short bulletin gives you information on selecting a trigger transformer for SCR/triacs. You'll learn a new method for selecting the proper pulse transformer for coupling trigger pulses into the gates of SCR's and triacs. Aries Technology, 1247 El Camino Real, Mountain View, Calif. 94040.

Circle 408 on Inquiry Card

Components catalog

Of particular interest to our international readers will be this 72-page multilingual electronic components catalog written in English and translated into French, German and Spanish. It provides a central source for information on rotary switches, capacitors, packaged electronic circuits and potentiometers. One special section features kits covering each of the general product lines. International Div. Globe Union Inc., 5757 North Green Bay Ave., Milwaukee, Wis. 53201.

Circle 409 on Inquiry Card

Computer capabilities

While you are taken on a tour of this group's computer facilities you will learn of their hardware and software design and manufacturing capabilities. This 12-page brochure introduces you to XLO Computer Systems Group and explains their special interest in mass memory subsystems, software and hardware design, special interfaces and special computer systems. Bryant Computer Prod., 850 Ladd Rd., Walled Lake, Mich. 48088.

Circle 410 on Inquiry Card

Triac applications

Two separate application reports cover triac phase control and triac triggering techniques. Bulletin CA-137 titled "Programmable Trigger Circuit for Triac Phase Control" describes how a trigger circuit, combined with a suitable triac, can regulate ac power by phase control in response to voltage inputs to an operational amplifier.

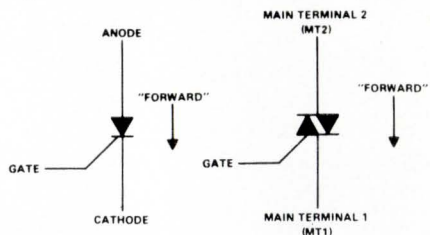

Symbols and conventions for SCR and Triac

Breadboard test results are provided, as are schematics. Application report CA-138, titled "Triac Triggering Techniques" discusses how to accomplish the triac triggering function and offers methods for controlling ac power with triacs. Circuit diagrams are included. Texas Instruments Inc., Inquiry Answering Service, Box 5012, M/S 308, Dallas, Tex. 75222.

Circle 411 on Inquiry Card

How can such a little guy uphold the family reputation?

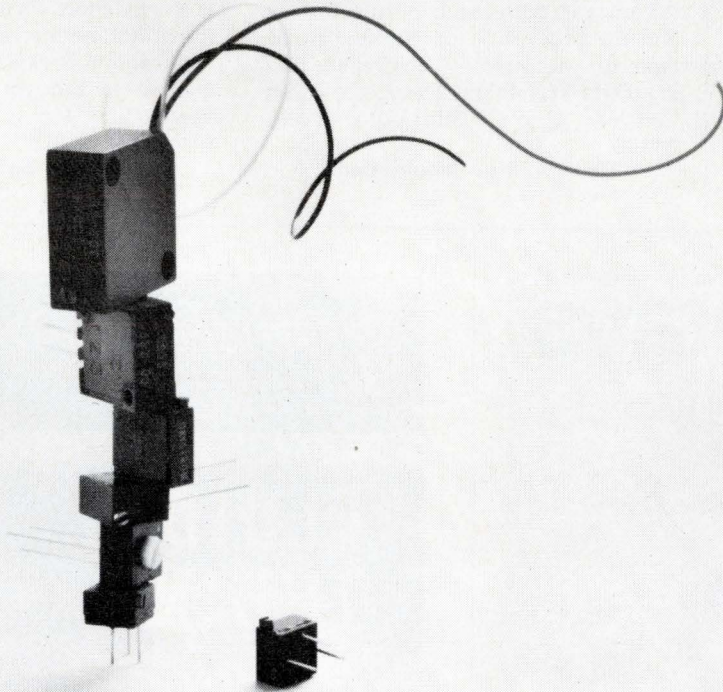

Our new 561/562 series are true Squaretrim® potentiometers down to the last quarter inch. As the smallest members of this distinguished family, they have to live up to a bigger reputation than other pots their size.

They do. We made sure.

We gave them the same high quality element that makes our military pots so reliable . . . the same tight $\pm 5\%$ tolerance . . . the same wide 10 ohms to 20K standard resistance range and -55°C to $+150^{\circ}\text{C}$ temperature

range. We even designed them to meet all environmental requirements of MIL-R-27208, like their larger military brothers.

Models 561 and 562 $\frac{1}{4}$ " Squaretrims are available in three configurations, top or side adjustable, and they give you a generous 13:1 adjustment ratio. You wouldn't expect a general-purpose pot to have all these features and still be reasonably priced. But it's just another example of how our Squaretrim family supports its reputa-

tion as the biggest name in value for the smallest thing in pots.

They're in stock now at Weston Potentiometer distributors. Or ask us about special resistance values, data sheets, evaluation samples.

The little guys.

WESTON COMPONENTS DIVISION,
Archbald, Pennsylvania 18403, Weston
Instruments, Inc. a Schlumberger company

WESTON®

**LOOKING
FOR
THOSE
HARD-TO-GET
SPECIAL AND
DISCONTINUED
TRANSISTORS ...
INCLUDING
PHILCO TYPES?
YOU JUST FOUND THEM!**



All 100% tested . . . guaranteed
& at the Industry's lowest prices.
Write for new catalog and compare



LANSDALE
Transistor & Electronics, Inc.
COLMAR, PENNA. 18915 • 215-855-9002

Circle 62 on Inquiry Card

LITERATURE

Panel instruments

You'll find more than 1,500 stock panel instruments described in this 32-page catalog, and you'll find a number of new instruments being introduced. New instruments include the Century series and the model 2800 digital panel instruments. A characteristics chart and a glossary of terms complete this comprehensive catalog. Simpson Electric Co., 5200 W. Kinzie St., Chicago, Ill. 60644.

Circle 412 on Inquiry Card

Computer-aided logic design

A free-field computer program—design analysis and review techniques (DART)—is introduced to you in a 16-page brochure. It describes the capabilities of DART, emphasizing system analysis and including error detection and correction, documentation and the production of punched paper tape for numerically controlled wiring. Data Technology Corp., 1050 East Meadow Circle, Palo Alto, Calif. 94303.

Circle 413 on Inquiry Card

Digital instrumentation

This young company offers literature (an 8-page essay) on the background behind their founding, and on their featured products, a digital analyzer and a series of probes. Two product brochures give specs and characteristics of their multi-channel digital signal display and the probes designed for exclusive use with this system. Data Display Systems Inc., 139 Terwood Rd., Willow Grove, Pa. 19090.

Circle 414 on Inquiry Card

Resistor handbook

A 1970 handbook on precision and power wire-wound resistors includes up-dated technical information on more than 35 series of wire-wound resistors. Characteristics and specs are given in chart form; graphs illustrate important points; and use in specific applications is explained. The 32-page manual is brought to you by RCL Electronics Inc., 700 S. 21st St., Irvington, N.J. 07111.

Circle 415 on Inquiry Card

rotary relays
by Couch
for rugged reliability
in small space

Simple and reliable in operation . . . made with premium materials and over-size contacts . . . true 1/7th size crystal can relays . . . pull-in sensitivity of 100 milliwatts or less . . . fully tested to military specifications . . . ideal for missile and aerospace applications. Write for new Data Sheet 2X.

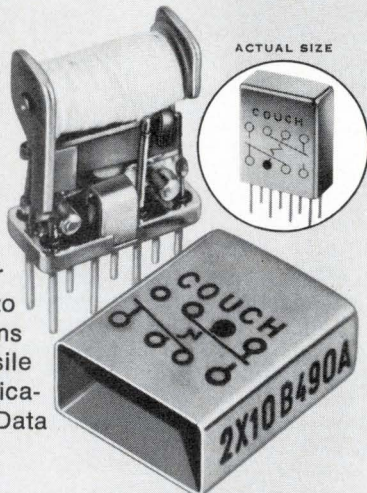

S. H. COUCH DIVISION
ESB INCORPORATED
36 River Street, Boston, Mass. 02126.

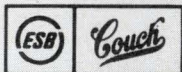

Circle 63 on Inquiry Card

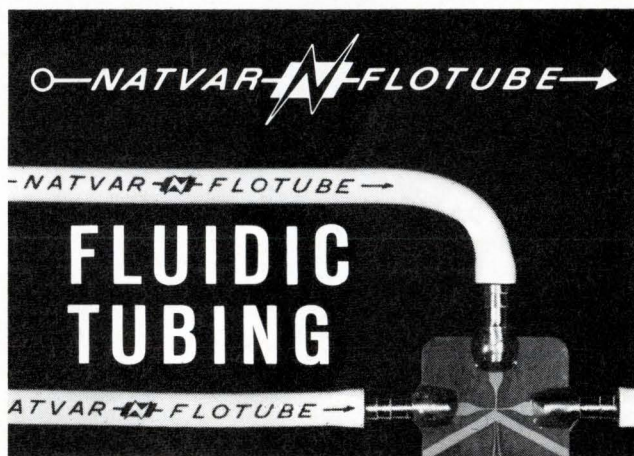

**FLUIDIC
TUBING**

- Tight, leakproof connections
- Won't kink on sharp turns
- Smooth, uniform bore.
- Resists chemicals

Natvar Flotube is a PVC tubing, specially formulated for use in fluidics. The smooth, uniform bore assures uniform impedance and low pressure-drop in fluidic circuits. Holds tight, leakproof connections and won't kink even on small radii. Available in all sizes for the most commonly used devices in clear and colors, with four transparent colors for circuit tracing. Send for technical data and FREE samples.

NATVAR CORPORATION
P. O. BOX 67 • RAHWAY, N. J. 07065

Circle 64 on Inquiry Card

Circuit test system

Although the linear circuit tester itself is not new (about one year old), this new brochure is updated to include several innovations in the system. Aspects of design philosophy help you to understand the significance of the sys-

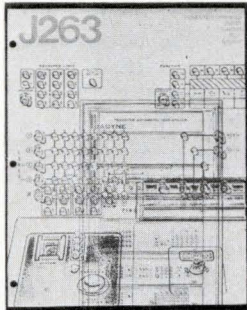

tem's achievements. Both input offset voltages and currents, for example, are measured completely independent of the effect of the other parameter, at any level of source resistance. Tera-dyne, 183 Essex St., Boston, Mass. 02111.

Circle 416 on Inquiry Card

Shielded enclosures

A 4-page data sheet will help you select the correct size rack-mounted enclosure meeting EMI/RFI shielding requirements for 19- and 24-in. cabinets. Engineering drawings show standard enclosures. Shielding information, material specs and a parts list are included. Technical Wire Products Inc., 129 Dermody St., Cranford, N.J. 07016.

Circle 417 on Inquiry Card

Thermistors and varistors

A condensed catalog, designed for electronic engineers and designers, covers a line of solid-state thermistors, varistors and components. Complete



specs are provided in tabular form for the entire series and a short discussion of each product is included. Victory Engineering Corp., Victory Rd., Springfield, N.J. 07081.

Circle 418 on Inquiry Card

Conversion factors

If you're a design engineer, you won't pass this up—it's a conversion factors and formulae booklet (20 pages) that covers all conversions of interest to electronic engineers from "abcoulomb" to "webers," as well as common formulae related to series and parallel circuits. Centralab, 5757 North Green Bay Ave., Milwaukee, Wis. 53201.

Circle 419 on Inquiry Card

ICs and components

Bringing you up-to-date on prices is this complete OEM price list on ICs and discrete semiconductors and components. All special pricing conditions and terms are conveniently cited for you at the opening of the list. Texas Instruments Inc., MS 308, Box 5012, Dallas, Tex. 75222.

Circle 420 on Inquiry Card

Readout tubes

Not only does this quick reference catalog list a complete line of readout tubes with condensed technical information, but it brings you four pages of ratings, characteristics and application notes illustrated with graphs

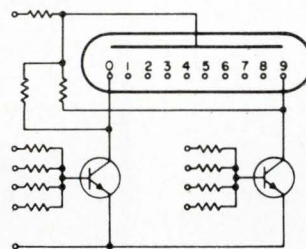

Transistor driving circuit

and circuit diagrams. The 12-page catalog discusses relevant topics such as pre-bias voltage, anode supply voltage, strobe operation and dimming. National Electronics Inc., Subs. of Varian, Geneva, Ill. 60134.

Circle 421 on Inquiry Card

High-technology services

A new series of literature defines the fourth generation computing services provided by this company's Automation Sciences Division (ASD). Two brochures detail ASD's capabilities and experience in Applications Programming and Systems Engineering. A third covers the facilities and services available on a local basis through regional technical application centers. 24 pages in all. General Automation Inc., 706 W. Katella, Orange, Calif.

Circle 422 on Inquiry Card

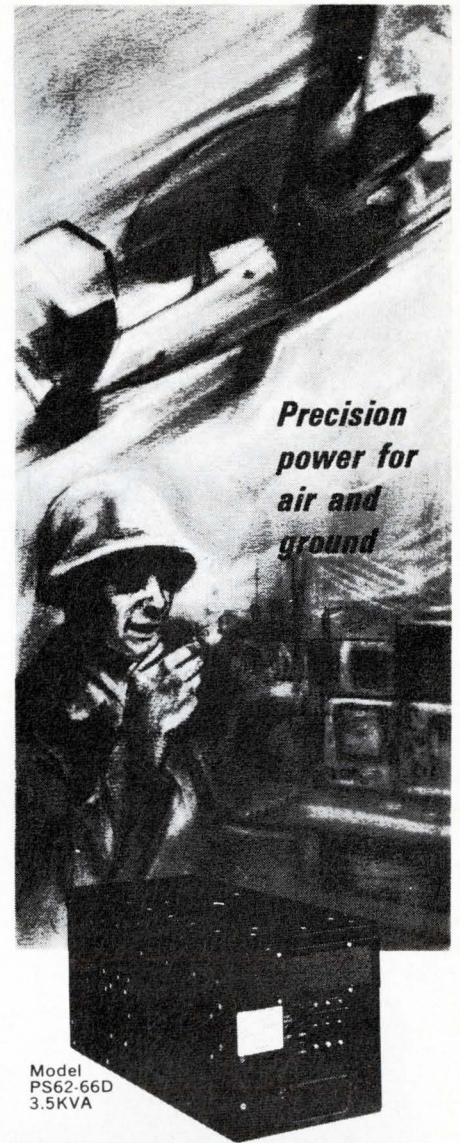

**Precision
power for
air and
ground**

Model
PS62-66D
3.5KVA

UNITRON FREQUENCY CONVERTERS 400 Hz to 60 Hz

3.5 and 8 KVA Sine Wave Outputs

• Complete input and output loading protection • Wide input voltage and frequency variations • Tested to Applicable Environment & RFI Specifications

From Unitron, two all-silicon solid state frequency converters with fourth-generation proven reliability and efficiency.

The design of these units gives an operational flexibility for a wide variety of environments.

Typical applications: Air-transportable equipment requiring precision 60 Hz power, and ground systems where input power is 400 Hz.

Write for complete information.

UNITRON

Division of Electric Machinery Mfg. Company

1624 N. FIRST ST.

GARLAND, TEXAS 75040 (214) 276-8591

Circle 65 on Inquiry Card



NORTON[®]
MAGNETIC HEADS
MULTITRACK
ERASE
RECORD
PLAY

Send now for complete technical literature.

NORTON
 ASSOCIATES, INC.

10 Di Tomas Court, Copiague, N. Y. 11726
 Phone: 516 598-1600

Circle 66 on Inquiry Card

LITERATURE

Videotape applications

Fifty-two closed-circuit video-tape recording equipment applications are detailed for you in this 8-page bulletin. They're divided into user areas—business and industry, government, education and medicine—and they mention particular institutions using each application. A brief history of the company's experience in the field is outlined for you at the beginning of the booklet. Ampex Corp., 2201 Estes Ave., Elk Grove Village, Ill. 60007.

Circle 423 on Inquiry Card

Pin sockets

The latest in plug-in pin sockets, terminals and spring-loaded contacts is brought to you in this 18-page catalog. Over 200 standard styles are now included in the pin socket line; more than 100 standard terminals are fully illustrated. You'll find complete specs on all items with information on finishes, materials and applicable mechanical and electrical test data. Robinson-Nugent Inc., 800 E. Eighth St., New Albany, Ind. 47150.

Circle 424 on Inquiry Card

Interface

The current issue of this bimonthly magazine concentrates on computers in medicine and features an in-depth report on the Miami Heart Institute. It is filled with interesting stories and anecdotes of the modern computer world. "Viewpoint" and "Technology Outlook," for example, provide new outlooks on "what computers are all about" and management in high-technology environments. 26 pages. Xerox Data Systems, A3-43, 701 S. Aviation Blvd., El Segundo, Calif. 90245.

Circle 425 on Inquiry Card

Applications brochure

If you're interested in high-speed data transmission over voice grade facilities you'll want a copy of this 12-page applications brochure on the Sebit-72/96 data sets. It includes items such as theory of operation, applications, actual modem operation, test results and detailed specs, and it's fully illustrated with diagrams and graphs. Rixon Electronics Inc., 2120 Industrial Pkwy., Silver Spring, Md. 20904.

Circle 426 on Inquiry Card

With M-E's ABC modular power supply system you create your own low-cost power supply package. A. Choose from supplies with outputs from 3 to 200 volts. B. Select one of four panel styles in quarter- or half-rack sizes: (1) blank; (2) on-off control with pilot light; (3) metered: volts and amps; or (4) complete with volt and amp meters, on-off control, pilot light, output terminals, and voltage adjust. C. Pick the four-module or eight-module rack.

Send for tech specs on all ABC Series models, panels, and racks.

M Mid-Eastern Industries A Division of Eanco, Inc.
 660 Jerusalem Rd. / Scotch Plains, N.J. 07076 / (201) 233-5900

M-E's new
Pick-Your-Power
Pack. It's simple
as ABC.



108

Circle 67 on Inquiry Card

NPO CHIP CAPACITORS

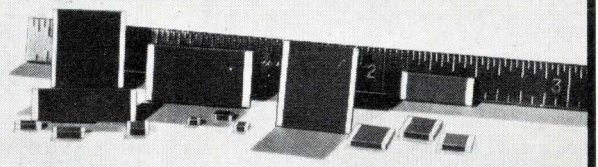

MDI offers 1000 pF

In a standard chip .100" x .050" x .050"

Search no more! They're here! These NPO ceramic multilayer chip capacitors offer the highest capacitance volumetric ratio, coupled with the lowest dissipation factor (less than 0.01% typ.) and highest insulation resistance (greater than one teraohm @ 25°C, and 50,000 megohms @ 125°C). Because they also meet applicable portions of MIL-C-11015 and MIL-C-39014 you can depend on these NPO chip capacitors where reliability and performance really count. Also available in kits... for further information call direct and ask for Jim Waldal.

Monolithic  Dielectrics Inc.

P.O. Box 647 • Burbank, Calif. 91503 • (213) 848-4465

Circle 68 on Inquiry Card

Product capability

A complete "in-house" capability, from design concept, through prototype and production engineering, tooling, manufacturing, assembly and testing, is described for you in a 6-page brochure. Photographs show production facilities and typical operations; products and major items of equipment are listed for you. TMI, 2335 Alaska Ave., El Segundo, Calif. 90245.

Circle 427 on Inquiry Card

IC logic

You'll find this a comprehensive handbook on the Series 54H/74H highspeed TTL IC logic. It's divided into three major sections. The first is on general design characteristics; the second is on electrical characteristics and gives specific test limit and test

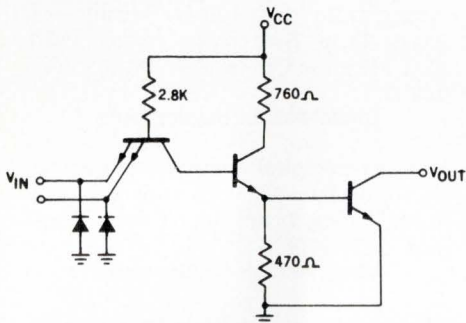

condition information for the evaluation of 52 ICs in this family. The third section, parameter measurement, gives you complete dc and ac measurement methods and procedures. Sprague Electric Co., Marshall St., North Adams, Mass. 01247.

Circle 428 on Inquiry Card

Template catalog

Nearly 200 standard templates, including 30 new metric templates, are pictured and described in a 24-page catalog. For easy reference, they are grouped by types, such as ellipses, electrical, etc. Ordering information is included for your convenience. Rapi-Design Inc., Box 6039, Burbank, Calif. 91505.

Circle 429 on Inquiry Card

Connector catalog

A comprehensive series of rf coaxial connectors are featured in this 48-page catalog. Construction and cable group data are given for 658 items, including plugs, receptacles and accessories, and dimensions are given with a photo-illustration of each item. Kings Electronics Co. Inc., 40 Marbledale Rd., Tuckahoe, N.Y. 10707.

Circle 430 on Inquiry Card

Integrated Circuit mounting without the usual problems

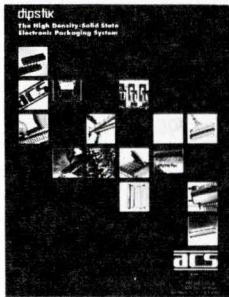

How to mount 5 dual in-lines in a package 1/4th the size of a PC board, without a drop of solder, in about 30 seconds, is covered in the new 16 page DipStik II System brochure. Elimination of PCBs for dual in-lines, 100% test point capability, complete protection for dual in-line leads and bodies, ability to handle discretes where necessary and a full line of mounting hardware and chassis for the system are also covered.

ACS INDUSTRIES

13726 Saticoy St., Van Nuys, Calif. 91402, (213) 988-5310

Circle 140 on Inquiry Card

FOR ELECTRONIC ENGINEERS ON THE WAY UP

A Course in

PROJECT MANAGEMENT

This *Project Management* course appeared originally in *The Electronic Engineer* and was devised for the engineer who wants to grow in his job and to help assure this, the course was developed in collaboration with Booz, Allen and Hamilton, one of the largest management consulting firms in the world. Their experience includes the development of project plans and control systems for over 1,000 projects involving the expenditure of many billions of dollars. **What it does for you**—*Project Management* is a relatively new discipline in the field of management sciences. And the course emphasizes the methods used to reach an objective while remaining within the prescribed product specifications, budget and schedule. It also helps the in-

dividual electronic engineer or manager to increase his personal skills, sharpen his capability and broaden his understanding of project management problems, both large and small. *And, it shows you how to achieve certain specified results at a particular point in time.* It can make you more valuable to your employer.

The 5 part course costs just \$4.00 and includes a test paper for your use. All those passing the examination will receive a Certificate of Completion that is suitable for framing. Why not put this course to work for you now? Send your order to *The Electronic Engineer*, Chestnut and 56th Streets, Philadelphia, Pennsylvania 19139.

NOW AVAILABLE . . .

A Course in

TELEMETRY

A special course on Telemetry is now being offered to all electronic engineers. It appeared originally in *The Electronic Engineer*. The course analyzes the fundamentals of telemetry and describes the function of telemetry equipment. The course consists of several parts, each one patterned after one specific portion of a telemetry system. Today, more than ever before, there is a critical need for more reliable, smaller, lighter *data gathering hardware*. This course provides a sound insight into the modern methods of data acquisition, processing and display and how they are organized. Some of the areas covered are:

- Multiplexers and Encoders
- Analog to Digital conversion
- Demultiplexing and Decoding
- Processing and Display

This course is especially useful to digital designers, design engineers, engineering managers, telemetry engineers, instrument designers and computer designers.

The complete 5 part course is available for just \$4.00 and this includes a test. All those successful in passing the examination will receive a formal Certificate of Completion that is suitable for framing.

To get this course, send your order to *The Electronic Engineer*, Chestnut and 56th Streets, Philadelphia, Pennsylvania 19139.

- Sensors, Transducers and Signal Conditioning

Cool power

Model CP-5-5
Price: \$152.00

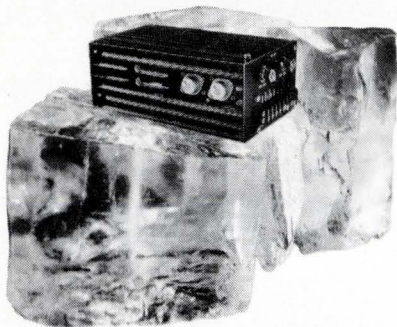

for IC logic

These new power modules from ERA provide *cool performance, total protection* for specialized use in IC, computer, telemetry, strain gauge and transistor applications.

The Transpac CP series is equipped with unique heat sinking for cool (71°C, free air) operation at high currents, protects itself and your equipment through built-in short circuit protection with instant recovery, adjustable current limiting and overvoltage protection.

A special burn-in test program at the factory assures reliability while compact silicon design saves space.

Send for catalog. Write today — before you design.

STANDARD MODELS

Output Voltage VDC	Current @			Model	Price
	50°C	60°C	71°C		
3.6	3.2	2.8	2.5	CP-3P6-2P5	\$131.00
5	3.2	2.8	2.5	CP-5-2P5	\$131.00
3.6	6.5	5.7	5.0	CP-3P6-5	\$152.00
5	6.5	5.7	5.0	CP-5-5	\$152.00
3.6	13.0	11.4	10.0	CP-3P6-10	\$194.00
5	13.0	11.4	10.0	CP-5-10	\$194.00
3.6	22.0	19.5	17.0	CP-3P6-17	\$241.00
5	22.0	19.5	17.0	CP-5-17	\$241.00
3.6	32.0	28.5	25.0	CP-3P6-25	\$325.00
5	32.0	28.5	25.0	CP-5-25	\$325.00



ERA TRANSPAC CORPORATION

A Subsidiary of
Electronic Research Associates, Inc.
67 Sand Park Road, Cedar Grove, N.J. 07009
(201) 239-3000

Circle 69 on Inquiry Card

LITERATURE

Analog-to-digital converters, 10-, 12- and 13-bit binary with and without amplifier inputs—4 pages. Data Technology Corp., 1050 East Meadow Circle, Palo Alto, Calif. 94303.

Circle 431 on Inquiry Card

Broadband power amplifier covers frequency range of 250 KHz to 110 MHz—2 pages. Electronic Navigation Ind. Inc., 1337 Main St. East, Rochester, N.Y. 14609.

Circle 432 on Inquiry Card

Selection guide for zener and voltage reference diodes identifies each model by voltage, current and impedance capabilities—6 pages. Fairchild Semiconductor, 313 Fairchild Dr., Mountain View, Calif. 94040.

Circle 433 on Inquiry Card

Capacitors, dc blocking and rf, are of integral construction and predictable capacitance without hot spots or corona paths. Polyflon Corp., New Rochelle, N.Y.

Circle 434 on Inquiry Card

Radial lead resistors for pc boards are 3- and 5/4-W wirewound and fit standard 0.1 in. matrix boards. Ohmite Mfg. Co., 3601 Howard St., Skokie, Ill. 60076.

Circle 435 on Inquiry Card

Power supplies feature voltage and current regulation, ic modular construction, remote voltage programming and error sensing—2 pages. Beco Solid State Systems, Box 686, Salem, Va. 24153.

Circle 436 on Inquiry Card

ECL basic gates, seven basic modules in TI's ECL2500 ic series for application in ultra-high speed digital systems—12 pages. Texas Instruments Inc., Box 5012, M/S 308, Dallas, Tex. 75222.

Circle 437 on Inquiry Card

Single diode oscillators available in fixed frequency or tunable versions in the frequency range 6.0 to 10.0 GHz—4 pages. Varian, Solid State Div., Salem Rd., Beverly, Mass. 01915.

Circle 438 on Inquiry Card

Product reference guide briefly describes function modules, analog systems and instrumentation as related to process control—4 pages. Bell & Howell Co., 706 Bostwick Ave., Bridgeport, Conn. 06605.

Circle 439 on Inquiry Card

Pressure-sensitive transducers with 1/10-, 1/4-, 1/2-, 1-, 2- and 5-psid ranges—6 data sheets. Stow Laboratories Inc., Hudson, Mass. 07149.

Circle 440 on Inquiry Card

Solid-state time delay relay brochure includes circuit applications and definitions of time delay relay terms—8 pages. Midtex/Aemco Inc., 10 State St., Mankato, Minn. 56001.

Circle 441 on Inquiry Card

Chip block diode may be soldered into thick- and thin-film hybrid circuits and pc boards by re-flow solder methods—2 pages. ASC Microelectronics, Danbury, Conn. 06810.

Circle 442 on Inquiry Card

Multiplexer input connector and limiter with new design approach allows separation of low-level analog signal wiring from digital logic wiring—4 pages. Data Technology Corp., 1050 East Meadow Circle, Palo Alto, Calif. 94303.

Circle 443 on Inquiry Card

Synchro-to-digital converter eliminates electromechanical angle indicators—2 pages. Theta Instrument Corp., Fairfield, N.J. 07006.

Circle 444 on Inquiry Card

Rf generator is discussed in terms of ratings and specs showing output and input in the 5- and 7.5-kW range—2 pages. Lindberg Hevi-Duty, 2450 W. Hubbard St., Chicago, Ill. 60612.

Circle 445 on Inquiry Card

EMI/RFI shielding materials and components—five fast and effective ways to prevent EMI/RFI—8 pages. Metex Corp., 970 New Durham Rd., Edison, N.J. 08817.

Circle 446 on Inquiry Card

Frequency to dc converter of completely solid-state silicon semiconductor design—2 pages. Solid State Electronics Corp., 15321 Rayen St., Sepulveda, Calif. 91343.

Circle 447 on Inquiry Card

Circuit breaker boots shield circuit breakers and panel openings in exposed panel installations—2 pages. APM-Hexseal Corp., 44 Honeck St., Englewood, N.J. 07631.

Circle 448 on Inquiry Card

Right angle male connector for pc boards conforms to revision "K" of Mil-E-5400—2 pages. Hugh H. Eby Co., 4701 Germantown Ave., Phila., Pa. 19144.

Circle 449 on Inquiry Card

Advertisers—May 1970



No liability is assumed for errors or omissions.
This index is published for a convenience.

ACDC ELECTRONICS	80
Rose Assoc.	
ACOPIAN CORP.	84
Mort Barish Assoc.	
ACS INDUSTRIES	109
Larry Courtney Co.	
ADAMS & WESTLAKE	48
Jaji Herbert	
ADAR ASSOC., INC.	50
Van Christo Assoc., Inc.	
AMELCO SEMICONDUCTOR	99
Monda McCarter & Smith	
AMERICAN MACHINE & FOUNDRY CO.	
POTTER & BRUMFIELD DIV.	25
Grant, Wright & Baker, Inc.	
AMPERITE CO.	101
H. J. Gold Co.	
APPLICON, INC.	5
Advertising Assistance, Inc.	
AUGAT, INC.	98
Horton, Church & Goff, Inc.	
BECKMAN INSTRUMENTS, INC.	
HELIPOT DIV.	66
N. W. Ayer/Jorgensen/Macdonald, Inc.	
BEDE ELECTRICAL INSTRUMENT CO.	85
Weston Assoc., Inc.	
BISHOP GRAPHICS, INC.	4
Sol R. Shein Adv.	
BUSSMANN MFG. DIV.	76
Henderson Adv. Co.	
CALMA CO.	88, C-16
Miller/Stoll Adv.	
CERMETEK, INC.	97
Hal Lawrence, Inc.	
CHRONETICS, INC.	29
j. s. lanza & assoc.	
COMPUTER MEASUREMENTS CO.	
DIV. NEWELL INDUSTRIES	49
Jones, Maher, Roberts, Inc.	
COORS PORCELAIN	Inside Back Cover
Buchen Adv., Inc.	
COUCH ORDNANCE	106
Culver Adv., Inc.	
DAVEN DIV.	95
N. H. Miller & Co., Inc.	
DYNATRONICS OPERATION, ELECTRONICS	
DIV GENERAL DYNAMICS CORP.	91
Neals & Hickok, Inc.	
ELCO CORP.	45
Schaefer Advertising Inc.	
ELECTRO-MOTIVE CO.	79
Culver Adv., Inc.	
ELECTRONIC GRAPHICS, INC.	88
The Hal Mayer Co.	
ERA TRANSPAC CORP.	110
Josephson, Cuffari & Co.	
FAIRCHILD SEMICONDUCTOR	20, 21
Chiat/Day, Inc.	
FERROXUCUBE CORP.	13
W. H. Schneider, Inc.	
GENERAL INSTRUMENT CORP.	
SEMI. ASSEMBLY DIV.	26
Norman Allen Assoc., Inc.	
GRAYHILL, INC.	4
Carr Liggett Adv., Inc.	
GRIES REPRODUCER CO.	100
Harold Marshall Adv., Co., Inc.	
HAMILTON WATCH CO.	59
Beaumont, Heller & Sperling, Inc.	
HEWLETT-PACKARD CO.	
COLORADO SPRINGS DIV.	Inside Front Cover
Tallant/Yates Adv., Inc.	
INSTRUMENT PRDTS., DIV. 3M CO.	22
Reach, McClinton & Co., Inc.	
INTERPLEX	88, C-15
The Strayton Corp.	
LANSDALE TRANSISTOR & ELECTRONICS, INC.	106
Product Promotions Agency, Inc.	
LEACH CORP.	16A, 16B
Chiat/Day, Inc.	

MATHESON GAS PRDTS., DIV. WILL ROSS, INC.	40
Cooper, Strock & Scannell, Inc.	
MELLONICS	69
Diener & Dorskind (WEST) Adv.	
MID-EASTERN INDUSTRIES	
DIV. EANCO, INC.	108
Halloff & Caine Assoc.	
MILLER-STEPHENSON	91
Michel-Cather, Inc.	
3-M CO., FILM & ALLIED PRDTS., DIV.	39, 96
Young & Rubicam, Inc.	
MONOLITHIC DIELECTRICS, INC.	108
Eastman Adv.	
MONROE, THE CALCULATOR CO.	
DIV. LITTON INDUSTRIES	6, 7
Baker & Hartel, Inc.	
MOTOROLA SEMI. PRDTS., INC.	14, 15
Lane & Wampler Adv., Inc.	
NATIONAL ELECTRONICS, INC.	
SUB. VARIAN ASSOC.	93
Connor-Sager Assoc., Inc.	
NATIONAL SEMICONDUCTOR	71, 72
Hall Butler Blatherwick, Inc.	
NATVAR CORP.	106
Sanger-Funnell, Inc.	
NORTH ELECTRIC CO.	46, 47
Marc Assoc.	
NORTON ASSOC., INC.	108
J. J. Coppo Co., Inc.	
PHILCO-FORD CORP.	42, 43
Aitkin-Kynett Co., Inc.	
POTTER & BRUMFIELD DIV.	
AMERICAN MACHINE & FOUNDRY CO.	25
Grant, Wright & Baker, Inc.	
RAPIDESIGN, INC.	100
Harry G. Willis & Assoc., Inc.	
RAYTHEON SEMICONDUCTOR	74, 75
Tycer Assoc.	
RCA ELECTRONIC COMPONENTS	
TEST EQUIPMENT	24
DIGITAL INTEGRATED CIRCUITS	56
POWER TRANSISTORS	Back Cover
Al Paul Lefton Co., Inc.	
RFL INDUSTRIES	92
Josephson, Cuffari & Co.	
SCIENTIFIC-ATLANTA, INC.	23
Now	
SPECTROL ELECTRONICS CORP.	28
Jones, Maher, Roberts, Inc.	
SPRAGUE ELECTRIC CO.	
CAPACITOR DIV.	1
The Harry P. Bridge Co.	
SYLVANIA, PARTS DIV.	35-38
Doyle Dane Bernbach, Inc.	
TELEDYNE PHILBRICK NEXUS	103
Renaccio Adv., Inc.	
TELEDYNE RELAYS	11
S. Michelson Adv.	
TERADYNE, INC.	8
Quinn & Johnson, Inc.	
TEXAS INSTRUMENTS, INC.	
COMPONENTS GROUP	41
Albert Frank-Guenter Law, Inc.	
TRIAD DISTRIBUTOR	
DIV. LITTON INDUSTRIES	44
MacManus, John & Adams, Inc.	
TUNG-SOL, DIV. WAGNER ELECTRIC	
CORP.	27
Winius-Brandon Co.	
UNION CARBIDE CORP.	83
Windfield, Inc.	
UNITRODE CORP.	19
The Siltan Co., Inc.	
UNITRON	107
Warren Assoc.	
VARIAN ASSOCIATES	87
Botsford, Constantine & McCarty, Inc.	
VIDAR CORP.	2
Bill Fisher Adv.	
WAKEFIELD ENGINEERING, INC.	100
Robert Robotham Adv.	
WATKINS-JOHNSON CO.	60
William C. Estler	
WESTON INSTRUMENTS, INC.	
ARCHBALD DIV.	105
Arndt-Preston-Chapin-Lamb & Keen, Inc.	

DISTRICT SALES MANAGERS

EDWARD G. SHAUD	
BALA-CYNWYD, (Pa.) 19004	
One Decker Square	
(Area Code 215) Sherwood 8-2000	
JOSEPH DRUCKER	
NEW YORK 10017—100 East 42nd St.	
(Area Code 212) Oxford 7-3400	
JOHN W. BERNHARDT	
CHICAGO 60606—120 S. Riverside	
Plaza	
(Area Code 312) 782-1400	
G. T. ALFANO	
NEEDHAM HEIGHTS, MASS. 02194—	
570 Hillside Ave.	
(Area Code 617) 444-0010	
TERRENCE D. BUCKLEY	
THOMAS R. BORIS	
LOS ANGELES 90005—3727 W.	
Sixth St., #202	
(Area Code 213) DUNkirk 7-1271	
RALPH PETERSEN	
LOS ALTOS (San Francisco) 94022	
199 First St., Room 335	
(Area Code 415) 941-6655	
RICHARD DUTE	
CLEVELAND 44114—601 Rockwell Ave.	
(Area Code 216) SUperior 1-2860	
FRANK A. SMITH	
HOLLYWOOD, FLA. 33020—	
2419 Hollywood Blvd.	
(Area Code 305) 927-7829	
NEWTON B. COLLINSON	
ATLANTA 30309—1776 Peachtree St.	
N.W.	
(Area Code 404) 872-4723	
HAROLD E. MOTT	
WAYNE L. LOVING	
DALLAS 75206—Meadows Bldg.	
Expressway at Milton	
(Area Code 214) EMerson 3-6426	
BRENT GILBERT	
BELLAIRE, (Texas) 77401	
P.O. Box 160	
(Area Code 713) 621-7550	
INTERNATIONAL BUSINESS OFFICES	
London, S.W. 1	Max F. Holsinger
67 68 Jermyn St., St. James's	Dir. European Sales
TRA 6318 9	Roy V.C. Hall, A. Berg
Cables	WHIP LONDON S.W. 1
Manchester 22	D. I. Goulden
Haletop, Wythenshawe Civic Centre	MERCURY 3292
4 Dusseldorf-Rath	E. Hillerbrand, R. Schomburg,
Ertelstrasse 32	W. Heckelmann
Dusseldorf 632031	
Cables	WHIP DUSSELDORF
Paris, 8e	S. Brown-Joussard
70 Rue de Ponthieu	ELYsees 65-77
Cables	UIIP PARIS 16e
Tokyo	C.T. Sakaguchi
Room 814, Togin Bldg. Marunouchi	
CPO Box No. 1572	Tel: 211-3506-3509
Cables	CLARENCE SAKA TOKYO
BUSINESS STAFF	
K. ROBERT BRINK	Publisher
STEPHEN A. FARKAS	Sales/Service Director
DENNIS J. PERKINS	Promotion Manager
MARK R. WERTH	Marketing Services Manager
JOHN E. JAENISCH	Advertising Sales Manager
PAT KAUFFMAN	Production Manager
WILLIAM M. COFFEY	Circulation Director
JAMES F. NAGY	Circulation Manager
JOSEPH P. BABCOCK	Reader Service Manager
JOHN H. KOFRON	Chilton Research Services
C. R. WILHIDE	Washington Vice-President



number

Coors Porcelain Company is the Number 1 producer of high-alumina ceramics and a major producer of alumina-ceramic substrates for thick- and thin-film circuits. This produces a number of benefits for you. Namely:

LOW COST—Whether your substrate order is large or small, you'll always find fair, competitive prices at Coors.

QUICK DELIVERY—Large-quantity substrate orders normally require only 6 to 8 weeks to complete. Small orders and prototype quantities usually take 2 weeks or less. Stocked blanks are shipped within 48 hours.

HIGHEST QUALITY—Coors has long been known as *the quality* manufacturer of technical ceramics. This means you can be sure Coors substrates will have uniform surfaces, precise dimensions,

maximum strength, maximum flatness, minimum camber, minimum waviness.

Coors can produce substrates to your specifications from either glazed or unglazed 96% alumina ceramic or unglazed 99.5% alumina ceramic. Both of these ceramics are dense, impervious, resistant to high temperatures, easily metallized, and have excellent electrical-insulation characteristics and good heat-transfer properties.

For details on Coors ceramic substrates, send for Bulletin 1400. Coors Porcelain Company, 600 Ninth Street, Golden, Colorado 80401.

Coors/CERAMICS

Circle 2 on Inquiry Card

Have symmetry reflected
HAVE SYMMETRY REFLECTED

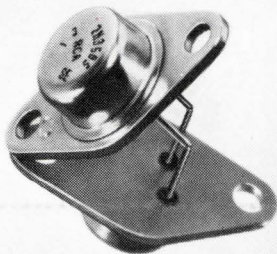

in your high-voltage designs with complementary pairs from RCA

Here's news for designers who have been waiting for high-voltage complements. RCA announces the TA7410, a new high-voltage silicon power transistor which extends the capability of RCA's whole new generation of p-n-p/n-p-n devices.

Featuring high-breakdown voltages and fast-switching, the TA7410 will be one of the most important transistors in a wide range of commercial, industrial, and military circuits...especially those using complementary pairs.

With new advantages from complementary high-voltage pairs you can:

- Obtain low output impedance at both + and - terminals with symmetrical series regulators
- Eliminate the destructive effects of leakage inductance in push-pull inverters
- Design line-operated, complementary linear amplifiers
- Create new complementary high-voltage switching inverters.

TA7410 is a p-n-p complement of the well-accepted 2N3585. Its companion type, TA7719, is a complement to 2N3584. TA7410 features a V_{CEO} of -300 V while TA7719 has a V_{CEO} of -250 V. Both are realistically specified for minimum betas of 20 at 1 A, and feature rise and fall times of 0.6 μ s maximum.

Let TA7410 and TA7719 complement your designs with their compact hermetically-sealed TO-66 packages. They represent the newest in a series of high-voltage complementary pairs that started with the 2N3440/2N5415—the industry's first such units (in hermetic TO-5 packages).

For more information, consult your local RCA Representative or your RCA Distributor. For technical data, write: RCA Electronic Components, Commercial Engineering, Section 1J5 /UT9, Harrison, N.J. 07029. In Europe: RCA International Marketing S.A., 2-4 rue du Lièvre, 1227 Geneva, Switzerland.

RCA

Circle 3 on Inquiry Card