



CC's Whang on interconnection: Some modems more equal?

CHILTON'S THE ELECTRONIC ENGINEER

VOL. 30 NO. 12
DECEMBER 1971

**Data terminals course—
What's in the future?**

**Eight-hundred engineers
design the ideal memory**

**Plus, the regular Data
Communications section**

Interface design problems? Ease them with these new ICs.





Look at Acopian's new mini-module dc power supplies

Look at their size. Single output models (there are duals, too) are as small as 2.32" x 1.82" x 1.00". And they can all be soldered directly into printed circuit boards.

Look at their performance. Load and line regulation is 0.02 to 0.1% depending on the model selected. Ripple is only 0.5 mv RMS. And Acopian's long experience in power supply technology assures high reliability.

Look at the choice of outputs. There are 58 different single output modules ranging from 1 to 28 volts, 40 ma to 500 ma. Duals are available in 406 different combinations

of voltages. And these are **true** dual power supplies, with like or different outputs in each section that are electrically independent of each other. Perfect for powering operational amplifiers. Or for unbalanced loads.

Acopian mini-module power supplies		
	Singles	Duals
Output Voltages (vdc):	1 to 28	1 to 28
Output Currents (ma):	40 to 500	40 to 250
Line and Load Regulation:	.02 to 0.1% depending on model	
Ripple:	0.5 mv RMS	
Ambient Temperature (without derating)	0 to 55°C	
Polarity:	outputs floating and isolated	

Look at their price. Single output models start at \$39, duals at \$58.

For a look at all the facts, write or call Acopian Corp., Easton, Pa. 18042. And just like Acopian's other 82,000 power supplies, every mini-module is shipped with a tag that looks like this . . .



Circle Reader Service #1

Sperry displays are available in 3 digit, 2 digit, and 1½ (7 segment character and a 1 with + and -) digit models in both ½" and ¼" sizes.



Compare portable displays

If you think that LED's, phosphor / fluorescent displays are the only one's you can logically use in your portable equipment, you better take a close comparison look at Sperry. The facts speak for themselves:

COMPARE READABILITY . . . a must requirement. Sperry displays† can be read in direct sunlight. Try the others.



85mW 100mW 500mW

COMPARE POWER . . . a very important factor. ¼ inch LED's normally require over 500mW. ½" phosphor/fluorescent devices normally require over 100mW. Because Sperry displays are so bright to begin with, they can go all the way down to 85mW without affecting readability. What about voltage? A simple, inexpensive DC/DC converter takes the battery voltage up to the 170 volts required to operate Sperry displays.

COMPARE RELIABILITY . . . simplicity is the key. Sperry displays are used aboard the Boeing 747. Need we say more.



COMPARE SIZE . . . it's the housing to character size ratio that counts. Which display do you want in your portable equipment?



Sperry ½"

Sperry ¼"

LED ¼"

tube ½"

Add these Sperry advantages to continuous unbroken figures and a low cost of \$2.30* per digit for either the ½" and ¼" device and you can end the comparison and specify Sperry — the right displays for your portable equipment or any gear. Get the whole story on Sperry displays by requesting complete technical information using this publication's reader service card or phone or write: Sperry Information Displays Division, Post Office Box 3579, Scottsdale, Arizona 85257, Telephone (602) 947-8371

SPERRY
INFORMATION DISPLAYS

It's a whole new ball game in display devices!

 SPERRY RAND

†Patent Pending *Based on 5,000 digit quantity.

Circle Reader Service #2

TR1402A...

ASYNCHRONOUS DATA COMMUNICATIONS ON ONE MOS/LSI CHIP THAT REPLACES OVER 50 TTL'S IN YOUR PRESENT SYSTEM.

TR1402A PROGRAMMABLE ASYNCHRONOUS RECEIVER/TRANSMITTER

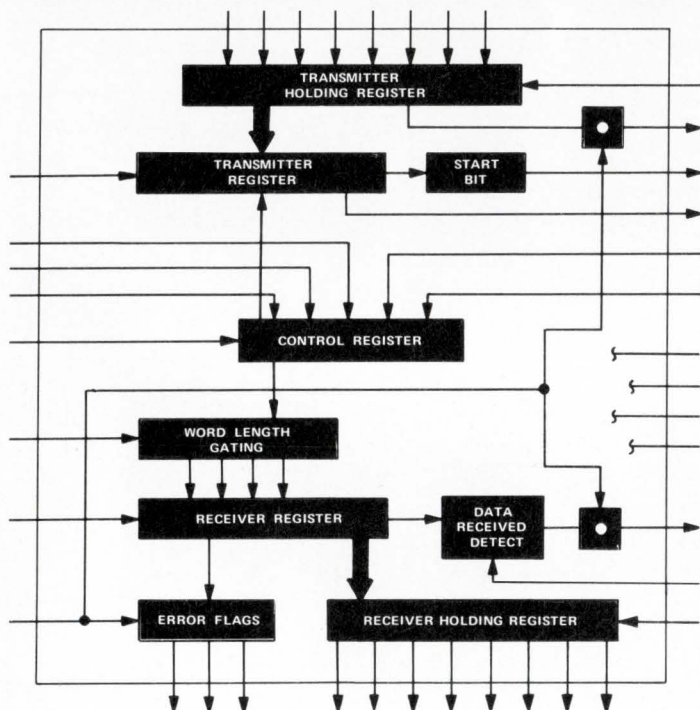

- Fully TTL/DTL Compatible
- MOS Silicon Gate-to 25K Baud

The ASYNCHRONOUS RECEIVER/TRANSMITTER is an MOS/LSI Silicon Gate, programmable MOS/LSI device for interfacing an asynchronous serial data channel of a peripheral or terminal with parallel data of a computer or terminal. The transmitter section converts parallel data into a serial word which contains the data along with start, parity, and stop bits. The receiver section converts a serial word with start, data, parity and stop bits, into parallel data and it verifies proper code transmission by checking parity and receipt of a valid stop bit. Both the receiver and the transmitter are double buffered. The array is compatible with bipolar logic. The array may be programmed as follows: The word length can be either 5, 6, 7, or 8 bits; parity generation and checking may be inhibited; the parity may be even or odd; and the number of stop bits may be either one or two.

- AUTOMATIC START BIT AND STATUS FLAG GENERATION
- TRI-STATE RECEIVER AND STATUS FLAG OUTPUTS
- PROGRAMMABLE
 - WORD LENGTH
 - PARITY/INHIBIT
 - STOP BIT LENGTH

We're in volume production.
Order your MOS/LSI devices now.

APPLICATIONS

Peripherals
Terminals
Mini Computers
Facsimile Transmission
Modems
Concentrators
Asynchronous Data Multiplexers
Time Share Systems
Tape Punches
Card & Tape Readers
Teleprinters & Line Printers
Data Sets
Controllers

Keyboard Encoders
Remote Data Acquisition Systems
Asynchronous Data Cassettes
Numerically Controlled Machine Tools
Communication Interface
Line Concentrators
Credit Verifiers
Optical Readers
Key To Tape & Card Systems
Remote CRT Displays
Digital Pattern Generators
Disc Storage Systems
Programmable Test Equipment

WESTERN  **DIGITAL**

C O R P O R A T I O N

19242 RED HILL AVENUE

BOX 2180

NEWPORT BEACH, CALIFORNIA 92663

(714) 557-3550

TWX-910-595-1139

THE ELECTRONIC ENGINEER

December 1971 Vol. 30 No. 12

Cover: top left. No shrinking violet when it comes to taking on the big boys, Sang Whang, International Communications Corp.'s vice president and technical director, sounds off on some of the knotty problems of interconnection. For what a major independent modem manufacturer has to say about this vital area, Ma Bell, and the FCC, see p. DC-3. In coming months, we'll publish the AT&T and FCC approaches to this data communications controversy.

Right bottom. Representative of a whole new class of communications interface integrated circuits, these MOS ICs make the communications designer's life a much simpler one. Pictured here are Motorola Semiconductor's standard bearers—a transmitter and a receiver that are both synchronous and asynchronous.

6	Editorial
12	Up to Date
16	Welcome
25	Microworld
DC-1	Data Communications
DC-3	Data Communications
	Editorial
DC-16	Data Communications
	Products
DC-24	Data Communications
	News
55	IC Ideas
60	New Product Features
61	New Products
68	Literature
72	Samples
73	Advertising Index
74	International Corner

25 MEMORIES: THE USERS SPEAK OUT By Stephen A. Thompson

Can 800 engineers design a memory? Although it sounds a bit unusual, that was the number of engineers that responded to the questions of a major memory manufacturer on what they needed in a memory. For a complete wrap-up on capability, features, and prices, read this.

DC-1 DATA COMMUNICATIONS following page 30

Once again we explore one of the areas that will offer the electronic engineer new directions for dynamic growth in the decade of the '70s—data communications. This month we conclude the Data Terminals course (with exam) and offer a guest editorial and comm news and products.

DC-3 THE INTERCONNECTION CRISIS By Sang Whang

Representing the independent modem maker, Whang writes of interconnection, Ma Bell and you.

DC-5 DATA TERMINALS COURSE—PART 5

With this final installment of the course, we devote ourselves to some of the developments that will affect the direction that data transmission will take in the future. Among these are facsimile, now poised for giant strides; non-impact printing; and data adapters.

- **Introduction** By Arthur J. Boyle, **The Electronic Engineer**
- **Facsimile communication** By Dave Klein, Xerox Corp.
- **Basic principles of facsimile** By Charles T. Roth, Xerox Corp.
- **Ink jet printing** By James Stone, A. B. Dick Co.
- **A firmware approach to data adapters** By Paul Wolf, Digital Scientific Corp.
- **Exam**

DC-18 ICS TO INTERFACE DATA TERMINALS

An integrated circuit that handles your interface problems? Why not, say several manufacturers who have adopted slightly different approaches to the problem of parallel-to-serial and serial-to-parallel conversion. Result: one or two ICs, where some 40 TTLs were needed before.

55 IC IDEAS

- **Digital frequency separator** By Leroy Young Jr., Western Electric Co.
- **A simple FSK receiver** By Don Kesner, Motorola Semiconductor
- **Line receivers with zero differential input** By Dale Pippenger, Texas Instruments, Inc.



KEPCO TALKS POWER SUPPLY TECHNOLOGY:

OUTPUT IMPEDANCE... *a measure of dynamic regulation*

Load regulation, or *load effect*, is the term used to describe a power supply's ability to stabilize its output against the adverse influence of a changing load. For an abruptly changing load, there will be both a transient effect and a steady-state effect. The time to decay from transient to steady state is called "*recovery time*."

The fact that the transient load effect is different from (usually greater than) the steady-state load effect implies that the regulation or stabilization ability of a power supply is different at frequencies other than d-c.

Indeed it is . . .

In the frequency domain, the load effect (for a sinusoidally varying load) is termed "output impedance." Plotted versus frequency, the shape of the impedance graph tells you whether the power supply's regulating ability is improving or degrading versus frequency, and if it is changing, at what rate. Since a feedback regulated power supply obtains its ability to stabilize by the action of an amplifier, the impedance plot tells you how much the amplifier's gain is changing with frequency—and by the rate of change, tells you how much phase shift is occurring.

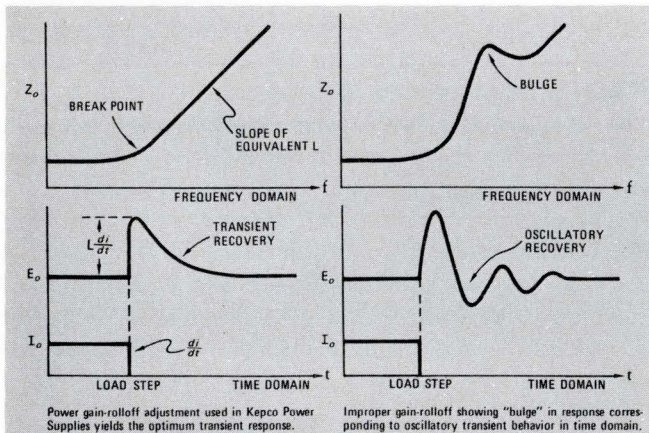

Because the phase shift and gain versus frequency are the criteria for stability in a feedback circuit, a knowledge of their relationship can give you important insight into the dynamic behavior of your power supply.

Ideally, the impedance of a voltage stabilizer should increase past the "break point" at a rate no greater than 6 dB per octave. Irregularities, humps, dips, etc., are intolerable and portend instability and even sustained output oscillation.

In a very real sense, the output impedance plot is a reciprocal *Bode plot* of the feedback amplifier's gain rolloff with frequency.

Kepco has long employed a *dynamic analysis* of its power supply's feedback characteristic—as revealed by both transient behavior and the output impedance plot—to optimize the gain—phase shift—frequency relationship for conventional and "high speed" power supplies. This extra effort insures the maximally stable design and provides you with power supplies having optimum performance.



Write Department DZ-19

KEPCO, INC. • 131-38 SANFORD AVENUE • FLUSHING, N.Y. 11352
(212) 461-7000 • TWX # 710-582-2631

Circle Reader Service #4

THE ELECTRONIC ENGINEER

December 1971
Vol. 30 No. 12

Bernard M. GittelmanPublisher
Alberto Socolovsky Editor
Arthur J. Boyle Managing Editor
Smedley B. Ruth Associate Editor
John E. Hickey, Jr. Features Editor
Sheldon Edelman Western Editor S. F.
Stephen A. Thompson Western Editor L. A.
John McNichol New Directions Editor
Deborah P. Wilkins Assistant Editor
Dr. O. M. Salati Consultant
Anne Axe Editorial Assistant
Lynda Rothstein Editorial Assistant
Mae Moyer Editorial Reader Service
Andrew Mittelbrunn Chilton Art Director
Phau Featherson Artist
George Baker Washington News Bureau
Neil Regeimbal Washington News Bureau
K. Robert Brink Publishing Vice President

Executive and Editorial Offices:
One Decker Square, Bala-Cynwyd, Pa. 19004
Tel (215) SH 8-2000

Address Mail to:
56th & Chestnut Sts., Philadelphia, Pa. 19139

Western Offices:
Stephen A. Thompson
3727 W. 6th St., #202, Los Angeles, Calif. 90005
Tel (213) DU 7-1271

Sheldon Z. Edelman
199 First St. Rm. 335, Los Altos, Calif. 94022
Tel (415) 941-6655

Chilton Officers & Directors: Robert E. McKenna, President; John H. Kofron, Charles W. Hevner, William A. Barbour, Sr. Vice Presidents; Richard H. Groves, K. Robert Brink, Publishing Vice Presidents; James Miades, Vice President, Finance; James A. Naughton, Vice President, Creative Services; Christian H. Miller, Secretary; Thomas J. Casper, Spencer H. Collmann, John P. Kushnerick, Raymond O. Nelson, Eugene C. Beaudet, William A. Phair, David Acton, Donald P. Jones, Richard C. Sorlien.

Monthly publication of Chilton Company, Chestnut & 56th Sts., Phila., Pa. 19139. (Area Code 215) SHerwood 8-2000. Controlled circulation postage paid at Philadelphia, Pa. \$1 a copy. Subscription rates U. S. and U. S. Possessions: 1 yr. \$12.00; 2 yrs. \$20.00. Canada 1 year \$14.00; 2 yrs. \$25.00. All other countries 1 yr. \$20.00; 2 yrs. \$35.00. © Chilton Company 1971. Title Reg. U.S. Patent Office. Reproduction or reprinting prohibited except by written authorization. Microfilm reproductions of **The Electronic Engineer** and its predecessors, **Electronic Industries** and **Tele-Tech**, may be obtained from University Microfilms, 313 N. First St., Ann Arbor, Mich.

The Chilton Electronics and Instrumentation Group
The Electronic Engineer
Instruments and Control Systems
Instrument & Apparatus News
Medical Electronic News
Electronic Components News



Exclusive IRI unsensitized emulsion screens offer fast turnaround, long life, lower costs.

Unsensitized emulsion screens is a mouthful. We just call them Q. R. for quick response. How quick? They can be processed in less than an hour. That's fast turnaround! We pre-coat the screens with an unsensitized emulsion that can be stored up to six months before use. When you're ready to expose and print, just apply our Q. R. sensitizer. Almost anyone can do it with a few minutes training. You eliminate messy in-house coating operations and lower your costs at the same time. Our Q. R. screens can be purchased in multiple emulsion thicknesses with tolerances to $\pm .0002''$. That's probably higher than your present control . . . and with greater repeatability to boot.

Want to learn more about this excellent product? Call or write our marketing department. Better still, see your IRI representative or local Buckbee-Mears consultant. He'll fill you in on all the details of our Q. R. screens, coated and exposed screens, or metal masks. IRI is a subsidiary of Buckbee-Mears, the world's largest volume producer of precision etched, stamped and electroformed parts. You can expect us to deliver, on time, what we say we can deliver. You'll save money with BMC, too, because we can choose from a wide range of capabilities to solve your particular needs. Fast delivery, reasonable prices, in-depth capability, well-trained sales force. Shouldn't you talk to us first?

Industrial Reproductions, Inc., 100 Northeastern Blvd., Nashua, N. H. 03060, Telephone (603) 883-5541.



Turnaround time is less than an hour when you use the IRI unsensitized emulsion screens.

**INDUSTRIAL
REPRODUCTIONS
INC.** NASHUA, NEW HAMPSHIRE

A SUBSIDIARY OF
bmc
BUCKBEE-MEARS COMPANY

1971—A sample of the decade

Like the tithe that ancient gods demanded of farmers from the early fruits of their harvest, 1971 has brought us a sample of the decade ahead, has left us with hopes, and has taken a toll. Measured in sales, in jobs, and in professional achievements, 1971 was a tough year, as 1970 had been before it. But, unlike 1970, this year closes on a positive note.

The managers at the helm of U.S. electronic companies know now that the electronics industry no longer has in the Department of Defense a rich uncle ready to support every new development, and to fund every new system.

While the DoD will remain an important customer, it is the public who will become the ultimate decision maker for profitable developments.

Yet the public isn't sold on technology. What are, after all, the most advanced examples of technology the average citizen owns? The TV set and the automobile. One pollutes his mind; the other pollutes the air he breathes. What are, on the other hand, examples of electronic products he trusts? The low-cost transistor radio, and Bulova's Accutron watch. One comes from Japan; the other is expensive. Is it any wonder, then, that the public either mistrusts technology or questions our ability to produce more useful products at low cost?

There are several electronic products that can gain the public's acceptance and win its confidence, such as the \$100 electronic calculator and the low cost watches and clocks driven by MOS digital ICs. Manufacturers, however, find it difficult to fund this type of development on their own and engineers in the U.S. are only now learning to design at low cost. The development of such products, now non-existent in this country, is important not only to manufacturers and engineers, but also to labor, government, and the public. Their development can provide jobs for labor, a good product for the public, and exportable items for the country. It makes good sense, therefore, for Washington to help the development of such new products and their components with tax incentives and low-cost loans.

A few hopeful signs have already come out of Washington in 1971. One, the Federal Communications Commission allowed competition among data communications carriers. Another, President Nixon, who considerably strengthened the Office of Science and Technology when he appointed Dr. Edward E. David, Jr. as his advisor, is sponsoring now a "New Technology Opportunities Program" for next year.*

Yes, we see positive signs for 1972. Not rich, but positive. The engineers, who can recognize these signs and become aware of the opportunities, will reap the rewards in 1975. These are the same engineers who broaden their background, who take a systems approach in their jobs, who are concerned not only with the equipment they make, but also about its application.

This magazine, **The Electronic Engineer**, with its sister publication **ECN (Electronic Component News)**, has also recognized those signs. For the past two years we have published courses (on MOS Optoelectronics, Memories, Data Terminals) to broaden our readers' background. We have opened a new section—Data Communications—to help you exploit the opportunities in this field. And we have brought into our pages challenging ideas by Dr. David, by David Packard, by FCC Chairman Dean Burch, and by many other personalities who will influence the direction of your jobs. Just like the closing year, we too have brought you in 1971 a sample of the decade ahead.

Alberto Socolovsky
Editor

*See "There is an EE in the White House," **The Electronic Engineer**, April 1971, pp. 26-29. For the New Technology Opportunities Program, the President has appointed William M. Magruder, who was in charge of the ill-fated SST program at the Dept. of Transportation.



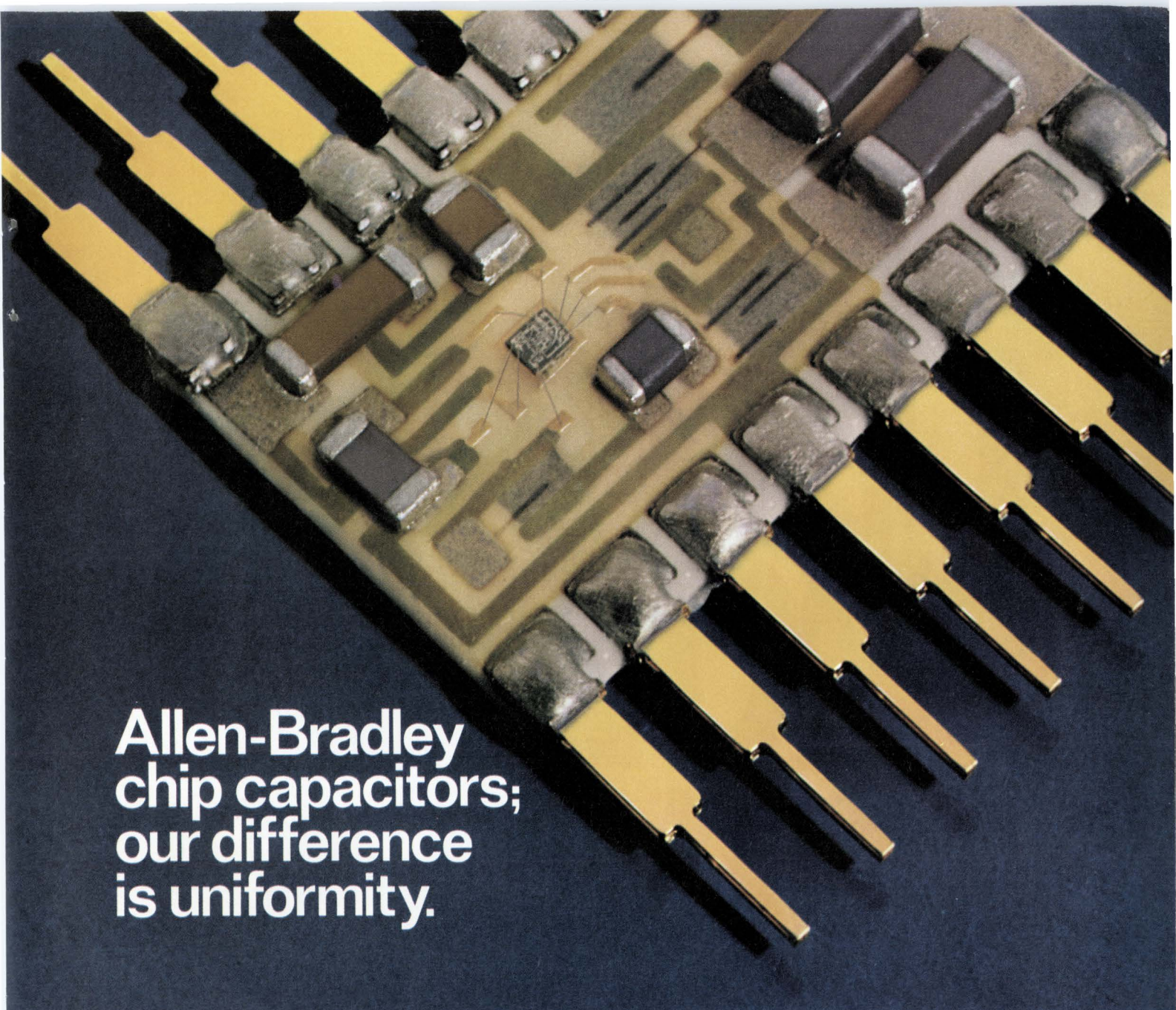

Allen-Bradley chip capacitors; our difference is uniformity.

Now you don't have to put up with a lot of production line problems to capitalize on the advantages of ceramic chip capacitors. We've developed a manufacturing process (different from any other in the industry) that makes our capacitor chips far more uniform. You profit from more stable chip-to-chip performance. Your production control becomes far easier because

we've found the answer to traditional product variables. But that's not all. In our unique manufacturing process, ceramic dielectric and noble metal electrodes are fired into a truly monolithic structure. Mechanically stronger. Virtually void-free. Moisture and contamination resistant. And our multi-layer terminations solve a variety of attachment problems. Standards

available in 50, 100 and 200 Vdc with no derating from -55°C to $+125^{\circ}\text{C}$. Capacitance from 10pF to $1\mu\text{F}$. NPO, stable, semi-stable and Hi-K. Specials available. See your A-B electronics distributor for selected sizes and values. Write for Bulletin 5415. Allen-Bradley, Electronics Division, Milwaukee, WI 53204. Export: Bloomfield, N.J. 07003. In Canada: Galt, Ontario.

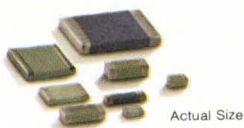

NEW DIMENSION ELECTRONICS
ALLEN-BRADLEY



NEW TTL/MSI PROBLEM SOLVERS

From our TTL Family Tree, simple new solutions for A/D converters, minicomputers, high speed systems.

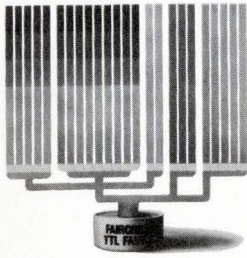

Four new high quality members have been added to the Fairchild family of 96 TTL/MSI circuits. Each can be used in a variety of designs—alone, or combined with other members of our TTL and/or MOS families—for simple solutions to complex systems problems: For example:

9334 8-Bit Addressable Latch for general purpose storage in high speed digital systems. Combined with other MSI devices, it can be easily expanded to form large storage arrays. By itself, the 9334 can serve as an 8-bit addressable latch memory, one-of-eight decoder or one-of-eight demultiplexer.

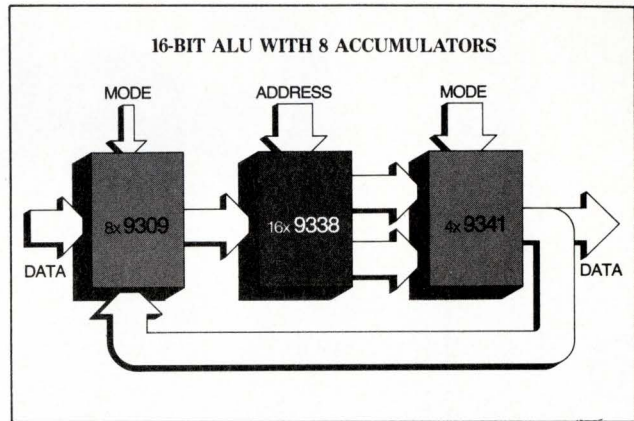

Used as a one-bit slice of eight registers/accumulators, it combines with either the 9340 or 9341/74181 ALU device to become the powerful heart of a minicomputer central processing unit. It's equivalent to a 9301 decoder, a 9308 latch, two 9312 multiplexers and a dual flip-flop. Send for our Appl. Note 220.

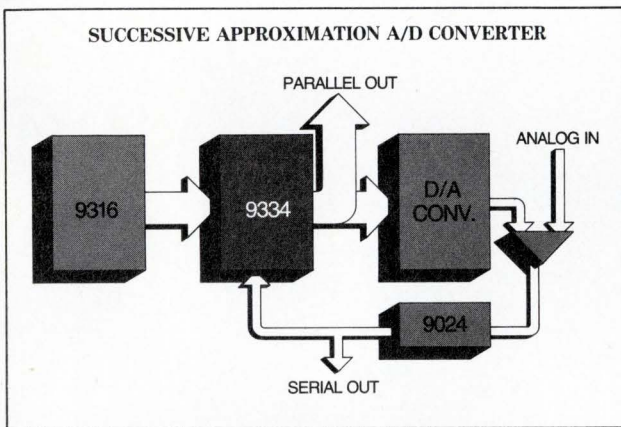

In an A/D Converter, the 9334, combined with a 9316 Binary Counter and standard linear devices, provides a successive approximation analog-to-digital conversion. Send for our Appl. Note 294.

9338 8-Bit Multiple Port Register for high speed storage in an arithmetic logic unit is probably the most significant new function yet designed for minicomputer memories. Uniquely, it eliminates any addressing restrictions by permitting simultaneous read/write without race problems and by allowing data to be written into any one of the 8 storage locations and read out of any two of the locations *simultaneously*.

93H00 and 93H72 High Speed 4-Bit Shift Registers improve system performance up to 300% over a wide range of design applications that are based on the 9300 industry standard shift register.

The 93H00 has the same pin configuration as 9300 but has improved minimum shift rate by a factor of 3 (to 45MHz). This high-speed 4-bit shift register is a multi-functional sequential logic block, useful in a wide variety of register and counter applications.

The 93H72 has a minimum shift frequency of 45MHz and typical 58MHz. It uses the same basic 4-bit shift register configuration as the 9300 but with additional logic flexibility. 9300 J and K inputs are replaced by single D type input and a clock enable input E, providing a HOLD ("do-nothing") state. This eliminates the need for external clock gating.

These MSI devices are indicative of the problem-solving power of the Fairchild TTL Family Tree, most comprehensive TTL line in the industry. They are available, along with product and application information, from your friendly Fairchild Distributor.

**MADE IN
FAIRCHILD**

Get nosy...

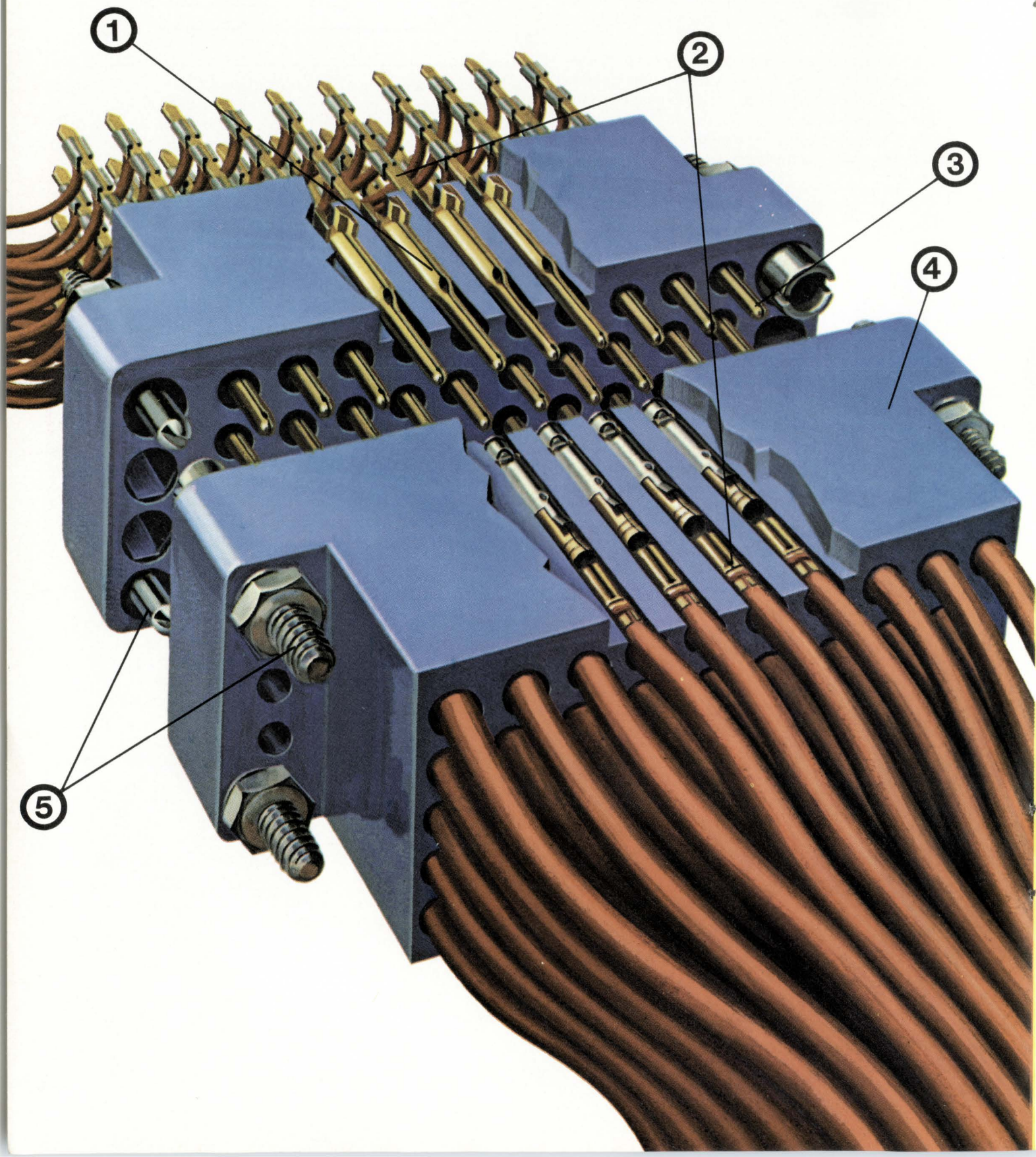

it pays.

Take a close look at the broad line of AMP "M" Series Connectors. You'll see how everything is designed and made better to give you better performance and higher reliability, at the lowest *installed* cost . . . this is what we call Economotion.

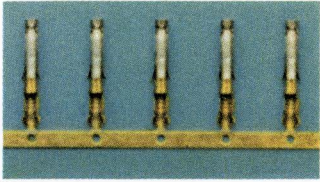

① The right pin and socket contacts for the job. Formed contacts with special socket spring design to make stronger and more uniform electrical contact—an AMP mated connector exhibits less resistance per contact than equal length of wire. Formed pins and sockets available in contact sizes 20, 18 and 16 accommodating wire ranges #14 to #30 AWG. Solid, screw-machined contacts available for military or aerospace requirements down to #32 AWG wire.

② AMP contacts are designed to be manually or automatically crimped on wire, or for soldering or welding techniques. Special contacts are designed for back-bay wiring, with either AMP TERMI-POINT* point-to-point wiring or wrap type methods.

Single crimp coaxial contacts. AMP COAXICON* Sub-miniature Coaxial Contacts cover a range from RG174U to RG196U including some twisted pairs. These contacts are terminated with one quick crimping action . . . inner conductor, outer braid and cable support, all simultaneously. VSWR and noise levels are kept at minimum. The finished termination is inspectable via a see-thru port. Coaxicon subminiature contacts fit all "M" Series blocks to allow complete freedom of mixing with standard contacts.

③ The right contact plating—the right thickness. With AMP, you can select from various platings engineered to do a specific job best. Available in gold, silver, tin and special alloys. Proper thickness during AMP manufacture is assured by exclusive X-ray emission analysis techniques.

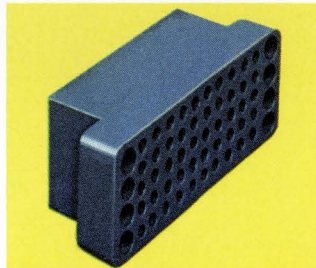

④ Largest selection of connector blocks. AMP offers more variety of contact configurations and a choice of quality molded plastics — "M" Series blocks are made from phenolics for all around service, or diallyl phthalates for stability under extreme conditions. They also meet Mil Spec requirements. Available in 6 to 160 positions for standard or coaxial contacts. Mix or match for your particular circuit needs.

★Trademark of AMP Incorporated

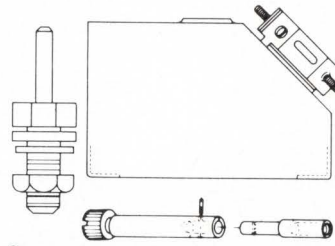

⑤ Pick from the broadest selection of hardware. Choose from a complete line of guide pins, sockets, strain-relief clamps. And two piece shields, with either lock-spring, quick-release or jackscrews, and cable clamps up to 1 1/4" diameter. Internal and external pin hoods are available for pin protection. Jackscrews of all types . . . fixed, turnable, short-short to long-long.

Everything about our "M" Series Connector design permits mating with almost any similar connector available today. So you can use them to retrofit, modify or interface . . . at a cost savings.

⑥ High-speed crimping or point-to-point wiring machines. AMP offers the most complete line of automatic application machines for use in your plant that give you capacities of 1,000 to 12,000 terminations per hour. Human error is cut to the absolute minimum. And operator skills are quickly and easily learned — we even train your production personnel.

The unique semi-automatic AMP Stripper / Crimper* simultaneously strips and terminates unstripped leads or wire harnesses at speeds up to 1,200 pins or sockets per hour.

Our fully-automated AMP-O-MATOR* Machine does everything . . . cuts wire to exact length, strips, terminates one or both ends. And with the same or two different contacts. Maximum capacity . . . 12,000 terminations per hour.

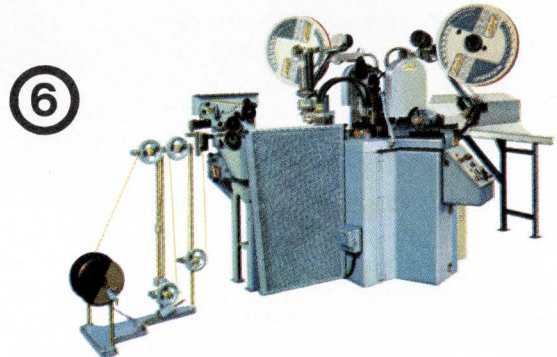

The AMP line is thoroughly tested. Tests cover all areas of electrical and mechanical performance and adverse environments — contact resistance, millivolt drop, shock, vibration, heat stability and corrosion resistance. Data covering these and other criteria is available.

Get nosy. Get all the information you need and learn how our "M" Series line pays off in reliability and improved productivity through AMP Economotion. Write: **Industrial Division, AMP Incorporated, Harrisburg, Pa. 17105.**

AMP
INCORPORATED

Mini uses maxi software

Varian Data Machines, like most mini-computer manufacturers, has muscled its way into the market on the strength of an excellent hardware capability. Recognizing that hardware will take you only so far, Varian now announces a very comprehensive operating system for its 620/f. Christened VORTEX, the real-time software system brings large system capability to the mini user.

It's a fact of life that, in many applications, minicomputers are very poorly

utilized. Most often this is because the operating system is "home brewed" by each customer and makes very inefficient use of the machine's speed and main memory.

The VORTEX system is Varian's answer to this problem. It features real-time foreground processing, true multi-task capability, automatic batch processing in the background, a powerful file maintenance capability, and a comprehensive I/O arrangement.

The system is built around rotating memory allowing you to use either disc or drum. For a minimum configuration (foreground only) you need 12k words of core memory. A full-blown system, with both foreground and background processing, can reside in 16k words of core. Varian sees the VORTEX system upgrading the capabilities of the 620/f to the point where it will compete with such machines as the IBM 1800, CDC's 1700, and the Sigma 3 from XDS.

Circle Reader Service #301

Pass the bucket

It's been a long time since the electronics industry first started to express an interest in a "bucket brigade" IC. And until now technical and manufacturing complexities would crop up and prevent a practical device.

A "bucket brigade" IC is an analog shift register that transfers information from stage to stage in response to timing signals. And Amperex has come up with one they call the M31. It's a p-channel MOS IC with 32 analog shift register stages, or "buckets," plus an input sampling circuit and an output follower. Since it operates directly on the analog input signal, no analog-to-digital or digital-to-analog signal conversions are necessary.

Look closely at the new IC and you'll see a chain of storage capacitors and charge-transfer circuits that act together as an analog shift register with an externally controlled shift rate. The array of capacitors stores information as a charge deficit rather than as a charge level. With charge storage deficit only

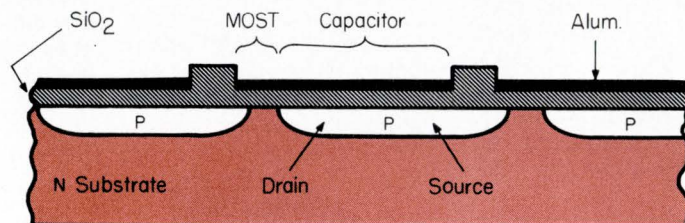
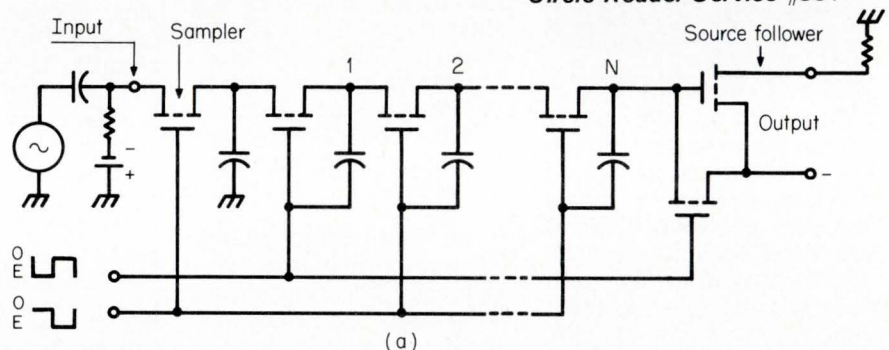

There are 32 "buckets" in this analog shift register IC. Using charge deficit storage, it needs only one transistor per capacitor (a). The cross section here shows a typical stage of charge deficit storage in a transfer circuit (b).

one transistor is needed per storage capacitor.

The Cambridge Research and Development Group of Westport, Conn., is the first to use the new IC in a com-

mercial application. They're using it in a variable speech control system.

If you're interested in how this device might suit your applications, contact Amperex Electronic Corp.

Circle Reader Service #302

They'd rather sense than switch

Sense amplifiers, originally for sensing low-level plated wire signals, now permit you to use cores for electronically alterable ROMs (EANDROS), according to John Bruder, Quadri's Advanced Product Development Manager. Their new core EANDROS achieve a 150-ns access time because the cores are sensed only, not switched as in read/write applications.

The "bucking flux" principle Quadri uses requires two cores per bit. The hys-

teresis diagram shows that two cores strung in opposite directions may be in the same or opposite states (a or b) and their flux will buck whenever a drive current is applied.

When the states are opposite, the proper drive current causes one core to output more flux because it begins to "turn the corner" and go into saturation and when the states are the same, both signals cancel exactly. This could define 1's and 0's.

Quadri prefers to keep core pairs in opposite states and to define the resulting positive or negative polarity from the two complementary states as 1's or 0's. This polarity sensing provides a greater signal-to-noise ratio and eliminates the need for threshold voltage discrimination. More information is available from Quadri Corp., 2950 West Fairmont, Phoenix, Ariz. 85017.

Circle Reader Service #303

Whiskers are out.

The new military standard for 1.5 watt power zeners is Unitrode's double pin bonded design.

The 1N4461-89 series from Unitrode is available off-the-shelf as JAN and JANTX zeners to MIL-S-19500/406 in most voltages from 6.8V to 100V. They offer greater reliability and improved electrical characteristics at no more cost than conventional 1 watt whisker-type metal can zeners. The reliability of the double pin design is further increased by bonding the silicon chip directly between terminal pins and then fusing a hard glass sleeve to the exposed silicon surface and pins.

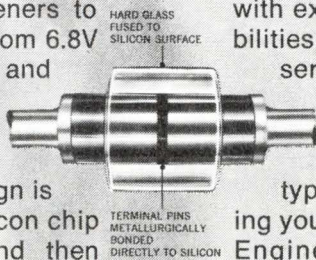

This results in a voidless, monolithic structure with exceptional zener stability. Surge capabilities are 5 times greater than the 1N3016B series. Zener impedances are improved and reverse currents are two orders of magnitude lower. The point is, now you can switch from whisker-type to double slug design without shaving your standards. For fast action, call Sales Engineering collect at (617) 926-0404, Unitrode Corporation, Dept. 12D, 580 Pleasant Street, Watertown, Mass. 02172.



UNITRODE

Circle Reader Service #8

DPM crowd gets even thicker . . . The competition in the under \$100 DPM business (see *The Electronic Engineer*, Oct. 1971, p. 71) has become even hotter. Analog Devices Inc., following the lead of Analogic, hopes to parlay their circuit design and marketing strengths into a dominant position in that field. The first product is the AD2001, a 3½ digit unit with autopolarity and overrange indication. The price is \$89 ea., in 100 quantities.

Circle Reader Service #304

MOS makes it in mainframes . . . Cogar Corp. of Wappingers Falls, N.Y., is shipping what it believes to be the first MOS main memory for a major computer product line. At least two of their Main Memory System Modules will be used in the 1904S computers of International Computer Ltd., a British firm. Each module contains 32,768 words by 25 bits (or 96k bytes) of n-channel MOS storage. System worst case access time is 175 ns and cycle time is 275 ns.

Circle Reader Service #305

It's time for CMOS in watches . . . Hughes now offers a low voltage, complimentary MOS countdown circuit for use in electronic watches. As for specs, the HCTR1601 is ion-implanted to reach equal n and p-channel threshold voltages of 0.7 ± 0.2 V, and it consumes $5 \mu\text{A}$ at 1.35 V when oscillating at 65 kHz. You can buy this new circuit for \$20 in 100-piece quantities.

Circle Reader Service #306

Laser mass memory delivered . . . The first trillion-bit laser mass memory system was delivered by Precision Instrument Co. of Palo Alto, Calif., to the Ames Research Center in Moffett Field, Calif., for use on the ARPA network and with Illiac IV. The UNICON (See *The Electronic Engineer*, June 1971, pp. 52-53) has an average access time within the total file of 4.5 s, an error rate less than one in 100 million bits, and a data storage cost of less than 0.0002c/bit.

New WESCON consumer show . . . WESCON will introduce "Expo Electronica," an exhibit of electronic products and systems for the home and office, in September 1972, at Los Angeles. It will precede WESCON by about a week and will be open to the public. Entertainment electronics, electronics for home security, office calculators, time-sharing terminals, displays, and minicomputers and peripherals will be the stars of the new show.

Automation gives a new look to BEMA . . . Electronic calculators were in the spotlight at this year's BEMA show in New York, with automated office equipment stealing some of the show. "Word processing," a new system for handling paperwork for the busy executive, emerged as a potential rival of data processing equipment. Along with new ideas, new exhibitors added interest to the show. Honeywell Instrument Systems was welcomed back with open arms—its first appearance at BEMA since 1968—and, as a new addition, Hewlett-Packard's Calculator Products Division made its debut this year.

Another price cut . . . Once again Hewlett-Packard has reduced the price of their alphanumeric solid-state displays. The new price reduction chops nearly 50% off recent prices. Now you can get displays for \$11 per character in quantities of 1000, a large cut off the recent \$20 per character price.

It's magic . . . Using a beam of laser light, Bell Labs scientists can raise small transparent glass spheres (20 microns in diameter) off of a glass surface and hold them aloft for hours in a stable position. The experiment demonstrates optical levitation. But they still have a long way to go to catch up to Houdini!

Tune in on vending ventures . . . Oak Mfg. Co., a leading maker of TV tuners, is now manufacturing a new unitized control system for leading vending machine manufacturers. The solid-state control enables machines to offer more selections with fewer parts and with less vulnerability to vandalism and dispensing errors.

Burr-Brown moving ahead . . . This month be sure to look for a surge of new products from Burr-Brown Research Corp., in Tucson, Ariz. Among them will be a low drift ($1 \mu\text{V}/^\circ\text{C}$) FET in a TO-99 can that uses a laser-trimmed, thin-film technology from Sloan. And since performance is improving with each mask iteration, guaranteed $1 \mu\text{V}/^\circ\text{C}$ versions of the 3500 monolithic op amp are also in sight. Other 3500's with $5 \mu\text{V}/^\circ\text{C}$ drift will be sold as matched pairs. A flourish of conversion modules is also scheduled for the next few months.

Circle Reader Service #307

Bits of information . . . Signetics has a new high-speed MOS ROM that can generate Japanese Katakana alphabet characters. It's a 2560-bit static IC organized as $64 \times 8 \times 5$. . . **Ling Electronics**, div. of LTV Altec Inc., now owns the manufacturing rights and inventories of a minicomputer product line. They intend to enter the computer-based systems markets, including direct digital control of test systems.

Westinghouse Electric Corp. has new color TV picture tubes that increase both the brightness and contrast of TV pictures . . . **RCA** has come up with a lightweight, high-capacity drum memory system qualified to military specs for an advanced anti-submarine warfare aircraft development program. The drum stores 8.8 million bits in 1 ft.³ of space.

Raytheon Semiconductor is the first domestic manufacturer to second source the Fairchild 9500 Series ECL. Director of Marketing, Gene Selven, estimates the non-captive ECL market will swell from \$30 million to \$100 million by 1974 . . . **The first all solid-state** Category II Instrument Landing System was delivered to the USAF at Travis AFB, Calif., by **Texas Instruments Inc.** Up to 130 systems will be supplied to the USAF and the FAA on a multiyear contract.

*Ever been away from home
and missed your storage scope?*

**NEXT TRIP
take one
with you**

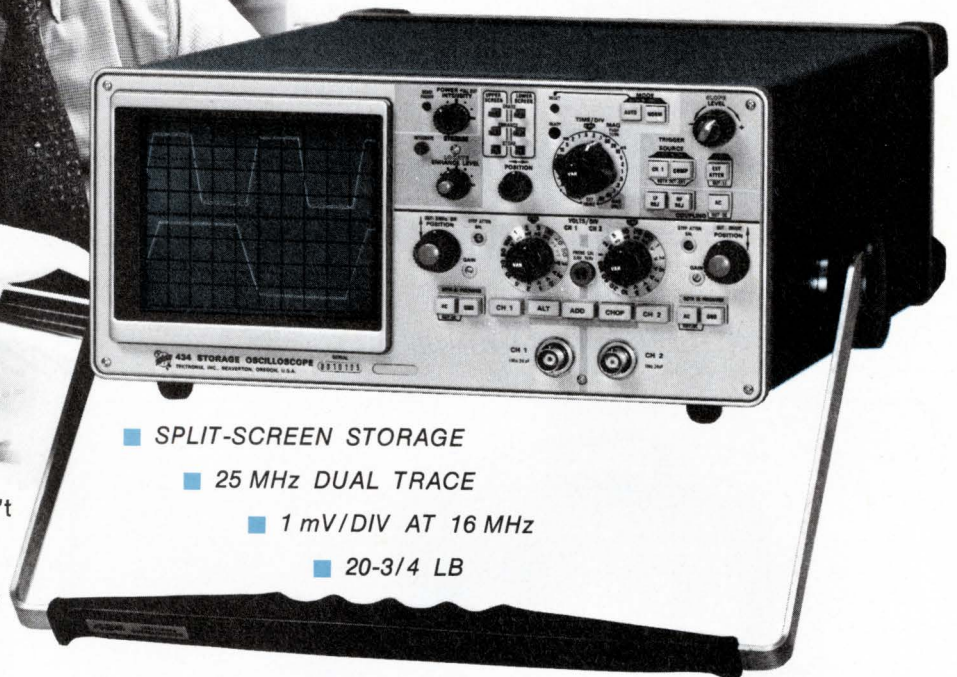

Storage isn't new. Portables aren't either. But storage in a portable oscilloscope certainly is. Now, they're together for the first time in the new TEKTRONIX portable 434 Storage Oscilloscope. It's virtually two instruments in one, offering you all the advantages of bistable split-screen storage, plus those of a portable oscilloscope with a conventional CRT.

How often have you had difficulty making measurements in applications where signals are single event or low rep rate, aperiodic or random? Storage provides you with an easy solution to many of these measurements. And, the portable 434 solves the problem of getting storage to the application.

To save your time, operating the 434 in a storage mode is as simple as pushing a front panel control. You just set the 434 to store a single sweep. When the event occurs, it's stored at writ-

ing rates up to 400 cm/ms and retained in a continuous view mode for as long as four hours. The bright, high-contrast display is clearly discernible even when you make the measurement in high ambient light. Another 434 feature you'll like is the CRT's high resistance to burns. It requires no more care than you give a conventional CRT.

The companion model 432 is a nonstorage model of the 434. Otherwise they're identical. Cabinet height is only 5-3/4 inches and rack height is 5-1/4 inches. Even so, there's room for a big 8 x 10-cm CRT. Bandwidth to 25 MHz, and sweep rates to 20 ns/div cover a wide spectrum of measurement needs. Deflection fac-

tors extend to 1 mV/div dual trace and are read out by lighted knob skirts even when you use the included 10X probes. Carrying weight is a very reasonable 20-3/4 pounds.

Before selecting your next portable, you'll want to see what's really new. Your field engineer will arrange a demo of the 432 and 434 at your convenience. Prices are: 432 Oscilloscope, \$1585. 434 Storage Oscilloscope, \$2150. U.S. Sales Prices FOB Beaverton, Oregon.



TEKTRONIX®

committed to
technical excellence

Ask your field engineer about the 434 with 5000 cm/ms stored writing speed (option 1).

Circle Reader Service #10

**Computer Graphics Displays
 Medical Displays
 Process Control Displays
 Document Retrieval Displays
 Educational Displays
 Business Data Displays
 C. C. T. V. / C. A. T. V. Displays
 Scientific / Test Equipment Displays
 Command and Control Displays**
**That about covers the uses for the
 Hughes Scan Conversion Memory Unit.
 So far.**

And the list keeps growing. Why? Our unit is designed with enough features to satisfy almost any video refresh and scan conversion requirement you can think of—alphanumerics or graphics. It's also inexpensive. With over 15 years of experience behind it. Here's a system that provides stored high resolution display. Use it with off-the-shelf TV monitors or



HUGHES
 HUGHES AIRCRAFT COMPANY
 INDUSTRIAL PRODUCTS DIV.
 OCEANSIDE, CALIFORNIA

existing displays. Heart of the system is our new low cost scan converter tube. Tubes and complete systems, along with applications engineering, are available at low prices—in quantities of one or hundreds for OEM needs. We'll give you the facts—and a demonstration—at our plant or yours. Who knows, you may have a use we haven't even thought of. Let's hear about it. Write or call: 2020 Oceanside Boulevard, Oceanside, California 92054 (714) 757-1200.

Circle Reader Service #11



Isolationist

Nobody likes line transients. Lab engineers hate them. Computer people get very upset when line transients flop their Flip-Flops. Now, you don't have to put up with that nonsense anymore. Our new little shielded "Isolationist" will give you high common mode rejection, stop high frequency line transients, put an end to 60 cycle leakage current and break AC ground loops . . . simply and economically. 0.1 to 2KVA units (to 0.0005 pfd. coupling capacity) are available from stock to 2 weeks. Write for our catalog.



CEA, a division of Berkleonics, Inc.
 1221 S. SHAMROCK AVENUE, MONROVIA, CALIFORNIA 91016 TELEPHONE: (213) 359-9261

Circle Reader Service #12

WELCOME

Low noise receivers

A group of engineering managers from the Applied Electronics Div. of AIL recently formed LNR Inc., which will specialize in the low-noise receiver field. Three of the new firm's leaders have experience with microwave ics, which will be one of the capabilities developed. Others include low noise parametric amps, tunnel diode amps, and related components. While this technology will represent a sizeable portion of LNR's efforts, the new shop also has plans to market subsystems, components, and its R&D capability. The initial thrust will be on low noise microwave receivers for the satellite communications market. Later, LNR will look at microwave relay and other point-to-point communications, radar, reconnaissance, countermeasures, navigation, radiometry, telemetry, missile electronics and avionics, and in technologies ranging from rf to optical frequencies.

Circle Reader Service #220

Blacks mean business

Right on! . . . with computer service at DP Associates in Huntsville, Ala. But there's something just a little bit unusual about this young company and its beginning. And it's right in keeping with the age of aquarius. The company, owned and managed by blacks, received more than half of its financial backing from a local black-owned organization chartered to promote new job opportunities for minority groups. The rest came from Computer Sciences Corp. And blacks currently represent about one-third of DP's system analysts, programmers, and office personnel. The firm has a contract from the General Services Admin. to provide complete technical support to the Federal Data Processing Center in Huntsville.

Circle Reader Service #221

Switch drivers

LRC Inc., formed in June, 1971, recently launched its product line with SD 1000-series switch drivers. The drivers will soon be joined by diode switches and strip line components. The switch drivers are compatible with TTL, boast a 10-ns delay, are short circuit protected, and perform in -54 to 100°C temperature ranges. The series has been designed to be compatible with a variety of diode switches and modulators.

Circle Reader Service #222

Circle Reader Service #25 →

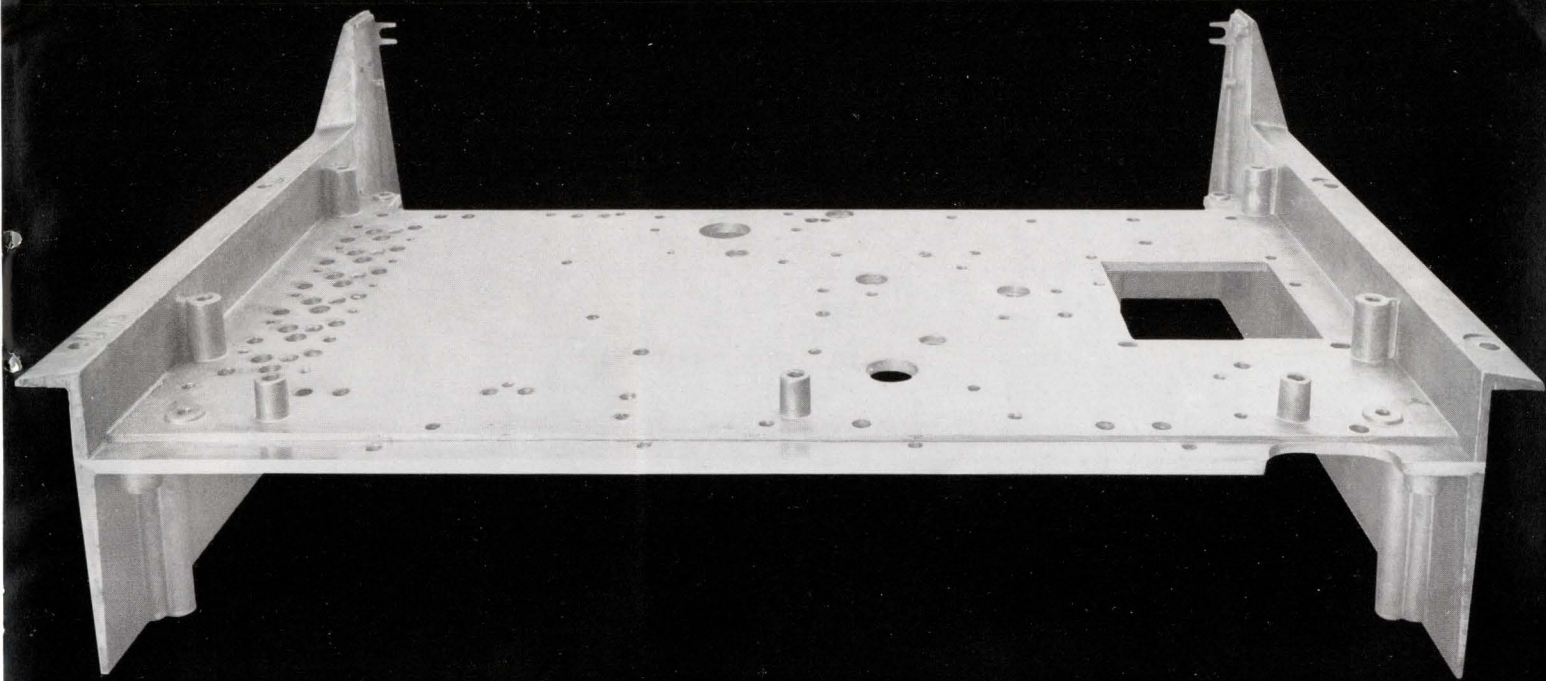

Only one OEM xy recorder is cast for the role.

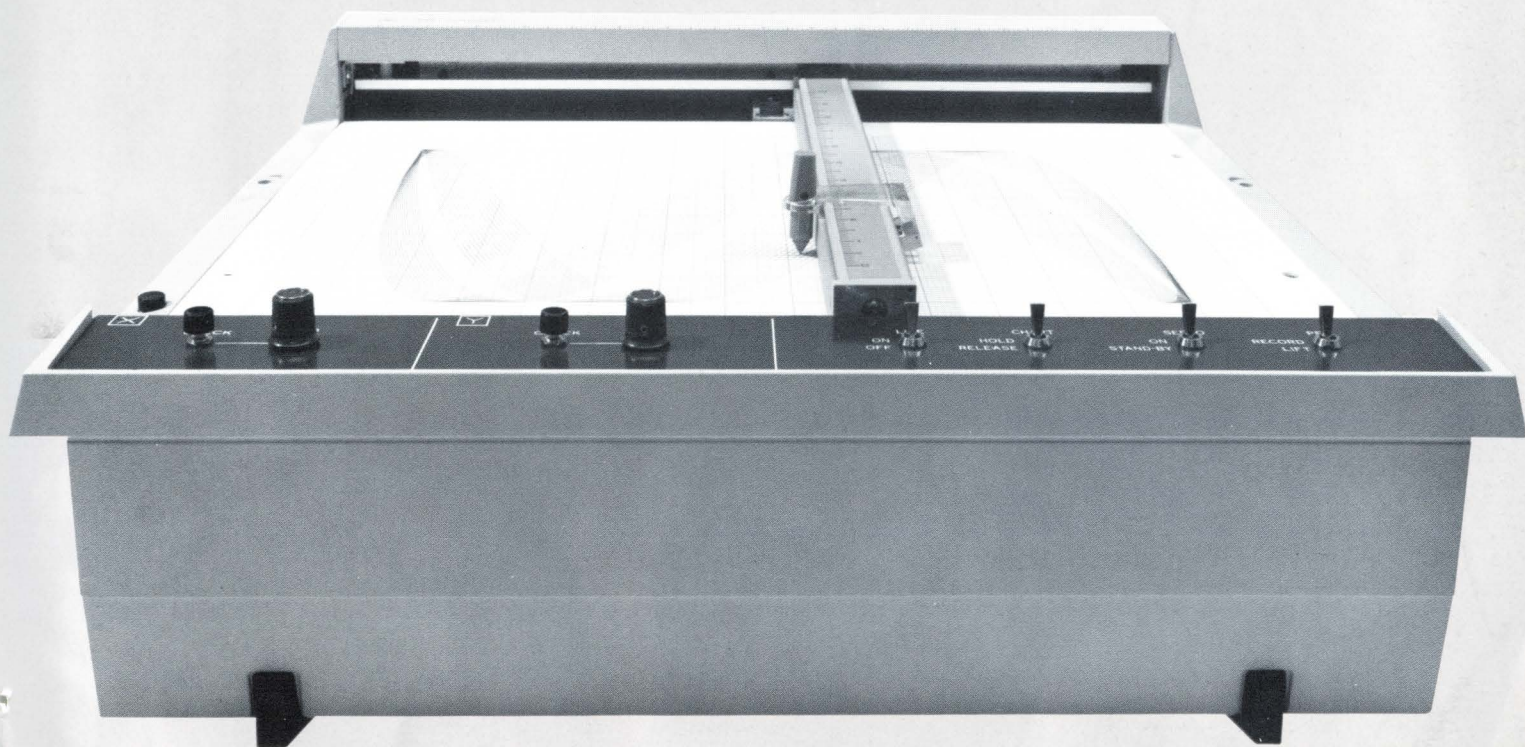

Ever try to find an xy recorder designed to adapt to your OEM system? We've built a totally new cast aluminum recorder because you've been buying modified laboratory machines for OEM applications. And paying for them in more ways than one.

HP's 7040 won't force you into buying anything you can't use. An OEM machine from the ground up, it's designed around a one-piece, die-cast aluminum mainframe... a rugged platform for the modular features you select. But *only* the features you select.

A complete cast of options lets you specify exactly what you need to do the job. Everything from a control panel (shown above) to rear connector. Nearly 40 independent options in all.

You get standard features that make sense in any OEM application. Things like Autogrip electrostatic holddown, IC circuitry, a long-life hybrid potentiometer, disposable pens and more. All the things we learned while pioneering the development of xy recorders for two decades.

A rugged die-cast mainframe. A complete cast of options. HP's new 7040 is the only OEM xy recorder cast for the role. Get specifications and discount data from Hewlett-Packard, 16399 West Bernardo Dr., San Diego, California 92127; Europe: 1217 Meyrin-Geneva, Switzerland.

HEWLETT  PACKARD

GRAPHIC RECORDERS

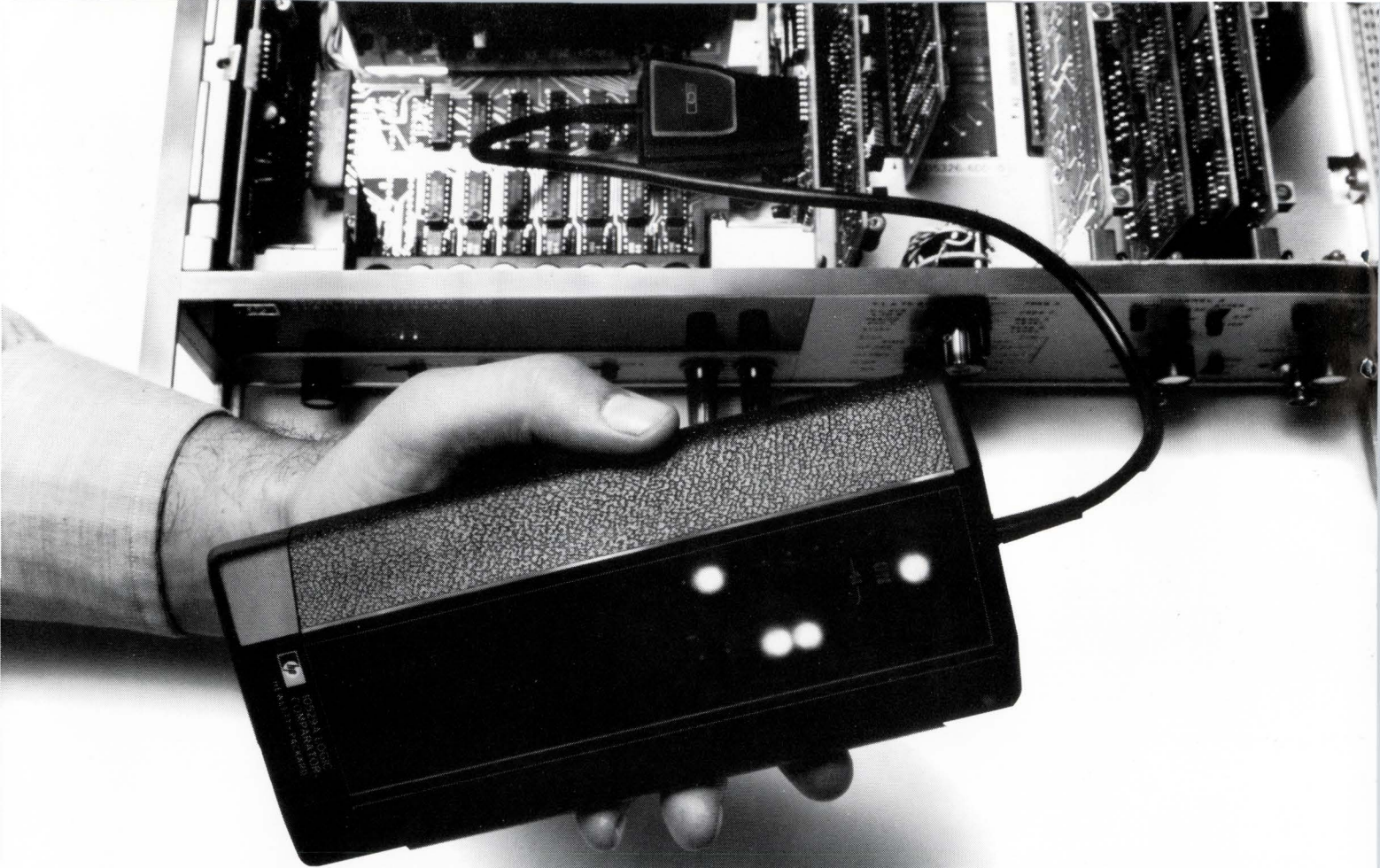

The IC troubleshooters march on.

This one spots a bad IC in 5 seconds or less.

Here comes the latest member of HP's Troubleshooters searching out faulty ICs. Just clip the HP 10529A Logic Comparator onto an in-circuit TTL or DTL IC. If the logic function isn't what it should be, bright red LEDs light up indicating which pins are at fault. A clever comparison scheme uses the circuit's power and input stimulus to do all this. Even dynamic errors as brief as 200 ns are stretched and displayed.

It comes complete with a self-test board, operating manual and all accessories packed in a handy case. It costs only \$295.

We're thinking ahead. Because the case is also designed

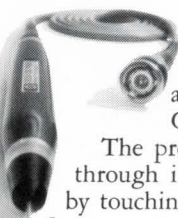
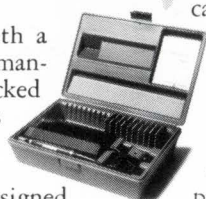

to hold our other two Troubleshooters — the HP 10525A Logic Probe and the HP 10528 Logic Clip. The probe lets you trace pulses through integrated circuits simply by touching a pin. The probe's tip flashes a signal for pulses as narrow as 25 ns, and indicates pulse polarity, pulse trains and logic states. It's almost like having an oscilloscope squeezed into a ball-point pen. \$95.

The clip is a convenient state indicator. It slips over your DTL or TTL package and bright LEDs display the



static state of all 16 (or 14) pins at a glance. It operates like 16 binary voltmeters. \$125.

You can buy all three as the HP 5010A for \$495, saving you time, aggravation and \$20.

The IC Troubleshooters march on. Wait until you see what we're working on now! Just call your HP field engineer to get your hands on them right away. Or if you want to know more, write Hewlett-Packard, Palo Alto, California 94304; Europe: 1217 Meyrin-Geneva, Switzerland.

HEWLETT  PACKARD

**You're
invited
to a private
screening**



**of the
National
Semiconductor
Memory
Seminar
Film.**

In your office.

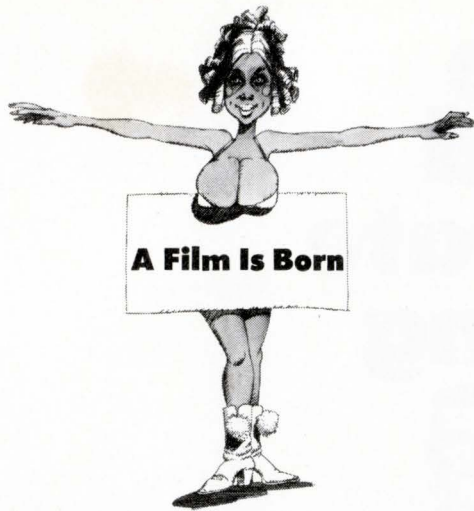

Recently, we captured our best memory spokesmen on film as they discussed the National Semiconductor memory design philosophy, our current broad-based product line, and upcoming new designs, as well as a number of memory system applications.

The result is *The National Semiconductor Memory Seminar Film*: an informative, no-holds-barred, no b.s. look at the past, present and future of semiconductor memories.

A 30-minute filmic experience we'd like to share with you in the privacy of your own office.

With up to 25 of your friends and co-workers.

Free crackerjacks.

And one of our best applications engineers as projectionist/answer man.

Five-Part Flick

Before asking you to sign up for a free private screening of *The National Semiconductor Memory Seminar Film*, we'd like to offer a brief summary (realizing of course that mere words can never fully describe the exact nature of this unique, five-part cinemagraphic work):

Part One: Mainframe Memories

A quick-paced, yet highly significant review of National's mainframe memory capability in which the MM1103 and a couple of dynamic MOS RAM superstars are put into proper focus. Namely, the Tri-State* 1024-bit MM5260 and the 2048-bit MM5262.

Part Two: Scratchpad/Cache Memories

A thought-provoking presentation of scratchpad and cache memory applications featuring the breathtaking (Tri-State, 256 x 1) DM74200 and a bevy of other highly talented National bipolar RAMs.

Part Three: Silicon Store Memories

This highly-informative, slickly-produced portion of the film is devoted to the introduction of the revolutionary new "silicon store" memory; an inertia-less electrically rotating data string ideally suited to the dual 256-bit MM5012 and 1024-bit MM5013, National's up-and-coming pair of new longer length dynamic accumulators with Tri-State logic.

Part Four: Buffer Memories

A hard-hitting, two-fisted recap of commonly known buffer memory applications, liberally sprinkled with appropriate devices from National's arsenal of static MOS RAMs, shift registers and bipolar RAMs.

Part Five: Microprogramming Memories

As the proverbial "light at the end of the tunnel" appears, a number of devices are quickly exposed; including the DM8597 (1024-bit bipolar ROM), MM5203 (2048-bit MOS pROM) and the MM5232 (Tri-State 4096-bit static MOS ROM).

(For your convenience, we've taken the liberty of listing our complete line of semiconductor memory devices. Look them over carefully. We'll be glad to send complete specs on any category you wish.)

All you have to do now is fill out and mail us the handy free film coupon.

*Tri-State is a trademark of National Semiconductor Corporation.

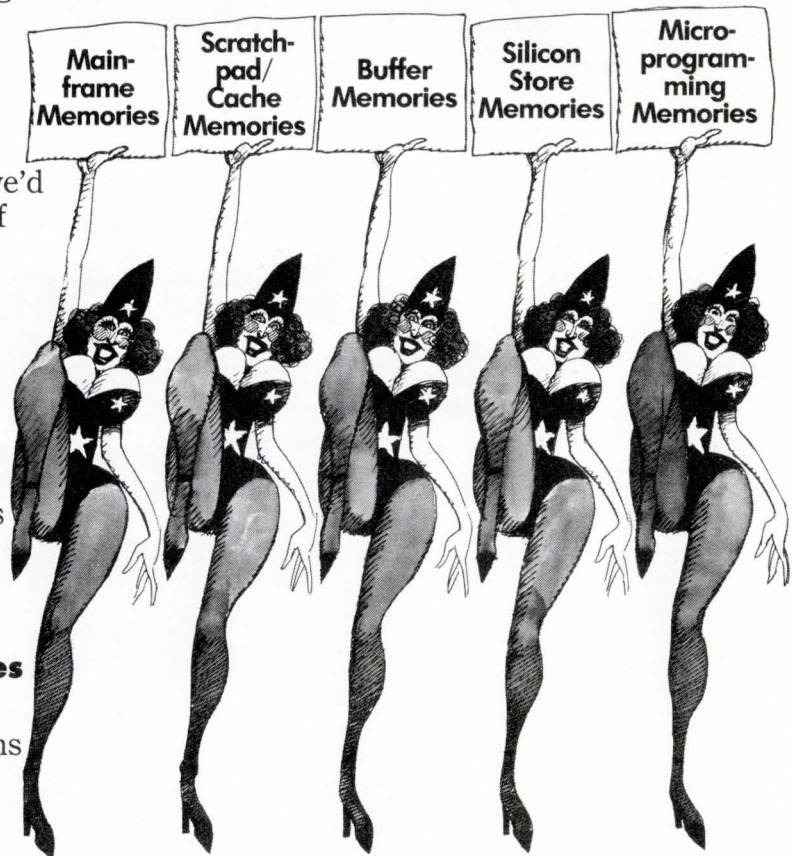

Mainframe Memories

MM5260 1024-bit Tri-State MOS RAM
MM1103 1024-bit MOS RAM
MM5262 2048-bit MOS RAM

Scratchpad/Cache Memories

DM7489 16 x 4 bipolar RAM
DM8599 16 x 4 Tri-State bipolar RAM
DM74200 256 x 1 Tri-State bipolar RAM (read-write)
DM86L99 16 x 4 low power bipolar RAM
DM8594 64 x 4 Tri-State bipolar RAM

Buffer Memories

DM7489 16 x 4 bipolar RAM
DM8599 16 x 4 Tri-State bipolar RAM
DM86L99 16 x 4 low power bipolar RAM
MM1101A2 256 x 1 MOS RAM
MM1101 256 x 1 MOS RAM
MM11011 256 x 1 MOS RAM
MM1101A 256 x 1 MOS RAM
MM1101A1 256 x 1 MOS RAM
MM5054 dual 80-bit tapped-static shift register
MM5052 dual 80-bit MOS shift register
MM5053 dual 100-bit MOS shift register

Silicon Store Memories

MM5012 dual 256-bit Tri-State dynamic shift register/accumulator
MM5013 1024-bit Tri-State dynamic shift register/accumulator
MM5016 500/512-bit dynamic shift register
MM5017 Dual 500/512-bit dynamic shift register
MM5019 Dual 256-bit mask programmable dynamic shift register

Microprogramming Memories

DM8598 256-bit Tri-State bipolar ROM
DM7488 256-bit bipolar ROM
DM8597 1024-bit Tri-State bipolar ROM (256 x 4)
DM74187 1024-bit bipolar ROM (256 x 4)
MM5203 2048-bit MOS PROM (256 x 8 or 512 x 4)
MM5231 2048-bit MOS (factory programmable) ROM
MM5241 3072-bit Tri-State static MOS ROM (64 x 6 x 8)
MM5232 4096-bit Tri-State static MOS ROM (512 x 8 or 1024 x 4)

Free Film Coupon. Sirs: sign me up for a free private showing of The National Semiconductor Memory Seminar Film in my office on _____ . I understand that crackerjacks and a projectionist/ applications engineer will be provided free. Would also like _____ complimentary "Admit One" tickets (maximum 25) to pass out to my friends and co-workers.

Name _____ Phone _____

Company _____

Address _____

City _____ State _____ Zip _____

Mail to: National Semiconductor Corporation,
2900 Semiconductor Drive, Santa Clara, California 95051.

National

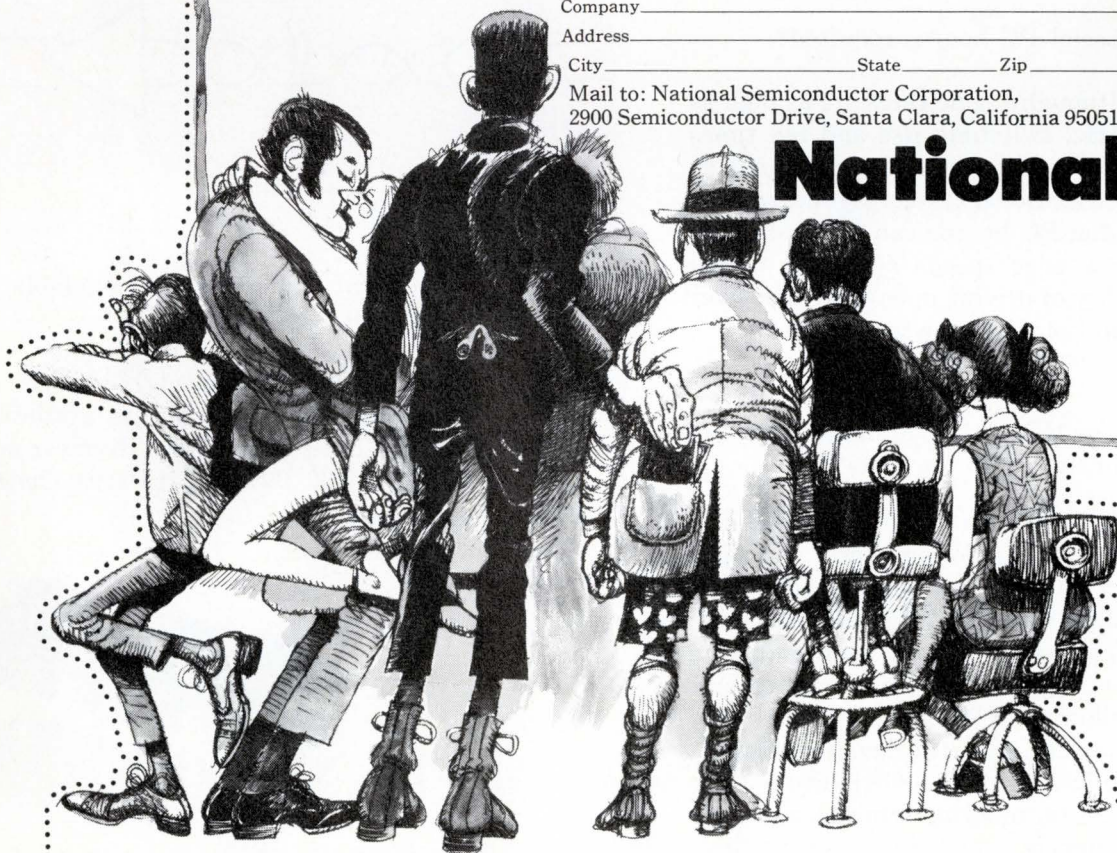

Some straight talk about **MECL 10,000...**

Perhaps you have already evaluated MECL 10,000 and discovered the many ways your system performance can be improved. Or, you may have questions concerning its application and you are considering various logic options. Here are a few answers to questions commonly asked. And if you don't know the answers, don't worry, we'll show you how to become a MECL 10,000 expert.

Q. How fast is MECL 10,000 and can it be adapted to very high speed systems?

A. MECL 10,000 offers 2 ns gate delays combined with low power dissipation (25 mW/gate). Where necessary, MECL 10,000 is compatible with MECL III to "shift up" for the high data rates required in critical timing chains.

Q. Are special PC boards required?

A. No. Although toggle rates are as high as 150 MHz, switching rise and fall times are slow enough (edge speed 3.0 ns) so that conventional system layouts such as two sided PC boards can be used. Also, the slow edge speeds allow the added flexibility of driving open wire, wire over a ground plane, wirewrap, or coax.

Q. How can MECL 10,000 improve system performance and cut costs?

A. MECL 10,000 provides design flexibility in many ways. For instance, the open emitter outputs and high impedance inputs allow wire-"OR"ing of several levels of gating, with a marked savings in gate and package count. Open emitter outputs allow data "bussing" and two-way data transfer. Also, the open emitter outputs allow complete flexibility in the choice of terminating schemes and logic interconnects.

Complementary (OR/NOR) outputs provide simultaneous "true" and "complement" functions, minimizing gate and package count in a system. And the complementary outputs provide excellent twisted pair (differential) line drivers at standard gate prices.

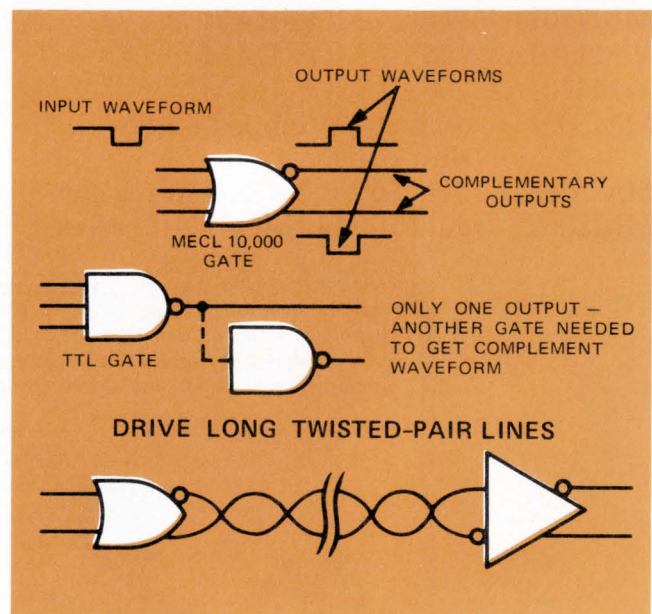

Q. How many functions are available in MECL 10,000?

A. Motorola has introduced 16 devices to date and now two more are available; the MC10116 Triple Line Receiver and the MC10160 Twelve-Bit Parity Generator/Checker.

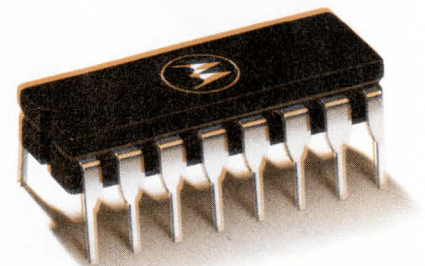

to help you eliminate the alternatives

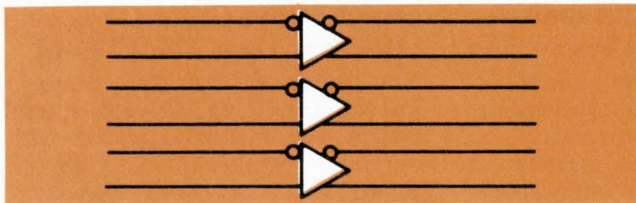

MC10116 Triple Line Receiver — A triple differential line amplifier for sensing differential signals over long lines. Also useful as a Schmitt trigger, or in applications where a stable reference voltage is necessary.

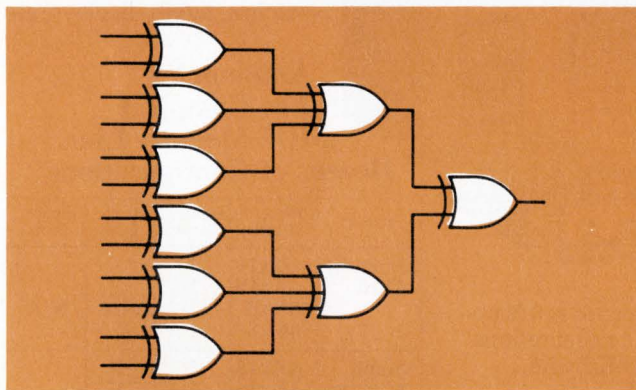

MC10160 12-Bit Parity Generator/Checker. Useful for high speed detection or generation of parity on long data words with minimum package count. One package offers nine EXCLUSIVE-OR gates internally connected to provide odd parity checking or generation.

Additional devices will shortly be introduced including:

- Multiplexers (Dual 4-to-1, Quad 2-to-1)
- Universal Counters (Binary and Decade)
- Universal Shift Registers
- Flip-Flops (100 MHz, 200 MHz, 500 MHz)
- MECL-to-MOS Interface (for memory systems)
- Buss Drivers/Receivers
- 16 x 4 Fast RAM, plus other memory configurations

MECL 10,000 eliminates the alternatives. Evaluate and compare!



MECL and MECL 10,000 are trademarks of Motorola Inc.

MOTOROLA MECL
... for faster computers & systems

Q. Is MECL 10,000 a single source logic family?

A. Definitely not. MECL 10,000 will be second-sourced by Signetics and several others will be announced shortly.

Q. Are special regulated power supplies necessary?

A. Not at all. MECL 10,000 operates over a wide range of supply voltages and there is a minimum change in operating characteristics within a $\pm 10\%$ supply voltage. Also, constant noise immunity is guaranteed over the new wide temperature range of -30°C to $+85^{\circ}\text{C}$.

Q. What special cooling requirements are required?

A. No special cooling is required. MECL 10,000 low power gates eliminate cooling and power distribution problems and insure long term reliability. Operate in still air or forced air.

You still have questions? We now have a new MECL 10,000 book covering MECL 10,000 specifications, design rules and applications. Be a MECL 10,000 expert, write to Motorola Semiconductor Products Inc., P.O. Box 20912, Phoenix, Arizona 85036 and ask for "MECL 10,000 Facts." And for immediate evaluation devices call your local Motorola distributor.

6 important announcements concerning a Compleat line of MOS memory systems

Announcing The Compleat MOS Memory Card. 73,728 Bits. You Can Buy One For Just \$1,859.

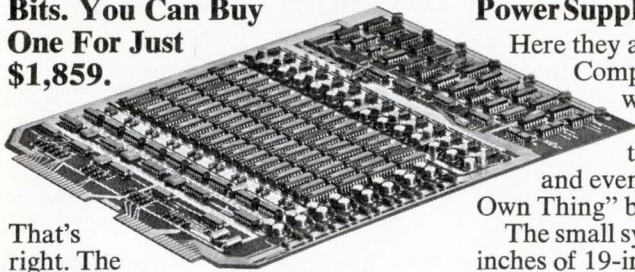

That's right. The single card price for our 72 chip memory is only \$1,859. That's just 2.5¢ a bit. And much less in quantity. It's a compleat memory too, with address and data registers, refresh, and timing controls. All you need is the power supply. Our compleat memory card is available in 4K by 18, 4K by 16, 8K by 9, and 8K by 8. And our TTL tri-state output logic makes it easy to assemble into larger systems.

Announcing The Compleat OEM Package. You End Up With The Manufacturing Rights

We'd like to sell thousands of cards to one customer, but we'll settle for a couple of hundred. So when you take delivery on your 200th card, we'll also include at no charge, the compleat art work, manufacturing drawings, test procedures



and vendor lists.

Which means you can eliminate the high cost of design and development yet end up with your own production when the chips are down and the volume is up.

Another advantage. You can get into production faster. And with product life cycles becoming shorter, launching a new product quicker can often be the key to success.

Announcing The Compleat MOS Memory System With Built-in Power Supplies And Testers Too

Here they are. A whole line of Compleat Memory Systems with built-in power supplies, memory testers, option boards and even a unique "Do Your Own Thing" board.

The small system occupies just 3½ inches of 19-inch rack space and provides typical memories of 4K by 36, 8K by 18 or 16K by 9.

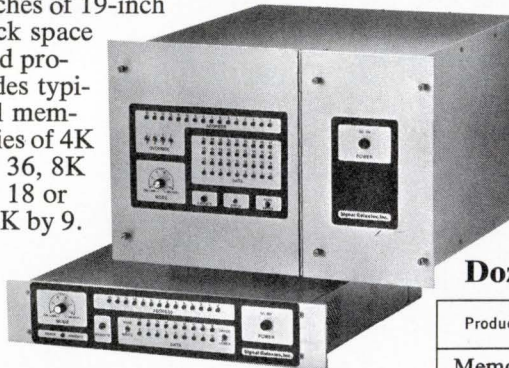

Our large system (12¼ inches of rack height) holds up to 8 memory cards for configurations such as 32K by 18 or 16K by 36.

With dozens of combinations to choose from, you'll find it a snap to order the memory to fit your exact requirements.

Announcing The Compleat Built-In Memory Tester With Six Selectable Modes

It's easy to run our memory systems through their paces with the optional built-in memory tester which has checkerboard, refresh, unique patterns, walking ones, all ones and all zeros tests selectable from the front panel. In addition to the automatic test modes, convenient LED pushlight switches are included to set up address and data patterns for

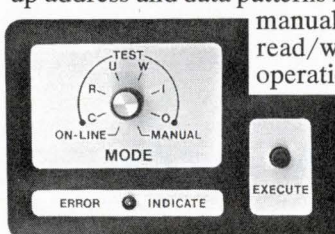

manual read/write operations.

Announcing Compleat System Design Using Our "Do Your Own Thing" Card

You can convert our memory into just about anything you want—special system, computer or controller—with our unique "Do Your Own Thing PC Board" which has 150 IC sockets with wire wrapped pins. Here's all you do. Just send your wire lists to us and we'll wire wrap to your design specs. You plug in the ICs and the result is "Instant Special". There's also room on the front panel for switches, lights, displays, etc.

Announcing The Compleat MOS Memory Line. Dozens of Configurations

Product	Word/Bit Structure	Memory Cards	Tester Cards	Option Cards
Memory Card	4Kx18	1		
	4Kx16	1		
	8Kx9	1	N/A	N/A
	8Kx8	1		
Small Memory System	4Kx18	1	1	
	4Kx16	1	1	
	8Kx9	1	1	
	8Kx8	1	1	
	4Kx36	2	1	N/A*
	4Kx32	2	1	
	8Kx18	2	1	
	8Kx16	2	1	
16Kx9	2	1		
16Kx8	2	1		
Large Memory System	16Kx18	4	1	1
	16Kx16	4	1	1
	8Kx36	4	1	1
	8Kx32	4	1	1
	24Kx18	6	1	1
	24Kx16	6	1	1
	12Kx36	6	1	1
	12Kx32	6	1	1
	32Kx18	8	1	1
32Kx16	8	1	1	
16Kx36	8	1	1	
16Kx32	8	1	1	

*Options contained on built-in tester board.

Write for our full color brochure

SIGNAL GALAXIES, INC.

A Subsidiary of the Signal Companies Inc.
6955 Hayvenhurst Avenue
Van Nuys, California 91406
Telephone (213) 988-1570

The Compleat Memory Makers

MEMORIES:

the users speak out

Stephen A. Thompson, Western Editor—Los Angeles

Serving potential customers begins with finding out what their needs are. Advertisements and articles about memories abound, but inputs from the supposed benefactors of this paper blizzard are scarce. Often they are told what's good for them, instead of being asked what they want.

A memory manufacturer, who wishes to remain anonymous, contacted 2,000 potential users by mail in May, 1971. They were mostly system design engineers, minicomputer designers, data communications engineers, system analysts, and senior design engineers at large computer companies. The manufacturer offered a free felt pen in return for answers to 10 questions. Data from the 779 responses has recently been made available to **The Electronic Engineer**—with the results of our analysis presented here.

It is worth noting that 779 memory users is a whopping number for statistical purposes. Gallup polls and TV rating services only use about 1,200 inputs to determine opinions of over 100 million potential voters and viewers, often with painful accuracy. The EIA will use inputs from only 18 companies to make its 1972 10-year forecast of the government electronics industry.

None of the respondents were told the name of the company. After reading the offer for the felt pen, the survey began.

Survey questionnaire

One of our clients is planning to produce a Semiconductor Memory System for the general memory market. A few minutes of your time will be most helpful in allowing him to determine the most desirable product features.

Briefly, the memory system is to be constructed with up to 72 MOS RAM 1024-bit devices on a single printed circuit board. The basic card will be organized as a 4096-word by 18-bit memory with a cycle time of under 600 ns.

Multiple-card system configurations of up to a half million bits are planned.

For the potential memory requirements you or your company may have in the next 18 months, how would you fill in the boxes below?

Question 1: Most of my requirements can be satisfied with a _____ nanosecond cycle time. (736 responses)

We hear a lot about speed. How important is it? Figure 1 shows that a 1- μ s cycle time satisfies over 23% of the users, but less than 6% are willing to go slower, at least in new designs. The groupings near 500 and 600 ns comprise another 30½%, though the 600-ns group may be influenced somewhat by the introduction. The remaining 40½% were distributed fairly evenly in 100-ns intervals from 100 ns and below to over 1 μ s. Volatility, which is discussed in Question 4, shows no significant trend with cycle time. Most mainframe memory technologies can compete in the 500 to 1,000 ns range and that is the speed most of the market offers.

Question 2: My minimum configuration would be _____ words by _____ bits. (721 responses)

Question 3: My maximum configuration would be _____ words by _____ bits. (651 responses)

Figure 2 gives some insight into the size that users desire. *Caution:* the capacity axis is not to scale, but is divided into convenient sizes. Unusual configurations are rounded up to the next nearest size. Above 1 kbit, capacities are rounded into "standard" kilobits or megabits. For instance, a 16,384 word by 16-bit memory is called 256 kilobits, not 262.144 kilobits.

Because several people specified word or bit sizes that were too large for the computer card format, only 746 "minimum" and 651 "maximum" responses are plotted. Though there are 95 fewer "maximums" plotted, Fig. 2 still gives a good indication of desired capacities. The mean shifts a factor of eight, from 32 kbits for the "minimums" responses to 256 kbits for the "maximums" responses.

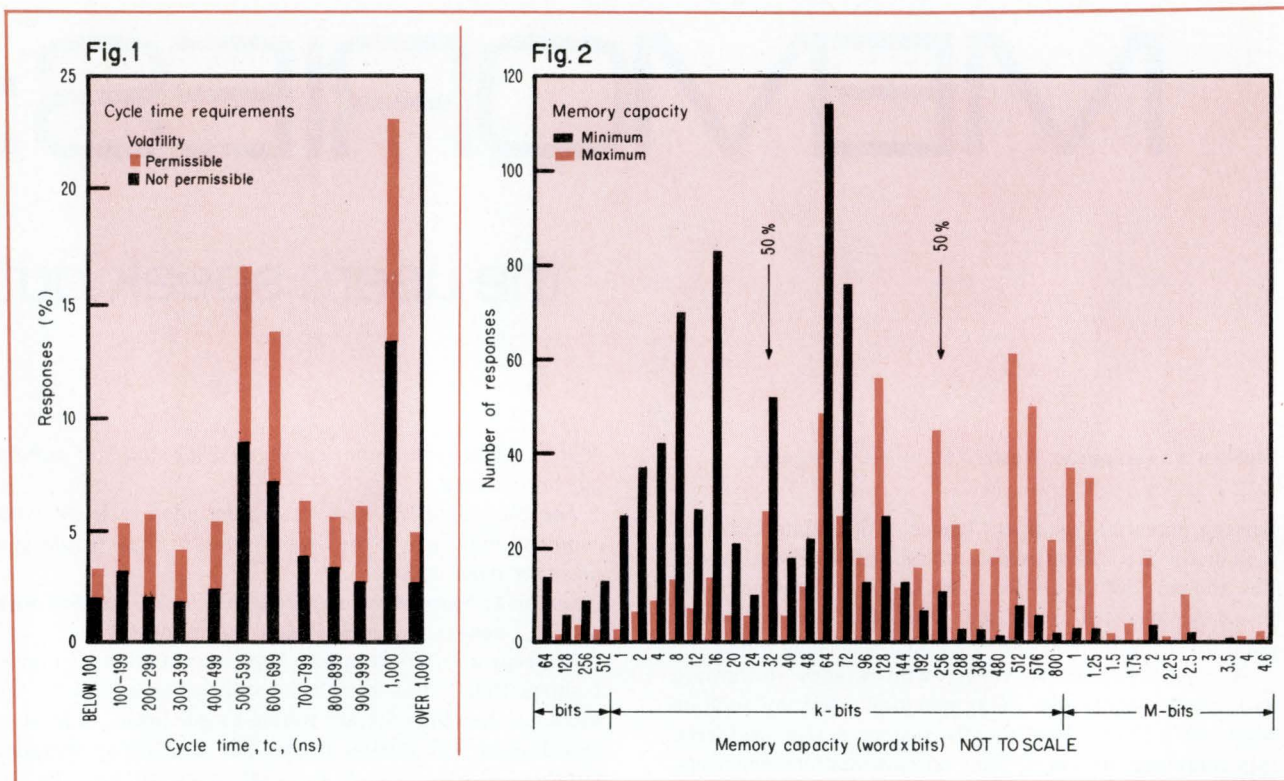

The most popular configuration mentioned in the "minimum" question was 4k x 16-bit. Over half of the responses specified a configuration between 1k and 4k and between 8 and 24 bits.

When talking about "maximums," the single most popular arrangement was 32k x 16-bits, or roughly the same factor of eight shift in capacity between minimum and maximum we saw in Fig. 2.

Question 4: Volatility of the memory data, in the event of power failure, IS or IS NOT permissible in my application. (779 responses)

How important is volatility, the much ballyhooed shortcoming of semiconductor memories? Well, 44.1% said that they could stand it; 52.8% said that they could not; and 3.1% had reservations. Without special precautions such as a standby battery, this closes over half of the memory market to semiconductors. The distribution of volatility as a function of cycle time is shown in Fig. 1.

Question 5: I consider a fair price for the memory card (4k x 18 at 600 ns) to be _____ ¢ per bit in small quantities. (675 responses)

Here we get a chance to chart the users' stated willingness to pay. In Fig. 3, we assume that a person who would pay 9¢ per bit would not be refuse to pay 2¢, etc.

Almost 10% said they thought a fair price would be 10¢ per bit, or more; 27% would go as high as 5¢; 68% would

put in their 2¢ worth; and 8½% thought they should get it for less than 1¢ per bit. The manufacturer guessed that about 2½¢ per bit would be appropriate, and that is a bull's eye on the 50% area.

These results strongly support the assumption by this author* that non-volatility cannot be sold for a premium. The average of the 310 who said volatility was permissible was 2.75¢ per bit. The 346 non-volatile proponents actually offer less—2.58¢ per bit. The average for all respondents, including don't-cares, is 2.68¢ per bit.

Question 6: A built-in tester IS or IS NOT one of my requirements. The price of the built-in tester should not exceed _____ dollars. (779 responses)

About one-fifth of the respondents said a built-in tester was required; 77.9% said it was not; and 2.6% thought they might need it. Though it was not specified just what this tester was supposed to do, 193 respondents from both the "need" and "don't need" classes specified a price they were willing to pay. About 15% said they would spring for \$1,000 or more; 35% would go \$500; and 60% would go \$200. The manufacturer, who originally anticipated a \$600 tester option, now finds that realistic price is almost double that.

*Stephen A. Thompson, "A Way of Thinking Memories," *The Electronic Engineer*, Dec. 1970, pp. 30-34.

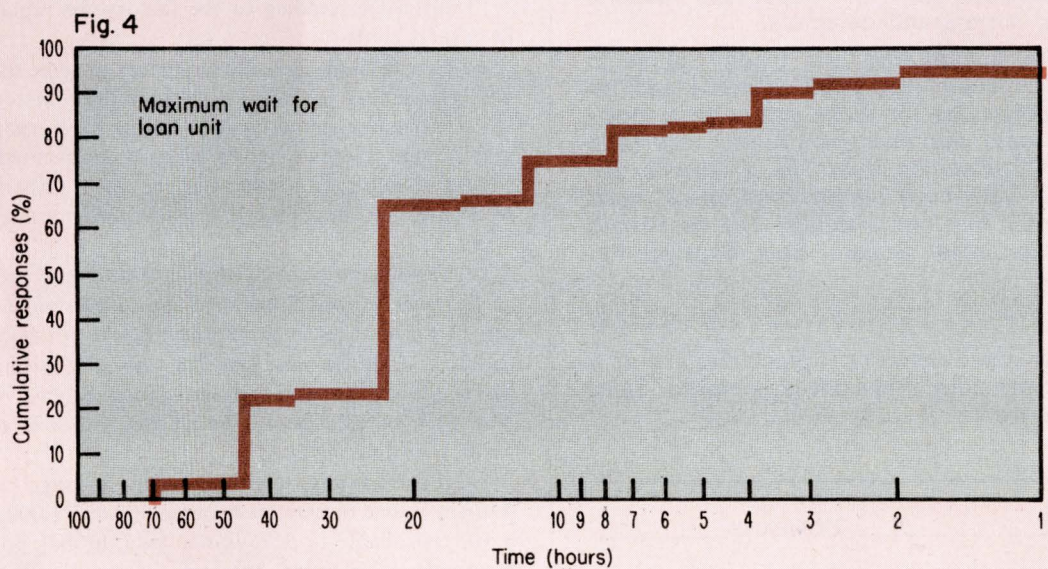
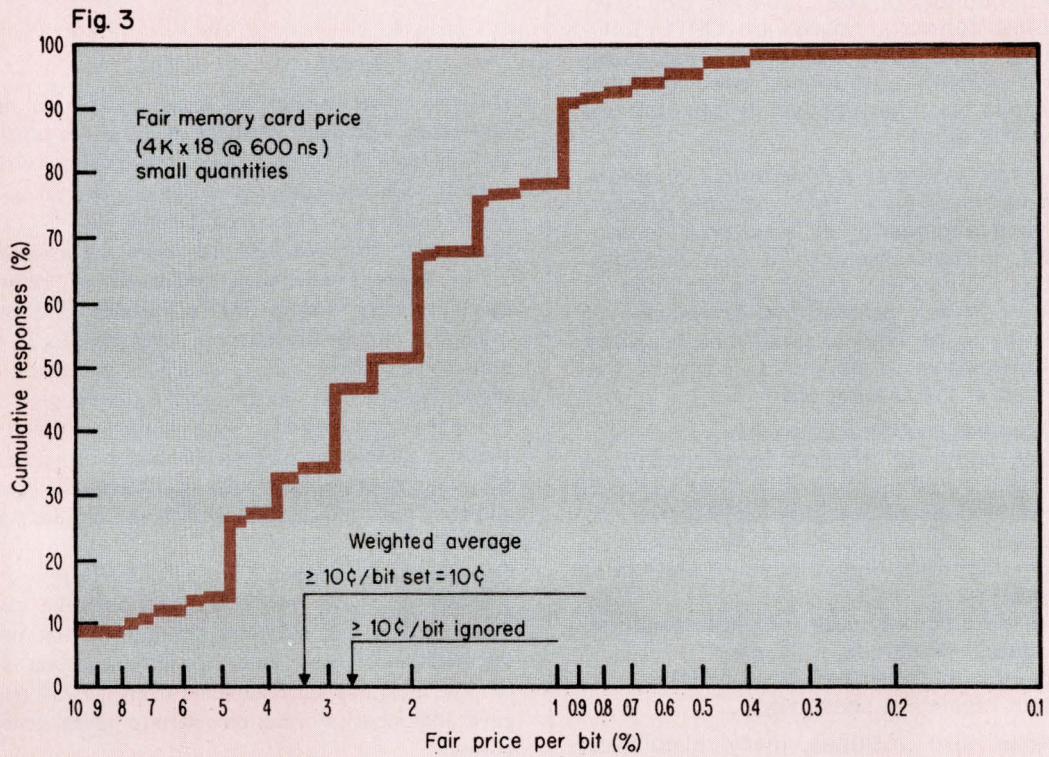

NOW... a COURSE on the New technology of optoelectronics

Compiled by the editors of *The Electronic Engineer*, this is truly *the* definitive course on OPTOELECTRONICS. It is a practical and tested demonstration which will enable you to master even the most complex assignments, *many of which can now be solved for the first time!*

The Course is an essential technological contribution to all those involved in the research, design, development and engineering of electronic components, circuits, systems, equipment and services. Completing this Course will enable the engineer to acquire a thorough and professional knowledge of optics and at the same time to qualify as a skilled buyer of optoelectronic components. Some of the subjects covered in the Course are:

- The background** on Optoelectronics . . .
- Physics of light—as applied to semiconductors . . .
- Physical definitions of optoelectronic terms . . .
- Materials—for both sources and detectors . . .
- Sources — Light-emitting diodes — Materials, efficiency . . .
- Detectors—Photoconductors (or photoresistors) photodiodes—Materials, efficiency . . .
- Amplifiers—Phototransistors, photoFETS—Materials, efficiency, sensitivity . . .

The Course also includes many simplified, practical applications for optoelectronic components such as light choppers, modulators, signal isolators, card and paper-tape readers, counters, sorters and detectors.

This complete, authoritative and *timely* Course in Optoelectronics costs just \$4.00 postpaid and includes an examination for those who wish to qualify. *All who pass the examination will receive a Certificate of Completion from The Electronic Engineer.* To get your copy simply send check, cash or money order to Course Editor, The Electronic Engineer, One Decker Square, Bala Cynwyd, Pa. 19004.

E-12

Send me your new Course on Optoelectronics at a cost of \$4.00 per copy. Payment is enclosed. Send the Course to me at:

NAME _____

ADDRESS _____ COMPANY _____

CITY _____ STATE _____ ZIP _____

Check here if you want special quantity prices E-12

Question 7: For my application, the memory system SHOULD or SHOULD NOT include the power supply. I would be reluctant to supply more than _____ different dc voltages to the memory. (742 responses)

About 40% want a power supply included, while the other 60% would rather supply their own. The number of voltages that users want to limit the memory to are:

No. of Voltages	Respondents (%)
1	8.8
2	54.6
3	29.3
4	4.8
5 & over	2.5

Question 8: Accessibility and removability of all major sub-assemblies, e.g., panel, memory cards, power supply, should be from the FRONT or REAR of the memory system.

Of the 603 responses, 62.8% prefer a frontal assault, and 37.2% prefer to sneak up from behind.

Question 9: Provided that loan units are available within _____ hours, a maintenance philosophy of "return to factory" for repair IS or IS NOT acceptable. (715 replies)

Some minimum downtime is acceptable to 71.4%. Loan units were unacceptable to 28.6% of the users. Figure 4 shows the wait for loan units that 468 people claim they can endure. Almost 25% were willing to wait two days, while an astonishing 67% would tolerate a one-day delay. Many users seem to recognize that memories break down, and they are willing to swing with the maintenance problem.

Question 10: Comments, if any. (199 replies)

When you know precisely what everyone wants, you don't need to ask questions. Important, but overlooked features may show up here, before the product is marketed. The most popular comments from the 199 people who gave additional information fell into seven general categories:

- The memory should be TTL compatible.
- Refresh should be automatic.
- Instead of sending to the factory for replacements, keep spare cards.
- Non-volatility is really important to some users, usually because they put memories into military systems.
- Expanding memories and altering their organizations may become the national pastime. Some wanted smaller chunks of words with fewer bits per word. Others wanted assurance that the memory could expand, usually to 32k words.
- Opinions on core and MOS were thoroughly mixed, with no clear-cut winner. Some said that until semiconductors caught up to cores in price, they would not budge from their cores. Others were grateful that MOS technology finally allowed them to dump those expensive cores. About all you can surmise is that inexpensive is good, but we all knew that anyhow.

So, if there is any such thing as an "average" memory, it might be one that cycles between 500 and 1,000 ns, is 4k x 16, expandable to 32k, is non-volatile, has no built-in power supply or tester, operates on two dc voltages, has front access for a loan unit less than 24 hours away, and costs less than 3.4¢ per bit. E

ARRAY OF HOPE

For Low-Cost, Bipolar LSI

Introducing a whole new concept in design flexibility — Motorola's 112-gate TTL array — the realization of economical custom LSI.

ARRAY CONCEPT PROVIDES MAJOR DESIGN ADVANTAGES

1. The design has already been proven except for the interconnections whose logical integrity can be established. Through Computer Aided Design probability of a successful part from the initial design is high.

2. Turn-around time is low for production quantities. And the array's predesigned cells make the use of Computer Aided Design easy.

3. Custom design costs are cut to a minimum since only metalization paths need be determined.

Besides yielding customized circuits in minimum time at low cost, the array concept provides a better speed/power product, lowers power consumption, and offers an overall reduction in system cost.

112 GATES AWAITING YOUR INSTRUCTIONS

Basically the device is a matrix array of 8 x 14 TTL NAND gates completely processed except for metalization. The designer has only to specify interconnection of the 14 8-input gates and 98 4-input gates to meet his overall function requirement. The array is then transformed into a custom circuit by designing metalization patterns which connect the gates into the desired functions.

Each cell can be used as a high-level, low-level or buss gate by connections made on the first layer metal. Signal wiring is done on second and third layers with power and ground runs on first and third layers. And AOI and totem pole configurations can be implemented by a simple combination of cells.

HOW SOON AND HOW MUCH?

Using the array design, prototype samples can be available within three months ARO, with limited production quantities following six weeks later. And non-recurring design costs range from \$6 - \$12,000 depending on extent of computer analysis required. Unit cost of finished parts ranges from \$45.00 (1K) to \$23.00 (25K). Design cycles are shortened by months and costs by one-third through application of the array concept.

START SAVING NOW

For further information on the 112-gate array write to Motorola Semiconductor Products Inc., P.O. Box 20912, Phoenix, Arizona 85036. Or for immediate assistance, call Larry Bradfield, collect, at (602) 962-2151. Larry will show you how to translate bipolar customizing into savings.



MOTOROLA LSI Arrays
— New Concepts in System Design

Output Limit Indicator Light,
Variable Width Pulse,
Sweep Width Control,
Frequency Analog Output,
Manual Trigger, etc.

More features for \$495 than any other Function Generator



IEC
**INTERSTATE
ELECTRONICS
CORPORATION**
A Subsidiary Of A-T-O Inc.
Dept. 7000, Box 3117
Anaheim, Calif. 92803
(714) 772-2811,
TWX 714-776-0280
Telex Nos.
655443, 655419

**The new F34 proves that a
Function Generator doesn't have
to be expensive to be great!**

Read the panel! The Output Limit indicator Light — unique! It guarantees you an unclipped waveform. The Sweep Width control — foolproof and calibrated. Frequency analog output, variable width pulse and manual trigger — they're all there and more. See for yourself! For details on IEC's complete Function Generator line, contact John Norburg today.

**The new SERIES 30 includes 3 other models
costing even less, starting at just \$295!**

DATA COMMUNICATIONS



International
Communications Corp's
Sang Whang:
the interconnection crisis

Data Terminals, Part 5—
the 'new' generation: fax,
no-impacts, & data adapters;
plus, the exam.

Data communications
news and products

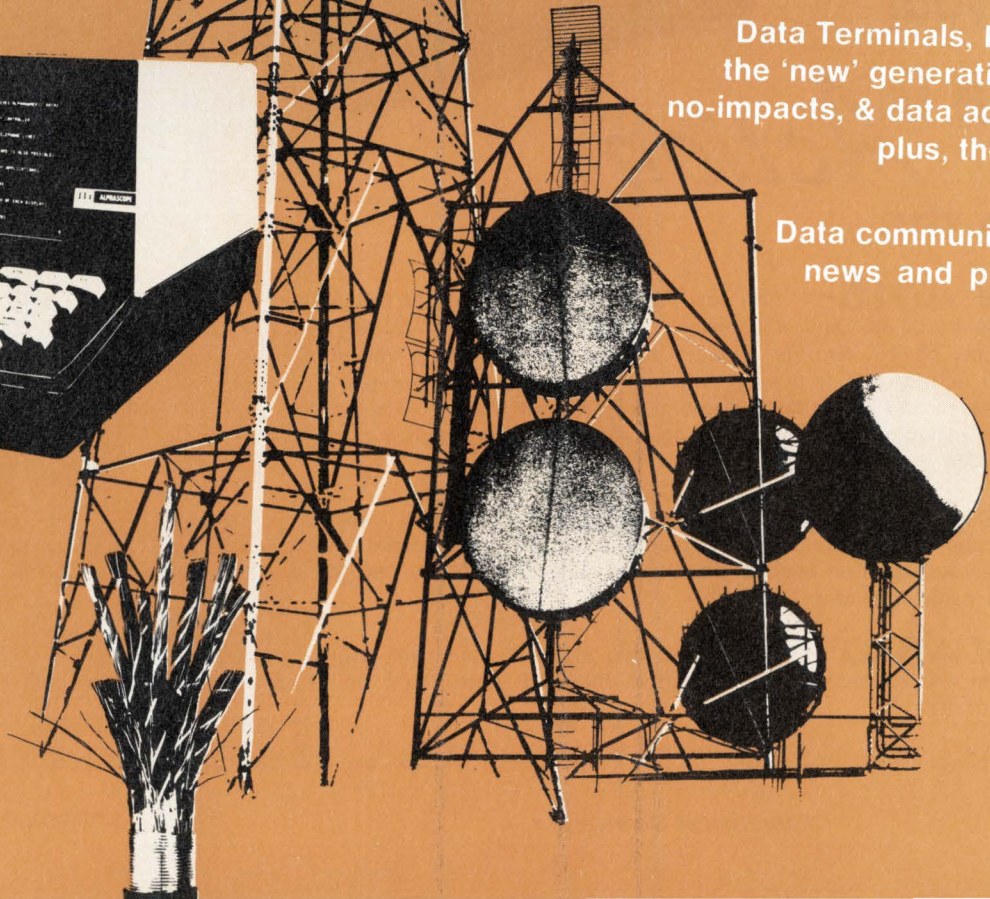

TEKTRONIX®

introduces

the first

BUSINESS-ORIENTED GRAPHING TERMINAL

\$3950
or less



put your
data in *Action*
with the

NEW 4010 — The new TEKTRONIX 4010 provides instant graphs in a variety of formats to quietly and economically assist your decision-making analysis of budget performance, clinical records, product and component testing, inventory or process control, sales activity and forecasts. Information needed quickly in graphical form for business, research and industrial decision-making is now feasible with the 4010 for only \$190 per month including maintenance. Single 4010's may be purchased for \$3950, decreasing to only \$3358 each for 20 or more.

NEW PLOT-10 — The new PLOT-10 software package for 4010 users makes graphing and alphanumeric manipulation of computerized information easy and immediately available on over 20 timesharing services, with IBM 360/370 systems and with numerous mini-computers.

NEW 4610 — Convenient, dry, 8½ x 11-inch hard copies of the displayed information are available in seconds from the 4610 Hard Copy Unit with simple push-button operation.



TEKTRONIX®
excellence in
information display

U.S. Sales Prices FOB Beaverton, Oregon

Tektronix, Inc., P.O. Box 500, Beaverton, Oregon 97005

The interconnection crisis

When a common carrier leases one of its voice grade transmission lines for data communication purposes, the customer usually gets one of the channels described as Channel 3002 lines under Federal Communications Commission Tariff No. 260.

The Tariff is considered a contract between the common carrier who provides the line, and the customer who leases the line. When the line does not meet the specification described in the Tariff, the common carrier has an obligation to correct the discrepancies. *Traditionally, this contract is written by the common carriers, and the user has no say about the specification in the contract. Therefore, the specification in the Tariff usually is very loose. Furthermore, many of the pertinent parameters of the line required for efficient data communication are not even included in the Tariff specification.* Obviously, there is no incentive on the part of the common carriers to tighten the specification of the line.

One might say that it is the responsibility of the FCC's Common Carrier Bureau to look after the interests of the public. However, the Common Carrier Bureau of the FCC is very short handed, operating on a very low budget. One wonders to what extent this has been affected by the lobbying of special interest groups, and a lack of real understanding of the need by many legislators. As a result, the staff of the FCC's Common Carrier Bureau is smaller than similar bureaus operating at the state level. It would be a vast understatement to say that the FCC's Common Carrier Bureau needs additional technical personnel to adequately regulate common carriers' services.

Introducing Sang Whang

Those who expected to doze off their lunch while attending Session 6A on Interconnection (of non-Bell devices to telephone lines) at this year's IEEE Convention were in for a big surprise. The surprise was Sang Whang, Vice President and Technical Director of Milgo's International Communications Corp. Unlike most participants of like sessions who present the most controversial points in gray tones, Whang made his views known with humor, emphasis, and a touch of sarcasm at AT&T's expense. One of the founders of the newly formed Independent Data Communications Manufacturers Assn., an organization devoted to presenting the independent modem maker's viewpoint on interconnection, Whang's technical specialty is the application of the mathematical theory of data communications to the real world of comm techniques and devices. He developed the technique of narrow band, high-speed synchronous data transmission, which was first implemented in the modem model 4400/24 in 1966. He was also responsible for the "Whang filter," a new family of equi-ripple phase delay filters. Prior to that, Whang directed the design of highly sophisticated passive networks for filters, equalizers, and simulators at Milgo Electronic Corp. and SEG Electronics Co., Inc.

For a more fanciful and amusing exposition of Mr. Whang's views on interconnection and Ma Bell, read "A (sometimes) grim fairy tale." To receive a copy,

Circle Reader Service #384

Some good, however, has come out of this situation. The FCC Commissioners are inclined to encourage competition rather than regulate everything. Many landmark decisions by the Common Carrier Bureau have changed the nature of the communications industry by stimulating competition.

As the foremost example of common carriers, AT&T has two principal types of business: one that falls under natural monopoly which still must be regulated, and the other one that will be controlled by competition. Separating one from the other to make sure that the monopoly does not subsidize the competitive part of the business is recognized as the most difficult problem affecting the complexion of the regulation itself.

The area of inadequately defined technical specifications in the Tariff is a lesser known technical problem which, unless properly checked, could create unfair competition. For example, AT&T competes against independent data set (modem) manufacturers in providing high-speed data transmission equipment. They also provide the transmission lines for this data communication. In high-speed data transmission, many parameters of the line characteristics (which are not included in the Tariff), can adversely affect data transmission.

I am not suggesting that AT&T personnel intentionally give poorer quality lines to users of competitive modems. As a matter of fact, the Long Lines people at 195 Broadway are trying very hard to provide good lines to everybody. But it is only natural that an operating Bell company would be inclined to try harder to provide better lines to the customer who uses a Bell data set. Without a tariff specification which the operating company must meet, a conflict of interests exist for the Bell data specialist and installer. If he tries very hard to improve the line characteristics to make a competitive modem work, he is, in effect, jeopardizing the sales of his own modem service. On the other hand, it is only natural that he should switch the line or try his best to improve the line if it would improve the performance of modems which his company supplied. With adequate specifications in the Tariff, he would have no difficult decision of this sort to make. His natural obligation would be simply to meet the specifications.

With the shortage of enough technically qualified personnel in the Common Carrier Bureau of the FCC, I think the responsible industries, representing independent manufacturers and the large users of data communications, should combine their resources to hire technically qualified personnel to examine the Tariff and recommend a new Tariff to adequately protect the interests of users under the supervision of the FCC's Common Carrier Bureau. We would then have a true contract, properly negotiated and settled by both parties.





Line Drivers and Receivers

Choose what you need

Differential, dual, quad, EIA std., MIL std., TTL/DTL compatible, pull-ups, pull downs . . . ?

It's not a question of what we have; it's a question of what you need. Because this is the largest in-stock assortment of line drivers and receivers available from one source, you won't have to trade-off performance for delivery . . . or price.

Quality and delivery are assured by TWF (Tailored Wafer Fabrication), a proprietary process that makes possible consistent initial wafer yields much higher than the industry average.

And you get a quantity discount on the *total* number of devices you order from Qualidyne — mix drivers and receivers, mix types, or even mix linear and digital IC's. There is no need for you to restrict your choice to one or two devices just because they are used in quantity elsewhere in your company.



Tailored Wafer Fabrication:
A unique innovation in semiconductor manufacture.



Want more information on these Line Drivers and Receivers? Call your Qualidyne representative, or contact us direct. And remember, we also offer sense amplifiers, diode arrays, monolithic duals, linear op amps, and semiconductor memories. Qualidyne/1230 Bordeaux Dr., Sunnyvale, Ca. 94086/(408) 734-3021.

Sales Representatives: Arizona, Scottsdale, Compar, (602) 947-4336 • California, Burlingame, Compar, (415) 347-5411 • California, Santa Ana, Rical Associates, (714) 557-6543 • Colorado, Denver, Electrodyne, (303) 757-7679 • Florida, Ft. Lauderdale, Beacon, (305) 772-4298 • Florida, Maitland, Beacon, (305) 647-3498 • Georgia, Atlanta, Beacon, (404) 351-3654 • Illinois, Des Plaines, Compar, (312) 775-0170 • Massachusetts, Lexington, Contact Sales, Inc., (617) 861-1550 • Michigan, Garden City, Compar, (313) 425-1235 • Minnesota, Minneapolis, Compar, (612) 922-7011 • Missouri, St. Louis, Compar, (314) 567-3399 • New Jersey, Clifton, Compar, (201) 546-3660 • New Jersey, Haddonfield, Sunday-O'Brien, (609) 429-1526 • New Mexico, Albuquerque, Compar, (505) 265-1020 • New York, Albany, Compar, (518) 489-7408 • New York, Endwell, Compar, (607) 723-8743 • New York, Cicero, Compar, (315) 471-3356 • New York, Fairport, Compar, (716) 271-2230 • North Carolina, Winston-Salem, Compar, (919) 723-1002 • Ohio, Fairview Park, Compar, (216) 333-4120 • Ohio, Dayton, Compar, (513) 890-9260 • South Carolina, Spartanburg, Beacon, (803) 576-7462 • Texas, Dallas, Compar, (214) 363-1526 • Texas, Houston, Compar, (713) 667-3420 • Virginia, Falls Church, Beacon, (703) 534-1673 • Washington, Kirkland, Compar, (206) 822-4191 • England, Electroautom Limited, Maidstone 54224-6 • France, Quatrelec S.A., 270.71.74—270.03.81 • West Germany, Wetricon GMBH, 08111-433635 • Japan, MTT International, (03) 359-4648 • The Netherlands, Eltron N.V., 020-928444 • Sweden, Nordisk Elektronik A.B., 08-24 83 40.



DATA TERMINALS:

Part 5

Arthur J. Boyle, Managing Editor

In the preceding installment, we discussed three specific types of terminals—teletypewriters, alphanumeric CRTs and tone-generating devices. The majority of terminals in service today fall into one of these three categories. This installment, however, is concerned not with how the market looks today, but rather with what is going to be important tomorrow.

Any attempt to guesstimate about the decade ahead must consider one extremely important fact. During the mid and late 1970's, faster, more reliable, and more economical digital transmission facilities are going to be available. The supplier may be the specialized carriers such as Datran and MCI or it may be Mother Bell. Most likely, you will be able to mix and match common and specialized carriers to come with an optimum configuration for each application. Who is going to bill you for these services is not important. What is important is that these services will be available, and they will have a tremendous impact on a great many phases of our society.

One area which stands to gain as much as any from this situation is facsimile. While working on the story which begins on the next page, Xerox installed one of their portable facsimile machines in our editorial offices. The convenience of fast, accurate transmission of copy and illustrations brought home the promise of facsimile in the years ahead. The combination of better transmission facil-

ities and newer generations of equipment will make facsimile a viable competitor with many of our more conventional forms of communication. Some insight of what is ahead is provided by the very comprehensive market studies done by Datran. The results of these studies point to a 25% growth in facsimile communications between now and 1975, plus an additional 25% between 1975 and 1980.

The growth of data communications is going to have a significant impact on another type of terminal equipment. Even today, in many applications, a computer talking to a 30 char/s printer is just not an acceptable situation. And it is going to become even less acceptable in the future. The big need is for a printer to fill the void between the conventional slow serial printers and the very expensive line printers. In this installment, we look at non-impact printers, specifically at ink jet devices, as holding the promise to fill this need.

The growth in data communications also promises some problems at the other end of the telephone line. The question is how to stuff all the inputs from newer and faster terminals into the computer. You will also see in this installment how one company solves the line adapter/data adapter problem through the use of firmware.

Since half the fun of any course is seeing what you got out of it, we close this final installment with our exam. Fill it out and mail it to the address shown. If you come up with 70% of the correct answers, we will send you a certificate showing successful completion of the course.



Facsimile communication

Dave Klein, Communication Systems Products
Xerox Corp., Rochester, N.Y.

It began in 1842, when an unheralded Scottish clockmaker successfully transmitted a crude image over a short distance. The process consisted of passing an electrified wire over an original document to translate the image into a signal, while swinging pendulums synchronized the process. Facsimile was born.

Several years later, another pioneer applied an electrolytic solution to the paper at the receiving end. This allowed different shades of gray to be transcribed on the treated paper when charges of electricity were passed through the paper and paved the way for the introduction of the rotating drum.

The first real impact of facsimile on communications occurred in 1924 when the first radiophotos were transmitted from London to New York. This accomplishment was a major step in proving facsimile a useful and important means of getting graphic information from one point to another quickly, exactly and economically.

Facsimile has since become a highly sophisticated communications medium. The value of facsimile equipment is obvious when considering typical or untypical business communications and the problems posed by delivery tie-ups, defective or delayed transcription and spiralling telephone expenses. In one application (although still in the experimental state) the U.S. Postal Service is using facsimile transceivers to transmit business mail between Washington and New York. This is the first stage of what could develop into a facsimile network linking all major post offices in the country.

Present capabilities

The Xerox 400 Telecopier transceiver is a good example of how far facsimile equipment has come since its rather humble beginnings. The "400," introduced in 1970, can transmit a full 8 1/2 x 11 in. page in 4 min., with smaller-size documents taking proportionately less time.

Original facsimile units were bulky, standing consoles that required broadband telephone channels or radio links and were limited to special applications. Extensive use of integrated circuits have changed all that. Today's models have sending and receiving functions combined in a single, compact unit that ties in directly to the dial-up telephone network through a built-in acoustic coupler. Now that facsimile units can operate with the DDD network, the fax market potential consists of all of the 30 million telephones in U.S. business offices.

Another type of available facsimile transmission equipment utilizes broadband transmission facilities (48 or 240 kHz). Long Distance Xerography (LDX) can transmit in 1 min. up to eight 8 1/2 x 11 in. pages of high quality copy (135 scan lines/in.), combining the use of electronic scanning with xerographic printout.

In the LDX scanner, a small spot of light a few thousandths of an inch in diameter is generated by a cathode ray tube. As the light spot scans the document, the darker image areas absorb most of the incident light, whereas the lighter background areas reflect most of it. The reflected light is channeled into a photomultiplier for conversion into an electrical signal. After suitable amplification and conditioning, the signal is converted to a binary output, with one level representing the black areas and the other, the image background. Since the scanner compensates automatically for different copy backgrounds, it can accept wide ranges of colored paper background.

The binary signal received at the LDX printer is used to gate a CRT in the printer on and off. The image on the printer CRT is transferred to the xerographic drum forming a horizontal line scan display. The motion of the xerographic drum provides the vertical scan. The image is then transferred to ordinary paper using conventional xerographic methods.

What is ahead for facsimile

Today's facsimile transceivers have merely scratched the surface. The versatility of facsimile equipment will be increased in the near future by new equipment with higher speed and vastly increased automation and systems' capability. Business users will be able to utilize facsimile systems for greatly increased volumes at significantly reduced costs per copy.

New communication channels will also have a major impact on facsimile services. Broadband lines will make it possible to transmit documents in seconds where it now takes minutes and at little or no increase in terminal cost. Broadband facilities such as cable TV will open the possibility of transmitting hard copy news, weather and financial reports direct to the home at high speeds.

Facsimile will not always remain in its present analog form either. Digital facsimile devices will interface with computers to bring new capability to the computer for instantaneous analysis. Overall, the future of facsimile is bright and the size of the market is staggering.

THE NEW WORD IN DATA COMMUNICATIONS

UAR/T, a GIANT* device. [part # AY-5-1012]

1. the first one-package MOS **Universal Asynchronous Receiver/Transmitter**.
2. a General Instrument LSI subsystem which accepts binary characters from either a terminal device or a computer and receives/transmits this character with appended control and error detecting bits. All characters contain a start bit, 5 to 8 data bits, one or two stop bits, and either odd/even parity or no parity. In order to make UAR/T™ universal, the baud rate, bits per word, parity mode, and the number of stop bits are externally selectable. The device is constructed on a single monolithic chip utilizing MTNS P-channel enhancement mode transistors. All inputs and outputs are directly compatible with TTL/DTL/MOS logic without the need for interfacing components and with all strobed outputs having tri-state logic.
3. the UAR/T is now available in a 40 lead dual in-line package and is priced at **\$30.00 each in quantities of 1-99 pieces and \$22.50 each in quantities of 100-999 pieces.**
4. newest member of General Instrument's family of MOS LSI data communication subsystems which also includes the AY-5-1008 terminal receiver and the AY-5-1010 terminal transmitter; both, too, are immediately available.

*Registered Trademark for General Instrument Advanced Nitride Technology

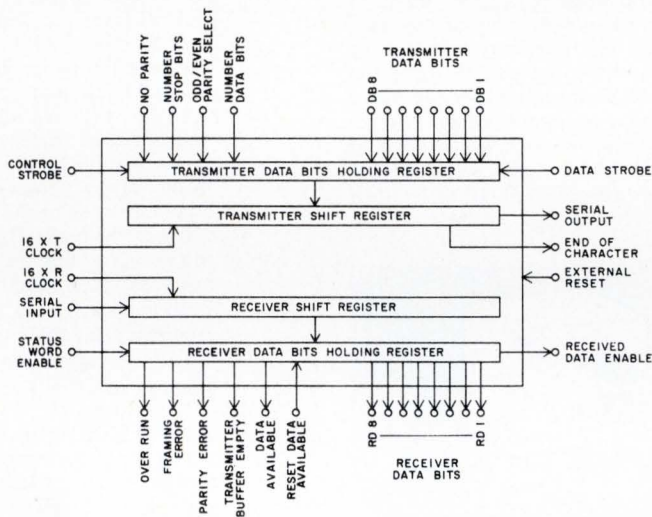

UAR/T—BLOCK DIAGRAM

For complete information call 516-733-3138 or write: Marketing Services Manager, General Instrument Corporation, 600 West John Street, Hicksville, N.Y. 11802, or call, in New York: 516-733-3333; in Chicago: 312-774-7800; in Los Angeles: 213-641-7411. In Canada, call or write: General Instrument Canada, Ltd., 61 Industry Street, Toronto 337, Ontario, Canada, Tel: 416-763-4133. In Europe, write: General Instrument Europe S.P.A., Piazza Amendola 9, 20149 Milano, Italy. In the U.K., write General Instrument U.K. Ltd., Stonefield Way, Victoria Rd., South Ruislip, Middlesex, England. In the Far East, write General Instrument of Taiwan Ltd., P.O. Box 22226, Taipei, Taiwan.

THE WORLD'S MOS EXPERIENCED COMPANY



GENERAL INSTRUMENT CORPORATION • 600 WEST JOHN STREET, HICKSVILLE, L. I., NEW YORK



Basic principles of facsimile

Charles T. Roth, Facsimile Engineer
Xerox Corp., Rochester, N.Y.

The basic principles of facsimile transmission are very closely related to those of television. In fact, facsimile may be called a slow scan television system with a hard-copy output. A small scanning aperture (on the order of 0.01 to 0.010 in.), at the send end of the system, measures the optical density of the original document and converts light to an electrical signal. After transmission over some form of communications link, these signals are used at the receiving end to print out the image in line segment form. To give you some feeling for the resolutions required, a thousand line per inch scan makes the facsimile copy virtually indistinguishable from the original. This is the type of resolution that is required for transmission of, for example, newspaper masters. Resolutions of about 96 scan lines per inch are typical of business facsimile systems where the basic requirement is a readable document. This approximate 10 to 1 difference in resolution has about a 100 to 1 effect on the speed of transmission.

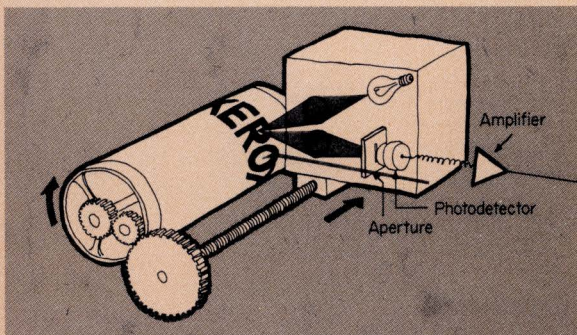

The above figure shows in schematic form the transmitting end of a typical facsimile scanning system. This basic system, one of the first types used for facsimile, is still the most widely used system today. The original document is attached to the drum and rotated past the movable carriage, which, in this case, is moved by a lead screw. Light from a lamp illuminates a small area of the original document while the document is scanned by focusing the reflected light through a lens onto an aperture plate. The aperture plate defines the shape and size of the scanning spot and a photodetector converts the intensity of the light passing through the aperture into an electrical signal which is then amplified and processed for transmission.

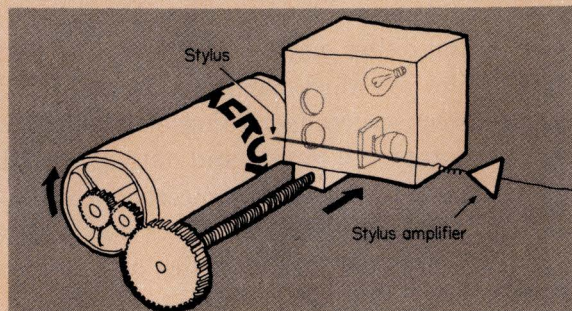

For printing the facsimile copy, the same basic mechanism may be used. As shown above, a piece of electro-sensitive paper is wrapped around the same drum that was used for scanning the original. A small wire stylus, approximately the same size as the scanning aperture, contacts the paper. This stylus is driven by an amplifier which passes a current through the stylus and the conductive paper. As the current is gated on and off, it blackens the paper to correspond to black areas on the original document.

So far, we have ignored the communication channel and assumed that whatever signal was scanned by the scanner would be printed out by the printer. Since we are faced with a bandwidth restricted channel, the signal characteristics of the transmission system must be considered. The typical facsimile system operates today over the ordinary long distance telephone system, which will not pass low frequencies. Consequently, the most common approach is to use the signal from the scanner to frequency modulate the carrier frequencies.

The average attenuation distortion of a telephone channel is a function of frequency. This attenuation is very rapid below 300 Hz and above 3000 Hz. Between 300 and 3000 Hz the response is fairly flat.

The most common fm frequencies used in facsimile today range from 1500 to 2450 Hz with 1500 Hz used for white and 2450 Hz used for black. Various shades of gray result in frequencies between these two limits. Typically, today's facsimile systems are designed with a scanning rate that produces an information signal of about 1250 Hz. In this case, the carrier alternates between 1500 and 2450 Hz, creating a pseudo carrier at 1975 Hz. With the 1250-Hz information signal, the lower sideband can extend down to 725 Hz. Since the attenuation distortion of the channel is fairly flat down to 300 Hz you might ask why not transmit a higher signal frequency and thereby achieve a higher document transmission speed. The answer presents itself if you look at the delay distortion of the channel as a function of frequency. The average delay distortion curve is fairly flat through the range discussed, i.e., from 725 to 1975 Hz. However, below about 700 Hz, a rapid increase in delay distortion is experienced. The 1250-Hz signal frequency range was picked to avoid this grossly distorting region of the frequency spectrum.

Ink jet printing

James Stone, Videograph Products, A. B. Dick Co.

The appearance of non-impact printers has introduced significantly different imaging techniques from that of Gutenberg and his successors. Normally, printers are classified as either impact or non-impact. In impact printers, a hammer strikes the printing medium driving it into the raised type face and printing ribbon. Alternatively, the type slug is driven into a print ribbon causing sufficient pressure on the paper surface to produce the image of the character on the type slug.

In non-impact printers, however, characters are formed by depositing an electrostatic charge on a dielectrically coated recording medium (requiring subsequent development and fixing of the image produced); by electrical discharges burning off the surface of the paper to reveal a sub-layer of image material; by thermal techniques producing color by heat in the recording medium; by electrolytic disposition of material into the recording; or by the ink jet process. Electrostatic printers require chemically treated or proprietary type paper costing the user from 1½ to 7¢ per sheet. The cost per printed page of treated paper is three to ten times the cost of standard untreated computer forms. While the ink jet process is slower than electrostatic printing methods, it offers the advantage of the use of standard paper forms.

Present equipments use one of three approaches. The first is a process developed by Dr. Hertz; the second a process developed by Teletype Corp.; and the third, a process developed by Richard Sweet, is used in equipment produced by A. B. Dick Co., Recognition Equipment, Inc., and Data Printer Corp.

The Hertz process

The Hertz process uses a pressurized source of ink coupled with a tiny nozzle. The ink is propelled through the nozzle toward the paper surface. Such a stream of ink will, due to the natural instabilities, break up into small droplets a short distance in front of the nozzle. If an electrode is placed near the point of drop formation, the voltage applied to the electrode will charge the droplets. For a small or uncharged stream, the droplets follow each other and a coherent thread-like stream of ink results. When highly charged, the individual droplets repel each other and the stream rapidly scatters.

A second small orifice in front of the recording surface can then be arranged such that an uncharged ink stream will pass through it and produce marks on the paper.

Charging the ink stream causes it to scatter and can, for all practical purposes, stop the flow of ink to the recording surface. This process, coupled with a mechanical movement of the assembly in the vertical and horizontal directions, can produce the images desired.

The Teletype process

A second technique called Inktronic, developed by the Teletype Corp., uses a dielectric ink. A high voltage field close to the nozzle electrostatically attracts and propels the ink toward the recording surface. As the ink is accelerated by the electrostatic field, it "necks down" like taffy and forms into a small regular sized stream of ink droplets. As a result of the accelerating field, each of these droplets contain an identical electrical charge. Deflection plates then electrostatically deflect the droplets in the vertical and horizontal direction and form the desired image on the recording surface. This process closely resembles the cathode ray tube. The ink droplets produced behave in much the same manner and are deflected in a similar manner to the electrons in a cathode ray tube.

The Sweet process

The Sweet approach uses pressurized ink to form a small high-velocity stream of ink directed toward the recording surface. As in the Hertz process, the stream breaks up into droplets a short distance in front of the nozzle. By injecting ultrasonic energy into the ink stream, a velocity modulation of the outpouring stream is produced. This modulation results in the formation of an extremely regular sequence of droplets.

As the droplets form, a neighboring electrode induces a predetermined electrostatic charge. This charge decides the path followed by the droplet from the charging plates to the recording surface. This path passes through a high voltage vertical deflection field and the vertical deflection of each droplet is proportional to the droplet charge.

In a typical system, a catcher tube or interceptor bar is placed so that uncharged or undeflected droplets are caught and returned to the ink reservoir. Droplets with sufficient charge to deflect them out of the way of the catcher will strike the print surface. The exact position on the print surface is controlled vertically by the amount of charge on the droplets. In addition, horizontal movement of the nozzle across the print surface provides horizontal deflection of the ink droplets. With control of both vertical and horizontal deflection of the droplets, alphanumeric characters are formed from a matrix pattern of droplets.

One example of an ink jet printing system is the A. B. Dick Co. Videojet® printer. This printer uses the Sweet



DATA TERMINALS COURSE

process in producing alphanumeric characters at rates up to 750 characters/s. In this system the ultrasonic signal causes 66,000 droplets/s to be formed. Although the system generates this many droplets, a deliberate zero charge is placed on every other droplet, causing these to be dumped or recirculated. The result is 33,000 droplets/s available for use in forming characters.

As input digital signals are received from the external data source, they are converted into a bit serial word descriptive of the character to be formed. For example, if the characters are formed using seven dot positions vertically by five dot positions horizontally, the bit serial word would contain 35 bits. The first seven bits would represent the presence or absence of ink droplets in the first vertical column, the second seven bits the second vertical column, and so on until the 35-bit configuration is defined.

This 35-bit digital word controls the charging of each of the 35 drops of ink required to form the character. A 0 bit results in no charge on the droplet. A 1 bit causes the

droplet to be charged by an amount proportional to the vertical position in the column, and the droplet strikes the paper at that position forming a spot. In this system, the character generating circuits must be stopped by the same 66,000-Hz ultrasonic signal used in forming the drops. By this means the writing assembly and the electronics remain synchronized.

What's ahead

A recent Arthur D. Little Computer Industry Market study forecast a \$125 million market for non-impact printers in 1975, with shipments increasing from 300 units in 1970 to more than 5000 units in 1975. A significant portion of this market will be shared by ink jet printers.

Though confined at the moment to computer and communications applications, the ink jet technique should open many new opportunities in the industrial, communications and printing fields. There seems little doubt that ink jet printing is here today and can be expected to assume a much larger role in the future.

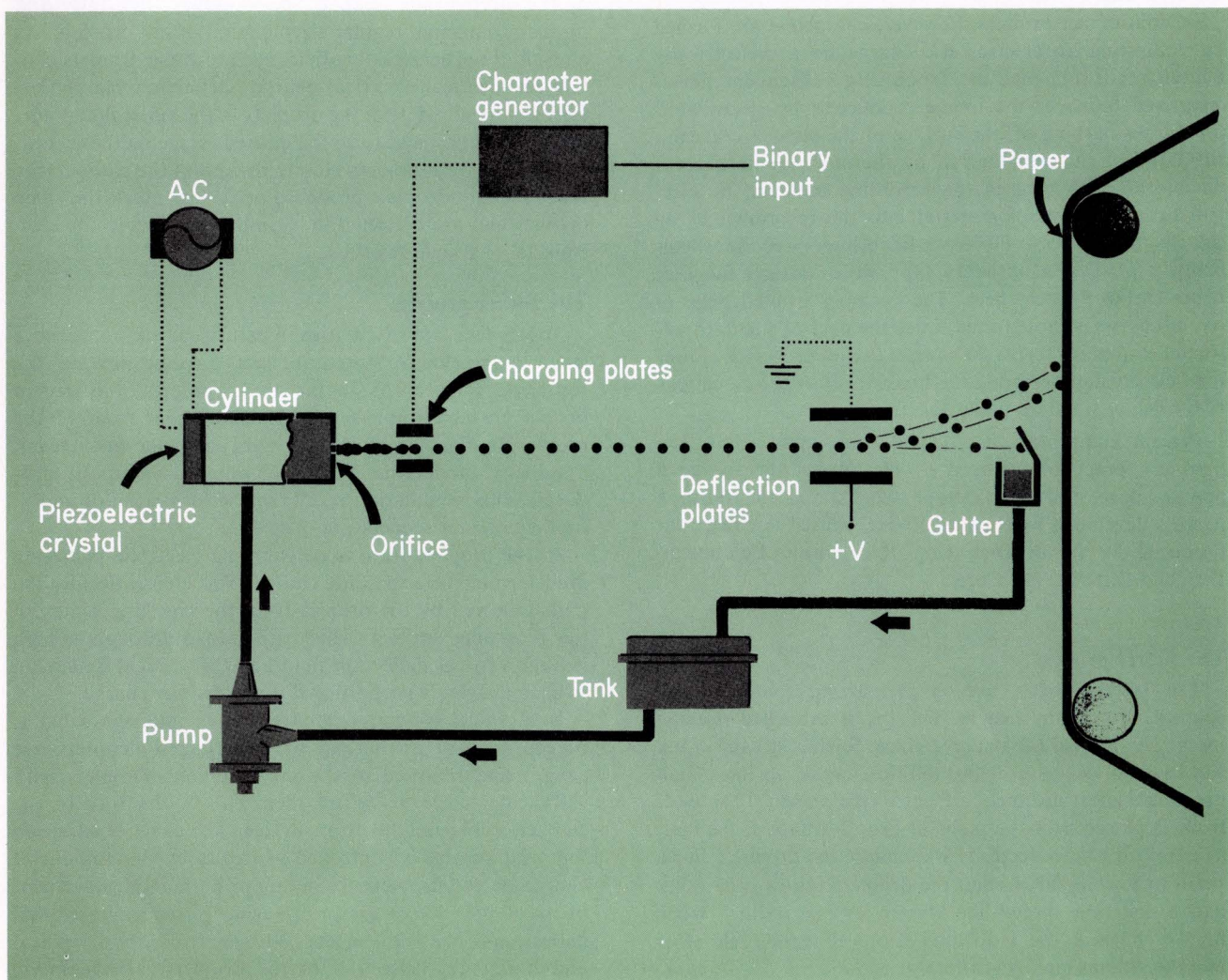

The Videojet printer forms the vertical strokes of a particular character by electrostatically deflecting charged droplets of ink. The amount of vertical de-

flexion is determined by the amount of charge imparted to the drop as it passes through the charging plates.

A firmware approach to data adapters

Paul Wolf, Digital Scientific Corp., San Diego, Calif.

With the rapid rise in terminal use, one of the biggest problems facing the system designer is that of getting all this data into the central computer. This function is performed by a device called a data adapter, which is actually an expensive little computer, itself.

The primary functions of a data adapter are to interface a communications facility with the central computer and to furnish data buffering. The main logical functions performed are bit sampling, bit buffering, generation of bit-service trap requests, error checking and the like. Since these functions must be provided for each communication line attached to the system, data adapters contribute inordinately to the overall system cost. This situation has not gone unnoticed, of course. The specialized data adapter has been a favorite target of the minicomputers for several years, and you will find minicomputers performing the data adapter function in a number of systems.

In many cases, the processing tasks of a data adapter are relatively trivial. In essence, they consist of conversion from bit serial to character serial streams and line protocol management. Consider for example a data adapter designed for use with an IBM System 360. Most of the data processing is performed by the 360 itself, and it is highly unlikely that anyone will tinker with the BTAM and QTAM routines simply to perform more preprocessing in the data adapter. (BTAM, Basic Telecommunication Access Method, and QTAM, Queried Telecommunication Access Method, are extensive software routines developed by IBM and used by their 360 customers).

The expensive part of a programmable data adapter is not the computer itself, but the line adapters for each line coming from the terminals. In a typical system, the line adapters account for perhaps 90% of the preprocessor cost. Hence, while substitute minicomputer data adapters have drastically cut the cost of the processing element, they have not yet achieved the potential system cost reductions. Without substantial reduction in the cost of the line adapting functions, there can be no major impact on large terminal system "data adaption" costs.

Other Approaches

One obvious alternative, performing the line adaption functions via software, simply will not work with today's computers. Practically speaking, there are no conventional machines fast enough to handle any substantial number of lines. The functions require instruction speeds under 100 ns with memory accesses less than 50 ns.

The other alternative to individual line adapters is firmware—specifically microprogramming in a control memory to emulate the functions of the line adapters. This approach has a number of advantages. Read-only memories are highly reliable, and their use permits the optimization of the CPU. The instruction set can be optimized for data communications functions by such methods as implementing check code instructions or bit manipulation functions to permit convenient manipulation of bits within words. The system can operate with an adaptive capability for line speeds. Equally important, the CPU hardware can be organized into registers and memories thereby reducing the need for expensive control logic.

There are two problems with the use of a microprogrammed control memory for a data adapter. First, most off-the-shelf ROMs today are not fast enough to do the job really effectively. For instance, high speed register to register manipulation is mandatory. It would be highly desirable to perform in 100 ns an instruction which merges the contents of one register with those of a second register and stores the results in a third register. This kind of speed can only be realized by a ROM with an access time of 35-50 ns (in a 65 K bit system). Speed at the system level is a key factor; some IC ROMs may have a 15-30 ns access time at the chip level, but an access time of 100 ns or more at the system level.

The second problem with today's ROMs, and the factor which has most slowed the growth of the ROM industry is the difficulty of altering them. Designers make mistakes and users change their applications. Any computer design must take this into consideration. If it is to be of real utility to the user, the ROM must be continually alterable at the bit level by the user without special tools. And even a soldering iron is a special tool to the programmer-user.

It's a major problem. Generally speaking, electrically alterable ROMs are either slow or can only be altered once. Mechanically alterable ROMs demand a repair sophistication beyond the reach of most programmers.

New ROM approach

To solve these specific problems, a new approach in ROM design was developed for Digital Scientific's Meta 4 computers. The access time at a system level of 65,000 bits is 35 ns and CPU instruction cycle times are less than 100 ns, thereby permitting nine or more microinstructions to be executed during each core memory cycle.

Equally important, this ROM can be easily altered in the field. The firmware contents are loaded on pattern boards



DATA TERMINALS COURSE

via adhesive-bonded "bit patch" patterns organized in rows and columns representing bit positions in sequential instructions. A bit patch is a binary 1 and the absence of a patch represents a binary 0. As these patches can be easily removed to form a desired pattern simply by lifting them with a sharp edge, virtually unlimited alteration is possible.

The ROM is a magnetic storage device which is based on several proprietary innovations in the memory field. The bit patches are small metal pieces with an adhesive backing. The magnetic circuit senses the presence or absence of these patches and converts the information into the corresponding 1 and 0 logic levels.

We expect that data adapter systems using ROM developments such as this will have a powerful impact on the terminal systems. Since the control unit is programmable, it can be used for a variety of data communications tasks simply by plugging in different ROMs. This flexibility can

be expended even more. There is literally no reason why a firmware machine could not be used as a data adapter on one shift and a communications processor on another.

It is estimated that the crossover point dictating the use of a firmware processor rather than a mini plus line adapters is 16 lines. Beyond that point, the acquisition cost savings alone of the firmware processor justify its use. (No cost value is assigned to the increased reliability or alterability).

However, since the ROM incremental costs to handle numbers of lines are minimal, it is logical to opt for greater capability in the initial purchase. Hence, a user with perhaps 20 lines will have a machine capable of handling two or three times that many. This "free" capacity will not only provide him the growth capability for a larger terminal system, but will permit him to adapt his machine on off shifts to applications requiring the additional processing power.

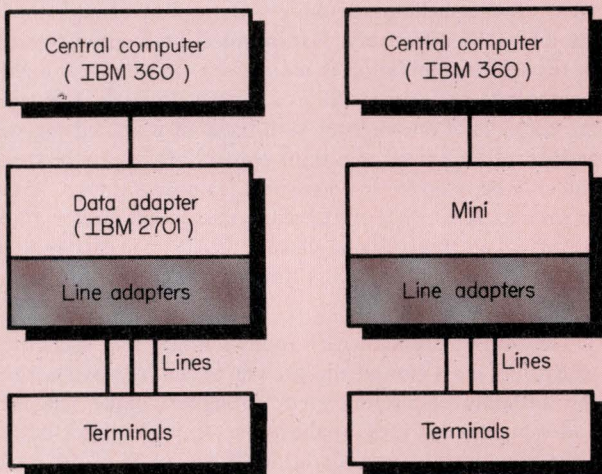

Using a conventional minicomputer to perform the data adapter function has relatively little impact on the cost of large systems because individual line adapters are still required.

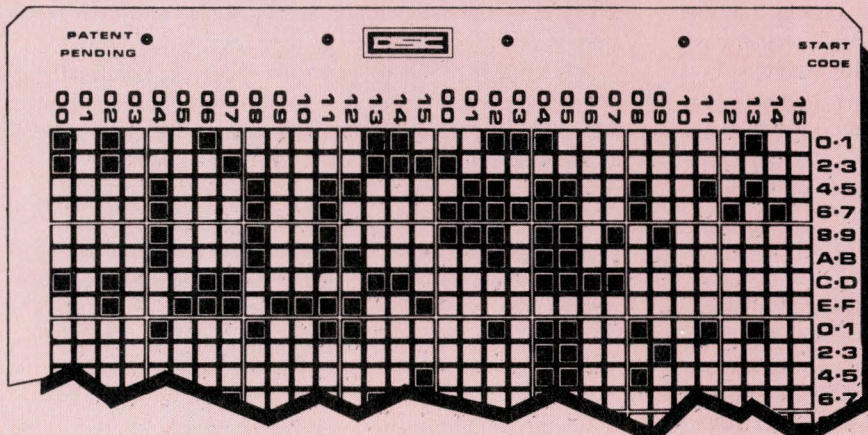

This ROM program board uses individual patches to program binary 1's into the memory. Because the patches are easily added and removed, you can rapidly reprogram the ROM without special tools.



DATA TERMINALS:

EXAM

We will send you a certificate of successful completion for the course on data terminals if you pass the exam below. Please enclose \$1.00 to cover the cost of handling, grading and printing of the certificate.

Indicate your answers by blacking the box that corresponds to the answer which you consider to be correct. After you have completed all the questions, tear out this page and mail to:

Data Terminals Exam
The Electronic Engineer
 One Decker Square
 Bala-Cynwyd, Pa. 19004

1. The most common communications code uses seven information bits plus one parity bit. This is the (a) *ASCII* (b) *Baudot* (c) *Hollerith* (d) *EB-CDIC* code. a.
b.
c.
d.
2. The voice-grade channel is the basic unit in today's communications systems. This channel has a usable bandwidth of about (a) *400 Hz.* (b) *2700 Hz.* (c) *1500 Hz.* (d) *3200 Hz.* a.
b.
c.
d.
3. Low-speed terminals account for the largest number of present-day installations. Such terminals almost always use (a) *VSB-am* (b) *PSK* (c) *DPSK* (d) *FSK* as a modulation technique. a.
b.
c.
d.
4. When start and stop bits are used to identify each character in the data stream, the type of transmission is known as (a) *synchronous* (b) *asynchronous* (c) *duplex*. (d) *simplex*. a.
b.
c.
d.
5. Baud rate as a measure of transmission speed (a) *means the same as bits/s.* (b) *is a measure of information flow.* (c) *is a measure of the signaling speed of the channel.* (d) *all of these.* a.
b.
c.
d.

6. Most A/N CRT terminals use a standard TV scan format. This type of scan produces (a) *525* (b) *600* (c) *400-450* (d) *480-500* active scan lines. a.
b.
c.
d.
7. The TV type of scan is the most demanding display mechanism for a ROM character generator. This is particularly true in the area of ROM (a) *size.* (b) *speed.* (c) *organization.* (d) *interface capabilities.* a.
b.
c.
d.
8. Current mode line drivers have several advantages over voltage mode drivers. Which of the following is not one of these advantages? (a) *Better noise margin.* (b) *Less power required.* (c) *Adaptability to large party line systems.* (d) *Single ended operation.* a.
b.
c.
d.
9. When interfacing with a modem, line drivers must meet the requirements of RS-232C. For this application, the drivers need a slew rate of greater than (a) *10 V/μs.* (b) *20 V/μs.* (c) *30 V/μs.* (d) *40 V/μs.* a.
b.
c.
d.
10. The N-key rollover interlock in a keyboard operates (a) *by preventing the strobe signal.* (b) *by preventing the depression of more than one key.* (c) *by alerting the operator to an error.* (d) *on a first/in first/out principle.* a.
b.
c.
d.
11. Low speed modems which operate over voice grade lines are those which operate at less than (a) *4800 bits/s.* (b) *2400 bits/s.* (c) *1800 bits/s.* (d) *600 bits/s.* a.
b.
c.
d.
12. The biggest drawback with an error-detection-with-retransmission algorithm is (a) *the time required to detect the error.* (b) *the retransmission time.* (c) *the line turnaround time.* (d) *the line conditioning required.* a.
b.
c.
d.

NOW...

*the only one of its
kind available!*

A Course in MOS INTEGRATED CIRCUITS

The editors of *The Electronic Engineer* have just compiled a complete 9 part course on MOS technology, applications and costs which appeared originally in *The Electronic Engineer*. It is a definitive volume that provides you with all the background you need as a user or a designer to master this new technology.

This state of the art course in MOS technology presents completely authoritative, up-to-the-minute guidance in using every aspect of this dynamic science. It covers the processing of MOS circuits, applications of MOS circuits, complementary MOS, MOS memories (random access, read only, associative memories and cost) and the testing of complex MOS integrated circuits.

This course is an exclusive from *The Electronic Engineer*. It is, in fact, the only one of its kind available. The authors, all recognized experts in their respective fields, take you with technical precision from the fundamentals on through to the most sophisticated phases of this dramatic technology. This course is the *one* authoritative way to keep ahead in these changing times.

Order your copy of the *only* course available on the new MOS technology and manufacturing processes for only \$5.00 per copy. Send your order today to: *The Electronic Engineer*, One Decker Square, Bala Cynwyd, Penna. 19004, Dept. E-12

Enclosed is my check or money order for \$_____ for _____ course(s) on MOS technology at a cost of \$5.00 each. Send as soon as possible to:

Name _____

Address _____ Company _____

City _____ State _____ Zip _____

Send me special quantity prices E-12

13. Time-division multiplexing is generally a better choice than frequency-division multiplexing in those applications with (a) *a high concentration of terminals in one location*. (b) *widely scattered terminals*. (c) *a small number of terminals*. (d) *low-speed terminals*. a.
b.
c.
d.

14. Character-interleaved TDM has the advantage over bit-interleaved TDM in the area of (a) *lower transmission delay*. (b) *accurate reproduction of the original waveform*. (c) *better channel capacity*. (d) *all of these*. a.
b.
c.
d.

15. In which of the following areas does TDM not have an advantage over FDM. (a) *Software demultiplexing*. (b) *System reconfiguration*. (c) *Point-to-point applications*. (d) *Systems which use echoplex*. a.
b.
c.
d.

16. It is not unusual to operate N/N CRT terminals over (a) *1200 baud* (b) *2400 baud* (c) *4800 baud* (d) *all of these* communication facilities. a.
b.
c.
d.

17. The typical resolution in today's business facsimile systems is about (a) *10 lines/in.* (b) *100 lines/in.* (c) *500 lines/in.* (d) *1000 lines/in.* a.
b.
c.
d.

18. Facsimile systems which operate over the DDD typically use an information signal of about 1250 Hz. This frequency was chosen because of the (a) *attenuation distortion* (b) *delay distortion* (c) *crossstalk* (d) *signal/noise ratio* of the telephone channel. a.
b.
c.
d.

19. The biggest advantage of ink jet printers over electrostatic non-impact printers is (a) *reduced paper costs*. (b) *higher operating speed*. (c) *direct multi-copy capability*. (d) *all of these*. a.
b.
c.
d.

20. The largest expense associated with the data adapter in a communication system results from the (a) *processing requirements*. (b) *data buffering*. (c) *line adapter functions*. (d) *bit-serial to character-serial conversion*. a.
b.
c.
d.

Don't forget to fill in your name and address and enclose \$1.00 to cover costs.
Please send my Certificate to:

Name: _____

Company: _____ Title: _____

Street: _____

City: _____

State: _____ Zip Code: _____

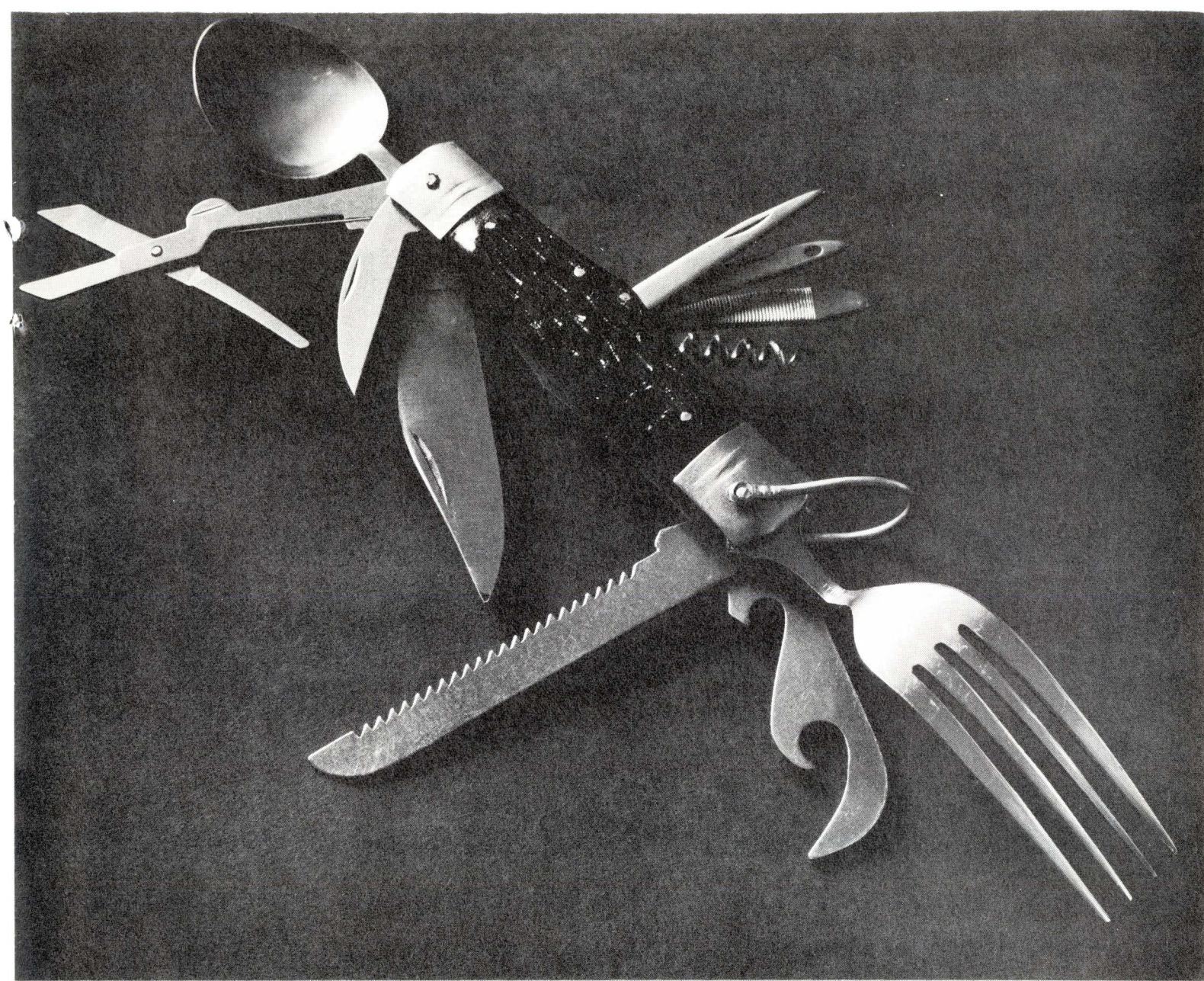

It's as versatile as a PDP-8.

As far as we can tell, there's a PDP-8 computer doing every job that's ever been done by a mini-computer.

We have them in steel mills. Nuclear reactors. Automotive plants. Hospitals. Laboratories. Newspapers. Businesses. All over the place. All over the world.

So it should come as no surprise to learn that the PDP-8 is the most

popular minicomputer ever made. In fact, more PDP-8's are installed every month than all the other minis put together.

Of course, it takes more than versatility to make the PDP-8 so popular. Having more than sixty peripherals to pick and choose from helps, too. As does PDP-8's library of software. It's the biggest collection of mini-computer software in the world.

And all the big computer company backup we offer doesn't hurt either. Over fourteen hundred sales/service engineers, for example.

But a lot of it must go back to what you learned as a kid: That there's nothing like something that'll do almost anything.

Digital Equipment Corporation, Maynard, Massachusetts 01754. (617) 897-5111.

digital

Circle Reader Service #34

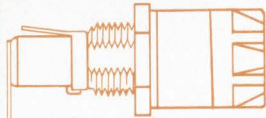

Space-saving size: projects only one inch behind panel, only 1-25/32 inches overall length

Easy-grip bayonet-type knob—sturdy compression spring assures good contact

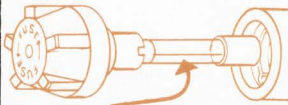

Knob grips fuse so that fuse is withdrawn when knob is removed

Made for installation in D-hole to prevent turning in panel

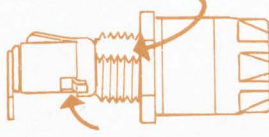

Terminals are mechanically secured in holder as well as soldered

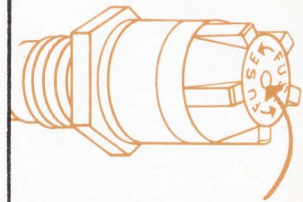

Knob has break-out hole to allow use of test probe

BUSS HTA FUSEHOLDER

FOR 1/4 x 1 1/4 INCH FUSES

Rated for 15 amps at any voltage up to 250. Dielectrically capable of withstanding 1500 volts A.C. between terminals and between terminal and panel.

Space Saver!



only a BUSS fuseholder could have.....

Inexpensive instant graphics

If you've avoided the use of a graphic terminal because of the high costs of hardware, software development, and computer overhead, a new Tektronix terminal may be what you've been waiting for.

The Model 4010 computer display terminal instantly graphs computerized data. It should be of great interest to both users and potential users of terminals with graphic and alphanumeric capabilities. And the reason is simple: price.

The cost of the 4010 is \$3950 for a single unit, dropping to as low as \$3400 for 20 or more. Or, you can lease a 4010 for \$200/month, including maintenance. Discounts on the rental price are offered if the lease exceeds 1 year.

A new software system, callable from FORTRAN, supports the 4010. Called PLOT-10, it lets you select software modules appropriate to your needs. And with PLOT-10, the 4010 is compatible



with more than 20 minicomputers (from DEC, Data General, Honeywell, Interdata, HP, Varian, and Raytheon), more than 20 time-sharing systems, and with IBM 360/370 systems. The software interfacing with the mini's is done in assembly language.

Although the 4010 is primarily business-oriented, the versatility of the PLOT-10 package lets you use the terminal in such diverse applications as circuit analysis, control systems, vibration analysis, IC mask layout, and so on.

Technically speaking, the 4010 is a stand-alone, storage-CRT, computer terminal. Alphanumeric input to the com-

puter is via a Teletype/33-style keyboard; graphic input is via a dual-thumbwheel arrangement on the keyboard.

The standard data-communications interface is a subset of RS232C. An optional data-comm interface gives you switch-selectable rates from 110 to 9600 b/s. Transmit and receive rates are independent of each other. And you can also select local-echo, full-duplex, or half-duplex modes.

In the alphanumeric mode, you have available 63, 5-x-7 dot-matrix characters, with 72 characters/line on 35 lines.

In the graphic mode, there are 1024 x 1024 addressable points, 1024 x 780 viewable points, with a vector drawing time of 2.6 ms. Graphic input is via 1024-x and 780-y points and a thumbwheel-controlled cursor. Tektronix, Inc., Box 500, Beaverton, Ore. 97005. (503) 644-0161.

Circle Reader Service #233

The sprinter printer

Computer output printers are generally categorized as either character-at-a-time (serial printers) or line-at-a-time (line printers). Serial printers have the definite advantage of a fairly modest price tag, but in many applications they impose a severe speed limitation on the system. Line printers, on the other hand, are extremely fast, but their cost eliminates them from a great number of applications. In areas such as telecommunications, minicomputer systems, and hardcopy printers in CRT systems, the most desirable speed/cost tradeoff lies somewhere between these two extremes.

Seeing a need for a fairly fast and inexpensive impact printer with fully formed characters, Printer Technology

Inc. recently set up shop to produce just such an animal. President of the new company is Matthew Lorber, who has an impressive track record in establishing high technology companies. His most recent success began in 1965 when he was one of the original founders of Analog Devices. Today Mr. Lorber still acts as the Chairman of the Board of the very successful circuit module house.

The problem which Mr. Lorber and his colleagues at Printer Technology set out to solve is by no means trivial. Conventional print-on-the-fly machines use a helical print wheel which rotates in front of the paper. During each revolution of the wheel, a hammer drives the paper against the wheel during that instant when the correct character is in position.

The first product from Printer Technology, the Printec-100, takes a different approach to the problem. The print wheel has three complete character sets on it instead of the conventional single set. So you get a threefold increase in printing speed without exceeding the maximum allowable print wheel-to-paper speed.

The result is a 100 char./s printing rate and a \$2,200 price tag. That price is for single units, and it does mean a complete printer. Standard features include all required electronics, a 64-character ASCII font, throw-away ink roller (no ribbons to change), a 136-character line length, 10 char./in. horizontal spacing, and a Vertical Format Unit for tabulation work, check printing, etc. Printer Technology Inc., Sixth Rd., Woburn Industrial Park, Woburn, Mass. 01801.

Circle Reader Service #234

...so many quality features squeezed into such a small package



Solder Terminals (HTA)

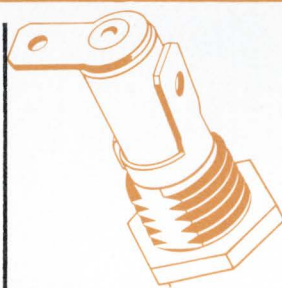

1/4" Quick-Connect Terminals (HTA-HH)

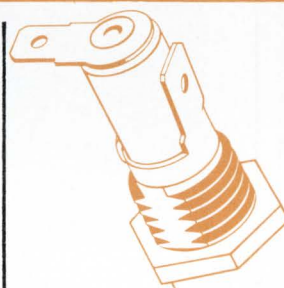

3/16" Quick-Connect Terminals (HTA-DD)

Space Saver!



BUSS HTA FUSEHOLDER

FOR 1/4 x 1/4 INCH FUSES

For more information on the HTA Fuseholder and the complete BUSS QUALITY line of small dimension fuses, fuseholders, and fuse-blocks, write for BUSS Bulletin SFB.

BUSSMANN MFG. DIVISION,
McGraw-Edison Co., St. Louis, Mo. 63107

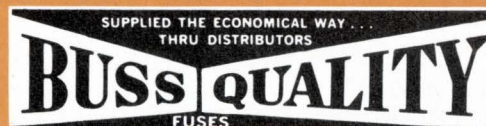

ICs to interface data terminals

Computers, data terminals, and other digital machines, handle data in parallel. But when they talk to each other via a communications line, however, the bit stream in that "conversation" has to be serial. Therefore, they need, at least, a parallel-to-serial converter when they send data, and a serial-to-parallel to receive it. Add a buffer, warning flags and a clock, and you now have the new class of communications interface ICs which are appearing in the market.

The first circuit that came close to this type of application was TI's SN79150, an MSI TTL multiplexer that could be used as a parallel-to-serial converter. Then Solid State Data Sciences introduced a UAR/T (see box), and General Instrument followed with two separate circuits, a transmitter (AY-5-1010) and a receiver (AY-5-1008).

Whom do you believe?

A few years ago, a little company in Long Island called Solid State Data Sciences—a spinoff from General Instrument, made a multichip, MOS version of one of Digital Equipment Corp.'s modules. Essentially, the circuit was an 8-bit, parallel-to-serial converter to interface a Teletype with a modem. It called the circuit UAR/T, for Universal Asynchronous Receiver/Transmitter. Before going out of business in 1970, SSDS landed an interesting order for UAR/Ts from a major computer manufacturer. After the demise of SSDS the customer shopped around for other sources, and gave prototype contracts to AMI (which has applied to register UAR/T as its trademark), General Digital (now Western Digital) and, of course, General Instrument, which had welcomed back SSDS's principals.

The circuits all three companies offer now are a much improved, all monolithic version of the original UAR/T. Interestingly, all three firms claim to have developed it, or delivered it, or announced it first, sometime around September 1st of this year. Motorola's ICs are different (separate packages for transmitter and receiver, both asynchronous and synchronous) and it'll introduce them this month.

Whom do you believe? That's immaterial. The important thing is who can deliver in quantity. All four say they can, with AMI claiming the largest number of prototypes out in customers' labs.

Now American Microsystems Inc., General Instrument, and Western Digital have introduced a single chip, MOS, asynchronous transmitter-receiver for less than \$30 in 100 quantities. (GI, which offers the lowest price, \$22.50, specifies the highest data rate, up to 20 kbaud.) In addition, Motorola is introducing this month two MOS ICs, a transmitter and a receiver that are both synchronous and asynchronous.

For a strictly asynchronous, transmit-receive application such as connecting Teletypes or other data terminals with a computer, the single-chip UAR/Ts are the best, most economical choice, especially if the computer has a bus-organized system using National Semiconductor's Tristate® TTL circuits. For synchronous applications, or for those that require only a transmitter or

a receiver (such as testing of data terminals), or for applications that demand the lowest jitter error, the Motorola circuits seem to have the edge. Combined, they cost \$32.20 in 100 quantities.

The requirements for most applications today fall somewhere between the clear-cut extremes outlined above. While unquestionably most of them are asynchronous, there is an increasing number of new designs that incorporate a synchronous option. This option will allow them in the future to operate economically in a data communications system such as the one proposed by Datran. To find the one that suits your application best, refer to the table of specifications, and contact the manufacturers by circling the inquiry numbers in the Reader Service Card.

General Instrument Corp.'s MOS UAR/T (Universal Asynchronous Receiver/Transmitter) offers flexibility in a single IC.

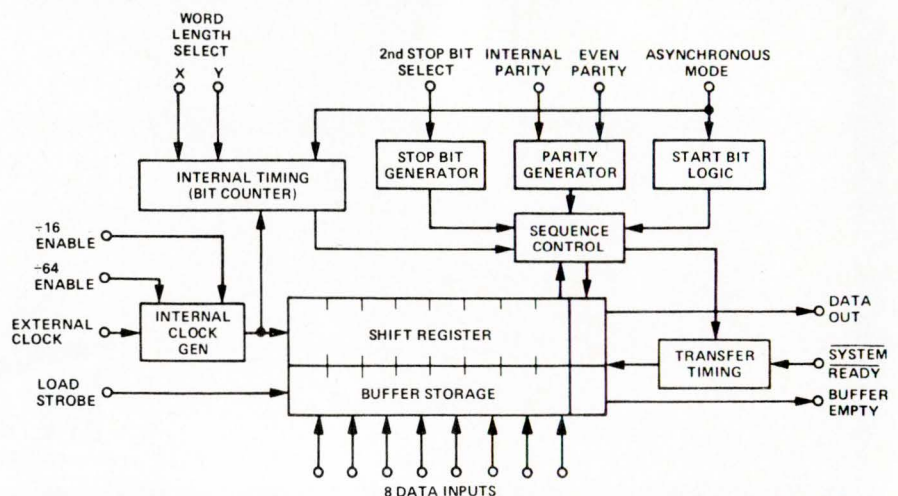
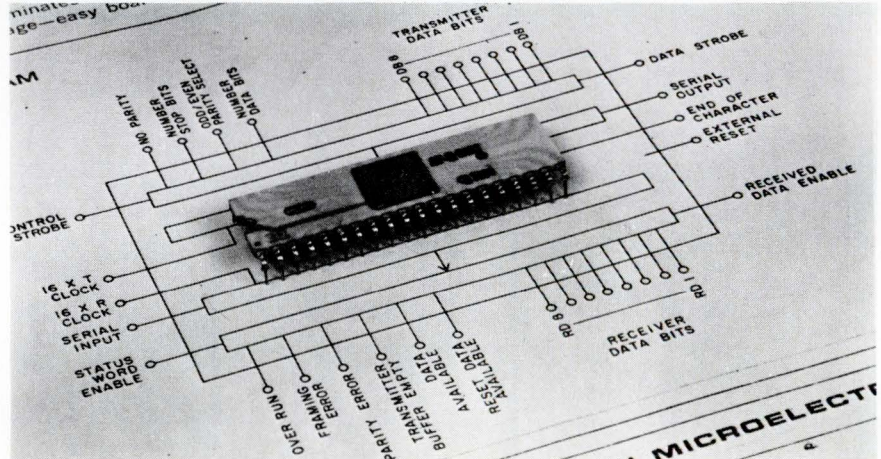

Motorola's parallel-to-serial converter for computer terminals (transmitter MC2257L).

Manufacturer		American Microsystems (AMI) (one package)		General Instrument (GI) (one package)		Motorola (two packages)		Western Digital (one package)		Editor's Comments		
Function		Transmitter Receiver		Transmitter Receiver		Transmitter Receiver		Transmitter Receiver		Transmitters and receivers, including those built in a single chip, can operate simultaneously at different data rates.		
Model No.		S1757		AY-5-1012		MC2257L MC2259L		TR1402A				
Mode		Asynchronous Full or half-duplex		Asynchronous Full or half-duplex		Synchronous Async. (full or half-duplex)		Synchronous Async. (full or half-duplex)			Asynchronous Full or half-duplex	
Data Rate (DR)		up to 10 kBaud		up to 20 kBaud		up to 10 kBaud		up to 10 kBaud		up to 12.5 kBaud		All circuits can interface with a 9600-baud modem. GI's circuit can also operate at 19.2 kBaud.
Programmable features	Word length	5-, 6-, 7-, and 8-bit word										All circuits, except Motorola's can also operate with "extended" 8-bit words (8 bits plus parity). When transmitting less than 8 bits, the characters are right-justified. A receiver clock operating at 16(DR) locates the center of incoming pulses within 6.25%, accurately enough to interface with computers. Western Digital senses both leading and falling edges of incoming pulses to double the accuracy. Motorola quadruples it with a 64(DR) clock. The higher accuracy is useful in communications applications.
	Parity	odd, even, or none										
	Stop bits generated	single or double		single or double		single or double		single or double				
	Internal clock rate	1(DR) 16(DR)	1(DR) 16(DR)	16(DR) 16(DR) (not programmable)		1(DR) 16(DR) 64(DR)	1(DR) 16(DR) 64(DR)	1(DR) 16(DR)	1(DR) 16(DR)			
Status outputs		Ready Data transmitted	Parity error Framing error Overrun Data received	Ready Data Transmitted	Parity error Framing error Overrun Data received	Ready	Parity error Framing error Overrun Data received	Ready Data transmitted	Parity error Framing error Overrun Data received	Each error flag (PARITY, FRAMING, or OVERRUN) of all circuits (except Motorola's) has a Tristate output which allows it to be wired-OR to a bus with corresponding flags from other receivers.		
Electrical and switching characteristics	Interface with TTL	Requires external resistors		Fully compatible with TTL		Requires external resistors	Requires external resistors	Fully compatible with TTL			The circuits by GI and Western digital are fully compatible with TTL. AMI and Motorola will introduce fully compatible circuits in 1972. <i>*had -- AMI cut the price by \$10 as we went to press</i>	
	MOS process	p-MOS, low threshold		MNOS (nitride)		p-MOS	p-MOS	Silicon-gate				
	V _{GG}	-12 V		-12 V		-12 V	-12 V	-12 V				
	V _{SS}	+ 5 V		+ 5 V		+ 5 V	+ 5 V	+ 5 V				
	V _{DD}	- 5 V		0 V		- 5 V	- 5 V	- 5 V				
Max. clock frequency	160 kHz 160 kHz		320 kHz 320 kHz		640 kHz	640 kHz	200 kHz					
Temperature range	0-70 C		0-70 C		0-75 C	0-75 C	0-70 C			* GI has the lowest price for asynchronous applications. All four manufacturers claim to have enough stock on distributors' shelves to fill 100-piece orders, and claim to be able to produce them at a rate of several thousands per month. Western Digital has three more options in stock: TR1402A-01 (12.5 kBaud, not fully TTL compat.) \$28.50 R.S. 209 TR1402A-02 (25 kBaud, not fully TTL compat.) \$45.00 R.S. 210 TR1402A-03 (25 kBaud, fully compatible) \$56.25 R.S. 211 Also, Texas Instruments has a spec sheet on an async. transmitter/receiver (TMS 6010) it plans to introduce in 1972. For a copy of the specifications, circle R.S. 212		
Package	40-pin ceramic dual-in-line		40-pin ceramic dual-in-line		24-pin ceram. dual-in-line	24-pin ceram. dual-in-line	40-pin ceramic dual-in-line					
Price (in 100 quantities)	\$28.10 \$18.10		\$22.50		\$13.60	\$18.60	\$37.50					
Delivery	Stock		Stock		Stock	Stock	Stock					
Address	3800 Homestead Rd. Santa Clara, CA. 95051		P.O. Box 600 Hicksville, N.Y., 11802		5005 E. McDowell Rd. Phoenix, AZ. 85008		P.O. Box 2180 Newport Beach, CA. 92663					
Contact	Tom Edel		William Seifert		Ron Komatz		Steve Stuart					
Circle Reader Service No.	204		205		206	207	208					



Model B80-3766
66 Key ASCII Tri-Mode

HOW TO SAVE MONEY ON KEYBOARDS:

UNLOCK REALLY BIG SAVINGS WITH THIS NEW..

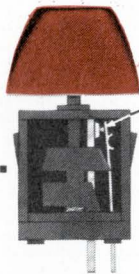

ACTUAL SIZE

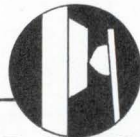

..GOLD "CROSSPOINT" CONTACT KEY

Gold "Crosspoint" Contacts plus simplified electronics enhance reliability and provide long life, low profile, low power consumption and low, low cost.

HOW TO DESIGN YOUR OWN KEYBOARD:

Call or write for the new six-page **Cherry Keyboard Designer's Specification Sheet** and the full-color **Cherry Keyboard Brochure** describing the reliable new Gold "Crosspoint" Key Module and Keyboards.

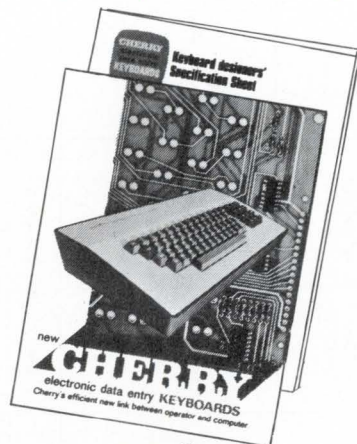

CHERRY

CHERRY ELECTRICAL PRODUCTS CORP.

3612 Sunset Avenue, Waukegan, Illinois 60085 • (312) 689-7600

Makers of patented Leverwheel/Thumbwheel Switches, Matrix Selector Switches, Snap-Action Switches and Keyboards.

Circle Reader Service #20

DC-20

DATA COMMUNICATIONS PRODUCTS

BUILT-IN MODEMS

An optional built-in manual originate, answer modems is now offered with lower-speed Teletype® terminals. These new modems provide compatibility with the Bell System's 101, 103 and 113 data sets with total integration of the modem function into the data terminal. This optional modem will add about \$200 to comparable terminal prices. Teletype Corp., 5555 Touhy Ave., Skokie, Ill. 60076.

Circle Reader Service #235

FAULT LOCATOR



Series 1691 contains its own signal source and will resolve multiple discontinuities. The unit will determine the magnitude and location of faults caused by bent, crushed, corroded, misaligned, or broken transmission line. Scientific-Atlanta, Inc., Box 13654, Atlanta, Ga.

Circle Reader Service #236

TELEPHONE DIALER MODULES

These two products are the first in a series of OEM communications control modules. The two units are PC board automatic dialers—one for pulse and one for tone dialing operations—that can be programmed to dial any telephone number up to 14 digits. G-V Controls Div. of Sola Basic Industries, 101 Okner Pkwy, Livingston, N.J.

Circle Reader Service #237

9600 B/S MODEM

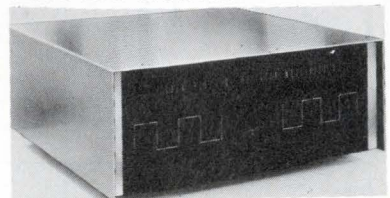

The Codex 9600 is a 9600 b/s voice band modem. The unit features an automatic adaptive digital equalizer which sets up in 275 ms and is continually optimized at a rate of 2400 times a sec. \$11,500. Codex Corp., 15 Riverdale Ave., Newton, Mass. 02195

Circle Reader Service #238

KEYBOARD ASSEMBLIES

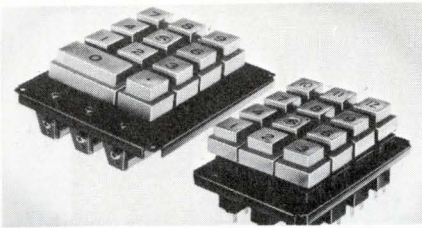

The "CR" series has normally open momentary action and a contact system that uses the resilience of the wire contacts. The gold-clad contacts provide a life of over 2 million operations. Current rating is 100 mA at 24 Vdc. Alcoswitch Div. of Alco Electronic Products, Inc., 1551 Osgood St., North Andover, Mass. 01845.

Circle Reader Service #239

DATA LINK PAIRS

WJ-2833 series oscillators and WJ-2823 series discriminators are for wide-band communication systems. Operating as data link pairs, they provide linear freq. modulation of a 3 GHz carrier in the 5 to 220 MHz range. Watkins-Johnson Co., 3333 Hillview Ave., Stanford Ind. Park, Palo Alto, Calif.

Circle Reader Service #240

DATA SET

The Tycom® 900 Data Set is an originate-only, full duplex data set with a -45 dBm receive sensitivity. It is compatible with the Bell System 103 and comes as a pc board modem for Data Access Arrangement users or as a complete acoustic coupler. \$69. Terminal Equipment Corp., 750 Hamburg Tpke, Pompton Lakes, N.J. 07442.

Circle Reader Service #241

NKRO KEYBOARDS

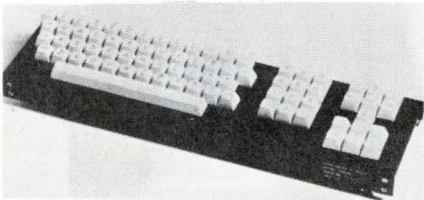

This broad line of general purpose keyboards is now available with N-key rollover protection. The feature allows each key to transmit its particular code in the exact sequence in which the keys were depressed. Licon, div. Illinois Tool Works Inc., 6615 W. Irving Park Rd., Chicago, Ill. 60634.

Circle Reader Service #242

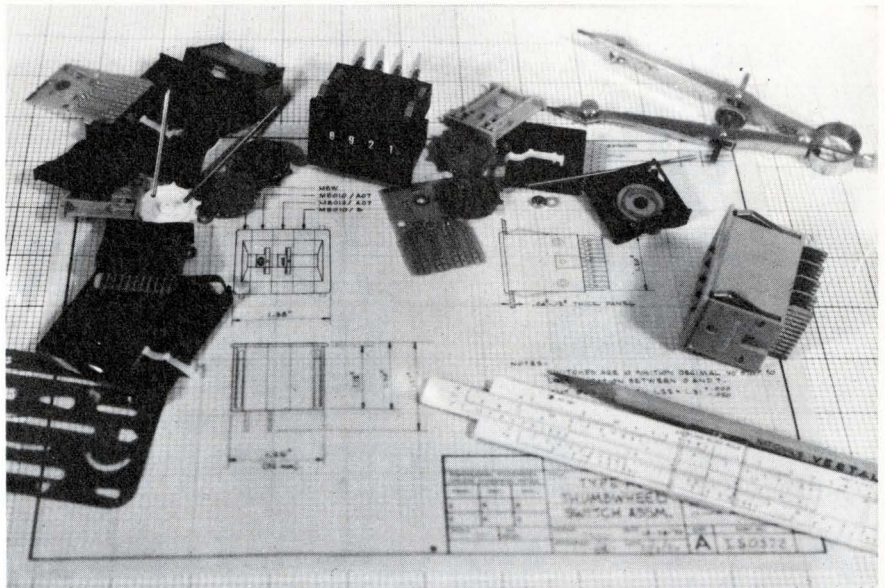

GO AHEAD!... DESIGN YOUR OWN

Chances are, whatever thumbwheel switch you end up with, INTERSWITCH already has a standard one that meets your design parameters, ready for off-the-shelf delivery. Our inventory includes the world's most complete selection of high-quality switches for application in computers, machine tool controls, data handling and test equipment. And even if your particular application requires a unique solution, we offer over 5 million custom configurations that can be assembled and delivered within 24 hours! This includes the most popular industry standards such as the front-mounted type M which features:

- Only 5/16" housings for less panel area
- Longer PCBs for component mounting
- Shallowest depths behind panel
- Availability in black, red, green, blue, yellow and white thumbwheels
- Custom markings on housings and spacers; decimal points, white lines, etc.
- Custom wheel markings
- 10 and 11 position thumbwheels, in both decimal and binary outputs
- Switch housings in black and beige
- Over 250 different binary output codes

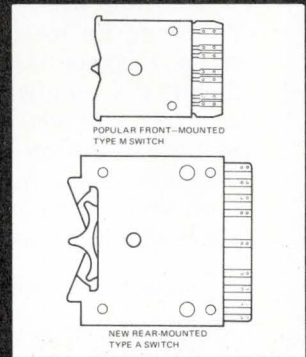

We also have available a new type A switch for rear-mounting applications, which includes more standard features than any other switch available. No matter what your design requirements or mounting preference, give us a call before you start re-inventing the wheel (thumbwheel, that is). You may find we've already done it for you.

Call us direct or call your nearest INTERSWITCH distributor or representative to find out.



ONE OF THE PURDY GROUP OF COMPANIES
Specialists in the MAN/MACHINE interface

770 AIRPORT BOULEVARD
BURLINGAME, CA 94010
TELEPHONE 415/347-8217

Circle Reader Service #21



Motorola Holds The Trump In Thyristors

And we want to deal you in!

Into one of the broadest thyristor lines available in the 1/2 to 100 A range. Backed by the No. 1 discrete house in the industry. But besides these two factors we're introducing several new reasons for letting us do the dealing.

For one, device number standardization.

Anyone who's ever specified thyristors realizes the jumble of house numbers staring him in the face; sometimes as many as thirty for one single device. Yet no one's had the motivation to standardize the situation by bringing 2N numbers, in mass, to this segment of the semiconductor industry.

Until now.

Motorola has begun a program of standardizing its total thyristor line — SCR's, triacs, triggers, UJT's, and diacs — by introducing 2N numbers to replace the frequent occurrence of house numbers. This will result in more useful specifications for easier device comparison and fast ordering procedures for both you and your company along with the peace of mind that comes with a 2N number.

A 2N number means security. Security that specs will play a repeat performance; no alterations just to satisfy manufacturing purposes.

A second idea is our glass-passivated process assuring uncontaminated junctions to provide the reliability in thyristors you've learned to expect from Motorola.

And the third idea we're promoting is really just common sense, but isn't commonly practiced — customer satisfaction. Well, we'd like to make customer satisfaction a common rule.

We want to supply you with every quality, reliable thyristor you need, whether you want one or thousands, when you want them, and at a price we're sure you'll find very attractive. To do all these good things we've committed our widely known and respected "production house" capability.

So take advantage of the offer on the opposite page. We know you'll draw a trump in thyristors.

YOUR FRANCHISED MOTOROLA SEMICONDUCTOR DISTRIBUTORS

ALABAMA, Huntsville	Gulf Electronics Corp.	(205) 539-2731	MICHIGAN, Detroit	RS Electronics	(313) 491-1012
ARIZONA, Phoenix	Hamilton/Avnet	(602) 269-1391	MINNESOTA, Edina	Low Bonn Co.	(612) 941-4860
CALIFORNIA, El Segundo	Liberty Electronics Corp.	(213) 322-8100	MINNESOTA, Minneapolis	Semiconductor Specialists, Inc.	(612) 854-8841
CALIFORNIA, Los Angeles	Hamilton Electro Sales	(213) 870-7171	MISSOURI, St. Louis	Semiconductor Specialists, Inc.	(314) 428-6100
CALIFORNIA, Los Angeles	K-Tronics/Wesco	(213) 685-9525	NEW JERSEY, Moorestown	Angus, Inc.	(609) 235-1900
CALIFORNIA, Mountain View	Elmar Electronics	(415) 961-3611	NEW JERSEY, Pennsauken	Radio Electric Service Co.	(609) 662-4000
CALIFORNIA, Mountain View	Hamilton/Avnet	(415) 961-7000	NEW MEXICO, Albuquerque	Kierulff Electronics Co., Inc.	(505) 247-1055
CALIFORNIA, Palo Alto	Kierulff Electronics, Inc.	(415) 968-6292	NEW YORK, Binghamton	Federal Electronics, Inc.	(607) 748-8211
CALIFORNIA, San Diego	Hamilton/Avnet	(714) 279-2421	NEW YORK, Hauppauge, L.I.	Cramer Electronics, Inc.	(516) 231-5600
CALIFORNIA, San Diego	Kierulff Electronics, Inc.	(714) 278-2112	NEW YORK, Rochester	Cramer Electronics, Inc.	(716) 275-0300
COLORADO, Denver	Hamilton/Avnet	(303) 433-8551	NEW YORK, East Syracuse	Cramer/Eastern	(315) 437-6671
CONNECTICUT, North Haven	Kierulff Electronics Co., Inc.	(303) 343-7090	NEW YORK, Westbury, L.I.	Schweber Electronics	(516) 334-7474
CONNECTICUT, North Haven	Cramer Electronics Inc.	(203) 239-5641	NEW YORK, Woodbury, L.I.	Harvey Radio Co., Inc.	(516) 921-8700
FLORIDA, Hollywood	Schweber Electronics	(305) 927-0511	OHIO, Cincinnati	Sheridan Sales Co.	(513) 761-5432
FLORIDA, Miami Springs	Gulf Electronics Corp.	(305) 885-8761	OHIO, Cleveland	Pioneer-Standard Electronics, Inc.	(216) 587-3600
FLORIDA, Orlando	Hall-Mark Electronics Corp.	(305) 855-4020	OHIO, Cleveland	Sheridan Sales Co.	(216) 524-8120
GEORGIA, Atlanta	Jackson Electronics Co.	(404) 355-2223	OKLAHOMA, Tulsa	Hall-Mark Electronics Corp.	(918) 835-8458
ILLINOIS, Chicago	Newark Electronics Corp.	(312) 638-4411	PENNSYLVANIA, Pittsburgh	Semiconductor Specialists, Inc.	(412) 781-8120
ILLINOIS, Chicago	Semiconductor Specialists, Inc.	(312) 279-1000	TEXAS, Dallas	Hall-Mark Electronics Corp.	(214) 231-5101
ILLINOIS, Schiller Park	Hamilton/Avnet Electronics	(312) 678-6310	TEXAS, Dallas	Sterling Electronics	(214) 357-9131
KANSAS, Lenexa	Hall-Mark Electronics Corp.	(913) 888-4747	TEXAS, El Paso	Midland Specialty Co.	(915) 533-9555
MARYLAND, Baltimore	Pyttron Industries, Inc.	(301) 539-6525	TEXAS, Houston	Hall-Mark Electronics Corp.	(713) 781-6100
MARYLAND, Rockville	Cramer/EW, Washington	(301) 948-0110	TEXAS, Houston	Sterling Electronics, Inc.	(713) 623-6600
MARYLAND, Rockville	Schweber Electronics	(301) 881-2970	UTAH, Salt Lake City	Cramer Electronics, Inc.	(801) 487-3681
MASSACHUSETTS, Lexington	R & D Electronics, Inc.	(617) 861-9200	WASHINGTON, Seattle	Hamilton/Avnet	(206) 624-5930
MASSACHUSETTS, Newton Centre	Cramer Electronics, Inc.	(617) 969-7700	WASHINGTON, Seattle	Liberty Electronics	(206) 763-8200
MICHIGAN, Detroit	Semiconductor Specialists, Inc.	(313) 255-0300	WISCONSIN, Milwaukee	Hall-Mark Electronics Corp.	(414) 476-1270



Pick A Card, Any Card— For A Free Thyristor From Motorola



To prove our commitment is no card player's bluff, we're inviting you to pick *one* of the following nine thyristors, all direct replacements* for those listed, to receive free.

Then just "Plug It In And Try It."

**Although these devices have comparable specifications, in some instances they may require slight modifications for the specific application before being considered "direct replacements."*

<p>If You're Using</p> <p>AA101 2N2689 AA108 2N3003 AA115 2N3007 B152 2N3029 BA152 2N3032 C103A 2N4097 CB202 2N4109 HR879A 2N4334 HR879B 2N5725 HR3029 2N5789 HR3032 2N5720 TSW22C 3F100 TSW100C 3G100 TSW101S 3J100 TIC46 3K100 1D102 3L100 2N879 3L1100 2N887 3L2100 2N950 4K100 2N2681 4L100 2N2685</p>	<p>Pick Motorola's FREE 2N5062</p> <p>100 V 800 mA TO-92 packaged SCR</p>
<p>If You're Using</p> <p>B01051 C122G B01052 C122B B01071 TA7404 B01072</p>	<p>Pick Motorola's FREE 2N4442</p> <p>200 V 8.0 A Thermopad† Case 90 packaged SCR GLASSIVATED!</p>
<p>If You're Using</p> <p>A1001 2N5755 A1002 40430 A1021 A03001 A03002</p>	<p>Pick Motorola's FREE 2N6071**</p> <p>200 V 4 A Thermopad Case 77 packaged Triac GLASSIVATED!</p>
<p>If You're Using</p> <p>B05041 2N685 B05042 2N6845 C30B 2N1845A C31B 2N1845B C35B 2N1846 C36B 2N1846A C37B 2N1846B C38B 2N4317 C135B 40742 TCR1520 40754 TCR2020 T13039 T1152</p>	<p>Pick Motorola's FREE 2N3897</p> <p>200 V 35 A "STUD" Case 175 packaged SCR</p>
<p>If You're Using</p> <p>SC50B SC60B TIC242B TIC252B TIC252B 2N5573 2N5806 2N5273 40662</p>	<p>Pick Motorola's FREE 2N6160</p> <p>200 V 30 A "STUD" case 175 packaged Triac GLASSIVATED!</p>
<p>If You're Using</p> <p>D5E43 D5E44 2N4898 5E29</p>	<p>Pick Motorola's FREE 2N4852</p> <p>$I_v = 4.0$ mA (min) TO-18 packaged UJT</p>
<p>If You're Using</p> <p>A01061 SC141B A01101 SC146B A01141 40668</p>	<p>Pick Motorola's FREE 2N6151**</p> <p>200 V 10 A Thermopad Case 90 packaged Triac GLASSIVATED!</p>
<p>If You're Using</p> <p>D13TI U13TI</p>	<p>Pick Motorola's FREE 2N6027</p> <p>$I_p = 2\mu$A (max) TO-92 packaged programmable UJT</p>
<p>If You're Using</p> <p>GBS203E TIC222B GBS226E TIC232B GBS210E GBS276D 2N5569 SC35B 40429 SC40B SC45B</p>	<p>Pick Motorola's FREE 2N6139</p> <p>200 V 10 A "STUD" Case 86 packaged Triac GLASSIVATED! **Use included external isolator if isolation is required.</p>

And along with that winning card, we'll also provide you with an "ace-in-the-hole" in the form of our new, complete 35-page **Guide To Thyristors**. This comprehensive book includes a guide to devices; selector guides; package outline dimension drawings; thyristor application guide; a guide to definitions, symbols, and terminology; and a thyristor cross-reference guide. It's **THE** thyristor guide; handy, informative, and concise; an invaluable reference manual for designers.

So pick out the Motorola thyristor card that can win for you, fill in the coupon, and mail it to your nearest Motorola franchised distributor today.

You can see this player means business — our cards are on the table!



†Trademark Motorola Inc.

I've picked a card! Send me the circled thyristor card (one only, please) including device, data sheet and "Plug It In And Try It" button along with my "ace-in-the-hole": Motorola's Guide To Thyristors.

SCR'S 2N5062 2N4442 2N3897
Triacs 2N6071 2N6151 2N6139 2N6160
UJT's 2N6027 2N4852

Name _____ Title _____
Company _____
Division _____ Dept. _____
Address _____
City _____ State _____ Zip _____

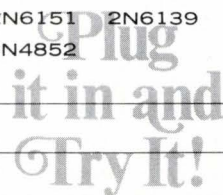

No more delay? . . . In a recent letter to FCC Chairman Dean Burch, the White House's Office of Telecommunications Policy (OTP) urged prompt action on the petitions for domestic satellite communications. OTP's Director, Dr. Clay T. Whitehead, went on to suggest that the applications of such organizations as Comsat, Comsat/AT&T, and Hughes/GTE could be handled by a policy of "open entry and competitive operation." This approach, used in the recent FCC decision on special common carriers, would not cause any harmful interference in the 4 and 6 GHz region, "even in the rather unlikely event that all proposed systems would be built."

A look at the future . . . Based on the responses of some 210 industry experts, Paul Baran and Andrew J. Lipinski of the Institute of the Future, Menlo Park, Calif., have predicted the telecommunications future, circa 1985. Among other portents, the study (180 pp., \$10) states that 1985 will see "Between five and 30 new inter-state carriers . . . and perhaps four separate special purpose satellite systems . . . and after several years of hearings, a new nationwide independent data network. . . ." The AT&T-sponsored survey estimates that by 1985 8 million terminals will be in use. The breakdown: 3.2 million, narrowband; 2 million, voiceband; 0.7 million, wideband; 1.4 million, Picturephone (data); and 0.7 million, Picturephone (personal and/or data).

Worried? Not us . . . Despite insistent claims to the contrary by specialized common carriers such as Datran and MCI, the growing demand for data transmission is "not on the verge of overwhelming the ability of the Bell System to meet demands for a complete line of communications services," according to AT&T Executive Vice President Cornelius Owens. Defending AT&T at the annual Digitronics Users Association Conference, Owens reasoned, "We estimate that 3 to 5% of transmission time on the Bell System's network is devoted to data. By 1980, we believe this may quadruple, but the relative size of the data market—as opposed to its absolute size and importance—has grown in measured increments rather than bounding leaps."

Easy rider . . . AT&T Chairman H. I. Romnes claims that a new technique will enable Ma Bell to meet the demand for digital transmission largely with existing facilities. Called DUV (Digital Under Voice), the development enables data to "hitchhike" on existing microwave radio systems at the lower end of the frequency band. The DUV system will be field tested in early 1972, in operation by 1974, and should enable Bell to meet the demand for digital data through 1977. AT&T officials have revised their estimates of the Bell data transmission market for 1980 upwards from \$2 billion to \$5 billion, compared with \$500 million last year. They also pointed out that the Bell system installed \$200 million worth of customer equipment this year, while competitors installed just \$8 million worth.

The world's largest net? . . . Representatives of 83 nations and 40 scientific organizations met in Paris to set up the World Science Information System, or Unisist. If the project is approved by the United Nation's Educational, Scientific, and Cultural Organizations (UNESCO), Unisist could be under way by 1973. The international data project will use the many existing resources instead of a single, massive information bank. However, the plan will require the development of a so-called "metalanguage" that can be read by any country's computers and then translated into its language.

It's a small(er) world . . . A small crystal filter, one cubic inch, enables GTE Lenkurt Inc. to announce a multiplex system three-quarters the size of comparable domestic systems. The crystal filter is composed of several thin layers of quartz in a capsule-like enclosure. Capable of transmitting 1,260 voice or data signals over single microwave radio or coax cable circuits for distances of 3,000 miles or more, the 46A3 multiplexer's capacity can be expanded to provide simultaneous transmission of 10,000 voice or data signals.

Circle Reader Service #243

Common cause . . . For the first time, national professional groups from the U.S. and Japan will co-sponsor a major computer conference. The U.S.A.-Japan Computer Conference, backed by the American Federation of Information Processing Societies (AFIPS) and the Information Processing Society of Japan (IPSJ), will be held in Tokyo, October 3-5, 1972. Plans are for a 50-50 split between the two countries in the exhibition area and technical sessions. The sessions will include papers on system architecture, computer networks and data communications, man-machine interaction, and a special emphasis on industrial and health and medicine applications. More information may be collected from AFIPS in Montvale, N.J.

Things are looking down . . . Motorola is the recipient of a \$1.5 million contract for a communications network in the new subway system in Wash., D.C. The system will use cable transmission, capable of handling all voice and data communications, including computer control of the trains and the link-up of all station kiosks to the central communications headquarters.

Bits and bytes . . . **Telecom, Inc.** has been awarded a \$60,000 contract by the Federal Aviation Administration to determine the operational requirements of the service B data communications system over the next decade. The accent is on state-of-the-art service at low cost.

A contract for over \$200,000 was awarded by Letterkenny Army Depot, Chambersburg, Pa., for some 400 I.I. Communications Corp. data sets. The data sets, aimed at very high-speed data transfer systems, are differentially coherent, four-phase, and on-line compatible with Bell and C.C.I.T.T. equipment.

THIS MONTH'S IDEAS	PAGE
Digital frequency separator	56
A simple FSK receiver	56
Line receivers with zero differential input.....	58

VOTE for the one you like best
Write the number of the Idea you like best in the box
on the inquiry card and send it to us.

SEND us practical, reproducible ideas that are original with you
and which have been implemented with linear or digital integrated circuits.
If we publish your idea, you win a check for \$25.00.
If our readers vote your idea the best of the issue in which it appears
you will receive a check for \$50.00.

Submit your IC Ideas to:
Alberto Socolovsky, Editor
THE ELECTRONIC ENGINEER
Chestnut & 56th Sts.
Philadelphia, Pa. 19139

HOW YOU VOTED

The winning Idea for the July 1971 issue is "Inexpensive divider extends range of 10 MHz counter to 100 MHz". Our prize-winning author is Mr. R. L. Starliper, who is a senior engineer with Western Electric in Burlington, N.C. Mr. Starliper is responsible for the design and development of various electronic subassemblies which form part of an automatic test equipment system.



Digital frequency separator

Leroy Young Jr., Western Electric Co., Greensboro, N.C.

This circuit will easily separate digital pulse inputs according to frequency. Monostable 1 is adjusted so that its period is equal to the period of the desired separating frequency f_o . Monostable 2 is set so its period is slightly longer than that of the lowest expected input frequency.

Allowing f_{in} to be a frequency swept digital input, the output of monostable 1 for inputs less than f_o is a series of pulses of the same frequency as f_{in} but with varying duty cycles. For inputs greater than f_o , the output of monostable 1 is a logic 1. Therefore, the output of mono-

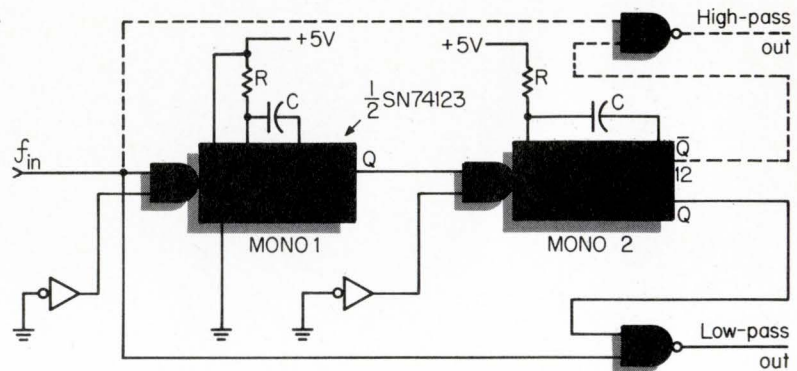

stable 2 is a logic 1 for all f_{in} less than f_o and a logic 0 (due to the lack of transitions from monostable 1) for all inputs greater than f_o .

Gating f_{in} with the Q output of monostable 2 provides a low-pass separator function, while gating with \bar{Q} provides a high-pass function.

To vote for this IC Idea, circle 913 on the Reader Service Card

A simple FSK receiver

Don Kesner, Motorola Semiconductor, Phoenix, Ariz.

This simple modem receiver converts the two audio tones in FSK systems into saturated logic levels. The op amp is used as a squaring circuit to convert the sinusoidal audio tones into a series of square wave pulses. Diode D_1 clips the negative half of the wave form, and the pulse train is fed to both a D-type flip-flop and a one-shot. Because the one-shot does not have a \bar{Q} output, you need the inverter stage (Q_1). This inverted output goes to a "digital differentiator" consisting of three NAND gates. The clock output from this circuit is about three DTL gate delays (100 ns) wide. This delay is insignificant at the data rates commonly used for telephone communications.

You can consider the circuit as a sample-and-hold, with the one-shot providing a timing signal for the sample. The negative edge of the squared input from the op amp triggers the one-shot.

If the time period established by R_1 and C is less than the period of

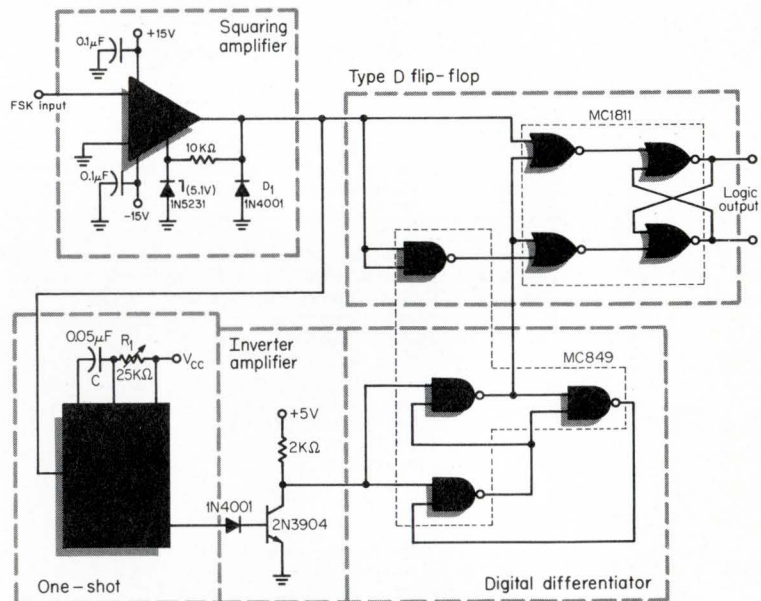

the squared input, the input is still low when the one-shot goes to the 0 level. This causes the differentiator to produce a clock pulse, setting the flip-flop to the 0 state. However, if

the squared signal goes to the high state during the natural period of the one-shot, the clock samples the high state and produces a logic 1 at the output.

To vote for this IC Idea, circle 914 on the Reader Service Card



TOP PRODUCTION NUMBER FOR PCB DRILLING!

Gardner-Denver N/C Grid-Drill™ makes 180 hits per minute, with from 4 to 16 individual spindles in a wide choice of arrangements. Handles as many as four stacks of boards as large as 15.5"x22" per stack. Drills hole sizes .010" to .250" with a variety of spindle speeds, including belt drive ball bearing to 50,000 rpm and air bearing to 90,000 rpm. Maintains accuracies of $\pm .0015"$, to random holes measured from common reference, through years of production service. Write for Bulletin AC-35 on this drill and the whole family of Wire-Wrap* equipment and related electronic products.

GARDNER-DENVER

Gardner-Denver Company, Quincy, Illinois 62301

*Wire-Wrap is a registered trademark of Gardner-Denver Company

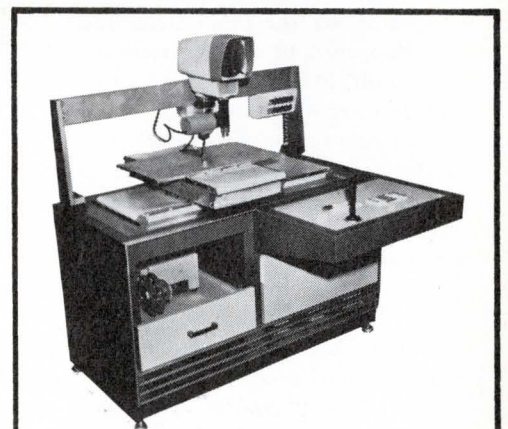

Prepare your own N/C tape automatically, too!

New Gardner-Denver N/C Programmer eliminates the tedious writing of program manuscripts. Works directly from undimensioned artwork. Makes its calculations automatically. Delivers the punched tape in a fraction of the time normally required.

Line receivers with zero differential input

Dale Pippenger, Texas Instruments Incorporated

Nowadays, line receiver ICs are being used in applications where the differential input voltage may be zero. In addition, because of their high sensitivity (resulting from a circuit gain which may be as high as 1000) these devices are being used as voltage comparators and level sensors.

While being advantageous, the high gain characteristic can pose some difficulties when the differential input voltage is near zero. Problems arise under these conditions because at differential levels below the threshold of the receiver, the device is operating in a linear region. With a typical gain of 1000, the receiver is therefore susceptible to noise and possible oscillation. Two different circuit approaches can be used to prevent oscillations in these types of applications.

The top circuit shows a scheme for open data line operation in applications where the input data line may be opened, or all the drivers are strobed off. In this circuit, a positive voltage is applied through a 10 k Ω resistor resulting in a +25mV level at the minus input and a logical 0 output. This places the receiver in a determinant condition, and it therefore will not oscillate.

The bottom circuit is a low frequency threshold detector. When using the line receivers shown, it is desirable to have some hysteresis and Schmitt trigger action. This will force the receiver through its linear operating region rapidly to prevent oscillation and noise interference. Resistor R_f , which provides the positive feedback required for the desired Schmitt trigger action, should be 5k to 10k Ω .

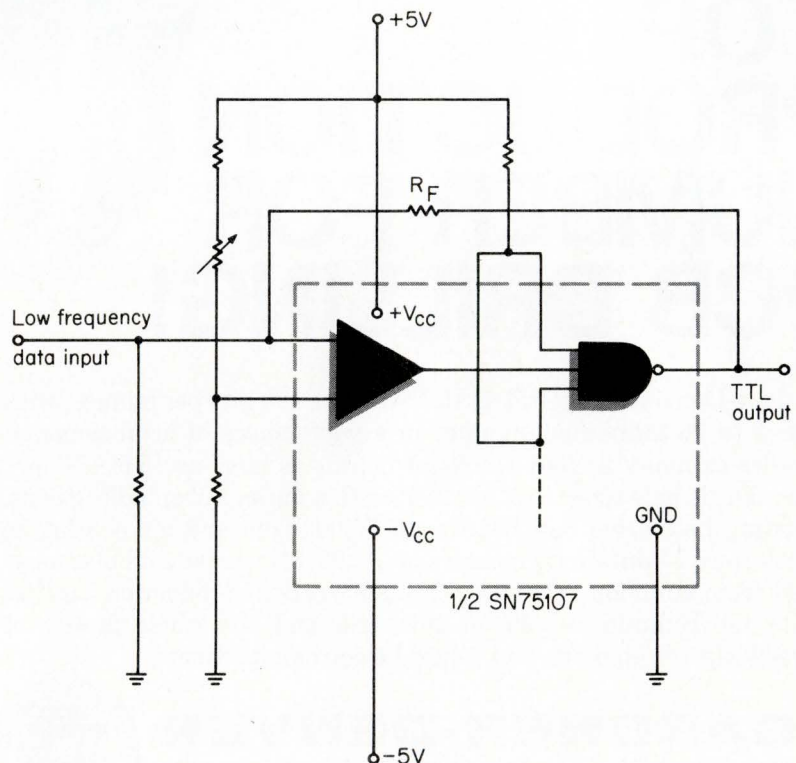
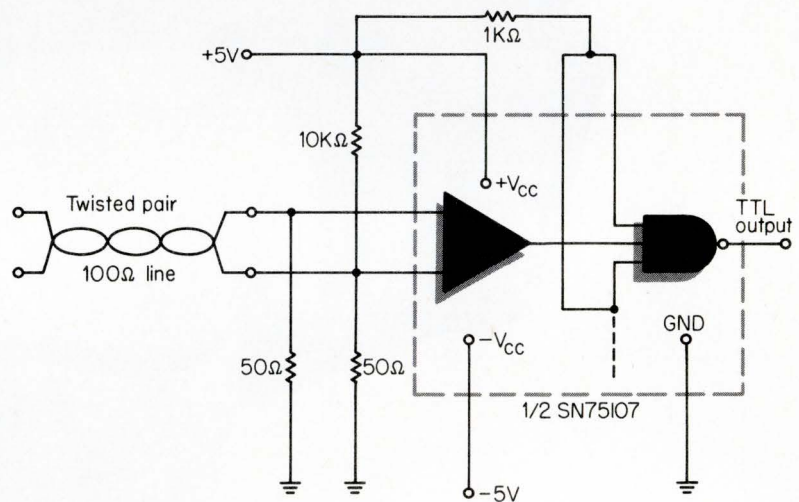

To vote for this IC Idea, circle 915 on the Reader Service Card

700V Planar

HI-VOLTAGE SILICON POWER TRANSISTORS

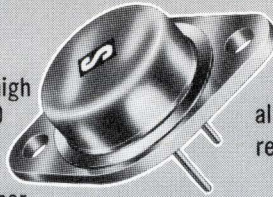

JEDEC
TO-3 CASE

First, Solitron announced the high voltage silicon power SDT 1050 Series. Next, Solitron announced the high voltage SDT 400 Replacement Series offering higher gain and reliability. Now Solitron has gone a giant step further and developed the new and unique high voltage SDT 500 Series with breakdown voltages (V_{CEX}) from 200 to 700 V. All transistors in this series utilize hi-rel planar construction and are SiO_2 passivated. Yet, there is no reduction of I_s/b and E_s/b ratings.

These new devices are ideal for power supplies,

all CRT deflection circuits, converters, inverters, relay drivers and series regulators.

FEATURING:

- I_{CBO} less than 50 μA @ 80% of V_{CBO}
- Excellent H_{FE} stability with temperature
- Typical 1.0 Amp Switching times ($I_C/I_B=10$) $I_{B1}=I_{B2}=100$ ma
 $t_r=600$ nsec, $t_s=1.5$ μ sec, $t_f=500$ nsec
- Low $\theta_{j-c}=1.0^\circ C/W$ Max., $0.8^\circ C/W$ Typ.
- $V_{BE0}=15$ V Min. @ 1 ma

SOLITRON SDT 500 SERIES SELECTION GUIDE

$V_{CE(S)}$ ($I_C=1.0A, I_B=0.1A$)
 H_{FE} ($I_C=1A, V_{CE}=5V$)

V_{CEX} @ 1 ma	200V	250V	300V	350V	400V	450V	500V	550V	600V	650V	700V
V_{CE0} @ 100 ma	200V	250V	250V	300V	300V	350V	350V	400V	400V	450V	500V
$V_{CE(S)}$ 0.4 h_{FE} 50-150	SDT520	SDT525	SDT530	SDT535	SDT540	SDT545	SDT500	SDT550	SDT560	SDT565	SDT570
$V_{CE(S)}$ 0.5 h_{FE} 30-90	SDT521	SDT526	SDT531	SDT536	SDT541	SDT546	SDT501	SDT551	SDT561	SDT566	SDT571
$V_{CE(S)}$ 0.6 h_{FE} 10 Min.	SDT522	SDT527	SDT532	SDT537	SDT542	SDT547	SDT502	SDT552	SDT562	SDT567	SDT572
$V_{CE(S)}$ I_C/I_B	1.0 max. 5A/1A	1.0 max. 5A/1A	1.0 max. 4A/0.8A	1.0 max. 4A/0.8A	1.0 max. 4A/0.8A	1.0 max. 4A/0.8A	1.0 max. 4A/0.8A	1.0 max. 4A/0.8A	1.0 max. 3A/0.6A	1.0 max. 3A/0.6A	1.0 max. 3A/0.6A

For complete information, prices and engineering application assistance, dial toll-free 1-800-327-3243. Or write:

Solitron

DEVICES, INC.

1177 BLUE HERON BLVD. / RIVIERA BEACH, FLORIDA / (305) 848-4311

TWX: (510) 952-7610

SAN DIEGO, CAL.
8808 Balboa Avenue
FET & Dual FET
Transistors
MOS/FET Devices
MOS Memory Arrays
Shift Registers
Monolithic IC's
Small Signal
Transistors

RIVIERA BEACH, FLA.
1177 Blue Heron Blvd.
Hi-Rel Power Transistors
SI & Ge. Power
Transistors
Hi-Rel Power Hybrids
PNP-NPN Industrial
Transistors

PORT SALERNO, FLA.
Cove Road
Microwave Connectors
Plaxial (R) Cable
Precision RF Coaxial

JUPITER, FLA.
1440 W. Indiantown Rd.
Microwave Stripline
Components
Microwave Semiconductor
RF Semiconductor
Microwave Integrated
Circuits

TAPPAN, N. Y.
256 Oak Tree Road
Diodes & Rectifiers
Zeners
High Voltage
Assemblies
Power Rectifiers
Thick Film Hybrid
Circuits
Ferrite & Ferrite Devices
Film Resistors

KENT, ENGLAND
Tubbs Hill House
London Road,
Sevenoaks
Solidev, Ltd.
Full line of
Solitron devices

BEN BARAQ, ISRAEL
51 Hayarkon Street
AEL Israel, Ltd.
Full line of
Solitron devices

TOKYO 105, JAPAN
No. 5, 3-Chome
Shibahamamatsu-Cho
Minato-Ku
Matsushita Electric
Trading
Full line of
Solitron devices

NEW PRODUCTS

A timely display

Arthur Freilich, President, Chrono-log Corp.

The better mousetrap or time display is always around the corner. So when one of our best customers for digital clocks came to us and asked us for a time display that was large, operated in high ambient light, and could be placed in several remote locations, we looked for a new solution.

Electronic digital clocks are used as a source of time information for data processing, telemetry, computer and controls systems. Their use as central time sources for displaying time in several remote locations, however, has been hampered by three problems in the past:

- High cost of remote display units, particularly devices which accept serial data.
- Cost and complexity of cabling for remote displays with parallel BCD data inputs. For example, 20 data lines are needed to transmit hours, minutes and seconds in BCD form, while 45 lines are needed if transmission is in decimal format.
- High cost of large size display elements (over 1 in. character height).

After studying all of the possibilities for a time display, we decided to add a video output to our standard IC digital clock, and display time on a standard TV monitor. The monitor itself costs less than \$150.00 per remote station, after the initial cost of the video digital clock to supply the video. Video is supplied to the monitors by one coax line linking all of the remotes together.

For one type of digital display we have used Nixies®, and these with the necessary electronics, cost \$500.00 to \$600 to display time in hours, minutes and seconds. The video digital clock and one standard TV monitor costs about \$2,060. But if you want three or more remotes, it is more economical to use the video clock since you must multiply the price of a single Nixie readout by

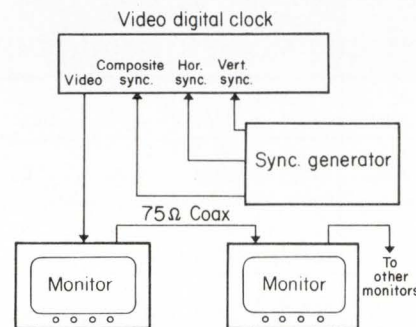
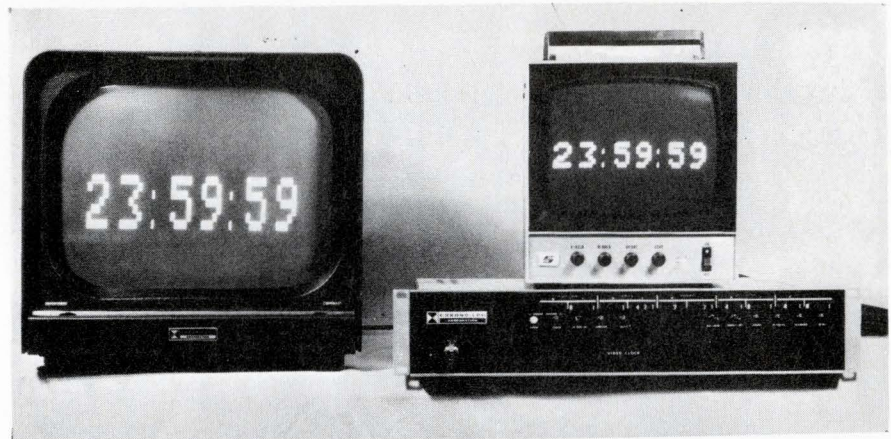

Two different sizes of TV video monitors used for digital displays. In this manner, digital TV monitors are used to display time. These digital displays can also be used for other digital data.

This block diagram will give you an idea of how easily TV displays may be added and interconnected.

the number of remotes needed. With the TV monitor, the cost is less than \$150.00 for each additional monitor after the initial investment. And you can have a larger display.

Although the monitor depicted here was designed to display time from our video digital clock system, the addition of some more electronics makes it a readout for any digital information if you need more than one display (only one display would be expensive).

The remote displays are standard CCTV monitors which are available in sizes from 5 to 21 in. and larger. By choosing the proper size monitors, the various character heights range from 1 1/2 in. on a 9 in. monitor, and up to 5 in. on large monitors.

The character height (and hence the aspect ratio) of the digits can be changed at each monitor by adjustment

of the monitor's vertical height setting. This allows adjusting each monitor to meet the viewing needs and preferences of those using that particular monitor. Also, the brightness can be set so that the characters are clearly visible in almost any ambient lighting.

The character video output in the clock is generated by means of a Read Only Memory (ROM) ASCII code character generator. Digits are selected by the character generation system at the proper time and fed to the ROM. In addition, an address corresponding to the horizontal line of the character being generated is also fed to the ROM. The output of the ROM is a 5 x 7 character matrix, as you can see in the photograph. Chrono-log Corp., 2853 West Chester Pike, Broomall, Pa., 19008. Circle No.

Circle Reader Service #250

ECONOMY LED DISPLAY

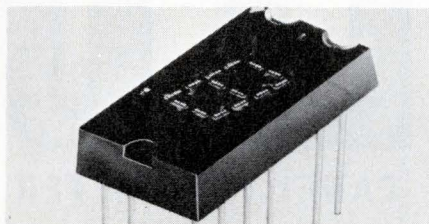

Data-Lit 10A, a 7-segment LED display, is an economy model replacement for the MAN-1 and MAN-1A. Minimum brightness is spec'd at 100 fL at 10 mA with typicals of 500 fL at 10 mA. \$6.75 (1000 pc. quan.). Litronix, Inc., 19000 Homestead Rd., Cupertino, Calif. 95014.

Circle Reader Service #251

DELAY LINE

This delay line converts TV video signals from interlace to non-interlace or vice versa. Designed for PC board mounting, Model 0.5HM has a nom. delay of 32 μ s, and a delay tol. of ± 10 ns. Walther M. A. Andersen & Assoc., 4 Main St. Ext., Tariffville, Conn. 06081. (203) 658-7666.

Circle Reader Service #252

OPTICAL SHAFT ENCODER

The Disc Rotaswitch 860 series encoder, which is only 1.5 in. in dia. x 1.2 in. long, uses a LED source to replace the incandescent lamps normally used in encoders. Disc Instruments, Inc., 2701 S. Halladay St., Santa Ana, Calif. 92705.

Circle Reader Service #253

PHOTO-ELECTRONIC CONTROL



This new control unit contains: one silicon photo element, one silicon npn transistor and two silicon diodes. It is suitable for direct relay driving. Rise time is 3.5 μ s. \$5.77 ea. (100 quan.). European Electronic Products, Corp., 10150 W. Jefferson Blvd., Culver City, Calif. 90230.

Circle Reader Service #254

RMC

TEMPERATURE COMPENSATING SOLDER-INS

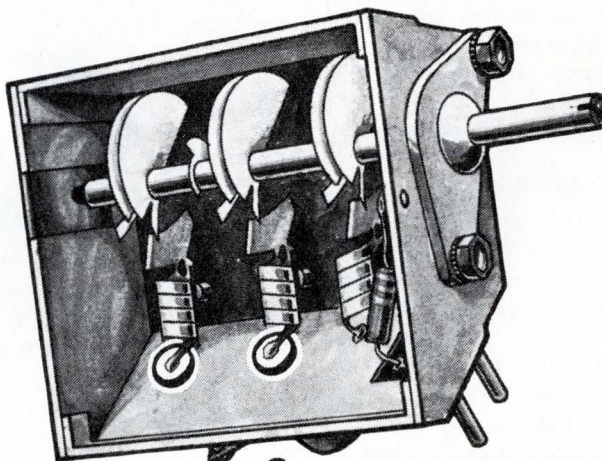

for

UHF APPLICATIONS

SPECIFICATIONS

CAPACITANCE: Within tolerance @ 1 MC and 25°C

CAPACITANCE TOLERANCES: $\pm 5\%$, $\pm 10\%$ or $\pm 20\%$ (but not less than ± 25 pf)

WORKING VOLTAGE: 500 VDC

INSULATION RESISTANCE: Greater than 7500 Megohms @ 500 VDC

FLASH TEST: 1000 VDC for 1 second

ELECTRODE: Pretinned for assured solderability

These new solder-in capacitors are designed for use in UHF applications requiring the absolute minimum in lead inductance effects. Solder-ins are available in a wide range of temperature coefficients in capacities from 1.5 to 105 pfd.

If your application requires special physical or electrical characteristics, contact RMC's Engineering Department.

Write today on your company letterhead for your copy of the RMC Catalog.

VISIT BOOTH 3C12-3C18 IEEE SHOW

DISCAP
CERAMIC
CAPACITORS

RMC

RADIO MATERIALS COMPANY

A DIVISION OF P. R. MALLORY & CO., INC.
GENERAL OFFICE: 4242 W. Bryn Mawr Ave., Chicago 46, Ill.
Two RMC Plants Devoted Exclusively to Ceramic Capacitors
FACTORIES AT CHICAGO, ILL. AND ATTICA, IND.

Circle Reader Service #27

NEW PRODUCTS

5000 V OPTO-ISOLATOR

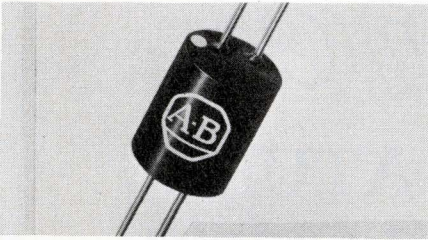

This opto-isolator has 5000 V isolation and a rise time (3.5 ms) that blocks hf transients. The PT-001, consists of an LED light source and a spectrally matched photoconductive cell assembled in a light-tight tubular package. Allen-Bradley Co., 1201 So. 2nd St., Milwaukee, Wis. 53204.

Circle Reader Service #255

REFERENCE AMPS

These amplifiers (CH2001 to CH2004) are for use in precision measuring applications. They have good stability characteristics with TCS of reference voltage of ± 10 , ± 25 , ± 50 , and ± 100 ppm/ $^{\circ}\text{C}$ plus low short-term drift. Centralab Semiconductor, 4501 N. Arden Dr., El Monte, Calif. 91734.

Circle Reader Service #256

PORCELAIN CAPACITORS

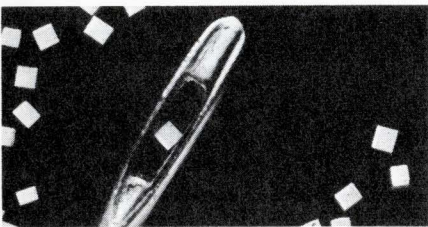

ATC 150 series chip capacitors have low insertion loss to 12 GHz, in capacity values from 0.1 to 100 pF. Termination material is Palladium Silver. From \$0.46 (1000 quan.). American Technical Ceramics, One Norden Lane, Huntington Station, N.Y. 11746.

Circle Reader Service #257

TANDEM SLIDE SWITCHES

Switches 47202LR (spst) and 47206LR (dpdt) are made with two independent single actuator knobs. Featuring "double-wipe" slide action, they provide "two switches in one" for quick production line installation, lower cost and greater density packaging. Switchcraft, Inc., 5555 No. Elston Ave., Chicago, Ill. 60630.

Circle Reader Service #258

CONNECTOR/POTTING KIT

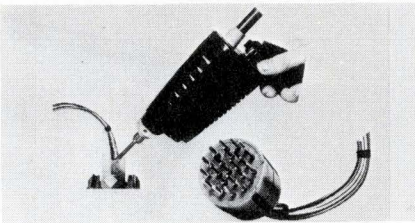

With this kit, containing polyethylene cartridges, connector contacts and a new industrial rated heat gun with an interchangeable nozzle feature, you can injection mold a mate to almost any connector. The polyethylene may also be used for many encapsulation and waterproofing applications. Wiring Analyzers, Inc., 9015 Wilshire Blvd., Beverly Hills, Calif. 90211.

Circle Reader Service #259

TRANSISTOR CHIPS

Here are some unmounted and unencapsulated power transistor chips that can be directly mounted on a heat sink in hybrid circuits. They can be used either singly or in complementary-pair configurations. The CH3439 family are passivated mesa npn chips. The CH2102 and CH5320, and CH4036 and CH5323 families are hv npn and pnp chips, respectively. RCA Solid State Div., Somerville, N.J. 08876.

Circle Reader Service #260

MEET ONE OF THE FAMILY

TRIMMERS

- TC to 10 ppm/ $^{\circ}\text{C}$.
- Setability to 0.05%.

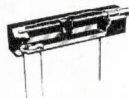

1200 Series superior to MIL Type RJ12

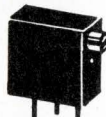

1240 Series 1/4" square Available after Feb. 1, 1972



Vishay has a resistor product that will exceed your performance specs . . . Send for your free application Bulletin G-11.

VISHAY RESISTOR PRODUCTS

63 LINCOLN HIGHWAY ■ MALVERN, PENNSYLVANIA 19355

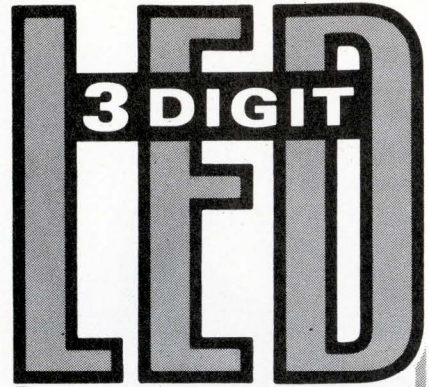

PANEL VOLT METER



- L•E•D DISPLAY
- HI SPEED OPERATION — 100 CONVERSIONS/SEC.
- DIGITAL SAMPLING A/D CONVERTER
- BUFFERED BCD OUTPUT — STANDARD
- COMPLETE SYSTEM CONTROL PROVISIONS

New! 3 Digit Panel Volt Meter for high speed use with computer controlled systems. Digital sampling technique provides high reliability and improved performance specs in both accuracy and stability; .05% accuracy at room temperature, .1% from 0 $^{\circ}$ C to 50 $^{\circ}$ C operating ambient.

Rugged all aluminum case, polarized lens and L•E•D display . . . a premium instrument at a moderate price . . . \$180

Design compatibility with all ERC Digital instruments—Counter—Clock—Stop Watch—Calendar Clock—Preset—Remote Display—Comparator—Frequency Meter.

call or write Bob Rush for technical data
Phone 913, 631-6700



electronic research co.

Box 913 • Shawnee Mission, Kansas 66202

NEW PRODUCTS

PUSHBUTTON SWITCH

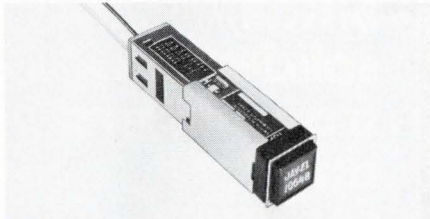

Soldering is not needed to connect these switches—they use a terminal junction system that accepts a Mil-C-39029/1-20 pin. Switching actions are momentary, magnetic holding and maintained depressed alternate. Jay-El Products, Inc., 1859 W. 169 St., Gardena, Calif. 90247.

Circle Reader Service #261

PRECISION CAPACITORS

Series 22R metallized polycarbonate capacitors achieve very flat capacitance change over wide temp. range similar to polystyrene along with the miniature size advantage of metallized mylar. TC: 1.5% max. change from -55° to 25°C , -0.7% from 25° to 105°C . S&EI Mfg., 18800 Parthenia St., Northridge, Calif. 91324.

Circle Reader Service #262

TV RATED SWITCH

The LPM switching assembly was designed specifically to achieve the new UL rating of TV-5 for an "On-Off" volume control switch. It uses a variable resistor with a miniature precision TV-5 rated snap switch, attached in push-pull fashion. Stackpole Components Co., Box 14466, Raleigh, N.C. 27610.

Circle Reader Service #263

MULTIPLE OUTPUT SUPPLIES

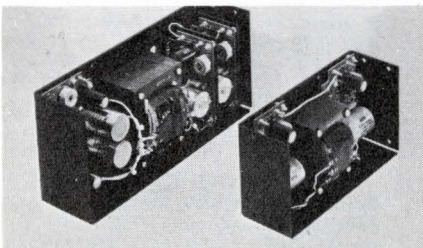

New series of OEM supplies includes two models with dual outputs for analog circuits and two with triple outputs for analog and digital outputs. The fully isolated outputs may be interconnected for any \pm requirement including MOSFET applications. Powertec, Inc., 9168 DeSoto Ave., Chatsworth, Calif. 91311.

Circle Reader Service #264

EPOXY RESIN

Eccoseal W 19 is a low viscosity (250 cps) epoxy resin, which may be used either as an impregnant or as a casting resin. It can also be used as a surface coating, which may be brushed, sprayed, or applied by dipping. Emerson & Cuming, Inc., Canton, Mass. 02021.

Circle Reader Service #265

LOW SHRINKAGE EPOXY

Tra-Cast 3107 is for casting, potting, encapsulating and tooling applications. It is a solvent-free, two-part system that blends easily to a medium viscosity liquid with good flowability. Tra-Con, Inc., 55 North St., Medford, Mass. 02155.

Circle Reader Service #266

PC SLIDE SWITCHES

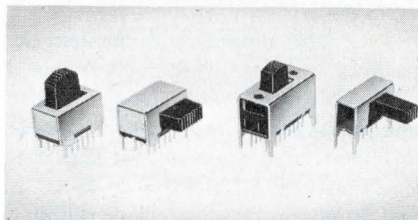

Low profile MSS miniature switches occupy less space than normal miniature toggle switches. They are rated at 0.3 A at 125 Vac. Alcoswitch, Box 1348, Lawrence, Mass. 01842.

Circle Reader Service #267

POTTING COMPOUND

A combination of low viscosity (6000 to 8000 cps at 25°C) and low dielectric constant (3.9 at 25°C and 100 kHz) makes Castall 402 suitable for potting densely packaged low-power devices. Castall, Inc., Weymouth Ind. Park, East Weymouth, Mass. 02189.

Circle Reader Service #268

PINS AND SOCKETS

Mating pin sizes are 0.019 in. dia. and 0.029 in. dia. Available sockets accept pin diameters of 0.019 thru 0.028 in. and 0.028 thru 0.035 in. This range fits most std., modularized components, controls, circuit boards, testing and computer peripheral equipment. \$25.00/100 for sockets (AP 923625 and AP 923627) and \$20.00/100 for pins (AP 923626 and AP 923628). A P Inc., 72 Corwin Dr., Painesville, Ohio 44077.

Circle Reader Service #269

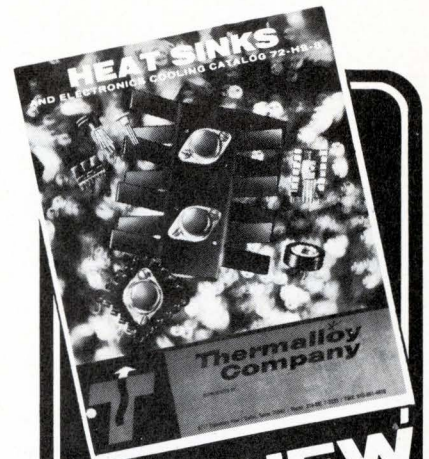

THE NEW Thermalloy HEAT SINK CATALOG 1972

FREE CATALOG

An easy to use, 40 page catalog containing over 150 configurations designed to quickly solve your electronic cooling problems. Simple selection guide eliminates complex calculations.

OVER 40 NEW PRODUCTS

Including:

- DIP HEAT SINKS
- PLASTIC POWER HEAT SINKS
- VERTICAL HEAT SINKS
- DISC PACKAGE HEAT SINKS
- LIQUID COOLED SYSTEMS



SEND FOR
FREE
CATALOG

Thermalloy

8717 DIPLOMACY ROW
DALLAS, TEXAS 75247
PHONE: 214/637-3333
TWX: 910/861-4410

Circle Reader Service #32

NEW PRODUCTS

NUMERIC DISPLAY PANEL

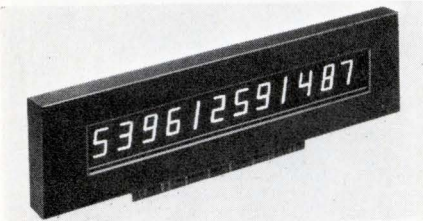

NDP1250 panel is a 9-segment, multi-character, cold-cathode, gas discharge display. Panels are available with a minimum of 8 and maximum of 16 characters. National Electronics, Inc., Geneva, Ill. 60134.

Circle Reader Service #270

10-MEGOHM PANEL METERS

This new line of meters for voltage and current measurements is available with an input Z of 10 M Ω , and with optional memory capability. Ideal Precision Meter Co., Inc., 214 Franklin St., Brooklyn, N.Y. 11222.

Circle Reader Service #271

POWER DEVICE COOLERS

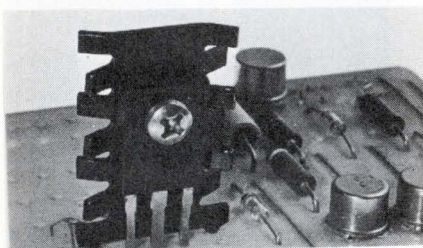

This cooler (the 6025), for vertical mounting of plastic power devices, is an aluminum heat sink that will accommodate most single mounting tab and most hole-through-case configurations. From \$0.14 to \$0.35. Thermalloy Co., 8717 Diplomacy Row, Dallas, Tex. 75247.

Circle Reader Service #272

VARIABLE CAPACITORS

Model 7271 features the use of low loss ceramic dielectrics and is well suited for fine tuning of crystal oscillators from kHz to GHz frequencies. It is for PC mounting or for welding to microstriplines. Johanson Mfg., Corp., 400 Rockaway Valley Rd., Boonton, N.J. 07005

Circle Reader Service #273

CERAMIC CAPACITORS

Size of the ceramic-dielectric UFP series capacitors is 0.546 in.² by 0.172 in. thick. Designed for high power rf applications they are rated at 8 A at +25°C. Capacitance values available range from 10 to 3000 pF. JFD Electronics Corp., 15th Ave. at 62nd St., Brooklyn, N.Y. 11219.

Circle Reader Service #274

TANTALUM CAPACITORS

Type DNS dipped solid tantalum capacitors are designed to replace aluminum electrolytics where reliability, size and stability is a prime factor. Available in either radial or axial lead construction they cost \$0.20 for a 1 μ F 35 V, and \$0.24 for a 6.8 μ F 35 V. National Components Industries, Inc., 5900 Voss Rd., West Palm Beach, Fla. 33407.

Circle Reader Service #275

R&P CONNECTORS

Two new rack and panel connectors will be priced from 8 to 12¢/contact. A 50-pin male version is interchangeable with connectors meeting the requirements of Mil-Std-24026. A 104-pin male version is interchangeable with connectors meeting the requirements of MS18263. GTE Sylvania Inc., 12 Second Ave., Warren, Pa. 16365.

Circle Reader Service #276

Immediately available!

Small, solid-state transmitters and receivers

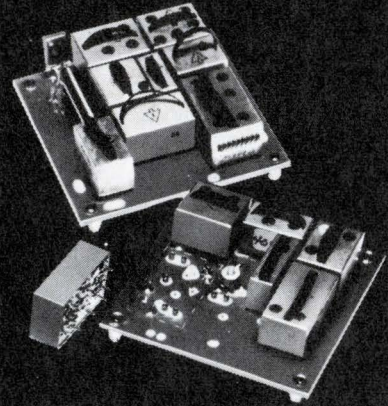

Searching for telemetry radio links?

Get plugged-in answers with REPCO's widely used low-cost, modular, FCC type accepted transmitters and receivers — Radio links come easy and natural to us as we are one of the world's largest manufacturers of hand-held two-way radios.

TRANSMITTER: Power ranges from 0.5W to 25 Watt. Frequency range is 25–50, 66–88, 132–174 MHz. Voice or tone at 300 to 3000 Hz; 16F3 or 15F2; weight 6 oz.; size 3.32" x 3.32" x 1".

RECEIVER: Frequency ranges match those of transmitters; sensitivity, 0.5 microvolt (20 db quieting); audio output, 750 milliwatts; weight 6 oz.; size 3.32" x 3.32" x 1".

For use under FCC parts 21, 81, 83, 89, 91, 93 and U.S. Government Services (Non-Tactical).

Size, weight and other design factors make it simple to adapt these TRANSMITTERS and RECEIVERS to fit your TELEMETRY or DATA ACQUISITION SYSTEM needs. Modules make maintenance quick and easy.

Repco

REPCO Incorporated,
Special Products Dept.
P.O. Box 7065, Orlando, Florida 32804
Telephone (305) 843-8484

MR inquiries invited

Circle Reader Service #36

MEET ONE OF THE FAMILY

DIRECT REPLACEMENTS for PRECISION WIREWOUNDS

- TC better than -10 ppm/°C.
- More performance at less cost.



V-53 Series $\frac{1}{8}$ the board space of RB-53



M-53 Series RB-53 size



Vishay has a resistor product that will exceed your performance specs . . . Send for your free application Bulletin G-11.

VISHAY RESISTOR PRODUCTS
63 LINCOLN HIGHWAY ■ MALVERN, PENNSYLVANIA 19355

Circle Reader Service #35

NEW PRODUCTS

MINIATURE RELAYS

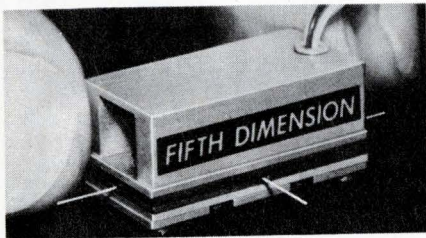

Two new relays provide lifetimes of 100-million operations in microstrip or stripline applications, handling rf (Logcell Model SLR 1103) or high speed pulse signals (SLR 1104 Logcell). They are $< \frac{1}{2} \times 1 \times \frac{7}{16}$ in. and weigh $< \frac{1}{2}$ oz. Fifth Dimension Inc., Box 483, Princeton, N.J. 08540.

Circle Reader Service #277

5 AMP RELAY

New addition to Thinpak series of AZ relays is only 0.435 in. high and can switch 5 A at 26 Vdc. The Model 535 was designed for applications with operating requirements that cannot be met by reed relays or normal contact type relays. \$1.81 ea. (1000 pc. quan.). American Zettler, 697 Randolph Ave., Costa Mesa, Calif. 92626.

Circle Reader Service #278

GENERAL PURPOSE RELAY

Series HM 3A subminiature relays are U.L. recognized, and are intended to meet GP control system and home appliance requirements. Babcock Electronics Corp., 3501 N. Harbor Blvd., Costa Mesa, Calif. 92626.

Circle Reader Service #279

MINIATURE REED RELAYS

Series 262 are miniature 10 W relays that feature high speed and vibration resistance. They are safely cradled within a resilient shock absorbing frame. Wheelock Signals, Inc., 273 Branchport Ave., Long Branch, N.J. 07740.

Circle Reader Service #280

POWER RECTIFIERS

Three new series of high efficiency power rectifiers with typ. recovery time of 15 ns in any circuit and forward voltage drop as low as 0.8 V at 20 A, come in 50, 75, 100 and 125 V types. They are: UES101 to 104 for 2.5 A, UES201 to 204 for 6 A, and UES301 to 304 for 20 A applications. Unitrode Corp., 580 Pleasant St., Watertown, Mass. 02172.

Circle Reader Service #281

Talk to Gudebrod

...about tying wire bundles
Lacing Tapes
Dial Cords
and Systems

...about harness rooms

Speed
Economy
Lab Control
Vibration
Temperature

...about Quality

...and about our
quarter of a century
of experience with *tough*
problems like yours!

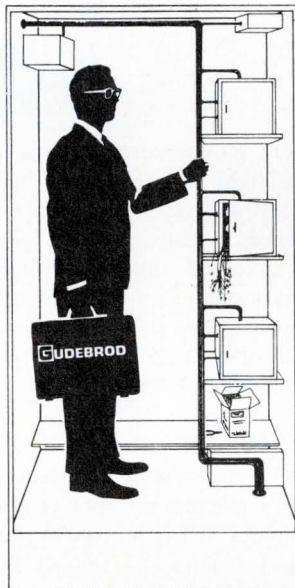

Gudebrod is known around the world as the "Quality House" for Lacing Tapes and Harness systems. We use knowledgeable company men and have five branch offices in the United States to serve you. Write to this address for prompt return of our Product Data Catalog. Should you be well into a project that needs immediate attention—phone the nearest office . . . Ask for the Electronics Division. *Then we can really do some talking!*

Philadelphia	215-WA 2-1122	Chicago	312-DE 7-3025
New York	212-LA 4-5858	Burbank	213-848-3962
Boston	617-HA 6-5347	Charlotte	704-333-9591

Export Division Office in New York

Gudebrod Bros. Silk Co., Inc.

FOUNDED IN 1870

Electronics Division

Dept. 512

12 SOUTH 12th STREET, PHILADELPHIA, PENNSYLVANIA 19107

Circle Reader Service #37

NEW PRODUCTS

LOGIC SWITCH

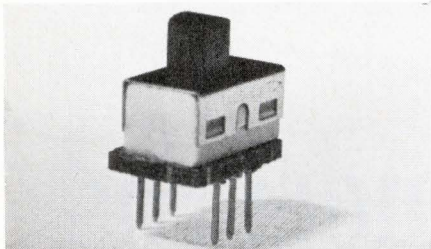

The LS-1 logic switch provides a dpdt snap action switch in a six pin DIP. Switch contacts are gold plated and rated at 1/2 A, 10,000 actuations. \$1.97 ea. (5000 quan.). Unique Devices Co., Box 70, Bountiful, Utah 84010.

Circle Reader Service #282

THIN THUMBWHEEL SWITCH

New 1976 series of rotary thumbwheel switches are only 0.350 in. wide. They are offered with 8, 10 and 12 position codes. Electronic Engineering Co. of California, 1441 E. Chestnut Ave., Santa Ana, Calif. 92701.

Circle Reader Service #283

EDGEBOARD CONNECTOR

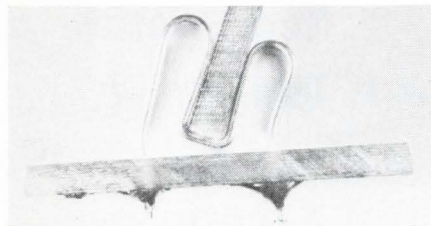

Type MC-1-55 Digi-Klip® is a heat-tempered, BeCu edgeboard connector that provides interconnection of "daughter" to mother board at a 55° angle. It accepts 0.062 in. pc board. Typical contact resistance is 3 Ω. Insertion/withdrawal life is 1000 cycles. Under 2¢ ea. in quan. Components Corp., Main St., Denville, N.J. 07834.

Circle Reader Service #284

FLAME-RETARDANT NYLON

Critical safety standards now required in TV and radio sets, business machines and electronic equipment can be satisfied with a new, flame-retardant nylon. Designated M340-FR, the new plastic has the top UL rating of Type I—as well as UL's SE-O classification. Monsanto Co., 800 N. Lindbergh Blvd., St. Louis, Mo. 63166.

Circle Reader Service #285

MINIATURE SCANNER



Miniature phototransistor with incandescent light source detects variations in light intensity from the surface being scanned. It reads marks as small as 3 mils at 75 mils distance. Will resolve 10 marks/in. at a velocity of 3000 ips. Accu-sort Systems, Inc., 601 Lawn Ave., Sellersville, Pa. 18960.

Circle Reader Service #286

FET OP AMP

The FA530 features 0.5 μs settling time to 0.01% in either inverting or non-inverting modes. It has a 20,000 CMRR. \$36.00 ea. Intronic, 57 Chapel St., Newton, Mass. 02158.

Circle Reader Service #287

LOW PASS FILTER

Model 2632 passes 2-32 MHz with loss under 0.5 dB and 1.5 (max.) vswr. Rejection is 100 dB, 80-1000 MHz. Rated at 100 W. Microwave Filter Co., Inc., 135 W. Manlius St., East Syracuse, N.Y. 13057.

Circle Reader Service #288

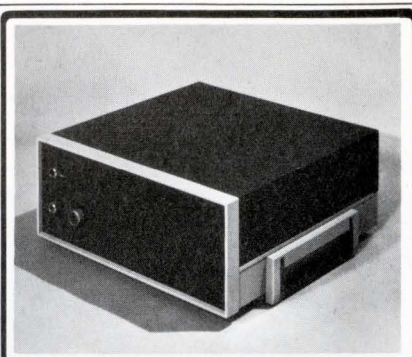

**CHASSIS AND CASE
IN ONE
HIGHLY FUNCTIONAL
UNIT**

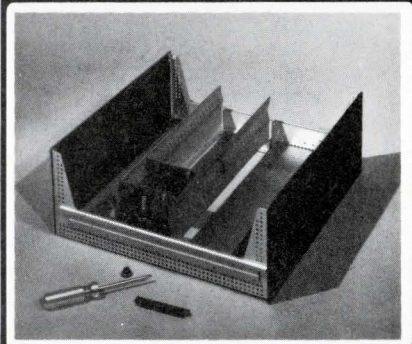

OPTIMA 17

OPTIMA 17 is designed around a lightweight chassis which can be removed in less than 60 seconds. Simply remove four screws and the chassis slips right out the back. Just the ticket for prototype assembly, and gives unexcelled access to your standard products.

You save on chassis layout and fabrication and your case remains factory fresh! OPTIMA 17 is available in four sizes and three configurations.

All OPTIMA cases, consoles, and racks are delivered painted and completely assembled.

Please write or call for our free, illustrated catalog.

Optima
enclosures

2166 Mountain Industrial Blvd.
Tucker, Georgia, 30084
Telephone 404-939-6340
A division of Scientific-Atlanta, Inc.

Circle Reader Service #39

MEET ONE OF THE FAMILY

NETWORKS

- TC to 1 ppm/°C.
- Tracking to 1/2 ppm/°C.



Resistor network for op-amp inputs

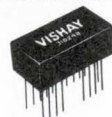

Standard network configurations to 16 bits



Vishay has a resistor product that will exceed your performance specs . . . Send for your free application Bulletin G-11.

VISHAY RESISTOR PRODUCTS
63 LINCOLN HIGHWAY ■ MALVERN, PENNSYLVANIA 19355

Circle Reader Service #38

NEW PRODUCTS

IC SOCKETS

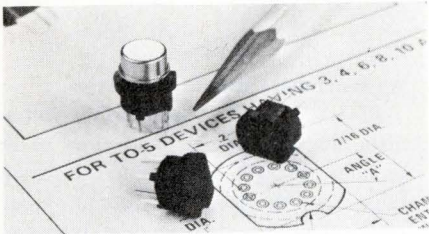

New series of 12 IC sockets accepts "TO" devices with up to four leads on a 0.100 in. pin circle, and up to 12 leads on a 0.200 in. pin circle. Series 131-55 sockets come in three different styles. Barnes Div., Bunker Ramo Corp., 24 N. Lansdowne Ave., Lansdowne, Pa. 19050.

Circle Reader Service #289

CONVERSION SLIDE RULE

Plastic ASTM slide rule converts customary to SI units in accordance with ASTM Standard E 380—the ASTM Metric Practice Guide. American Society for Testing and Materials, 1916 Race St., Phila., Pa. 19103.

Circle Reader Service #290

24 PIN DIP SOCKETS

Available in both solderless wrap or solder-in types, these sockets have replaceable contacts. The contacts accept 0.008-0.023 round or flat leads with a contact resistance of 8-10 mΩ \$1.00-\$2.00. Scanbe Mfg. Corp., 3445 Fletcher Ave., El Monte, Calif. 91731.

Circle Reader Service #291

COMPONENT PLATFORMS

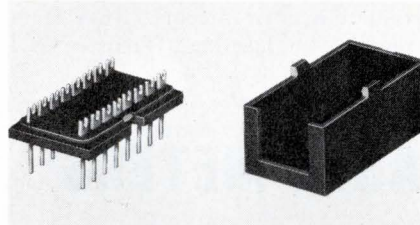

These platforms are for mounting discrete components and constructing electronic circuits. Available in 14 and 16-pin DIPs, they have snap-on covers available in five heights. Component Mfg. Service, Inc., 1 Component Park, West Bridgewater, Mass. 02379.

Circle Reader Service #292

12-V READ-OUT TUBES

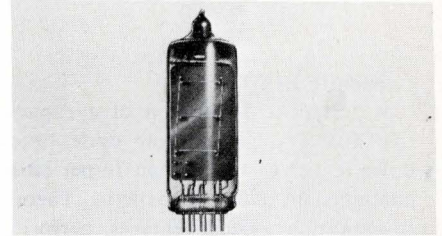

Here is a series of 12-V subminiature read-out tubes for mobile and portable equipment. They provide 10,000 ft.L of brightness at 30 mA/segment with a life expectancy of 10,000 h. Nu-Metrics, div. of Pentron Industries, Box 489, Vanderbilt, Pa. 15486.

Circle Reader Service #293

OPTICAL COATING

Chromafuse™ optical coating for back-lit electronic display panels eliminates hot spots, chromatic halo, and enhances legend colors without materially reducing the light transmission. Panel-graphic Corp., 10 Henderson Dr., West Caldwell, N.J. 07006.

Circle Reader Service #294

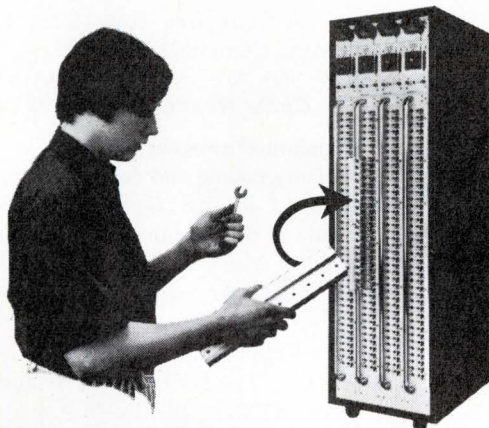

Power Burn-In System with Heat Sinks interchangeable to any case style in 30 minutes!

- ✓ Demountable heat sink bars hold constant temperature for Burn-Ins, HTRB, Life Testing, Product Evaluation.
- ✓ Versatile System never becomes obsolete.
- ✓ Complete System or Modules available.

Write or call for Standard Burn-In Literature.

WAKEFIELD ENGINEERING, INC.

Systems Div. Wakefield, Mass. 01880 • Phone: 617-245-5900

Circle Reader Service #40

THE ELECTRONIC ENGINEER • Dec. 1971

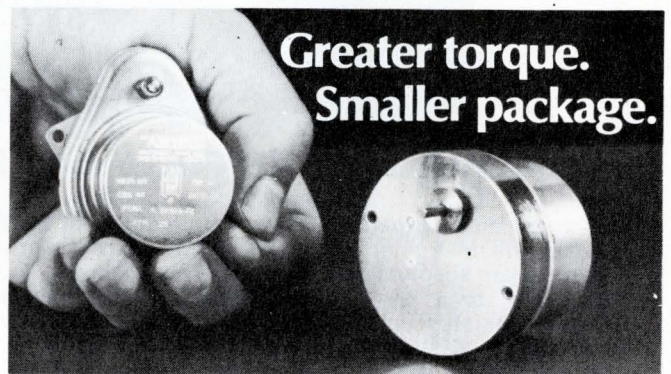

Compact...reversible...synchronous. These low-cost motors are real workhorses.

When your constant speed applications call for high torque, low power or reversibility, consider these miniature permanent magnet synchronous motors. They not only conserve space but they'll save you money. Low rotor speeds and permanently lubricated bearings assure quiet operation and extended life, as well.

Torque at the rotor shaft is .75 oz-in. @ 300 rpm for the 81300 series (in the hand). Input power is 1.5 watts nominal. Gearing gives a choice of 92 different speed combinations to 1/360 rpm.

Series 81400 gives you 2 oz-in. @ 300 rpm at the rotor shaft. Input power is 3 watts nominal. Gear trains available to lower output speed to 1 rpm.

Send for information now!

THE A. W. HAYDON COMPANY



232 North Elm Street, Waterbury, Conn. 06720 Tel. (203) 756-4481 TWX: 710-477-3141
In Europe: Polymotor International - Brussels 1, Belgium

Circle Reader Service #42

LITERATURE

Capacitive ROM

A technical description of a capacitive ROM system featuring cycle times down to 125 ns at less than 2c per bit is contained in a 6-page bulletin. Theory of operation, system features, performance characteristics with a typical timing sequence, and various system configurations are provided. Integrated Memories Inc., 260 Fordham Rd., Wilmington, Mass. 01887.

Circle Reader Service #382

Radiation effects

Application Note ICAN-6604 describes radiation effects on COS/MOS devices. The 16-pager contains abstracts of the results of three reports on the subject. The note is intended as a guide in the design of COS/MOS circuits into systems that will be exposed to various radiation environments. RCA Commercial Engineering, Harrison, N.J. 07029.

Circle Reader Service #383

MURA/HIOKI PANEL METERS

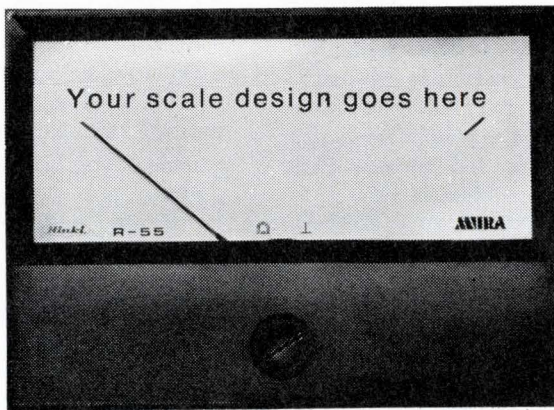

TOP QUALITY AND FULLY GUARANTEED

Made by Hioki, Japan's leading manufacturer of quality panel meters, these fine instruments can be used wherever precision measurement is an absolute requirement. They come in various sizes from 2" x 2½" to 6" x 4½" with either d'Arsonval or taut-band movements. Resistances and scale designs can be tailored to your special needs. Distributed in the United States only by Mura Corp., they are attractively priced and fully guaranteed. Sold only in O.E.M. quantities of 300 and up.

MURA 50 SOUTH SERVICE ROAD, JERICHO, N.Y. 11753
Telephone: (516) 334-2700 Telex: 967-879

Mura is the world's largest supplier of miniature panel meters.
Circle Reader Service #43

MEET ONE OF THE FAMILY

IN-PLANT FACILITY

- Make resistors to $\pm 0.01\%$.
- Make resistors with $\pm 1 \text{ ppm}/^\circ\text{C TC}$.



Select resistor chip, adjust to exact value, coat with silicone and encapsulate.

Vishay has a resistor product that will exceed your performance specs... Send for your free application Bulletin G-11.



VISHAY RESISTOR PRODUCTS
63 LINCOLN HIGHWAY ■ MALVERN, PENNSYLVANIA 19355

Circle Reader Service #44

A (sometimes) grim fairy tale

ICC V.P. Sang Whang brings you an ultra-modern fable on the ethics of interconnection. He cleverly tells how you (alias "the subjects"), the common carriers (alias "the independent manufacturers"), and the FCC Common Carrier Bureau (alias "the regulatory council") are subtly stifled by "the only company in the land that had the right to provide



electric power to the subjects." It really is a fairy tale, with many not-so-subtle pokes and digs at AT&T. And, of course, there's a moral to it all. To find out if everybody lives happily ever after, ask for your free copy from International Communications Corp., 7620 N.W. 36th Ave., Miami, Fla. 33147.

Circle Reader Service #384

Thumbwheel switches

Binary coding and decoding types are included in this 4-page booklet on standard and miniature thumbwheel switches. You'll also find single, double, and four-pole switching, as well as specs, circuit diagrams, truth tables, and selection guides for all. A. W. Haydon Co., 232 N. Elm St., Waterbury, Conn. 06720.

Circle Reader Service #385

Microprogramming guide

Third-generation computer architecture and the advantages and method of implementing microprogramming are outlined in this 25-page guide. And it gives thorough coverage to microprogrammed system data flow. It discusses alterable core ROMs with a detailed cost/performance curve analysis, and explains the development of a microprogram in a typical central processor. And last but not least, computer software aides are outlined. Datapac Inc., 18872 Redhill Ave., Santa Ana, Calif. 92707.

Circle Reader Service #386

Amplifier applications

Here's thorough data on the use of 12.5-V transistors in an amplifier that is capable of withstanding an all-phase infinite V_{SWR} at maximum power output. The 15-page application note also gives you detailed performance characteristics, schematics, and a parts list. TRW Semiconductors, 14520 Aviation Blvd., Lawndale, Calif. 90291.

Circle Reader Service #387

Rf connectors

The 66 pages of this catalog are packed with everything you need to know about rf connectors. It details adaptors, cable connectors, and receptacles. It discusses applications, accessories, and design. Plus, it provides specs, selection guides, and construction data. You even get assembly and mounting instructions. Pictures and diagrams are endless! Everything's here, and it's brought to you by Sealectro Corp., Rf Components Div., Mamaroneck, N.Y. 10543.

Circle Reader Service #388

Logic handbook

You'll want to add this to your collection of outstanding handbooks from DEC. This one will make you an expert in implementing electronic logic designs for instrumentation, computer interface, data gathering, and control. By the time

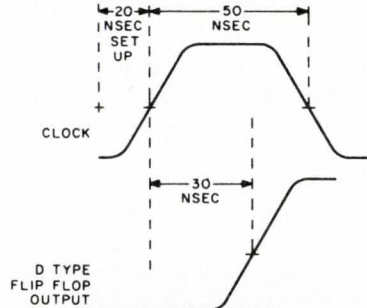

D type flip-flop timing

you've finished its 362 pages, you'll have found everything you need for putting your designs into action, from connector blocks to mounting cabinets. Don't miss this one. It's from Digital Equipment Corp., 146 Main St., Maynard, Mass. 01754.

Circle Reader Service #389

Multilayer PC boards

Solid post multilayer circuitry for critical applications is used in the production of these PC boards. A 4-page data sheet describes the process with design parameters, detailed specs, and circuit design information. Honeywell Information Systems, 26 Coromar Dr., Santa Barbara Research Park, Goleta, Calif. 93017.

Circle Reader Service #390

Micro 1600/21 minicomputer

This little bulletin gives you the big facts on the organization, standard features, special CPU features, instruction repertoire, input/output operations, and systems elements and options of the new Micro 1600/21 minicomputer. Briefly, the new mini features micro-programmed architecture, an efficient input/output system, and an instruction set with 107 different operations. This bulletin will fill you in on the rest. Microdata Corp., 644 E. Young St., Santa Ana, Calif. 92705.

Circle Reader Service #391

Pylon

TEST FIXTURES



Pylon introduces a fixed-point Probing System for probing ceramic dual in-line packages before lead frames are attached to the package. Pylon also manufactures Probing Systems for thin film circuits, thick film circuits, single-sided and multi-layer printed circuit boards and wire-wrapped back planes.

**Pylon Company, Inc., Attleboro, Mass. 02703
57 Newcomb Street — Tel. (617) 222-3726**

Circle Reader Service #45

Monitor events-track time -conserve space!



Mini events or time indicators for important billing or maintenance functions.

Although they measure only $\frac{3}{4}$ " square x $\frac{1}{4}$ " long, these precision indicators have a clearly visible 4-digit readout. They're easy to see, yet occupy only a minimum of space. They're non-resettable and tamper-proof — the perfect way to monitor elapsed time or events in peripherals, business machines, production machinery or similar electrical/electronic equipment.

The *Elapsed Time Indicator* is furnished with either front or side readout, for surface or through-panel mounting. Available for 50 or 60 Hz operation.

The *Events Counter* comes with the flange-type mount only. Count rate is 1200 cpm. It can be supplied for DC or 50, 60 or 400 Hz operation at various voltages. Power consumption is 2.5 watts nominal.

Send for information now!

THE A. W. HAYDON COMPANY

NORTH AMERICAN PHILIPS
A COMPANY

232 North Elm Street, Waterbury, Conn. 06720 Tel. (203) 756-4481 TWX: 710-477-3141
In Europe: Polymotor International - Brussels 1, Belgium

Circle Reader Service #46

Correed handbook

This 60-page handbook and applications manual has everything you need for the selection of correed assemblies and their proper application. It discusses reed switch development, design, basic correed types, how to use cor-

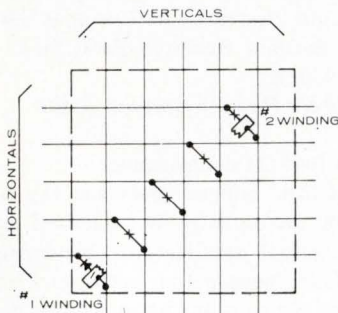

Crosspoint matrix

reeds, testing, switching circuits, and technical and dimensional data. You'll find it an excellent guide to dry reed switching and you can get it by writing on company letterhead to Automatic Electric, Northlake, Ill. 60164.

Instruments catalog

Here's a big (256-page), juicy catalog of gear that spans the frequency spectrum from dc to microwaves. The equipment sections detail the manufacturer's complete lines of signal sources, timing generators and clocks, power supplies, voltage standards, test gear, spectrum analyzers and curve tracers, electromagnets, waveguide components and microwave subsystems, computers and test systems, and printers. Most sections begin with an explanation of the fundamentals of the type of measurement typified by the instruments in that section. This 1971/72 instruments catalog is a useful addition to anyone's catalog file. Systron-Donner Corp., One Systron Dr., Concord, Calif. 94520.

Circle Reader Service #392

Computer data

One of these two new booklets discusses remote terminal configuration and summarizes the functional characteristics, speeds, and prices of the COPE batch terminal series. It includes data on card reading and punching speeds, printing capabilities, and optional peripherals such as dual printers, extended core memory units, and magnetic/paper tape drives. The other gives you a convincing argument on the use of remote computerized text processing; provides many typical applications as successful examples; and briefs you on all the available output options. University Computing Co., 1500 UCC Tower, Box 6228, Dallas, Tex. 75222.

Circle Reader Service #393

Transistor handbook

The updated version of this popular transistor catalog serves as a complete reference guide for all discrete devices manufactured by National. You'll find that schematics, graphs, and charts give you complete design data for each de-

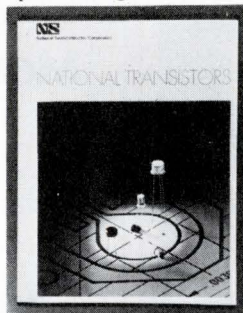

vice type and process. Pro-electron, npn and pnp small signal transistors, and FETs are covered. You'll even find application data within its 130 pages. National Semiconductor Corp., 2900 Semiconductor Dr., Santa Clara, Calif. 95051.

Circle Reader Service #394

IC catalog

Here's an updated version of Cam-bion's IC catalog. They've added 40 pages of information on IC accessories and wire wrapping products and services to their data on high density IC sockets, circuit boards, breadboards, card files, power planes and logic cards. Cambridge Thermionic Corp., 445 Concord Ave., Cambridge, Mass. 02138.

Circle Reader Service #395

Planar triode applications

All aspects of planar triode application are discussed in this 8-page note. There's information on tube mounting, contact surfaces, cooling, heater voltage, and accessories. And helpful graphs and diagrams supplement the text. Eimac Div. of Varian, 1678 S. Pioneer Rd., Salt Lake City, Utah 84104.

Circle Reader Service #396

Reed switch and keyboard components

From the dreed relay to the push-button switch to the plastic key tops—all the data you need is here in these 40 pages. And there's information on operate speed and bounce, contact noise, and shielding, as well as complete specs for each component. The single and dual function key top systems are explained, and you're given a keyboard diagram so you can set up your own. All this data is provided by Hathaway Components Div., 5250 E. Evans Ave., Denver, Colo. 80222.

Circle Reader Service #397

Stepper motor handbook

Permanent magnet stepper motors are the subject of this 28-page manual giving you complete data on selection, design, and application. It discusses basic principles, motor characteristics,

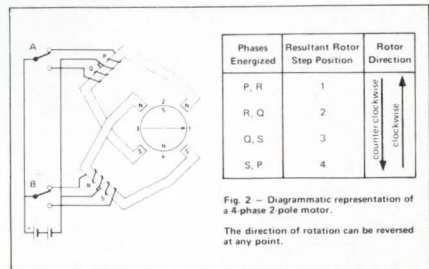

drive circuits, four and eight-phase construction, and accessories. Plus, it's packed with informative diagrams and graphs. A. W. Haydon Co., 232 N. Elm St., Waterbury, Conn. 06720.

Circle Reader Service #398

MEET ONE OF THE FAMILY

PRECISION RESISTORS

- Temperature Coefficients to 1 ppm/°C.
- Tolerances to ±0.001%.



S102 Series
Stability to
25 ppm/yr.



HP202 Series
Stability to
5 ppm/yr.



Vishay has a resistor product that will exceed your performance specs... Send for your free application Bulletin G-11.

VISHAY RESISTOR PRODUCTS

63 LINCOLN HIGHWAY ■ MALVERN, PENNSYLVANIA 19355

Circle Reader Service #47

Data modem

Questions and answers about Paradyne's new data modem are contained in a short form brochure. The unit provides a throughput of 4800 bits/s, accomplished by an advanced error control system. It is intended for direct replacement of conventional modems. Paradyne Corp., Box 5144, 2040 Calumet St., Clearwater, Fla. 33518.

Circle Reader Service #399

IC product guide

A comprehensive 48-page product guide covers RCA's line of linear and digital ICs. The literature provides quick reference application charts, device features, definitive data, schematics, and block and logic diagrams. As an extra added attraction an op amp selection chart gives salient static and dynamic characteristics and special device features for RCA's op amp line. RCA Commercial Engineering, Harrison, N.J. 07029.

Circle Reader Service #400

Keyboard wall chart

This keyboard selection guide is a handy wall chart that summarizes essential data on keyboards for you. It's sponsored by Micro Switch and compiled by the editors of *The Electronic Engineer* (you saw it in our September issue). It gives you explanations of common terms (such as encoding, shift/modes, strobe, repeat, interlock, error detection, and key array), reference graphs of the USASCII and the EBCDIC codes, a keyboard illustration and diagrams of keyboard switches, and a useful checklist for keyboards.

Circle Reader Service #405

Designer's guide to multilayer boards

If multilayer boards turn you on, here's a "pinup" you'll want to have. It's a wall chart sponsored by Lockheed Electronics and compiled by the editors of *The Electronic Engineer* and *Electronic Component News*. The amount of information it covers is impressive—conductors, conductor plating, layout tolerances and dimensions, hole location, laminates, laminating, designer's spec guide, general specs for multilayer design, voltage between conductors, and more. Be sure to get your free copy.

Circle Reader Service #406

A guide to high value capacitors

Another wall chart from *The Electronic Engineer*, you'll find this one, sponsored by General Electric, as useful as the rest. First there's a general discussion about capacitors (aluminum electrolytics, tantalum electrolytics, film, paper, and metallized film) and then a comparison of these types. There's also data on capacitors for ICs; capacitance, tolerance, and temperature; specs and standards; and important factors to remember when you make your selections. For an extra copy of this capacitor guide

Circle Reader Service #407

Power supplies

Precision dc power supplies and power supply module systems are the subject of an 8-page short form catalog. Designated C671, the bulletin includes salient features, physical characteristics, prices, and a list of options and accessories. Trygon Electronics, 1200 Shames Dr., Westbury, N.Y. 11590.

Circle Reader Service #401

Semiconductors

Here's another comprehensive catalog from GE. It starts off with an index of suggested GE replacements and goes on to give you necessary specs for each of their devices. By the time you've reached the end of its 76 pages, you'll have reviewed complete specs for transistors, amplifiers, switches, diodes, rectifiers, and triacs, as well as selection guides, circuit assemblies, and package outlines. General Electric, Semiconductor Products Dept., Electronics Park, Syracuse, N.Y. 13201.

Circle Reader Service #402

Sound advice

... is a 14-page booklet that teaches you how to become an instant noise expert. Sound waves, loudness measurement and calculations, octave band levels, sound power, and noise addition are all covered in common engineering terms so you can understand the principles of sound and its characteristics. The charts and curves are most helpful, and there's even a list of references should you decide to go deeper into the subject. Sperry Rand Corp., Vickers Div., Troy, Mich. 48084.

Circle Reader Service #403

Data module applications

Data modules are a new idea in data input and programming techniques. The module is a miniature coding device equivalent to a 1 x 4 matrix board or a hexi-decimal thumbwheel switch. In this brochure you'll read about installation techniques, output code selections, programming keys, programming concepts and applications. Interswitch, 770 Airport Blvd., Burlingame, Calif. 94010.

Circle Reader Service #404

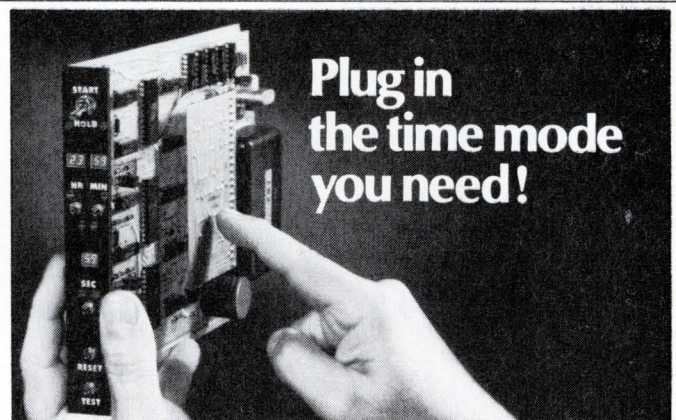

New Time Code Generator has LED display ... plus simple convertibility of time format.

No other time code generator/display unit can match the built-in features and values packed into this compact plug-in module. For example: you can select a plug-in submodule for either IRIG Format A or IRIG Format B time output; you get high-visibility time display in 00-23 hours, minutes and seconds provided by light emitting diodes (LED's); and, you get front-mounted Start/Hold/Set/Reset/Test switching functions to let you make full use of all the built-in capabilities.

Designed for 5 VDC operation, this new space-saving unit is ideal for computer and computer peripheral applications.

Send for information now!

THE A. W. HAYDON COMPANY

NORTH AMERICAN PHILIPS

232 North Elm Street, Waterbury, Conn. 06720 Tel. (203) 756-4481 TWX: 710-477-3141
In Europe: Polymotor International - Brussels 1, Belgium

Circle Reader Service #48

SAMPLES

THE ELECTRONIC ENGINEER

Dual-in-line socket

This offer brings you samples of an 8-lead dual-in-line socket whose body is moulded in glass-filled nylon. Two contact materials are available, both withstanding up to 10,000 insertions. Typical contact resistance is 5 or 15 m Ω , depending on the contact material you choose. Jermyn, 712 Montgomery St., San Francisco, Calif. 94111.

Circle Reader Service #408

Miniature hardware guide

Here's a catalog in slide rule form that reads out complete specs for more than 1300 sizes of micro-eyelets, micro-rivets, micro-washers, and micro-nuts. There are many sizes and finishes to choose from, and the guide gives you all dimensions for each. You'll find them ideal for your "micro" applications. Circon Corp., Santa Barbara Airport, Goleta, Calif. 93017.

Circle Reader Service #409

Washers and spacers

In this sample assortment you'll get washers and spacers made of various metallic and non-metallic materials in sizes ranging from 0.086 in. to 1.935 in. (outside diameter) and thicknesses from 0.004 to 0.15 in. A 48-page stock die list is included with the samples. Boker's Inc., 3104 Snelling Ave. S., Minneapolis, Minn. 55406.

Circle Reader Service #410

Emergency lighting calculator

Here's a pocket-sized emergency lighting calculator that gives you a lightguard emergency lighting system selector and data on wiring distance for voltage drop protection. The system selector compares voltage ratings with the

lightguard units needed to meet a specific lamp watt load. The other determines wire gauge necessary to prevent voltage drop. ESB Inc., Rising Sun & Adams Aves., Philadelphia, Pa. 19120.

Circle Reader Service #411

Display aid

Here's a unique idea from Sperry Information Displays Div. It's an actual size, printed version of the Sperry SP-730 series display. You simply peel off the back and press it on new equipment design mock-ups and other pre-production applications. The orange and black, 16-digit strips can easily be cut apart for your individual display requirements. Sperry Information Displays Div., Box 3579, Scottsdale, Ariz. 85257.

Circle Reader Service #412

Teflon laminations

Along with this literature you receive swatched samples of these proprietary laminations. Included are T-18, teflon laminated to a heavy layer of pressure sensitized vinyl; TF-12, teflon laminated to pressure sensitized foil for high temperature applications; and "lamalok," teflon fused to metal. Lamart Corp., 16 Richmond St., Clifton, N.J. 07015.

Circle Reader Service #413

Shrinkdown tubings

Samples of these shrinkdown tubings will show you their capabilities with insulating lugs, connectors, resistors, and other small parts. There are vinyl shrinkdown tubings, irradiated polyolefin tubings (in various grades to meet Mil-I-23053 B/5), and high temperature tubing made of teflon to choose from. L. Frank Markel & Sons Inc., Norristown, Pa. 19404.

Circle Reader Service #414

DISTRICT SALES MANAGERS

EDWARD G. SHAUD
BALA-CYNWYD, (Pa.) 19004
One Decker Square
(Area Code 215) SHerwood 8-2000

JOSEPH DRUCKER
NEW YORK 10016-600 Third Ave.
(Area Code 212) OXford 7-3400

JOHN W. BERNHARDT
CHICAGO 60606-120 S. Riverside
Plaza
(Area Code 312) 782-1400

G. T. ALFANO
NEEDHAM HEIGHTS, MASS. 02194-
570 Hillside Ave.
(Area Code 617) 444-0010

TERRENCE D. BUCKLEY
THOMAS R. BORIS
LOS ANGELES 90020-3727 W.
Sixth St. # 202
(Area Code 213) DUnkirk 7-1271

RALPH PETERSEN
LOS ALTOS (San Francisco) 94022
199 First St., Room 335
(Area Code 415) 941-6655

RICHARD DUTE
CLEVELAND 44114-601 Rockwell Ave.
(Area Code 216) SUperior 1-2860

NEWTON B. COLLINSON
ATLANTA 30309-1776 Peachtree St.
N.W.
(Area Code 404) 872-4723

MILES G. THORNTON, JR.
DALLAS 75206-Meadows Bldg.
Expressway at Milton
(Area Code 214) EMerson 3-6426

HAROLD E. MOTT
R. DENT SHILLINGLAW
Houston 77027
4151 Southwest Freeway
Suite 735
(Area Code 713) 621-7550

INTERNATIONAL BUSINESS OFFICES

London, SW1Y 6PB Max F. Holsinger
67-68 Jermyn St., St. James's Dir. European Sales
01-839 6318-9 K. J. Hendry, S. K. Elliott
Cables WHIP, LONDON S. W. 1

Manchester M22 5RQ D. I. Goulden
Haletop, Wythenshawe Civic Centre 061-437 3293

4 Dusseldorf-Nord E. Hillerbrand
Eitelstrasse 32 R. Schomburg, H. Haibt
Dusseldorf 652031-2
Cables WHIP, DUSSELDORF

75 Paris 8e S. Brown-Joussard
70 rue de Ponthieu J.-C. Lamoine
Paris 359 65-77
Cables UIIP, PARIS 8E

Tokyo C. T. Sakaguchi
Room 814, Togin Bldg., Marunouchi
CPO Box No. 1572 Tel: 211-3506-3509
Cables CLARENCE SAKA TOKYO

BUSINESS STAFF

BERNARD M. GITTELMAN
Publisher
DENNIS J. PERKINS
Promotion Manager
LOUIS L. MARINES
Marketing Services Manager

K. A. MARTINI
B. A. TATUM
Advertising Production

WILLIAM HOWAT
Circulation Director
JOSEPH A. GALVAN
Circulation Manager

JOSEPH P. BABCOCK
Reader Service Manager
JOHN H. KOFRON
Chilton Research Services
C. R. WILHIDE
Washington Vice-President

MEET ONE OF THE FAMILY

DECADE BOXES

- $\pm 0.005\%$ accuracy AT THE TERMINALS.
- Stability to 5 ppm/yr.



Model 1301-1304
self contained



Models for
panel mounting



Vishay has a resistor product that will exceed your performance specs . . . Send for your free application Bulletin G-11.

VISHAY RESISTOR PRODUCTS

63 LINCOLN HIGHWAY ■ MALVERN, PENNSYLVANIA 19355

Circle Reader Service #49

Advertisers—December 1971

No liability is assumed for errors or omissions.
This Index is published for a convenience.

ACOPIAN CORP.IFC	Mort Barish Associates, Inc.
ALLEN-BRADLEY CO. 7	Hoffman-York, Inc.
AMP, INC.10, 11	Aitkin-Kynett Co., Inc.
BUCKBEE-MEARS CO. 5	Midland Assoc., Inc.
BUSSMANN MFG. DIV.,	McGraw-Edison Co.DC-16, DC-17
Henderson Adv. Co.	
CEA, A Div. of Berkleonics 16	Jansson Adv., Inc.
CERRY ELECTRICAL PRDTS. CORP.DC-20	Kolb/Tookey & Assoc., Inc.
DELTRON, INC. 73	The Larwin Agency
DIGITAL EQUIPMENT CORP.DC-15	Creamer, Trowbridge, Case & Basford, Inc.
EDMUND SCIENTIFIC CO. 74	Walter S. Chittick Co., Inc.
ELECTRONIC RESEARCH CO. 62	Miller Adv.
FAIRCHILD SEMICONDUCTOR8, 9	Carson/Roberts/Inc.
GARDNER-DENVER CO. 57	Buchen Adv., Inc.
GENERAL INSTRUMENT CORP./	Microelectronics Div.DC-7
Norman Allen Assoc., Inc.	
GUDEBROD BROS. SILK CO., INC. 65	Coastline Adv.
A. W. HAYDON CO.67, 69, 71	J. B. Rundle Adv.
HEWLETT-PACKARD 18	Lennen & Newell/Pacific
HEWLETT-PACKARD, SAN DIEGO 17	Phillips Ramsey Adv.
HUGHES AIRCRAFT CO. 16	Foote, Cone & Belding
INTERSTATE ELECTRONICS CORP. 30	Leland Oliver Co., Inc.
INTERSWITCH, INC.DC-21	Wm. J. Purdy Promotions, Inc.
KEPCO, INC. 4	Weiss Adv.

MC COY ELECTRONICS CO.IBC	Williams & Assoc.
MOTOROLA SEMICONDUCTOR	PRDTS., INC.22, 23, 29, DC-22, DC-23
E. B. Lane & Assoc., Inc.	
MURA CORP. 68	Kamery Assoc., Inc.
NATIONAL SEMICONDUCTOR19, 20, 21	Chiat/Day, Inc.
PYLON CO. 69	American Line-A-Graph Corp.
QUALIDYNE CORP.DC-4	Hal Lawrence, Inc.
RCA, Solid State Div.BC	Al Paul Lefton, Inc.
RADIO MATERIALS CO. 61	M. M. Fisher Assoc., Inc.
REPCO., INC. 64	Wilson, Haight & Welch, Inc.
SIGNAL GALAXIES 24	Larry Courtney Co.
SCIENTIFIC-ATLANTA, INC. 66	Now
SOLITRON DEVICES, INC. 59	Haselmire Pearson Adv., Inc.
SPERRY Information Displays Div. 1	N. A. Winter Adv.
TEKTRONIX, INC.DC-2, 15	Dawson, Inc.
THERMALLOY CO. 63	Phillips, Inc.
UNITRODE CORP. 13	Impact Adv., Inc.
VARFLEX CORP. 74	Barlow/Johnson, Inc.
VISHAY RESISTOR PRDTS.62, 64, 66, 68, 70, 72	The Larwin Agency
WAKEFIELD ENGINEERING, INC. 67	Robert Robotham Adv.
WESTERN DIGITAL CORP. 2	Creative Communications

No. 2 Killer of Power Supplies



Ripple Current in Filter Capacitors!

- More capacitance means higher ripple current rating.
- Higher ripple current rating means longer life!

Series LA Modular Power Supplies

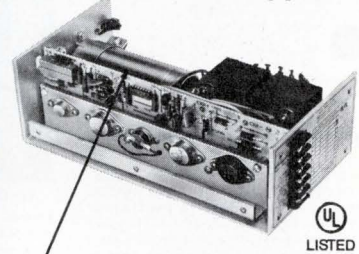

Twice as much capacitance than in leading competitive units. Check it! **PROOF POSITIVE** of **Deltron's Greater Reliability Thru**



Write for Free Technical Bulletin 30 "The Power Supply Killers," and learn how to select power supplies for longer life.

L-201
Deltron inc.
Wissahickon Ave.,
North Wales, Pa. 19454



Circle Reader Service #50

Field-effect transistors

Here's thorough information on several series of n-channel epitaxial planar silicon FETs. In addition to mechanical and electrical characteristics, there are frequency charts, dimensional diagrams, and graphs illustrating temperature variation, common drain-source, and input characteristics. A. S. Akers Electronics, 3191 Horten, Norway.

Circle Reader Service #415

Electronic telephone exchange

Called the PRX-205, this telephone exchange system is comprised of a fully electronic control unit and switching network. It may be used for any line-switching function at terminal exchanges or designated centers in public telephone networks, or as a large PABX or a Telex exchange. Thorough data on the switching network, control circuits, and setting up a connection are available from N. V. Philips Telecommunicatie Industrie, Box 32, Hilversum, The Netherlands.

Circle Reader Service #416

Line printer for minicomputers

A medium-speed line printer designed for minicomputer systems provides printouts (up to five copies) at the speed of 300 lpm in 128 columns. Column options are available, as are drum character set options. And it accepts PC board modules for control electronics and interface. Tokyo Electron Labs Inc., Meiho Bldg., 22 Nishi Shinjuku 1-chome, Shinjuku-ku, Tokyo, Japan.

Circle Reader Service #417

Bipolar random access memory

Here is a 1024-bit bipolar RAM with a 50-ns access time, a single 5-V supply rail, and both inputs and outputs that are DTL/TTL compatible. The memory includes full decoding facilities, eight sense amplifiers on a single chip, plus it features a standby dissipation of 5 uW/b and an access dissipation of 300 uW/b. Ferranti Ltd., Fields New Rd., Chadderton, Oldham, Lancashire, England.

Circle Reader Service #418

Data keyboard switches

You'll find these pushbutton switches with reed contacts ideal for your standard and terraced keyboard applications. With all the latest features for accuracy, low operating force action, and stability, you also get a choice of style, mounting (direct wire or PC board), and colors. Pye TMC, 15 Sheffield St., Toronto, Canada.

Circle Reader Service #419

Video display terminal

A 2000-character video display terminal is available with a full range of interfaces that offer software compatibility with such computers as the IBM 360 and 370, and the Burroughs 3500. Comprehensive editing facilities enable off-line editing before transmission to the computer. Other major features include split-screen operation, blinking fields, and remote cursor addressing. EMI Electronics Ltd., Hayes, Middlesex, England.

Circle Reader Service #420

SAVE TIME · CUT COSTS · UP QUALITY CONTROL HARD-TO-FIND INDUSTRIAL BUYS MANY U.S. GOVERNMENT SURPLUS BARGAINS IN SCIENCE, OPTICS, SPACE

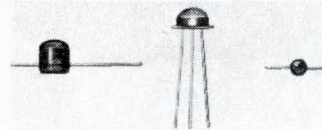

NEW LIGHT-EMITTING-DIODE KIT

Bargain kit ideal for economical experimenting with amazing LED's, the tiny solid state monochromatic lamps that use low voltage DC, last up to 1MM hrs. Used in card-tape readers, character recognition, hi-speed detectors, all kinds of electro-optical applications. Kit incl 3 LED's: gallium arsenide (MLED 600, MV 50, MLED 930); 2 visible red emitting (6600 A.); 1 infra-red emitting (9000 A.); 6 resistors; 1' 20mm plastic fibre optic light pipe; instrs.

Stock No. 41,597EE.....\$5.95 Ppd.

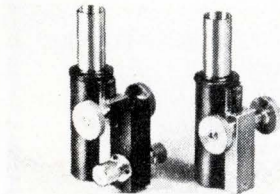

MICROSCOPE FOCUSING TUBE

Rare find! Most flexible, adaptable body avail for specialized mounting. Precision brass helical rack & steel pinion focusing. Accepts all standard 917" eyepieces—adaptable to full Edmund line, variety of scientific devices. Built to Int'l. Stds for scope optics. Flat brass 1 x 3" base easily drilled or tapped for mounting. Coarse & Fine focusing—3mm fine focusing travel. 160mm (6 1/4") x 81mm (3-3/16") x 78mm (3-1/16").

Stock No. 71,525EE.....\$61.50 Ppd.
No. 71,524EE.. (Coarse only)....\$39.95 Ppd.

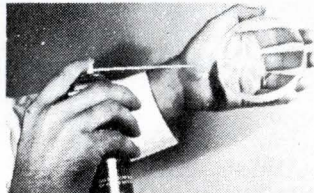

WHOOSH DUST OFF OPTICS, NEGS.

Fastest, easiest, safest way to remove dust and lint from optics, negatives, slides; any hard-to-reach area. Saves hours of brushing, cleaning, spotting to get rid of microscopic dust. Patented solid propellant Fluorogel 8 oz aerosol gives 2,500 jet sprays of moisture-free vapor. Dry air! Works in any position, even upside down! Handy 5" extension snorkle gets to it, wherever. It's like having a pinpoint portable 70-lb pressure compressor. Instrs.

Stock No. 60,902EE.....\$2.85 Ppd.

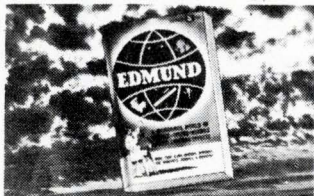

GIANT FREE CATALOG

Completely new 1972 edition—148 pages. Bargains galore! New categories, items, illustrations. 1,000's of buys for industry—Optics, Ecological and Physical Sciences, Electronics. On-the-Job helps, quality control aids. Optics for research labs, design engineers, experimenters. Instruments for checking, measuring, improve quality, cut costs. Hard-to-get surplus bargains. Write for catalog EE.

Varglas silicone rubber sleeving stays this flexible from -70° to 400° F.

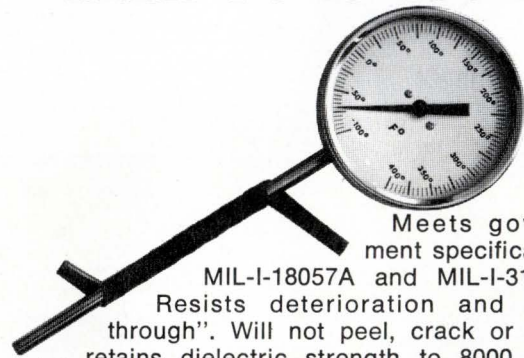

Meets government specifications MIL-I-18057A and MIL-I-3190/6. Resists deterioration and "cut-through". Will not peel, crack or craze. . . . retains dielectric strength to 8000 volts. Fungus-resistant and flame-retardant, its tough, thin-wall construction and precision ID make it ideal for miniaturized designs. Brilliant, non-fading colors for instant coding. Choose from .010" to 3" ID, coils, spools, or 36" lengths. Delivery off-the-shelf or on order within one week.

Send for this and other free samples. Write:

Vargflex

Vargflex Corporation
506 W. Court Street, Rome, N.Y. 13440.
Circle Reader Service #52

THE ELECTRONIC ENGINEER • Dec. 1971
Circle Reader Service #53 →

EDMUND SCIENTIFIC CO. 300 EDSCORP BLDG.
BARRINGTON, NEW JERSEY 08007
ORDER BY STOCK NUMBER • OPEN ACCOUNT TO RATED FIRMS • MONEY-BACK GUARANTEE

Circle Reader Service #51

Let's make it crystal clear.

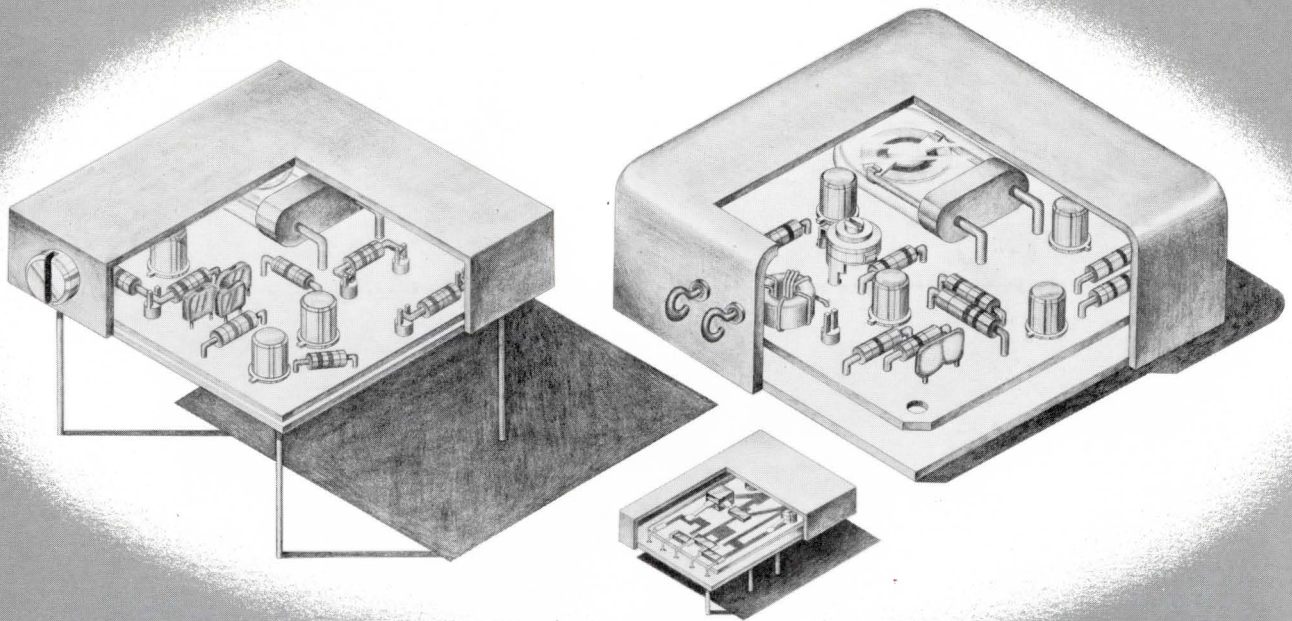

In precision oscillators, that is. Look at the inside story of all M^CCoy performance-rated oscillators. Quality craftsmanship and specialized technology provides you with a wide variety of custom designs with varying form factors. You may require extremely tight frequency stabilities, low aging rates, exceedingly difficult shock and vibration requirements, tightly controlled pull ranges and monotonic slopes with exacting tolerances. These are the parameters M^CCoy precision oscillators must meet from custom design stage through quality controlled manufacturing processes. Check our inside story with these specifications, then check your requirements and call your M^CCoy Representative or write to: M^CCoy Electronics Company, Mt. Holly Springs, Pa., 17065.

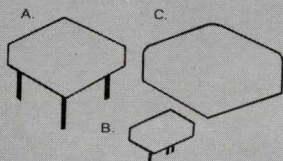

A.
MODEL MC163X2 Temperature Compensated Crystal Oscillator

Frequency Range: 8.0 KHz to 28.0 MHz
Frequency Tolerance and Temperature Range
 ±0.5 PPM -30° to + 60°C
 ±1.0 PPM -40° to + 70°C
 ±5.0 PPM -55° to + 105°C

Input Voltage: + 12 VDC ±2% and + 5 VDC ±5%
Output: Square Wave Compatible with TTL or DTL Logic

Outside Trim: Available on Request
Package Size: 2" X 2" X .525" High
Mounting: 5 ea., .030" Dia. Wire Leads for PC Board Mounting
Seal: Hermetic

B.
MODEL MC1000A1 Standard Crystal Oscillator

Frequency Range: 188 KHz to 50 MHz
Frequency Tolerance and Temperature Range
 ±50 PPM over -55° to + 105°C
 ±50 PPM over -40° to + 85°C
 ±50 PPM over 0° to + 75°C

Input Voltage: + 5VDC ± 5%
Output: Square Wave Compatible with TTL or DTL Logic

Package Volume: .196 Cubic Inches
Package Size: 1.190" X .715" X .230" High Max.
Mounting: Printed Circuit Board or Direct Plug in to a Dual In-Line Socket
Seal: Hermetic

C.
MODEL MC133X7 Temperature Compensated Voltage Controlled Crystal Oscillator

Frequency Range: 5 KHz to 75 MHz
Total Deviation: Up to 0.1% (1000PPM)
Temp. Stability: To ± 10 PPM over -40 to + 70°C or

Total Deviation: Up to 60 PPM
Temp. Stability: ± 1 PPM over 0 to + 80°C

Input Voltage: + 15VDC ± 1% at typically 25 MA
Output: 1 MW Min.
Deviation Linearity: Better than 5%
Deviation Rate: Up to 20 KHz

mccoy

ELECTRONICS COMPANY
 a subsidiary of OAK ELECTRO/NETICS CORPORATION

MT. HOLLY SPRINGS, PENNSYLVANIA 17065 • TELEPHONE: 717-486-3411 • TWX: 510-650-3548

"ADVANCING CRYSTAL TECHNOLOGY FOR TWO DECADES"

Make your move to RCA's new "Hometaxial II" line-up to find exactly how much transistor you need

2N6261 $V_{CEO}(\text{Max.}) = 80 \text{ V}$ $h_{FE} = 25-100$ @ $I_C = 1.5 \text{ A}$	2N3054 $V_{CEO}(\text{Max.}) = 55 \text{ V}$ $h_{FE} = 25-100$ @ $I_C = 0.5 \text{ A}$	2N6250 $V_{CEO}(\text{Max.}) = 40 \text{ V}$ $h_{FE} = 20-100$ @ $I_C = 1.5 \text{ A}$
2N6254 $V_{CEO}(\text{Max.}) = 80 \text{ V}$ $h_{FE} = 20-70$ @ $I_C = 5 \text{ A}$	2N3055 $V_{CEO}(\text{Max.}) = 60 \text{ V}$ $h_{FE} = 20-70$ @ $I_C = 4 \text{ A}$	2N6253 $V_{CEO}(\text{Max.}) = 45 \text{ V}$ $h_{FE} = 20-70$ @ $I_C = 3 \text{ A}$
2N6258 $V_{CEO}(\text{Max.}) = 80 \text{ V}$ $h_{FE} = 20-60$ @ $I_C = 15 \text{ A}$	2N3772 $V_{CEO}(\text{Max.}) = 60 \text{ V}$ $h_{FE} = 15-60$ @ $I_C = 10 \text{ A}$	2N6257 $V_{CEO}(\text{Max.}) = 40 \text{ V}$ $h_{FE} = 15-75$ @ $I_C = 8 \text{ A}$
2N6264 $V_{CEO}(\text{Max.}) = 150 \text{ V}$ $h_{FE} = 20-60$ @ $I_C = 1 \text{ A}$	2N3441 $V_{CEO}(\text{Max.}) = 140 \text{ V}$ $h_{FE} = 25-100$ @ $I_C = 0.5 \text{ A}$	2N6263 $V_{CEO}(\text{Max.}) = 120 \text{ V}$ $h_{FE} = 20-100$ @ $I_C = 0.5 \text{ A}$
2N6262 $V_{CEO}(\text{Max.}) = 150 \text{ V}$ $h_{FE} = 20-70$ @ $I_C = 3 \text{ A}$	2N3442 $V_{CEO}(\text{Max.}) = 140 \text{ V}$ $h_{FE} = 20-70$ @ $I_C = 3 \text{ A}$	2N4347 $V_{CEO}(\text{Max.}) = 120 \text{ V}$ $h_{FE} = 15-60$ @ $I_C = 2 \text{ A}$
2N6259 $V_{CEO}(\text{Max.}) = 150 \text{ V}$ $h_{FE} = 15-60$ @ $I_C = 8 \text{ A}$	2N3773 $V_{CEO}(\text{Max.}) = 140 \text{ V}$ $h_{FE} = 15-60$ @ $I_C = 8 \text{ A}$	2N4348 $V_{CEO}(\text{Max.}) = 120 \text{ V}$ $h_{FE} = 15-60$ @ $I_C = 5 \text{ A}$

RCA now introduces "Hometaxial II", a second-generation line-up of silicon power transistors that will change your design thinking—with new heights in current, voltage, and dissipation ratings. Pick your device and price. Already workhorses of the industry, Hometaxial-base silicon devices measure up to their specifications—reliably. That's because Hometaxial-base means freedom from second breakdown!

Check the chart for exactly which—and how much—transistor you need. Then call RCA. See your local RCA Representative for more information. For technical data on specific types, write: RCA Solid State Division, Section 59L UTL25, Box 3200, Somerville, N.J. 08876. International: RCA, Sunbury-on-Thames, U.K., or P.O. Box 112, Hong Kong. In Canada: RCA Limited, Ste. Anne de Bellevue, 810 Quebec.

RCA Solid State
products that make products pay off

Circle Reader Service #54