

SCORPION

PRODUCT
DESCRIPTION

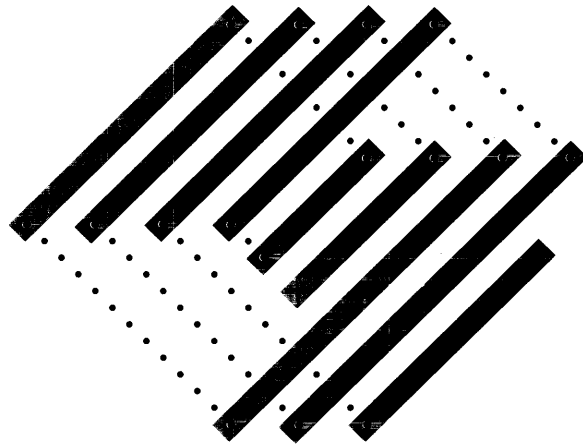

ARCHIVE

ARCHIVE CORPORATION

SCORPIONTM

1/4" Streaming Tape Drive
PRODUCT DESCRIPTION

Part Number 20271-001

March 1984

The Archive Corporation reserves the right to update or make changes in tape drive products and specifications as recorded in this manual without prior notice to prospective users.

SCORPION is a Trade Mark of the Archive Corporation.

Copyright© 1984 Archive Corporation

Table of Contents

	Page
Section 1 Introduction	
1.1 General.....	1-1
1.2 Description	1-1
1.3 Performance Specification Summary	1-1
Section 2 Scorpion Tape Drive Features	
2.1 General.....	2-1
2.2 Space-Saving Separate Assemblies Option.....	2-1
2.3 High-Capacity/Low-Cost Media.....	2-1
2.4 High Data Transfer Rate	2-1
2.5 Multifunction Capability.....	2-1
2.6 Intelligent Control.....	2-2
2.7 Standard Intelligent Interface	2-2
2.8 Data Integrity	2-2
2.9 Advanced Technology.....	2-2
Section 3 Scorpion Basic Tape Drive Functional Characteristics	
3.1 General.....	3-1
3.2 Basic Tape Drive Description	3-1
3.3 Storage Media	3-2
3.3.1 Cartridge Loading	3-3
3.4 Scorpion Basic Tape Drive Characteristics	3-5
3.4.1 Basic Drive Selection	3-5
3.4.2 Basic Drive Head Assembly Positioning and Track Selection.....	3-5
3.4.3 Tape Positioning	3-6
3.4.4 Writing Data To Tape	3-7
3.4.5 Reading Data From Tape	3-7
3.4.6 Full Tape-width Erase.....	3-7
3.4.7 Output Interface Signals.....	3-7
Section 4 Scorpion Basic Tape Drive Interface (QIC-36)	
4.1 General.....	4-1
4.2 Interface Characteristics.....	4-1
4.3 Signal Lines From The Controller.....	4-2
4.3.1 Select (DS0 -)	4-2
4.3.2 Reset (RST -).....	4-2
4.3.3 Go (GO -)	4-2
4.3.4 Reverse (REV -).....	4-2
4.3.5 Track Select Bits (TR0 -, TR1 -, TR2 -, and TR3 -).....	4-2
4.3.6 Write Data + (WDA +) and Write Data - (WDA -).....	4-3
4.3.7 High Current (HC -)	4-3
4.3.8 Erase Enable (EEN -).....	4-3

4.3.9	Write Enable (WEN -)	4-3
4.3.10	High Speed (HS -)	4-3
4.3.11	Threshold (THD -)	4-3
4.4	Signal Lines From The Basic Tape Drive	4-3
4.4.1	Read Data Pulses (RDP -)	4-3
4.4.2	Upper Tape Hole (UTH -) and Lower Tape Hole (LTH -)	4-3
4.4.3	Drive Selected (SLD -)	4-4
4.4.4	Cartridge In (CIN -)	4-4
4.4.5	Write Protected (USF -)	4-4
4.4.6	Tachometer Pulses (TCH -)	4-4
4.5	Signal Terminations	4-4
4.6	Signal Loading	4-4
4.7	Interface Connector J1 Pin Assignments	4-5
4.8	Power Interface	4-5
4.8.1	Power Requirements	4-5
4.8.2	Power Connector Location and Pin Assignments	4-6

Section 5 Scorpion Intelligent Tape Drive Functional Characteristics

5.1	General	5-1
5.2	Description of Intelligent Tape Drive	5-1
5.3	Drive and Track Selection	5-1
5.4	Self Tests	5-2
5.5	Tape Motion	5-2
5.5.1	Serpentine Recording	5-2
5.5.2	Tape Positioning Operations	5-2
5.6	Data Storage and Recovery Methods	5-4
5.6.1	Recording and Encoding Technique	5-4
5.6.2	Data Format	5-4
5.6.3	Write Operations	5-5
5.6.3.1	Underruns	5-5
5.6.3.2	Write File Mark	5-5
5.6.3.3	Data Append	5-5
5.6.3.4	End of Media	5-5
5.6.4	Read Operations	5-5
5.6.4.1	Read After A File Mark	5-6
5.6.4.2	Read File Marks	5-6
5.6.4.3	Read Underruns	5-6
5.6.5	Error Detection and Recovery	5-6
5.6.5.1	Read-After-Write Error Recovery	5-6
5.6.5.2	Read Error Recovery	5-7
5.7	Status Information	5-7

Section 6 Scorpion Intelligent Tape Drive Interface (QIC-02)

6.1	General	6-1
6.2	Interface Characteristics	6-1
6.3	Control Lines From The Host	6-2

6.3.1	Request.....	6-2
6.3.2	On Line	6-2
6.3.3	Transfer	6-2
6.3.4	Reset.....	6-2
6.4	Control Lines From The Drive	6-2
6.4.1	Ready.....	6-2
6.4.2	Exception	6-2
6.4.3	Acknowledge.....	6-2
6.4.4	Direction.....	6-2
6.5	Bi-Directional Bus Lines.....	6-2
6.5.1	The Command Set.....	6-2
6.5.2	Select Commands	6-3
6.5.3	Motion Commands.....	6-3
6.5.4	Write Command.....	6-3
6.5.5	Write File Mark Command.....	6-3
6.5.6	Read Command	6-4
6.5.7	Read File Mark Command.....	6-4
6.5.8	Read Status Command	6-4
	6.5.8.1 Status Information.....	6-4
6.6	Interface Signal Timing.....	6-4
6.7	Host Connector Pin Assignments.....	6-14
6.8	Signal Terminations	6-15
6.9	Signal Loading	6-15
6.10	Power Interface	6-15
	6.10.1 Intelligent Tape Drive Power Specifications.....	6-15
	6.10.2 Power Connector Locations and Pin Assignments	6-15

Section 7 Maintenance and Reliability Goals

7.1	Preventative Maintenance.....	7-1
7.2	Field Maintenance and Special Tools	7-1
7.3	Spare Parts.....	7-1
7.4	Reliability Goals.....	7-1
	7.4.1 Service Life	7-1
	7.4.2 Mean Time Between Failures (MTBF).....	7-1
	7.4.3 Mean Time To Repair (MTTR)	7-1

Section 8 Physical Characteristics

8.1	Environmental Requirements.....	8-1
	8.1.1 Ambient Conditions	8-1
8.2	Physical Integration Data	8-1
	8.2.1 Physical Dimensions and Weight Of The Basic and Intelligent Scorpion	8-1
	8.2.2 Mounting Requirements	8-2

Appendix A Extended Format and Command Capabilities (QIC-24)

A.1	General.....	A-1
A.2	QIC-24 Format	A-1
A.3	Set Format (0010 011P).....	A-1

List of Tables

Table		Page
	Section 1 Introduction	
1.1	Performance Specification Summary	1-2
	Section 4 Scorpion Basic Tape Drive Interface (QIC-36)	
4.1	Code Combinations For Track Selection.....	4-2
4.2	Tape Hole Signal Output Code	4-3
4.3	Basic Tape Drive Interface Connector Pin J1 Assignments.....	4-5
4.4	Basic Tape Drive Power Requirements	4-6
4.5	Basic Tape Drive J2 Power Connector Pin Assignments	4-6
	Section 6 Scorpion Intelligent Tape Drive Interface (QIC-02)	
6.1	Command Summary	6-3
6.2	Host Connector J1 Pin Assignments	6-14
6.3	Intelligent Tape Drive Power Requirements	6-16
6.4	Power Connector Pin Assignments	6-17
	Section 8 Physical Characteristics	
8.1	Environmental Requirements.....	8-1
8.2	Basic Tape Drive Physical Dimensions and Weight	8-2
8.3	Intelligent Tape Drive Physical Dimensions and Weight	8-2

List of Illustrations

Figure		Page
Section 3 Scorpion Basic Tape Drive Functional Characteristics		
3.1	Scorpion Basic Tape Drive.....	3-1
3.2	Standard 1/4-inch Tape Cartridge	3-2
3.3	Internal Construction 1/4-inch Tape Cartridge	3-2
3.4	Cartridge Insertion	3-3
3.5	Slide Lever Operation	3-4
3.6	Protective Door.....	3-4
3.7	Write Protect Plug	3-4
3.8	Tape Drive Cartridge Loading Area.....	3.5
3.9	Head Positioning Mechanism	3.6
Section 4 Scorpion Basic Tape Drive Interface (QIC-36)		
4.1	Basic Tape Drive Interface	4-1
4.2	GO – and REV – Signals Timing Diagram	4-2
4.3	Basic Tape Drive Interface Connector J1	4-4
4.4	Basic Tape Drive Power Connector J2.....	4-6
Section 5 Scorpion Intelligent Tape Drive Functional Characteristics		
5.1	Full-High Intelligent Tape Drive	5-2
5.2	Half-High Basic Tape and SAC PWB.....	5-2
5.3	Serpentine Recording	5-3
5.4	Comparative Track Layout.....	5-4
5.5	Tape-position Holes DC 300XL and DC 600A 1/4-Inch Cartridge Tape.....	5-4
5.6	4-To-5 Run Length Limited Code	5-4
5.7	Archive QIC-11 1/4-Inch Streaming Tape Format	5-5
Section 6 Scorpion Intelligent Tape Drive Interface (QIC-02)		
6.1	QIC-02 Interface	6-1
6.2	Reset Timing Without POC Enable	6-5
6.3	Reset Timing With POC Enable	6.6
6.4	Read Status Command Timing Diagram.....	6-7
6.5	Select Command Timing Diagram.....	6-8
6.6	BOT, Retension or Erase Command Timing Diagram	6-9
6.7	Write Data Command Timing Diagram.....	6-10
6.8	Write File Mark Command Timing Diagram	6-11
6.9	Read Data Command Timing Diagram.....	6-12
6.10	Read File Mark Command Timing Diagram	6-13
6.11	Host Interface Connector J1.....	6-15
6.12	Intelligent Drive Power J2 Connector	6-17

	Page
Section 7 Maintenance Features and Reliability Goals	
7.1	Scorpion Spare Assemblies 7-2
Section 8 Physical Characteristics	
8.1	Horizontal Mounting Position 8-2
8.2	Vertical Mounting Position..... 8-2
8.3	Basic Tape Drive Outline Drawing..... 8-4
8.4	Intelligent Tape Drive Outline Drawing..... 8-5
8.5	Stand Alone Controller Outline Drawing 8-6
Appendix A Extended Format and Command Characteristics (QIC-24)	
A.1	QIC-24 1/4-inch Streaming Tape Format A-2
A.2	Location Of Jumpers CC and KK and LEDs DS1, DS2, DS3, DS4, and DS5 A-2

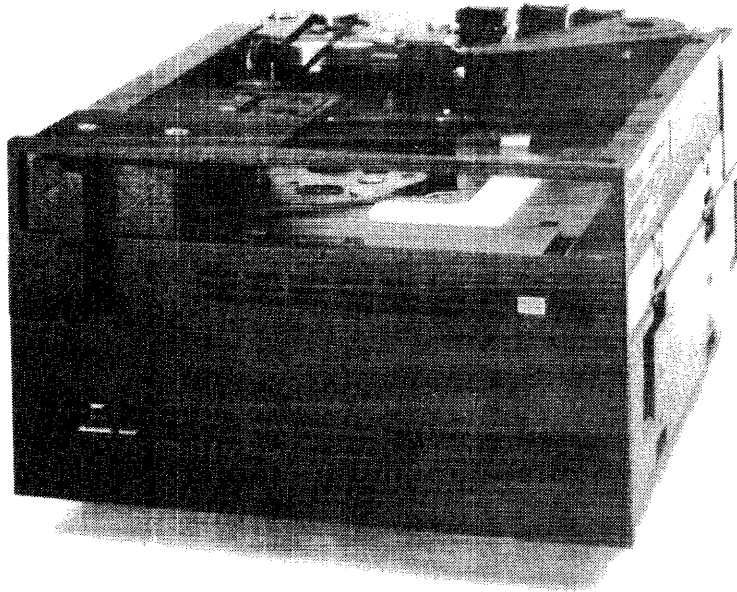

Scorpion Intelligent 1/4-inch Cartridge Streaming Tape Drive

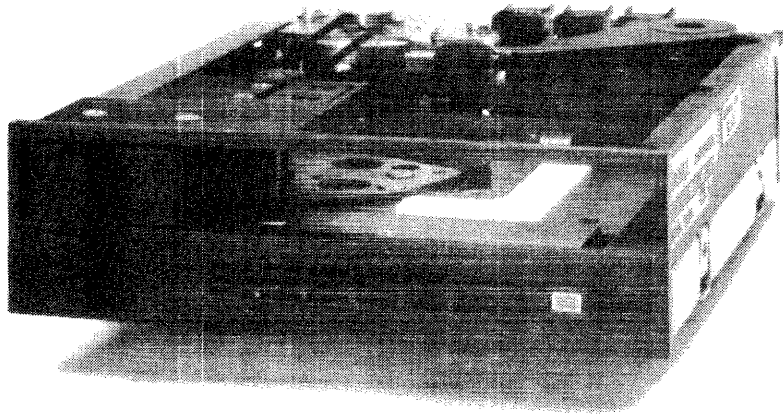

Scorpion Basic 1/4-inch Cartridge Streaming Tape Drive

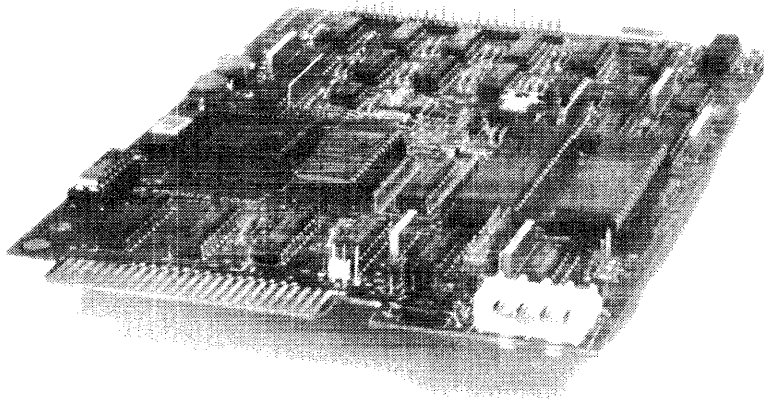

Scorpion Stand Alone Controller (SAC) PWB

SECTION 1

INTRODUCTION

1.1 GENERAL

This document provides a description of the Scorpion 1/4-inch streaming cartridge tape drive. Several versions of the Scorpion are available and the capabilities and features of each are explained.

1.2 DESCRIPTION

The Scorpion is a 1/4-inch streaming cartridge tape drive packaged in a 5 1/4-inch footprint which is fully compatible with the 5 1/4-inch floppy disk drive footprint. Its primary function is dependable and efficient backup for Winchester disk drives in the 10MB to 160MB+ range.

Three different configurations of the Scorpion are available to the designer and will be discussed in this document at length.

The Basic Scorpion is offered in a half-high package and contains the Basic electronics and

mechanics. The Intelligent version of the Scorpion is available in two options. The controller/formatter can be housed directly below the basic unit, making the total height equal to a standard full-height floppy disk drive or Winchester disk drive. The controller/formatter can also be mounted some distance from the half-high Basic unit providing additional space-saving advantages.

The exclusive LSI circuitry used extensively in the Scorpion electronics maximizes efficiency and reliability.

1.3 PERFORMANCE SPECIFICATION SUMMARY

Six models offered have a number of tape speeds, storage capacities and other advanced characteristics (Table 1.1) providing the optimum backup solution to the system designer and integrator.

Table 1.1 Performance Specification Summary

Model	5320L 5320C	5920L 5920C	5945L 5945C
No. of Tracks	4	4	9
No. of Channels*	2	2	2
Capacity DC 300XL	20 megabytes	20 megabytes	45 megabytes
Capacity DC 600A	26.7 megabytes	26.7 megabytes	60 megabytes
Backup Time DC 300XL	12 min.	4 min.	9 min.
Backup Time DC 600A	16 min.	5.2 min.	12 min.
Recording Mode	NRZI	NRZI	NRZI
Recording Data Density	8000 bpi	8000 bpi	8000 bpi
Encoding Method (Intelligent Scorpion)	4-to-5 RLL**	4-to-5 RLL	4-to-5 RLL
Flux Density	10,000 ftpi	10,000 ftpi	10,000 ftpi
Track Capacity DC 300XL	5.0 megabytes	5.0 megabytes	5.0 megabytes
Track Capacity DC 600A	6.6 megabytes	6.6 megabytes	6.6 megabytes
Data Transfer Rate	30 k bytes/sec	90 k bytes/sec	90 k bytes/sec
Tape Speed	30 ips	90 ips	90 ips
Start/Stop Time	100 ms	300 ms	300 ms

*Channel is defined as one write head gap followed by one read head gap.

**RLL is defined as "Run Length Limited"

C = Basic Scorpion tape drive

L = Intelligent Scorpion tape drive

SECTION 2

SCORPION TAPE DRIVE FEATURES

2.1 GENERAL

The Scorpion features are:

- Space-saving separate assemblies option (2.2)
- High-capacity/low-cost media (2.3)
- High data transfer rate (2.4)
- Multifunction capability (2.5)
- Intelligent control (2.6)
- Standard intelligent interface (2.7)
- Data integrity (2.8)
- Advanced technology (2.9)

2.2 SPACE-SAVING SEPARATE ASSEMBLIES OPTION

When space limitation and device placement are a consideration, the Intelligent Scorpion is available in two smaller major assemblies which can be mounted separately. These assemblies are the "Stand Alone Controller" (SAC) and the 1/2-high "Basic Tape Drive". By using these assemblies it is possible to mount the SAC away from the Basic drive a maximum distance of 3 meters (9 feet 10 inches). These assemblies are connected by a single 50 conductor ribbon cable. Operation of the Scorpion in this configuration is identical in function to the Intelligent unit described in this manual.

2.3 HIGH-CAPACITY/LOW-COST MEDIA

With the correct industry standard 1/4-inch tape cartridge loaded into the appropriate model Scorpion tape drive (see Table 1.1), 20, 45 or 60 megabytes of data can be stored in one 1/4-inch tape cartridge. The ability to store data in convenient, compact (4 inches x 6 inches x 11/16 inches) cartridges provides a means of ensuring the security of large amounts of data which could be lost due to an unexpected Winchester disk drive failure. Storage applications listed in paragraph 2.5 also use the large capacity attribute to advantage. Couple this with the minimal media insertions that are required to achieve total media backup and the 1/4-inch cartridge tape takes on vital importance in applications where data security and data backup convenience are priorities.

The 1/4-inch cartridge puts the Scorpion backup storage media in the category of low cost, providing high capacity data storage backup with a practical media cost.

2.4 HIGH DATA TRANSFER RATE

At 90 kilobytes per second the Scorpion Model 5920 backs up 20 megabytes in four minutes, the Model 5945 backs up 45 megabytes in nine minutes and 60 megabytes in twelve minutes. The Model 5320 performs at 30 kilobytes per second and therefore backs up 20 megabytes in approximately 12 minutes. A complete tabulation of data transfer rates and back up times is given in Table 1.1 for these examples and all other Scorpion tape

drive and tape cartridge combinations. All the models will accept 512 bytes of data at a Burst Data Transfer Rate of 200 kilobytes per second.

2.5 MULTIFUNCTION CAPABILITY

The primary role of the Scorpion is image backup, but the versatility of this streaming tape drive allows applications such as: software distribution, transaction logging, data collection, data exchange, and program loading.

2.6 INTELLIGENT CONTROL

The Scorpion Intelligent tape drive model communicates with the host over a byte wide path for both commands and data. It executes tape commands and data formatting without host intervention and automatically performs all data recovery operations.

2.7 STANDARD INTELLIGENT INTERFACE

Commands, status information, read/write data and control signals are transmitted to and from the Intelligent drive via the industry standard QIC*-02 REV D interface. The QIC-02 REV D interface has a total of 16 lines for communication between the host and the Intelligent Scorpion tape drive. Eight lines form an 8 bit bi-directional bus for commands, status and read/write data. The remaining eight lines are the control signal lines.

2.8 DATA INTEGRITY

For all Scorpion models the packaging of the media in cartridges eliminates the problems of dust, finger prints, and creases which can destroy data.

In all Scorpion models use of AC erase eliminates peak shift caused by biasing the media which

occurs during DC erase. This method allows recording at extremely high density. The brushless DC drive motor speed is tightly regulated by a digital servo system.

The Intelligent Scorpion uses recording techniques which ensure reliable data storage and recovery.

- A Cyclic Redundancy Check (CRC) is performed when writing information to tape or reading information from tape. A CRC error in the write mode will cause a block to be re-written until no CRC error occurs or until the limit of 16 consecutive same block re-writes occurs. A CRC error in the read mode will cause a read re-try until no CRC error occurs or the limit of 16 read re-tries have been made.
- A technique that ensures reliable data recovery is the use of a wide band phase-locked-loop which follows instantaneous speed variations. A 4-to-5 bit run-length limited coding technique is used to maintain precise synchronization of the data detection system.

2.9 ADVANCED TECHNOLOGY

Advanced features incorporated into the Scorpion tape drive product are:

- Increased reliability achieved through the use of state of the art LSI technology to decrease part count and power consumption.
- Self test diagnostics in the Intelligent model that ensure the operational readiness of the tape drive electronic systems. On reset or power up of the drive, a Power On Confidence (POC) check will be run only if the POC enable jumper clip is installed on the LSI Stand Alone Controller. Results of these tests will appear in an LED display.

*Working Group for Quarter Inch Cartridge compatibility

SECTION 3

SCORPION BASIC TAPE DRIVE FUNCTIONAL CHARACTERISTICS

3.1 GENERAL

This section contains the following information regarding the Scorpion Basic tape drive functional characteristics:

- A description of the Basic tape drive (3.2)
- A description of the storage media and the mechanics of loading and unloading the cartridge. (3.3)
- Scorpion Basic tape drive characteristics (3.4)

3.2 BASIC TAPE DRIVE DESCRIPTION

The Scorpion Basic tape drive (Figure 3.1) consists of a compact metal chassis on which are mounted the following assemblies: magnetic recording head assembly, capstan drive motor, tape hole sensors, cartridge in place sensing switch and safe sensing switch. The drive also contains mechanical devices to facilitate loading, positioning and unloading of the cartridge. The drive electronics are packaged on two printed circuit boards. The "Main" PWB is mounted below the cartridge loading area and the "Capstan Motor Driver" PWB is mounted behind the cartridge loading area.

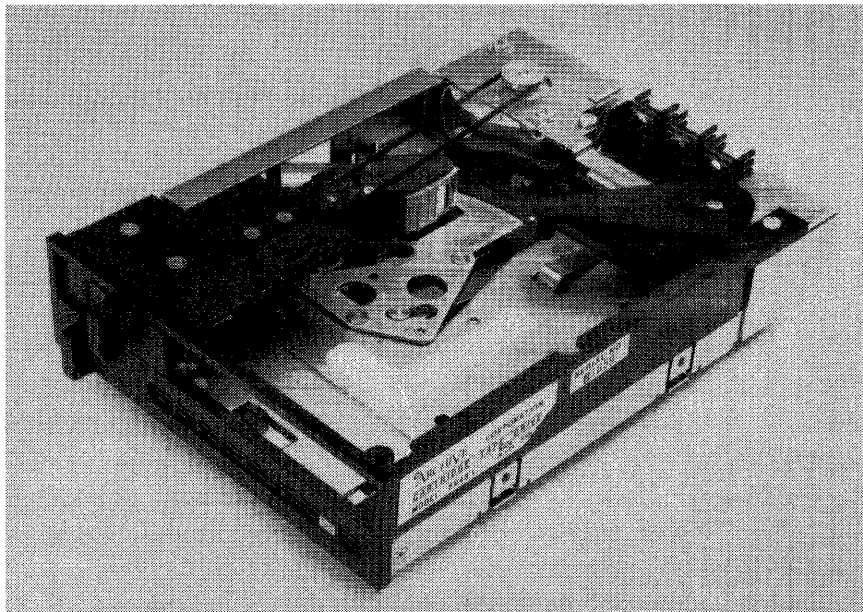

Figure 3.1 Scorpion Basic Tape Drive

3.3 STORAGE MEDIA

The Scorpion tape drives use the DC 300XL (450 feet of tape) or the DC 600A (600 feet of tape) 1/4-inch tape cartridge. Tape cartridges purchased through the Archive Corporation are qualified by the Archive Corporation to operate in Archive tape drive products. Figure 3.2 shows a picture of the standard 1/4-inch tape cartridge. Figure 3.3 is an illustration of the internal con-

struction of a 1/4-inch tape cartridge showing how it interfaces with the Scorpion tape drive.

Different write currents are required for the two cartridges due to the difference in oxide coating thickness and coercivity. The Model 5945L Intelligent drive determines the cartridge type by measuring the distance between the BOT and load point holes (3 feet for DC 300XL and 4 feet for DC 600A) and selects the appropriate write current for the cartridge which is inserted.

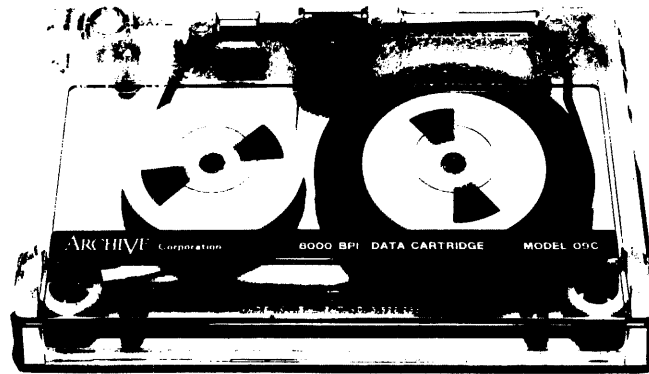

Figure 3.2 Standard 1/4-Inch Tape Cartridge

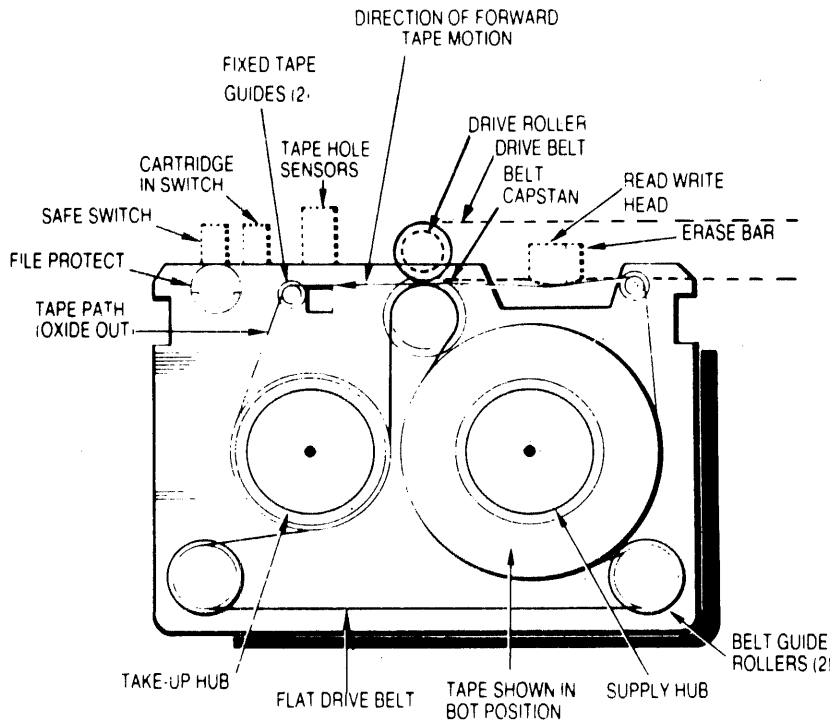

Figure 3.3 Internal Construction 1/4-Inch Tape Cartridge

3.3.1 Cartridge Loading

The cartridge is inserted through the loading aperture (Figure 3.4) so that the cartridge protective door is facing the slide lever side of the drive front panel and enters the drive first. The protective door then opens as the cartridge becomes fully inserted. The cartridge is inserted over a full-width lip and when fully inserted descends to be retained by the lip. The front slide lever is now moved toward the cartridge until it reaches the lever stop (Figure 3.5). This action will secure the cartridge and bring the head assembly to its correct operating position. Loading of the cartridge is now complete.

Cartridge loading involves both the cartridge mechanics and the drive mechanics.

In the cartridge:

- A protective door swings open as the cartridge is inserted. (Figure 3.6)
- A write protect plug (Figure 3.7) can be positioned as required to allow or inhibit writing on the tape in the cartridge inserted.

In the drive:

- Devices secure the cartridge against two planes of contact and align it against three points of reference as specified in ANSI standard 3.55-1982.
- A safe switch (Figure 3.8) is activated or not activated depending on the write protect plug orientation.
- A cartridge-in switch is activated when the cartridge is fully inserted and the slide lever is engaged (Figure 3.8).
- The action of the slide lever as it is moved toward the cartridge causes the head assembly to slide into place against the tape. (Figure 3.8)

The cartridge is unloaded by moving the slide lever on the front panel away from the cartridge until the slide lever stop is reached. The head assembly retracts, and a "cartridge ejector" device lifts the cartridge clear of the retaining lip. An "eject arm" will now push the tape cartridge out

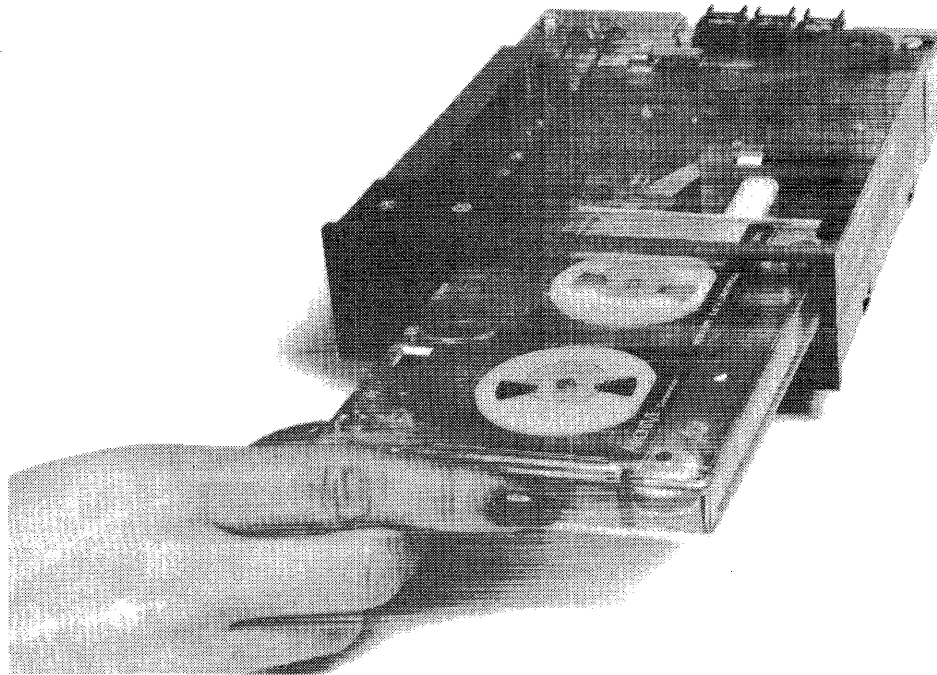

Figure 3.4 Cartridge Insertion

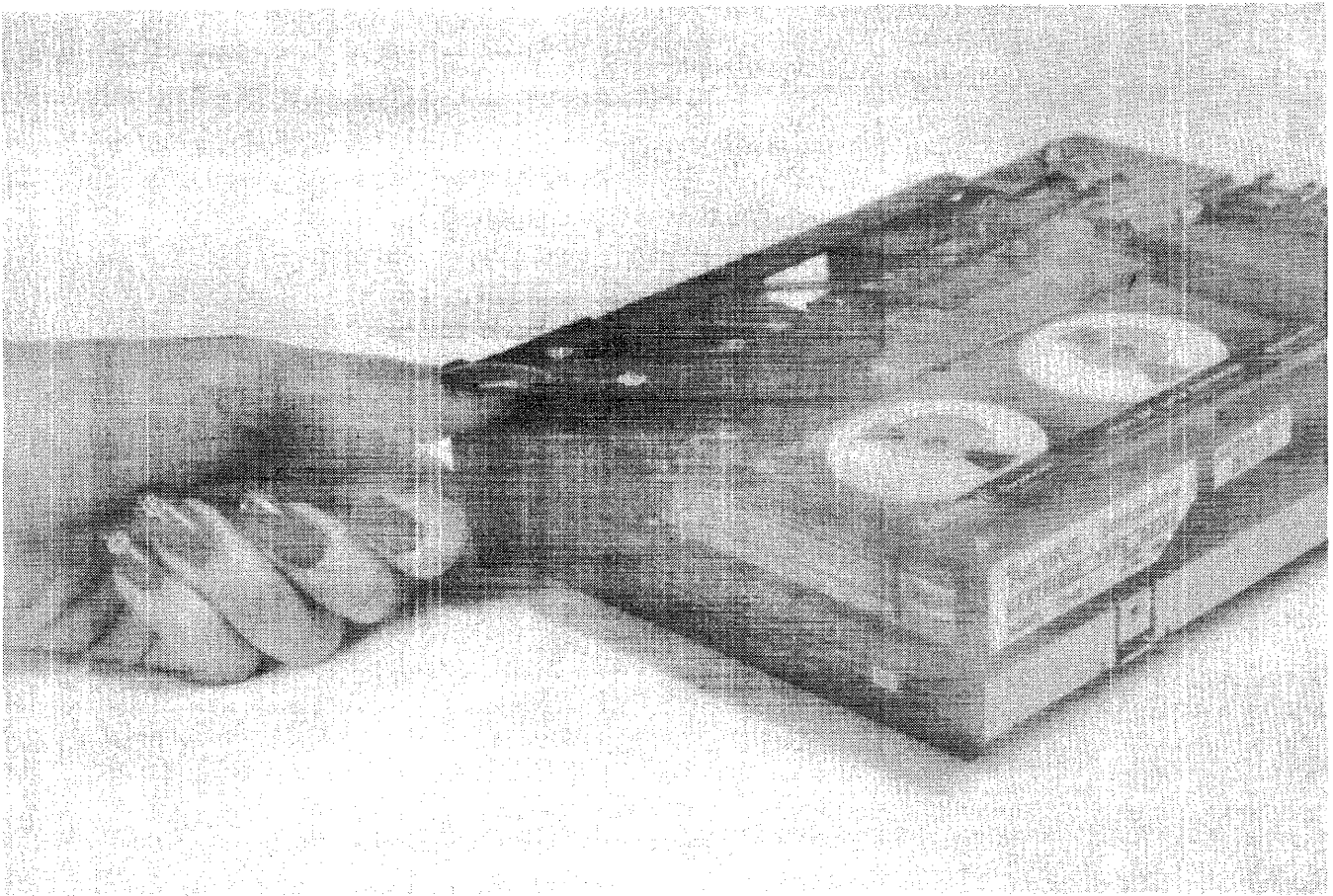

Figure 3.5 Slide Lever Operation

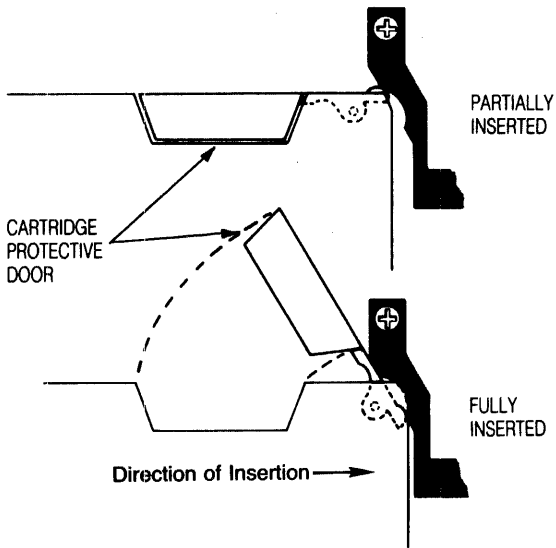

Figure 3.6 Protective Door

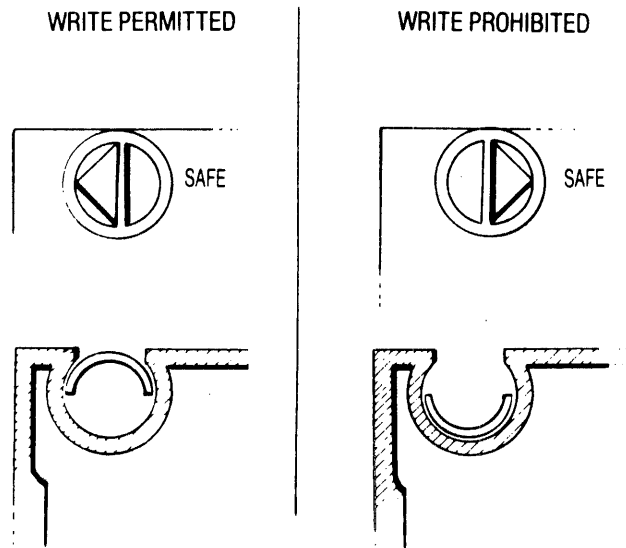

Figure 3.7 Write Protect Plug



Figure 3.8 Tape Drive Cartridge Loading Area

slowly so that a portion of the cartridge is extending beyond the front panel. This places the cartridge within easy grasp of the operator. The cartridge is completely unloaded by pulling it from the drive.

3.4 SCORPION BASIC TAPE DRIVE CHARACTERISTICS

It may be useful while reading part 3.4 to refer to section 4, "Scorpion Basic Tape Drive Interface." The Basic tape drive will perform functions such as:

- Basic Drive selection.
- Head assembly positioning for track selection.
- Tape positioning.
- Write data to tape.
- Read data from tape.
- A full tape-width erase.

- Generate needed output interface responses for use by the controller.

3.4.1 Basic Drive Selection

The Basic drive is selected by asserting the select (DS0-) input at the Basic drive interface. Application of the DS0- signal to the Basic drive enables the drive for use by the attached controller and turns on the LED activity lamp on the front panel.

3.4.2 Basic Tape Drive Head Assembly Positioning And Track Selection

A head positioning stepper motor and associated control circuit step the head assembly to a number of positions on the tape. This allows four track serial recording in the 20/26.7 megabyte drives and nine track serial recording in the 45/60 megabyte drive.

The head assembly has a lower and upper pair of heads. Each pair consists of a write head followed by a read head. A full width erase bar is shown on the right side of the head assembly (Figure 3.9).

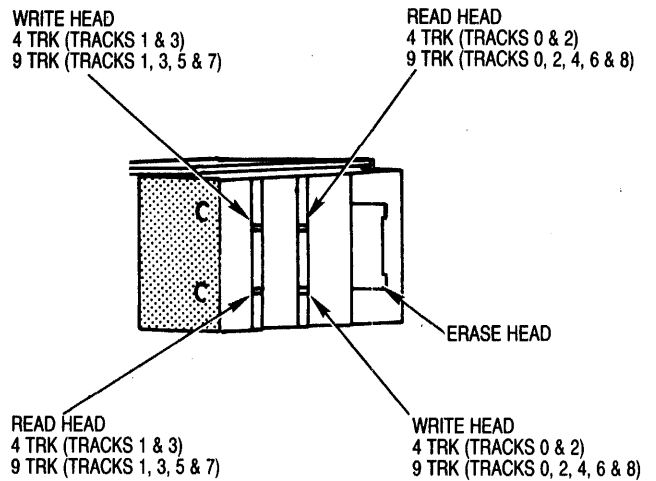
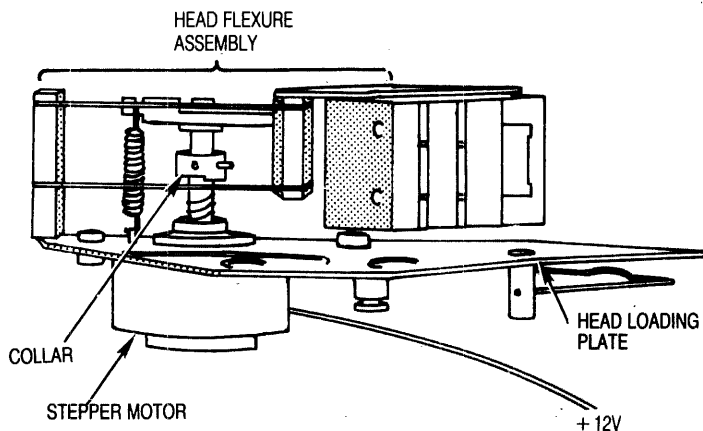

Figure 3.9 Head Positioning Mechanism

Track selection in the Basic drive is controlled by:

- Automatic repositioning of the head assembly to a reference position after tape drive reset.
- Using the state of the track select bits (TR0-, and TR1- in four track drives or TR0-, TR1-, TR2- and TR3- in the nine track drives) to direct Basic tape drive track selection electronics.

Precise positioning of the head assembly is essential to assure media interchangeability from one drive to another. At each power up or reset the head assembly is stepped to a reference surface (re-calibrate position) to make certain that the track alignment is accurate. Actual acquisition of the correct track under the proper read/write head pair is a combination of head assembly positioning and read/write head pair selection.

When reset the Basic drive will position the head assembly to the re-calibrate reference position. From this reference position the Basic drive is normally initialized to track 0 by the track select bits. The track select bits control head assembly positioning and selection of one of the two available read/write head pairs. The head assembly is

moved 96 steps from the reference position to the position for track 0. Upper or lower read/write head pair selection is determined by the state of TR0-. In selecting track 0, TR0- is not asserted, selecting the lower read/write head pair. Assertion of TR0- at this point will cause the upper read/write head pair, track one, to be selected. Any further track selection will move the head assembly a required number of steps calculated by the drive electronics and select the read/write head pair designated by track select bit TR0-.

3.4.3 Tape Positioning

Tape positioning in the Scorpion Basic tape drive is governed by input signals from the interface and signals generated internally by the Basic tape drive. The internal signals also appear at the output interface.

Input interface signals responsible for tape positioning include: select (DS0-), go (GO-), reverse (REV-), high speed (HS-) and track select bits TR0- and TR1- (4 track) or track select bits TR0-, TR1-, TR2-, and TR3- (9 track) as follows:

- No control signals will be responded to unless DS0- is asserted. Deassertion of DS0- causes a tape stop sequence to occur.

- Assertion of GO- causes a tape start sequence in the direction specified by the state of REV-. Changing the state of REV- while GO- is still asserted causes a stop sequence followed by a start sequence in the opposite direction.
- The high speed signal (HS-) is provided to give the 30 ips tape drives 90 ips speed in tape motion operations that do not require reading or writing.
- Changing track select bits one or above is permissible while GO- is still asserted. The change in track select bits causes a tape stop sequence followed by a track position sequence and a tape start sequence.

Internal signals which can affect tape positioning are cartridge in (CIN-), upper tape hole (UTH-), and lower tape hole (LTH-) as follows:

- Insertion of the tape cartridge causes CIN- to be asserted allowing tape motion functions to be performed. Removal of the tape cartridge causes CIN- to be de-asserted and a stop tape sequence results.
- Detection of LTH- and or UTH- in a code that represents BOT or EOT will cause a tape positioning routine as follows:
 1. Upon detection of the BOT code the drive will stop tape and if a start sequence in the forward direction (GO- asserted and REV- deasserted) has not since been commanded, the drive will move tape in the opposite direction until it detects the BOT code again after which it will stop tape. If however, a start sequence in the forward direction has been commanded a normal start sequence will occur.
 2. Upon detection of the EOT code the tape will stop and if GO- and REV- are not asserted the drive will move tape in the opposite direction until it again detects the EOT code after which it will stop tape. If however, GO- and REV- are asserted the drive will perform a start sequence in the reverse direction.

3.4.4 Writing Data To Tape

To write data to tape in the Scorpion Basic tape drive a number of conditions must be satisfied. The drive must be selected (DS0-) at the interface, write enable (WEN-) must be active and the cartridge write protect cam must be positioned to close the unsafe switch (USF-). Differential write data (WDA+ and WDA-) must be available at the input interface. A signal is supplied to the drive from the controller to cause a higher write current (HC-) if the 3M DC 600A tape cartridge is used.

3.4.5 Reading Data From Tape

The read circuit is always enabled. Data passing under the selected read head will be available at the interface as read data (RDP-).

3.4.6 Full Tape-Width Erase

A full tape-width erase of the tape that passes under the erase head is accomplished by applying erase enable (EEN-) and ensuring that TR0- is false (track zero selected) at the interface.

3.4.7 Output Interface Signals

Basic tape drive internal status information is communicated to the controller by the following signals:

- Upper tape hole (UTH-) and lower tape hole (LTH-) produce a coded output to the controller (Table 4.2 Tape Hole Signal Output code) which indicates the presence of BOT, WARNING or EOT holes.
- Drive selected (SLD-) when asserted indicates to the controller that the drive has been addressed by the controller (DS0-) and is ready to respond to commands.
- Cartridge in (CIN-) when asserted indicates to the controller that a cartridge has been loaded. If CIN- is deasserted the cartridge has been removed from the drive.

- Tachometer pulses (TCH-) indicate that the tape is in motion. Each pulse indicates the passing of a measure of tape depending on the tape drive motor type in use.
- The state of write protected (USF-) signal indicates the position of the tape cartridge

write protect plug and will allow or disallow write current in the Basic drive.

- Read Data (RDP-) is a serial stream of read data pulses, one data pulse for each transition read from tape.

SECTION 4

SCORPION BASIC TAPE DRIVE INTERFACE (QIC-36)

4.1 GENERAL

This section contains the following Basic tape drive interface information:

- General characteristics of the interface (4.2)
- A description of the signals from the controller (4.3)
- A description of the signals from the Basic tape drive (4.5)
- Signal Terminations in the Basic tape drive and termination requirements for the controller (4.6)
- Pin assignments for interface connector J1 (4.7)
- Power requirements, J2 power connector location and Pin assignments (4.8)

4.2 INTERFACE CHARACTERISTICS

There are 22 signal lines in use at the Scorpion Basic interface. Fifteen lines are used for signals that come from the controller and 7 are used for signals that originate at the Basic tape drive (Figure 4.1)

The Basic tape drive utilization of input signals to control internal operation and the generation of output signals is enabled upon the assertion of tape drive select (DS0-) from the controller (See Paragraph 4.3.1 Select)

The signals are sent on lines of a 50 pin cable which must not exceed 3 meters (9 feet 10 inches) in length.

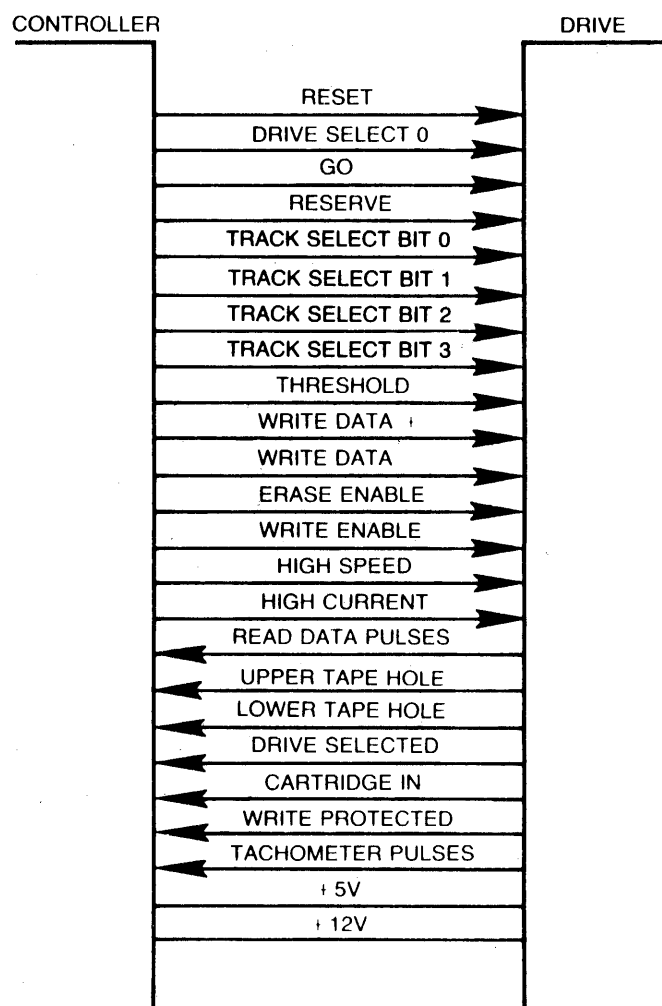

Figure 4.1 Basic Tape Drive Interface
(QIC-36)

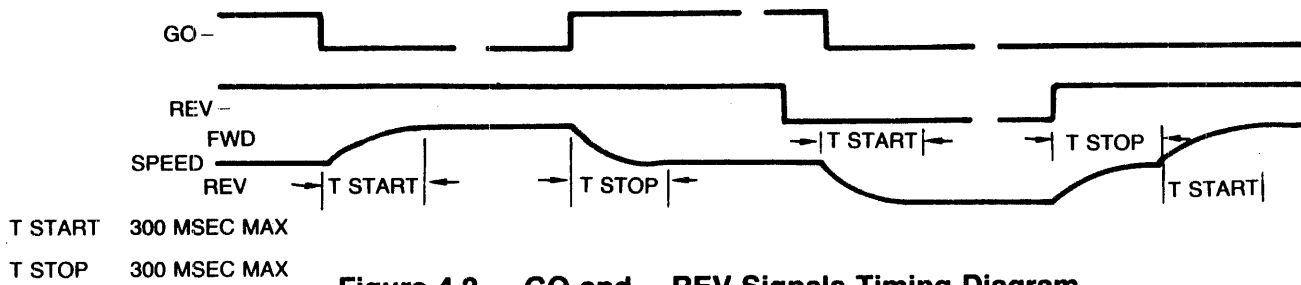

Figure 4.2 – GO and –REV Signals Timing Diagram

Standard TTL levels are used on signal lines to the controller as follows:

- FALSE, logic 0 (high) = 2.4 to 5.25 VDC
- TRUE, logic 1 (low) = 0 to 0.55 VDC

Standard TTL levels are required on signal lines to the drive as follows:

- FALSE, logic 0 (high) = 2.0 to 5.25 VDC
- TRUE, logic 1 (low) = 0 to 0.8 VDC

4.3 SIGNAL LINES FROM THE CONTROLLER

4.3.1 Drive Select (DS0–)

The assertion of DS0– will allow Basic tape drive operations under microcomputer control to proceed. Erase and write current will be permitted under interface control and the output interface signals to the controller will be enabled. The drive selected (SLD–) signal will be generated in the Basic drive and sent to the controller.

4.3.2 Reset (RST–)

Upon receiving a 70 microsecond or longer pulse on the RST– input signal line, the drive per-

forms a 3 second initialization routine and recalibration of the head assembly to the recalibrate reference position.

4.3.3 Go (GO–)

Assertion of GO– causes a start sequence in the direction specified by the state of REV–. Typical tape motion timing is shown in Figure 4.2.

4.3.4 Reverse (REV–)

Assertion of REV– will cause tape motion in the reverse direction if GO– is asserted. Deassertion of REV– will cause tape motion in the forward direction if or when GO– is asserted. See motion timing Figure 4.2.

4.3.5 Track Select Bits 0,1,2, and 3 (TR0–, TR1–, TR2–, and TR3–)

Track select bits TR0– and TR1– are used to select one track from tracks 0 thru 3 in four track drives.

Track select bits TR0–, TR1–, TR2– and TR3– are used to select one track from tracks 0 thru 8 in nine track drives. The code combinations necessary to select the required track are shown in Table 4.1.

Table 4.1 Code Combinations For Track Selection

Track Select Bit	Binary Input Code									
	Track 0	Track 1	Track 2	Track 3	Track 4	Track 5	Track 6	Track 7	Track 8	
(LSB) TR0–	0	1	0	1	0	1	0	1	0	
TR1–	0	0	1	1	0	0	1	1	0	
TR2–	0	0	0	0	1	1	1	1	0	
(MSB) TR3–	0	0	0	0	0	0	0	0	1	

4.3.6 Write Data+ (WDA+) and Write Data- (WDA-)

WDA+ and WDA- are differential signals sent to the basic interface at standard TTL voltage levels during the time WRITE ENABLE (WEN-) is asserted. The Basic tape drive read/write system is optimized to record data at a nominal density of 10,000 flux transitions per inch (ftpi).

4.3.7 High Current (HC-)

Higher current is used to write data to tape when HC- is asserted from the controller as a result of detecting the insertion of a DC 600A tape cartridge into the Basic tape drive.

4.3.8 Erase Enable (EEN-)

If EEN- is asserted and TR0- is false (track zero selected) the entire tape under the erase head will be erased.

4.3.9 Write Enable (WEN-)

The WEN- input must be asserted at the Basic drive interface for write data to be gated to the write head.

4.3.10 High Speed (HS-)

HS- is a signal provided to allow the 5320 Basic drive to move tape at 90 IPS when performing

tape motion operations which do not require reading or writing to tape such as: erase, rewind retention, and some repositioning routines. See "Intelligent Interface" Section 6.0 for an explanation of these operations.

4.3.11 Threshold (THD-)

When asserted, read threshold invokes a 35% qualifying amplitude threshold for the read signal off tape.

4.4 SIGNAL LINES FROM THE BASIC TAPE DRIVE

4.4.1 Read Data Pulses (RDP-)

Read data is sent to the controller in a serial stream from the interface. Since no read enable is required, RDP- will be present any time data passes under the read head.

4.4.2 Upper Tape Hole (UTH-) And Lower Tape Hole (LTH-)

The UTH- and LTH- are output to the controller indicating specific positions on the tape. The BOT, load point, early warning and EOT holes produce an output code as shown in Table 4.2 to inform the controller of the tape position.

Table 4.2 Tape Hole Signal Output Code

UTH	LTH	
1	1	Beginning of tape position – BOT holes nearest recording area just right of tape hole sensor
0	1	End of tape position – EOT hole nearest recording area just left of tape hole sensor
1	0	Warning zone – between BOT tape holes and load point hole or between early warning hole and EOT tape hole
0	0	Recording zone – between load point hole and early warning hole providing that a beginning of tape position or end of tape position has occurred since the last cartridge insertion (CIN), otherwise this code means "tape position unknown".

4.4.3 Drive Selected (SLD-)

SLD- is enabled as a true output to the controller when the input DS0- is true from the controller at the Basic drive interface.

4.4.4 Cartridge In (CIN-)

CIN- is generated when a tape cartridge is fully inserted actuating the cartridge-in switch. CIN- becomes false when the tape cartridge is removed.

4.4.5 Write Protected (USF-)

USF- is an output that informs the controller whether or not the Basic drive will allow data to be written to tape. Writing will not be allowed if USF- is asserted. If USF- is not asserted writing will be permitted. The factor that dictates the state of this output is the position of the write protect plug on the cartridge when the cartridge is inserted into the drive. See Figure 3.7 Write Protect Plug.

4.4.6 Tachometer Pulses (TCH-)

Tachometer pulses are generated for each revolution of the capstan motor. The pulses inform the controller when tape is moving and how far it has moved.

4.5 SIGNAL TERMINATIONS

The controller is required to terminate signal lines that originate at the Scorpion Basic tape drive and the Basic tape drive is required to terminate signal lines originating at the controller. Signal terminations at the controller and the tape drive require 220 ohms to +5VDC and 330 ohms to ground. The drive terminates all input signals except RST- using a sixteen pin dual inline resistor package at socket location U 11. RST- is terminated as specified by internal discrete resistors.

4.6 SIGNAL LOADING

Signals from the controller to the tape drive are loaded by no more than one terminator and 2 standard TTL loads. The controller shall not load the signals from the tape drive with more than one terminator and one standard TTL load.

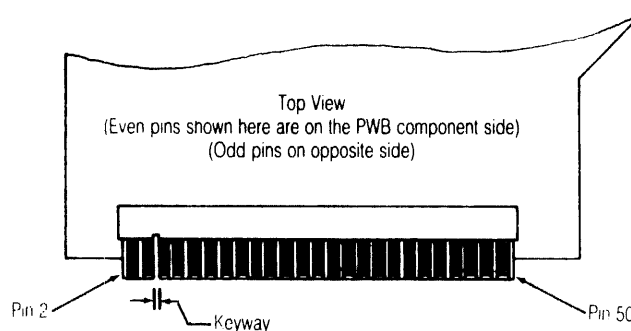

Figure 4.3 Basic Tape Drive Interface Connector J1

4.7 INTERFACE CONNECTOR J1 PIN ASSIGNMENTS

The connection is through a raised 50 pin PCB edge connector J1 (Figure 4.3) on the Main PCB at the back of the drive. All even pins are for active signals or reserved (Table 4.3). All odd pins are signal returns. The signal returns are

connected to signal ground at the drive and should be connected to signal ground at the controller.

4.8 POWER INTERFACE

4.8.1 Power Requirements

The DC power requirements are as tabulated in Table 4.4.

Table 4.3 Basic Tape Drive Interface Connector J1 Pin Assignments

Pin#	Name	To	Name
02	GO-	D	Go
04	REV-	D	Reverse
06	TR3-	D	Track Select Bit 3 (MSB)
08	TR2-	D	Track Select Bit 2
10	TR1-	D	Track Select Bit 1
12	TR0-	D	Track Select Bit 0 (LSB)
14	RST-	D	Reset
16	RES	R	Reserved
18	RES	R	Reserved
20	RES	R	Reserved
22	DS0-	D	Drive Select
24	HC-	D	High Current (High write current for DC 600A tape)
26	RDP-	C	Read Data Pulse
28	UTH-	C	Upper Tape Hole
30	LTH-	C	Lower Tape Hole
32	SLD-	C	Selected
34	CIN-	C	Cartridge In
36	USF-	C	Unsafe
38	TCH-	C	Tachometer
40	WDA-	D	Write Data -
42	WDA+	D	Write Data +
44	THD-	D	Threshold
46	HS-	D	High Speed (90 ips)
48	WEN-	D	Write Enable
50	EEN-	D	Erase Enable

LEGEND: D = Drive
 C = Controller
 R = Reserved

Table 4.4 Basic Tape Drive Power Requirements

DC Voltage	+ 12 Volts	+ 5 Volts
Tolerance (includes 200mv max. ripple)	± 10%	± 5%
Operational current	1.6 ± 0.8 amps (Cartridge Dependent)	0.6 amps max.
Tape Start or stop surge current	4.0 amps max. up to 300 msec*	0.0 amps
Power on surge current	Thru 150 uf max. capacitance	Thru 25 uf max. capacitance
Voltage Rise Time	100 ms max.	100 ms max.
Power sequence	None	None
Power Dissipation (In continuous streaming mode)	19 watts	3 watts
Power Dissipation (During start or stop power surges)	48 watts	3 watts

*May be longer for defective cartridge

4.8.2 Power Connector Location And Pin Assignments

Power must be plugged into the Basic drive at J2 (Figure 4.4) on the Motor Driver PWB at the back of the drive. The mating connector (P2) requires an AMP P/N 1-480424-0 and uses AMP P/N 60619-1 female contact pins. The power connections are listed in Table 4.5.

Table 4.5 Basic Tape Drive J2 Power Connector Pin Assignments

Pin 1	+ 12 VDC
Pin 2	+ 12 VRET
Pin 3	+ 5 VRET
Pin 4	+ 5 VDC

Note: Pins 2 and 3 connected together at the drive.

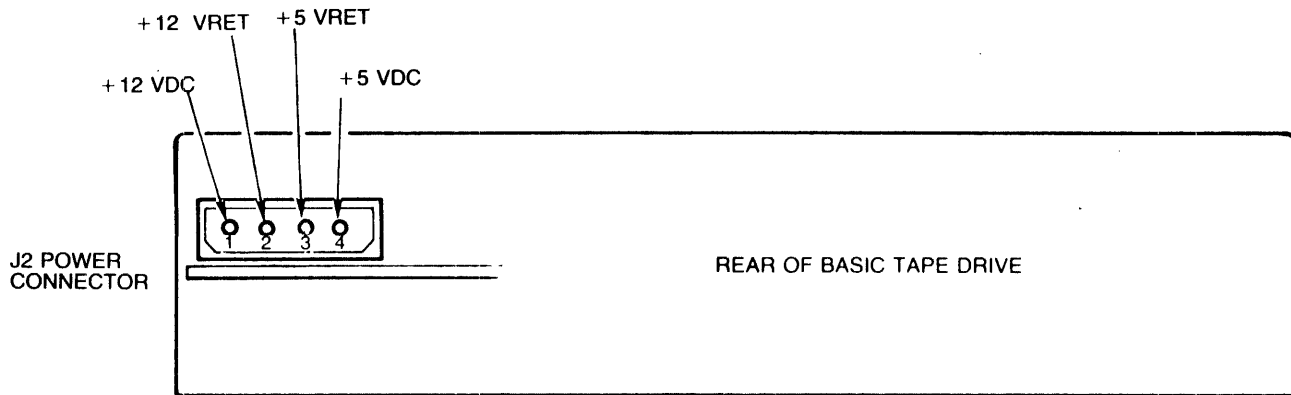

Figure 4.4 Basic Tape Drive Power Connector J2

SECTION 5

SCORPION INTELLIGENT TAPE DRIVE FUNCTIONAL CHARACTERISTICS

5.1 GENERAL

The contents of this section apply to both the full-high Intelligent tape drive and the Intelligent tape drive in two separate assemblies [Basic tape drive with Stand Alone Controller (SAC) PWB] for space saving purposes. Reference to section 6, "Scorpion Intelligent tape drive interface" while reading this section may be useful. This section contains the following information concerning the Scorpion Intelligent tape drive functional characteristics:

- Description of the Intelligent tape drive (5.2)
- The method used for selection of the drive and track in the Intelligent drive (5.3)
- A description of device self testing (5.4)
- The elements of tape motion in the Intelligent tape drive (5.5)
- Methods used in the storage and recovery of data (5.6)
- The process of acquiring status information (5.7)

5.2 INTELLIGENT TAPE DRIVE DESCRIPTION

The Intelligent Scorpion tape drive is available in two options as follows:

- A full-high Intelligent option combines the Basic tape drive (described in Section 3.0) with the Stand Alone Controller (SAC) PWB mounted in a metal chassis below (Figure 5.1)
- A half-high Intelligent option mounts the Basic tape drive away from the Stand Alone Controller (SAC) PWB with a ribbon cable connecting them (Figure 5.2)

5.3 DRIVE AND TRACK SELECTION

Drive selection is accomplished with the SELECT command. One unit is selected. Drive 0 is automatically selected following a power on sequence or a RESET to the drive. Another command called SELECT DRIVE, LOCK CARTRIDGE may be used. This command will select the drive and provide a soft cartridge lock. Soft cartridge lock means the front panel LED will remain on regardless of tape position. In addition EXCEPTION will be asserted when a locked cartridge is removed. Execution of the SELECT command or RESET will unlock the cartridge.

Track selection is automatically performed by the drive in such a way as to appear to the host as one long track. Physical track 0 and all even numbered tracks are recorded by the drive in the forward direction. Odd numbered tracks are recorded by the drive in the reverse direction. Read and write operations start at the beginning of tape on track 0 (logical BOT) after cartridge insertion, reset, power on and following off line

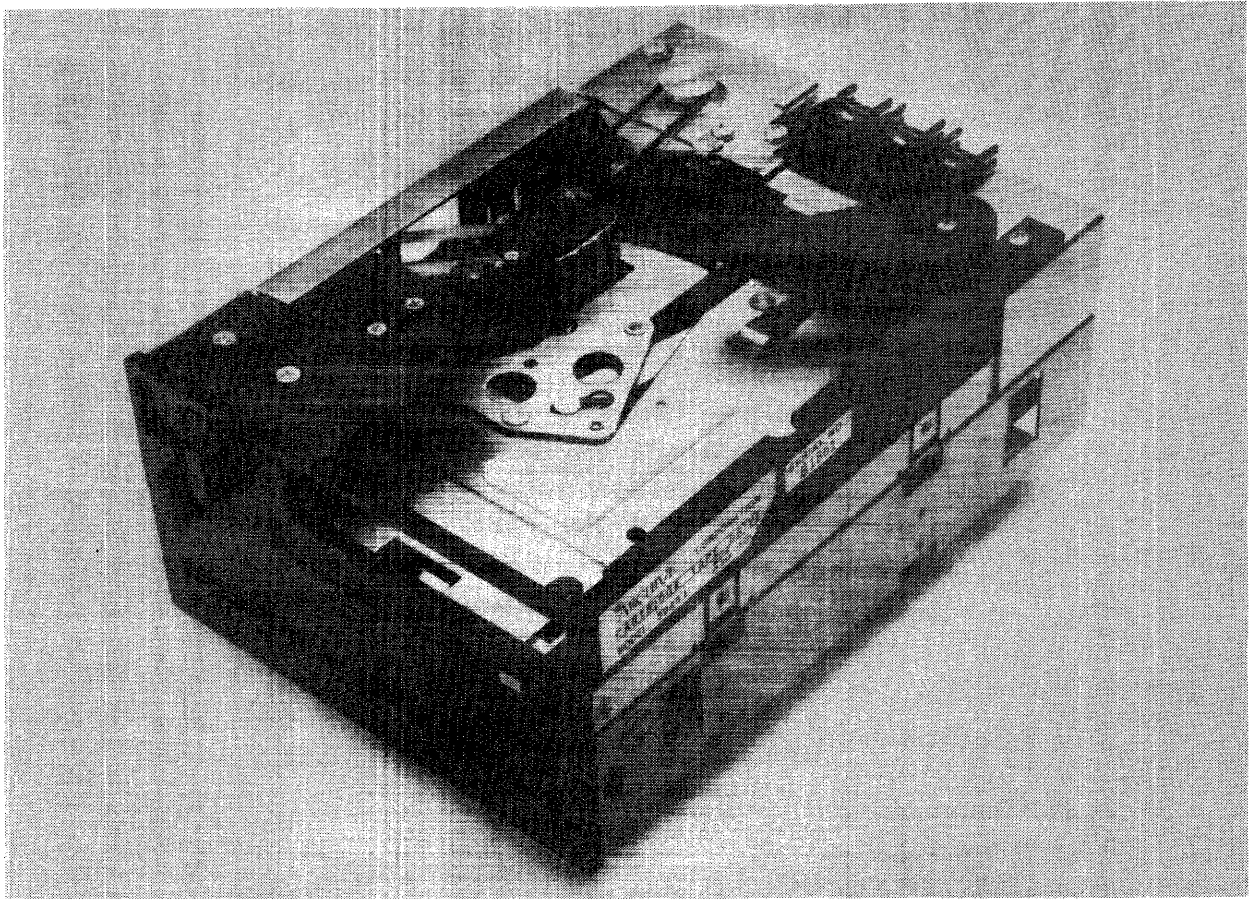

Figure 5.1 Full-High Intelligent Tape Drive

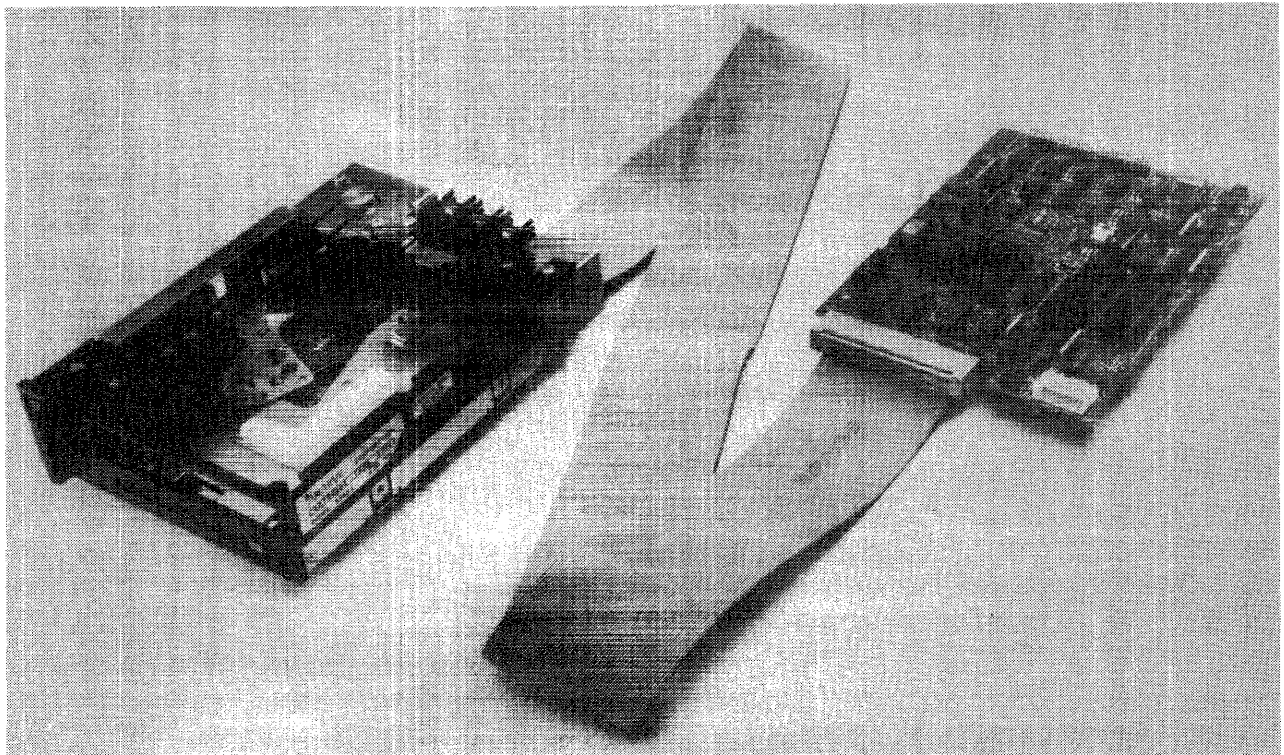

Figure 5.2 Half-High Basic Tape And SAC PWB

sequence. Under all other circumstances the read and write operations begin where the previous operation finished.

5.4 SELF TESTS

The Power On Confidence (POC) check is composed of a number of tests to ensure the operational readiness of the drive electronics before the drive is used.

The POC check is optional. To run the check placement of a jumper at location KK (Figure A.2) is required. With the jumper in place, tape drive power on or reset will cause the tests to begin. Five LEDs on the back of the Stand Alone Controller PWB indicate that the tests are in progress by blinking on then off. The following tests will be run to check the operation of the SAC electronics:

1. 8031 internal RAM and basic microcomputer instruction test.
2. LSI controller chip test
3. 16K RAM chip test
4. Data Separator logic test
5. 8155 PIA chip test

Failures detected by POC are indicated by the five LEDs at the back of the SAC board DS1 – DS5 (Figure A.2) and reported to the host by the assertion of EXCEPTION within 5 seconds. Failure of tested electronics is associated with an LED designated as follows:

LED	Failed Electronics
DS1	LSI controller chip error
DS2	16K RAM buffer chip error
DS3	Data Separator logic error
DS4	8155 (PIA) chip error
DS5	Not used

If a test fails it is repeated. Each time a test fails the associated LED will blink. Failure of the 8031 microcomputer shall be indicated by unpredictable results. Upon passing the tests successfully the LEDs will blink once, on and then off.

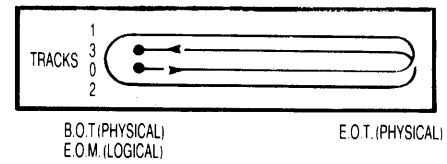

A. Four track recording

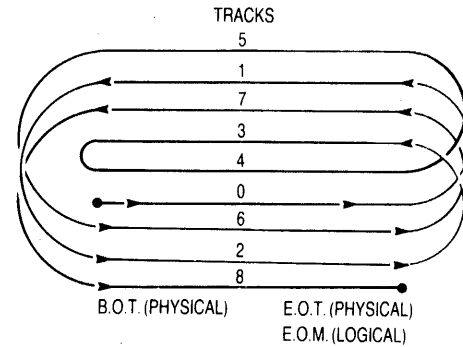

B. Nine track recording

Figure 5.3 Serpentine Recording

5.5 TAPE MOTION

5.5.1 Serpentine Recording

The serpentine pattern (Figure 5.3) is created by writing track 0 with the lower pair of heads enabled while moving from BOT to EOT. An erase bar which precedes these heads will do a full tape width erase on the first pass. When the end of tape is reached, the lower pair of heads is disabled and the upper pair of heads is enabled. The capstan motor is reversed and as the tape moves from EOT to BOT, track 1 is written. When the beginning of tape is reached, tape motion is stopped, the head assembly is stepped to the next track pair location and the process is repeated until either four or nine tracks are written depending on the drive type. The track layout of the Scorpion allows the nine track, 45/60MB drive to read tapes written on a four track, 20/26.7MB drive (Figure 5.4).

5.5.2 Tape Positioning Operations

Commands which will generate a tape positioning operation are BOT, RETENSION, and ERASE.

A BOT command will rewind the tape to the BOT holes (Figure 5.5) at the beginning of the tape.

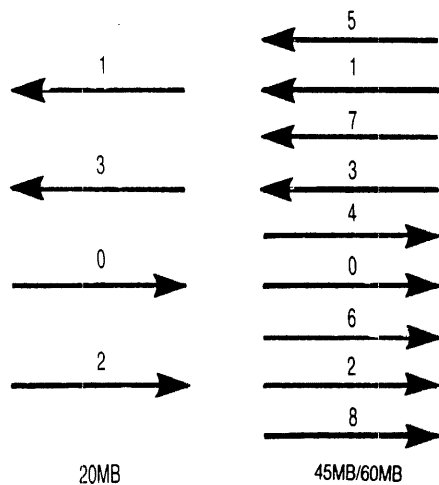

Figure 5.4 Comparative Track Layout

A RETENSION command will wind the tape to BOT then EOT and back to BOT (Figure 5.5). The ERASE command is used to erase the entire tape. This command will cause the drive to rewind the tape to BOT, erase from BOT to EOT and then rewind the tape to BOT.

5.6 DATA STORAGE AND RECOVERY METHODS

5.6.1 The Recording and Encoding Technique

The method of recording is NRZI, using a 4-to-5 run-length limited code (Figure 5.6). The 4-to-5

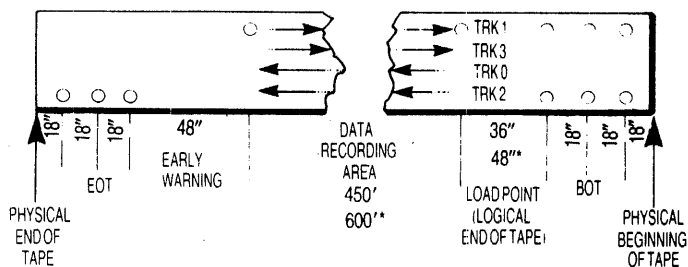

*DC 600A Tape

Figure 5.5 Tape-position Holes DC 300XL and DC 600A 1/4-Inch Cartridge Tape

HEX	BINARY	=	HEX	BINARY
00	0000	=	19	11001
01	0001	=	1B	11011
02	0010	=	12	10010
03	0011	=	13	10011
04	0100	=	1D	11101
05	0101	=	15	10101
06	0110	=	16	10110
07	0111	=	17	10111
08	1000	=	1A	11010
09	1001	=	09	01001
0A	1010	=	0A	01010
0B	1011	=	0B	01011
0C	1100	=	0E	11110
0D	1101	=	0D	01101
0E	1110	=	0E	01110
0F	1111	=	0F	01111
PREAMBLE		=	1F	11111
POSTAMBLE		=	1F	11111
DATA BLOCK MARKER		=	07	00111
FILE MARK		=	05	00101

Figure 5.6 4-to-5 Run Length Limited Code

code translates 4 bit nibbles of data to 5-bit nibbles of encoded data. By design there will never be more than two consecutive zeros in the data stream, regardless of how the five-bit-encoded nibbles are strung together. This recording and encoding technique ensures that a synchronizing transition (a one bit) will occur at least once for every three bit cells. It also allows the use of three unique bit patterns for preamble/postamble, data block marker and file mark. These are patterns that can never appear in the user data field.

The 4-to-5 encoded data are written at signal densities up to 10,000 flux transitions per inch (ftpi). This equates to a data density of 8000 bits per inch (bpi). The signal is recorded on AC-erased tape. A single, full width erase bar is used to erase tape. When data is recorded on track 0, the erase bar is enabled, erasing the full width of the tape ahead of the write head. When the end of track 0 is reached, the erase bar is disabled and the remainder of the tracks are written on cleanly erased tape. The Scorpion command set also allows the user to do an erase pass prior to writing.

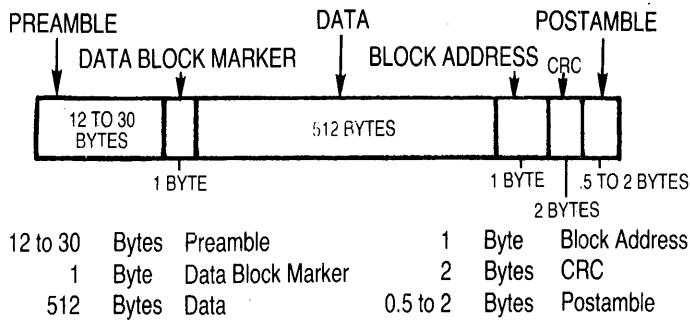

Figure 5.7 Archive QIC-11 1/4-Inch Streaming Tape Format

5.6.2 Data Format

Data transfers to the tape drive are in 512 byte blocks. Because this is an Intelligent drive it automatically formats each block as it is written on the tape. The Archive QIC-11 format (Figure 5.7) contains 528.5 to 548 bytes of bit serial data.

5.6.3 Write Operations

If the drive is at BOT and receives a WRITE command and the first block of data, it will begin moving tape. When the Load Point is seen, the drive will begin recording the data on tape. If the drive is already in the streaming mode and receives a WRITE command (e.g. following a WRITE FILE MARK command) it will ensure that it has received the next block of data and that the tape is up to speed after which it will resume writing data to tape following the file mark block. The controller has four data buffers which are used in a ring sequence. As long as the host is able to keep data flowing so that the next block to be written is available, the drive will keep the tape in motion.

Each formatted block of data is written immediately after the preceding block. A 12 to 30 byte preamble is written at the beginning of each formatted block and is made up of an all ones pattern used for read data synchronization. A 0.5 to 2 byte postamble is written at the end of each formatted data block to act as guard information. The postamble is made up of an all ones pattern also.

5.6.3.1 Underruns

To write in the streaming mode, the tape must be in constant motion. For tape motion to be constant, the flow of data from the host must be sufficient to keep the tape drive's buffers full of data. If data transfers from the host are interrupted, an underrun will occur. If the transfers of data from the host are just slightly under the required data rate, tape will not stop but the drive may, at intervals, write a duplicate of the preceding data block. The duplicate block is transparent to the host.

If data from the host is seriously interrupted, the drive will respond by writing a second copy of the last block, and then writing an elongated postamble, stopping tape motion, changing direction and positioning back over already written data.

When the data transfers resume, the drive will search for the end of the last block and begin writing.

Underruns should be avoided since the second copy of the last block and the elongated postamble both consume tape. The reposition routine also takes some time, reducing throughput.

5.6.3.2 Write File Mark

A file mark is a unique data block created by the drive. The command may be given in one of two ways.

If the user wishes to write a file mark, a WRITE FILE MARK command is issued. The drive will write a file mark, stop tape motion and exit write mode. The drive will not rewind the cartridge.

When the drive is in the write mode the user can also write a file mark by simply de-asserting ON LINE when READY is true. The drive will automatically write the file mark, exit write mode and rewind to BOT.

5.6.3.3 Data Append

New data may be appended to existing data on a cartridge tape. The host may also locate the end of recorded data by issuing repetitive READ

FILE MARK commands until “No Data Detected” is reported in the status bytes. A WRITE command is then issued by the host to append data.

5.6.3.4 End of Media

When a write operation is in process and the early warning hole for the last track is sensed, the drive will stop accepting data from the host at the next block boundary. The drive will finish writing all data blocks contained in the buffers and then raise EXCEPTION to the host. In response the host will read the drive status which will inform the host that the end of media bit has been set.

Once the end of media status bit has been read by the host, the host may then command WRITE, WRITE FILE MARK or drop ONLINE to produce one of the following tape drive responses.

- Write a block of data supplied by the host.
- Write a file mark.
- Write a file mark and rewind to BOT.

5.6.4 Read Operations

When a READ command is given at the beginning of tape, the drive will start tape motion in search of data. When the first block has been successfully read, READY is asserted and data transfers to the host begin. The drive will continue reading and transmitting data to the host until a file mark is encountered. When the drive reads a file mark, the read mode is exited and EXCEPTION is asserted. If no data is present on the cartridge, the drive will assert EXCEPTION and “No Data Detected” will be set in the status bytes.

5.6.4.1 Read After a File Mark

When a file has been read from the tape, the host may continue reading by issuing another Read Command. The drive will search for data after the file mark. Again, when the first block has been found, READY will be asserted and data transfers to the host will begin.

If no data is present beyond the file mark, the drive will assert EXCEPTION and “No Data Detected” is reported in the status bytes.

5.6.4.2 Read File Marks

To the tape drive, a READ FILE MARK command is the same as a READ DATA command except that no data is transferred to the host.

The drive reads the tape in search of a file mark. When a file mark is found, EXCEPTION is asserted with “file mark found” in the status bytes.

5.6.4.3 Read Underruns

As long as the host can maintain the required data transfer rate, the drive will keep the tape in motion. If something should happen to interrupt the data transfer, the drive will stop tape motion, reverse tape direction and position over previously read data. This is called a “read underrun”. When the host is able to begin transferring data, the drive will start tape motion and continue reading. The repositioning routine generated by the read underruns slow the average throughput.

5.6.5 Error Detection and Recovery

5.6.5.1 Read-After-Write Error Recovery

As data is written on the tape, a read-after-write check is performed. Error detection is accomplished by a sixteen-bit CRC character which is appended to the data block and written on tape. If a block is found to have an error, it is rewritten without stopping tape motion. Because the read head follows the write head by 0.3”, the block following the block-in-error has already been started. When this block is completed, the block-in-error is rewritten, along with a second iteration of the block following the block-in-error. If this effort is successful, writing continues. The drive will make 16 attempts to write the block-in-error before declaring a hard error. When a hard error occurs, the cartridge is rewound to BOT and EXCEPTION with unrecoverable data error is asserted.

5.6.5.2 Read Error Recovery

During a Read operation, the drive verifies each block using the 16 bit CRC character. If an error

occurs, either CRC or block sequence, the drive will read the next two blocks to see if the block-in-error was rewritten without error. If not, the drive stops the tape, backs up and tries to read the block-in-error a second time.

The drive will make 16 attempts to re-read a block before declaring a hard error. When a hard error occurs, the drive will stop tape motion, assert EXCEPTION with "Unrecoverable Data Error" in the status bytes. After a hard error, the host may continue reading the balance of the tape by issuing a READ command.

Multiple read re-tries will cause the controller to note in the status bytes if eight or more tries are

required before an error is recovered from a block of data.

5.7 STATUS INFORMATION

Following a power-up/reset or an exception condition, the drive will require the Host to perform a read status operation by asserting EXCEPTION. The Host will issue a READ STATUS command and handshake the six status bytes across the bus. Within the protocol of the interface a READ STATUS command may be initiated by the host even if the drive has not asserted the EXCEPTION signal.

SECTION 6

SCORPION INTELLIGENT TAPE DRIVE INTERFACE (QIC-02)

6.1 GENERAL

The contents of this section apply to both the full-high Intelligent tape drive and the Intelligent tape drive in two separate assemblies (Basic tape drive with Stand Alone Controller) for space saving purposes.

Interface information in this section is divided into five categories as follows:

- General information about the QIC-02 interface characteristics. (6.2)
- Specific explanations concerning the signals that can be activated on the control lines. (6.3 and 6.4)
- A description of the commands and data that can be transmitted on the 8 bit bi-directional bus. (6.5)
- Interface timing diagrams. (6.6)
- Pin Assignments for the host interface connector, tape drive power specifications and power connector pin assignments. (6.7 and 6.8)

6.2 INTERFACE CHARACTERISTICS

Data, commands and status information are transmitted to and from the Intelligent drive via the industry standard QIC-02 interface (Figure 6.1).

The QIC-02 interface is:

- Four control lines from the host.
- Four control lines from the drive.
- An eight-bit bi-directional bus.

The bus and control signals are all standard TTL levels and are low true.

FALSE, Logic 0 2.4 to 5.25 VDC
TRUE, Logic 1 0 to 0.55 VDC

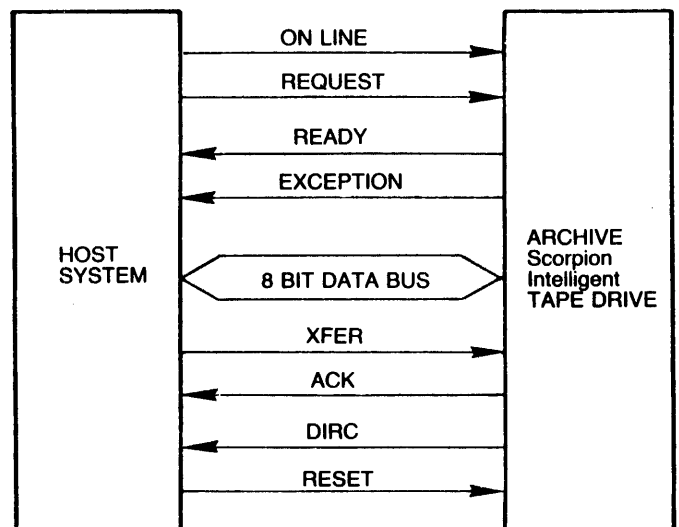

Figure 6.1 QIC-02 Interface

6.3 CONTROL LINES FROM THE HOST

6.3.1 REQUEST

REQUEST is driven by the host to signal to the controller that a command is present on the interface and to handshake the command across the interface. REQUEST is also used to handshake the six status bytes from the drive.

6.3.2 ON LINE

ON LINE is used by the host to terminate a read or write operation. Prior to beginning a read or write operation ON LINE must be true. When ON LINE becomes false, the operation is terminated and the cartridge is rewound to BOT.

6.3.3 TRANSFER

TRANSFER is the data handshake signal from the host. It is used with ACKNOWLEDGE from the drive to transfer data asynchronously across the interface.

6.3.4 RESET

The RESET line is used to initialize the tape drive. A RESET causes the drive to recalibrate the heads to track zero and to initialize the firmware.

6.4 CONTROL LINES FROM THE DRIVE

6.4.1 READY

READY is driven by the tape drive, it signals that the drive can accept a command and is used to handshake the command across the interface. During a read status operation it is used to handshake status data across the interface to the host. In the write mode READY indicates that a buffer in the drive is ready to be filled by the host. In the read mode READY indicates that a drive buffer is ready to be emptied by the host.

6.4.2 EXCEPTION

EXCEPTION is used to alert the host to a condition which has terminated the execution of a command. The drive sets EXCEPTION to signal the termination of an operation. The termination

referred to may be a normal completion or an interruption due to an encountered fault (hard errors, write protected cartridges, etc).

6.4.3 ACKNOWLEDGE

ACKNOWLEDGE is the data handshake signal from the drive. It is used with TRANSFER to transfer data across the interface asynchronously.

6.4.4 DIRECTION

The state of the DIRECTION signal defines the direction commands or data flow across the bus. The Intelligent Scorpion drive controls the direction of the bus. DIRECTION is available to the host only to enable/disable the host's bus drivers. When DIRECTION is true, data flows to the host. When DIRECTION is false, data flows to the tape drive.

6.5 BI-DIRECTIONAL BUS LINES

The bi-directional bus lines are used to transfer commands, status, and read/write data between the host system and the Intelligent Scorpion tape drive.

6.5.1 The Command Set

The Scorpion command set is shown in Table 6.1. All Scorpion commands are single byte commands and are QIC-02 compatible. Each command has two fields, the command type and the command modifiers. Bits 7 through 5 are the command type field and bits 4 through 0 are the command modifier field.

There are seven user command types:

<u>Type Field</u>	<u>Command Group</u>
000	Select
001	Motion
010	Write
011	Write File mark
100	Read
101	Read File mark
110	Read Status

Table 6.1 Command Summary

Bit		Description
7654	3210	
0000	0001	SELECT DRIVE 0
0001	0001	SELECT DRIVE 0 LOCK CARTRIDGE
0010	0001	BOT
0010	0010	ERASE
0010	0100	RETENSION
0100	0000	WRITE
0110	0000	WRITE FILE MARK
1000	0000	READ
1010	0000	READ FILE MARK
1100	0000	READ STATUS

6.5.2 SELECT COMMANDS

The SELECT command enables the Basic tape drive to communicate with the controller. Once enabled by the SELECT command the LED on the front panel will be on during read, write, or position operations and when stopped between files. The front panel LED will be off when the cartridge is not inserted in the drive.

An alternate method of selecting the drive is to use the SELECT DRIVE, LOCK CARTRIDGE command. The SELECT DRIVE, LOCK CARTRIDGE command also enables the Basic tape drive to communicate with the controller. This command causes the front panel LED to remain on during read or write operations and regardless of tape position. In addition EXCEPTION will be asserted if the cartridge is removed while the front panel LED is on. During normal operation in the SELECT DRIVE, LOCK CARTRIDGE (cartridge loaded) mode the select indicator will remain on until the SELECT command is again issued as described in the previous paragraph.

6.5.3 MOTION COMMANDS

Within the motion command type, there are three operations that can be performed.

1. Rewind the tape cartridge to BOT.

2. Completely erase a tape cartridge.
3. Manually initialize a cartridge.

The command to accomplish the first operation is called the BOT command. It will rewind the tape at high speed to BOT.

An ERASE command will accomplish the second operation. The entire tape is erased with an erase bar the width of the tape.

To accomplish the third operation a RETENSION command is issued. This will rewind the tape first to BOT at high speed, then to EOT and back to BOT.

6.5.4 WRITE COMMAND

The WRITE command instructs the drive to write data on the tape, while writing, data formatting and error correction are automatically performed.

6.5.5 WRITE FILE MARK COMMAND

A WRITE FILE MARK command causes the Scorpion to write a file mark on the tape. A file mark may be used to identify the end of recorded data or a division between groups of data. The command may be given to conclude writing or to create a division between the data being written without stopping tape motion.

6.5.6 READ COMMAND

The READ command instructs the drive to read data from the tape. Data will be transferred from the drive to the host with an asynchronous handshake. During a read operation, error recovery will be automatically performed by the drive.

6.5.7 READ FILE MARK COMMAND

The READ FILE MARK command allows the user to seek to the end of a file. During a read file mark operation, the controller will read the tape, searching for a file mark, but the data will not be transferred to the host. When a file mark is detected, tape motion is stopped and the host is informed that a file mark was found.

6.5.8 READ STATUS COMMAND

The READ STATUS command is used to transfer status information from the drive to the host. The status bytes are used to communicate such things as “end of media”, “file mark detected”, “write protected cartridge”, etc.

A “read status operation” may be initiated by the host at the completion of a command. The host must issue READ STATUS command if EXCEPTION is asserted by the drive.

6.5.8.1 Status Information

The Scorpion maintains six bytes of status information that are available to the host. The status bytes are requested by a READ STATUS command. When an exception condition occurs, the host must perform a read status operation. An exception condition is defined as any condition which prevents the performance or continuation of a command.

The host, however, is not limited to using the READ STATUS command only in response to an exception condition. Within the limits of the interface protocol, the host may request status at any time.

The status bytes contain the following information:

<u>Bit</u>	<u>Byte 0</u>
0	File mark detected
1	Bad block not located
2	Unrecoverable data error
3	End of media
4	Write protected cartridge
5	Unselected drive
6	Cartridge not in place
7	Status byte 0 bits (active)

<u>Bit</u>	<u>Byte 1</u>
0	Power-on/reset occurred
1	End of recorded media
2	Bus parity error
3	Beginning of media
4	Marginal block detected (Eight or more read retries for one block)
5	No data detected
6	Illegal command
7	Status byte 1 bits (active)

Bytes 2 (MSB) and 3 (LSB) contain a binary count of the number of recoverable errors that occurred during the last read or write operation.

Bytes 4 (MSB) and 5 (LSB) contain a binary count of the number of underruns that occurred during the last read or write operation.

6.6 INTERFACE SIGNAL TIMING

Timing information for the reset control signal (with and without POC enabled) and the QIC-02 REV D compatible command set is provided in Figures 6.2 thru 6.10.

6.7 HOST CONNECTOR PIN ASSIGNMENTS

The host interface has been designed to minimize the number of interconnects (Table 6.2) between the drive and the host. Data and commands are transferred to and from the Intelligent Scorpion tape drive on an 8-bit bi-directional data bus using asynchronous hand-shaking techniques to eliminate rigorous timing constraints. The host interface connector is designated J1.

The connection is through a 50 pin PCB edge connector (Figure 6.11). The pins are numbered 1 through 50 with the even numbered pins located

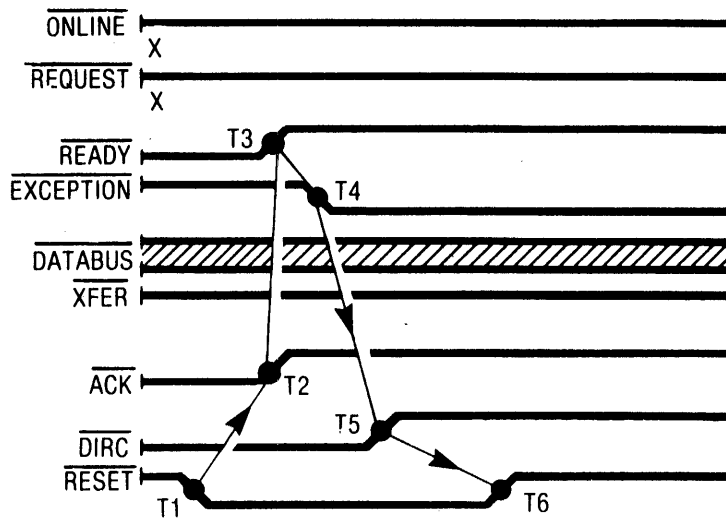

ACTIVITY	CRITICAL TIMING
T1-HOST ASSERTS RESET	N/A
T2-CONTROLLER DISABLES ACK	T1-T2 < 1 U Sec.
T3-CONTROLLER DISABLES READY	T1-T3 < 1 U Sec.
T4-CONTROLLER ASSERTS EXCEPTION	T1-T4 < 3 U Sec.
T5-CONTROLLER DISABLES DIRC	T1-T5 < 3 U Sec.
T6-HOST DISABLES RESET	T1-T6 > 25 U Sec.
X-DON'T CARE	

Figure 6.2 Reset Timing Without POC Enable

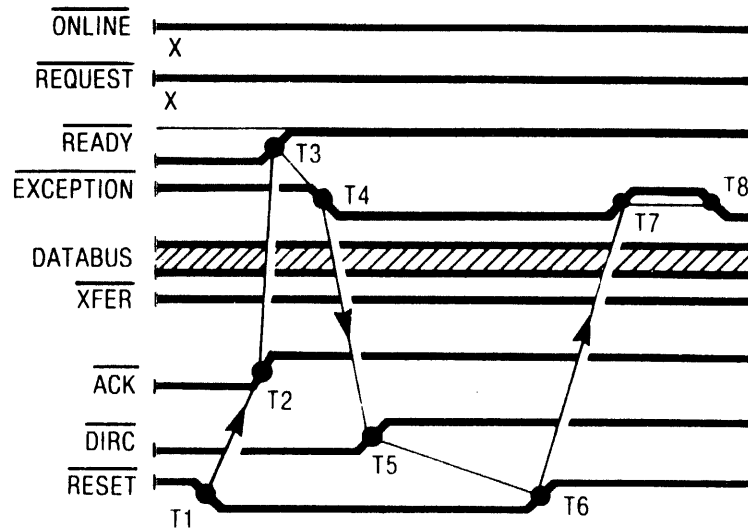

ACTIVITY

- T1-HOST ASSERTS RESET
- T2-CONTROLLER DISABLES ACK
- T3-CONTROLLER DISABLES READY
- T4-CONTROLLER ASSERTS EXCEPTION
- T5-CONTROLLER DISABLES DIRC
- T6-HOST DISABLES RESET
- T7-CONTROLLER DISABLES EXCEPTION
- T8-CONTROLLER ASSERTS EXCEPTION

X-DON'T CARE

CRITICAL TIMING

- N/A
- T1—T2 < 1 U Sec.
- T1—T3 < 1 U Sec.
- T1—T4 < 3 U Sec.
- T1—T5 < 3 U Sec.
- T1—T6 > 25 U Sec.
- T6—T7 > 0
- T7—T8 < 5 Sec. For POC Pass

Figure 6.3 Reset Timing With POC Enable

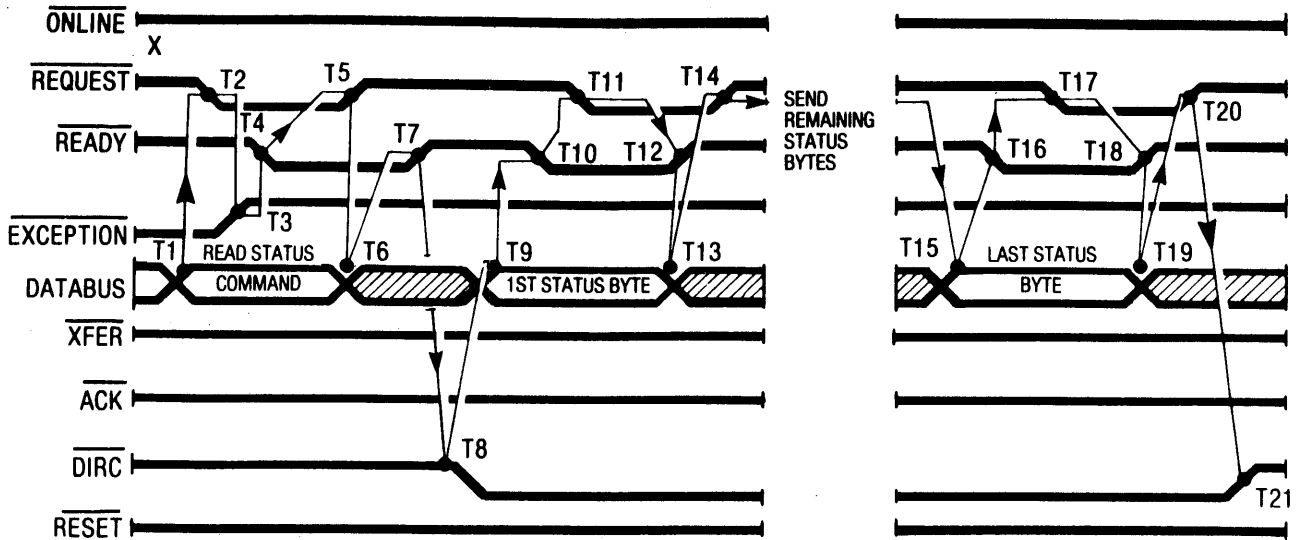

ACTIVITY

- T1-HOST COMMAND TO BUS
- T2-HOST SETS REQUEST
- T3-CONTROLLER RESETS EXCEPTION
- T4-CONTROLLER SETS READY
- T5-HOST RESETS REQUEST
- T6-BUS DATA INVALID
- T7-CONTROLLER RESETS READY
- T8-CONTROLLER CHANGES BUS DIRECTION
- T9-1ST STATUS BYTE TO BUS
- T10-CONTROLLER SETS READY
- T11-HOST SETS REQUEST
- T12-CONTROLLER RESETS READY
- T13-BUS DATA INVALID
- T14-HOST RESETS REQUEST
- T15-LAST STATUS BYTE TO BUS
- T16-SAME AS T10
- T17-SAME AS T11
- T18-SAME AS T12
- T19-SAME AS T13
- T20-SAME AS T14
- T21-CONTROLLER CHANGES BUS DIRECTION
- T22-CONTROLLER SETS READY
- X-DON'T CARE

CRITICAL TIMING

- N/A
- T1-T2 > 0 U Sec.
- T3-T4 > 10 U Sec.
- 20 < T2-T4 < 500 U Sec.*
- T4-T5 > 0 U Sec.
- T4-T6 > 0 U Sec.
- 20 < T5-T7 < 100 U Sec.
- N/A
- N/A
- T7-T10 > 20 U Sec.
- N/A
- T11-T12 < 1 U Sec.
- T11-T13 > 0 U Sec.
- T11-T14 > 20 U Sec.
- N/A
- SAME AS T10
- SAME AS T11
- SAME AS T12
- SAME AS T13
- SAME AS T14
- N/A
- T20-T21 > 0 U Sec.
- T21-T22 > 0 U Sec.

*NOTE: This time may be >500 M Sec. if the following occurs:

- a. The online signal is deasserted
- b. Retry sequence and no data detected
- c. At end of the track and turn around or start up.

Figure 6.4 Read Status Command Timing Diagram

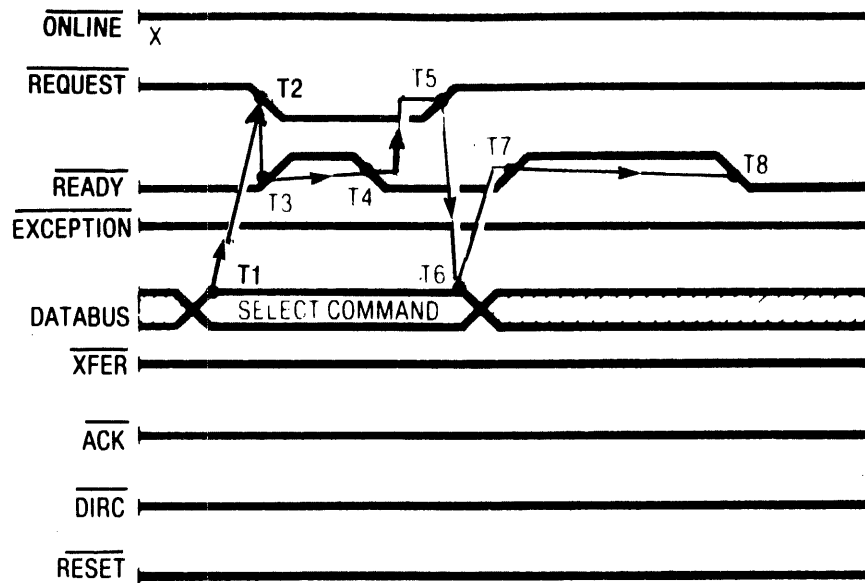

ACTIVITY

- T1-HOST COMMAND TO BUS
- T2-HOST SETS REQUEST
- T3-CONTROLLER RESETS READY
- T4-CONTROLLER SETS READY
- T5-HOST RESETS REQUEST
- T6-BUS DATA INVALID
- T7-CONTROLLER RESETS READY
- T8-CONTROLLER SETS READY

X-DON'T CARE

CRITICAL TIMING

- N/A
- $T1-T2 > 0$ U Sec.
- $T2-T3 < 1$ U Sec.
- $50 < T3-T4 < 500$ U Sec.*
- $T4-T5 > 0$ U Sec.
- $T4-T6 > 0$ U Sec.
- $20 < T5-T7 < 100$ U Sec.
- $T7-T8 > 20$ U Sec.

*NOTE: This time may be > 500 M Sec. if the following occurs:

- a. The online signal is deasserted.
- b. Retry sequence and no data detected.
- c. At end of the track and turn around or start up.

Figure 6.5 Select Command Timing Diagram

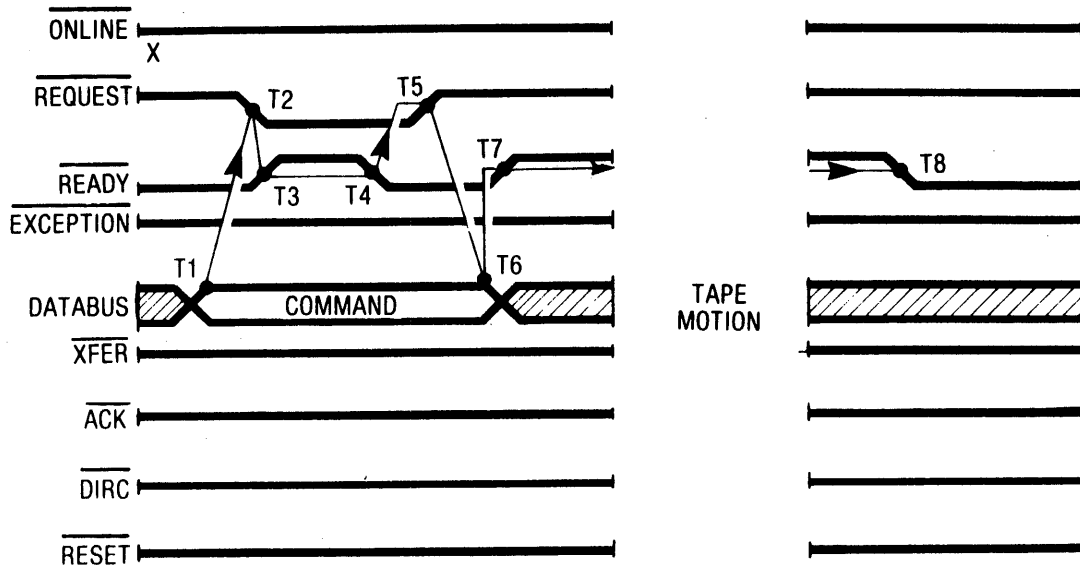

ACTIVITY

- T1-HOST BUS DATA VALID
- T2-HOST SETS REQUEST
- T3-CONTROLLER RESETS READY
- T4-CONTROLLER SETS READY
- T5-HOST RESETS REQUEST
- T6-BUS DATA INVALID
- T7-CONTROLLER RESETS READY
- T8-CONTROLLER SETS READY

X-DON'T CARE

CRITICAL TIMING

- N/A
- $T1-T2 > 0$ U Sec.
- $T2-T3 < 1$ U Sec.
- $20 < T3-T4 < 500$ U Sec.*
- $T4-T5 > 0$ U Sec.
- $T3-T6 > 0$ U Sec.
- $20 < T5-T7 < 100$ U Sec.
- $T7-T8 > 20$ U Sec.

*NOTE: This time may be > 500 M Sec. if the following occurs:

- a. The online signal is deasserted
- b. Retry sequence and no data detected
- c. At end of the track and turn around or start up

Figure 6.6 BOT, Retension or Erase Command Timing Diagram

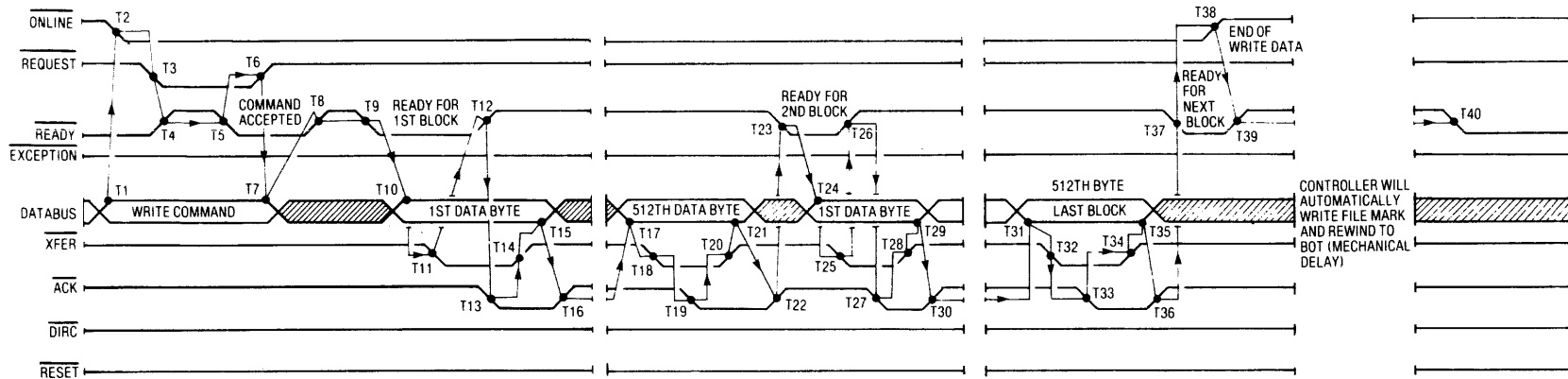

ACTIVITY	CRITICAL TIMING	ACTIVITY	CRITICAL TIMING	ACTIVITY	CRITICAL TIMING
T1-HOST COMMAND TO BUS	N/A	T15-BUS DATA INVALID	T13—T15>0 U Sec.	T28-HOST RESETS XFER	SAME AS T14
T2-HOST SETS ONLINE	N/A	T16-CONTROLLER RESETS ACK	0<T14—T16<3 U Sec.	T29-BUS DATA INVALID	SAME AS T15
T3-HOST SETS REQUEST	T2—T3>0 U Sec.	T17-HOST DATA TO BUS	N/A	T30-CONTROLLER RESETS ACK	SAME AS T16
T4-CONTROLLER RESETS READY	T3—T4<1 U Sec.	T18-SAME AS T11	SAME AS T11	T31-HOST DATA TO BUS	N/A
T5-CONTROLLER SETS READY	20<T4—T5<500 U Sec.*	T19-SAME AS T13	SAME AS T13	T32-HOST SETS XFER	SAME AS T18
T6-HOST RESETS REQUEST	T5—T6>0 U Sec.	T20-SAME AS T14	SAME AS T14	T33-CONTROLLER SETS ACK	SAME AS T19
T7-BUS DATA INVALID	T5—T7>0 U Sec.	T21-SAME AS T15	SAME AS T15	T34-HOST RESETS XFER	SAME AS T20
T8-CONTROLLER RESETS READY	20<T6—T8<100 U Sec.	T22-SAME AS T16	SAME AS T16	T35-BUS DATA INVALID	N/A
T9-CONTROLLER SETS READY	T8—T9>20 U Sec.	T23-CONTROLLER SETS READY	T22—T23>100 U Sec.	T36-CONTROLLER RESETS ACK	SAME AS T22
T10-HOST DATA TO BUS	N/A	T24-HOST DATA TO BUS	N/A	T37-CONTROLLER SETS READY	SAME AS T23
T11-HOST SETS XFER	T10—T11>40 NANO Sec.	T25-HOST SETS XFER	SAME AS T11	T38-HOST RESETS ONLINE	N/A
T12-CONTROLLER RESETS READY	T11—T12<1 U Sec.	T26-CONTROLLER RESETS READY	SAME AS T12	T39-CONTROLLER RESETS READY	N/A
T13-CONTROLLER SETS ACK	0.5<T11—T13<100 U Sec	T27-CONTROLLER SETS ACK	SAME AS T13	T40-CONTROLLER SETS READY	N/A
T14-HOST RESETS XFER	T13—T14>0 U Sec.				

*NOTE: This time may be >500 M Sec. if the following occurs:

- The online signal is deasserted
- Retry sequence and no data detected
- At end of the track and turn around or start up.

Figure 6.7 Write Data Command Timing Diagram

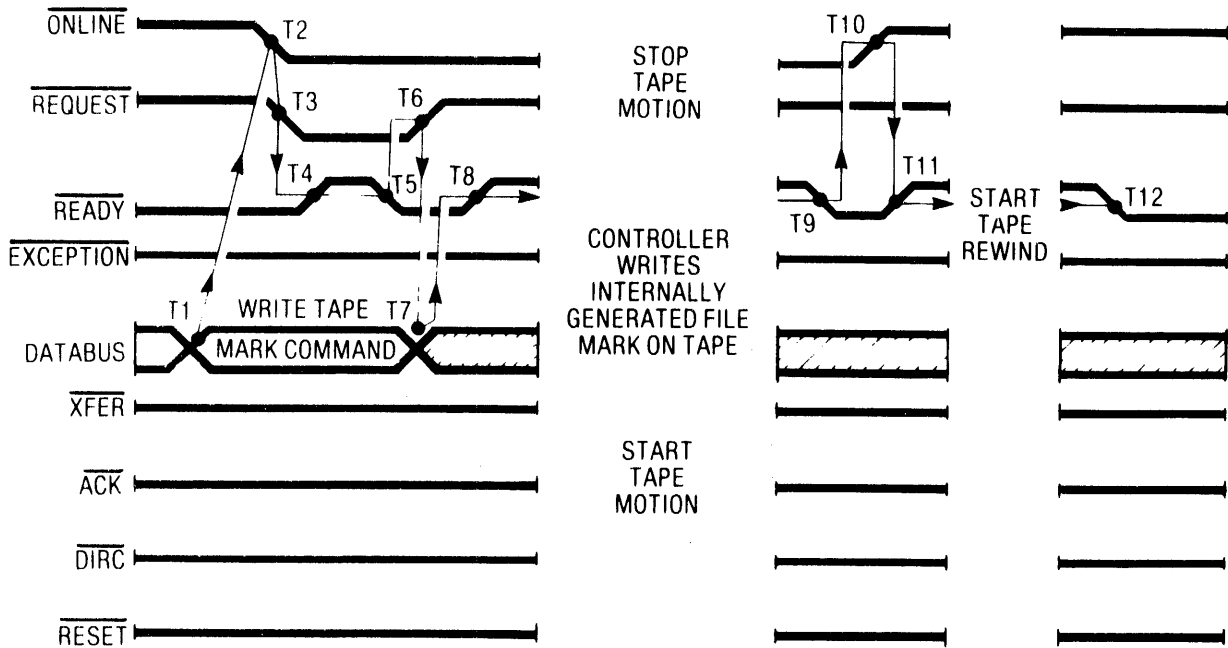

ACTIVITY

- T1-HOST COMMAND TO BUS
- T2-HOST SETS ONLINE
- T3-HOST SETS REQUEST
- T4-CONTROLLER RESETS READY
- T5-CONTROLLER SETS READY
- T6-HOST RESETS REQUEST
- T7-BUS DATA INVALID
- T8-CONTROLLER RESETS READY
- T9-CONTROLLER SETS READY
- T10-HOST RESETS ONLINE
- T11-CONTROLLER RESETS READY
- T12-CONTROLLER SETS READY (AT B.O.T.)

CRITICAL TIMING

- N/A
- T1-T2 > 0 U Sec.
- T2-T3 > 0 U Sec.
- T3-T4 < 1 U Sec.
- 20 < T4-T5 < 500 U Sec.*
- T5-T6 > 0 U Sec.
- T5-T7 > 0 U Sec.
- 20 < T6-T8 < 100 U Sec.
- N/A
- T9-T10 > 0 U Sec.
- N/A
- N/A

*NOTE: This time may be >500 M Sec. if the following occurs:

- a. The online signal is deasserted
- b. Retry sequence and no data detected
- c. At end of the track and turn around or start up

Figure 6.8 Write File Mark Command Timing Diagram

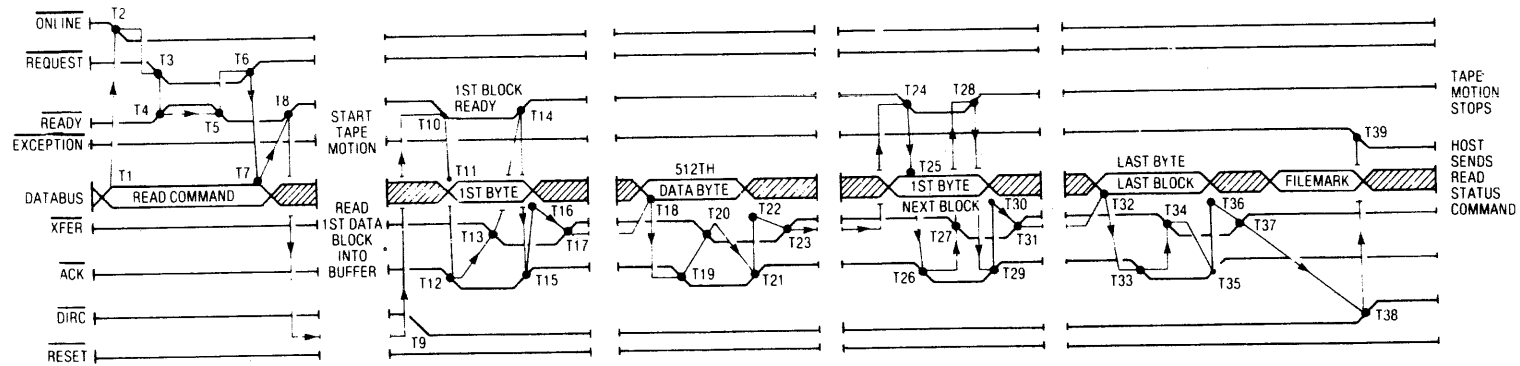

ACTIVITY	CRITICAL TIMING	ACTIVITY	CRITICAL TIMING	ACTIVITY	CRITICAL TIMING
T1-HOST COMMAND TO BUS	N/A	T14-CONTROLLER RESETS READY	$T13-T14 < 1 \text{ U Sec.}$	T27-HOST SETS XFER	SAME AS T13
T2-HOST SETS ONLINE	N/A	T15-CONTROLLER RESETS ACK	$0.5 < T13-T15 < 3 \text{ U Sec.}$	T28-CONTROLLER RESETS READY	SAME AS T14
T3-HOST SETS REQUEST	$T2-T3 > 0 \text{ U Sec.}$	T16-BUS DATA INVALID	$T13-T16 > 0 \text{ U Sec.}$	T29-CONTROLLER RESETS ACK	SAME AS T15
T4-CONTROLLER RESETS READY	$T3-T4 < 1 \text{ U Sec.}$	T17-HOST RESETS XFER	$T15-T17 > 0 \text{ U Sec.}$	T30-BUS DATA INVALID	SAME AS T16
T5-CONTROLLER SETS READY	$20 < T4-T5 < 500 \text{ U Sec.}^*$	T18-BUS DATA VALID	N/A	T31-HOST RESETS XFER	SAME AS T17
T6-HOST RESETS REQUEST	$T5-T6 > 0 \text{ U Sec.}$	T19-CONTROLLER SETS ACK	SAME AS T12	T32-LAST BYTE TO BUS	N/A
T7-BUS DATA INVALID	$T5-T7 > 0 \text{ U Sec.}$	T20-HOST SETS XFER	SAME AS T13	T33-CONTROLLER SETS ACK	SAME AS T12
T8-CONTROLLER RESETS READY	$20 < T6-T8 < 100 \text{ U Sec.}$	T21-CONTROLLER RESETS ACK	SAME AS T15	T34-HOST SETS XFER	SAME AS T13
T9-CONTROLLER CHANGES DIRC	N/A	T22-BUS DATA INVALID	SAME AS T16	T35-CONTROLLER RESETS ACK	SAME AS T15
T10-1ST DATA BYTE TO BUS	N/A	T23-HOST RESETS XFER	SAME AS T17	T36-BUS DATA INVALID	SAME AS T16
T11-CONTROLLER SETS READY	N/A	T24-CONTROLLER SETS READY	N/A	T37-HOST RESETS XFER	SAME AS T17
T12-CONTROLLER SETS ACK	$T11-T12 > 70 \text{ NANO Sec.}$	T25-1ST BYTE TO BUS	N/A	T38-CONTROLLER SETS EXCEPTION	N/A
T13-HOST SETS XFER	$T12-T13 > 0 \text{ U Sec.}$	T26-CONTROLLER SETS ACK	SAME AS T12	T39-CHANGE BUS DIRECTION	N/A

*NOTE: This time may be $> 500 \text{ M Sec.}$ if the following occurs:

- The online signal is deasserted
- Retry sequence and no data detected
- At end of the track or turn around or start up

Figure 6.9 Read Data Command Timing Diagram

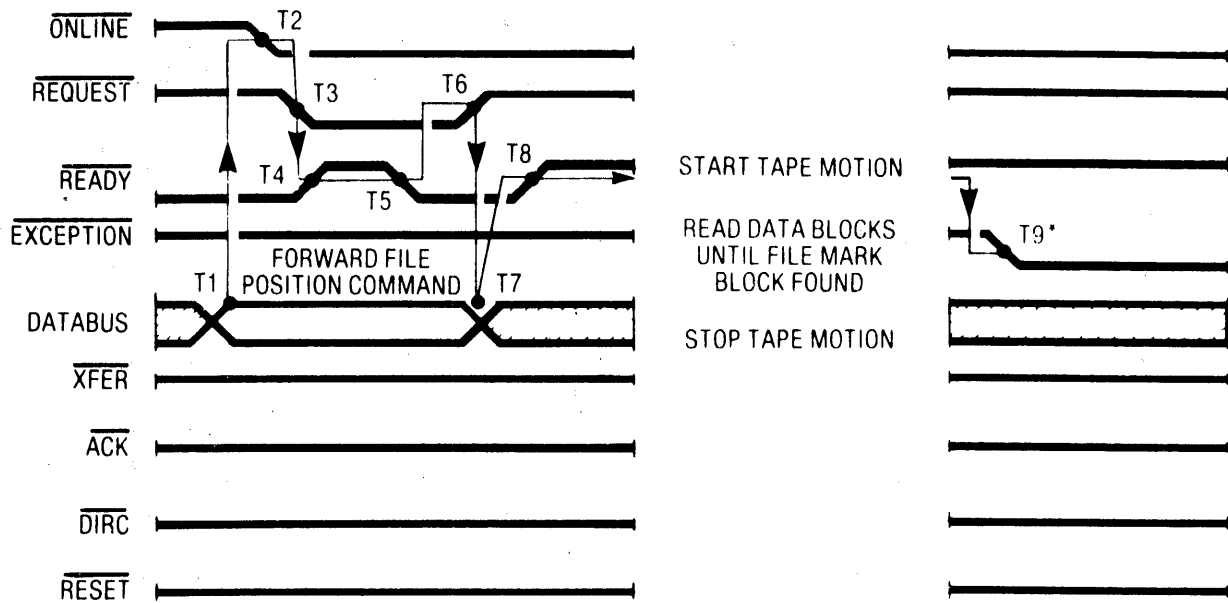

ACTIVITY

- T1-HOST COMMAND TO BUS
- T2-HOST SETS ONLINE
- T3-HOST SETS REQUEST
- T4-CONTROLLER RESETS READY
- T5-CONTROLLER SETS READY
- T6-HOST RESETS REQUEST
- T7-BUS DATA INVALID
- T8-CONTROLLER RESETS READY
- T9-CONTROLLER SETS EXCEPTION

CRITICAL TIMING

- N/A
- T1-T3 > 0 U Sec.
- T2-T3 > 0 U Sec.
- T3-T4 < 1 U Sec.
- 20 < T4-T5 < 500 U Sec.**
- T5-T6 > 0 U Sec.
- T4-T7 > 0 U Sec.
- 20 < T6-T8 < 100 U Sec.
- N/A

*System must issue read status command

**NOTE: This time may be > 500 M Sec. if the following occurs:

- a. The online signal is deasserted
- b. Retry sequence and no data detected
- c. At end of the track and turn around or start up

Figure 6.10 Read File Mark Command Timing Diagram

Table 6.2 Host Connector J1 Pin Assignments

Pin #	To	Mnemonic	Name
02	X	SPR-	RESERVED
04	X	SPR-	RESERVED
06	X	SPR-	RESERVED
08	X	SPR-	RESERVED
10	X	HBP-	RESERVED*
12	B	HB7-	HOST BUS BIT 7
14	B	HB6-	HOST BUS BIT 6
16	B	HB5-	HOST BUS BIT 5
18	B	HB4-	HOST BUS BIT 4
20	B	HB3-	HOST BUS BIT 3
22	B	HB2-	HOST BUS BIT 2
24	B	HB1-	HOST BUS BIT 1
26	B	HB0-	HOST BUS BIT 0
28	D	ONL-	ONLINE
30	D	REQ-	REQUEST
32	D	RST-	RESET
34	D	XFR-	TRANSFER
36	H	ACK-	ACKNOWLEDGE
38	H	RDY-	READY
40	H	EXC-	EXCEPTION
42	H	DIR-	DIRECTION
44	X	SPR-	RESERVED
46	X	SPR-	RESERVED
48	X	SPR-	RESERVED
50	X	SPR-	RESERVED

Note: All odd numbered pins are signal returns. They are connected to signal ground at the host.

X = Reserved
 B = Bi-directional
 D = Drive
 H = Host

*Reserved for host odd parity.

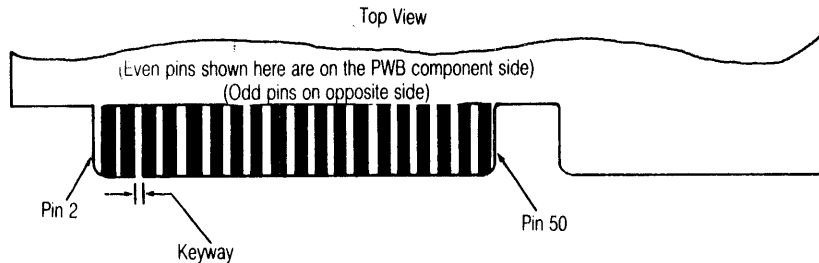

Figure 6.11 Host Interface Connector J1

on the component side of the PCB. There is a key slot located between pins 4 and 6 to ensure the cable is mounted in the correct position. The recommended mating connector is 3M type 3415-0001 fifty pin connector.

6.8 SIGNAL TERMINATIONS

The host and the tape drive have specific termination requirements.

Signal terminations at the host are 220 ohms to +5 VDC and 330 ohms to ground. The host shall terminate the bi-directional data bus and the four control signals from the tape drive.

Signal terminations at the tape drive are 220 ohms to +5.0 VDC and 330 ohms to ground. These resistances are provided by a 16 pin resistor dual inline package (DIP) located at socket 1E on the tape drive Stand Alone Controller (SAC) PWB. The resistor DIP terminates the bi-directional data bus and 4 control signal lines from the host.

6.9 SIGNAL LOADING

Signals from the host to the tape drive are loaded by no more than 2 ma plus the required termi-

nation. The host shall not load each signal from the tape drive with more than 2 ma plus the required terminator load.

6.10 POWER INTERFACE

6.10.1 Intelligent Tape Drive Power Specifications

The DC power requirements are tabulated in Table 6.3.

6.10.2 Power Connector Locations and Pin Assignments

Power must be applied to the Intelligent tape drive in two places requiring two input connectors. The connectors are identical and the Pin assignments are the same. Power must be plugged into the Motor Driver PWB J2 at the back of the Basic tape drive. Power must also be plugged into the SAC PWB J2 at the back of the tape drive or at the mounting location if the SAC PWB is mounted separately. The mating connectors for the power cable to the Intelligent tape drive are AMP type 1-480424-0 and uses AMP type 60619-1 female contact pins (Figure 6.12).

The connections at both J2 connectors are as shown in Table 6.4.

Table 6.3 Intelligent Tape Drive Power Requirements

DC Voltage	+12 Volts	+5 Volts
Tolerance (includes 200 mv max. ripple)	± 10%	± 5%
Operational current	1.75 ± 0.8 (Cartridge Dependent)	2.4 amps max.
Tape Start or stop surge current	4.15 amps max. up to 300msec*	0 amps
Power on surge current	Thru 200 uf max. capacitance	Thru 60 uf max. capacitance
Voltage Rise Time	100 ms max.	100 ms max.
Power sequence	None	None
Power Dissipation (In continuous streaming mode)	21 watts	12 watts
Power Dissipation (During start or stop power surges)	50 watts	12 watts

*May be longer for defective cartridge.

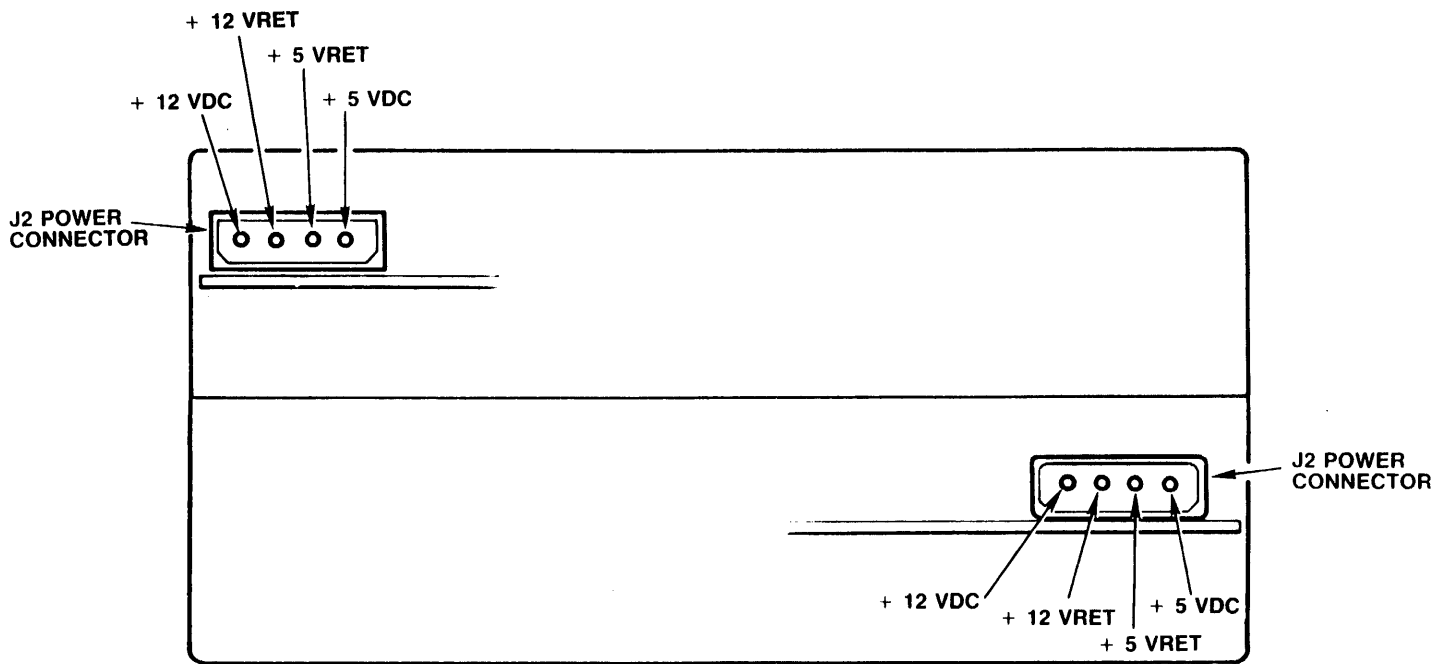

Figure 6.12 Intelligent Drive Power J2 Connectors

Table 6.4 Power Connector Pin Assignments

Pin 1	+12 VDC
Pin 2	+12 VRET
Pin 3	+5 VRET
Pin 4	+5 VDC

Note: Pins 2 and 3 are tied together at the Intelligent tape drive.

SECTION 7

MAINTENANCE FEATURES AND RELIABILITY GOALS

7.1 PREVENTIVE MAINTENANCE

Preventive maintenance for the drive consists of cleaning the read/write head assembly and tape hole sensor openings. The recommended frequency of cleaning is after every eight hours of actual tape motion. It is also recommended that the drive be cleaned after an initial pass of a new cartridge (or, if new cartridges are used exclusively, then after every 2 hours of tape motion). Recommended cleaning is with a clean lint-free swab and IBM (or equivalent) head cleaning solution. A 95% isopropyl alcohol solution may also be used. The procedure for cleaning the heads is:

- Ensure that power to the drive is off.
- Move the slide lever to extend the head assembly into the cartridge area.
- Use a 6 inch or longer lintless cotton swab move the swab in and out to clean the heads.
- Take care that excess cleaner is not applied to adjacent parts and that all residue left is completely removed prior to insertion of media.

7.2 FIELD MAINTENANCE AND SPECIAL TOOLS

Field Maintenance must be performed only by personnel who have been trained by the Archive Corporation. Special tools can be ordered from Archive for use by these factory trained personnel.

7.3 SPARE PARTS

Available Spare parts include the Stand Alone Controller PCB, the Main PCB, and the Motor Driver PCB (Figure 7.1). These parts can be ordered directly from the Archive Corporation Sales Department.

NOTE

Only service persons authorized by the Archive Corporation should undertake the adjustment of Scorpion electromechanical parts.

7.4 RELIABILITY GOALS

7.4.1 Service Life

The drive will provide a useful life of 5 years. Repair of a drive by replacement of major parts during the product lifetime is permitted.

7.4.2 Mean Time Between Failures (MTBF)

The mean time between failures shall be greater than 5000 hours. This includes all power on and operational time, but excludes any maintenance periods. The operational time is estimated to be 30% of the time that power is on.

7.4.3 Mean Time To Repair (MTTR)

MTTR is the average time for an Archive trained service person to diagnose and correct a malfunction at the subassembly level. The MTTR is less than 1/2 hour.

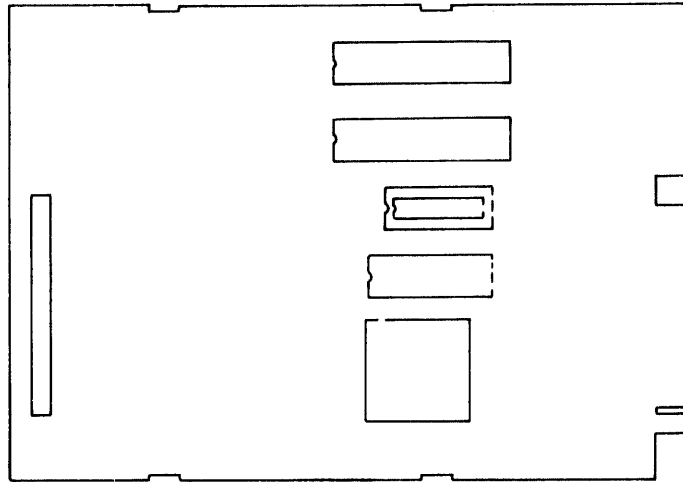

Stand Alone Controller PCB

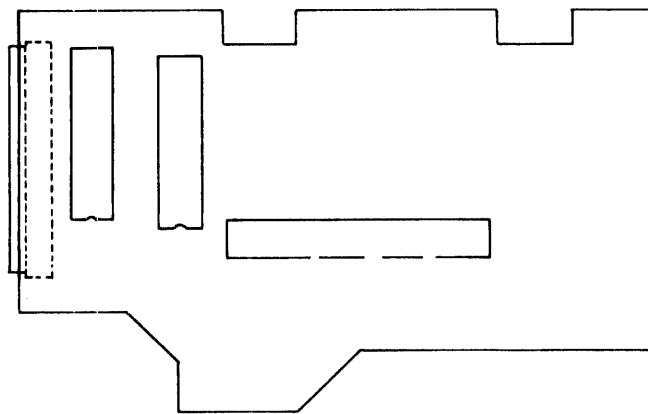

Main PCB

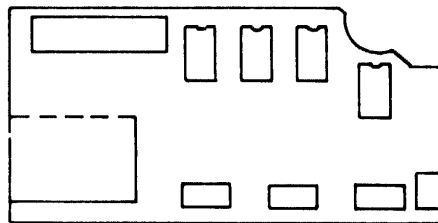

Motor Driver PCB

Figure 7.1 Scorpion Spare Assemblies

SECTION 8

PHYSICAL CHARACTERISTICS

8.1 ENVIRONMENTAL REQUIREMENTS

The limits of the operating and non-operating tape drive environment are listed in Table 8.1.

8.1.1 Ambient Conditions

Free air flow is required to prevent the drive ambient temperature from rising above 45 degrees C (113 degrees F) under operating conditions. Otherwise forced cooling to achieve the operating temperature requirements should be supplied.

8.2 PHYSICAL INTEGRATION DATA

8.2.1 Physical Dimensions And Weight of The Basic And Intelligent Scorpion

Dimensions and weight for the Half-High Basic drive are listed in Table 8.2. Dimensions and weight for the Full-High Intelligent drive are listed in Table 8.3.

Table 8.1 Environmental Requirements

	Operational	Non-Operational
Temperature	+5° to +45°C (+41° to +113°F)	-30° to +60°C (-22° to +140°F)
Relative Humidity	20 to 80% (non-condensing)	0 to 99% (non-condensing)
Thermal Gradient	1°C/min (33.8°F/min)	
Altitude	-1,000 ft to 15,000 ft	-1,000 ft to 50,000 ft
Shock	2.5g max (1/2 sine wave 11 msec duration on any axis)	25g max (1/2 sine wave 11 msec duration on any axis)
Vibration	0.005 inch max peak to peak displacement 0 to 63 Hz, 0.5g peak max. accel- eration 63 to 500 Hz	0.1 inch max peak to peak displacement 0 to 17 Hz, 1.5g peak max. accel- eration 17 to 500 Hz

Table 8.2 Basic Tape Drive Physical Dimensions And Weight

Depth	8.00 in	±.02 in	203.2 mm	±.51 mm
Width	5.75 in	±.02 in	146.05 mm	±.51 mm
Height	1.625 in	±.01 in	41.26 mm	±.25 mm
Weight	3.0 lb	±.5 lb	1.36 kg	±.23 kg

Table 8.3 Intelligent Tape Drive Physical Dimensions and Weight

Depth	8.45 in	±.02 in	214.6 mm	±.51 mm
Width	5.75 in	±.02 in	146.05 mm	±.51 mm
Height	3.25 in	±.02 in	82.55 mm	±.51 mm
Weight	3.75 lbs	±.5 lb	1.7 kg	±.23 kg

8.2.2 Mounting Requirements

The Scorpion Basic drive is designed to be mounted easily into the 1/2-high 5 1/4-inch floppy disk mounting space (See Figure 8.3 outline drawing for dimension detail and mounting hole location). The Scorpion Intelligent drive is designed to be easily mounted into the full-high 5 1/4-inch floppy disk mounting space (See Figure 8.4 outline drawing for dimension detail and mounting hole location).

The Basic and Intelligent drives are tested for alignment in the horizontal plane and in the vertical plane. It is recommended that units be mounted in the following orientations only:

Horizontal: Flat on the user supplied frame (cartridge loading area at drive top) with the tape slot facing forward (Figure 8.1).

Vertical: Tape unit on its right side with the tape slot facing forward (Slide lever at the top-Figure 8.2).

When mounting the Basic drive using the four provided threaded mounting holes in the chassis bottom (use horizontal position for reference) any three, but only three mounting holes should be used. When the drive must be secured to the user supplied frame by its sides, use of all four (two on each side) threaded holes in the drive chassis sides is permitted.

When mounting the Intelligent drive, threaded holes may be selected from the 16 threaded holes (6 on each side and 4 on the bottom) provided to allow mounting in the permitted orientations.

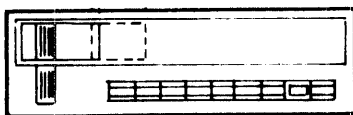

Figure 8.1 Horizontal Mounting Position

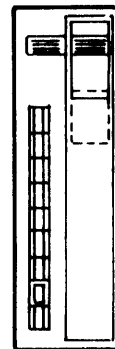

Figure 8.2 Vertical Mounting Position

The Intelligent configuration that requires separate mounting of the Basic drive and controller is mounted as follows:

- The mounting instructions already supplied for the Basic drive portion will apply.
- The controller portion may be mounted in one of two ways.
 1. Mounting in the supplied controller chassis may be accomplished by selecting the

required mounting holes from the 12 threaded holes provided in the chassis.

2. The controller PWB (by itself) can be mounted using the four holes that are provided in the board. See Figure 8.5 outline drawing for dimension detail and mounting hole location.

If a drive is mounted for operation in a dirty environment, positive measures should be taken to ensure that contaminants do not enter the drive.

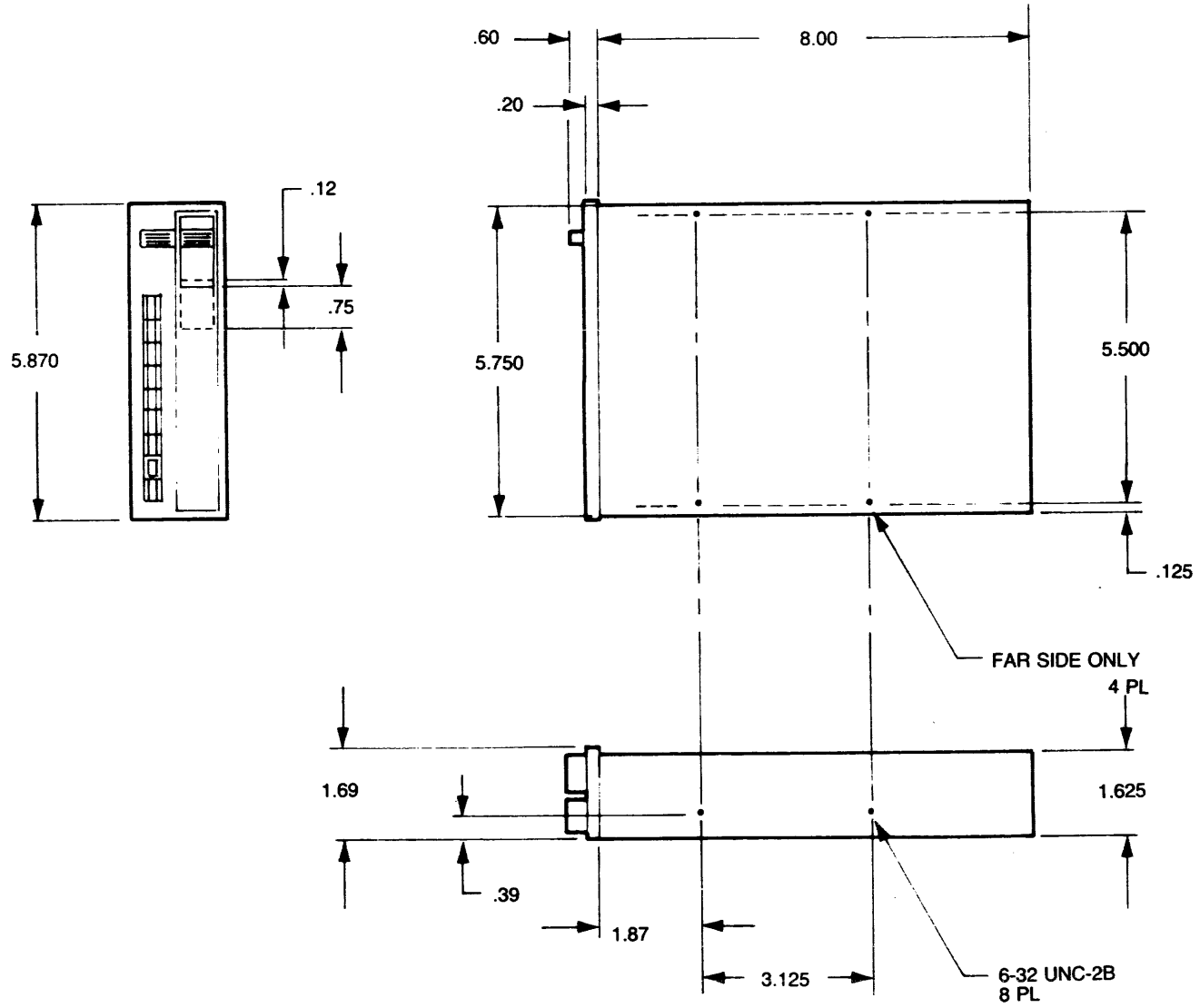

Figure 8.3 Basic Tape Drive Outline Drawing

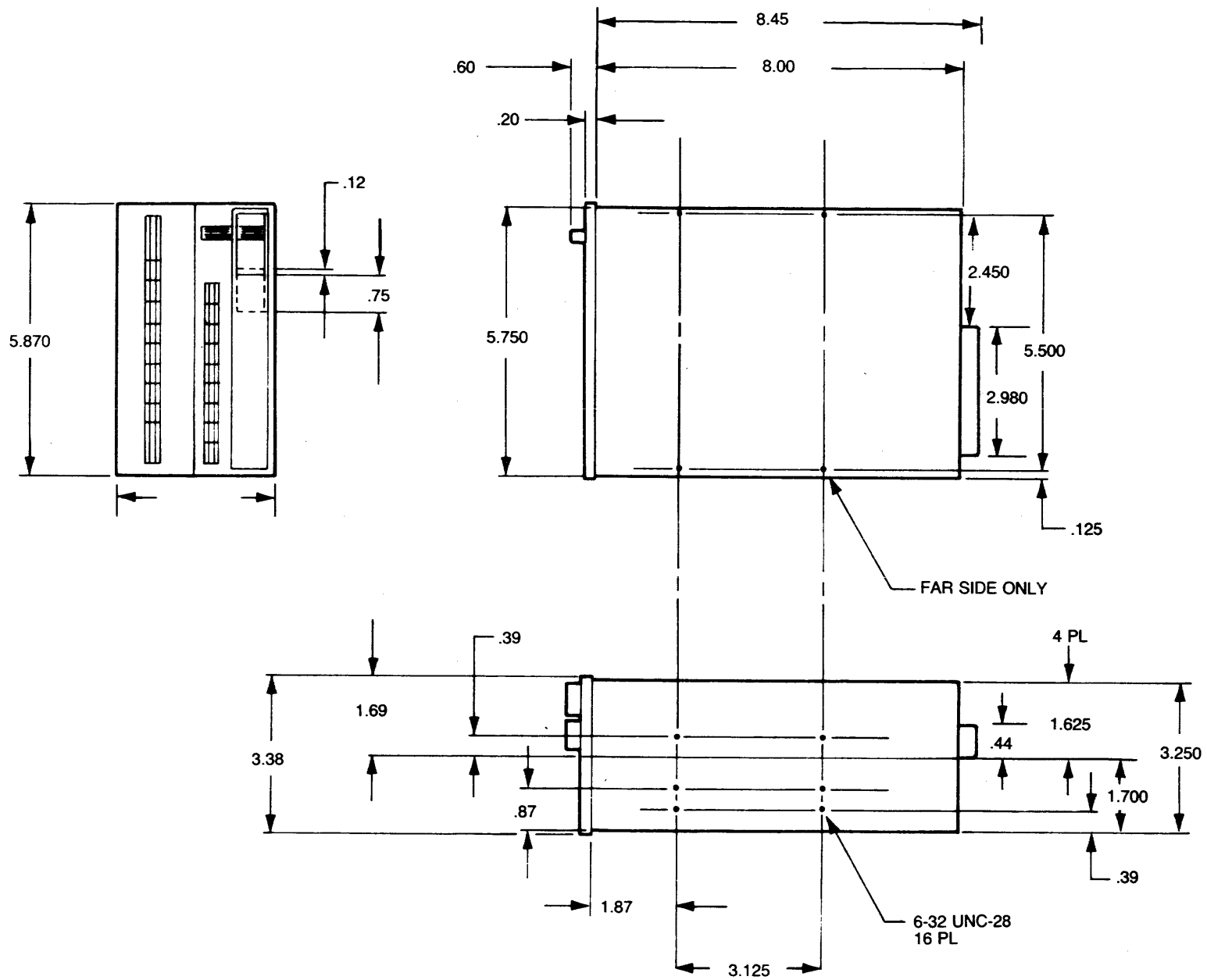

Figure 8.4 Intelligent Tape Drive Outline Drawing

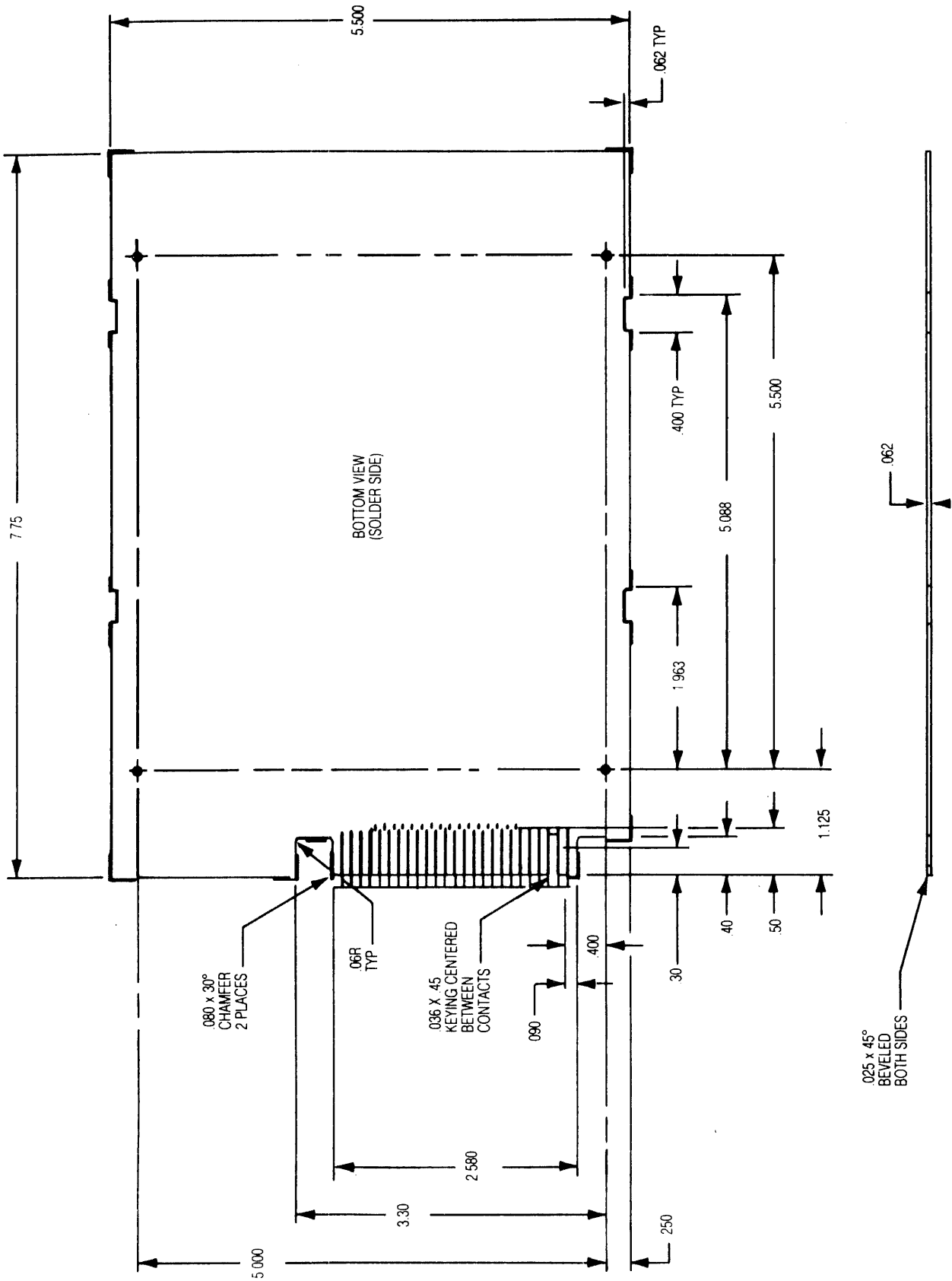

Figure 8.5 Stand Alone Controller Outline Drawing

APPENDIX A

EXTENDED FORMAT AND COMMAND CAPABILITIES (QIC-24)

A.1 GENERAL

Archive Intelligent 1/4-inch Tape Drive versions 5320L-2, 5920L-2 and 5945L-2 have extended format capabilities. The drive is able to use one of two data formats: the QIC-11 format as described in section 5 or the QIC-24 format as described in this appendix. The main difference between the formats is the QIC-24 expanded (4 bytes) block address capability. Commands for both QIC-11 and QIC-24 are the same, however the command set as described in section 6 has been expanded to include the SET FORMAT command. This command allows the device to operate in either the QIC-11 or QIC-24 format. The command is further explained in paragraph A.3.

A.2 QIC-24 FORMAT

The formatting of tape in the QIC-24 standard recording pattern provides an industry accepted basis for information interchange between information processing systems, communications systems and associated equipment using the 1/4-inch magnetic tape cartridge.

A typical format pattern as written during normal streaming operation contains 531.5 to 551 bytes of bit serial data (Figure A.1.)

Variations of this pattern which occur to accommodate other than optimum streaming mode conditions are enumerated in the QIC-24 REV D Format standard available through the Archive Corporation.

A.3 SET FORMAT (0010 011P)

These commands will set the device to operate in either the QIC-11 or QIC-24 format. If the least significant bit is a one the QIC-24 format will be selected. If the least significant bit is a zero the QIC-11 format will be selected. These commands are legal only when the drive is logically at BOT. If not at BOT, EXCEPTION is asserted with ILLEGAL COMMAND status. Attempting to read while the wrong format is selected will result in an error condition with EXCEPTION asserted and a NO DATA DETECTED status.

In regard to the SET FORMAT commands it should be noted that a power up or a RESET of the device will select the hardware default format as defined by a jumper located on the controller/formatter. The pins designated CC (Figure A.2) on the 20 pin jumper block control the default. If the jumper is installed the device will default to the QIC-24 format. If the jumper is not installed the device will default to the QIC-11 format.

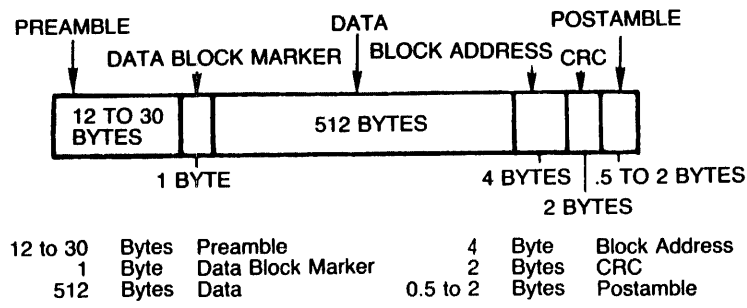

Figure A.1 QIC-24 1/4-Inch Streaming Tape Format

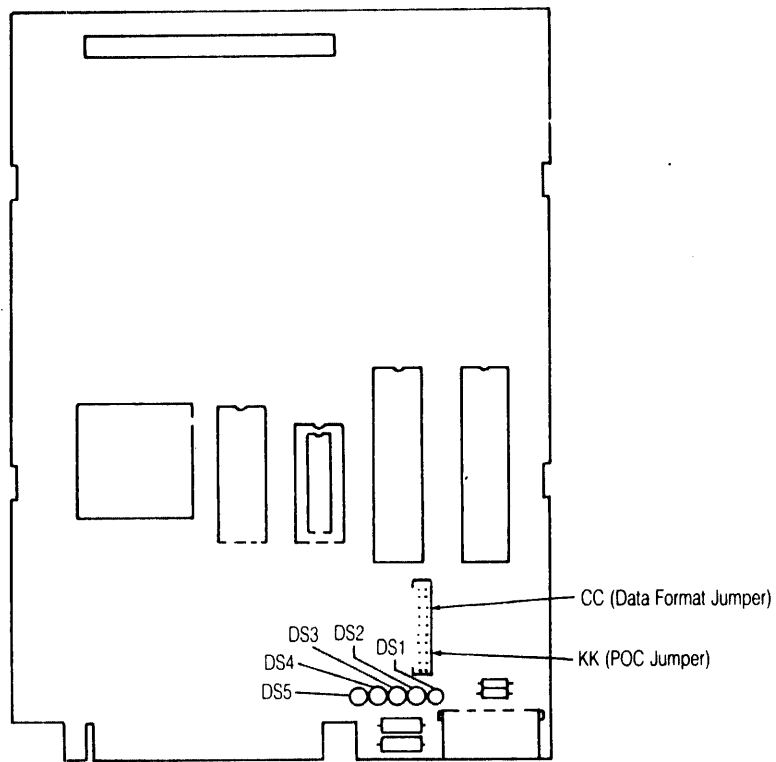

Figure A.2 Location of Jumpers CC and KK and LEDs DS1, DS2, DS3, DS4, and DS5

Every effort has been made to ensure the technical accuracy and consistency of the material contained in this manual. Should you discover any inconsistencies or have any comments on the contents, please address them to:

**Archive Corporation
Technical Publications
3540 Cadillac
Costa Mesa, CA 92626**