

Burroughs

**User's
Manual**

ET 1000 Series
**Ergonomic
Workstations**

(Relative to release level 8.0)

Distribution Code SM

Priced Item
Printed in U.S.A.
February 1985

1182144

**User's
Manual**

**ET 1000 Series
Ergonomic
Workstations**

(Relative to release level 8.0)
Copyright © 1985, Burroughs Corporation, Detroit, Michigan, 48232

Burroughs cannot accept any financial or other responsibilities that may be the result of your use of this information or software material, including direct, indirect, special or consequential damages. There are no warranties extended or granted by this document or software material.

You should be very careful to ensure that the use of this software material and/or information complies with the laws, rules, and regulations of the jurisdictions with respect to which it is used.

The information contained herein is subject to change without notice. Revisions may be issued to advise of such changes and/or additions.

Warning: This equipment generates, uses, and can radiate radio frequency energy and if not installed and used in accordance with the instructions manual, may cause interference to radio communications. It **HAS** been tested and found to comply with the limits for a Class A computing device pursuant to Subpart J of Part 15 of FCC Rules, which are designed to provide reasonable protection against such interference when operated in a commercial environment. Operation of this equipment in a residential area is likely to cause interference in which case the user at his own expense will be required to take whatever measures may be required to correct the interference.

Correspondence regarding this publication should be forwarded, using the Documentation Evaluation Form at the back of the manual, or remarks may be addressed directly to Burroughs Corporation, Corporate Product Information East, 209 W. Lancaster Ave., Paoli, PA 19301, U.S.A.

LIST OF EFFECTIVE PAGES

Page	Issue
iii	Original
iv	Blank
v thru ix	Original
x	Blank
1-1 thru 1-4	Original
2-1 thru 2-28	Original
3-1 thru 3-11	Original
3-12	Blank
4-1 thru 4-20	Original
5-1 thru 5-6	Original
6-1 thru 6-7	Original
6-8	Blank
7-1 thru 7-9	Original
7-10	Blank
8-1 thru 8-5	Original
8-6	Blank
9-1 thru 9-7	Original
9-8	Blank
A-1	Original
A-2	Blank
B-1	Original
B-2	Blank
C-1 thru C-3	Original
C-4	Blank
D-1 thru D-12	Original
E-1 thru E-3	Original
E-4	Blank
F-1	Original
F-2	Blank
G-1	Original
G-2	Blank
H-1, H-2	Original
I-1	Original
I-2	Blank
J-1 thru J-15	Original
J-16	Blank
K-1 thru K-7	Original
K-8	Blank
L-1	Original
L-2	Blank
M-1, M-2	Original
1 thru 3	Original

TABLE OF CONTENTS

Section	Title	Page
	INTRODUCTION.....	ix
1	THE SYSTEM.....	1-1
	System Controls and Indicators.....	1-2
	System Features.....	1-3
	Ergonomics.....	1-3
	Keyboard.....	1-3
	Data Communications Interface.....	1-3
	Confidence Testing.....	1-3
	Display.....	1-3
	Configuration Control.....	1-3
	Auxiliary Printer.....	1-3
	Highlighting.....	1-3
	Editing Functions.....	1-4
	Forms.....	1-4
	Key Programming.....	1-4
2	INSTALLATION.....	2-1
	What You Need to Know Before Proceeding.....	2-2
	Contents of the Carton.....	2-3
	Unpacking the Unit.....	2-4
	Installing and Interconnecting Terminal Components.....	2-6
	Attaching Data Communications (Optional).....	2-9
	Note on Special (Two Wire Direct) Burroughs Cabling..	2-10
	Note on Common Data Communications Cabling.....	2-11
	Installing the Signal Cables	
	(When Your Terminal is Last Unit on Line).....	2-12
	Installing the Signal Cables	
	(When Your Terminal is Not Last Unit on Line).....	2-14
	Data Communications (TDI).....	2-17
	Data Communications (RS232C).....	2-18
	Data Communications (BDAA).....	2-19
	Installing the Power Cord.....	2-22
	Turning on the Terminal.....	2-23
	Troubleshooting.....	2-26
	Maintenance.....	2-27
3	KEYBOARD AND KEY FUNCTIONS.....	3-1
	The Keyboard.....	3-1
	Keyboard Indicators.....	3-1
	Key Functions Chart.....	3-2
	Key Functions (Further Defined).....	3-8

TABLE OF CONTENTS (CONT.)

Section	Title	Page
4	TERMINAL CONFIGURATION.....	4-1
	The Configuration Menu.....	4-1
	Displaying the Configuration Menu.....	4-1
	Changing Configuration Menu Options.....	4-4
	Address.....	4-4
	Buffer.....	4-4
	DCOM.....	4-6
	Print.....	4-9
	Edit.....	4-11
	Screen.....	4-16
	Semi-Permanent Configurations.....	4-18
	Directly Changing the Configuration Table.....	4-19
	Reconfiguration Error Checks.....	4-19
5	BUFFER CONTROL.....	5-1
	Keystroke Buffer.....	5-2
	Softkey Buffer.....	5-3
	Display Buffer.....	5-4
	Data Comm Buffer.....	5-5
	Printer Buffer.....	5-6
6	DEFINING KEY FUNCTIONS (KEY PROGRAMMING).....	6-1
	Semi-Permanent/Permanent Softkey Buffers.....	6-2
	Programming a Key.....	6-3
	Correcting Key Programming Mistakes.....	6-4
	Using a Programmed Key in Another Sequence.....	6-4
	Programming a Key to Its Original Function.....	6-5
	Data Comm Procedures.....	6-6
	Method 1.....	6-6
	Method 2.....	6-7
7	DESIGNING PAGES (FORMS MODE).....	7-1
	Left-Justified Text Fields.....	7-1
	Right-Justified Text Fields.....	7-2
	Protected Text Field.....	7-2
	Ending a Text Field.....	7-2
	Entering Forms Mode.....	7-2
	Exiting Forms Mode.....	7-2
	Sample Form.....	7-3
	Operating Modes.....	7-4
	Control Mode.....	7-4
	Edit Mode.....	7-5
	Keyboard Text Entry.....	7-5
	Data Comm Text Entry.....	7-6
	Forms Mode.....	7-6
	Local Mode.....	7-6
	Read/Write Mode.....	7-7
	Receive Mode.....	7-7
	Search Mode.....	7-7
	Transmit Mode.....	7-9

TABLE OF CONTENTS (CONT.)

Section	Title	Page
8	PRINTER CONTROL.....	8-1
	Screen Print.....	8-1
	Print/Aux Print.....	8-2
	Print Sequences for Print/Aux.....	8-3
	Serial Printer Connector Pinouts.....	8-4
	Extended Character Sets.....	8-4
	Diacritics.....	8-5
	Auxiliary Input.....	8-5
9	CONTROL AND ESCAPE SEQUENCES.....	9-1
	Control Sequences.....	9-2
	Escape Sequences.....	9-5
A	STANDARD US ASCII CHART.....	A-1
B	DATA COMM MESSAGE CHART.....	B-1
C	KEY AND CURSOR PROGRAMMING.....	C-1
	Function Codes.....	C-2
	Programmable Cursor and Select Page Control.....	C-3
D	CONFIGURATION TABLE.....	D-1
E	TERMINAL TESTS.....	E-1
	Confidence Test Routines (CTR).....	E-1
	Maintenance Test Routines (MTR).....	E-1
F	COMMONLY USED CTRL H SEQUENCES.....	F-1
G	PAGES OF DISPLAY TABLE.....	G-1
H	SO/SI XTN AND SO/SI XLT OPTIONS FOR TEXT RECEIVED FROM AND TRANSMITTED TO DATA COMM.....	H-1
I	MEMORY MAP.....	I-1
J	CONSTRUCTION OF EXTENDED CHARACTERS LANGUAGE VERSIONS...J-1	J-1
K	CONTROL CHARACTER ACTIONS.....	K-1
L	TEXT CHARACTER ENTRY ALGORITHM.....	L-1
M	POINTER ADVANCE ALGORITHM.....	M-1
	INDEX.....	1

LIST OF ILLUSTRATIONS

Figure	Title	Page
4-1	Typical Configuration Menu.....	4-3
5-1	Buffer Interface.....	5-1
5-2	Keystroke Buffer Interface.....	5-2
5-3	Softkey Buffer Interface.....	5-3
5-4	Display Buffer Interface.....	5-4
5-5	Data Comm Buffer Interface.....	5-5
5-6	Printer Buffer Interface (Screen Print).....	5-6
5-7	Printer Buffer Interface (Print/Aux Print).....	5-7
8-1	Screen Print Sequence.....	8-3
8-2	Print/Aux Print Sequence.....	8-4

LIST OF TABLES

Table	Title	Page
2-1	RS232C Interface (Upstream).....	2-20
2-2	Concatenation Interface (Downstream).....	2-21
4-1	SO/SI Functional Conditions.....	4-18

INTRODUCTION

If this is your first ET 1000 Series unit, it would be beneficial if you started at the beginning and read through the first few chapters of this manual. This will explain how to get started. If you are already familiar with the ET 1000 Series, it may be helpful to skim through the first few chapters to refamiliarize yourself with the various processes and commands.

Do not turn on the unit unless you are familiar with it.

The ET 1000 Series consists of two basic parts, the Display and the Keyboard. Your unit may have an optional Keypad.

SECTION 1

THE SYSTEM

The Burroughs ET 1000 Series terminal consists of a video display, a keyboard, and an optional keypad. It is designed to be used with a host.

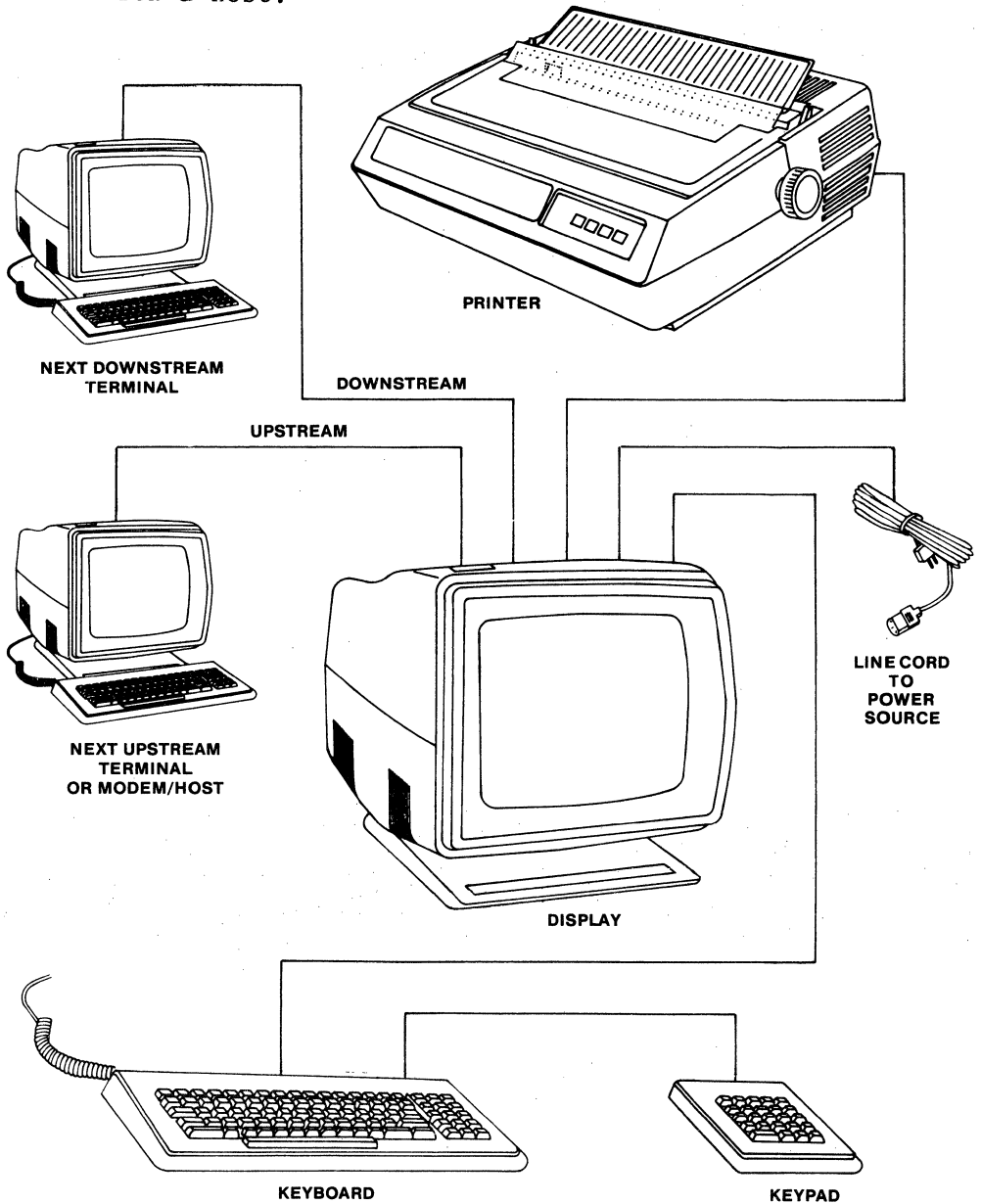

SYSTEM CONTROLS AND INDICATORS

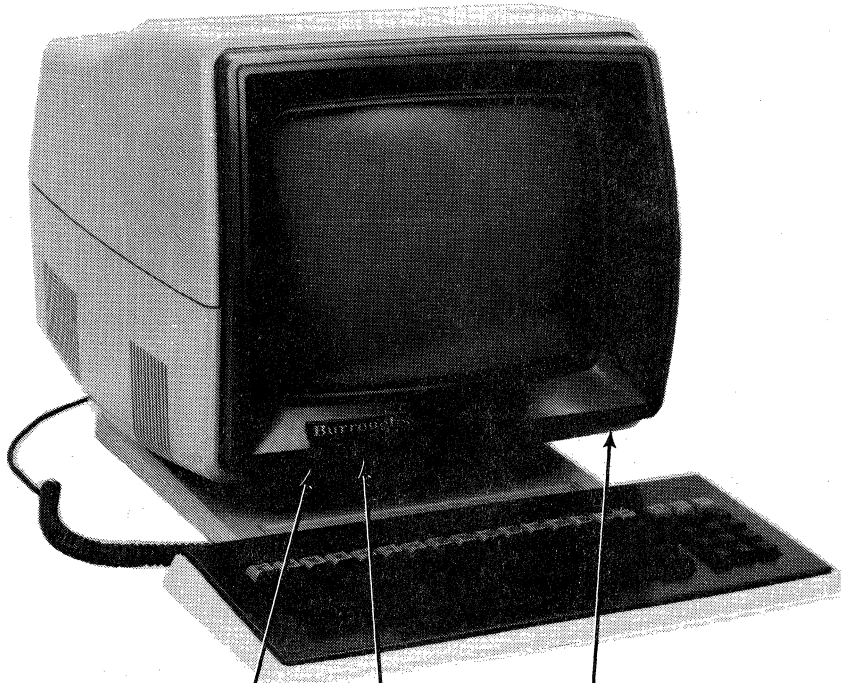

ON/OFF SWITCH

THIS SWITCH ALLOWS POWER FROM THE WALL SOCKET TO BE APPLIED TO THE UNIT. THE '0' IS THE OFF POSITION OF THE SWITCH, AND THE '1' IS THE ON POSITION.

CONTRAST CONTROL

THIS CONTROL VARIES THE DEGREE OF DIFFERENCE BETWEEN THE CHARACTERS AND THE BACKGROUND. WHEN THE CONTRAST CONTROL IS TURNED CLOCKWISE, THE CHARACTERS BECOME DIMMER AND THE SCREEN BECOMES BRIGHTER.

BRIGHTNESS CONTROL

THIS CONTROL VARIES THE DEGREE OF SCREEN AND CHARACTER HIGHLIGHT. WHEN THE BRIGHTNESS CONTROL IS TURNED CLOCKWISE, BOTH THE SCREEN AND CHARACTERS BECOME BRIGHTER.

SYSTEM FEATURES

Ergonomics

The terminal is designed to meet the increasing demands for optimum user comfort by incorporating tilt and swivel features as well as modern, attractive styling.

Keyboard

The alphanumeric keyboard and optional keypad have adjustable tilt mechanisms. The keyboard has seven indicators used to enable the operator to determine the mode of the terminal. Audible "click" and "alarm" functions are independently adjustable to three distinct levels, or these can be turned off.

Data Communications Interface

Data Comm is achieved with either asynchronous or synchronous interface compatible with RS232C and TDI or BDAA interface. More than one RS232C multipoint terminal may be connected end-to-end.

Confidence Testing

When the terminal is turned on, internal hardware testing takes place. This gives the operator a high confidence level concerning the proper functioning of the terminal.

Display

The green phosphor display provides fully-formed characters, the choice of 12 or 24 lines of user area, and 40 or 80 characters per line. The display also uses a user status line and a system status line.

Configuration Control

Since operating requirements at each installation are different, the configuration of the terminal can be achieved by keyboard input.

Auxiliary Printer

Hard copy of data can be obtained from a printer by the host, or terminal, with RS232C interface using TTY/RO protocol.

Highlighting

This feature is used to emphasize specific blocks of data or areas of the display. Highlighting can be enabled from the keyboard or the host.

Editing Functions

These functions through the use of keyboard keys or control sequences are used to move the cursor, insert characters, and delete characters.

Forms

This mode can be entered from the keyboard or the host. The forms page is divided into two types of fields: protected and unprotected. Protected fields cannot be modified; unprotected fields can be modified.

Key Programming

With the exception of the SHIFT key, all keys may be permanently or semi-permanently programmed to perform a function other than the originally assigned function.

SECTION 2

INSTALLATION

This section describes how to unpack and connect the components. The steps of installation are as follows:

1. Unpack the components.
2. Attach the optional keypad to the keyboard.
3. Attach the keyboard to the video display.
4. Attach a printer to the video display.
5. Attach the video display to the host.
6. Make sure that the terminal is turned off before plugging it in.
7. Plug the terminal into the wall outlet.

After installation is complete, turn on the terminal and run any of the programs available to you on your system. Consult your system administrator for details of available programs.

The ET 1000 Series terminal allows you to program keys to perform an unlimited variety of functions and tasks, design and use forms for every day use, and print and edit locally.

WHAT YOU NEED TO KNOW BEFORE PROCEEDING

Before proceeding, select a suitable location for the terminal. Make sure there is an area near this location to unpack the components.

The instructions in this manual are written for the first-time installer. If you have difficulty, read the instructions again or ask your system administrator for assistance.

Further assistance may be obtained if you are in a location served by one of the Burroughs telephone hot-lines. If you are in one of these areas, the phone number is found in the large box along with other information regarding this unit. When calling the hot-line, be prepared to give the following information:

- o Model and serial number of your terminal (located under the terminal).
- o Model name of any peripherals (printer or modem) attached to the terminal.
- o Model name of the host to which your terminal is connected.

After you unpack the components, put the packing material back in the large box, then store it for possible future use.

Completion of step 4 (Attach a printer to the video display) requires configuration details from your system administrator and may require the assistance of a qualified field engineer.

CONTENTS OF THE CARTON

Save all packing materials included in the shipping carton for possible future use.

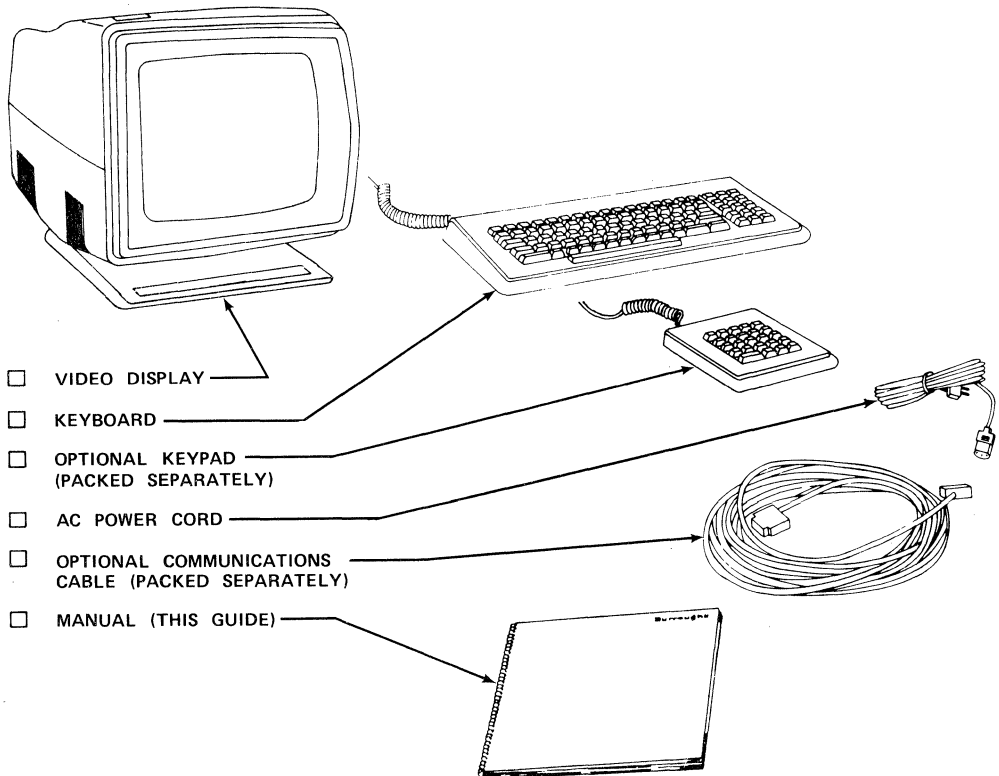

UNPACKING THE UNIT

STEP 1

Remove the keyboard and ac power cord from the box. Place these parts aside until you have positioned the video display on your desk or work area.

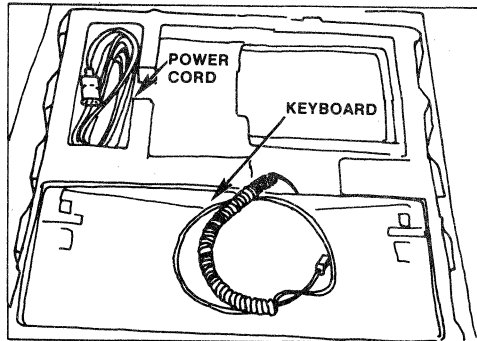

STEP 2

Remove the foam packing from the top of the terminal.

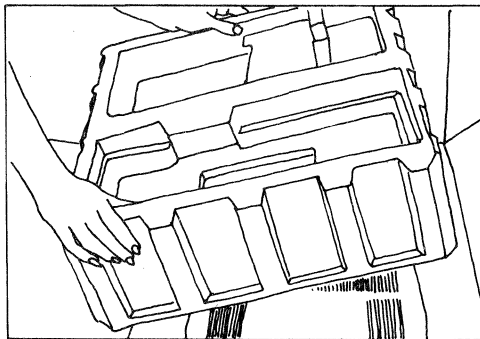

STEP 3

Lift the video display out of the box, and place it in the selected location.

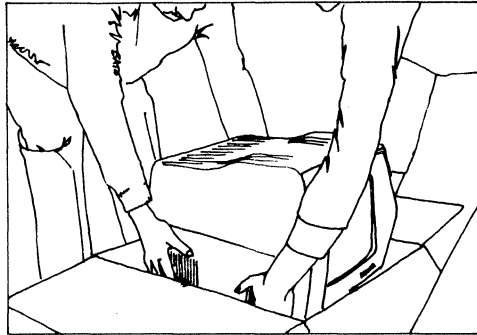

WARNING

The video display weighs 34 pounds (15.42 kg). It should be removed from the box by two people.

STEP 4

Remove the plastic bag from the video display. Remove the foam packing (which prevents the display from tilting) from the base of the terminal.

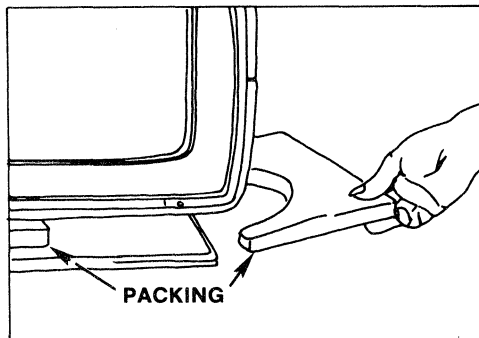

INSTALLING AND INTERCONNECTING TERMINAL COMPONENTS

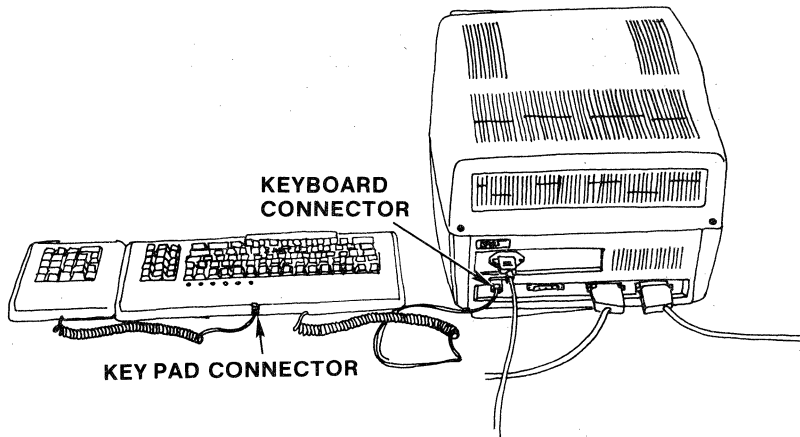

STEP 1

Place the keyboard next to the video display. If the optional keypad is included, connect it as shown in steps 2 thru 4. If there is no keypad, go to step 5.

NOTE

The bottom of the keypad is equipped with a movable plate (the slide connector). This plate, which slides both ways, is used to connect the keypad to either side of the keyboard, as desired by the operator.

STEP 2

On the bottom of the keypad, push in the retaining lugs that hold the slide connector in place. Pull out the slide connector (on the side you have chosen to use), until it "snaps" into its open position.

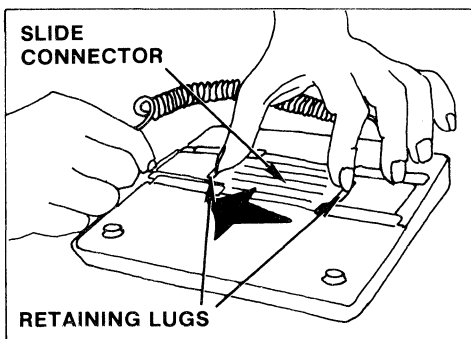

STEP 3

Attach the keypad to the keyboard, as shown in the illustration.

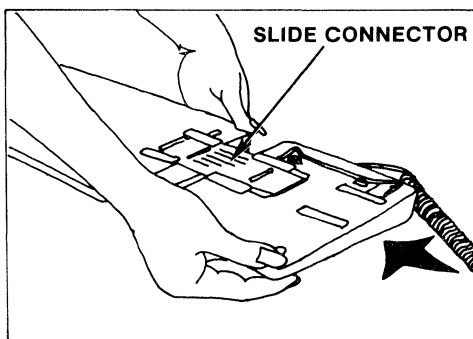

STEP 4

Insert the small, transparent, plastic plug on the end of the coiled keypad cable into the rear of the keyboard.

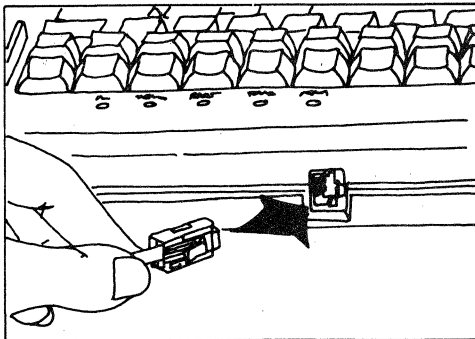

CAUTION

This plug is fragile. Care must be taken not to force it into its receptacle.

STEP 5

Insert the small, transparent plastic plug on the end of the coiled keyboard cable into the connector marked "KBD" on the rear of the video display.

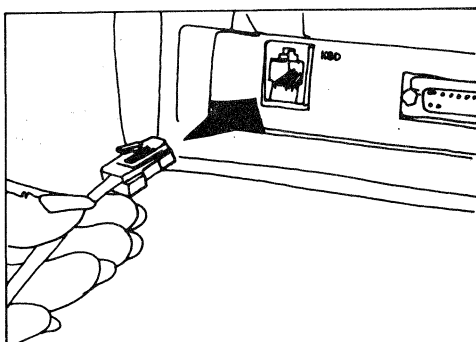

ATTACHING DATA COMMUNICATIONS (OPTIONAL)

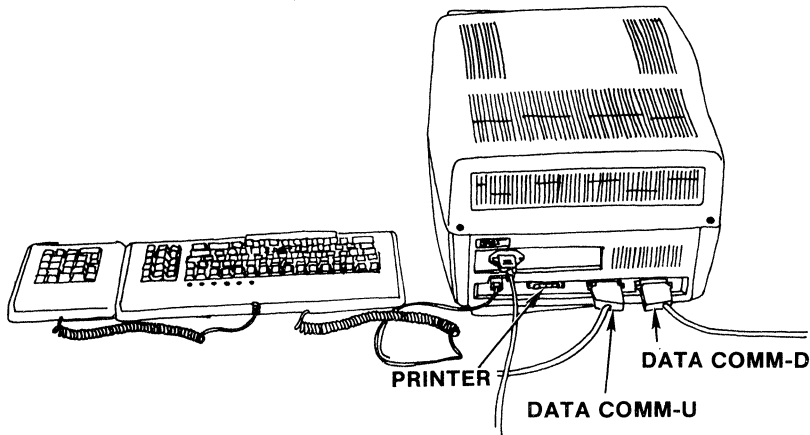

TERMINOLOGY NOTE

Some of the terms used in the following discussion have special meanings. They are defined to enhance your understanding.

- HOST** The Host unit is the computer, word processor, or other similar principal equipment, to which your terminal is attached.
- MODEM** A Modem is a device which enables equipment to communicate over existing telephone lines. Like a telephone, one is used at each end of the line. In this manual, when reference is made to a host in text or illustrations, the use of modems is assumed.

Note On Special (Two Wire Direct) Burroughs Cabling

Some existing Burroughs installations use cables of the type illustrated below:

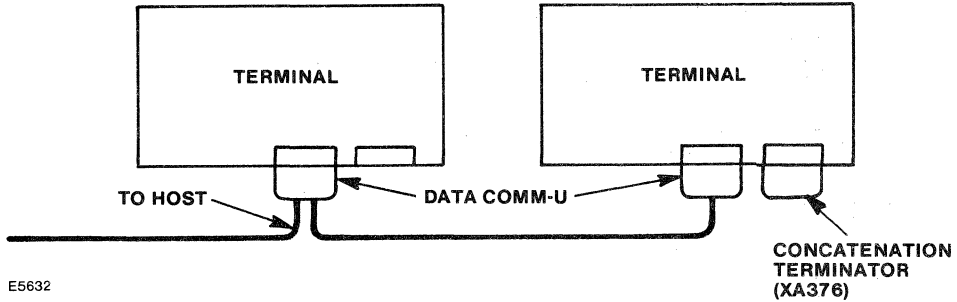

There is only one connection made at the rear of each unit. At each terminal, the cable is attached to the DATA COMM-U socket. Except for TDI, the last terminal requires a CONCATENATION TERMINATOR attachment. This attachment signals the system that this is the last terminal on the line.

If the terminal you are installing is going to take the place of an existing terminal, unplug the existing terminal and plug the same cable connector into the terminal. Refer to Turning on the Terminal described later in this section.

If the terminal you are installing is going to be added to the system, you will need a cable that is custom built by a Burroughs field engineer. Contact your Burroughs support representative for details.

Note On Common Data Communications Cabling

Most Data Communications installations use cabling of the type illustrated below:

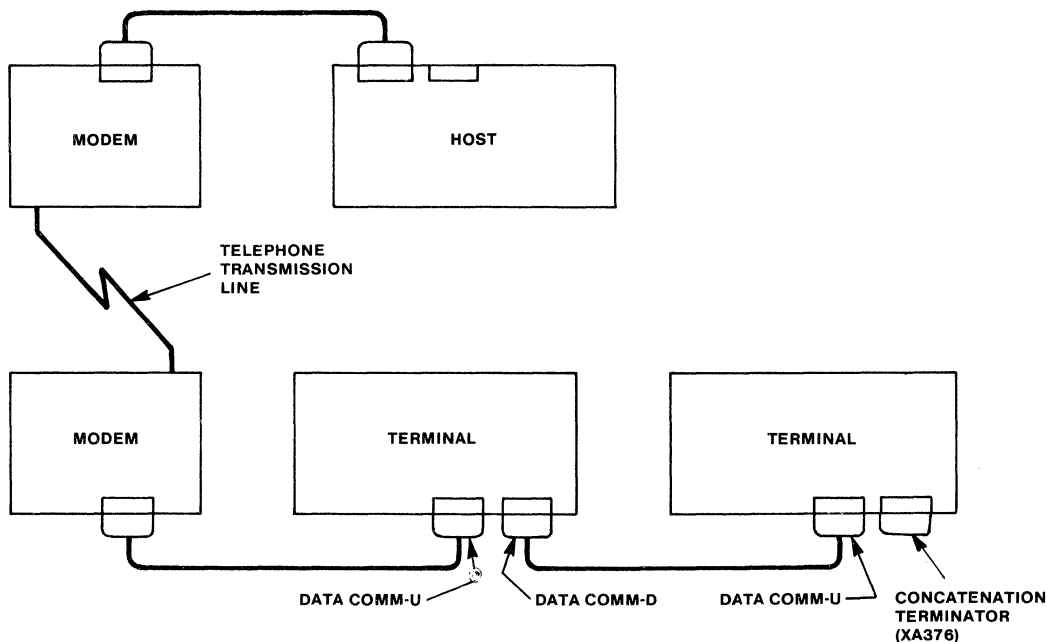

E5633

The two cable connectors at the rear of the unit are used. One, labeled **DATA COMM-U**, is used for the cable that is also connected to the telephone interface unit (modem). The other, labeled **DATA COMM-D**, is used for the cable that is also connected to another terminal -- when there is another terminal further down the line.

Notice the **CONCATENATION TERMINATOR (XA376)**. It is needed on the last terminal when it is concatenated from a modem or from another terminal.

INSTALLING THE SIGNAL CABLES (When your terminal is last unit on line)

If the terminal you are installing is the last terminal on the line, attach the signal cables (ordered separately) as follows:

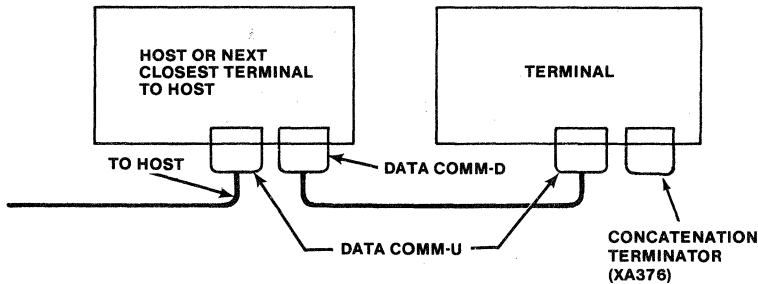

NOTE: REFER TO "DATA COMMUNICATIONS" SUBSECTION FOR CABLE LENGTH.

E5634

NOTE

Refer to Data Communications in this section for cable length.



STEP 1 (At the host or next closest terminal to the host)

Note that one end of the cable has 25 pins. Insert this connector into the DATA COMM-D receptacle at the rear of the host (or next closest terminal terminal to the host).

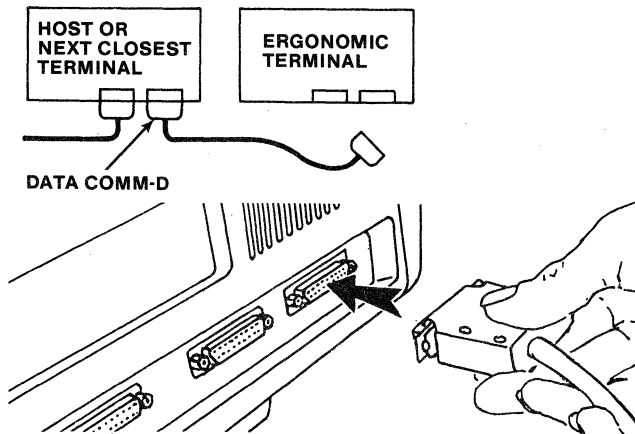

E5635

STEP 2 (At your terminal)

Note that the other end of the cable has 25 pencil-point-sized receptacles. Insert this connector into the DATA COMM-U receptacle at the rear of the terminal you are installing.

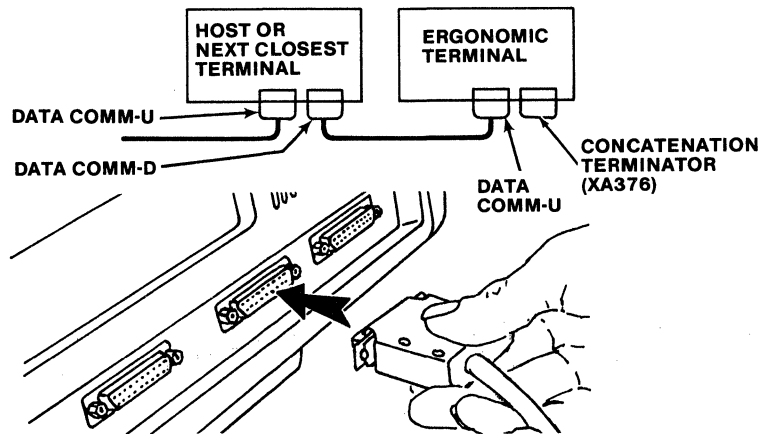

E5636

STEP 3

Secure both connectors by tightening their retaining thumbscrews. (Note that some cable connectors are not fitted with thumbscrews, and a screwdriver may be needed.)

STEP 4

Attach and secure the CONCATENATION TERMINATOR (XA376) to the receptacle at the farthest rear right of the terminal. Tighten using thumbscrews or screwdriver, as necessary.

INSTALLING THE SIGNAL CABLES (When your terminal is not last unit on line)

If the terminal you are installing is **not** the last terminal on the line -- it is located between the host and printer, disk unit, or another terminal -- attach the signal cable as follows:

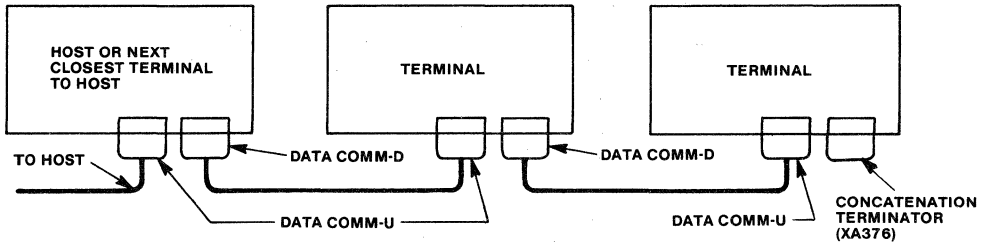

E5637

NOTE

Refer to Data Communications in this section for cable length.

□ STEP 1 (At the host or next closest terminal to the host)

At the rear of the host (or next closest terminal to the host), remove the cable connector from the DATA COMM-D connector.

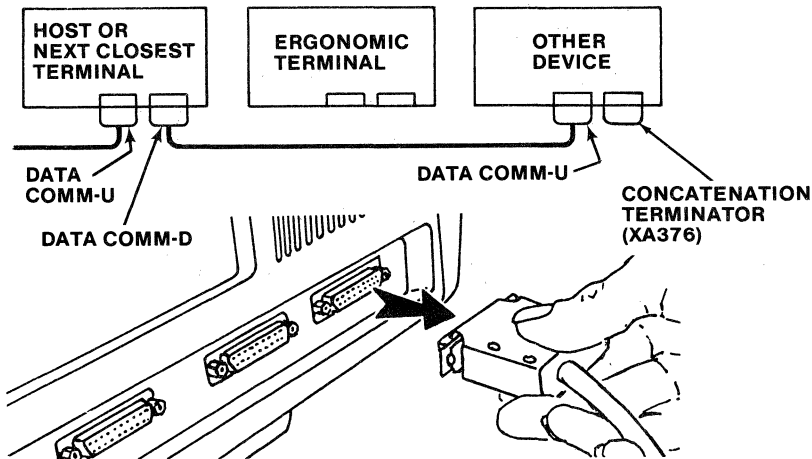

E5638

□ STEP 2

Attach the cable connector you just removed in step 1 to the DATA COMM-D connector at the rear of the terminal you are installing.

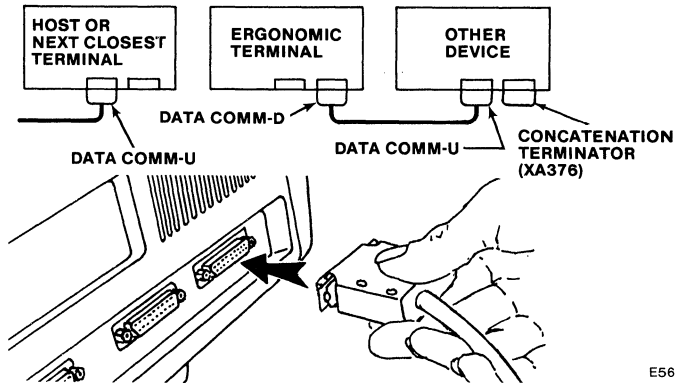

E5639

□ STEP 3

Note that one end of the cable has 25 pins. At the rear of the host (or next closest terminal to the host), insert this connector into the DATA COMM-D connector.

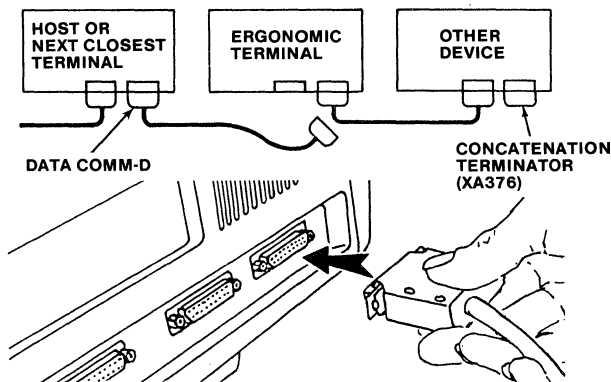

E5640

STEP 4

Note that one end of the cable has 25 pencil-point-sized receptacles. At the rear of the terminal you are installing, insert this connector into the 25-pin DATA COMM-U receptacle.

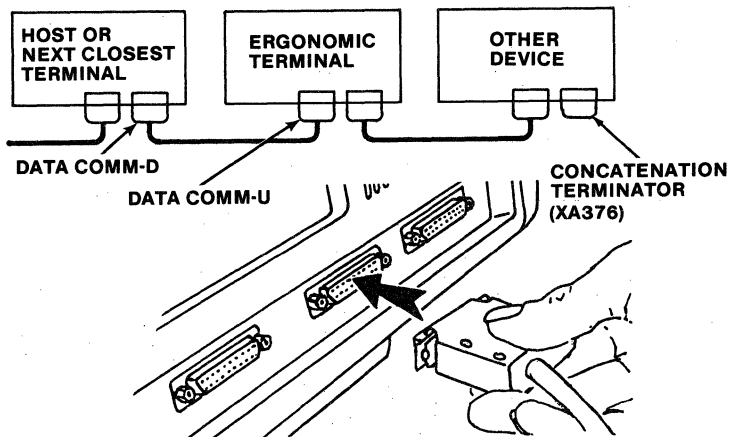

E5641

STEP 5

Secure both connectors by tightening their retaining thumbscrews. (Note that some cable connectors are not fitted with thumbscrews, and a screwdriver may be needed.)

NOTE

If a printer is being installed along with your terminal, perform the printer installation at this time.

DATA COMMUNICATIONS (TDI)

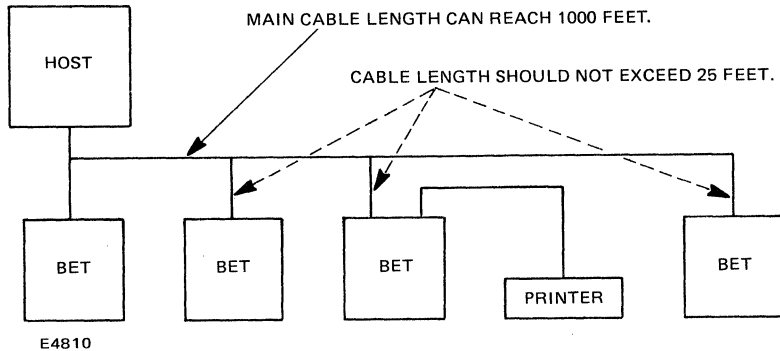

Figure 2-1. System Interconnection-TDI Option 1

- o Maximum baud rate is 9600.
- o Maximum cable length for main cable should not exceed 1,000 feet.
- o Maximum cable length from main cable to individual terminals should not exceed 25 feet.
- o Maximum number of terminals should not exceed 9.

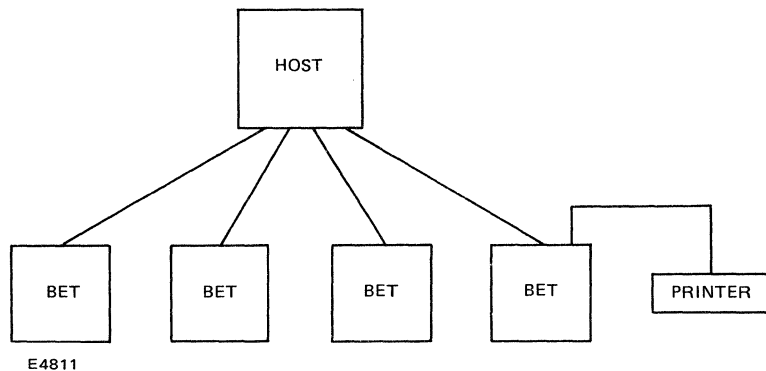
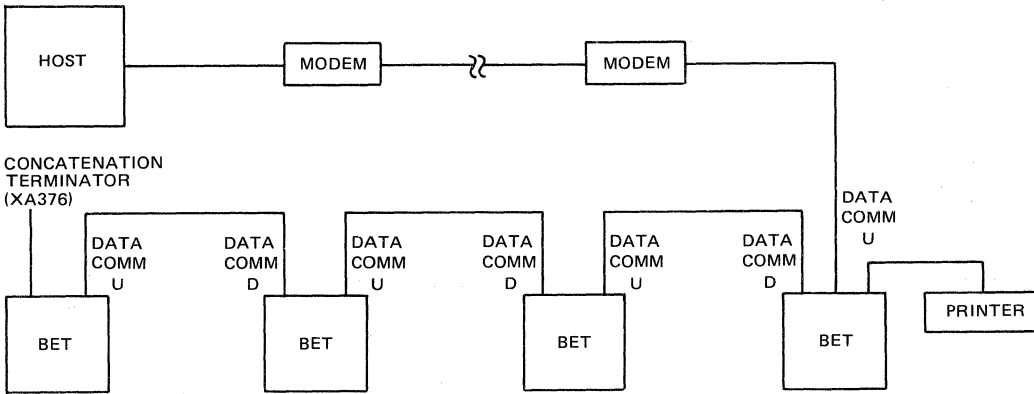

Figure 2-2. System Interconnection-TDI Option 2

DATA COMMUNICATIONS (RS232C)



E4812

Figure 2-3. System Interconnection-RS232C

- o Maximum length between the first terminal and the modem should not exceed 50 feet.
- o Maximum length between powered on terminals should not exceed 100 feet.
- o Synchronous terminal limitations:
 - 1 terminal at 38.4K baud
 - 2 terminals at 19.2K baud
 - 4 terminals at 9600 baud
 - 8 terminals at 4800 baud
- o Asynchronous terminal limitations:
 - No limitation other than consideration of throughput delay.

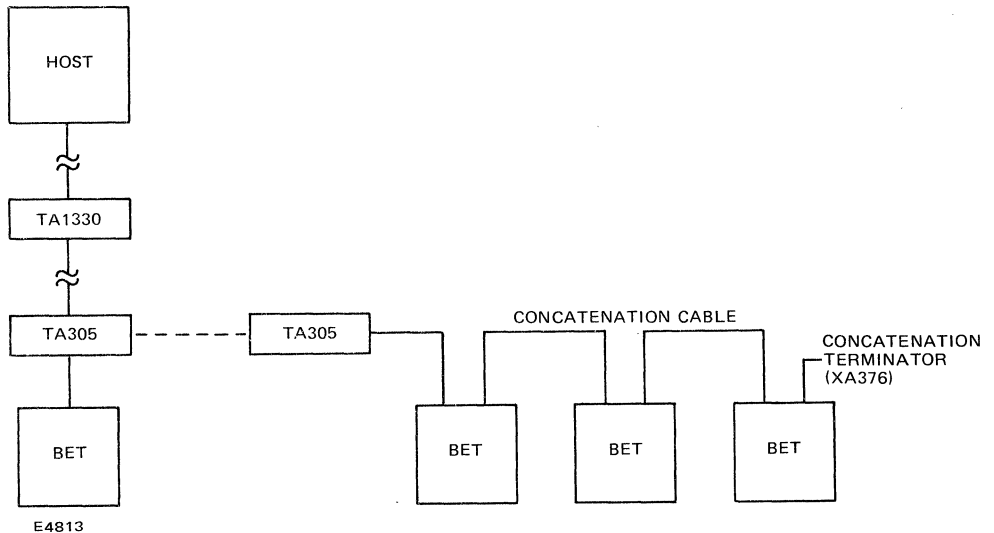
DATA COMMUNICATIONS (BDAA)**Figure 2-4. System Interconnection-BDAA**

- o Maximum baud is 38.4K.
- o Maximum number of terminals should not exceed 64.
- o Maximum cable length should not exceed 15,000 feet.
- o Maximum cable length from the function box to the first terminal should not exceed 25 feet.

Table 2-1. RS232C Interface (Upstream)

Pin	RS232C	ET 1000	Description
1	AA	framegnd	protective ground (TDI/BDAA)
2	BA	BA	transmitted data (TDI/BDAA)
3	BB	BB	received data (BDAA)
4	CA	CA	request to send
5	CB	CB	clear to send
6	CC	CC	data set ready
7	AB	GND	signal ground (TDI/BDAA)
8	CF	CF	data carrier detect
9	--	--	--
10	--	--	--
11	--	CH	rate selector 111/126
12	--	--	--
13	--	--	--
14	--	--	--
15	DB	DB	transmit clock (DCE)
16	--	--	--
17	DD	DD	receiver clock (DCE)
18	--	--	--
19	--	--	--
20	CD	CD	data terminal ready
21	--	--	--
22	--	--	--
23	CH	CH	data signal rate sel (DTE) (111)
24	--	CCITT116	select standby (116)
25	--	--	--

Table 2-2. Concatenation Interface (Downstream)

Pin	RS232C	ET 1000	Description
1	AA	framegnd	protective ground
2	BA	DWNST MBA	transmitted data
3	BB	DWNST MBB	received data
4	CA	DWNST MCA	request to send
5	CB	DWNST RCB	clear to send
6	CC	DWNST MCC	data set ready (+V)
7	AB	GND	signal ground
8	CF	DWNST MCF	data carrier detect (+V)
9	--	--	--
10	--	--	--
11	--	--	--
12	--	--	--
13	--	--	--
14	--	--	--
15	DB	DWNST MDB	transmit clock (DCE)
16	--	--	--
17	DD	DWNST MDD	receiver clock (DCE)
18	--	--	--
19	--	--	--
20	CD	DWNST MCD	data terminal ready
21	--	--	--
22	--	--	--
23	--	--	--
24	--	--	--
25	--	--	--

INSTALLING THE POWER CORD

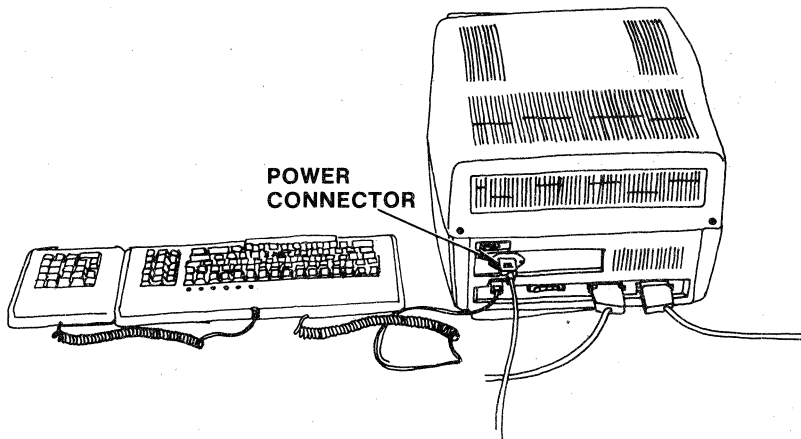

STEP 1

Locate the ac power cord and insert it into the connector on the rear of the terminal. Note the location of the fuse to the left of the connector.

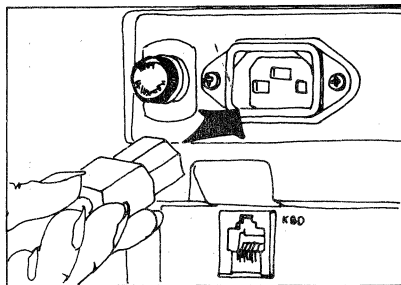

STEP 2

Plug the power cord into the ac outlet.

TURNING ON THE TERMINAL

Before turning on the terminal, first read the following steps to familiarize yourself with the sequence of events that will take place when power is applied, then perform each step.

If the terminal does not respond exactly as indicated in these steps, refer to Troubleshooting in this section.

CAUTION

The terminal must be turned off before you begin the following procedure. Check the power ON/OFF switch.

The power ON/OFF switch (labeled "1" for ON, and "0" for OFF) is located under the right front corner of the video display cabinet. The keyboard lights should not be on when the power is off; if any are on, simply turn off the power switch.



STEP 1

Set the power ON/OFF switch to the ON position. Observe that the keyboard lights come on.

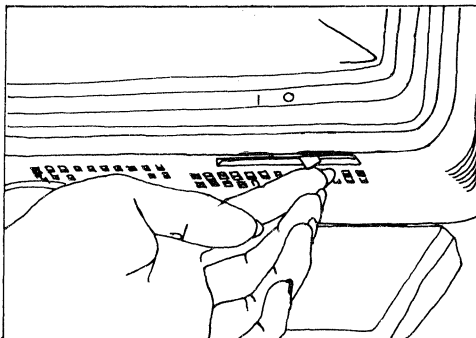

STEP 2

Observe that the indicator lamps stay on for a few seconds, then go off (confidence test is in progress).

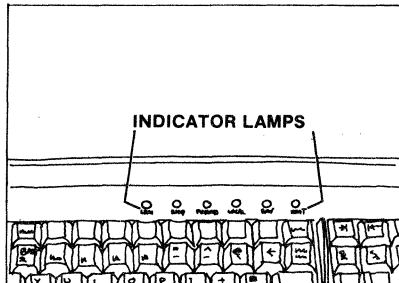

STEP 3

After approximately fifteen (15) seconds, the video display screen is filled with characters several times.

STEP 4

Observe that the video display goes blank and a few seconds later the six asterisks appear. (The confidence test has been successfully completed, and the terminal is ready to operate.)

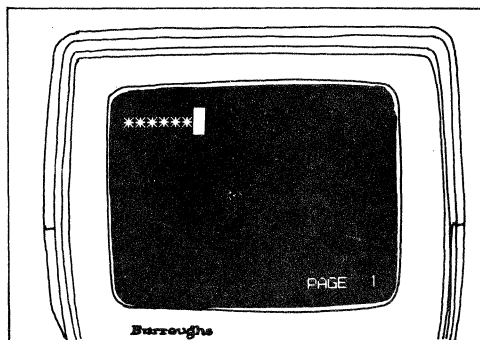

STEP 5

Under the left-front corner of the video display, locate the Brightness and Contrast thumbwheel controls (Brightness on left, Contrast on right.)

STEP 6

Adjust the Brightness and Contrast controls until the display is comfortable to view.

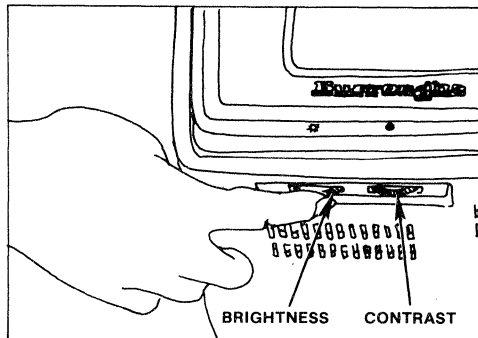

TROUBLESHOOTING

This chart may help you to answer some questions concerning the operation of the terminal. The left column lists some typical problems. The right column presents actions which may eliminate the problem. If you are unable to correct the problem with information listed in this chart, contact your Burroughs representative for assistance.

Problem

Action

The terminal will not work. Keyboard lights do not come on when the unit is turned on. There is no image on the screen.

Make sure that the power cord is plugged in.

Make sure that the outlet has power.

If power cord is plugged in and the outlet has power, but the terminal still will not work, unplug power cord.

Check the fuse in the terminal. If it is "blown," call your Burroughs service or field engineer.

There is no image on the screen but keyboard lights come on when unit is turned on.

Check the brightness control. It may be in its lowest the position.

Make certain you wait at least 30 seconds after you turn on the unit before you operate it. During this time the unit is completing its confidence test. Pressing a key too soon may cause an undesired effect.

MAINTENANCE

The terminal requires a minimum of user attention to ensure its trouble-free operation. The following suggestions should help to maximize your use and enjoyment of the system.

- o The surfaces of the equipment (screen, display cabinet, keyboard) should be cleaned, as required, using a clean, damp, lint-free cloth. In difficult cases, a cloth dampened with rubbing alcohol may be used to clean the screen.
- o Avoid spillage problems by keeping liquids a safe distance away from the terminal.
- o Keep paperclips, pins, eraser rubbings, and so on, away from the top of the display cabinet, the keyboard, and the optional keypad.
- o Discourage the use of the terminal by anyone who has not read and understood this manual.

You should have completed these steps:

1. Connected the optional keypad to the keyboard.
2. Connected the keyboard to the video display.
3. Connected the printer to the video display (optional).
4. Connected the video display to the host.
5. Made sure the ON/OFF switch was in the OFF (0) position before plugging the unit into a power source.
6. Plugged the power cord into the video display, then the wall outlet.
7. Turned on the unit.
8. Witnessed a successful terminal confidence test.
9. Read the Maintenance and Troubleshooting sections.

SECTION 3

KEYBOARD AND KEY FUNCTIONS

THE KEYBOARD

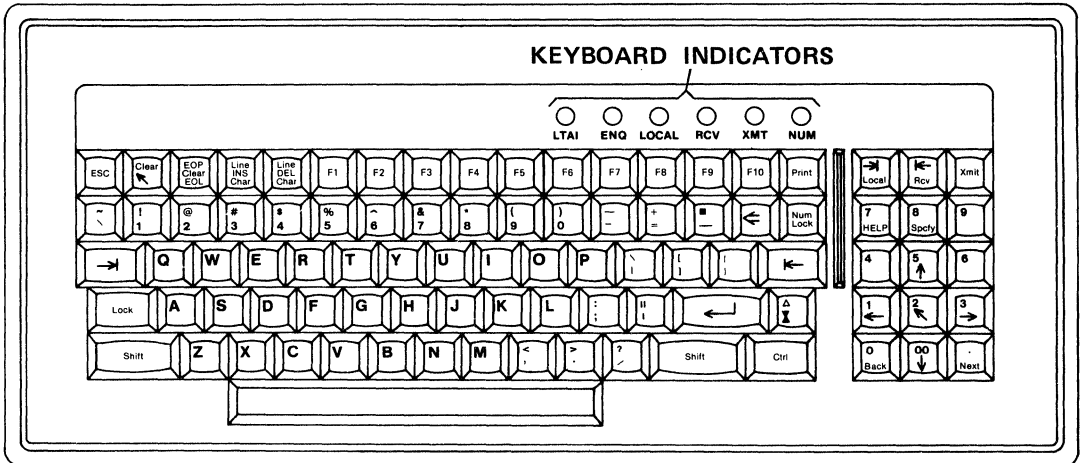





E5644

KEYBOARD INDICATORS

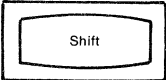
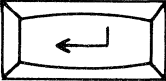

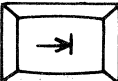
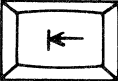
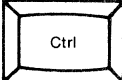

- | | |
|-------|--|
| LTAI | BLINKS WHEN THERE IS DATA COMM LINE ACTIVITY. |
| ENQ | INDICATES A RECEIVED MESSAGE DURING ODT OPERATION. |
| LOCAL | GOES ON WHEN IN LOCAL MODE. |
| RCV | GOES ON WHEN RECEIVING. |
| XMT | GOES ON WHEN TRANSMITTING. |
| NUM | GOES ON WHEN NUM LOCK KEY IS PRESSED. |
| LOCK | GOES ON WHEN THE SHIFTED LOCK KEY IS PRESSED. |

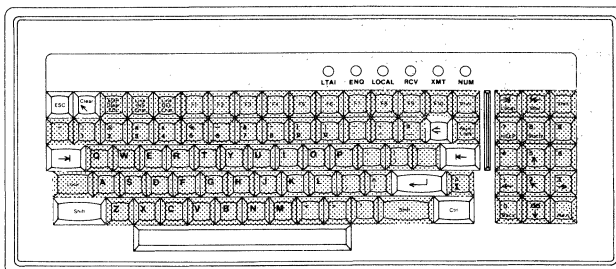
KEY FUNCTIONS CHART

KEY	FUNCTION	
	SHIFTED	UNSHIFTED
<p>SHIFT</p> 	<p>DISPLAYS UPPER-CASE LETTERS, OR ENABLES THE UPPER-CASE FUNCTION.</p>	
<p>RETURN</p> 	<p>RETURNS CURSOR TO NEXT LINE, FIRST COLUMN.</p>	
<p>BACKSPACE</p> 	<p>BACKSPACES LEFT ONE COLUMN.</p>	
<p>TAB</p> 	<p>PREVENTS WRITING TAB CHARACTERS.</p>	<p>TAB MOVES CURSOR TO NEXT RIGHT TAB STOP OR SEARCH CHARACTER.</p>
<p>REVERSE TAB</p> 	<p>REVERSE TAB MOVES CURSOR TO PRECEEDING TAB STOP.</p>	
<p>CONTROL</p> 	<p>LOCKS TERMINAL IN CONTROL MODE CONTINUOUSLY.</p>	<p>LOCKS TERMINAL IN CONTROL MODE ONLY ONCE.</p>
<p>ESCAPE</p> 	<p>USED IN CONJUNCTION WITH OTHER KEYS TO GENERATE CONTROL CODES.</p>	





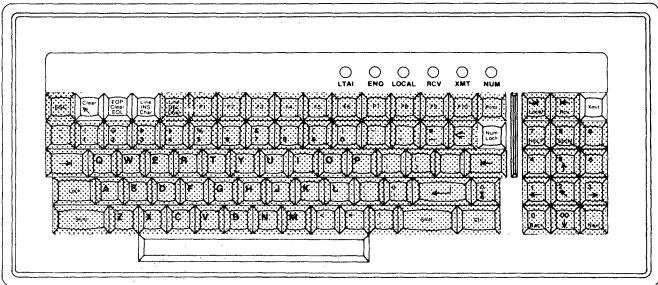

KEY FUNCTIONS CHART (CONT.)

KEY	FUNCTION	
	SHIFTED	UNSHIFTED
<p>TRANSMIT</p> 	<p>CHANGES TERMINAL STATE TO TRANSMIT.</p>	
<p>NUMBER LOCK</p> 	<p>ENABLES NUMBER KEYS IN SHIFTED MODE. (NUM LOCK INDICATOR LIT.)</p>	<p>RESETS NUM LOCK MODE.</p>
<p>CLEAR/HOME</p> 	<p>CLEARs SCREEN AND MOVES CURSOR TO HOME POSITION.</p>	<p>MOVES CURSOR TO HOME POSITION (COLUMN 1, ROW 1).</p>
<p>END-OF-PAGE/ CLEAR/END-OF-LINE</p> 	<p>CLEARs DATA FROM CURSOR TO END-OF-PAGE.</p>	<p>CLEARs DATA FROM CURSOR TO END-OF-LINE.</p>
<p>LINE/INSERT/ CHARACTER</p> 	<p>INSERTs LINE AT CURSOR POSITION.</p>	<p>INSERTs CHARACTER AT CURSOR POSITION.</p>

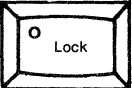





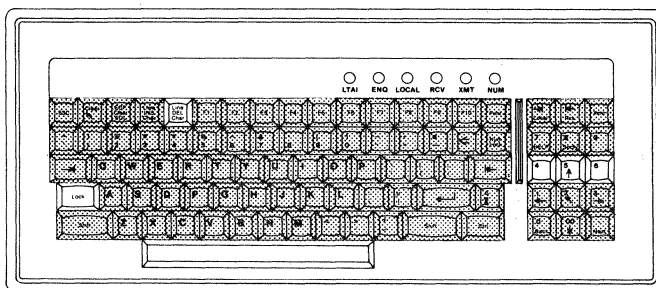

KEY FUNCTIONS CHART (CONT.)

KEY	FUNCTION	
	SHIFTED	UNSHIFTED
<p>LINE/DELETE/ CHARACTER</p> 	<p>DELETES LINE AT CURSOR.</p>	<p>DELETES CHARACTER AT CURSOR.</p>
<p>CAPS LOCK</p> 	<p>CAUSES UPPER CASE ALPHABET CHARACTERS WHETHER SHIFT KEY IS PRESSED OR NOT.</p>	<p>CAUSES LOWER CASE ALPHABET CHARACTERS.</p>
<p>4</p> 	<p>DISPLAYS NUMBER 4.</p>	
<p>5/UP ARROW</p> 	<p>DISPLAYS NUMBER 5.</p>	<p>MOVES CURSOR UP ONE LINE.</p>
<p>6</p> 	<p>DISPLAYS NUMBER 6.</p>	





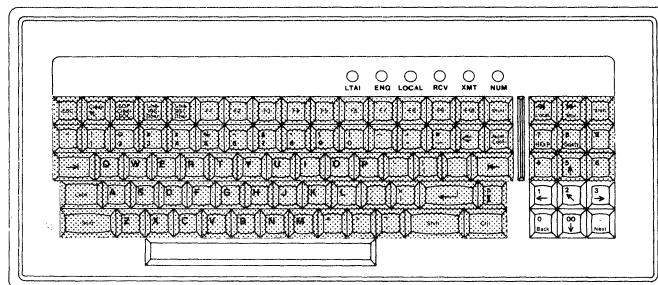

E5631c

KEY FUNCTIONS CHART (CONT.)

	FUNCTION	
	SHIFTED	UNSHIFTED
<p>1/LEFT ARROW</p> 	DISPLAYS NUMBER 1.	BACKSPACE CURSOR LEFT ONE COLUMN POSITION. (IN CONTROL MODE, MOVES BACK ONE PAGE.)
<p>2/HOME</p> 	DISPLAYS NUMBER 2.	MOVES CURSOR TO HOME POSITION (COLUMN 1, ROW 1).
<p>3/RIGHT ARROW</p> 	DISPLAYS NUMBER 3.	MOVES CURSOR ONE POSITION TO THE RIGHT. (IN CONTROL MODE, MOVES FORWARD ONE PAGE.)
<p>0/BACK</p> 	DISPLAYS NUMBER 0.	CAUSES TERMINAL TO DISPLAY PRECEEDING PAGE.
<p>00/DOWN ARROW</p> 	DISPLAYS NUMBERS 00.	MOVES CURSOR TO THE SUCCEEDING LINE. (IN CONTROL MODE, SCROLLS THE PAGE UP.)
<p>./NEXT</p> 	DISPLAYS DECIMAL POINT.	CAUSES TERMINAL TO DISPLAY THE NEXT PAGE.



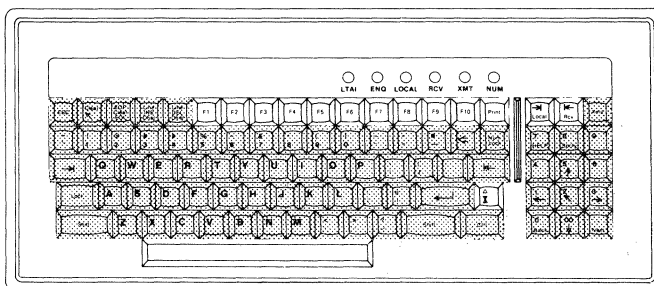

KEY FUNCTIONS CHART (CONT.)

KEY	FUNCTION	
	SHIFTED	UNSHIFTED
<p>END-OF-TEXT/ GROUP SEPARATOR</p> 	<p>STORES GROUP SEPARATOR CODE AT CURSOR POSITION.</p>	<p>CAUSES END-OF-TEXT CODE TO BE DISPLAYED ABOVE CURSOR.</p>
<p>FUNCTION KEYS 1 THRU 10</p> 	<p>PROGRAMMABLE.</p>	<p>PROGRAMMABLE.</p>
<p>PRINT</p> 	<p>INITIATES A SCREEN PRINT WITH A FORM FEED. PRINTS PROTECTED DATA IN FORMS MODE.</p>	<p>INITIATES A SCREEN PRINT WITHOUT A FORM FEED. PRINTS ONLY PROTECTED DATA IN FORMS MODE.</p>
<p>TAB/LOCAL</p> 	<p>TAB MOVES CURSOR TO NEXT TAB STOP.</p>	<p>SETS TERMINAL STATE TO LOCAL.</p>
<p>REVERSE TAB/ RECEIVE</p> 	<p>MOVES CURSOR TO PRECEEDING TAB STOP.</p>	<p>SETS TERMINAL STATE TO RECEIVE.</p>



KEY FUNCTIONS CHART (CONT.)

KEY	FUNCTION	
	SHIFTED	UNSHIFTED
<p>7/HELP</p> 	DISPLAYS NUMBER 7.	APPLICATION DEPENDENT.
<p>8/SPECIFY</p> 	DISPLAYS NUMBER 8.	SENDS CURRENT CURSOR POSITION TO THE HOST.
<p>9</p> 	DISPLAYS NUMBER 9.	

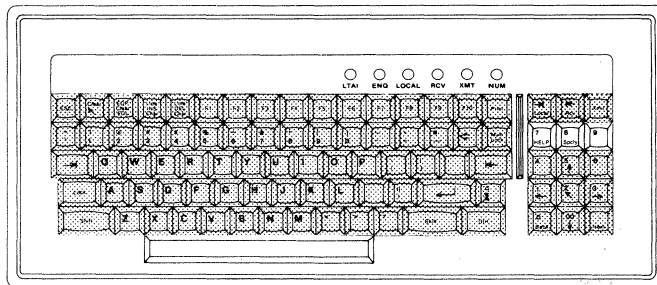

KEY FUNCTIONS (FURTHER DEFINED)

SHIFT

Unshifted/Shifted: Modifies keystroke codes; letter keys yield uppercase codes; other keys are modified as indicated on key tops.

RETURN

Unshifted/Shifted: If 'KBD CR/LF=Y', then returns cursor to first column; if not, to first column only. If 'CR WRITE FROM KYBD=Y', stores code at cursor (unless on protected data in Forms mode).

BACKSPACE

Unshifted/Shifted: Backspaces left one column without deleting the character at that position.

TAB

Unshifted: Moves cursor to next right tab stop, next search character, or the next unprotected field if in Forms mode. If 'HT WRITE FROM KYBD=Y', then stores code at cursor.

Shifted: If Search mode is set, performs skip to next search character or field (if in Forms mode), else same as unshifted.

REVERSE TAB

Unshifted/Shifted: Reverses tab moves cursor to preceding tab stop, or to previous unprotected field if in Forms mode.

CONTROL

Unshifted: Displays 'CTRL' on status line, enables the terminal in Control mode. The terminal is cleared from Control mode at end of a valid CTRL sequence.

Shifted: Displays 'CTRL' on status line, enables the terminal in Control mode. The terminal is not cleared from Control mode, even at end of a valid CTRL sequence.

ESCAPE

Unshifted/Shifted: Stores Escape code at cursor location. Used in conjunction with other keys to generate Control codes.

TRANSMIT

Unshifted/Shifted: Lights XMIT lamp and clears RCV and LOCAL lamps. Changes terminal state to transmit. If in Control mode, does a line-at-a-time XMIT. Sets keystroke lockout.

NUMBER LOCK

Unshifted/Shifted: Enables number keys in shifted mode. (NUM lamp lit.)

CLEAR/HOME

Unshifted: Moves cursor to home position (column 1, row 1), or to first unprotected field if in Forms mode.

Shifted: Clears screen and moves cursor to home position, or clears unprotected fields if in Forms mode.

END-OF-PAGE/CLEAR/END-OF-LINE

Unshifted: Clears data from cursor to end-of-line, or unprotected field from cursor to end-of-field if in Forms mode.

Shifted: Clears data from cursor to end-of-page, or unprotected fields from cursor to end-of-page if in Forms mode and 'CLEAR FORMS=N'.

LINE/INSERT/CHARACTER

Unshifted: Toggles character insertion. Inserts character at cursor position within line. If in Control mode, the scope is the page.

Shifted: Inserts line at cursor line shifting former cursor line and all succeeding lines down. No effect in Forms mode.

LINE/DELETE/CHARACTER

Unshifted: Deletes character at cursor within line. If in Control mode, the scope is the page.

Shifted: Deletes line at cursor inserting one blank line at the end-of-page. No effect in Forms mode.

CAPS LOCK

Unshifted: Causes lowercase alphabet characters.

Shifted: Causes uppercase alphabet characters whether shifted key is pressed or not.

4:

Unshifted: Programmable, no original function.

Shifted: Displays number 4.

5/UP ARROW

Unshifted: Moves cursor up one line. If in Control mode, a scroll up is performed.

Shifted: Displays number 5.

6:

Unshifted: Programmable, no original function.

Shifted: Displays number 6.

1/LEFT ARROW

Unshifted: Backspaces cursor left one column position. If in Control mode, a page back is performed.

Shifted: Displays number 1.

2/HOME

Unshifted: Moves cursor to home position (column 1, row 1). If in Control mode, the mobile home position is set to the cursor position.

Shifted Displays number 2.

3/RIGHT ARROW

Unshifted: Moves cursor one position to the right. If in Control mode, a page forward is performed.

Shifted: Displays number 3.

0/BACK

Unshifted: Causes terminal to display preceeding page.

Shifted: Displays number 0.

00/DOWN ARROW

Unshifted: Moves cursor to the succeeding line. If in Control mode, a scroll down is performed.

Shifted: Displays numbers 00.

./NEXT

Unshifted: Causes terminal to display the next page.

Shifted: Displays decimal point.

END-OF-TEXT/GROUP SEPARATOR

Unshifted: Causes End-of-Text code to be displayed above cursor unless in protected field in Forms mode. If 'Line-At-A-Time Transmit=Y', cursor is moved to mobile home column (same line). If this option is 'N', cursor is moved to mobile home position.

Shifted: Stores Group Separator code at cursor position.

FUNCTIONS KEYS F1 THROUGH F10

Unshifted/Shifted: Programmable, no original function.

PRINT

Unshifted: Initiates a screen print without a form feed. Same as 'CTRL :'. In Forms mode, only unprotected data is printed.

Shifted: Initiates a screen print with a form feed. Same as 'CTRL ;'. In Forms mode, both protected and unprotected fields are printed.

TAB/LOCAL

Unshifted: Sets terminal state to Local. Clears all lamps, then turns on Local lamp. Terminates key programming sequence. Clears Read/Write mode and Control mode. Unlocks keyboard.

Shifted: Same as unshifted TAB; moves cursor to next tab stop or to next unprotected field in a Forms page. If 'HT Writes From KYBD=Y', then stores code at cursor.

REVERSE TAB/RECEIVE

Unshifted: Sets terminal state to Receive, lights RCV lamp, clears Local lamp, aligns data comm cursor to keyboard cursor, and sets keystroke lockout.

Shifted: Same as REVERSE TAB; moves cursor to preceding tab stop or to previous unprotected field in a Forms page.

7

Unshifted: Programmable, no original function.

Shifted: Displays number 7.

8/SPECIFY

Unshifted: Lights XMIT lamp, sends current cursor position to the host in ASCII or HEX, depending on SPECIFY option setting, and aligns data comm pointer to keyboard cursor.

Shifted: Displays number 8.

9

Unshifted: Programmable, no original function.

Shifted: Displays number 9.

SECTION 4

TERMINAL CONFIGURATION

A terminal configuration is a group of options that determines the functional characteristics of that terminal. The first time the unit is turned on, it is necessary to check that the configuration of this terminal is correctly set for the type of work you will be doing. Before setting the configuration for your terminal, read the next few pages carefully.

NOTE: Entering and exiting the menu at any time causes the contents of the display memory to be erased.

THE CONFIGURATION MENU

The configuration options are arranged in a configuration menu. Within the menu, these options are grouped according to specific functions--such as edit functions, screen functions, data comm functions, and so forth. Each option has a preset value (the default). Each default remains in effect unless you alter it.

In the following paragraphs, the options that you will most likely alter are explained first. These are followed by an explanation of the entire configuration menu.

NOTE: As a general rule, any change to the configuration menu should be supervised by the installation or systems manager.

DISPLAYING THE CONFIGURATION MENU

As you read, you will be asked to perform the control sequences in the boxes. A control sequence is a series of keystrokes that instructs the terminal to perform a certain function.

Press the Control key (CTRL) to begin a sequence. This key is located at the bottom right-hand corner near the text keys. It is also located on the optional numeric keypad. Pressing CTRL puts the terminal in Control mode. This is indicated when the word 'CTRL' appears in the bottom right-hand corner of the screen, left of the 'PAGE' indication.

When entering a Control sequence, remember that a word in angle brackets, <>, represents a single key on the keyboard; and when you are instructed to shift, hold the <SHIFT> key down . If you make a mistake entering the Control sequence, press LOCAL until the word 'CTRL' disappears from the bottom right-hand corner of the screen.

Enter the control sequence below to begin the first step in configuring your terminal.

Note: This sequence will not be displayed on the screen.

ENTER:

<CTRL><SHIFT>RWMODE

If you entered the Control sequence correctly, the configuration menu will be displayed on the screen as illustrated on the following page. If the configuration menu does not appear, then the Control sequence was incorrectly entered. Reenter the Control sequence.

```

                                TERMINAL CONFIGURATION MENU
ADDRESS:[00]SCREEN  [  ]GPSELECT  [  ]PRINT/AUX  [  ]GROUP POLL
BUFFERS:[03840]SCREEN [2048]DCOM   [0256]SOFTKEY [0256]KEYBOARD[2048]PRINTER
DCOM:   [ 9600]BPS   [N]SYNC      [N]RS232
        [N]ODT      [N]POINT-TO-POINT [N]MONITOR  [Y]PARITY CHK
        [N]EARLYFILL SCREEN [Y]BEEP ON NAK [000]MIN CTS DELAY
        TRANS NUM [Y]DC1 RCV MODE HOLD [A]SPECIFY KEY
[000]RCV DELAY [N]RTS HOLD [Y]RCV MODE HOLD
[N]CKT 116 [N]CKT 111/126 [N]OPT POL/SEL
PRINT: [ 1200]BPS [Y]PARITY BIT [8]BITS/CHAR [D]AUX INPUT [  ]LOG ACK
[E]PARITY E/O [Y]PARITY CHK [N]2 STOP BITS [N]DELAY AFTER CR/LF
[1]BUSY 0/1 [N]EXTEND LINE [Y]TRANSLATE [N]FILTER [  ]XON/XOFF
EDIT: [Y]AUTO FORMS SKIP [Y]FORMS XMT TO CURSOR
[N]LOWERCASE LOCKOUT [N]DCOM LF->CR [Y]DCOM CR->LF
[1F]OPEN [1E]CLOSE ALT FORM DELIMITER [N]LINE-AT-A-TIME TRANSMIT
[N]SOH CLEAR SCREEN [N]HT [N]CR [N]ETX WRITE FROM DCOM
[Y]CURSOR WRAPAROUND [N]HT [N]CR WRITE FROM KYBD [N]ETX ADV
[Y]FIXED TABS [N]CLEAR FORMS [Y]KBD CR/LF [Y]SOH EXIT FORMS
[N]VT PAGE ADV [N]FF CLR TABS [N]DC2 ADV DCP [N]TAB RETAIN
[024]ROW [080]COL PAGE END ALARM [N]KEYSTROKE BUFFER
[06]RPT RATE [05]RPT DELAY [2]CLICK LEVEL [2]ALARM LEVEL
SCREEN: [Y]60 HZ [R]CURSOR [N]BLINK CURSOR
[80]CHAR/LINE [024]LINE/PAGE [24]LINE/SCREEN
[01]INTL LANG [N]SO/SI XLT [N]SO/SI XTN

```

E5647

Figure 4-1. Typical Configuration Menu

CHANGING CONFIGURATION MENU OPTIONS

At this point, you are ready to alter an option in the configuration menu. The menu is divided into six groups of options. These are the Address, Buffer, DCOM, Print, Edit, and Screen groups.

To alter the terminal configuration, position the cursor to the field showing the option you want to change and type the desired value into the field. Using the TAB keys will quickly position the cursor in the field you want to update.

The following are the option descriptions.

Address

Each item in the ADDRESS group is used in the data comm polling and selecting sequences to distinguish this terminal from other terminals on the data comm line. When you transmit to the host, these addresses are included in the message to identify the sender to the host. Furthermore, when the host sends a message to this terminal, these addresses specify which terminal(s) are to receive the message. The legal characters that should be used in the ADDRESS group are those from columns 20 through 7F of the ASCII chart. Note: Use CTRL (sp) H \$ for an EOT character. Options within this group are:

SCREEN: The two-character address for the keyboard/CRT screen combination. The default is 00.

GPSELECT: A one-character group select character. The default is ~.

PRINT/AUX: The two-character address for the background printer. The default is (sp)!. Note that this is sometimes referred to as the background address.

GROUP POLL: Address of the group of terminals to which this terminal is physically connected on the data comm line. The default value is (EOT,EOT).

Buffer

The BUFFER group represents the size, in bytes, of the buffer or storage area that is set aside for each item. The total number of bytes cannot exceed 24,576 (decimal); each value is entered in decimal. Note: If the softkey buffer is changed to a value other than 256, the key programs will be stored temporarily in a buffer called the temporary softkey buffer. This buffer is only in effect until the terminal is turned off or forced through the confidence test. Refer to Defining Key Functions (Key Programming) for details.

The options within this group are:

- SCREEN:** Information to be displayed is placed in the screen buffer before being displayed. The default is two pages (3840 bytes).
- DCOM:** Information received from the data communications line is placed into the data comm buffer as it is received. Messages being sent out on the line are moved to the data comm buffer immediately before transmission to the host computer. The default is 2048 bytes.
- SOFTKEY:** The current definition of each redefined softkey is stored in the softkey buffer. The default is 256 bytes.
- KEYBOARD:** The size of the area of memory used for storing keystrokes. Used only when <Y> is entered in the option keystroke buffer. The default value is 0256 bytes.
- PRINTER:** Information being sent to the printer is placed in the print buffer before being printed. The default is 2048.

DCOM

The DCOM area of the configuration screen describes the data communications environment for the terminal. Options within this group are:

BPS: The baud is specified here. Legal values are 75, 110, 134.5, 150, 300, 600, 1200, 1800, 2400, 4800, 9600, 19200, and 38400. The default is 9600.

SYNC: If a synchronous line is used, specify [Y] in this field. If the line is asynchronous, specify [N]. For example, BDAA would be [N]. The default is N.

RS232: If RS232C is used, enter Y. If TDI or BDAA is used, enter N. The default is a space, bypassing this terminal.

ODT: Protocol for the computer system operator display terminal. ODT Read/Write mode selected by [Y]. The default is N.

POINT-TO-POINT: Standard ODT protocol uses a special point-to-point data comm network. The default is N.

Note: If ODT is selected, point-to-point must be selected.

MONITOR: Enables the data comm monitor by specifying N. This field cannot be entered as a permanent configuration. When the terminal is turned on, this field is set to N. Pressing the LOCAL key will temporarily stop the mode and pressing RCV or XMT key will start it again.

PARITY CHK: Specify [Y] for receive parity check. Specify [N] to ignore received parity errors. Logitudinal block check characters are checked in either case. The default is Y.

EARLYFILL SCREEN: Messages may be placed on the screen. These messages can be placed either while they are being received from the data communications line, or all at once after the complete message is received. The options depend on the value of this field.

FURTHER EXPLANATION

A [Y] here causes each message to be placed on the screen character by character at the same time it is received from the line. This is usually preferable on low speed lines to cause the terminal operator to think response time is better than it actually is (this is a psychological effect--there is no real difference). The disadvantage of this is that should the message not be successfully received on the first try, the user will see each retry on his screen.

Terminals on high speed communication lines, where a full-screen message only requires a few seconds of line time, usually are configured with an [N] here, so that each message is sent to the screen only after it is completely and successfully received by the terminal. The default is N.

Note: This option should not be set if ESC sequences are received from data comm.

BEEP ON NAK: If you want to be notified that a message is waiting to be transmitted to your terminal, specify [Y] in the BEEP ON NAK field, and the terminal will sound its beeper each time it responds with a NAK to a select. If this beep is not desired, place [N] in this field. The default is Y. Note: If the ALARM LEVEL option is set to 0, a beeper will not be heard.

MIN CTS DELAY: This option specifies the time that the terminal waits after the modem raises clear-to-send until the terminal is allowed to transmit. A right-justified, numeric value between 000 and 255, expressing a time in milliseconds (1/100th of a second), is entered in this field. The default is 000.
Note: A typical Burroughs TDI delay is 1 millisecond.

TRANS NUM: An optional part of poll-select protocol allows a transmission number to be used with each message so that certain types of communication errors will be corrected. If transmission numbers are used, the terminal will ignore them upon reception. Enter [A] or [C] to use the A/C alternation, enter [0] or [1] to use the 0/1 alternation, and leave blank to disable transmission numbers in all transmissions.

DC1 RCV MODE HOLD: If the receipt of a DC1 character anywhere in the message should cause the terminal to remain in the Receive state after message interpretation, then enter a [Y] in this field. Otherwise, an [N] in this field allows all received DC1 characters to be interpreted as "Clear Character From DCP To End Of Line". The default is Y.

SPECIFY KEY: Enter [H] to use the specify key to send hexadecimal values for the cursor location. Enter [A] to send the ASCII code starting with space as indication column one/row one.

RCV DELAY: The amount of time that the terminal waits after transmitting to the host before receiving. A right-justified, numeric value between 000 and 255, expressing a time in milliseconds (1/100th of a second), is entered in this field. The default is 000.

RTS HOLD: Enter [Y] to enable an approximate 3 bit delay in dropping RTS. The default is N.

- RCV MODE HOLD:** After successful receipt of a message from the data communications line, the terminal either remains ready to receive another message (remains in Receive state), or it changes to Local state. Local state prohibits the receipt of another message, but unlocks the keyboard and permits local data entry. If the terminal is to remain in Receive state, enter [Y] in this field. If the terminal should "flip" to Local state after a message is received, enter [N] here. The default is Y.
- CKT 116:** This option selects the signal level for circuit 116. Enter [Y] to enable circuit 116, or [N] to disable the circuit. The default is N.
- CKT111/126:** This option selects the signal level for circuit 111/126. Circuit 111/126 selects the modem speed. Enter [Y] to enable circuit 111/126, or [N] to disable the circuit. The default is N.
- OPT POL/SEL:** Enter [Y] to select the optional POL/SEL character 7B/7C, or [N] to select the standard POL/SEL character 70/71. The default is N.

Print

This group is independent of the data comm line and is used to set the interface between the terminal and the printer. Options within this group are:

- BPS:** The communications rate for the printer interface, in bits per second, is specified in this field. Permitted values are 75, 110, 134.5, 150, 300, 600, 1200, 1800, 2400, 4800, 9600, and 19200. The default is 1200.
- Note:** It is to your advantage to set the printer bps to a speed slightly faster than 10 times the rate the printer prints. This smooths out the operation of the printer interface.
- PARITY ENABLE:** Some printers do not require the parity bit. If the parity is not to be transmitted to the printer, specify [N] in this field. If parity is to be used, specify [Y]. The default is Y.
- BITS/CHAR:** Some printers use other than the standard 7 bit characters; specify 5, 6, 7, or 8 bits per character. The default is 7.

AUX INPUT: Enter [D] to transmit the input device data to the data comm host without screen interpretation or visibility. Enter [S] to interpret the input device data and enter it on the screen at the keyboard cursor. The default is D.

LOG ACK: Any alphanumeric character can be designated to enable this function. When enabled, it causes the terminal to transmit a one-character message to the host/application. This occurs when sufficient room exists in the printer buffer for a second, equally long message. The host should not send another message until it receives a LOG ACK from the terminal.

Disable LOG ACK by entering **CTRL H \$ (EOT)**

PARITY (E/O): Asynchronous communication usually uses even parity. Specify [E] for even parity or [O] for odd parity. Note the following field to ignore parity. Even if parity is disabled, either even or odd parity must still be specified. The default is E.

PARITY CHK: Some printers do not require the parity bit. If the parity is not to be transmitted to the printer, specify [N] in this field. If parity is to be used, specify [Y]. The default is Y.

2 STOP BITS: Communications on certain low speed lines, usually asynchronous, requires extra timing (stop bits) between characters. If an extra stop bit is to be included in each character transmitted and received, specify [Y] in this field. If no such extra bit is needed, specify [N]. The default is N.

DELAY AFTER CR/LF: Some types of printers require extra time to return the printhead mechanism to column one after a CR/LF sequence is sent to the printer. The delay is measured in milliseconds. The default is N.

BUSY (0/1): One of the wires between the terminal and the attached printer carries a signal to indicate whether the printer is busy or idle. Some printers use a zero (high) value to indicate "busy" while others use a one (low) value. Specify which value, [0] or [1], the printer sends to indicate that it is busy. The default is 0.

EXTENDED LINE: A [Y] here inhibits the automatic CR at the end of the line when sent to the printer. The default is N.

FILTER: A [Y] enables this function. FILTER filters out control codes from the data stream going to the printer. This includes those single-character ESCAPE functions except for:

BEL BS HT LF VT FF and CR.

Extended character functions ESC S0/SI, S0/SI, and ESC'X are treated as they would be by data comm. The default is N.

XON/XOFF: When enabled, this function allows a printer without a BSY (BUSY) line the option to indicate BUFFER FULL by sending XOFF, and BUFFER EMPTY by sending XON.

This function is enabled by entering the printer's XON/XOFF control codes on the Menu Page.

This function is disabled by entering:

CTRL H \$ CTRL H \$ (EOT EOT)

in the control field on the Menu.

TRANSLATE: Enter [Y] here to replace the screen highlight characters with a space. The default is Y.

Edit

These editing functions control user-selected options on how the keyboard-CRT screen foreground terminal is to interpret certain control features, and how data is to be displayed on the screen. The options within this group are:

AUTO FORMS SKIP: Enter [Y] here if data entry from keyboard in Forms mode should automatically skip from field to field (without using cursor positioning or TAB keys). The default is Y.

FORMS XMIT TO CURSOR: When the terminal is in Forms mode, one of two possible actions may be taken when the XMIT key is pressed:

1. The data which is actually sent at that time may be all unprotected fields (including transmittable protected).

2. The data sent may be only those unprotected fields (including transmittable protected) between the home position and the position of the cursor at the time the XMIT key is pressed.

To select the first of these two options (transmit all unprotected fields), enter [N] in this field. To select the second (transmit only the unprotected data from home to cursor), enter [Y] here. The default is Y.

LOWERCASE LOCKOUT: [Y] in this field prevents lowercase from being enabled. The default is N.

DCOM LF->CR: Depending on application program design, you may want to have the terminal behave as if each LF (line feed) character received from the data communications line was immediately followed by a CR (carriage return) character.

If this action is desired, enter [Y] in this field. If [N] is entered here, the LF character will perform only a line feed operation without a carriage return. The default is N.

DCOM CR->LF: Depending on application program design, you may want to have the terminal behave as if each CR character received from the data communications line was immediately followed by an LF character.

If this action is desired, enter [Y] in this field. If [N] is entered here, the CR character will perform only a carriage return operation without a line feed operation, thus remaining on the same line of the screen. The default is Y.

ALT FIELD DELIMS - OPENING:

The US character (right-pointing triangle) always starts a left-justified unprotected field. One alternate character may also be chosen to have this same action. The character which is to be used in this manner is specified here. When the terminal is placed into Forms mode, all occurrences of this alternate character are transformed into right-pointing triangles to start left-justified unprotected fields. This field is specified with hexadecimal characters. The default is 1F (US).

ALT FIELD DELIMS - CLOSING:

The RS character (left-pointing triangle) always ends an unprotected field or highlighting. One alternate character may also be chosen to have this same action. The character which is to be used in this manner is specified here. When the terminal is placed into Forms mode, all occurrences of this alternate character end unprotected fields or highlighting. The field is specified with hexadecimal character. The default is 1E (RS).

LINE-AT-A-TIME TRANSMIT:

The terminal can operate in either a page-at-a-time or a line-at-a-time mode. In page-at-a-time mode, indicated by an [N] in this field, the message size transmitted from the terminal may be as large as one full page of data. In line-at-a-time mode, the maximum message size transmitted from the terminal is one line. The default is N.

SOH CLEAR SCREEN:

This field controls whether the screen is cleared to spaces when a message is received. Enter [Y] in this field to clear the screen immediately before receipt of each message. An [N] in this field will cause the contents of the screen to remain on the screen while the newly-received message is "painted" on top of the old information. The default is N.

WRITE FROM DCOM - HT:

When the HT (tab) character is received from the host, it may or may not be written onto the screen depending on the value of this field. A [Y] here causes the HT character to be written onto this screen. An [N] here causes it not to be written onto the screen. In either case, the terminal performs the editing function described for this character. The default is N.

WRITE FROM DCOM - CR:

When the CR (carriage return) character is received from the host, it may or may not be written onto the screen, depending on the value of this field. A [Y] here causes the CR character to be written onto the screen. An [N] here causes it not to be written onto the screen. In either case, the terminal performs the editing function described for this character. The default is N.

WRITE FROM DCOM - ETX:

When the ETX (end of text) character is received from the host, it may or may not be written onto the screen, depending on the value of this field. A [Y] here causes the ETX character to be written onto the screen. An [N] here causes it not to be written onto the screen. The default is N.

CURSOR WRAPAROUND:

Enter [Y] here to enable the cursor to move from the lower right position of a page to the home position upon data entry. The default is Y.

HT CR WRITE FROM KYBD:

Enter a [Y] here to enable the TAB key or RET key to also enter the character at that position. The default is N.

ETX ADV: If the ETX character is written from DCOM, then a [Y] here allows advance cursor. The default is N.

FIXED TABS: [Y] enables the variable tab option. [N] enables fixed tabs at every eight positions. The default is Y.

CLEAR FORMS: Enter a [Y] here to enable the clear all DCP page in Forms mode. Both protected and unprotected data are erased. The default is Y.

KBD CR/LF: [Y] causes the RET key to both perform the return to column one (leftmost) and to move down one line. The default is N.

SOH EXIT FORMS: [Y] causes the SOH of the data comm message to take the terminal out of Forms mode on the DCP page. The default is Y.

VT PAGE ADV: [Y] enables the interpretation of VT from data comm as a page advance for the DCP. [N] enables VT to set the variable tab stops. The default is N.

FF CLR TABS: [Y] clears the entire area of the DCP page by filling with spaces, and moves the DCP to the home position. [N] means this function is ignored. In Forms mode, this function is not in effect. That is, all the unprotected fields are cleared from the page and it moves the DCP to the entry position of the first field.

DC2 ADV DCP: [Y] enables the DC2 character from data comm to be interpreted as a DCP advance. [N] enables the DC2 character from data comm to be interpreted as forms enable/disable.

TAB RETAIN: Variable tab stops may be retained after a temporary reconfiguration. Enter [Y] here. The default is N.

ROW/COL PAGE END ALARM:

Enter the row and column numbers so that data entry will sound the beeper. Enter with decimal value. The defaults are 24 and 80, respectively.

KEYSTROKE BUFFER: [Y] enables the keyboard to be buffered in the keystroke buffer while the data comm process is still active upon unloading the data comm buffer to the screen. [N] does not use the keyboard buffer. The default is N.

NOTE

Once this option is set to [Y], you must press the LOCAL key immediately upon exiting the menu via a CTRL RPXXXX sequence.

RPT RATE: Keyboard key repeat code. The default is 06.

00: no repeat	04: 11 c/s	08: 19 c/s	12: 40 c/s
01: 5 c/s	05: 13 c/s	09: 21 c/s	13: 50 c/s
02: 7 c/s	06: 15 c/s	10: 25 c/s	14: 60 c/s
03: 9 c/s	07: 17 c/s	11: 30 c/s	15: 75 c/s

RPT DELAY: The time to hold the keyboard key down before repeat begins. The default is 05.

00: no repeat	04: .4 sec	08: .8 sec	12: 1.2 sec
01: .1 sec	05: .5 sec	09: .9 sec	13: 1.3 sec
02: .2 sec	06: .6 sec	10: 1.0 sec	14: 1.4 sec
03: .3 sec	07: .7 sec	11: 1.1 sec	15: 1.5 sec

CLK LEVEL: The sound level of the audible feedback (click) upon depression of a keyboard key. The default is 2.

0: no click 1: low level 2: medium level 3: loud level

ALARM LEVEL: The sound level of the 400 Hz audible alarm in the keyboard used by editing processed and data comm. The default is 2.

0: no click 1: low level 2: medium level 3: loud level

Screen

The screen group is used to format the display. Options within this group are:

60 HZ: The screen refresh rate is controlled by the contents of this field. A 60-Hz refresh rate is selected by a [Y] here. A 50-Hz refresh rate is selected by an [N] here. The refresh rate should be the same as the frequency of the power supply to which the terminal is connected.

In most of Europe, 50-Hz ac is used, so a 50-Hz refresh rate should be specified. In most of North America, 60-Hz ac is used, so a 60-Hz refresh rate should be specified. The default is Y.

BLINK CURSOR: The cursor may be either blinking or non-blinking. Specify [Y] here for blinking cursor, or [N] for non-blinking cursor. The default is N.

CURSOR: The cursor may be either a reverse video block or an underline or invisible. Specify [R] here for reverse video, [U] for underline, or [N] for invisible. The default is R.

CHAR/LINE: Enter [40] or [80] characters per display line. When 40 characters per line, character is extended to horizontal. The default is 80.

LINE/PAGE: Enter the number of lines per page (value from 1 to 256 within the limits of the display buffer), the desired number of pages, and the number of characters per line. The default is 24.

LINE/SCREEN: Enter [12] or [24] lines per screen user display area. When 12 lines/screen, character is extended to vertical. The default is 24.

INTL LANG: Enter the code of the language of the keyboard and symbol generator.

01: United States	18: Sweden
02: United Kingdom	19: Thailand
03: France/Belgium	20: Arabic
04: Italy	21: Hebrew
05: Germany	32: TERCO B/Suisse German
06: Brazil	33: TERCO A/Suisse French
07: Spain/Latin America	34: United States (1A)
08: Denmark/Norway	35: United States (1B)
09: Croatia (Yugoslavia)	36: France/Belgium (3A)
10: Sweden/Finland	37: Germany (5A)
13: Cyrillic/(U.S.S.R.)	38: Brazil (6A)
14: Turkey	39: Spain/Latin America (7A)
15: Greece	40: Iceland (16A)
16: Iceland	41: Swiss/German
	42: Swiss/French

SO/SI XLT: This indicates SO/SI (shift-out/shift-in) code conversion on the screen when the text is transmitted to the host system. (Refer to table 4-1 below for conditions of this function.)

SO/SI XTN: This selects extended character sets for receiving SO/SI code from host system. (Refer to table 4-1 below for conditions of this function.)

Table 4-1. SO/SI Functional Conditions

Menu Setting		Condition		
SO/SI XLT	SO/SI XTN	RECEIVE SO/SI	TRANSMIT HIGHLIGHTS	TRANSMIT EXTENDED CHARS.
[N]	[N]	HIGHLIGHTS	SO/SI	ESC SO/ESC SI
[N]*	[Y]	EXTENDED CHARACTERS*	ESC4/ESC3*	SO/SI*
[Y]*	[N]	HIGHLIGHTS*	ESC4/ESC3*	ESC SO/ESC SI*
[Y]	[Y]	EXTENDED CHARACTERS	ESC'./ESC'/'	SO/SI

NOTE

Options ESC4/ESC3 are in conflict with another function of the terminal (CTRL ## XMIT). Therefore, these settings and conditions will not be implemented on any Burroughs terminal or workstation (MT985 or ET 1000 Series replacements or emulations) shipped after January 1, 1986.

The FIRST option ([N] [N]) is the recommended setting. However, if you wish to use another, use the FOURTH option. This allows the use of the SO/SI as data comm extended delimiters, ESC'./ESC'/' as screen highlights, and CTRL ## XMIT within the same application.

Refer to appendix H for further information on SO/SI.

SEMI-PERMANENT CONFIGURATIONS

Semi-permanent configurations are those changes which remain in effect until the terminal is turned off. For example, to display large characters on the screen for a short time, the two options, LINE/SCREEN and CHAR/LINE can be changed using a special control sequence. When the terminal is turned off, these two options will return to their defaults. (Permanent configurations remain in effect even after you turn the terminal off.)

To make a semi-permanent change in the configuration, follow the procedure for changing the configuration options, except press LOCAL after you enter <CTRL><SHIFT>RCXXXX. Do not perform the <CTRL><SHIFT>RPXXXX sequence.

DIRECTLY CHANGING THE CONFIGURATION TABLE

A string of 8-bit bytes, called a scratchpad, contains the specifications of all the selected configuration options. Each byte is identified by a hexadecimal number (80 through 27F). An individual bit in the scratchpad is identified by the notation "c/b" where "c" is the character and "b" is the bit. Bit numbers range from 7 (high-order) to 0 (low-order). The correspondence between scratchpad data and the configuration options is tabulated in figure 4-1.

The contents of the scratchpad can be displayed on the screen and modified from the keyboard. Changes do not take effect until a configuration operation is performed. This operation may be initiated either from the keyboard or by data comm, and takes place automatically during the terminal startup sequence.

At that time, reconfiguration transfers the scratchpad values into the actual working values of the configuration parameters. Also, the consistency comparison between the scratchpad values of the configuration and various limitations of the machine is checked. (For example, the storage allocated for display store and data comm buffer cannot exceed the storage available in the terminal.) If the reconfiguration operation fails, a diagnostic message is displayed on the screen, and a default configuration takes effect.

RECONFIGURATION ERROR CHECKS

When the configuration menu is modified (semi-permanently or permanently), the terminal checks the contents for reconfiguration errors. The reconfiguration error check occurs after these conditions:

- the control sequence <CTRL><SHIFT>RCXXXX, and
- the LOCAL key is pressed, or
- the control sequence <CTRL><SHIFT>RPXXXX is entered.

It differs from the entry error check in that the entry error check ensures that valid characters are entered. The reconfiguration error check ensures that valid options are selected.

For example, in the last option of the configuration menu, SO/SI XTN, if [A] is entered, the entry error check would pass because a capital letter was entered. But the configuration error check would not because [A] is not a valid option; [Y] or [N] is a valid option. When a configuration error is detected, one or more numbers are displayed. Only the number of the error will be displayed at the top line of the screen after LOCAL is pressed or <CTRL><SHIFT>RPXXXX is entered. Refer to appendix E for the menu item in error, then make the appropriate corrections.

SECTION 5

BUFFER CONTROL

A buffer is an area in the terminal that stores data in the form of bytes. (A byte is a character or keystroke, such as a letter or symbol.) The terminal has five buffers : keystroke, softkey, display, data comm, and printer. Each buffer can be defined in the configuration menu, and must be a defined size, even if it is zero. The total amount of usable buffer area is 24,576 bytes.

For example, the display buffer, data comm buffer, and print buffer can each have 7,680 bytes; the softkey buffer can have 1,500 bytes; and the keystroke buffer can have 36 bytes. Figure 5-1 shows the buffers in the terminal, and is followed by an explanation of each buffer. Refer to appendix I for a memory map.

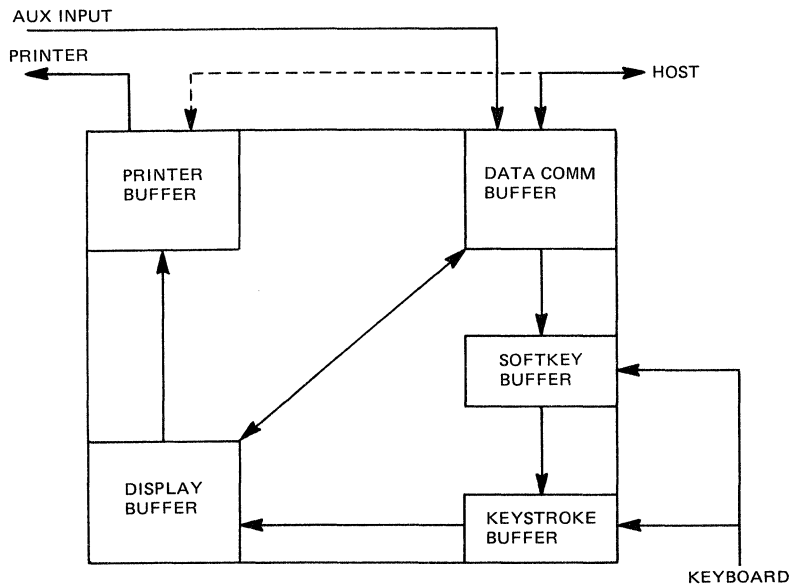

E4801

Figure 5-1. Buffer Interface

KEYSTROKE BUFFER

Keystrokes made during a keystroke lockout condition are stored in the keystroke buffer. Keystroke lockout occurs when the unit is in RCV or XMT mode and the LOCAL indicator light is off. If the keystroke buffer is enabled--line 20 on the configuraton menu--keystrokes are stored.

The size of the keystroke buffer can be specified in decimal on the configuration menu--line 3. Once the lockout condition is cleared (the LOCAL indicator light goes on again), the contents of the keystroke buffer are transferred to the screen buffer and displayed on the screen.

When the keystroke buffer is full, the message KEYSTROKE LOST is displayed on the user status line. Pressing LOCAL will clear this message as well as the keystroke buffer. Figure 5-2 shows the relationship between the keystroke and screen buffers.

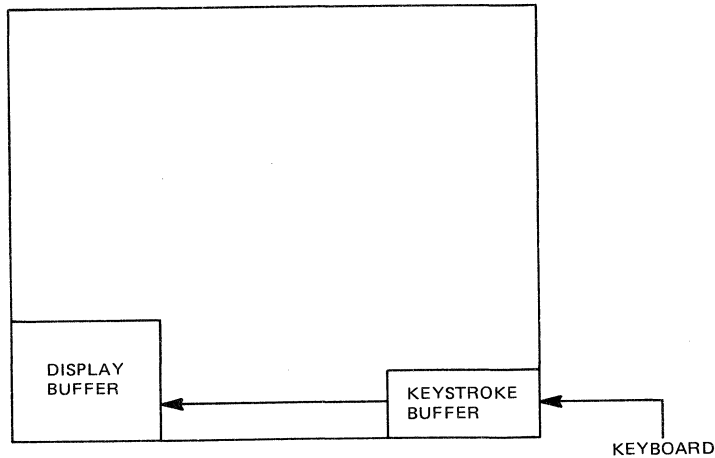

E4802

Figure 5-2. Keystroke Buffer Interface

SOFTKEY BUFFER

The softkey buffer is used to store key programming sequences (refer to the section 6 for details on key programming). A key can be redefined via the keyboard or the host. In both cases, when a key is redefined, the new function is stored in this buffer. When a redefined or softkey is pressed, the function is relayed to the keystroke buffer, then transferred to the screen buffer.

NOTE

The redefined functions of the key stays in the softkey buffer. When the softkey buffer option is changed to a value other than 0256, the key programs are stored in an area of the softkey buffer other than the default 256 bytes. When a value other than 0256 is used, the key programs in the default 0256 bytes are not accessed, thus giving the impression that there are no programmed keys.

Figure 5-3 shows the interconnection of these buffers.

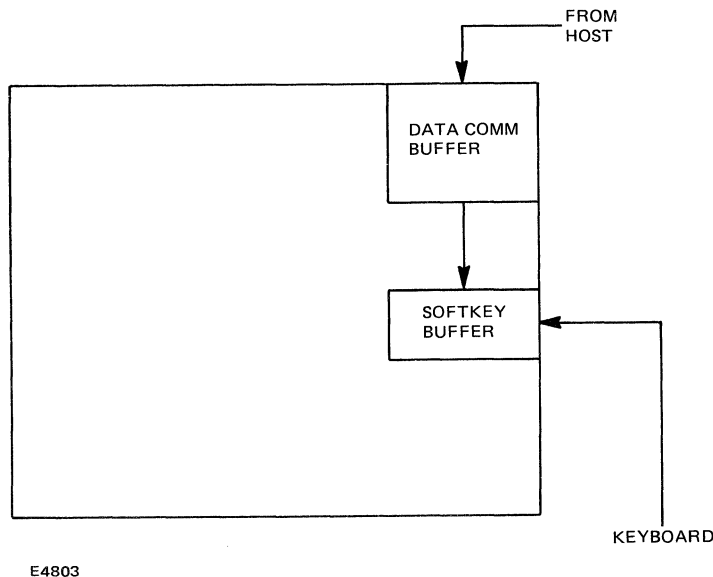

Figure 5-3. Softkey Buffer Interface

DISPLAY BUFFER

The display (screen) buffer stores the data that will be displayed on the screen. This data can come from the keystroke or data comm buffer. Two pointers indicate the location at the display buffer: Keyboard data is pointed to by the cursor while data comm data is pointed to by the DCP (data comm pointer). These are independent of each other. (However, if the page contains both the DCP and cursor at the end of a data comm transmission, the cursor is aligned to the position of the DCP.)

The screen buffer can be transferred to the data comm buffer or the print buffer as long as the size of the buffers allows it. For example, if the data to be transferred to the data comm buffer from the screen buffer is 3,840 bytes (two full pages), and the data comm buffer is only 1,920 bytes (one full page), the excess data is disregarded, and only the first 1,920 bytes will be transferred.

Six bytes are required for each line in the display buffer (including 12 for the status lines). Add these in when calculating space within the 24,576 bytes of user space.

The screen buffer is transferred to the data comm buffer when the XMIT key is pressed, and the screen buffer is transferred to the print buffer when the PRINT command is generated from the keyboard. Figure 5-4 below shows the interconnection of these buffers. Note: Refer to appendix G for relationships between the number of pages and the display buffer.

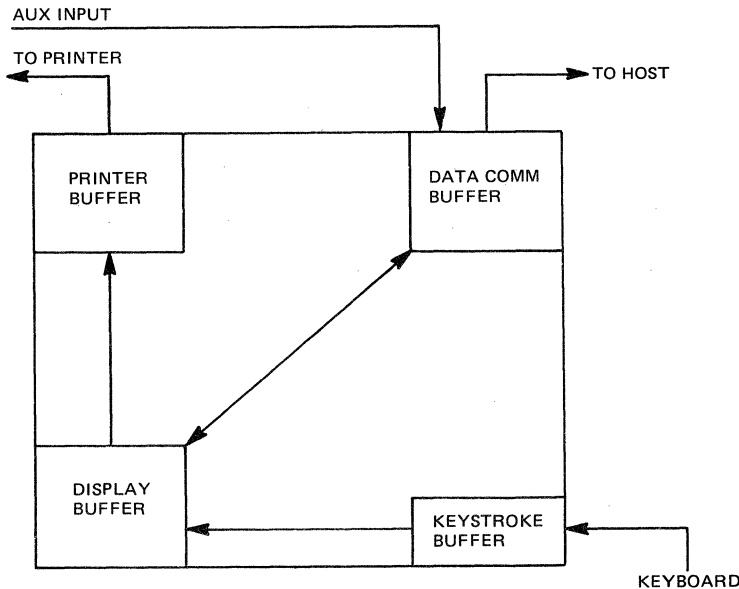

E4804

Figure 5-4. Display Buffer Interface

DATA COMM BUFFER

The data comm buffer is used for storing data received from the host. This data can be transferred to the screen buffer to be displayed on the screen. If the host redefines a key, this data will be transferred to the softkey buffer. In some cases, the host may want to send data to be printed on the printer without disturbing the operation of the terminal. In this case, the data comm buffer is transferred to the print buffer. Figure 5-5 below shows the interconnection of these buffers.

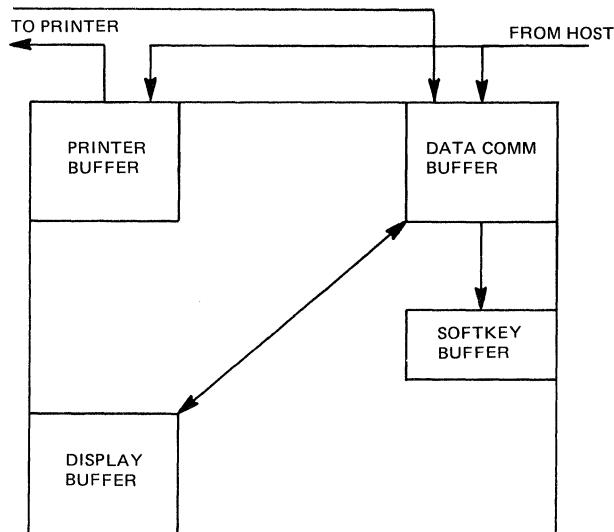

E4805

Figure 5-5. Data Comm Buffer Interface

PRINTER BUFFER

The printer buffer is used for storing data that is to be printed on the printer. The printer buffer can receive data from two sources: the display buffer and the host. When the data is received from the display buffer (SCREEN PRINT), input from the keyboard is prohibited. When the data is received from the host (PRINT/AUX), input from the keyboard is not prohibited. Both PRINT/AUX and SCREEN PRINT are explained in the Printer Control section. Figures 5-6 and 5-7 show the PRINT/AUX and the SCREEN PRINT data flow.

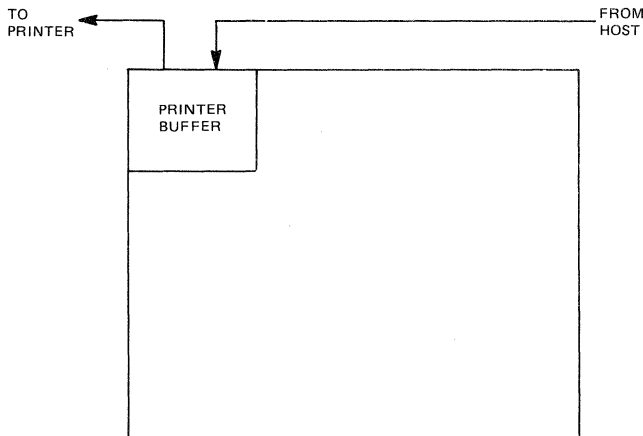

E4807

Figure 5-6. Printer Buffer Interface (Screen Print)

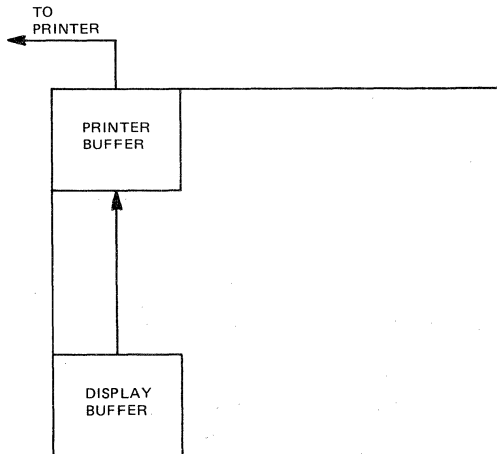

E4806

Figure 5-7. Printer Buffer Interface (Print/Aux Print)

SECTION 6

DEFINING KEY FUNCTIONS (KEY PROGRAMMING)

Key programming is a feature of the terminal that enables you to redefine the function of a key. Its purpose is to reduce the number of keystrokes per function.

All the keys are assigned an original function, except the function keys, labeled F1 through F10, which have no original function.

The maximum number of characters that can be used in permanent key programming is 256. For example, if you program the F1 key to print "Good Morning" on the display, the character count is 14:

F1	equals	1	character
Good	equals	4	characters
one space	equals	1	character
Morning	equals	7	characters
the End Key Program character	equals	1	character
	equals	14	characters total

After this key program is entered, there will be 242 characters left that you can use in other key programs.

The end key program character is the LOCAL key.

The only keys that cannot be programmed are the two SHIFT keys. All other keys can be permanently or semi-permanently redefined to perform functions other than their originally assigned functions. All key codes executed by the keyboard may also be used in a key program.

Permanent key programs (not lost at power off) are stored in permanent locations in the terminal memory; however, any key program considered permanent can be changed or deleted.

Semi-permanent key programs (lost at power off) are stored in a semi-permanent memory area, temporarily reserved for key programming.

SEMI-PERMANENT/PERMANENT SOFTKEY BUFFERS

There are two areas of memory that can hold key programs. Both are called softkey buffers.

One softkey buffer is the default buffer, which is exactly 256 bytes (1 byte equals a keystroke). The other softkey buffer is a semi-permanent area in memory.

Key programs can be defined in the default 256-byte softkey buffer. After this, the semi-permanent key programs can be defined in a semi-permanent softkey buffer in a size other than 256. Both buffers cannot be accessed at the same time. The semi-permanent softkey buffer is used when a value other than 256 is specified in the configuration menu.

The key programs resident in the default softkey buffer remain until they are reprogrammed. The semi-permanent softkey buffer key programs remain in effect until the terminal is turned off or until the confidence test is executed.

Every key you program requires 1 byte for each keystroke in the key program and 2 bytes for the buffers: one for the key to be programmed and one for the stop code. For example, if you want the A key to perform the B key function (pressing the A key will display a B), then this key program will be 3 bytes long. If you want the A key to display BURROUGHS TERMINAL, this key program would be 20 bytes long. (The space between Burroughs and Terminal counts as 1 byte.)

If more bytes (keystrokes) are entered than are reserved in the softkey buffer, the message BUFFER OVERFLOW is displayed on the user status line. This means that the entire key program must be entered again. Therefore, be sure to reserve the correct number of bytes before proceeding.

PROGRAMMING A KEY

Set the conditions for programming a key by pressing the CTRL key, the spacebar, the SHIFT key, the L key, and then the CTRL key once again:

<CTRL><SPACEBAR> L <CTRL>

The space you have with which to work is defined as follows:

B = 256

The 256 value is used on the assumption that you have not changed this value in the configuration menu.

Press THE KEY YOU WANT TO PROGRAM

Press THE KEYS OF THE KEY PROGRAM

Press LOCAL

Note: Each time you press a key, the character count decreases by one.

To program the backspace key, for example, backspace one position and delete the character displayed in that position. For example:

Press BACKSPACE
 Press BACKSPACE
 Press DELETE CHARACTER
 Press LOCAL

Pressing LOCAL ends the key program sequence.

The key you programmed now performs its new function until the terminal is turned off or forced through its confidence test.

To make the key changes permanent--that is, they will remain as you programmed them after the terminal is turned off---perform the following:

ENTER:

<CTRL><SHIFT>RWMODE<CTRL><SHIFT>RPXXXX

Correcting Key Programming Mistakes

If you make a mistake in a key program, backspacing to correct the mistake counts as a keystroke. The following is an example of what will be entered as the key program in the softkey buffer if a mistake is corrected:

Ergonomic (space)Terminla(backspace)(backspace)al

When the key you programmed is pressed, 'Ergonomic Terminla' is displayed, the cursor backspaces two times, then 'al' is displayed. The final key program sequence is 24 bytes long. The key program sequence without the mistakes is only 20 bytes long.

If you make a mistake, press LOCAL, then enter the correct key program sequence.

NOTE

The LOCAL key will stop the key program sequence normally; therefore, the incorrect key sequence will be entered into the buffer. However, entering the correct key program sequence will change the previous (incorrect) key program to the new (correct) key program.

Using a Programmed Key in Another Sequence

If a key is programmed to perform a function other than its original function, the original function still remains in effect for any other key program sequence.

For example, if you program the A to display a B, then discover that you need an A for creating a different programming sequence, pressing the A while creating that new key program sequence will display an A for that sequence.

Once that key programming session is over and a new sequence has been created, the A once again assumes the function that you have programmed for it.

Programming a Key to Its Original Function

To restore a key's original function, enter:

<CTRL><SPACE><L><CTRL>

Press twice the key you want to restore to its original function

Press <LOCAL>

If a key is to perform no function, enter:

<CTRL><SPACE><L><CTRL>

Press the key you want to have no function

Press <LOCAL>

DATA COMM PROCEDURES

Method 1

The function keys, F1 through F10 (unshifted and shifted) can be programmed through data comm, where the host manipulates the softkey buffer and sends the key programs to the terminal in the form of escape sequences. The principles of the softkey buffer, described in the keyboard procedure, apply to the data comm procedure.

The following is the data comm procedure for key programming the function keys.

1. ESC RBccccdddppp (optional-see below).
2. ESC RKppp (see below).
3. Code for one key being programmed (any number 01 - 20).
4. Function codes (refer to appendix C).
5. Key program end code (LOCAL code, i.e., A9).
6. Repeat steps 3 through 5 for each key being programmed (upto a maximum of 20).
7. Key program end code (LOCAL code, i.e., A9).

Step 1 (ESC RBccccdddppp) reserves memory for the softkey buffer, if necessary. This is required only if the keyboard program, which includes all of the new key programs, is larger than 256 bytes. ESC RB allows for temporary expansion of the keyboard program from 257 bytes to 4095 bytes. It does not write to permanent memory. The ten characters following the ESC RB are hex values, where:

ccc equals the data comm buffer size up to 4095 bytes

dddd equals the display memory size

ppp equals the softkey buffer size up to 4095 bytes.

This sequence also checks whether the amount of memory you want to reserve for key programming is available in the terminal. The terminal responds with six asterisks to indicate that the memory is available, or with an error message to indicate that this amount of memory is not available.

In step 2 (ESC RKppp), ppp equals the number of pairs of bytes, in hex, to be sent to the terminal. If the text is greater than the softkey buffer value, BUFFER OVERFLOW is displayed on the user status line. This message means that step 1 is required.

In step 3, code for one key being programmed (any number 01 -20), the key being programmed must be compatible with earlier products. Any code here will default to unshifted F1 (95). The next key programmed will default to unshifted F2 (96).

Method 2

Any key except the SHIFT key can be programmed through data comm by using the ESC RH sequence. The following is the data comm procedure for key programming using this method:

1. ESC RBcccdppp (optional-see method 1).
2. ESC RT010202 (see below).
3. ESC RHhhhhkk (see below).
4. Code for key being programmed (refer to appendix C for key location values).
5. Function codes for this key (refer to appendix C).
6. Key program end code (00).
7. Repeat steps 4 through 6 or 3 through 6 until all the desired keys are programmed (see below).
8. Key program end code (00).
9. ESC RCXXXX.

Step 2 (ESC RT010202) causes the terminal to transmit the contents of hex locations 102 and 103, the start address of the softkey buffer. This address must be used in step 3 the first time it is performed.

Step 3 (ESC RHhhhhkk) requires that hhhh be the hex value of the address obtained in step 2 for the first time it is performed or an adjusted value if it is performed more than once. The value kk is the hex length of the pairs of bytes which follow. These will be placed in the buffer address beginning at location hhhh.

Step 7 requires steps 4 through 6 to be repeated if a multiple number of keys are to be programmed following a single ESC RH sequence. A combination of both may be desired. In any case it is necessary to adjust hhhh address each time an ESC RH sequence is sent.

Example: The following sequence causes these results:

```
(a)<---0123
(A)<---ABCD
(unshifted F1)<----cursor down, X when softkey buffer
                    begins at 0180H.
```

ESC RH01801132303132330042414243440095F9580000 ESC RCXXXX

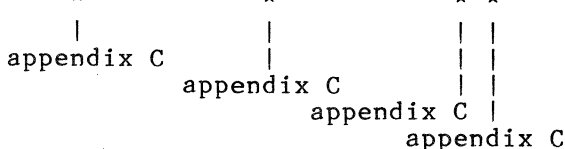

SECTION 7

DESIGNING PAGES (FORMS MODE)

An operator-designed page used to enter information is called a form. This information is entered into defined fields, enclosed by delimiters. These fields can be of unlimited length.

The area outside a delimiter is called a fixed field. The fixed fields of a form are used for headings, titles, and/or information about the form.

The area within a delimiter is called a text field.

The three types of text fields, left-justified, right-justified, and protected, can be of any length up to one line.

Text fields of the same type can follow one another on the same line or on succeeding lines.

A form is first 'built' by the operator or received from data comm in the normal operating mode. The Forms mode is then entered to make the delimiters, protected text fields, and fixed fields inaccessible to the operator. The next few paragraphs describe the three types of text fields and delimiters, and how to transfer the form to and from the Forms mode. This is followed by an example and an explanation of a sample form.

Data comm functions often behave differently in Forms and Non-Forms modes. Refer to section 9 and appendix K for descriptions.

LEFT-JUSTIFIED TEXT FIELDS

Data is entered in a left-justified text field beginning in the leftmost position. Each keystroke is displayed to the right of the previous one. The beginning delimiter of a left-justified text field is a US character (>), displayed by performing the following control sequence:

ENTER:

<CTRL><SHIFT>H?

RIGHT-JUSTIFIED TEXT FIELDS

Data is entered in a right-justified text field beginning in the rightmost position. Each keystroke moves the previous keystrokes one position to the left. The beginning delimiter of a right-justified text field is a GS character (^), displayed by performing the following control sequence:

ENTER:

<CTRL><SHIFT>H=

PROTECTED TEXT FIELD

Data is entered in a protected text field at any time prior to entering Forms mode. When Forms mode is entered, this field will no longer be accessible to the operator. The beginning delimiter of a protected text field is an FS character (<>), displayed by performing the following control sequence:

ENTER:

<CTRL><SHIFT>H<

ENDING A TEXT FIELD

Each text field is ended by an RS character (<), displayed by performing the following control sequence:

ENTER:

<CTRL><SHIFT>H>

ENTERING FORMS MODE

After the form is 'built', it is necessary to make the delimiters, protected text fields, and fixed fields inaccessible to the operator. To do this, enter the following control sequence:

ENTER:

<CTRL><SHIFT>W

EXITING FORMS MODE

To transfer the form from the Forms mode to the Local mode (for normal operation), enter the following sequence:

<CTRL><SHIFT>Q

SAMPLE FORM

In the following sample form, the bold printed data represents a fixed field; the data inside the delimiters represents the various text fields.

INTER-OFFICE MEMO FORM

DATE ▷May 15, 1983◁ ————— Left-Justified Text

TO ◇Christopher Ashwood◁

FROM ◇Jacqueline Steward◁

SUBJECT ◇Expenses◁

◇Here are last month's expenses from the Data Processing Dept.◁

Enter Items Below	Enter Amounts Below
▷paper ◁	◇\$◁△ 350.00◁
▷office supplies ◁	△ 50.00◁
Left-Justified Field	◇ _____ ◁
	◇TOTAL \$◁△ 400.00◁
	Right-Justified Text

◇Regards,◁

= PROTECTED TEXT AREAS (FIXED, BUT STILL TRANSMITTABLE)

= DESCRIPTIVE NOTATION

After the form is 'built', performing the <CTRL><SHIFT>W control sequence will transfer the newly-created form to the Forms mode, and position the cursor in the first position of the first right-or left-justified text field. In the sample form, the cursor is positioned in the left-most position of the 'DATA' text field. Only the right- or left-justified text fields can be typed in.

The sample form has six fields that can be typed in:

'DATA', two 'ITEMS', two 'AMOUNTS', and 'TOTAL' text fields.

The TAB and REVERSE TAB keys can be used to 'skip' to another field, as in the configuration menu.

NOTE

If Y is entered for the AUTO FORMS SKIP option in the configuration menu, the cursor will automatically 'skip' from a filled left-justified text field to the next text field. If N is entered for this option, the alarm will sound when a left-justified text field is full.

To exit the form from the Forms mode, perform the <CTRL><SHIFT>Q control sequence. (The form is now in the 'build' stage where you can alter any part of it.)

OPERATING MODES

The terminal has other operating modes besides the Forms mode. They are the Control mode, Edit mode, Local mode, Read/Write mode, Receive mode, Search mode, and Transmit mode.

Control Mode

The Control mode is not a substate of the Local mode, even though it is entered from the keyboard via the CTRL key. Entering Control mode permits you to access instructions that direct the terminal to perform certain functions---such as exchanging the cursor line with the one below it. After the instruction is entered by way of a control sequence, the terminal reverts to the Local mode.

Refer to section 9 for the list of control sequences the terminal can perform.

Edit Mode

Text entry is used more often than any of the other operations. It is actuated either from the keyboard by text keys (letters, digits, punctuation marks, and special characters in the ASCII code set 20,...,7F), or from data comm by non-control characters.

Although storing a character and advancing a pointer is a simple operation, variables such as entry source (keyboard versus data comm), skip flag, Forms or Non-Forms mode, and some configuration options complicate the description of general text entry.

Keyboard Text Entry

When the use of a text key initiates text entry, the text-character-entry operation is activated. If the ASCII code of the character corresponding to the key is in the range from 61 through 7A (i.e., a lowercase letter) and the setting of LOWERCASE LOCKOUT=Y, then the code is reduced by 32. This replaces each lowercase letter by its uppercase equivalent.

In Forms mode pages, text can be entered from the keyboard in US fields and the rightmost positions of GS fields only.

Text entry in a US field proceeds as in a non-forms page. After each character is stored, the cursor moves one space to the right until the last position in the field is reached. After storing a character in the last position of the field, the cursor advancement depends on whether AUTO FROM SKIP IS "Y" OR "N". If "Y", the cursor skips to the next unprotected location. If "N", the cursor moves one space to the right into a protected location. Explicit operator action (e.g., TAB) is then required to move it into an unprotected region.

When entering text from the keyboard into a GS field, the cursor does not move at all; instead, the contents of the field shift left one space before the new character is stored. Again, the operator must take explicit action to move the cursor out of a GS field (e.g., HOME).

Data Comm Text Entry

Text entry by a data comm message is easier than text entry from the keyboard. Data comm text entry differs from keyboard text entry in that:

1. The skip flag has no effect.
2. Cursor wrap around has no effect---the data comm pointer unconditionally advances from the end of a page back to its beginning.
3. GS fields are treated like US fields.
4. Text entry is allowed in fixed fields.
5. In a forms page, storing a character in a location at the end of any field, GS, US, or RS, advances the data comm pointer to the next GS or US field.

Forms Mode

The Forms mode is a substate of the Local mode, even though it is entered by a control sequence. Entering the Forms mode allows you to make the delimiters, text fields, and fixed fields of a form inaccessible to the operator. If the terminal is configured (Y entered for SOH EXIT FORM), and a message is sent to the terminal from the host, the terminal relinquishes the Forms mode page to accept the message.

Certain functions in Forms mode behave differently than when they are in non-forms mode. Refer to section 9 for descriptions of control sequences and escape sequences when in different modes of operation.

Local Mode

When the terminal is in the Local mode, it can accept data entered from the keyboard, or it can output displayed data to a printer by means of control sequences. While the terminal is in Local mode, the host normally cannot gain access to the display; however, the host can force the terminal to receive or transmit data. The terminal buzzer will sound to signify that the host wants to send data to the terminal. If N is entered for the option BEEP ON NAK in the configuration menu, the buzzer will not sound.

Read/Write Mode

The Read/Write mode (RW mode) is entered through the keyboard by means of a control sequence which displays the configuration menu. Entering this mode allows you to change one or more options semi-permanently or permanently, or to display the existing options. While the terminal is in the RW mode, the host cannot gain access to the display. Refer to the configuration menu section for details of the RW mode.

Receive Mode

The Receive mode is entered from the keyboard by pressing the RCV key, or from the host by means of data comm. When the terminal is in the Receive mode, it accepts escape sequence or display data messages from the host. It remains in the Receive mode until the message is received in its entirety and the parity is checked. After successful reception of the message, the terminal will enter the Local mode, unless Y is entered for the option RCV MODE HOLD.

Search Mode

Search mode scans the display store to find and replace instances of a particular character. Unlike Forms and video modes, which apply to individual pages in the display store, Search mode involves the entire terminal. It can be turned on and off either from the keyboard (on by CTRL-A, off by CTRL-S) or by a data comm message (on by ESC E, off by ESC F). When Search mode is on, it affects the following functions:

- The SKIP key (Shifted TAB).
- Keyboard data entry.
- Entry into Forms mode.
- Transmission of a Forms mode page.

The bases of Search mode operation are the "search character" and the "skip flag". The Search character is compared with successive display store characters during a scan. The default Search character is "|" (hex code 7C); it can be specified to be another character. This can be done either from the keyboard (CTRL E x) or by a data comm message (ESC - x). However, it reverts to "|" whenever Search mode is turned off.

Much of the skip flag function is to record whether the cursor arrived at its present location as a result of a Search operation. Its status then determines the cursor action following replacement (by text-key entry) of display store characters.

Search mode scanning operation depends on whether the page containing the keyboard cursor is in Forms mode. If it is not, the scan begins in response to the SKIP key. It moves to the right until it encounters an instance of the search character.

The scan is restricted to the page in which it begins. That is, if it reaches the end of the page, it returns to the start of the page and continues to the cursor location. If the page contains no instance of the search character, the cursor is moved to the home position of the page.

A successful search moves the cursor to the flag. Most non-text keys clear the skip flag; the only exceptions are keys (and CTRL sequences) that neither move the cursor nor alter the contents of the display store.

Finally, the message interpreter clears the skip flag whenever an incoming message puts the data comm pointer on the same page as the keyboard cursor.

In Forms mode, scanning stops not only at instances of the search character, but also at unprotected fields. If the scan encounters a GS or US that delimits an unprotected field before it encounters a character matching the search character, the cursor immediately advances to the data entry position of the field. It ignores any intervening instances of the search character and clears the skip flag.

The Forms/Search mode combination also affects transmission. Transmission of a forms page omits protected fields, but Search mode transmission includes them.

If Search mode is on when a page is put into Forms mode, or if the pointer page is in Forms mode when Search mode is enabled, a Search mode scan begins at the first character of the page. The scan stops at the first instance of the search character, or at the first unprotected field, as explained previously. The appropriate pointer is then moved to that position.

NOTE

The updated pointer is the cursor if the mode change was initiated from the keyboard.
If caused by a data comm message, then the data comm pointer is updated.

Transmit Mode

To enter the Transmit mode from the keyboard, press the XMIT key.

To enter the Transmit mode from the host, a special escape sequence message must be sent through data comm.

When the Transmit mode is entered from the keyboard or forced by the host, the display data from the home position to the cursor is sent to the host.

If an end-of text character is displayed on the page, the data from the cursor to the end-of-text character is sent to the host.

If line-at-a-time is Y, then the data from the left margin of the cursor line to the cursor is sent to the host. CTRL XMIT always does a line at a time.

SECTION 8

PRINTER CONTROL

The terminal can be connected directly to a printer, and can be used to print the contents of the screen via a keyboard or data comm command. Also, the host can initiate a PRINT/AUXILIARY (PRINT/AUX) print.

When a PRINT/AUX print is initiated, the printing does not affect the terminal in any way. While the printer is operating, the terminal can be in any mode.

SCREEN PRINT

When a SCREEN PRINT command is sent from the terminal or host, the screen data is transferred from the display buffer to the print buffer. When the print buffer is full or the contents of the display buffer are transferred to the print buffer, then the print buffer is transferred to the printer.

If there is more display data than the print buffer can hold, then the "overflow" is disregarded. Once the display buffer is transferred to the printer buffer, you can begin inputting from the keyboard. You know when the display buffer has been transferred when the word CTRL disappears from the bottom, right-hand corner of the screen. Even though the printer may be activated at this point, you can still key in on the terminal.

Either the terminal or host is capable of initiating three SCREEN PRINT commands. The terminal-originated SCREEN PRINT commands are initiated by a control sequence. The host-originated SCREEN PRINT commands are initiated by escape sequences (refer to the Escape Sequence section).

One PRINT command prints the whole page from the home position to the cursor location. This occurs in either Forms mode or Non-Forms mode, with a form feed generated after the last line of the print. To initiate a "Print Whole Page With Form Feed" from the terminal, perform the following control sequence:

ENTER:

<CTRL>;

Note: Pressing the PRINT key (shifted) performs the same function.

Another PRINT command prints the unprotected data, then generates a form feed after the last line of print. This PRINT command, mostly used in the Forms mode, prints all the unprotected data fields in the form (that is, fields in a form that can be updated). If the terminal is not in Forms mode, then this command performs the same function as <CTRL>;. To initiate the "Print Unprotected Data with Form Feed" from the terminal, perform the following:

ENTER:

<CTRL>:

The third PRINT command is almost the same as the first <CTRL>, except no form feed is generated after the last line of print. To initiate a "Print Whole Page With No Form Feed", perform the following:

ENTER:

<CTRL>]

Note: Pressing the PRINT key (unshifted) performs the same function.

The cursor position at the time the terminal receives or generates the PRINT command determines the position at which printing stops.

If the cursor precedes the home position, then printing stops at the end of the page.

If <LOCAL> is pressed before the print operation is completed, then the print operation ceases.

If the printer status is NOT READY or a printer fault occurs, then the message PRINTER ERROR will be displayed on the user status line of the terminal screen.

PRINT/AUX PRINT

Print/Aux printing is initiated from the host to allow the printer to work on one task while the terminal is being used for another task. The Print/Aux address and the Screen address are considered two separate addresses to the host. The text received for Print/Aux print is sent directly to the printer buffer. Printing begins when all of the text has been received.

Print/Aux printing allows messages received by the host to be sent directly to the printer without examination by the terminal. This Print/Aux print is normally kept in Receive mode, rather than in Local mode, so that no operator action is required to print the messages.

PRINT SEQUENCES FOR PRINT/AUX

The following illustrations show a Screen print operation and a Print/Aux print operation.

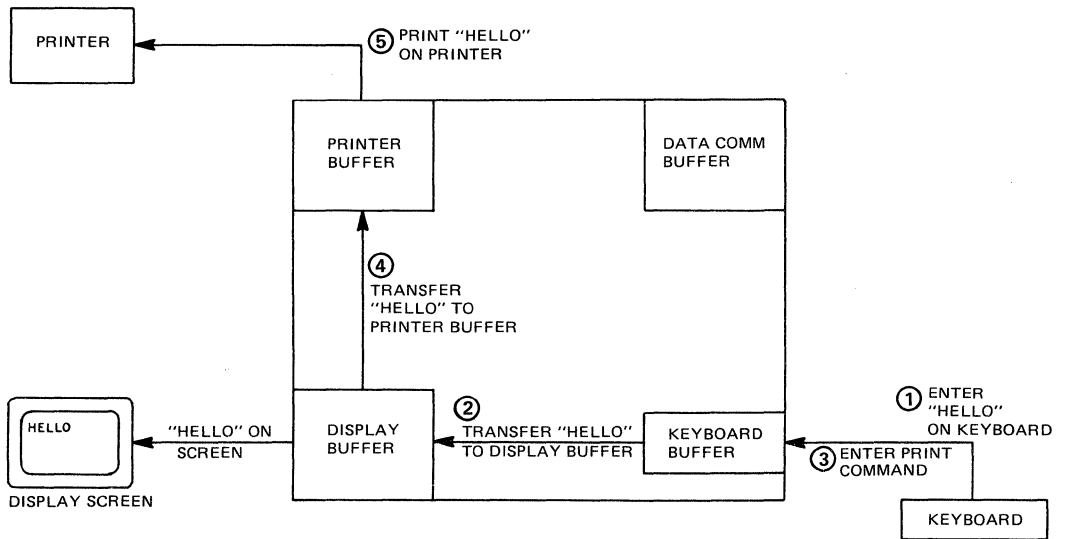

E4808

Figure 8-1. Screen Print Sequence

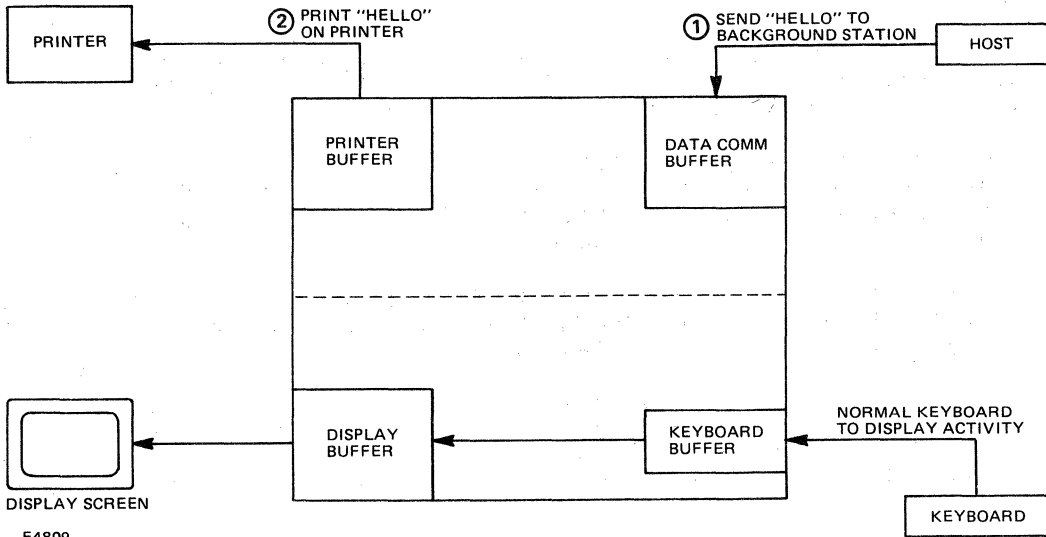

Figure 8-2. Print/Aux Print Sequence

SERIAL PRINTER CONNECTOR PINOUTS

Standards for the I/O pinouts for the connector used with a serial printer attached to the terminal are shown in the following table.

Pin	RS232 Pin Name	I/O	Function
1	frameground	-	frameground (shield)
2	T x D	input	auxiliary data
3	R x D	output	printer data
4	RTS	input	printer busy
5	CTS	output	clear to send (always true)
6	DSR	output	data set ready (always true)
7	signal ground	-	signal ground
8	CD	output	carrier detect (always true)
20	DTR	input	printer ready

Connector: receptical 3387 3365, standoff 2638 6102, or equivalents.

This interface satisfies the requirements of the standard asynchronous interface host.

EXTENDED CHARACTER SETS

Two types of characters can be stored in the display buffer. They are the standard characters (00-7F) and the extended characters (80-FF). When the extended character set is provided, the terminal can display these extended characters from data comm or the keyboard. Refer to appendix H.

DIACRITICS

To display extended characters from the keyboard the diacritic marks are used. There are two types of diacritic marks on the keyboard: stationary cursor and backspace cursor.

When the stationary cursor diacritic mark is entered, the character on the cursor is erased, the diacritic is displayed, and the cursor remains stationary. When the next character is typed, two situations may occur.

1. If it is a character which can be composed with the diacritic, then the extended character representing the diacritic and the typed character is displayed.
2. If it cannot be composed with the diacritic, the typed character overwrites the displayed diacritic and a cursor right is performed. Pressing the space key after a diacritic will leave the diacritic displayed while doing a cursor right.

When a backspace cursor diacritic mark is entered, the character on the cursor is erased and the cursor advances. A backspace or cursor left operation must then be performed before another key is typed. Depending on the typed key, an extended character may not be displayed at this time. In either case, a cursor right is performed.

Refer to appendix J for extended character construction for various language versions.

AUXILIARY INPUT

Input from text is accepted for either the screen at the keyboard cursor position or for the data comm transmission. This depends upon the configuration menu item: AUX INPUT []> (S or D). Actual transmission to the host is initiated when an ETX (03H) character is received.

NOTE: Be careful not to input EOT (04H) characters.

SECTION 9

CONTROL AND ESCAPE SEQUENCES

A control sequence is an instruction initiated from the keyboard. It directs the terminal to perform certain functions. Each control sequence begins by pressing CTRL.

The abbreviation 'SP' represents one depression of the space bar, and a letter in parentheses, (), represents a hexadecimal value.

These control sequences should be used under the guidance of the systems manager.

Escape sequences are like control sequences, except that they are initiated by the host. Each escape sequence begins with the escape code.

CONTROL SEQUENCES

CTRL XMIT	Line-at-a-time transmit.
CTRL (up arrow)	Scrolls up.
CTRL (down arrow)	Scrolls down.
CTRL (right arrow)	Moves cursor to home of next page (VT PAGE ADV [N]); moves cursor down to next vertical tab stop (VT PAGE ADV [Y]).
CTRL (left arrow)	Moves cursor to home of previous page (VT PAGE ADV [N]); moves cursor up to previous vertical tab stop (VT PAGE ADV [Y]).
CTRL CHAR/INS	Sets Insert mode, sets scope flag to "page", inserts a blank at cursor, and clears CTRL indicator.
CTRL CHAR/DEL	If scope = page, deletes the character at cursor position.
CTRL CR	Performs carriage return without storing a CR (hex OD, graphic) character.
CTRL HOME	Sets mobile home line and column to current cursor position.
CTRL ?	Complements horn-enable flag; beeps horn if enabled.
CTRL ;	Prints screen data from home to cursor.
CTRL :	Prints unprotected data from home to cursor.
CTRL]	Prints screen data from home to cursor, no form feed.
CTRL >	Moves cursor to current location of data comm pointer.
CTRL A	Sets Search mode on.
CTRL B	Moves cursor line down.
CTRL E x	Sets search character equal to x.
CTRL H x	Writes logical product of x and 1101 1111 at cursor position.

CONTROL SEQUENCES (CONT.)

CTRL I	Sets video mode of cursor page to green-on-black.
CTRL M	Rolls cursor page down.
CTRL N	Rolls cursor page up.
CTRL O	If variable tab stop option (96/5) is in effect, clears tab stops.
CTRL P	If variable tab stop option (96/5) is in effect, complements tab stop corresponding to the cursor column number.
CTRL Q	Sets Forms mode of cursor page OFF; moves cursor to home position of cursor page; if CLEAR-FORM option (96/3) is in effect, clears page.
CTRL RAhhhh	If RW mode is set, displays 16 scratchpad locations in ASCII, beginning at hhhh.
CTRL RCxxxx	Stores back into scratchpad the RH or RA data currently displayed (if any).
CTRL RHhhhh	If RW mode is set, displays 16 scratchpad locations in HEX, beginning at hhhh.
CTRL RLxxxx	If RW mode is set, displays error log (only /DC ## significant).
CTRL RPxxxx	If RW mode is set, copies scratchpad into EAROM; performs terminal startup.
CTRL RWxxxx	If xxxx = password, clears display store and sets RW mode flag.
CTRL S	Sets Search mode OFF; sets search character equal to "!".
CTRL T	Enables keyboard entry of lowercase characters (clears option 92/6, lowercase lockout).
CTRL U	Sets video mode of cursor page to black-on-green.
CTRL V	Moves a line up.
CTRL W	Transforms cursor page to Forms mode (provided transformation is valid), and moves cursor to first unprotected field.

CONTROL SEQUENCES (CONT.)

- CTRL Y Disables keyboard entry of lowercase characters (sets option 92/6, lowercase lockout).
- CTRL <-c-r Moves cursor to column c, row r on cursor page.
- CTRL hh kk Moves cursor to column hh, row kk on cursor page.
- CTRL-n-n-XMT Transmits ESC-n-n.
- CTRL-space-C-CTRL Clears cursor page; writes character set in first 128 positions.
- CTRL-space-D-CTRL Terminal restart (confidence test, reconfigures from EAROM).
- CTRL-space-E-CTRL Repetitive read-write memory test; restarts on any keystroke.
- CTRL-space-F-CTRL Initiates printer confidence test.
- CTRL-space-H-CTRL Sets data comm bit rate to 600 baud and restarts data comm.
- CTRL-space-J-CTRL Sets data comm bit rate to 1200 baud and restarts data comm.
- CTRL-space-K-CTRL Sets data comm bit rate to 1800 baud (asynch) or 2400 baud (synch) and resets data comm.
- CTRL-space-L-CTRL Initiates key programming sequence
- CTRL-space-M-CTRL Fills display store with "E"
- CTRL-space-V-CTRL Clears cursor page, displays firmware version number.

ESCAPE SEQUENCES

ESC !	Inserts (by line) a blank at the data comm pointer location.
ESC " c r	Moves data comm pointer to (column c, row r) of the page it is on.
ESC ^ hh kk	Moves data comm pointer to hexadecimal column hh and row kk.
ESC #	If variable tab stop option (96/5) is in effect, clears tab stops.
ESC \$ n	Moves data comm pointer to the home position of page n.
ESC %	Deletes (by line) the character at the data comm pointer location; Forms mode by unprotected field.
ESC &	Moves keyboard cursor to the current location of the data comm pointer.
ESC ' x	Writes the logical product of x and 1101 1111.
ESC (Sets transmit-page flag after ETX received.
ESC - x	Sets search character equal to x.
ESC _ x	Fills entire page with character x.
ESC "SO"	Shifts out to extended character set.
ESC "SI"	Resets shift out.
ESC 3	Underlines video highlight translate to SI.
ESC 4	Reverses video highlight translate to SO.
ESC 6	Prevents moving keyboard cursor to DCP upon ETX.
ESC =	Unlocks keyboard keystroke buffer (A1/4 = 1) and places terminal in Local mode.
ESC .	If variable tab stop option (96/5) is in effect, complements the tab stop corresponding to the current data comm pointer column number.
ESC :	Prints unprotected data from home to cursor.
ESC ;	Prints screen data from home to cursor.

ESCAPE SEQUENCES (CONT.)

- ESC < Moves the data comm pointer line DOWN.
- ESC > Moves the data comm pointer line UP.
- ESC ? Beeps horn if enabled.
- ESC Inserts (by page) a blank at the data comm pointer location.
- ESC C Moves data comm pointer one position to the right.
- ESC D Sets mobile home line and column to the line and column of the data comm pointer.
- ESC E Sets Search mode ON.
- ESC F If data comm pointer and keyboard cursor are in the same page, sets Search mode off and sets search character equal to "!".
- ESC J Clears from data comm pointer to end of page (unprotected field).
- ESC K Clears from data comm pointer to end of line (unprotected field).
- ESC L Insert a blank line at data comm pointer location.
- ESC M Deletes the data comm pointer line.
- ESC N Sets video mode of data comm pointer page to black-on-green.
- ESC O Sets video mode of data comm pointer page to green-on-black.
- ESC P Deletes (by page) the data comm pointer character.
- ESC RAhhhhkk Stores next kk bytes of message into scratchpad, beginning at location hhhh.
- ESC RBhhhhkkkkhhh Configures sizes of data comm buffer, display buffer, and programmable key buffer.
- ESC R C xxxx Invokes reconfiguration operation.
- ESC RHhhhhkk Interprets next kk characters of message as hex digits; packs pairs of digits into bytes and stores them into scratchpad beginning at location hhhh.

ESCAPE SEQUENCES (CONT.)

- ESC RKkkk Interprets next kkk pairs of hex characters as key codes and loads into programmable key buffer (cleared first) for function keys F1 through F10, unshifted and shifted.
- ESC R L Transmits contents of error log to host.
- ESC R P Copies scratchpad into EAROM and invokes terminal startup.
- ESC RS kk m Clears user status line and copies the next kk bytes of message m into it; (kk)maximum=72 decimal, 48 hexadecimal.
- ESC RThhhkk Transmits to host machine kk bytes from scratchpad, beginning with location hhhh.
- ESC S Rolls data comm pointer page UP.
- ESC T Rolls data comm pointer page DOWN.
- ESC W Transforms data comm pointer page to Forms mode (provided transformation is valid) and moves data comm pointer to first unprotected field.
- ESC X Sets Forms mode of data comm pointer page OFF.
- ESC Y Disables keyboard entry of lowercase characters.
- ESC Z Enables keyboard entry of lowercase characters.
- ESC J Prints screen data from HOME to cursor; no form feed.
- ESC space C Clears data comm pointer page; stores ASCII character set in first 128 positions.
- ESC space D Terminal restart (confidence test, reconfiguration from EAROM).
- ESC space V Transmits firmware version number to host as V#.p.o.
- ESC "FF" Clears page without clear TABS.
- ESC space F Printer interface test.

APPENDIX A

STANDARD US ASCII CHART

<div style="display: flex; justify-content: space-between; align-items: center;"> <div style="text-align: right;"> b₇ → b₆ → b₅ → </div> <div style="text-align: left;"> 0 0 0 0 0 1 0 1 0 0 1 1 1 0 0 1 0 1 1 1 0 1 1 1 </div> </div>																
b₄ ↓	b₃ ↓	b₂ ↓	b₁ ↓	COL → ROW ↙	0	1	2	3	4	5	6	7				
0	0	0	0	0	NUL	DLE	SP	Ø	Ⓐ	P	\	p/POL				
0	0	0	1	1	SOH	DC 1	!	1	A	Q	a	q/SEL				
0	0	1	0	2	STX	DC 2	"	2	B	R	b	r				
0	0	1	1	3	ETX	DC 3	#	3	C	S	c	s/FSL				
0	1	0	0	4	EOT	DC 4	\$	4	D	T	d	t/BSL				
0	1	0	1	5	ENQ	NAK	%	5	E	U	e	u				
0	1	1	0	6	ACK	SYN	&	6	F	V	f	v				
0	1	1	1	7	BEL	ETB	'	7	G	W	g	w				
1	0	0	0	8	BS	CAN	(8	H	X	h	x				
1	0	0	1	9	HT	EM)	9	I	Y	i	y				
1	0	1	0	10 (A)	LF	SUB	*	:	J	Z	j	z				
1	0	1	1	11 (B)	VT	ESC	+	;	K	[k	{				
1	1	0	0	12 (C)	FF	FS	,	<	L	\	l					
1	1	0	1	13 (D)	CR	GS	-	=	M]	m	}				
1	1	1	0	14 (E)	SO	RS	.	>	N	^	n	~				
1	1	1	1	15 (F)	SI	US	/	?	O	_	o	DEL				

EPI408

APPENDIX B

DATA COMM MESSAGE CHART

HEX CODE	ASCII	VIDEO DISPLAY	ALTERNATE VIDEO DISPLAY
00	NUL	□	NU
01	SOH	┌	SH
02	STX	└	SX
03	ETX	⊠	EX
04	EOT	⤴	ET
05	ENQ	⊠	EQ
06	ACK	√	AK
07	BEL	Ⓚ	BL
08	BS	↶	BS
09	HT	→	HT
0A	LF	≡	LF
0B	VT	↓	VT
0C	FF	⤵	FF
0D	CR	▽	CR
0E	SO	⊗	SO
0F	SI	⊙	SI
10	DLE	▢	DL
11	DC1	⊖	D1
12	DC2	⊖	D2
13	DC3	⊖	D3
14	DC4	⊖	D4
15	NAK	⋈	NK
16	SYN	⌋	SY
17	ETB	└	EB
18	CAN	⊠	CN
19	EM	+	EM
1A	SUB	⸍	SB
1B	ESC	⊖	EC
1C	FS	▣	◇
1D	GS	△	△
1E	RS	◁	◁
1F	US	▷	▷

E5645

APPENDIX C

KEY AND CURSOR PROGRAMMING

A0	A1	A2	A3	A4	A5	A6	A7	A8	A9	AA	AB	AC	AD	AE	AF	
90	91	92	93	94	95	96	97	98	99	9A	9B	9C	9D	9E	9F	
80	81	82	83	84	85	86	87	88	89	8A	8B	8C	8D	8E	8F	
70	71	72	73	74	75	76	77	78	79	7A	7B	7C	7D	7E	7F	
60	62	63	64	65	66	67	68	69	6A	6B	6C	6D	6E	6F		
50	52	53	54	55	56	57	58	59	5A	5B	5C	5D	5E	5F		
41	42	43	44	45	46	47	48	49	4A	4B	4C	4D	4E	4F		
31	32	33	34	35	36	37	38	39	3A	3B	3C	3D	3E	3F		
*	22	23	24	25	26	27	28	29	2A	2B		*		2E		
	12	13	14	15	16	17	18	19	1A	1B				1E		
0B																
03																

F8	F9	FA
F0	F1	F2
E8	E9	EA
E0	E1	E2
D8	D9	DA
D0	D1	D2
C8	C9	CA
C0	C1	C2
B8	B9	BA
B0	B1	B2

* not programmable

KEYBOARD

FB	FC	FD	FE	FF
F3	F4	F5	F6	F7
EB	EC	ED	EE	EF
E3	E4	E5	E6	E7
DB	DC	DD	DE	DF
D3	D4	D5	D6	D7
CB	CC	CD	CE	CF
C3	C4	C5	C6	C7
BB	BC	BD	BE	BF
B3	B4	B5	B6	B7

OPTIONAL
KEYPAD

E5643

FUNCTION CODES

Function Code	Function	Function Code	Function
00	Program End	B4, B5	Escape
01-1F	Control Characters	B6-C3	No Function
20-7F	Alphanumeric Chars.	C4, C5	Reverse Tab
80, 81	Clear	C6, C7	Tab
82, 83	Insert Character	C8-CD	No Function
84	Delete Character	CE, CF	Clear Field
85	Delete Line	D0, D1	Home
86	Clear to End-Of-Line	D2	Caps Lock Enable
87	Clear to End-Of-Page	D3	Caps Lock Disable
88	Roll Down	D4, D5	No function
89	Roll Up	D6, D7	Return
8A	Move Down	D8, D9	No Function
8B	Move Up	DA, DB	Skip
8C-9B	No Function	DC, DD	No Function
9C	Print Unprotected	DE, DF	Reverse Tab
9D	Print All	E0	Tab Set
9E	Forms Enable /	E1	Tab Clear
9F	Forms Disable	E2-E9	No Function
A0, A1	Align	EA, EB	00
A2, A3	End-Of-Transmission	EC, ED	000
A4, A5	Control	F0, F1	Tab
A6, A7	Specify	F6	Cursor Up
A8, A9	Local	F7	Cursor Left
AA, AB	Receive	F8	Cursor Right
AC, AD	Transmit	F9	Cursor Down
AE, AF	Home	FA	Scroll Down
B0	Numeric Lock Enable	FB	Scroll Up
B1	Numeric Lock Disable	FC, FD	Back Page
B2, B3	Skip	FE, FF	Next Page

PROGRAMMABLE CURSOR AND SELECT PAGE CONTROL

Col/ Row/ Page	Char	ASCII Code	E B C D I C	Col/ Row/ Page	Char	ASCII Code	E B C D I C	Point Col/ Row/ Page	Char	ASCII Code	E B C D I C
1	sp	20	40	33	@	40	7C	65	\	60	79
2	!	21	4F	34	A	41	C1	66	a	61	81
3	"	22	7F	35	B	42	C2	67	b	62	82
4	#	23	7B	36	C	43	C3	68	c	63	83
5	\$	24	5B	37	D	44	C4	69	d	64	84
6	%	25	6C	38	E	45	C5	70	e	65	85
7	&	26	50	39	F	46	C6	71	f	66	86
8	`	27	7D	40	G	47	C7	72	g	67	87
9	(28	4D	41	H	48	C8	73	h	68	88
10)	29	5D	42	I	49	C9	74	i	69	89
11	*	2A	5C	43	J	4A	D1	75	j	6A	91
12	+	2B	4E	44	K	4B	D2	76	k	6B	92
13	'	2C	6B	45	L	4C	D3	77	l	6C	93
14	-	2D	60	46	M	4D	D4	78	m	6D	94
15	.	2E	4B	47	N	4E	D5	79	n	6E	95
16	/	2F	61	48	O	4F	D6	80	o	6F	96
17	0	30	F0	49	P	50	D7	81	p	70	97
18	1	31	F1	50	Q	51	D8	82	q	71	98
19	2	32	F2	51	R	52	D9	83	r	72	99
20	3	33	F3	52	S	53	E2	84	s	73	A2
21	4	34	F4	53	T	54	E3	85	t	74	A3
22	5	35	F5	54	U	55	E4	86	u	75	A4
23	6	36	F6	55	V	56	E5	87	v	76	A5
24	7	37	F7	56	W	57	E6	88	w	77	A6
25	8	38	F8	57	X	58	E7	89	x	78	A7
26	9	39	F9	58	Y	59	E8	90	y	79	A8
27	:	3A	7A	59	Z	5A	E9	91	z	7A	A9
28	;	3B	5E	60	[5B	4A	92	{	7B	C0
29	<	3C	4C	61	\	5C	50	93		7C	6A
30	=	3D	7E	62]	5D	5A	94	}	7D	D0
31	>	3E	6E	63	~	5E	5F	95	ç	7E	A1
32	?	3F	6F	64	-	5F	6D	96	DEL	7F	D7

APPENDIX D

CONFIGURATION TABLE

The configuration table is a consolidation of the configuration menu. The table also has more special options than the configuration menu. This table should be used only by the most experienced operator, since hexadecimal calculations are necessary. The configuration options in this table are the hex address locations in memory, and are accessed through a control sequence after the initial control sequence <CTRL>RWMODE is entered. Using the memory address 80 (hex), for example, enter <CTRL>RH0080. (RH is the abbreviation for Read Hex, and the 0080 is the memory address 80 (hex) of the configuration table.) The screen should display the following in the upper, left-hand corner.

```
0080 / 02 E1 32 00 17 4F 7B 7D
      00 53 41 47 09 00 47 41
```

The first hex value after the slash (/) is the value in address 80 (hex). The following fifteen hex values are the values of the subsequent fifteen addresses. For the addresses 00F0 through 00FB, 0108 through 011F, and 0130 through 016F, the contents have more meaning when displayed in ASCII. To display the ASCII values, instead of the hex values a Read ASCII operation is performed. To do this enter <CTRL>RAhhh (where hhh equals the memory address to be displayed. Note that characters in addresses 0108 through 010B (the password to RW, Read/Write mode) must be entered after RW in the control sequence <CTRL>RWxxxx (xxxx equals the four characters in addresses 0108 through 010B).

CONFIGURATION TABLE

Address	Hex Default	Bit	Description	Menu (Default)
80	08	7	1 - synchronous 0 - asynchronous	SYNC (N)
		6	1 - point-to-point (ODT, alternate) 0 - multipoint	POINT TO-POINT (N)
		5	1 - SOH clears DCP page 0 - no action on SOH	SOH CLEAR SCREEN (N)
		4	1 - special Forms-XMT 0 - normal Forms-XMT	FORMS XMIT TO CURSOR (Y)
		3	1 - sets stay-in-RCV flag 0 - clear DCP to end of page	DC1 RCV MOD HOLD (Y)
		2	1 - ODT mode (R/W) 0 - multipoint	ODT (N)
		1	unused	
		0	1 - inhibit parity check 0 - check parity	PARITY CHK (Y)
81	A1	7-0	Baud Rate (see 8C) E9 - 38.4K D1 - 19.2K A1 - 9600 F5 - 4800 E9 - 2400 E1 - 1800 D1 - 1200 A1 - 600 D1 - 300 A1 - 150 96 - 134.5 7E - 110 41 - 75	BPS (9600)
82	00	7-0	CTS delay 0 - 0 msec FF-255 msec	MIN CTS DELAY (000)
83	00	7-0	Turnaround delay 0 - 0 msec FF-255 msec	RCV DELAY (000)

CONFIGURATION TABLE (CONT.)

Address	Hex Default	Bit	Description	Menu (Default)
84	17	7-0	lines/page minus 1 0B = 12 lines/page 17 = 24 lines/page	LINE/PAGE (24)
85		7-0	unused	
86	1F	7-0	alt US delimiter	OPEN ALT FORM DELIM (1F)
87	1E	7-0	alt RS delimiter	CLOSE ALT FORM DELIM (1E)
88	00	7	unused	
		6	transmission numbers (see 88/1) 1 - includes 0 - omitted	TRANS NUM (blank)
		5	unused	
		4	unused	
		3	circuit 116 1 - enabled 0 - disabled	CKT 116 (N)
		2	circuit 111/126 1 - enabled 0 - disabled	CKT 111/126 (N)
		1	transmission numbers if used 1 - 40/41 (A/@) 0 - 30/31 (0/1)	TRANS NUM
		0	poll/select characters 1 - 7B/7C 0 - 70/71	OPT POL/SEL (N)
89	30	7-0	Address 1	SCREEN (00)
8A	30	7-0	Address 2	SCREEN (00)
8B	04	7-0	group select message identifier	GPSELECT (EOT)
8C	08	7-0	Baud Rate (see address 81) 0A - 75 through 300 baud 09 - 600 through 4800 baud 08 - 9600 through 38.4K baud	BPS (9600)

CONFIGURATION TABLE (CONT.)

Address	Hex Default	Bit	Description	Menu (Default)
8D	01	7-0	international language 01 - United States 02 - United Kingdom 03 - France/Belguim 04 - Italy 05 - Germany 06 - Brazil 07 - Spain/Latin America 08 - Denmark/Norway 09 - Croatian (Yugoslavia) 0A - Sweden/Finland 0D - Cyrillic (U.S.S.R.) 0E - Turkey 0F - Greece 10 - Iceland 12 - Sweden 13 - Thailand 14 - Arabic 15 - Hebrew 20 - TERCO B Suisse/French 21 - TERCO A Suisse/German 22 - United States A 23 - United States B 24 - France/Belguim A 25 - Germany A 26 - Brazil A 27 - Spain/Latin America A 28 - Iceland A 29 - Swiss/German 2A - Swiss/French	INTL LANG (01)
8E	04	7-0	group address 1	GROUP POLL (EOT,EOT)
8F	04	7-0	group address 2	GROUP POLL (EOT,EOT)
90	00	7-0	unused	
91	00	7-0	unused	

CONFIGURATION TABLE (CONT.)

Address	Hex Default	Bit	Description	Menu (Default)
92	0C	7	1 - enable 3 bit delay in dropping RTS 0 - disable 3 bit delay in dropping RTS	RTS HOLD (N)
		6	1 - lower case lockout 0 - lower case enable	LOWERCASE LOCKOUT (N)
		5	1 - invisible cursor 0 - visible cursor	CURSOR (R)
		4	1 - no skip to next field 0 - skip to next field	AUTO FORM SKIP (Y)
		3	1 - 24 lines/screen 0 - 12 lines/screen	LINE/SCREEN (24)
		2	1 - 80 characters/line 0 - 40 characters/line	CHAR/LINE (80)
		1	1 - blinking cursor 0 - steady cursor	BLINK CURSOR (N)
		0	1 - move DCP to next line col. 1 0 - move DCP down one line	DCOM LF->CR (N)
93	00	7-0	unused	
94	0F	7-0	display buffer size (MSB) end address	SCREEN (3840)
95	00	7-0	display buffer size (LSB) end address	SCREEN (3840)
96	00	7	1 - no cursor wraparound 0 - cursor wraparound	CURSOR WRAP-AROUND (Y)
		6	1 - TAB key writes -Y before tabbing 0 - TAB key only tabs	HT WRITE FROM KYBD (N)
		5	1 - variable tab stops 0 - fixed tab stops	FIXED TABS (Y)
		4	1 - ETX written at DCP 0 - no ETX written	ETX WRITE FROM DCOM (N)
		3	1 - Forms Mode clear key clears page 0 - clears only unprotected data	CLEAR FORMS (N)
		2	1 - data comm VT advances page CTRL -Y vertical tabs down CTRL X- vertical tabs up 0 - data comm VT tab stops at DCP CTRL -Y and X- changes cursor page	VT PAGE ADV (N)
		1	1 - FF clears DCP page and tab stops 0 - FF clears only DCP page	FF CLR TABS (N)
		0	1 - DC2 advance DCP 0 - DC2 complements Forms Mode of DCP page	DC2 ADV DCP (N)

CONFIGURATION TABLE (CONT.)

Address	Hex Default	Bit	Description	Menu (Default)
97	4F	7-0	end of page alarm 47 - col 72 (for example)	COL END OF PAGE ALARM (80)
98	17	7-0	end of page alarm OB - row 12 (for example)	ROW END OF PAGE ALARM (24)
99	00	7-0	display buffer size (MSB) start address	SCREEN (3840)
9A	00	7-0	display buffer size (LSB) start address	SCREEN (3840)
9B	48	7	1 - no translation of printer control char 0 - translate printer control character to space, except BGL,LF,UT,FF,DC1, DC2, DC3, ESC; CR translated to CRLF.	TRANSLATE (Y)
		6	1 - beep on NAK TO SELECT 0 - no beep	BEEP ON NAK (Y)
		5	1 - inhibit AUTO CR at end of display line 0 - CR at end of display line	EXTEND LINE (N)
		4	unused	
		3	1 - receive ready after Data Comm message 0 - local state after Data Comm message	RCV MODE HOLD (N)
		2	1 - 256 ms delay for CR 0 - no delay	DELAY AFTER CR/LF (N)
		1	unused	
		0	unused	
9C	00	7-0	data comm buffer size (MSB) start address	DCOM (2048)
9D	00	7-0	data comm buffer size (LSB) start address	DCOM (2048)
9E	08	7-0	data comm buffer size (MSB) end address	DCOM (2048)
9F	00	7-0	data comm buffer size (LSB) end address	DCOM (2048)

CONFIGURATION TABLE (CONT.)

Address	Hex Default	Bit	Description	Menu (Default)		
A0	00	7	1 - XMT home at current cursor line 0 - XMT home at mobile home line and col.	LINE-AT-A-TIME TRANSMIT (N)		
		6	1 - RET key stores CR before moving cursor 0 - RET key only moves cursor	CR WRITE FROM KYBD (N)		
		5	1 - RET key moves to col 1 of same line 0 - RET key moves to col 1 of next line	KBD CR/LF (N)		
		4	1 - data comm stores CR before moving DCP 0 - data comm only moves DCP	CR WRITE FROM DCOM (N)		
		3	1 - dcomm CR moves DCP to col 1 same line 0 - dcomm CR moves DCP to col 1 next line	DCOM CR->LF (Y)		
		2	1 - advance DCP after storing ETX 0 - leave DCP ON ETX	ETX ADV (N)		
		1	1 - SOH leaves all pages in Forms Mode 0 - SOH disables all pages from Forms Mode	SOH EXIT FORMS (Y)		
		0	1 - store HT before tabbing DCP 0 - tab DCP only	HT WRITE FROM DCOM (N)		
		A1	00	7	1 - retain variable tab stops 0 - clear variable tab stops	TAB RETAIN (N)
				6	1 - Specify key, hex row, col 0 - Specify key, ASCII row, col	SPECIFY KEY (A)
5	1 - fast fill enable 0 - fast fill disable			EARLY FILL SCREEN (N)		
4	1 - keystroke buffer enable 0 - keystroke buffer disable			KEYSTROKE BUFFER (N)		
3	1 - transmit highlight ESC/3, ESC/4, ESC', ESC/ 0 - transmit highlight SI/SO			SI/SO XLT (N)		
2	1 - SI/SO extended character sets 0 - SI/SO perform highlighting			SI/SO XTN (N)		
1	unused					
0	unused					
A2	01	7-0	keyboard buffer size (MSB)	KEYBOARD (0256)		
A3	00	7-0	keyboard buffer size (LSB)	KEYBOARD (0256)		

CONFIGURATION TABLE (CONT.)

Address	Hex Default	Bit	Description	Menu (Default)
A4	20	7-0	background printer address 1	PRINT/AUX () [SP!]
A5	21	7-0	background printer address 2	PRINT/AUX () [SP!]
A6	08	7-0	printer buffer size (MSB)	PRINTER (2048)
A7	00	7-0	printer buffer size (LSB)	PRINTER (2048)
A8	56	7-4	repeat delay 0 - no repeat 1 - 0.1 sec 2 - 0.2 sec 3 - 0.3 sec 4 - 0.4 sec 5 - 0.5 sec 6 - 0.6 sec 7 - 0.7 sec 8 - 0.8 sec 9 - 0.9 sec A - 1.0 sec B - 1.1 sec C - 1.2 sec D - 1.3 sec E - 1.4 sec F - 1.5 sec	RPT DELAY (05)
		3-0	repeat rate 0 - no repeat 1 - 5 c/s 2 - 7 c/s 3 - 9 c/s 4 - 11 c/s 5 - 13 c/s 6 - 15 c/s 7 - 17 c/s 8 - 19 c/s 9 - 21 c/s A - 25 c/s B - 30 c/s C - 40 c/s D - 50 c/s E - 60 c/s F - 70 c/s	RPT RATE (06)

CONFIGURATION TABLE (CONT.)

Address	Hex Default	Bit	Description	Menu (Default)
A9	0A	7	1 - cursor underline 0 - cursor block	CURSOR [R]
		6	1 - RS232 0 - TDI/BDAA	RS232 ()
		5	1 - 60 HZ 0 - 50 HZ	60 HZ (Y)
		4	1 - enable keystroke buffer 0 - keystrokes not buffered	KEYSTROKE BUFFER (N)
		3-2	alarm level 00 - off 01 - low 10 - medium 11 - loud	ALARM LEVEL (2)
		1-0	click level 00 - off 01 - low 10 - medium 11 - loud	CLICK LEVEL (2)
		AA		7-0
AB		7-0	CRC for permanent storage	
AC		7-0	unused	
AD	0A	7	1 - inhibit parity check 0 - enable parity check	PARITY CHK (Y)
		6	1 - printer interface odd parity 0 - printer interface even parity	PARITY (E/O) (E)
		5	1 - two stop bits 0 - one stop bit	EXTRA STOP BITS (N)
		4	1 - 1 is printer busy 0 - 0 is printer busy	BUSY (0/1) (0)
		3-2	00 - five bits per character 01 - six bits per character 10 - seven bits per character 11 - eight bits per character	BITS/CHAR (7)
		1	1 - enable parity bit 0 - disable parity bit	PARITY BIT (Y)
		0	1 - aux input load to screen 0 - aux input load to data comm buffer	AUX INPUT (D)

CONFIGURATION TABLE (CONT.)

Address	Hex Default	Bit	Description	Menu (Default)
AE	A1	7-0	printer baud rate 41 - 75 baud 7E - 110 baud 96 - 134.5 baud A1 - 150 baud D1 - 300 baud A1 - 600 baud D1 - 1200 baud E1 - 1800 baud E9 - 2400 baud F5 - 4800 baud A1 - 9600 baud D1 - 19.2K baud	BPS (1200)
AF	08	7-0	printer baud rate 0A - 75 through 300 baud 09 - 600 through 4800 baud 08 - 9600 and 19.2K baud	BPS (1200)
B0-B3			unused	
B4		7	1 - filter print data removes NUL through ACK and SO through US codes 0 - background print transparent data	FILTER [N]
		6-0	unused	
B5		7-0	character returned in response to print message EOT disables	LOGACK [^E Y]
B6		7-0	XON handshake with printer	XON/XOFF [^E T ^E T]
B7		7-0	XOFF handshake with printer EOT disables	XON/XOFF [^E T ^E T]
B8 - EF			unused	
F0-27F			(See ASCII Representations.)	

ASCII REPRESENTATIONS (ADDRESSES 00F0 THROUGH 027F)

ADDRESS	0	0	0	0	0	0	0	0	0	0	0	0	0	0	0	0
	0	0	0	0	0	0	0	0	0	0	0	0	0	0	0	0
	F	F	F	F	F	F	F	F	F	F	F	F	F	F	F	F
	0	1	2	3	4	5	6	7	8	9	A	B	C	D	E	F
ASCII REP	C	T	R	L	(unused)	F	O	R	M	(unused)						

ADDRESS	0	0	0	0	0	0	0	0	0	0	0	0	0	0	0	0
	1	1	1	1	1	1	1	1	1	1	1	1	1	1	1	1
	0	0	0	0	0	0	0	0	0	0	0	0	0	0	0	0
	0	1	2	3	4	5	6	7	8	9	A	B	C	D	E	F
ASCII REP	**	(Key Program buffer size)*					M	O	D	E	P	A	G	E		

NOTES: * Address 102-103 is set to start address of Softkey Buffer. Default value is 0180.
 Address 104-105 is set to end address of Softkey Buffer. Default value is 027F.
 ** Status Line start address.

ADDRESS	0	0	0	0	0	0	0	0	0	0	0	0	0	0	0	0
	1	1	1	1	1	1	1	1	1	1	1	1	1	1	1	1
	1	1	1	1	1	1	1	1	1	1	1	1	1	1	1	1
	0	1	2	3	4	5	6	7	8	9	A	B	C	D	E	F
ASCII REP	BUFFER OVERFLOW															

ADDRESS	0	0	0	0	0	0	0	0	0	0	0	0	0	0	0	0
	1	1	1	1	1	1	1	1	1	1	1	1	1	1	1	1
	2	2	2	2	2	2	2	2	2	2	2	2	2	2	2	2
	0	1	2	3	4	5	6	7	8	9	A	B	C	D	E	F
ASCII REP	(unused)															

ASCII REPRESENTATIONS (CONTINUED)

ADDRESS	0 0 0 0 0 0 0 0 0 0 0 0 0 0 0
	1 1 1 1 1 1 1 1 1 1 1 1 1 1 1
	3 3 3 3 3 3 3 3 3 3 3 3 3 3 3
	0 1 2 3 4 5 6 7 8 9 A B E F C D
ASCII REP	P R I N T E R b b E R R O R b b

ADDRESS	0 0 0 0 0 0 0 0 0 0 0 0 0 0 0
	1 1 1 1 1 1 1 1 1 1 1 1 1 1 1
	4 4 4 4 4 4 4 4 4 4 4 4 4 4 4
	0 1 2 3 4 5 6 7 8 9 A B C D E F
ASCII REP	R E C E I V E b b E R R O R b b

ADDRESS	0 0 0 0 0 0 0 0 0 0 0 0 0 0 0
	1 1 1 1 1 1 1 1 1 1 1 1 1 1 1
	5 5 5 5 5 5 5 5 5 5 5 5 5 5 5
	0 1 2 3 4 5 6 7 8 9 A B C D E F
ASCII REP	K E Y S T R O K E b b L O S T b

ADDRESS	0 0 0 0 0 0 0 0 0 0 0 0 0 0 0
	1 1 1 1 1 1 1 1 1 1 1 1 1 1 1
	6 6 6 6 6 6 6 6 6 6 6 6 6 6 6
	0 1 2 3 4 5 6 7 8 9 A B C D E F
ASCII REP	R E C E I V I N G b _ b P . b b

ADDRESS 0170 - 017F (not used).

ADDRESS 0180 - 027F Default Softkey Buffer

NOTE:

If memory locations 010C-010F are changed from "PAGE" to blanks (these memory addresses are part of those used for the status line), then the page number never appears while doing NEXT/PREVIOUS PAGE functions. Also, "RECEIVING PG" made to blanks at location 0160 does not show page numbers. The terminal should also suppress the numbers under these conditions as the host can write to the status line.

E5642

APPENDIX E

TERMINAL TESTS

The terminal has two test routines to ensure correct operation: the Confidence Test Routines (CTR), and the Maintenance Test Routines (MTR).

CONFIDENCE TEST ROUTINES (CTR)

The CTR is provided with superior reliability, and tests all the major hardware functions. The CTR is initiated when you turn on the terminal, enter CTRL sp D CTRL, or when ESC sp D is sent from the host.

Once the CTR has been initiated, all the lamp indicators on the keyboard come on. When the CTR is complete, all the lamp indicators on the keyboard go off, except the local indicator. At the same time, the contents of the EAROM are transferred to the configuration menu, six asterisks are displayed on the screen, and the buzzer sounds.

The following Confidence Test Routines are executed in approximately thirty seconds:

1. ROM test.
2. RAM test.
3. Battery back-up RAM test.
4. Timer test.
5. Data comm interface test.
6. Keyboard interface test.
7. Keyboard test.
8. Printer, AUX interface test.

MAINTENANCE TEST ROUTINES (MTR)

Once the CTR has been completed, you can perform any of the following MTRs by entering the specified control sequence from the keyboard, or by sending the specified escape sequence from the host.

RAM TEST

Control Sequence	CTRL sp E CTRL
Escape Sequence	ESC sp E

The RAM test is executed until an error is detected, or any key is pressed. If no error is detected, and a key is pressed, then the CTR is executed.

PRINTER INTERFACE TEST

Control Sequence	CTRL sp F CTRL
Escape Sequence	ESC sp F

ALL CHARACTER DISPLAY

Control Sequence	CTRL sp C CTRL
Escape Sequence	ESC sp C

"E" DISPLAY

Control Sequence	CTRL sp M CTRL
Escape Sequence	ESC sp M

ERROR DISPLAY

If an error is detected while a CTR or MTR is executing, the appropriate error code(s) is displayed on the screen.

Pressing the local key returns the terminal to normal operation.

Note: This should only be done after the error is reported to a trained service representative who recommends this action.

Error

Error Code	Test	Description of Error
BAhhhh	RAM	Data was written in lAhhhh, and an error was detected in address BAhhhh.
Bnhhhh	RAM	Address hhhh (hex) was checked and an error was detected in value of n bit. If hhhh is 8000 to EBFF, then an error exists in RW memory. If hhhh is F000 to FFFF, then an error exists in front memory.
CEhhhh 00hhhh	ROM	A CRC error was detected. CEhhhh: hhhh is starting address of block causing error. 00hhhh: hhhh is ending address of block causing error.
Tn0000	Timer	A timer does not operate, or a timer count is outside the 50% range. n=1=Timer 1, n=2=Timer 2, n=3=Timer 3

Error Code	Test	Description of Error
PR000n	Print	A printer interface error occurred. n=1: received data error n=2: time out during receive n=3: time out during transmit n=4: received parity error n=5: received overrun n=6: received framing error
KB000n	Kybd	A keyboard interface error occurred. n=1: received data error n=2: time out during receive n=3: time out during transmit n=4: received parity error n=5: received overrun n=6: received framing error n=7: keyboard test error - <i>STUCK KEY</i>
EC0000	EAROM	A CRC error when the EAROM was read.
CDhhhh	Config	A configuration error was detected in the configuration table at hhhh (hex) address.

APPENDIX F

COMMONLY USED CTRL H SEQUENCES

Sequence	Hex Code	Char	Effect
CTRL H \$	04	EOT	disable menu parameters
CTRL H .	0F	SI	begin underline video
CTRL H /	0E	SO	begin reverse video
CTRL H 7	17	ETB	end highlight
CTRL H 8	18	CAN	begin blink video
CTRL H 9	19	EM	begin secure video
CTRL H :	1A	SUB	begin bright video
CTRL H <	1C	FS	begin protected text field
CTRL H =	1D	GS	begin right-justified text field
CTRL H >	1E	RS	end field or highlight
CTRL H ?	1F	US	begin left-justified text field

APPENDIX G

PAGES OF DISPLAY TABLE

For full screen size = 24 lines per page

1	page =	1,920	bytes
2	page =	3,840	bytes
3	page =	5,760	bytes
4	page =	7,680	bytes
5	page =	9,600	bytes
6	page =	11,520	bytes
7	page =	13,440	bytes
8	page =	15,360	bytes
9	page =	17,280	bytes
10	page =	19,200	bytes

The number of pages is calculated as follows:

$$\#pages = display\ buffer\ size / (char/line) * (line/page)$$

Note: When a surplus of lines is in a page arrangement, these surplus lines of memory are not used.

If the size of the page is larger than that of the screen data entry, and the cursor function will not cause the screen to scroll, the displayed lines are always adjusted to keep the cursor visible.

APPENDIX H

SO/SI XTN AND SO/SI XLT OPTIONS FOR TEXT RECEIVED FROM AND TRANSMITTED TO DATA COMM

Receiving from data comm:

Received	Configuration	Function
ESC S0		Select extended character. After this sequence each character received is OR'd with 80 (hex).
ESC SI		Select standard character.
S0	SO/SI XTN=Y SO/SI XTN=N	Same as ESC S0. Reverse highlight.
SI	SO/SI XTN=Y SO/SI XTN=N	Same as ESC SI. Underline highlight.
ESC 3 ESC'/		Underline highlight with SI to the display buffer.
ESC 4 ESC'.		Reverse highlight with S0 to the display buffer.

Note: Received text starts from SI status always.

Transmitting to data comm:

Transmitted	Configuration	Display Buffer
ESC SO SO	SO/SI XTN=N SO/SI XTN=Y	An extended character is detected after a standard character.
SO	SO/SI XTN=N and SO/SI XLT=N	SO(reverse highlight).
ESC SI SI	SO/SI XTN=N SO/SI XTN=Y	A standard character is detected after an extended character.
SI	SO/SI XTN=N and SO/SI XLT=N	SI(underline highlight).
ESC 4*	SO/SI XLT=Y and SO/SI XTN=N -or- SO/SI XLT=N and SO/SI XTN=Y	SO (reverse highlight).
ESC 3*	SO/SI XLT=Y and SO/SI XTN=N -or- SO/SI XLT=N and SO/SI XTN=Y	SI (underline highlight).
ESC '.	SO/SI XLT=Y and SO/SI XTN=Y	SO (reverse highlight).
ESC '/	SO/SI XLT=Y and SO/SI XTN=Y	SI (underline highlight).

SO/SI XLT=N and SO/SI XTN=N or SO/SI XLT=Y and SO/SI XTN=Y are recommended settings. These allow the use of the SO/SI (as data comm extended delimiters and screen highlights) and CTRL ## XMIT within the same application.

ESC/SO, ESC/SI, ESC/3, ESC/4, ESC'., and ESC'/ always produce the same function. That is, configuration is ignored upon reception from data comm.

NOTE

Options ESC4/ESC3 are in conflict with another function of the terminal (CTRL ## XMIT). Therefore, these settings and conditions are not implemented on any Burroughs terminal or workstation (MT985 or ET1000 Series replacements or emulations) shipped after January 1, 1986.

APPENDIX I MEMORY MAP

Address Range	Firmware Memory Map	Size
0000 7FFF		32,768 bytes
8000 82FF	Configuration Table	
8300 8300	Status Line	
	System Work Area	7,168 bytes
9C00 9C00	Display Parameter	
	Display Buffer	
	Data Comm Buffer	
	Softkey Buffer	
	Print Buffer	
FBFF FBFF	Keyboard Buffer	24,576 bytes
FC00 FC00	CMOS RAM Area	1,024 bytes

APPENDIX J

CONSTRUCTION OF EXTENDED CHARACTERS LANGUAGE VERSIONS

CODE CHART	VERSION 1.1A,1B

COL ROW	0	1	2	3	4	5	6	7	8	9	10 (A)	11 (B)	12 (C)	13 (D)	14 (E)	15 (F)
0	NU	DL	þ	0	@	P	·	p				Ë	ö	h	ë	ö
1	SH	D1	!	1	A	Q	a	q			À	Ğ	ø	à	ğ	ø
2	SX	D2	”	2	B	R	b	r			Á	Ì	Ş	á	ì	ş
3	EX	D3	#	3	C	S	c	s			Â	Í	Š	â	í	š
4	ET	D4	\$	4	D	T	d	t			Ã	Î		ã	î	ß
5	EQ	NK	%	5	E	U	e	u			Ä	Ï	þ	ä	ı	þ
6	AK	SY	&	6	F	V	f	v			Æ	Ï	Ù	æ	ï	ù
7	BL	EB	,	7	G	W	g	w			Æ	IJ	Ú	æ	ij	ú
8	BS	CN	(8	H	X	h	x			Ć	Ĵ	Û	ć	ĵ	û
9	HT	EM)	9	I	Y	i	y			Ç	Ł	Ü	ç	ł	ü
10 (A)	LF	SB	*	:	J	Z	j	z			Č	Ń	Ű	č	ň	ű
11 (B)	VT	EC	+	;	K	Ł	k	ł			Đ	CE	Ý	đ	ce	ý
12 (C)	FF	◇	,	<	L	\	l	;				Ò	Ÿ	đ	ò	ÿ
13 (D)	CR	△	-	=	M]	m	}			È	Ó	Ÿ	è	ó	ÿ
14 (E)	SO	◁	·	>	N	ˆ	n	˘			É	Ô	Ž	é	ô	ž
15 (F)	SI	▷	/	?	O	_	o	■			Ê	Õ		ê	õ	

<div style="display: flex; justify-content: space-around;"> CODE CHART VERSION 2 </div>	

COL ROW	0	1	2	3	4	5	6	7	8	9	10 (A)	11 (B)	12 (C)	13 (D)	14 (E)	15 (F)
0	NU	DL	þ	0	@	P	`	p								
1	SH	D1	!	1	A	Q	a	q								
2	SX	D2	"	2	B	R	b	r								
3	EX	D3	£	3	C	S	c	s								
4	ET	D4	\$	4	D	T	d	t								
5	EQ	NK	%	5	E	U	e	u								
6	AK	SY	&	6	F	V	f	v								
7	BL	EB	,	7	G	W	g	w								
8	BS	CN	(8	H	X	h	x								
9	HT	EM)	9	I	Y	i	y								
10 (A)	LF	SB	*	:	J	Z	j	z								
11 (B)	VT	EC	+	;	K	[k	{								
12 (C)	FF	◇	,	<	L	\	l	!								
13 (D)	CR	△	-	=	M]	m	}								
14 (E)	SO	◁	·	>	N	^	n	—								
15 (F)	SI	▷	/	?	O	_	o	■								

<p>CODE CHART VERSION 3,3A</p>	
--	--

COL ROW	0	1	2	3	4	5	6	7	8	9	10 (A)	11 (B)	12 (C)	13 (D)	14 (E)	15 (F)
0	NU	DL	þ	o	@	P	`	p				Ë	ö	h	ë	ö
1	SH	D1	!	1	A	Q	a	q			À	Ǧ	ø	à	ǧ	ø
2	SX	D2	"	2	B	R	b	r			Á	ì	ş	á	î	ş
3	EX	D3	£	3	C	S	c	s			Â	í	š	â	í	š
4	ET	D4	\$	4	D	T	d	t			Ã	î		ã	î	þ
5	EQ	NK	%	5	E	U	e	u			Ä	ï	þ	ä	ı	þ
6	AK	SY	&	6	F	V	f	v			Å	ï	ù	å	ï	ù
7	BL	EB	,	7	G	W	g	w			Æ	ıı	ú	æ	ıı	ú
8	BS	CN	(8	H	X	h	x			Ç	ı	û	ç	ı	û
9	HT	EM)	9	I	Y	i	y			Ç	ı	ü	ç	ı	ü
10 (A)	LF	SB	*	:	J	Z	j	z			Č	ň	ŵ	č	ň	ŵ
11 (B)	VT	EC	+	;	K	[k	ƒ			Đ	CE	Ý	đ	ce	ý
12 (C)	FF	◇	,	<	L	\	l	ı				ò	ŷ	đ	ò	ŷ
13 (D)	CR	△	-	=	M]	m	ı			È	ó	Ÿ	è	ó	ŷ
14 (E)	SO	◁	.	>	N	^	n	—			É	ô	ž	é	ô	ž
15 (F)	SI	▷	/	?	O	_	o	■			Ê	õ		ê	õ	

<p>CODE CHART VERSION 4</p>	

COL ROW	0	1	2	3	4	5	6	7	8	9	10 (A)	11 (B)	12 (C)	13 (D)	14 (E)	15 (F)
0	NU	DL	♢	0	@	P	`	p								
1	SH	D1	!	1	A	Q	a	q								
2	SX	D2	”	2	B	R	b	r								
3	EX	D3	£	3	C	S	c	s								
4	ET	D4	\$	4	D	T	d	t								
5	EQ	NK	%	5	E	U	e	u								
6	AK	SY	&	6	F	V	f	v								
7	BL	EB	,	7	G	W	g	w								
8	BS	CN	(8	H	X	h	x								
9	HT	EM)	9	I	Y	i	y								
10 (A)	LF	SB	*	:	J	Z	j	z								
11 (B)	VT	EC	+	;	K	[k	{								
12 (C)	FF	◇	,	<	L	\	l	;								
13 (D)	CR	△	-	=	M]	m	}								
14 (E)	SO	◁	.	>	N	^	n	—								
15 (F)	SI	▷	/	?	O	_	o	■								

<p>CODE CHART VERSION 5,5A</p>	

COL ROW	0	1	2	3	4	5	6	7	8	9	10 (A)	11 (B)	12 (C)	13 (D)	14 (E)	15 (F)
0	NU	DL	þ	0	S	P	·	p				Ë	ö	h	ë	ö
1	SH	D1	!	1	A	Q	a	q			À	Ğ	ø	à	ğ	ø
2	SX	D2	..	2	B	R	b	r			Á	İ	Ş	á	ı	ş
3	EX	D3	£	3	C	S	c	s			Â	Í	Š	â	í	š
4	ET	D4	\$	4	D	T	d	t			Ã	Î		ã	î	þ
5	EQ	NK	%	5	E	U	e	u			Ä	İ	þ	ä	ı	þ
6	AK	SY	&	6	F	V	f	v			Å	Ï	Ù	å	ï	ù
7	BL	EB	,	7	G	W	g	w			Æ	IJ	Ú	æ	ij	ú
8	BS	CN	(8	H	X	h	x			Ć	Í	Û	ć	ı	û
9	HT	EM)	9	I	Y	i	y			Ç	L	Ü	ç	ı	ü
10 (A)	LF	SB	*	:	J	Z	j	z			Č	Ñ	Ŵ	č	ñ	ŵ
11 (B)	VT	EC	+	;	K	Ä	k	ä			Đ	CE	Ý	đ	ce	ý
12 (C)	FF	◇	,	<	L	ö	l	ö				Ò	ÿ	đ	ò	ÿ
13 (D)	CR	△	-	=	M	Ü	m	ü			È	Ó	ÿ	è	ó	ÿ
14 (E)	SO	◁	·	>	N	ˆ	n	β			É	Ô	Ž	é	ô	ž
15 (F)	SI	▷	/	?	O	ˉ	o	■			Ê	Õ		ê	õ	

CODE CHART VERSION 6.6A	

COL ROW	0	1	2	3	4	5	6	7	8	9	10 (A)	11 (B)	12 (C)	13 (D)	14 (E)	15 (F)
0	NU	DL	þ	0	@	P	`	p				Ë	ö	h	ë	ö
1	SH	D1	!	1	A	Q	a	q			À	Ǧ	ø	à	ǧ	ø
2	SX	D2	"	2	B	R	b	r			Á	ì	ş	á	î	ş
3	EX	D3	#	3	C	S	c	s			Â	í	š	â	í	š
4	ET	D4	\$	4	D	T	d	t			Ã	î		ã	î	β
5	EQ	NK	%	5	E	U	e	u			Ä	ï	þ	ä	ı	þ
6	AK	SY	&	6	F	V	f	v			Å	ï	ù	å	ï	ù
7	BL	EB	,	7	G	W	g	w			Æ	IJ	Ú	æ	ij	ú
8	BS	CN	(8	H	X	h	x			Ć	Ĵ	Û	ć	ĵ	û
9	HT	EM)	9	I	Y	i	y			Ç	Ľ	Ü	ç	ı	ü
10 (A)	LF	SB	*	:	J	Z	j	z			Č	Ň	Ŧ	č	ň	ŧ
11 (B)	VT	EC	+	;	K	Œ	k	œ			Đ	CE	Ý	đ	ce	ý
12 (C)	FF	◇	,	<	L	Ç	l	ç				Ò	Ÿ	đ	ò	ÿ
13 (D)	CR	△	-	=	M	Ã	m	ã			È	Ó	Ÿ	è	ó	ÿ
14 (E)	SO	◁	.	>	N	ˆ	n	ˆ			É	Ô	Ž	é	ô	ž
15 (F)	SI	▷	/	?	O	ˉ	o	■			Ê	Õ		ê	õ	

CODE CHART VERSION 7.7A	

COL ROW	0	1	2	3	4	5	6	7	8	9	10 (A)	11 (B)	12 (C)	13 (D)	14 (E)	15 (F)
0	NU	DL	þ	0	@	P	`	p				Ë	ö	h	ë	ö
1	SH	D1	!	1	A	Q	a	q			À	Ğ	ø	à	ğ	ø
2	SX	D2	"	2	B	R	b	r			Á	Ì	Ş	á	ì	ş
3	EX	D3	#	3	C	S	c	s			Â	Í	Š	â	í	š
4	ET	D4	\$	4	D	T	d	t			Ã	Î		ã	î	þ
5	EQ	NK	%	5	E	U	e	u			Ä	Ï	þ	ä	ı	þ
6	AK	SY	&	6	F	V	f	v			Ř	Ï	Ù	ř	ï	ù
7	BL	EB	,	7	G	W	g	w			Æ	IJ	Ú	æ	ij	ú
8	BS	CN	(8	H	X	h	x			Ć	Ĵ	Û	ć	ĵ	û
9	HT	EM)	9	I	Y	i	y			Ç	Ł	Ü	ç	ł	ü
10 (A)	LF	SB	*	:	J	Z	j	z			Č	Ň	Ŧ	č	ň	ŧ
11 (B)	VT	EC	+	;	K	Ł	k	ł			Đ	CE	Ý	đ	ce	ý
12 (C)	FF	◇	,	<	L	Ñ	l	ñ				Ò	Ÿ	đ	ò	ÿ
13 (D)	CR	△	-	=	M	Ĵ	m	ĵ			È	Ó	Ÿ	è	ó	ÿ
14 (E)	SO	◁	.	>	N	^	n	^			É	Ô	Ž	é	ô	ž
15 (F)	SI	▷	/	?	O	-	o	■			Ê	Õ		ê	õ	

<p>CODE CHART VERSION 8</p>	

COL ROW	0	1	2	3	4	5	6	7	8	9	10 (A)	11 (B)	12 (C)	13 (D)	14 (E)	15 (F)
0	NU	DL	þ	0	Ö	P	ö	p								
1	SH	D1	!	1	A	Q	a	q								
2	SX	D2	"	2	B	R	b	r								
3	EX	D3	£	3	C	S	c	s								
4	ET	D4	\$	4	D	T	d	t								
5	EQ	NK	%	5	E	U	e	u								
6	AK	SY	&	6	F	V	f	v								
7	BL	EB	,	7	G	W	g	w								
8	BS	CN	(8	H	X	h	x								
9	HT	EM)	9	I	Y	i	y								
10 (A)	LF	SB	*	:	J	Z	j	z								
11 (B)	VT	EC	+	;	K	Æ	k	æ								
12 (C)	FF	◇	,	<	L	Ø	l	ø								
13 (D)	CR	△	-	=	M	Ř	m	ř								
14 (E)	SO	◁	·	>	N	Ü	n	ü								
15 (F)	SI	▷	/	?	O	Ǻ	o	ǻ								

<p>CODE CHART VERSION 9</p>	

COL ROW	0	1	2	3	4	5	6	7	8	9	10 (A)	11 (B)	12 (C)	13 (D)	14 (E)	15 (F)
0	NU	DL	þ	0	Š	P	·	p								
1	SH	D1	!	1	A	Q	a	q								
2	SX	D2	“	2	B	R	b	r								
3	EX	D3	£	3	C	S	c	s								
4	ET	D4	\$	4	D	T	d	t								
5	EQ	NK	%	5	E	U	e	u								
6	AK	SY	&	6	F	V	f	v								
7	BL	EB	,	7	G	W	g	w								
8	BS	CN	(8	H	X	h	x								
9	HT	EM)	9	I	Y	i	y								
10 (A)	LF	SB	*	:	J	Z	j	z								
11 (B)	VT	EC	+	;	K	Ć	k	ć								
12 (C)	FF	◊	,	<	L	Č	l	č								
13 (D)	CR	△	-	=	M	Š	m	š								
14 (E)	SO	◁	·	>	N	Ž	n	ž								
15 (F)	SI	▷	/	?	O	—	o	■								

<p>CODE CHART VERSION 13</p>	

COL ROW	0	1	2	3	4	5	6	7	8	9	10 (A)	11 (B)	12 (C)	13 (D)	14 (E)	15 (F)
0	NU	DL	Ø	0	@	Р	Ю	П								
1	SH	D1	!	1	A	Q	А	Я								
2	SX	D2	"	2	B	R	Б	Р								
3	EX	D3	#	3	C	S	Ц	С								
4	ET	D4	\$	4	D	T	Д	Т								
5	EQ	NK	%	5	E	U	Е	У								
6	AK	SY	&	6	F	V	Ф	Ж								
7	BL	EB	,	7	G	W	Г	В								
8	BS	CN	(8	H	X	Х	Ь								
9	HT	EM)	9	I	Y	И	Ы								
10 (A)	LF	SB	*	:	J	Z	Й	З								
11 (B)	VT	EC	+	;	K	[К	Ш								
12 (C)	FF	◇	,	<	L	∨	Л	Э								
13 (D)	CR	△	-	=	M]	М	Щ								
14 (E)	SO	◁	·	>	N	Ь	Н	Ч								
15 (F)	SI	▷	/	?	O	_	О	■								

CODE CHART VERSION 14	

COL ROW	0	1	2	3	4	5	6	7	8	9	10 (A)	11 (B)	12 (C)	13 (D)	14 (E)	15 (F)
0	NU	DL	ð	0	Ç	P	ç	p								
1	SH	D1	!	1	A	Q	a	q								
2	SX	D2	"	2	B	R	b	r								
3	EX	D3	Ł	3	C	S	c	s								
4	ET	D4	\$	4	D	T	d	t								
5	EQ	NK	%	5	E	U	e	u								
6	AK	SY	&	6	F	V	f	v								
7	BL	EB	,	7	G	W	g	w								
8	BS	CN	(8	H	X	h	x								
9	HT	EM)	9	I	Y	i	y								
10 (A)	LF	SB	*	:	J	Z	j	z								
11 (B)	VT	EC	+	;	K	İ	k	ı								
12 (C)	FF	◇	,	<	L	Ö	l	ö								
13 (D)	CR	△	-	=	M	Ş	m	ş								
14 (E)	SO	◁	·	>	N	Ū	n	ū								
15 (F)	SI	▷	/	?	O	Ǧ	o	ǧ								

<p>CODE CHART VERSION 15</p>	

COL ROW	0	1	2	3	4	5	6	7	8	9	10 (A)	11 (B)	12 (C)	13 (D)	14 (E)	15 (F)
0	NU	DL	þ	0	@	P	`	π								
1	SH	D1	!	1	A	Q	A	P								
2	SX	D2	"	2	B	R	B	Σ								
3	EX	D3	#	3	C	S	Γ	T								
4	ET	D4	\$	4	D	T	Δ	Y								
5	EQ	NK	%	5	E	U	E	Φ								
6	AK	SY	&	6	F	V	Z	X								
7	BL	EB	,	7	G	W	H	Ψ								
8	BS	CN	(8	H	X	Θ	Ω								
9	HT	EM)	9	I	Y	I	ΔP								
10 (A)	LF	SB	*	:	J	Z	K	πΣ								
11 (B)	VT	EC	+	;	K	[^	{								
12 (C)	FF	◇	,	<	L	\	M	!								
13 (D)	CR	△	-	=	M]	N	}								
14 (E)	SO	◁	.	>	N	^	≡	~								
15 (F)	SI	▷	/	?	O	-	O	■								

<p>CODE CHART VERSION 16.16A</p>	
--	--

COL ROW	0	1	2	3	4	5	6	7	8	9	10 (A)	11 (B)	12 (C)	13 (D)	14 (E)	15 (F)
0	NU	DL	þ	o	É	P	é	p				Ë	ö	h	ë	ö
1	SH	D1	!	1	A	Q	a	q			À	Ğ	ø	à	ğ	ø
2	SX	D2	"	2	B	R	b	r			Á	ì	ş	á	ì	ş
3	EX	D3	£	3	C	S	c	s			Â	í	š	â	í	š
4	ET	D4	\$	4	D	T	d	t			Ã	î		ã	î	þ
5	EQ	NK	%	5	E	U	e	u			Ä	ï	þ	ä	ı	þ
6	AK	SY	&	6	F	V	f	v			Å	ï	ù	å	ı	ù
7	BL	EB	,	7	G	W	g	w			Æ	ıj	ú	æ	ıj	ú
8	BS	CN	(8	H	X	h	x			Ć	ıj	û	ć	ıj	û
9	HT	EM)	9	I	Y	i	y			Ç	ıj	ü	ç	ıj	ü
10 (A)	LF	SB	*	:	J	Z	j	z			Č	ň	ŵ	č	ň	ŵ
11 (B)	VT	EC	+	;	K	þ	k	þ			Đ	CE	ý	đ	ce	ý
12 (C)	FF	◊	,	<	L	Æ	ı	æ				ò	ŷ	đ	ò	ŷ
13 (D)	CR	△	-	=	M	ð	m	ð			È	ó	ŷ	è	ó	ŷ
14 (E)	SO	◁	.	>	N	ö	n	ö			É	ô	ž	é	ô	ž
15 (F)	SI	▷	/	?	O	Á	o	á			Ê	õ		ê	õ	

<p>CODE CHART VERSION 18</p>	

COL ROW	0	1	2	3	4	5	6	7	8	9	10 (A)	11 (B)	12 (C)	13 (D)	14 (E)	15 (F)
0	NU	DL	Ø	0	É	P	é	p								
1	SH	D1	!	1	A	Q	a	q								
2	SX	D2	"	2	B	R	b	r								
3	EX	D3	#	3	C	S	c	s								
4	ET	D4	α	4	D	T	d	t								
5	EQ	NK	%	5	E	U	e	u								
6	AK	SY	&	6	F	V	f	v								
7	BL	EB	,	7	G	W	g	w								
8	BS	CN	(8	H	X	h	x								
9	HT	EM)	9	I	Y	i	y								
10 (A)	LF	SB	*	:	J	Z	j	z								
11 (B)	VT	EC	+	;	K	Ä	k	ä								
12 (C)	FF	◇	,	<	L	ö	l	ö								
13 (D)	CR	△	-	=	M	ä	m	ä								
14 (E)	SO	◁	.	>	N	ü	n	ü								
15 (F)	SI	▷	/	?	O	-	o	■								

CODE CHART	VERSION 41,42
------------	---------------

COL ROW	0	1	2	3	4	5	6	7	8	9	10 (A)	11 (B)	12 (C)	13 (D)	14 (E)	15 (F)
0	NU	DL	þ	0	@	P	`	p			þ	Ë	ö	ñ	ë	ö
1	SH	D1	!	1	A	Q	a	q		¨	À	Ǧ	ø	à	ǧ	ø
2	SX	D2	”	2	B	R	b	r		´	Á	Ì	Ş	á	ì	ş
3	EX	D3	#	3	C	S	c	s			Â	Í	Š	â	í	š
4	ET	D4	\$	4	D	T	d	t			Ã	Î	£	ã	î	β
5	EQ	NK	%	5	E	U	e	u			Ä	Ï	þ	ä	ı	þ
6	AK	SY	&	6	F	V	f	v			Ř	Ï	Ù	ř	ï	ù
7	BL	EB	,	7	G	W	g	w			Æ	IJ	Ú	æ	ij	ú
8	BS	CN	(8	H	X	h	x			Ć	Ĵ	Û	ć	ĵ	û
9	HT	EM)	9	I	Y	i	y			Ç	Ľ	Ü	ç	ı	ü
10 (A)	LF	SB	*	:	J	Z	j	z			Č	Ň	Ŧ	č	ň	ŧ
11 (B)	VT	EC	+	;	K	Ľ	k	ł			Đ	CE	Ý	đ	ce	ý
12 (C)	FF	◇	,	<	L	\	l	ı			Š	Ò	Ÿ	đ	ò	ÿ
13 (D)	CR	△	-	=	M]	m	}			È	Ó	Ÿ	è	ó	ÿ
14 (E)	SO	◁	.	>	N	^	n	—			É	Ô	Ž	é	ô	ž
15 (F)	SI	▷	/	?	O	_	o	■			Ê	Õ	°	ê	õ	■

APPENDIX K

CONTROL CHARACTER ACTIONS

NULL (00)

Ignored in text of message.

SOH (01)

Indicates the start of header of a text.

Reception of SOH code causes the following to take place:

SOH EXIT FORM

If Y, and DCP page is in Forms mode, then Forms mode is released.

SOH CLEAR SCREEN

If Y, then the DCP page is entirely cleared and the DCP moves to the home position.

STX (02)

Indicates the start of text. An STX is received following the normal header sequence. The following message will appear on the status line:

"RECEIVING- - - P.X"

ETX (03)

Indicates the end of text.

When the text has been received successfully, the following takes place:

The received text is displayed on the DCP page.

If option = Y: After the entire text is displayed, ETX WRITE FROM DOOM is examined.

NON-FORMS: Displays ETX code at DCP.

FORMS: Does not display ETX.

If ETX is displayed as in the above, ETX ADV is examined.

If option = Y: After display of ETX, the DCP advances one column.

Depending on the cursor position, the following will take place:

If the DCP page and the cursor page coincide with each other and if ESC 6 is not contained in the text, the cursor is aligned to the DCP position. The received message on the status line is cleared. In mode, however, if the cursor moves into the GS field, the cursor is right-justified in the field (the DCP does the same).

If the DCP page is different from the cursor page, the cursor then remains in the current position and the received message on the status line remains displayed.

RCV MODE HOLD

If option = Y: Upon completion of receiving, the terminal is left in the RCV mode.

If option = N: Upon completion of receiving the terminal goes into the Local mode.

EOT (04)

Transmission control code. An EOT in the text causes a sequence error. The terminal goes into the "waiting for the polling or selection" state.

ENQ (05)

Transmission control code. An ENQ in the text is stored in the display buffer.

ACK (06)

Transmission control code. An ACK in the text is stored in the display buffer.

BEL (07)

NON-FORMS: Sounds the buzzer (unless disabled).

FORMS: Even if the buzzer is disabled, it is sounded.

BS (08)

Moves the DCP one column to the left.

HT (09)

HT WRITE FROM DOOM

Horizontal tab

If option = Y Write HT code at DCP.

Fixed tab

If option = N: Advances the DCP to the next variable tab stop.

If there is no tab, the DCP moves to the home position of the page.

If option = Y: Advances the DCP to the next fixed tab stop.

FORMS:

If option = Y: DCP is within a protected field; HT is not displayed.

DCP is within US field; HT is displayed at the DCP.

DCP is within the GS field:

When DCP is not in the rightmost position, HT is not displayed.

When DCP is in the rightmost position, HT is displayed.

Moves the DCP to the leftmost position of the next unprotected field.

LF (0A)

Moves the DCP down one line.

If the DCP is on the last line of the page, this causes the DCP to move to the same column on the first line of the page.

After completion of the movement, the terminal checks DOOM LF-> CR.

If option = Y Moves the DCP to column 1 of the line.

If option = N Does not move the DCP.

VT (0B)

NON-FORMS:

Vertical tab function VT PAGE

If option = Y: Moves the DCP to the next vertical tab stop whose line is expressed by $8n+1$; therefore, the line numbers are 1, 9, 17, 25, etc.

If the current line is fewer than 8 from page end, the DCP moves to line 1. After moving to the new line, the DCP moves to column 1 of that line.

If option = N: If fixed tab stop mode, this command is ignored.
If fixed TAB [N], reverse the horizontal variable tab stop.

VT (0B)

VT PAGE ADV

FORMS:

If option = Y: Same as in the NON-FORMS mode except that the DCP moves to the data entry position of the first unprotected field after moving to the new line.

If option = N: Ignored.

FF (0C)

NON-FORMS:

Clears the entire area of the DCP page by filling with spaces and moves the DCP to the home position.

FF CLR TABS

Variable tab

If option = Y: All variable tabs are cleared.

If option = N: Ignored.

FORMS:

Clears all the unprotected fields in the page and moves the DCP to the entry position of the first field.

CR (0D)

NON-FORMS:

CR WRITE FROM DOOM

If option = Y: Stores CT at DCP position.

If option = N: Does not store CR.

Moves the DCP to column 1 of the same line.

DOOM CR to LF

If option = Y: Does not move the DCP.

If option = N: Moves the DCP down one line. If the DCP was on the last line, it moves to the first line.

FORMS:

CR WRITE FROM DOOM

If option = Y: Does not store CR code if the DCP is on a delimiter.
Stores CR code if the DCP is in an unprotected field.

If option = N: Does not store the CR code.

Moves the DCP to column 1 of the same line.

SO (0E)

Reverse highlight code stored.

SI (0F)

Underline highlight code stored.

DLE (10)

Data link escape code stored in the display buffer.

Stored in the display buffer.

DC1 (11)

NON-FORMS:

DC1 RCV MOD HOLD

If option = N: Leaves the terminal in the Receive mode after completion of receiving.
Clears from the DCP position to the end of the line.

FORMS:

DC1 RCV MOD HOLD

If option = Y: Leaves the terminal in the Receive mode after completion of receiving.

If option = N:

Within protected field: Ignored.

US field:

Clears from the DCP position to the end of the field.

If the field extends to the next line, clears extending to the next line.

GS field:

DCP at rightmost position of field.

The data at the DCP is cleared.

DCP ignored at other positions.

DC2 (12)

DC2 ADV DCP

If option = Y: Advances the DCP one column.

If option = N: Reverses the FORMS mode on the DCP page.

Change from FORMS to NON-FORMS:

Releases Forms mode of the DCP page and sets the DCP to the home position of the page. If the cursor page and DCP page coincide with each other, the FORMS status is reset and the cursor is aligned to the DCP.

Change from NON-FORMS to FORMS:

Sets the Forms mode on the DCP page. If the Search mode has been set when mode is changed to the reverse, the terminal works the same as in the Forms mode set by ESC E sequence.

DC3 (13)

Moves the DCP up one line (the column is the same).

If the DCP is on the first line, it is moved to the same column on the end line of the page.

DC4 (14)

NON-FORMS: Moves the DCP to the home position of the page.

FORMS: Moves the DCP to the leftmost position on first unprotected field of the page.

NAK (15)

Transmission control code NAK in the text is stored in the display buffer.

SYN (16)

Transmission control code.

SYN in the text is stored in the display buffer.

In synchronous mode SYN is ignored.

ETB (17)

Stops highlight.
Stores ETB code at the DCP as a space and advances DCP one column.

CAN (18)

Starts blink video.
Stores CAN code at the DCP as a space and advances DCP one column.

EM (19)

Starts secure video.
Stores EM code at the DCP as a space and advances DCP one column.

SUB (1A)

Starts bright video.
Stores SUB code at the DCP as a space and advances DCP one column.

ESC (1B)

NON-FORMS: Starts ESC sequence.
With ESC code, DCP is not affected.

FS (1C)

Stores FS code at the DCP and advances DCP one column.
In Forms mode, after storing FS, if no unprotected field remains, Forms mode is disabled.

GS (1D)

NON-FORMS: Stores GS code at the DCP and advances DCP one column.

FORMS: Ignored.

APPENDIX L

TEXT CHARACTER ENTRY ALGORITHM

Text Character Entry Procedures:

1. From keyboard: at the cursor location...
 - a. NON-FORMS page: stores character; advances cursor.
 - b. FORMS page:
 1. Character is GS, US, or RS: operation is complete.
 2. Character is not GS, Us, or RS.
 - a. Skip flag on.
 1. Cursor is on GS, US, or RS: advances cursor.
 2. Cursor is not on GS, US, or RS: stores character; advances cursor.
 - b. Skip flag off.
 1. Cursor in US field: stores character; advances cursor.
 2. Cursor at rightmost position of GS field one space to the left; stores character.
 3. Operation is complete.
2. from data comm: at data comm pointer location...
 - a. NON-FORMS page: stores character; advances pointer.
 - b. FORMS page:
 1. Character is US, GS, or RS: operation is complete.
 2. Character is not US, GS, or RS.
 - a. Pointer is on GS, US or RS: advances pointer.
 - b. Pointer is not on GS, US or RS: stores character; advances pointer.

APPENDIX M

POINTER ADVANCE ALGORITHM

Pointer Advance Procedures:

1. Cursor.
 - a. Skip flag off.
 1. NON-FORMS page.
 - a. Cursor not at end of page: moves cursor one space to the right.
 - b. Cursor at end of page:
 1. Option 96/7 = 1: leaves cursor where it is.
 2. Option 96/7 = 0: moves cursor to home position of page.
2. FORMS page: moves cursor one space to right.
 - a. Option 92/4 = 1: operation is complete.
 - b. Option 92/4 = 0:
 1. Cursor on non-delimiter and not at (1, 1): operation is complete.
 2. Cursor on GS, US, or RS, or at (1, 1): moves right to next non-delimiter immediately following a GS or US.
 - a. Cursor in US field: operation is complete.
 - b. Cursor in GS field:
 1. Option 96/6 = 1: writes HT at cursor location; moves cursor right to end of field.
 2. Option 96.6 = 0: moves cursor right to end of field.

3. Skip flag on
 1. NON-FORMS page
 - a. Page contains one or more instances of search character: moves cursor right to next instance of Search character; leaves skip flag on.
 - b. Page contains no instance of search character: set cursor to home; turns skip flag off.
 2. FORMS page: moves cursor right until it is on a GS or US or an instance of the search character; then...
 - a. cursor on GS or US: turn skip flag OFF; proceeds as in 1a2b2.
 - b. cursor on an instance of search character: leaves skip flag ON.
2. Data comm pointer
 - a. NON-FORMS page: moves the pointer one space to the right.
 - b. FORMS page: moves the pointer one space to the right; then...
 1. Pointer is on a GS, US or RS, or is at (1, 1): moves right to next non-delimiter following a GS or US.

Move Pointer Right Procedure:

1. Pointer not at end of line: increments column number.
2. Pointer at end of line:
 - a. Pointer not on bottom line of page: sets column number to 1; increments line number.
 - b. Pointer on bottom line of page: sets line and column numbers to 1.

INDEX

Address group, 4-4
ASCII standard chart, A-1

Buffer control, 5-1
 data comm buffer, 5-5
 display buffer, 5-4
 keystroke buffer, 5-2
 printer buffer, 5-6
 softkey buffer, 5-3
Buffer group, 4-4, 4-5

Configuration table, D-1 thru D-10
Construction of extended characters, J-1
 language version 1A, J-1
 language version 1B, J-1
 other language versions, J-2 thru J-15
Control mode, 7-4
Control sequences, 9-1 to 9-4

Data comm
 SO/SI XLT effects on text transmitted, H-1, H-2
 SO/SI XTN effects on text transmitted, H-1, H-2
Data comm buffer, 5-5
Data comm procedures, 6-6, 6-7
DCOM group, 4-6 thru 4-9
Designing pages, 7-1
 ending a text field, 7-2
 exiting forms mode, 7-2
 left-justified text fields, 7-1
 protecting forms modes, 7-2
 protecting text fields, 7-2
 right-justified text fields, 7-2
 sample page (form), 7-3
Display buffer, 5-4

Edit group, 4-11 to 4-16
Edit mode, 8-5
Escape sequences, 9-1, 9-5 thru 9-7

Forms mode, 7-6
Forms/Non-Forms, K-1 thru K-7, L-1, M-1, M-2

Groups (terminal configuration)
 address, 4-4
 buffer, 4-4, 4-5
 DCOM, 4-6 thru 4-9
 print, 4-9 thru 4-11
 edit, 4-11 thru 4-16
 screen, 4-16 thru 4-18

INDEX (CONT.)

- Keyboard, 3-1
 - illustration, 3-1
 - indicators, 3-1
- Key functions, 3-8 thru 3-11
 - chart, 3-2 thru 3-7
 - correcting, 6-4
 - defining, 6-1
 - permanent softkey buffers, 6-2
 - programming, 6-1
 - programming example, 6-3
 - returning to original function, 6-5
 - semi-permanent softkey buffers, 6-2
 - sequence defined, 6-1
 - using a programmed key in another sequence, 6-4
- Keystroke buffer, 5-2
- Local mode, 7-6
- Memory map, I-1
- Mode(s), operating, 7-4
- Operating modes, 7-4
 - Control mode, 7-4
 - Edit mode, 7-5
 - Forms mode, 7-6
 - Local mode, 7-6
 - Read/Write mode, 7-7
 - Receive mode, 7-7
 - Search mode, 7-7, 7-8
 - Transmit mode, 7-9
- Page design (forms mode), 7-1
- Printer buffer, 5-6
- Printer control, 8-1
 - diacritics, 8-5
 - extended character sets, 8-4
 - Print/Aux, 8-2
 - Print/Aux sequence, 8-3
 - Screen Print, 8-1, 8-2
 - serial printer connector pinouts, 8-4
- Print group, 4-9 thru 4-11
- Procedures
 - data comm, 6-6, 6-7
 - data comm installation, 2-9 thru 2-19
 - installation (system), 2-1 thru 2-8
 - maintenance (system), 2-27
 - pointer advance algorithm, M-1, M-2
 - text character entry algorithm, L-1
 - unpacking (system), 2-4, 2-5
- Programming keys, 6-1 thru 6-7

INDEX (CONT.)

Read/Write mode, 7-7
Receive mode, 7-7

Screen group, 4-16 thru 4-18
Search mode, 7-7, 7-8
Sequences, control and escape, 9-1 thru 9-7
SO/SI XLT, 4-17, 4-18, H-1, H-2
SO/SI XTN, 4-17, 4-18, H-1, H-2
Softkey buffer, 5-3

System, 1-1
 controls, 1-2
 features, 1-3, 1-4
 indicators, 1-2
 installation, 2-1 thru 2-8
 maintenance, 2-27
 unpacking, 2-4, 2-5

Terminal configuration, 4-1
 address group, 4-4
 buffer group, 4-4, 4-5
 changing configuration table, 4-18, 4-19
 configuration menu, 4-1
 DCOM group, 4-6 thru 4-9
 displaying configuration menu, 4-1, 4-2
 menu options, 4-4
 print group, 4-9 thru 4-11
 reconfiguration error checks, 4-19
 screen group, 4-16 thru 4-18
 semi-permanent configurations, 4-18

Terminal tests, E-1 thru E-3

Text fields, 7-1
 ending, 7-2
 left-justified, 7-1
 protected, 7-2
 right-justified, 7-2

Transmit mode, 7-9

15	g	!!	GP	
03840	2048	0256	0256	2048
	Y	Y		
9600	N			
N		Y		005
Y				A
Blank	Y			
000	N		Y	
N	N		N	

>46< >6< >!< >44<

Dcom: >9600< >N< >N< >N< >Y<
>N< >N< >Y< >004<
>N< >Y< >A<
>L >Y<
>000L >N< >Y<
>N< >N< >N<

EDIT

Form XMT to CURSOR Y
CR write from KB N