

 *NOS 2 Reference Set*
Volume 4
Program Interface

LIST OF MACROS

ABORT	11-1	GETTL	6-12	RPVBLK	10-10
APPEND	5-30	GETUSC	6-36	RTIME	9-6
ASSIGN	4-9	HTIME	9-5	SAVE	5-15
ATTACH	5-36	JDATE	9-5	SETASL	6-3
BKSP	3-42	LABEL	4-11	SETFAL	4-3
BKSPRU	3-43	LOADD	11-24	SETFET	2-17
CATLIST	5-21	LOADQ	11-26	SETFS	4-3
CHANGE	5-38	LOCK	4-4	SETGLS	6-24
CHECKPT	10-5	MACHID	6-25	SETJAL	6-35
CLOCK	9-2	MEMORY	11-9	SETJCI	6-30
CLOSE	3-20	MESSAGE	11-10	SETJCR	6-16
CLOSER	3-23	MODE	6-2	SETJOB	6-31
CONTROL	10-2	MOVE	11-12	SETJSL	6-4
CSET	11-31	NORENUN	6-20	SETLC	6-13
CSTATUS	6-42	OFFSW	6-9	SETLOF	6-28
DATE	9-2	OLD	5-42	SETMFL	6-27
DAYFILE	11-1	ONSW	6-9	SETPAGE	6-39
DEFINE	5-32	OPEN	3-13	SETPFAC	5-43
DISTC	11-29	OVERLAY	11-21	SETPFAL	5-44
EDATE	9-3	OVWRITE	3-40	SETPR	6-1
EFFECT	11-35	PACKNAM	6-20,21	SETRFL	6-14
ENCSF	4-10	PDATE	9-6	SETSC	6-38
ENDRUN	11-5	PERMIT	5-27	SETSLM	11-32
EREXIT	6-5	POSMF	3-46	SETSS	6-16
ETIME	9-4	PRIMARY	4-26	SETSSM	6-8
EVICT	3-51	PROMPT	11-31	SETTL	6-4
EXCST	10-5	PROTECT	6-31	SHELL	6-33
FILEB	2-14	PSCSF	4-10	SKIPB	3-53
FILEC	2-14	PURGE	5-20	SKIPEI	3-53
FILINFO	4-26	READ	3-25	SKIPF	3-52
GET	5-19	READC	3-58	SKIPFB	3-54
GETACT	6-25	READCW	3-27	SKIPFF	3-52
GETASL	6-11	READEI	3-33	STATUS	4-4,5
GETCN	6-41	READH	3-59	STIME	9-7
GETEM	6-11	READL	3-29	SUBR	11-13
GETFLC	6-19	READN	3-32	SYSCOM	1-8
GETFNT	4-18	READNS	3-31	SYSTEM	11-14
GETGLS	6-23	READO	3-60	TIME	9-7
GETJA	6-17	READS	3-60	TSTATUS	11-33
GETJAL	6-35	READSKP	3-26	UNLOAD	3-44
GETJCI	6-29	READW	3-61	UNLOCK	4-4
GETJCR	6-15	RECALL	11-13	USECPU	6-18
GETJN	6-10	RENAME	4-2	USERNUM	6-18
GETJO	6-17	REPLACE	5-29	VERSION	6-22
GETJOSC	6-33	REPRIEVE	10-15	WAIT	11-15
GETJSL	6-12	REQUEST	11-20	WPHR	3-34
GETLC	6-23	RERUN	11-20	WRITE	3-34
GETLIDA	11-5	RETURN	3-43	WRITEC	3-59
GETLOF	6-28	REWIND	3-38	WRITECW	3-36
GETLVL	6-40	REWRITE	3-38	WRITEF	3-35
GETMC	11-7	REWRITEF	3-39	WRITEH	3-59
GETPAGE	6-39	REWRITER	3-39	WRITEN	3-41
GETPPF	6-27	RFILEB	2-15	WRITEO	3-60
GETPR	6-10	RFILEC	2-15	WRITER	3-35
GETRI	6-40	ROLLOUT	6-7	WRITES	3-61
GETSS	6-21	ROUTE	7-8	WRITEW	3-61
GETSSID	6-32	RPHR	3-25		
GETSSM	11-8	RPHRLS	3-30		



**NOS VERSION 2
REFERENCE SET**

VOLUME 4

PROGRAM INTERFACE

CDC® COMPUTER SYSTEMS:

CYBER 180

CYBER 170

6000 SERIES

REVISION RECORD

REVISION	DESCRIPTION
(04-26-82)	Manual released. Manual reflects NOS 2.0 at PSR level 562. This manual documents the following new features: QAC interface; revised DSP parameter block; new format of GETFNT macro; new macros GETEJS, SETJOB, SETFS, GETSSID, and GETJOSC; EJT job status and connection status fields; service class types; universal availability of the XJ instruction; binary memory dump request (DMB); new parameter for the STATUS macro that returns additional information for tape files; and revised CIO interface.
B (01-27-83)	Manual updated to reflect NOS 2.1 at PSR level 580 and to make miscellaneous technical changes. New features include extended DSP parameter block, QAC extended GET request, addition to QAC PEEK reply block for remote host files, prefix table for DMB processor, and SHELL and WAIT macros. This edition obsoletes all previous editions.
C (09-30-83)	Manual updated to reflect NOS 2.2 at PSR level 596/587 and to make miscellaneous technical changes. New features include common libraries, enhanced system security, service class assignment by users, expanded equipment status table, and support for CYBER 170 Model 845. This edition obsoletes all previous editions.
D (10-12-84)	Manual updated to reflect NOS 2.3 at PSR level 617 and to make miscellaneous technical changes. New features for this release include alternate CATLIST restriction, default charge restriction, enhanced CLASS command, support of the 834 Disk Subsystems, support of the 639 Magnetic Tape Units, and support of the CYBER 180 Computer Systems. This edition obsoletes all previous editions.
E (03-27-85)	Manual updated to reflect NOS 2.4.1 at PSR level 630 and to make miscellaneous technical changes. New features for this release include support of the CYBER 180 Models 840, 850, and 860, support of the 5870 Printer, and support of the 895 Disk Subsystem.
F (12-16-85)	Manual updated to reflect NOS 2.4.3 at PSR level 647 and to make miscellaneous technical changes. New features include support of CYBER 180 Model 990, support of 836 Disk Subsystems, Control Byte 10 to control CDCNET terminal attributes, and disk error recovery enhancements.
G (09-30-86)	Manual updated to reflect NOS 2.5.1 at PSR level 664 and to make miscellaneous technical changes.
H (04-23-87)	Manual updated to reflect NOS 2.5.2 at PSR level 678 and to make miscellaneous technical changes.
J (04-14-88)	Manual updated to reflect NOS 2.6.1 at PSR level 700 and to make miscellaneous corrections.

Publication No.
60459690

REVISION LETTERS I, O, Q, S, X AND Z ARE NOT USED.

© 1982, 1983, 1984, 1985, 1986, 1987, 1988
 by Control Data Corporation
 All rights reserved.
 Printed in the United States of America

Address comments concerning this manual to:
 Control Data
 Technical Publications
 4201 N. Lexington Avenue
 St. Paul, MN 55126-9983
 or use Comment Sheet in the back of this manual.

LIST OF EFFECTIVE PAGES

New features, as well as changes, deletions, and additions to information in this manual, are indicated by bars in the margins or by a dot near the page number if the entire page is affected. A bar by the page number indicates pagination rather than content has changed.

PAGE	REV	PAGE	REV	PAGE	REV	PAGE	REV	PAGE	REV
Front Cover	-	3-7	H	4-3	C	5-29	E	7-1	D
Inside Front Cover	G	3-8	H	4-4	B	5-30	E	7-2	J
Title Page	-	3-8.1/3-8.2	H	4-5	C	5-31	C	7-3	G
2	J	3-9	A	4-6	C	5-32	H	7-4	E
3	J	3-10	B	4-7	H	5-33	B	7-5	J
4	J	3-11	J	4-8	E	5-34	D	7-6	J
5	H	3-12	C	4-9	A	5-35	H	7-7	J
6	J	3-13	C	4-10	A	5-36	D	7-8	J
7	J	3-14	C	4-11	H	5-37	J	7-9	G
8	H	3-15	A	4-12	H	5-38	D	7-10	H
9	J	3-16	D	4-12.1/4-12.2	H	5-39	D	8-1	H
10	H	3-17	D	4-13	A	5-40	D	8-2	D
11	H	3-18	A	4-14	J	5-41	H	8-3	D
12	H	3-19	A	4-15	H	5-42	C	8-4	H
13	H	3-20	G	4-16	D	5-43	C	8-5	A
14	H	3-21	A	4-17	H	5-44	C	8-6	C
1-1	C	3-22	A	4-18	B	5-45	C	8-7	J
1-2	D	3-23	C	4-19	D	6-1	G	8-8	E
1-3	A	3-24	C	4-20	D	6-2	D	8-9	H
1-4	B	3-25	C	4-21	C	6-3	D	8-10	E
1-5	A	3-26	C	4-22	F	6-4	J	8-11	H
1-6	C	3-27	C	4-23	D	6-5	F	8-12	H
1-7	A	3-28	A	4-24	F	6-6	F	8-13	J
1-8	B	3-29	E	4-25	A	6-7	C	8-14	J
1-9	F	3-30	C	4-26	H	6-8	A	8-15	G
1-10	B	3-31	C	4-26.1/4-26.2	H	6-9	B	8-16	G
1-11	F	3-32	C	4-27	H	6-10	B	8-17	G
1-12	B	3-33	C	4-28	B	6-11	D	8-18	J
1-13	F	3-34	C	4-29	H	6-12	A	8-19	J
1-14	B	3-35	C	4-30	H	6-13	C	8-20	J
1-15	A	3-36	F	5-1	J	6-14	B	8-20.1/8-20.2	J
1-16	A	3-37	D	5-2	J	6-15	A	8-21	G
2-1	B	3-38	C	5-3	F	6-16	C	8-22	J
2-2	G	3-39	C	5-4	J	6-17	D	8-23	D
2-3	G	3-40	C	5-4.1/5-4.2	J	6-18	B	9-1	A
2-4	G	3-41	C	5-5	F	6-19	A	9-2	B
2-5	G	3-42	C	5-6	J	6-20	C	9-3	D
2-6	C	3-43	C	5-7	J	6-21	C	9-4	B
2-7	A	3-44	C	5-8	J	6-22	E	9-5	B
2-8	G	3-45	C	5-9	J	6-23	B	9-6	A
2-9	A	3-46	C	5-10	J	6-24	B	9-7	D
2-10	C	3-47	A	5-11	H	6-25	E	10-1	B
2-11	B	3-48	A	5-12	H	6-26	C	10-2	J
2-12	C	3-49	A	5-13	D	6-27	B	10-3	A
2-13	B	3-50	A	5-14	H	6-28	B	10-4	B
2-14	A	3-51	C	5-15	D	6-29	A	10-5	A
2-15	A	3-52	C	5-16	H	6-30	A	10-6	A
2-16	J	3-53	C	5-17	D	6-31	B	10-7	C
2-17	H	3-54	C	5-18	B	6-32	D	10-8	C
2-18	B	3-55	A	5-19	C	6-33	C	10-9	D
2-19	A	3-56	A	5-20	B	6-34	G	10-10	B
2-20	J	3-57	B	5-21	H	6-35	C	10-11	A
3-1	C	3-58	A	5-22	D	6-36	D	10-12	D
3-2	D	3-59	A	5-23	H	6-37	D	10-13	B
3-3	A	3-60	B	5-24	H	6-38	D	10-14	D
3-4	B	3-61	B	5-25	C	6-39	C	10-15	F
3-5	A	3-62	A	5-26	D	6-40	D	10-16	F
3-6	C	4-1	B	5-27	D	6-41	D	11-1	D
		4-2	J	5-28	C	6-42	E	11-2	D

PAGE	REV	PAGE	REV	PAGE	REV	PAGE	REV	PAGE	REV
11-3	C	A-13	E	F-11	A				
11-4	C	A-14	C	G-1	D				
11-5	D	A-15	C	G-2	A				
11-6	D	B-1	J	G-3	A				
11-7	B	B-2	F	G-4	A				
11-8	D	B-3	F	G-5	A				
11-9	C	B-4	J	G-6	A				
11-10	A	B-5	H	G-7	A				
11-11	F	B-6	F	G-8	A				
11-12	G	B-7	F	G-9	D				
11-13	G	B-8	F	G-10	A				
11-14	G	B-9	J	H-1	A				
11-15	G	B-10	J	H-2	A				
11-16	C	B-11	J	H-3	A				
11-17	C	B-12	J	H-4	B				
11-18	C	B-13	F	H-5	B				
11-19	J	B-14	F	H-6	A				
11-20	D	B-15	F	H-7	A				
11-21	C	B-16	F	H-8	A				
11-22	J	B-17	F	H-9	A				
11-23	B	B-18	F	I-1	A				
11-24	A	B-19	F	I-2	A				
11-25	A	B-20	F	I-3	A				
11-26	C	B-21	F	I-4	D				
11-27	B	B-22	F	I-5	A				
11-28	A	B-23	F	I-6	C				
11-29	D	B-24	F	I-7	A				
11-30	F	B-25	F	I-8	C				
11-31	B	B-26	F	J-1	D				
11-32	E	B-27	F	J-2	A				
11-33	H	B-28	F	J-3	A				
11-34	H	B-29	F	J-4	A				
11-35	J	B-30	F	J-5	A				
12-1	A	C-1	F	J-6	C				
12-2	C	C-2	E	J-7	A				
12-3	E	C-3	E	J-8	A				
12-4	F	C-4	E	K-1	J				
12-4.1/12-4.2	F	C-5	E	K-2	J				
12-5	H	C-6	E	K-3	J				
12-6	D	C-7	E	K-4	J				
12-7	F	C-8	E	L-1	J				
12-8	F	C-9	E	L-2	H				
12-9	G	C-10	H	L-3	G				
12-10	G	C-11	H	L-4	G				
12-11	G	C-12	H	L-5	G				
12-12	J	C-13	H	L-6	G				
12-13	J	C-14	H	L-7	G				
12-14	G	C-15	H	M-1	D				
12-15	H	D-1	J	M-2	D				
12-16	H	E-1	D	M-3	D				
12-17	H	E-2	C	Index-1	G				
12-18	H	E-3	B	Index-2	H				
12-18.1	H	E-4	D	Index-3	H				
12-18.2	H	E-5	H	Index-4	H				
12-18.3/		E-6	C	Index-5	H				
12-18.4	H	E-7	G	Index-6	H				
12-19	F	E-8	F	Index-7	H				
12-20	F	E-9	E	Index-8	H				
12-21	F	E-10	H	Index-9	H				
A-1	A	E-11	G	Index-10	H				
A-2	C	E-12	G	Comment Sheet	J				
A-3	E	F-1	B	Back Cover	-				
A-4	E	F-2	C						
A-5	C	F-3	C						
A-6	C	F-4	C						
A-7	C	F-5	D						
A-8	C	F-6	D						
A-9	C	F-7	D						
A-10	C	F-8	H						
A-11	C	F-9	H						
A-12	E	F-10	H						

PREFACE

This manual describes the Network Operating System (NOS), Version 2. NOS controls operation of CDC CYBER 180 Computer Systems, Models 810, 830, 835, 840, 845, 850, 855, 860, 870, 990, and 995; CDC CYBER 170 Computer Systems, Models 171, 172, 173, 174, 175, 176, 720, 730, 740, 750, 760, 815, 825, 835, 845, 855, 865, and 875; CDC CYBER 70 Computer Systems, Models 71, 72, 73, and 74; and CDC 6000 Computer Systems.

The NOS Reference Set, composed of four separate volumes, describes the external features of NOS 2.

AUDIENCE

Volume 1, Introduction to Interactive Usage, is written for the novice.

Volume 2, Guide to System Usage, is written for the applications or systems programmer who is unfamiliar with NOS.

Volume 3, System Commands, is written for all NOS users.

Volume 4, Program Interface, is written for the experienced COMPASS applications programmer or systems programmer.

The reader of each volume should have a knowledge of the material contained in the previous volumes.

ORGANIZATION

Volume 1, Introduction to Interactive Usage (60459660), shows a user at an interactive terminal how to enter, run, and correct programs, and how to create, retrieve, and maintain permanent files. Other topics covered include physical terminal connection and login/logout procedures.

Volume 2, Guide to System Usage (60459670), describes the general concepts of NOS and some of the utilities used with NOS. Topics included are job processing, file concepts, procedures, magnetic tape processing, Modify, and loading files. This volume is to be used as a learning tool and does not contain comprehensive descriptions of all NOS commands.

Volume 3, System Commands (60459680), describes the system commands that form the user interface to NOS.

Volume 4, Program Interface (60459690), describes the COMPASS program interface to NOS. Detailed descriptions of function processors and macros available to COMPASS user programs are included.

CONVENTIONS

The following notational conventions are used throughout this manual.

SYSTEM REQUEST AND MACRO FORMATS

The system request and macro formats in this manual are presented using both uppercase and lowercase characters. Uppercase characters must be entered exactly as shown. Lowercase characters are to be replaced with the appropriate characters as described in the text.

The auto recall parameter is a special case. This parameter is shown in uppercase for all requests except CIO requests. However, the system processes all non-CIO requests made by user programs with auto recall, regardless of whether or not the auto recall parameter is specified in the request. The system processes CIO requests with auto recall only if the auto recall parameter is specified in the request.

NUMBER BASE NOTATION

Decimal base is used throughout this manual except where otherwise noted. Octal integers greater than 7 or less than -7 are written with a subscript 8 or the word octal. Octal base is used in the following contexts:

- Address indices for memory tables and parameter blocks.
- Display code values.
- Function codes of macros.
- Numbers of words in memory.
- Numerical fields in memory.

Decimal base is used in all program examples except where the BASE OCTAL pseudoinstruction or the postradix B is used.

EXTENDED MEMORY

The forms of extended memory are as follows:

- Extended memory for models 865 and 875 and CYBER 180-class machines is unified extended memory (UEM) and may also include either extended core storage (ECS), extended semiconductor memory (ESM), or STORNET.
- Extended memory for model 176 is large central memory extended (LCME), and may also include ECS, ESM, or STORNET.
- Extended memory for all other NOS computer systems is either ECS, ESM, or STORNET. STORNET is supported only on CYBER 170 (except model 176) and 180 Computer Systems.

ECS, ESM, and STORNET are the only forms of extended memory that can be shared in an ECS multiframe complex and accessed by a distributive data path (DDP) or low-speed port (LSP).

ECS refers to ECS, ESM, and STORNET. Extended memory refers to all forms of extended memory unless otherwise noted. However, when referencing extended memory in the context of an ECS multiframe complex or DDP or LSP access, UEM and LCME are excluded.

Programming information for the various forms of extended memory can be found in the COMPASS Version 3 Reference Manual and in the appropriate computer system hardware reference manual.

Some of the CYBER 170 Computer Systems share many of the functional and architectural attributes of the CYBER 180 Computer Systems. Specifically, CYBER 170 Models 815, 825, 835, 845, and 855 fall into this category. It is sometimes convenient to refer to the CYBER 180 models and these CYBER 170 models collectively. This manual uses the term CYBER 180-class machines to refer to this collection.

MEMORY WORD FORMATS

The following notations are used in memory word formats:

- Bits of memory words are numbered in decreasing order from left to right, starting with 59 on the left and ending with 0 on the right.
- Bytes (12-bit portions) of memory words are numbered in increasing order from left to right, starting with 0 (byte 0 consists of bits 59 through 48, byte 1 consists of bits 47 through 36, byte 2 consists of bits 35 through 24, byte 3 consists of bits 23 through 12, and byte 4 consists of bits 11 through 0).
- Fields that contain only capital letters indicate portions of memory that contain the display code values for those letters.
- Diagonal lines () indicate a portion of memory that is not used by the system and may contain any value. These portions may, however, be used by future versions of NOS.
- The word 'reserved' or the phrase 'reserved for Control Data' indicates a portion of memory that is either used internally by the system or is reserved for future use. The phrase 'reserved for installations' indicates a portion of memory that each installation may use in whatever manner it chooses.
- A zero indicates a portion of memory that contains all binary zeros.

CHARACTER SETS

The ASCII character set is used in the examples in this manual. Other NOS-compatible character sets are described in appendix A.

SUBMITTING COMMENTS

The last page of this manual is a comment sheet. Please use it to give your opinion on the manual's usability, to suggest specific improvements, and to report any errors. If the comment sheet has already been used, you can mail your comments to:

Control Data Corporation
Technology and Publications Division ARH219
4201 Lexington Avenue North
St. Paul, MN 55126-6198

Additionally, if you have access to SOLVER, an online facility for reporting problems, you can use it to submit comments about the manual. Use NS2 as the product identifier.

IN CASE OF TROUBLE

Control Data's Central Software Support maintains a hotline to assist you if you have trouble using our products. If you need help beyond that provided in the documentation, or find that the product does not perform as described, call us at one of the following numbers and a support analyst will work with you.

From U.S.A. and Canada: (800) 345-9903

From other countries: (612) 851-4131

The preceding numbers are for help with product usage. Address questions about physical packaging and/or distribution of printed materials to Literature and Distribution Services at the following address:

Control Data
Literature Distribution Services
308 North Dale Street
St. Paul, Minnesota 55103

or you can call (612) 292-2101. If you are a Control Data employee, call (612) 292-2100.

RELATED PUBLICATIONS

The following manuals contain information directly related to the material presented in this volume.

You might also want to consult the NOS System Information Manual. It is an online manual that includes brief descriptions of all NOS and NOS product manuals. You can access this manual by logging into NOS and simply entering the command EXPLAIN.

These manuals are available through Control Data sales offices or Control Data Literature Distribution Services, 308 North Dale Street, St. Paul, MN 55103.

<u>Control Data Publication</u>	<u>Publication Number</u>
Binary Maintenance Log (BML) Message Formats	60459940
CDCNET Batch Device User Guide	60463863
CDCNET Terminal Interface Usage	60463850
Common Memory Manager Version 1 Reference Manual	60499200
COMPASS Version 3 Reference Manual	60492600
CYBER Loader Version 1 Reference Manual	60429800
CYBER Record Manager Advanced Access Methods Version 2 Reference Manual	60499300
CYBER Record Manager Basic Access Methods Version 1.5 Reference Manual	60495700
Modify Version 1 Reference Manual	60450100

<u>Control Data Publication</u>	<u>Publication Number</u>
Network Access Method Version 1 Host Application Programming Reference Manual	60499500
NOS Version 2 Administration Handbook	60459840
NOS Version 2 Analysis Handbook	60459300
NOS Version 2 Applications Programmer's Instant	60459360
NOS Version 2 Diagnostic Index	60459390
NOS Version 2 Installation Handbook	60459320
NOS Version 2 Operations Handbook	60459310
NOS Version 2 System Overview	60459270
NOS Version 2 Systems Programmer's Instant	60459370
NOS Version 2 Tape Management System (TMS) Site Operations Manual	60463350
NOS Version 2 Tape Management System (TMS) User Reference Manual	60463110

Appendix K contains a comprehensive bibliography of all Control Data publications related to NOS.

DISCLAIMER

This product is intended for use only as described in this document. Control Data cannot be responsible for the proper functioning of undescribed features or undefined parameters.

CONTENTS

<p>1. PROGRAM/SYSTEM COMMUNICATION 1-1</p> <p>Function Processors 1-1</p> <p>System Requests 1-2</p> <p style="padding-left: 20px;">System Request Processing 1-3</p> <p style="padding-left: 20px;">Issuing RA+1 Requests 1-5</p> <p>NOS Systems Texts 1-6</p> <p>Macro Usage 1-7</p> <p style="padding-left: 20px;">SYSCOM 1-8</p> <p>Common Deck Usage 1-9</p> <p>2. FILE ENVIRONMENT TABLE (FET) 2-1</p> <p>Circular Buffers 2-1</p> <p style="padding-left: 20px;">FIRST Address 2-2</p> <p style="padding-left: 20px;">LIMIT Address 2-2</p> <p style="padding-left: 20px;">IN Address 2-2</p> <p style="padding-left: 20px;">OUT Address 2-2</p> <p style="padding-left: 20px;">Data Space 2-3</p> <p>FET Description 2-4</p> <p>FET Creation Macros 2-14</p> <p style="padding-left: 20px;">FILEB 2-14</p> <p style="padding-left: 20px;">FILEC 2-14</p> <p style="padding-left: 20px;">RFILEB 2-14</p> <p style="padding-left: 20px;">RFILEC 2-15</p> <p>FET Modification Macro 2-17</p> <p style="padding-left: 20px;">SETFET Parameter Processing 2-19</p> <p style="padding-left: 20px;">SETFET Examples 2-20</p> <p>3. INPUT/OUTPUT 3-1</p> <p>Combined Input/Output (CIO) 3-1</p> <p style="padding-left: 20px;">CIO Function Processing 3-4</p> <p>Accessing Files 3-7</p> <p style="padding-left: 20px;">Reading Files 3-8.1</p> <p style="padding-left: 20px;">Writing Files 3-8.1</p> <p style="padding-left: 20px;">Random Request Processing 3-10</p> <p>CIO Processing on Secured Systems 3-12</p> <p style="padding-left: 20px;">Reading Files 3-12</p> <p style="padding-left: 20px;">Writing Files 3-12</p>		<p>Creating Files 3-12</p> <p>Status Returned by CIO 3-12</p> <p>CIO Open and Close Functions 3-12</p> <p>OPEN 3-13</p> <p style="padding-left: 20px;">Mass Storage Operations 3-14</p> <p style="padding-left: 20px;">Unlabeled Tape Processing 3-15</p> <p style="padding-left: 20px;">Nonstandard Labeled Tape Processing 3-15</p> <p style="padding-left: 20px;">Standard ANSI Labeled Tape Processing 3-15</p> <p style="padding-left: 20px;">Extended Label Processing 3-17</p> <p>CLOSE 3-20</p> <p>CLOSER 3-23</p> <p>CIO Read Functions 3-24</p> <p style="padding-left: 20px;">RPHR (000) 3-25</p> <p style="padding-left: 20px;">READ (010) 3-25</p> <p style="padding-left: 20px;">READSKP (020) 3-26</p> <p style="padding-left: 20px;">READCW (200) 3-27</p> <p style="padding-left: 20px;">READLS (210) 3-29</p> <p style="padding-left: 20px;">RPHRLS (230) 3-30</p> <p style="padding-left: 20px;">READNS (250) 3-31</p> <p style="padding-left: 20px;">READN (260) 3-32</p> <p style="padding-left: 20px;">RADEI (600) 3-33</p> <p>CIO Write Functions 3-33</p> <p style="padding-left: 20px;">WPHR (004) 3-34</p> <p style="padding-left: 20px;">WRITE (014) 3-34</p> <p style="padding-left: 20px;">WRITER (024) 3-35</p> <p style="padding-left: 20px;">WRITEF (034) 3-35</p> <p style="padding-left: 20px;">WRITECW (204) 3-36</p> <p style="padding-left: 20px;">REWRITE (214) 3-38</p> <p style="padding-left: 20px;">REWRITER (224) 3-39</p> <p style="padding-left: 20px;">REWRITEF (234) 3-39</p> <p style="padding-left: 20px;">OVWRITE (244, 254) 3-40</p> <p style="padding-left: 20px;">WRITEN (264) 3-41</p> <p>File Positioning Functions 3-42</p> <p style="padding-left: 20px;">BKSP (040) 3-42</p> <p style="padding-left: 20px;">BKSPRU (044) 3-43</p> <p style="padding-left: 20px;">REWIND (050) 3-43</p> <p style="padding-left: 20px;">UNLOAD (060) 3-44</p> <p style="padding-left: 20px;">RETURN (070) 3-45</p> <p style="padding-left: 20px;">POSMF (110) 3-46</p> <p style="padding-left: 40px;">Standard ANSI Labeled Multifile Set Processing 3-46</p> <p style="padding-left: 40px;">Extended Label Multifile Set Processing 3-47</p>
---	--	---

EVICT (114)	3-51	DEFINE (010, CCDF)	5-32
SKIPF (240)	3-52	ATTACH (011, CCAT)	5-36
SKIPFF (240)	3-52	CHANGE (012, CCCG)	5-38
SKIPEI (240)	3-53	OLD (021, CCOD)	5-42
SKIPB (640)	3-53	SETPFAC (022, CCAC)	5-43
SKIPFB (640)	3-54	SETPFAL (023, CCAL)	5-44
Data Transfer Macros	3-54		
READC	3-58		
WRITEC	3-59		
READH	3-59		
WRITEH	3-59		
READO	3-60		
WRITEO	3-60		
READS	3-60		
WRITES	3-61		
READW	3-61		
WRITEW	3-61		
CYBER Record Manager I/O	3-62		
		6. CONTROL POINT MANAGER	6-1
4. LOCAL FILE MANAGER	4-1	SETPR (001)	6-1
Error Processing	4-2	MODE (002)	6-2
RENAME (000)	4-2	SETASL (003)	6-3
SETFS (003)	4-3	SETJSL (003)	6-4
SETFAL (007)	4-3	SETTL (003)	6-4
LOCK (010)	4-4	EREXIT (004)	6-5
UNLOCK (011)	4-4	ROLLOUT (006)	6-7
STATUS (012)	4-4	SETSSM (010)	6-8
STATUS (013)	4-5	ONSW (011)	6-9
REQUEST (014)	4-6	OFFSW (012)	6-9
REQUEST (015)	4-7	GETJN (013)	6-10
ASSIGN (020)	4-9	GETPR (015)	6-10
ENCSF (022)	4-10	GETEM (016)	6-11
PSCSF (023)	4-10	GETASL (017)	6-11
LABEL (024)	4-11	GETJSL (017)	6-12
GETFNT (025)	4-18	GETTL (017)	6-12
PRIMARY (031)	4-26	SETLC (022)	6-13
FILINFO (032)	4-26	SETRFL (023)	6-14
		GETJCR (024)	6-15
		SETJCR (025)	6-16
		SETSS (026)	6-16
		GETJO (027)	6-17
		GETJA (030)	6-17
		USECPU (031)	6-18
		USERNUM (032)	6-18
		GETFLC (033, 055)	6-19
		PACKNAM (035)	6-20
		PACKNAM (036)	6-21
		GETSS (037)	6-21
		VERSION (044)	6-22
		GETLC (045)	6-23
		GETGLS (046)	6-23
		SETGLS (047)	6-24
		MACHID (050)	6-25
		GETACT (051)	6-25
		SETMFL (052)	6-27
		GETPPF (057)	6-27
		GETLOF (061)	6-28
		SETLOF (062)	6-28
		GETJCI (074)	6-29
		SETJCI (074)	6-30
		PROTECT (075)	6-31
		SETJOB (106)	6-31
		GETSSID (110)	6-32
5. PERMANENT FILE MANAGER	5-1		
Alternate User Access Processing	5-4		
Error Processing	5-4		
PFM Macro Parameter Conventions	5-10		
Auxiliary Device Request	5-14		
SAVE (001, CCSV)	5-15		
GET (002, CCGT)	5-19		
PURGE (003, CCPG)	5-20		
CATLIST (004, CCCT)	5-21		
PERMIT (005, CCPM)	5-27		
REPLACE (006, CCRP)	5-29		
APPEND (007, CCAP)	5-30		

GETJOSC (111)	6-33	11. SYSTEM/LOADER REQUESTS	11-1
SHELL (113)	6-33		
GETJAL (116)	6-35	System Requests	11-1
SETJAL (117)	6-35	ABORT	11-1
GETUSC (123)	6-36	DAYFILE	11-1
SETSC (124)	6-38	ENDRUN	11-5
GETPAGE (127)	6-39	GETLIDA	11-5
SETPAGE (130)	6-39	GETMC	11-7
GETLVL (133)	6-40	GETSSM	11-8
GETRI (134)	6-40	MEMORY	11-9
GETCN (136)	6-41	MESSAGE	11-10
CSTATUS (137)	6-42	MOVE	11-12
		RECALL	11-13
		SUBR	11-13
		SYSTEM	11-14
		WAIT	11-15
7. FILE ROUTING	7-1	User Field Length Dump Requests	11-16
DSP Function	7-1	Dump Extended Memory (DEP)	11-16
ROUTE	7-8	Dump Extended Memory with	
Error Processing	7-10	Display Code (DED)	11-16
		Binary Dump of Central Memory	
		and Extended Memory (DMB)	11-17
		Dump Central Memory (DMP)	11-19
		Dump Central Memory with Display	
		Code (DMD)	11-19
8. QUEUE ACCESS INTERFACE	8-1	Queue File Manager	11-19
QAC Requests	8-10	RERUN (015)	11-20
ALTER Request	8-11	NORERUN (016)	11-20
GET Request	8-14	Loader Requests	11-20
PEEK Request	8-16	OVERLAY	11-21
		LOADD	11-24
		LOADQ	11-26
9. SYSTEM TIME/DATE REQUESTS	9-1	Memory Allocation for Overlay	
CLOCK	9-2	Loaders	11-28
DATE	9-2	Interactive Terminal Requests	11-29
EDATE	9-3	DISTC Macro	11-29
ETIME	9-4	CSET Macro	11-31
HTIME	9-5	PROMPT Macro	11-31
JDATE	9-5	SETSML Macro	11-32
PDATE	9-6	TSTATUS Macro	11-33
RTIME	9-6	EFFECT Macro	11-35
STIME	9-7		
TIME	9-7		
		12. PROGRAM WRITING TECHNIQUES	12-1
10. JOB CONTROL	10-1	Writing Programs under NOS	12-1
Translate Control Statement	10-1	Parameter Processing	12-1
CONTROL (004)	10-2	Writing Interactive Programs	12-4.1
EXCST (005)	10-5	Conversion Problems	12-4.1
Checkpoint/Restart	10-5	Default File Assignments and	
CHECKPT	10-5	Special File Treatment	12-4.1
Reprieve Processing	10-8	Special Handling	12-5
RPVBLK	10-10	Other Special Handling	12-5
REPRIEVE	10-15	Program Control of Terminal Activity	12-6

Control Bytes	12-7	0012 - Reserved	12-11
0000 - End-of-Line	12-7	0013 - End-of-String	12-11
0001, 0002 - End-of-Block	12-7	0014 - Internal End-of-Block	12-11
0003 - Auto Input	12-7	0015 - Executive Auto Input	12-14
0004 - Log Off User	12-8	0016 - Terminal Redefinition	
0005 - Initiate ASCII Input	12-8	for NAM/CCP	12-14
0006 - Initiate Transparent		Mapping Between Terminal	
Input Mode	12-8	Attributes for NAM/CCP	
0007 - Initiate Transparent		and NAM/CDCNET	12-18.1
Output	12-9	Control of Program Execution	12-19
0010 - Terminal Redefinition		Reprieve Processing for User	
for NAM/CDCNET	12-10	Breaks 1 and 2	12-21
0011 - Initiate ASCII Output	12-11		

APPENDIXES

A. CHARACTER SETS	A-1	COMCCMD	F-7
Character Set Anomalies	A-2	Other Common Decks	F-8
Character Set Tables	A-2	SYSLIB	F-10
Interactive Jobs	A-3		
Batch Jobs	A-3	G. BINARY FORMATS	G-1
Jobs Using Line Printers	A-3	PP - CYBER 180, CYBER 170, CYBER 70,	
Jobs Using Magnetic Tape	A-12	or 6000 Computer Systems PP	
		Absolute	G-1
B. MESSAGES	B-1	OPL - Modify Old Program	
		Library Deck	G-2
C. GLOSSARY	C-1	Modification Table Format	G-3
		Text Format	G-4
D. INTERPRETIVE MODE READING AND		OPLD - Program Library Directory	G-5
WRITING OF EXTENDED MEMORY	D-1	ULIB - User Library Group	G-7
		TEXT - Unrecognized as Binary	G-9
		PROC - Procedure	G-9
E. SPECIAL USER INFORMATION	E-1	Compressed Compile File	G-10
Job Communication Area	E-1		
Exchange Package Area	E-4	H. EXAMPLES OF RANDOM I/O	H-1
EJT Connection Status Codes	E-6		
EJT Job Status Codes	E-6	I. PROGRAMMING STANDARDS	I-1
EJT Scheduling Data Field	E-7	Documentation Standards	I-1
File Types and Origin Codes	E-8	Design Overview	I-1
Service Class Types	E-9	External Interface	I-2
Default Service Classes	E-9	Internal Interface	I-2
Device Types	E-10	Detailed Code Analysis	I-2
Error Flags	E-11	Comment Statement Documentation	I-2
F. CPU COMMON DECKS	F-1	Table Generation	I-7
CPCOM	F-1	Further Considerations	I-8
COMCMAC	F-5	Coding Specifications	I-8

J. MAGNETIC TAPE FORMATS	J-1	K. BIBLIOGRAPHY	K-1
Data Formats	J-1		
I (Internal) Format	J-2		
S (Stranger) Format	J-3	L. SHELL PROCESSING	L-1
SI (System Internal) Format	J-4		
L (Long Block Stranger) Format	J-5	Shell Program Example Using COMPASS	L-1
F (Foreign) Format	J-5	Shell Program Example Using FORTRAN 5	L-5
End-of-Tape/End-of-Reel Conditions	J-6		
HDR1 Label Format	J-7	M. EXTENDED REPRIEVE PROCESSING	M-1

INDEX

FIGURES

2-1 Circular Buffer	2-1	H-1 COMPASS Program to Create a Random File	H-2
2-2 Read Operation	2-3		
2-3 Write Operation	2-4	H-2 Input File for Program Creating a Random File (Figure H-1)	H-4
2-4 Standard FET for Mass Storage and Terminal Files	2-4	H-3 Structure of the Random File Created	H-5
2-5 Standard FET for Labeled Magnetic Tape Files (CIO and POSMF)	2-5	H-4 COMPASS Program Using READLS Macro to Retrieve a List of Records from a Random File	H-6
3-1 Sample Random Access File Format	3-7		
3-2 Modified Sample Random Access File Format	3-10	H-5 COMPASS Program to Replace Certain Records on a Random File	H-8
3-3 Data Transfer Buffer Arrangement	3-55		
11-1 Absolute Loader Memory Assignment	11-28	I-1 Source Code for DOCUMENT	I-4
E-1 Job Communication Area	E-1	I-2 External Documentation of Program	I-5
E-2 Exchange Package Area	E-4	I-3 Internal Documentation of Program	I-6
G-1 Modify Library File Format	G-2	L-1 Shell Program Example Using COMPASS	L-3
G-2 Modification Table Format	G-3	L-2 Shell Program Example Using FORTRAN 5	L-6
G-3 Modify Text Format	G-4	M-1 Extended Reprieve Example	M-2
G-4 Library File Directory Table	G-5		
G-5 User Library (ULIB) Format	G-7		
G-6 ULIB Record Format	G-8		
G-7 ULIB Deck Entry/Externals Format	G-9		
G-8 Compressed Compile File Format	G-10		

TABLES

2-1 Effects of r, w, and rr FET Parameters on File Manipulation Operations	2-13	A-1 Character Sets for Interactive Jobs	A-5
3-1 CIO Function Status Response Codes and Processing Options	3-6	A-2 Character Sets for Batch Jobs	A-7
10-1 RPV Error Codes, Classes, and Flags	10-14	A-3 ASCII to 6/12-Bit Display Code Conversion	A-10
12-1 NAM/CDCNET Terminal Redefinition Attributes	12-12	A-4 Nine-Track ASCII Coded Tape Conversion	A-13
12-2 NAM/CCP Terminal Redefinition Attributes	12-15	A-5 Nine-Track EBCDIC Coded Tape Conversion	A-14
12-3 Terminal Attribute Mapping from NAM/CCP to NAM/CDCNET	12-18.1	A-6 Seven-Track Coded Tape Conversion	A-15

PROGRAM/SYSTEM COMMUNICATION

1

The Network Operating System (NOS) allows communication between a CPU program and predefined system routines and functions as follows:

- RA+1 system requests to function processors.
- NOS systems texts.
- Macros.[†]
- Common decks.^{††}

These routines enable you to perform complex operations with a minimum of coding. They have been thoroughly tested and optimized, and are designed to meet system interface requirements.

FUNCTION PROCESSORS

Several NOS system routines process user requests. Sections 3 through 11 contain descriptions of each function processor, including:

- Identification of the requests (function numbers).
- Systems texts containing macros and symbol definitions needed to issue the requests.
- System macros (or common decks containing macros) available to issue the requests.
- Common decks containing efficient code and macros to issue the requests.
- Information returned from the processor after the requests.

Following is a list of the NOS function processors whose system request formats are described in this manual.

<u>Processor</u>	<u>Description</u>	<u>Section</u>
ABT	Exit processing request	11
CIO	Combined input/output	3
CKP	Checkpoint processor	10
CPM	Control point manager	6

[†]Refer to the COMPASS Version 3 Reference Manual for a complete description of how macros are defined and used.

^{††}Refer to the Modify Version 1 Reference Manual for a complete description of how common decks are defined and used.

<u>Processor</u>	<u>Description</u>	<u>Section</u>
CVL	Common validation interface processor	11
DED, DEP	Extended memory dump	11
DMB	Binary dump of central memory and extended memory	11
DMD, DMP	Central memory dump	11
DSP	File routing	7
END	Program termination request	11
LDD, LDQ	Fast dynamic loading	11
LDR, LDV	Overlay request	11
LFM	Local file manager	4
MEM	Memory requests	11
MSG	System message processor	11
PFM	Permanent file manager	5
QAC	Queue access interface	8
QFM	Queue file manager	11
RCL	Recall CPU	11
RFL	Memory requests	11
RPV	Reprieve processing	10
SFM	System file manager	11
TCS	Command translator	10
TIM	Time and date functions	9
TLX	Interactive terminal requests	11
WCL	Recall CPU for a specified time	11

SYSTEM REQUESTS

All communication with the system is performed by entering a system request in location 1 (RA+1) of the field length and executing an exchange jump (XJ) instruction (refer to figure E-1). The system then initiates execution of that portion of the system required to satisfy the request. There are two types of system requests.

- Those that contain all information necessary in RA+1 (for example, RCL).
- Those that require additional areas for parameters or results from the system; for example, CIO requires the specification of a file environment table (FET).

The format of the 60-bit request is one of the following (depending on whether two or three parameters are to be passed).

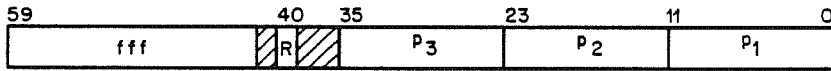

fff System request name.

R Auto recall bit.

P₁,P₂,P₃ Parameters passed to the portion of the system that processes fff.

SYSTEM REQUEST PROCESSING

Whether a system request communicates with a FET or another parameter block, the first word of this area is usually the status word. Both the system and the user program use the lower portion of this word to communicate the status of the request. When bit 0 is cleared (equals 0), the system is in control of the request; when it is set (equals 1), the user program is in control of the request.

For example, to write on file ABC, the user program must perform the following steps (if you use the macro interface described in section 3, the common decks COMCCIO and COMCSYS perform these steps for you).

1. Check the status (bit 0 of the first word of the FET, address 2000 in the example) of ABC.
2. If ABC is busy (bit 0 cleared), the user program must wait until bit 0 is set. This is done by issuing a system request to recall (RCLP), or by issuing a RECALL macro on the FET.
3. When ABC is idle (bit 0 set), the user program must clear bit 0 and place the request in RA+1.
4. If other processing can be performed, the user program proceeds.
5. If further processing depends upon ABC being completed, the user program must check the status word for completion (bit 0 set by the system).

To perform this write operation on file ABC, the user program issues a system request to CIO. The following diagram illustrates the program/system control when performing this operation.

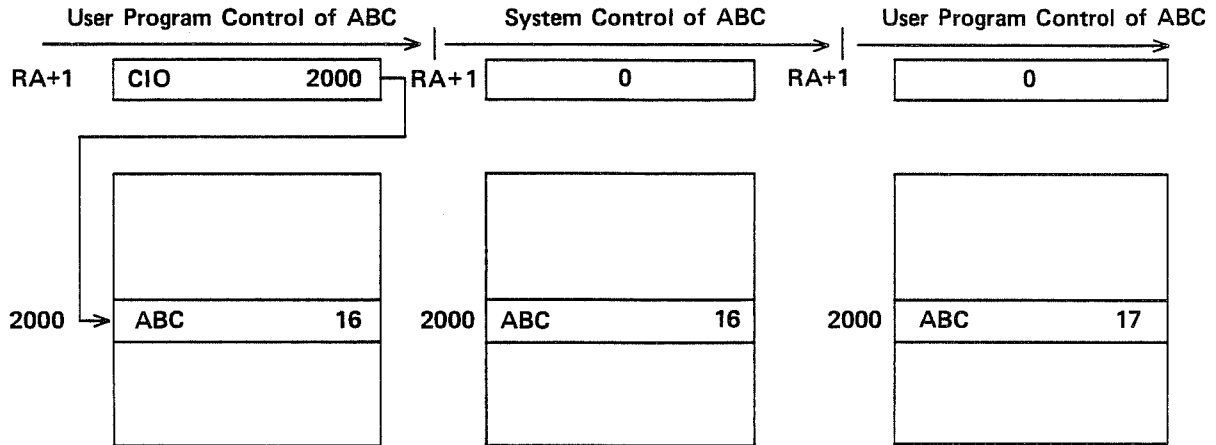

The user program requests the system to take control of ABC by clearing bit 0 of the first word of the FET (address 2000) and entering CIO 2000 in RA+1.

The system clears RA+1 upon beginning processing of the request.

The system sets bit 0 of the first word of the FET upon completing the request.

In many situations, the program cannot proceed until the system request is complete (as in steps 2 and 5 when ABC is busy). The user program can prevent further execution until the request is complete (bit 0 of the first word of the FET set) by issuing a recall (RCLP) request or a RECALL macro on the FET after the CIO request or by specifying the auto recall bit on the original CIO request. This reduces the amount of CPU time used by the job.

If the request in the previous example were issued with auto recall specified,

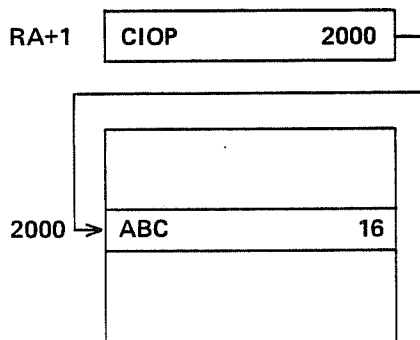

P is the display code representation of the auto recall bit (20_8); that is, bit 40 of RA+1 is set.

the system would not allow the job to continue execution until bit 0 of word 2000 is set.

The program must perform the following steps to process the request with auto recall (if you use the macro interface described in section 3, the common decks COMCCIO and COMCSYS perform these steps for you).

1. Check the status of ABC (bit 0 of word 2000, which is the first word of the FET).
2. If ABC is busy, wait until bit 0 is set and return to step 1. This can be done by issuing an RCLP request or a RECALL macro on word 2000.
3. Clear bit 0 of word 2000 and place the CIOP request in RA+1.

Processing can proceed with the assurance that the previous operation on ABC is completed (bit 0 of word 2000 does not have to be checked).

You should be aware that many system requests require that the auto recall bit be set. This is noted in the description of the requests where applicable.

ISSUING RA+1 REQUESTS

When a system request is placed in RA+1, the user program should issue an exchange jump instruction (XJ) to ensure immediate processing of the request.

When the system detects a request in RA+1 that can be processed, RA+1 is cleared and processing begins.

The following example illustrates the steps involved in processing a system request.

1. The user program issues a CIO request on the FET address, without the auto recall bit set,† to RA+1.
2. The user program issues an XJ instruction.
3. The system immediately accepts the CIO request. The user program begins to execute again only after the system has started processing the request.
4. At the point where the user program requires that the CIO request be completed before further instructions are executed, the program issues an RCLP request on the FET address. This prevents the user program from continuing until the CIO request is completed.

The user program places the system request in RA+1 and executes an XJ instruction. The CPU is exchanged to the system program CPUMTR from the user program. The system acts upon the request immediately.

If you use the macros described in this manual, the common deck COMCSYS places the function request in RA+1 and issues the XJ instruction for you.

†If the CIO request in this example were made with the auto recall bit set, step 4 would not be necessary because the user program would not resume execution until the CIO request completes.

NOS SYSTEMS TEXTS

The following systems texts are available to you.

- SYSTEXT.
- PPTEXT.
- NOSTEXT.
- PSSTEXT.
- ECSTEXT.

Although other systems texts exist, the macros described in this manual are supported only in the systems texts just listed.

SYSTEXT contains system communication macros that are used by the CPU COMPASS programmer. PPTEXT contains symbol definitions used by all system PP routines for intercommunication and contains the micro NOSVER as defined in the system OPL common deck COMSVER. NOSTEXT contains all system communication macros, micros, and symbol definitions that are found in SYSTEXT and PPTEXT.

NOTE

In order to use symbol definitions contained in a systems text, you must include the COM-PASS pseudoinstruction SST in your program.

PSSTEXT contains macros that are defined on system OPL common decks COMCMAC and COMCCMD, and the micro NOSVER defined on system OPL common deck COMSVER (refer to Common Deck Usage in this section and to appendix F).

ECSTEXT contains operation definitions that are defined on common deck COMCECM. These definitions provide instructions for interpretive mode reading and writing of extended memory (refer to appendix D).

By selecting the correct systems text (for the applications COMPASS programmer, this is usually SYSTEXT and/or PSSTEXT), you can reduce the amount of system resources needed for assemblies.

To obtain listings of the systems texts, enter one or more of the following commands after accessing the system OPL.†

```
MODIFY,Q,CL,CS=0,Z./*EDIT,SYSTEXT
```

```
MODIFY,Q,CL,CS=0,Z./*EDIT,PPTEXT
```

```
MODIFY,Q,CL,CS=0,Z./*EDIT,NOSTEXT
```

```
MODIFY,Q,CL,Z./*EDIT,ECSTEXT
```

†Your site must control access to the system OPL as required by the site's licensing agreement. Contact your site analyst to obtain the procedure for gaining access to the system OPL. These examples (and all following examples) assume that you have the system OPL available with a local file name of OPL.

To obtain a listing of PSSTEXT, enter the following commands after accessing the system OPL.

```
MODIFY,Z./*EDIT,PSSTEXT
```

```
COMPASS,I,LO=X.
```

MACRO USAGE

Macros are available for issuing most requests to the function processors. If macros are not available, you can define your own using the MACRO pseudoinstruction (refer to the COMPASS Version 3 Reference Manual).

A macro is a predefined sequence of COMPASS statements that can be used in a program. You can use predefined macros by specifying the location of the macro definitions to COMPASS with the S or G parameter. For example:

```
COMPASS,I,B,S=XYZTEXT.
```

This call causes all macro definitions in XYZTEXT to be available for assembly of the program. If no S parameter is specified, COMPASS uses the system default system text SYSTEXT. The macros described in this manual, unless otherwise noted, are defined in SYSTEXT and NOSTEXT.

Some macros are defined in common decks. To assemble programs containing these macros, the common deck must be called into the text of the program (refer to Common Deck Usage in this section). If a macro is defined in common deck COMCMAC or COMCCMD, you have the option of specifying the alternate systems text PSSTEXT. For example:

```
COMPASS,I,B,S,S=PSSTEXT.
```

This makes available all macro definitions in PSSTEXT (that is, those defined in common decks COMCMAC and COMCCMD) as well as all macros in SYSTEXT for the assembly of the program.

In addition to the macros available in SYSTEXT, an integer divide operation definition is provided for your convenience. Its format is as follows:

```
IXi Xj/Xk
```

The operation divides Xj by Xk and places the result in Xi. The contents of registers Xj, Xk, and B7 are destroyed.

When a macro parameter refers to an address, the parameter may generally be a register name, a relocatable address, an external symbol, or an absolute address. You should consult the expansions of the system macros to determine whether registers can be used with a given macro and, if so, the optimum use of registers. You are responsible for ensuring that a register used as a parameter contains only the parameter (for example, if an 18-bit address is specified by an X register, you must in some cases ensure that the upper 42 bits of the register are zero).

Most NOS system macros and common decks preserve the contents of the following registers.

AO, X0, A5, and X5

Also, upon exit, the contents of registers B1 and X2 are as follows:

B1 1

X2 FET address (refer to section 2), if a macro specifies the FET address as a parameter

There are exceptions to these rules; you should refer to documentation of a macro or common deck when in doubt.

The contents of the B1 register are assumed to be 1 upon entry only if the SYSCOM B1 macro is called or the B1=1 COMPASS pseudoinstruction is defined.

SYSCOM

The SYSCOM macro performs the following functions.

- Optionally defines the B1=1 COMPASS pseudoinstruction.
- Defines system communication symbols.

If this macro is used, it should be declared before executable statements or common decks occur in the program.

Macro format:

<u>Location</u>	<u>Operation</u>	<u>Variable</u>
	SYSCOM	B1

B1 If present, COMPASS pseudoinstruction B1=1 is defined.

Many system common decks called from macros assume the contents of the B1 register to be equal to 1. Other common decks assume B1 is equal to 1 only if the macro SYSCOM B1 or COMPASS pseudoinstruction B1=1 is defined. If the B1 parameter is not included in the SYSCOM call or if there is no SYSCOM call, these common decks then generate additional code to set B1 equal to 1. If SYSCOM B1 or the B1=1 pseudoinstruction is used, it is your responsibility to set the B1 register equal to 1. This should be done as the first instruction executed in the program.

The specification of SYSCOM (with or without specifying B1) also makes available the system communication symbols (refer to figure E-1). These are:

<u>Symbol</u>	<u>Value</u>	<u>Description</u>
RA.MTR	1	Address of RA+1.
ARGR	2	Address of the first argument.
SPPR	278	Special program parameter area (locations 278 through 478).

<u>Symbol</u>	<u>Value</u>	<u>Description</u>
PGNR	64g	Program name (bits 59 through 18).
ACTR	64g	Argument count (bits 17 through 0).
CMUR, RA.CMU	65g	Compare/move unit (CMU) available flag (bit 59).
LWPR	65g	LWA+1 of the assigned program space (bits 17 through 0). If Common Memory Manager is loaded in your job's field length, bits 17 through 0 contain the complement of the LWA+1 of the assigned program space (refer to the Common Memory Manager Reference Manual).
FWPR	66g	FWA of the assigned program space (bits 17 through 0).
JOPR	66g	Job origin type (bits 35 through 24).
XJPR, RA.CEJ	66g	Central exchange available (bit 59). This bit is always set.
CSMR	67g	System character set mode flag (bit 59); set if 64-character set mode.
LDRR	67g	LDR completion (bit 29).
CCDR	70g	Command image (eight locations).
LINP	60 ₁₀	Lines per page; used to format output.

COMMON DECK USAGE

A system common deck is a COMPASS subroutine or group of macro or symbol definitions that have been tested, optimized, and placed on a program library from which you can access them.

All of the common decks supplied with the system are available to any user who has access to the system OPL.[†] The OPL is a collection of records of text that can be accessed randomly by the Modify utility program. Refer to the MODIFY command in Volume 3, System Commands, or to the Modify Version 1 Reference Manual. Normally, the system OPL is available as a direct access permanent file and you must issue an ATTACH command before Modify runs.

Several classes of system common decks exist; however, you need only be concerned with the CPU common decks. Documentation of the common decks provided with the system OPL can be obtained with the following commands after the system OPL is accessed.

```
MODIFY,Z./*EDIT,CALLCPU
DOCUMENT.
```

To obtain a complete listing of the routines, enter the following command.

```
MODIFY,Q,CL,CS=NOSTEXT,Z./*EDIT,CALLCPU
```

[†]Your site must control access to the system OPL as required by the site's licensing agreement. Contact your site analyst to obtain the procedure for gaining access to the system OPL.

Appendix F contains a list of the CPU common decks of general interest and describes their functions.

CPU common deck names have the following format.

COMCxxx

COM	Indicates a common deck.
C	Specifies CPU common deck.
xxx	Entry point name (sometimes defined inside the routine as xxx=).

The typical COMPASS programmer who is writing relocatable programs is generally unaware of the common deck interface, and needs only be concerned if a common deck of unique nature (for example, the common deck that converts display code to binary representations) is required, or if the specified common deck is not on the system library (SYSLIB). Refer to appendix F for a list of common decks available in relocatable form on SYSLIB.

Two common decks (COMCMAC and COMCCMD) are also available on systems text PSSTEXT. You have the option of either calling these decks from the system OPL or specifying the alternate systems text PSSTEXT as described under Macro Usage, earlier in this section.

Most system macros require that the common deck related to a function processor be available in the program; however, you do not need to specifically call them when assembling relocatable programs, since all macros specify entries to common decks as external symbols. When the relocatable subroutines are loaded, the routines required at execution time (such as LFM= and CIO=) are loaded from SYSLIB.

For example, a subroutine uses the following macro.

```
.  
.br/>READ      ABC,R  
.
```

This macro requires routines CIO= and SYS= ; however, the READ macro generates:

```
RJ      =XCIO=
```

and CIO= generates:

```
RJ      =XSYS=
```

Since these are flagged as external references (=X), the loader satisfies them from SYSLIB if they are not locally satisfied.

If a program is not relocatable or if the desired common deck is not on SYSLIB, then a system common deck must be accessed from the system OPL.

To use a common deck, either insert the Modify directive *CALL in the text of your program, use the COMPASS pseudoinstruction XTEXT, or, for a relocatable program, reference the entry point as an external so that it is loaded and linked from SYSLIB.

NOTE

When using a common deck, you should be aware both of the entry and exit conditions for the common deck and of which registers that deck uses. These are contained in the documentation within each common deck.

The following example illustrates the procedure for using the *CALL directive.

```

JOB1.
USER,USERNAM,PASSWRD.
COPYBR,INPUT,XFILE.          COPY PROGRAM TO XFILE
ATTACH,OPL/UN=LIBRARY.       ATTACH OPL
.RFL,45000.
MODIFY,Q,CL.                  CALL MODIFY PROGRAM
LGO.                           LOAD AND EXECUTE COMPASS BINARY
-EOR-
PROG                            DECK NAME TO BE EDITED
                                IDENT  PROG,TME
                                ABS      BODY OF ABSOLUTE COMPASS PROGRAM
                                ENTRY  START  THAT OUTPUTS THE CURRENT TIME
                                SYSCOM B1
                                ORG    110B
                                TME    CON    0
                                OUTPUT FILEC OBUF,101B
                                START  SB1    1
                                CLOCK  TME    CLOCK MACRO REQUIRES
                                SA5    TME    COMMON DECK COMCSYS
                                BX6    X5
                                WRITEO OUTPUT WRITEO MACRO REQUIRES COMMON
                                WRITER OUTPUT DECK COMCWTO, WRITER REQUIRES
                                ENDRUN COMCCIO, ENDRUN REQUIRES COMCSYS
                                *CALL  COMCCIO MODIFY DIRECTIVES TO INSERT
                                *CALL  COMCWTO SPECIFIED COMMON DECKS
                                *CALL  COMCSYS
                                OBUF   BSS    101B
                                END
                                -EOR-
                                *REWIND XFILE REPOSITION XFILE TO BOI
                                *CREATE XFILE CREATE PROGRAM LIBRARY
                                *EDIT  PROG MODIFY DECK PROG
                                -EOI-

```

The procedure for using the COMPASS pseudoinstruction XTEXT to obtain common decks is detailed in the following example.

```
JOB2.
USER,USERNAM,PASSWRD.
ATTACH,OPL/UN=LIBRARY.
COMPASS.
LGO.
-EOR-
      IDENT  PROG,TME
      ABS
      ENTRY  START
      SYSCOM B1
      ORG    110B
TME   CON    0
OUTPUT FILEC OBUF,101B
START SB1    1
      CLOCK  TME
      SA5    TME
      BX6    X5
      WRITEO OUTPUT
      WRITER OUTPUT
      ENDRUN
OPL   XTEXT  COMCSYS
OPL   XTEXT  COMCWTO
OPL   XTEXT  COMCCIO
OBUF  BSS    101B
      END
-EOI-
```

After attaching the system OPL, a call is made to the COMPASS assembler. The XTEXT pseudoinstruction provides a means of obtaining source statements from a file other than that being used for input. COMPASS transfers the text from the external source and assembles it before taking the next statement from the program.

A COMPASS listing from a program using the XTEXT pseudoinstruction also does not list the inserted common decks. These can be obtained with the COMPASS LIST pseudoinstruction or by using list options on the COMPASS command.

A conflict of tags is one problem that may arise when using common decks. Since all tags and routine names within common decks conform to the NOS programming specifications (refer to appendix I), each routine name relates to its particular function. Normally, all system common decks are automatically qualified by the common deck name (refer to the description of the QUAL pseudoinstruction in the COMPASS Version 3 Reference Manual), so that no internal tags other than routine names should cause a tag conflict. If one of your routine names conflicts with a routine name in a common deck being used, you should rename your routine.

If you do not wish to rename your routines, you may instead use the following procedure.

1. Define the tag QUAL\$ to turn off automatic qualification of common decks.
2. Manually qualify the entire common deck (including the routine names) with the QUAL pseudoinstruction.

For example, to use the space-fill-name common deck COMCSFN, you can use the method shown in the following sample program.

DUPLICT

IDENT DUPLICT
ENTRY DUPLICT

*CALL COMCMAC
QUALS EQU 1 SUPPRESS AUTOMATIC COMMON DECK QUALIFICATION

* THE *SPACE FILL NAME* COMMON DECK MUST BE QUALIFIED
* BECAUSE THE PROGRAM HAS A SUBROUTINE *SFN* AND THE
* PROGRAMMER DOES NOT WISH TO RENAME THE SUBROUTINE.

DUPLICT SB1 1 ENTRY
SA1 DUPA SET SYMBOL NAME IN MESSAGE
MX0 -18 CLEAR VALUE PORTION OF WORD
SX5 X1+ SAVE VALUE
BX1 X0*X1
RJ /SFILL/SFN SPACE FILL WORD
SA6 DUPC
SX1 X5+ CONVERT VALUE
RJ CDD
SB2 3 SHIFT VALUE 3 CHARACTERS LEFT
RJ SFN
SA6 DUPD ISSUE MESSAGE
MESSAGE DUPB,,R
ENDRUN

Transfers control to
COMCSFN, qualified
by SFILL

Transfers control to
the program's shift
register routine, SFN

DUPA CON OLNAME+123456
DUPB CON 10H SYMBOL
DUPC CON 0 SYMBOL NAME
CON 10HHAS VALUE
DUPD CON 0 CONVERTED SYMBOL VALUE
CON 0 MESSAGE TERMINATOR

SFN SPACE 4,10
** SFN - SHIFT REGISTER BY *N* CHARACTERS.

*
* ENTRY (X6) = REGISTER TO SHIFT.
* (B2) = NUMBER OF CHARACTERS TO SHIFT.
*
* EXIT (X6) = SHIFTED LEFT.
*
* USES B - 2.
* X - 6, 7.

SFN SUBR ENTRY/EXIT
SX7 B2 SET NUMBER OF BITS TO SHIFT
SB2 B2+B2
LX7 2
SB2 B2+X7
LX6 X6,B2 SHIFT REGISTER
EQ SFNX RETURN
SPACE 4,10

* COMMON DECKS.

*CALL COMCSYS
*CALL COMCCDD
QUAL SFILL QUALIFY *SFN*
*CALL COMCSFN
QUAL * RESTORE NULL QUALIFIER
SPACE 4,10
END DUPLICT

The QUAL\$ tag can also be used to suppress the qualification of common decks called more than once in separate overlays. In the following example, the QUAL pseudoinstruction is used in each of the two primary overlays; the symbol QUAL\$ is used to allow a copy of COMCCDD in each overlay without symbol conflicts.

```

OVER      IDENT  MAIN,MAIN,MAIN      MAIN (0,0) OVERLAY
          ABS
          TITLE MAIN (0,0) OVERLAY.
          ORG   110B

QUAL$    EQU    1          SUPPRESS COMMON DECK QUALIFICATION

*        LOAD TWO OVERLAYS - ONE AT A TIME - EACH WILL USE
*        ITS OWN COPY OF *CDD*, BUT WILL USE *SYS=* AND
*        *MSG=* THAT RESIDE IN THE (0,0) OVERLAY.

MAIN     SB1     1
          MESSAGE MAIA,,R * MAIN RUNNING.*
          OVERLAY MAIB,0100B LOAD *OVL1* OVERLAY
          SB2    X1      EXECUTE *OVL1*
          JP     B2

MAI1     OVERLAY MAIB,0200B LOAD *OVL2* OVERLAY
          SB2    X1      EXECUTE *OVL2*
          JP     B2

MAI2     MESSAGE MAIC,,R * MAIN COMPLETE.*
          ENDRUN  END

MAIA     DATA   C* MAIN RUNNING.*
MAIB     CON     OLLGO   OVERLAY FILE NAME
MAIC     DATA   C* MAIN COMPLETE.*

*CALL    COMCSYS
*CALL    COMCOVL

OVER     BSS     0          OVERLAY AREA BASE
          TTL    PRIMARY (1,0) OVERLAY.
          EJECT
          QUAL   OVL1     DEFINE QUALIFICATION FOR THIS OVERLAY
          IDENT  OVL1,OV1,OV1,1,0   PRIMARY (1,0) OVERLAY
          ORG    OVER     START AT OVERLAY AREA

```

* READ THE REAL TIME CLOCK AND ISSUE A DAYFILE MESSAGE
* INDICATING WHEN OVERLAY WAS CALLED.

OV1 RTIME OV1A GET CURRENT TIME
SA1 OV1A CONVERT MILLISECONDS TO DISPLAY CODE
MX0 -36
BX1 -X0*X1
RJ CDD
SA6 OV1C
MESSAGE OV1B,,R * OVL1 CALLED AT NNNNNN*
EQ MAI1 RETURN

OV1A CON 0 REAL TIME CLOCK
OV1B DATA 20H OVL1 CALLED AT
OV1C CON 0 CONVERTED MILLISECONDS
CON 0 MESSAGE TERMINATOR

*CALL COMCCDD

TTL PRIMARY (2,0) OVERLAY.
EJECT
QUAL OVL2 DEFINE QUALIFICATION FOR THIS OVERLAY
IDENT OVL2,OV2,OV2,2,0 PRIMARY (2,0) OVERLAY
ORG OVER START AT OVERLAY AREA

* READ THE REAL TIME CLOCK AND ISSUE A DAYFILE MESSAGE
* INDICATING WHEN OVERLAY WAS CALLED.

OV2 RTIME OV2A GET CURRENT TIME
SA1 OV2A CONVERT MILLISECONDS TO DISPLAY CODE
MX0 -36
BX1 -X0*X1
RJ CDD
SA6 OV2C
MESSAGE OV2B,,R * OVL2 CALLED AT NNNNNN*
EQ MAI2 RETURN

OV2A CON 0 REAL TIME CLOCK
OV2B DATA 20H OVL2 CALLED AT
OV2C CON 0 CONVERTED MILLISECONDS
CON 0 MESSAGE TERMINATOR

*CALL COMCCDD

END

This section describes the file communication area necessary for file creation and the processing of many user requests. The file environment table (FET) is the standard communication area or parameter block for the system file processors. The COMPASS programmer must define the FET, whereas the higher level languages (COBOL and FORTRAN, for example) automatically establish and use this area.

Depending on the processor being used, certain areas of the FET must be defined and used in communicating with that processor. The minimum length of a FET is five words, although many processors require a longer FET.

CIRCULAR BUFFERS

A circular buffer is a central memory storage area that contains data during input/output operations. It is called a circular buffer because routines that process input/output treat the first word of the buffer area as if it were contiguous to the last word of the buffer area.

All input/output is performed by passing data between a circular buffer in central memory and a peripheral device (mass storage or magnetic tape, for example).

The buffer pointers FIRST, IN, OUT, and LIMIT define the circular buffer (figure 2-1).

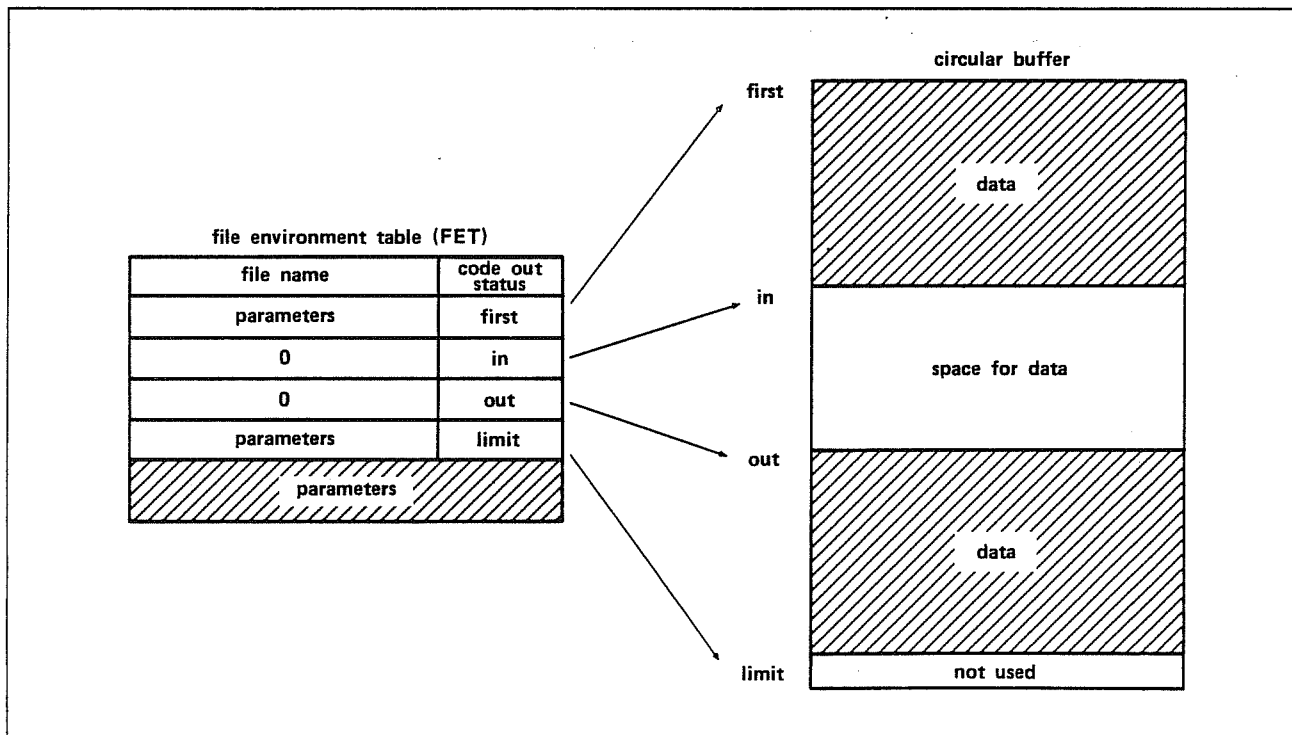

Figure 2-1. Circular Buffer

FIRST ADDRESS

FIRST is the address of the first word of the buffer area. Routines that perform input/output never change the value of FIRST.

LIMIT ADDRESS

LIMIT is the address of the word following the last word of the buffer area. Buffer data is not stored in LIMIT. When LIMIT is reached during a read or write operation, the next word to be read or written is FIRST. Routines that perform input/output never change the value of LIMIT.

The addresses FIRST and LIMIT define the boundaries of the circular buffer. The size of the buffer is always (LIMIT-FIRST).

IN ADDRESS

IN is the address of the next word of the buffer into which data can be entered. During a read operation, the system enters data into the buffer beginning at IN; during a write operation, the user program enters data into the buffer beginning at IN. During a read operation, the system increments IN as it enters data into the buffer; when IN reaches LIMIT, the system immediately resets IN to FIRST. During a write operation, the user program must increment IN as it enters data into the buffer, and must reset IN to FIRST when IN reaches LIMIT (the data transfer macros described in section 3 increment and reset the buffer pointers as necessary for the user program).

If, during a CIO operation, IN reaches (OUT-1), or IN reaches (LIMIT-1) and (OUT=FIRST), the buffer is full. The buffer is full when all words except one contain data. Because the system enters data into the buffer one PRU at a time rather than one word at a time for some CIO operations, the system may consider the buffer to be full if it attempts to enter data into the buffer and the buffer contains less than one PRU of available space.

OUT ADDRESS

OUT is the address of the next word of the buffer from which data can be read. During a write operation, the system removes data from the buffer beginning at OUT; during a read operation, the user program removes data from the buffer beginning at OUT. During a write operation, the system increments OUT as it removes data from the buffer; when OUT reaches LIMIT, the system immediately resets IN to FIRST. During a read operation, the user program must increment OUT as it removes data from the buffer, and must reset OUT to FIRST when OUT reaches LIMIT (the data transfer macros described in section 3 increment and reset the buffer pointers as necessary for the user program).

If OUT reaches IN during a CIO operation, the buffer is empty. Because the system removes data from the buffer one PRU at a time rather than one word at a time for some CIO operations, the system may consider the buffer to be empty if it attempts to remove a PRU of data from the buffer and the buffer contains less than one PRU of data.

Figure 2-2 is an example of a read operation.

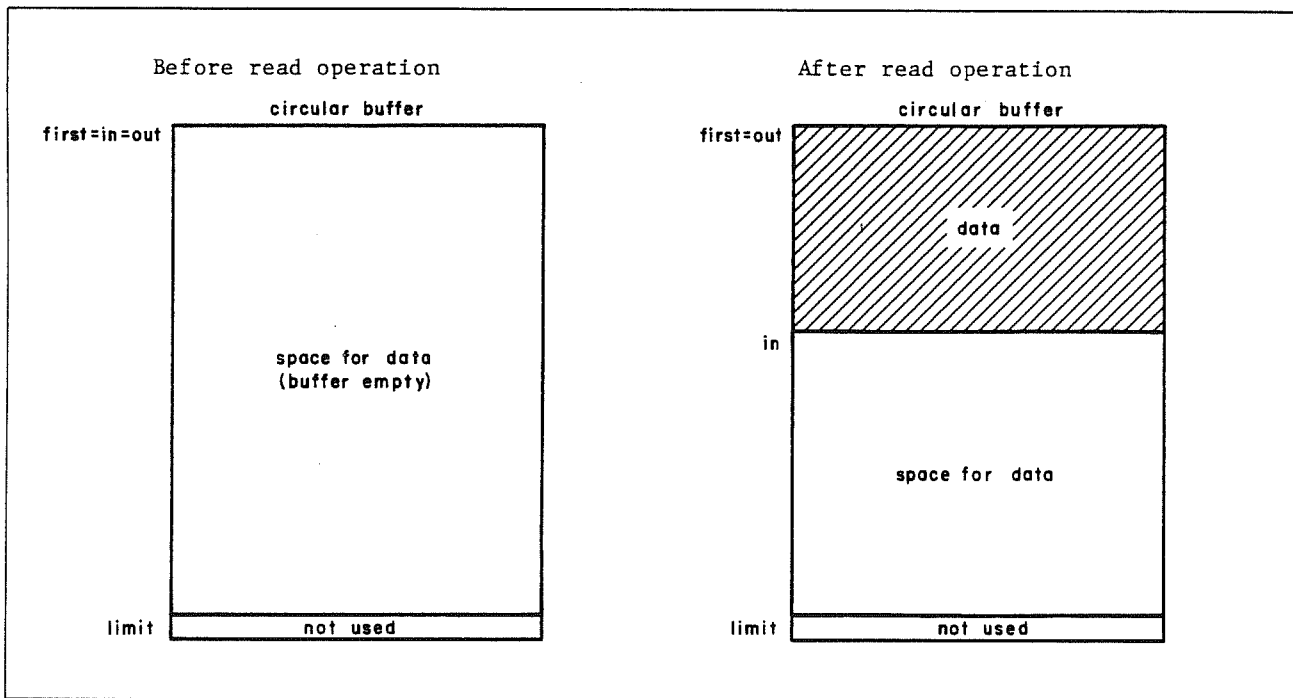

Figure 2-2. Read Operation

DATA SPACE

At any instant a circular buffer is either empty, partially full, or full. When empty, the available unused space in a buffer is one word less than the size of the buffer. When full, all words but one of the buffer contain data.

The system does not permit a circular buffer to be completely filled with data because the IN and OUT pointers would contain equal values and a full buffer could not be distinguished from an empty buffer.

If IN is less than OUT, the amount of data in the buffer is $(LIMIT-FIRST) - (OUT-IN)$ and the available space is $(OUT-IN-1)$. If IN is greater than OUT, the amount of data in the buffer is $(IN-OUT)$ and the available space is $(LIMIT-FIRST) - (IN+1-OUT)$.

Figure 2-3 is an example of a write operation.

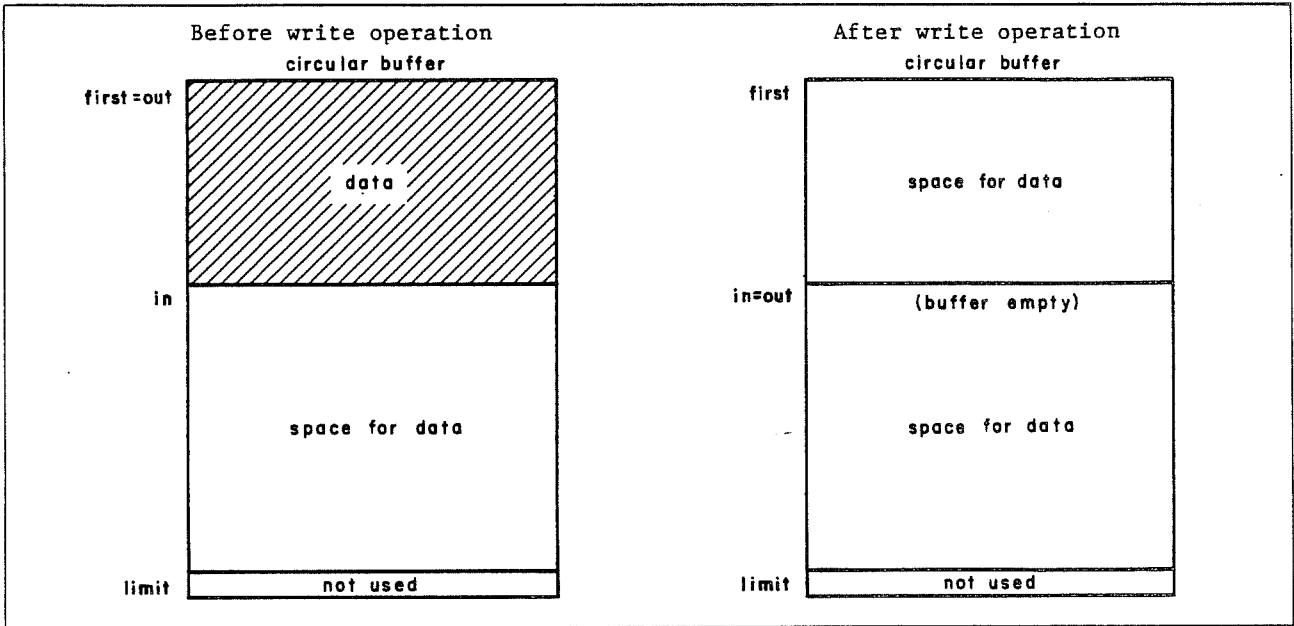

Figure 2-3. Write Operation †

FET DESCRIPTION

There are two basic FET formats. Figure 2-4 illustrates the standard FET for mass storage and terminal files; figure 2-5 illustrates the standard FET for magnetic tape files. The figures are followed by a description of the FET fields. When a field is used by only one of the file processors, it is noted in the description.

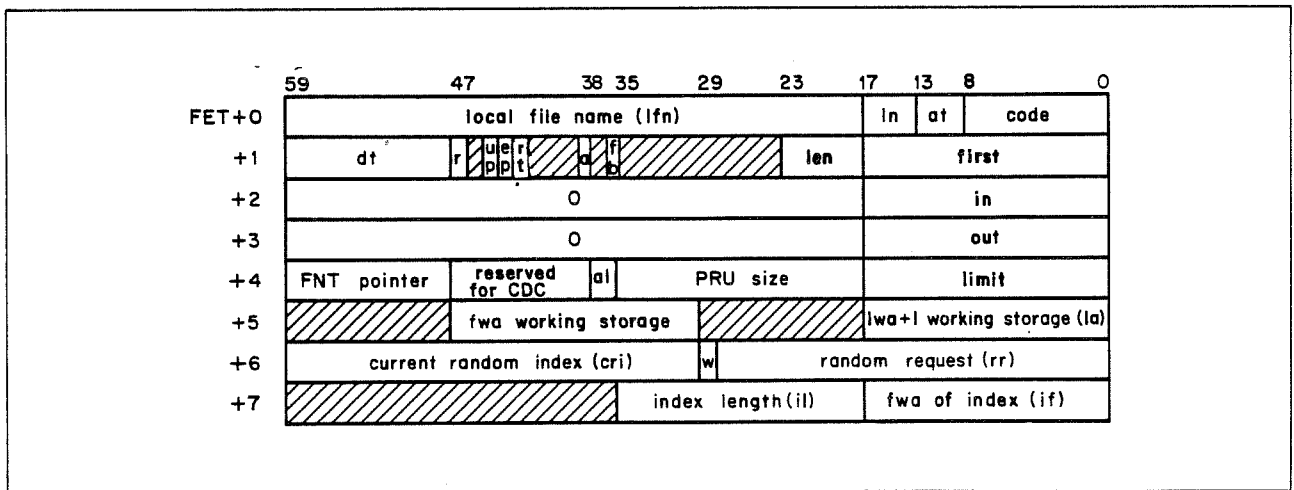

Figure 2-4. Standard FET for Mass Storage and Terminal Files

†Refer to section 5 for a description of the FET fields used in processing permanent file manager (PFM) requests.

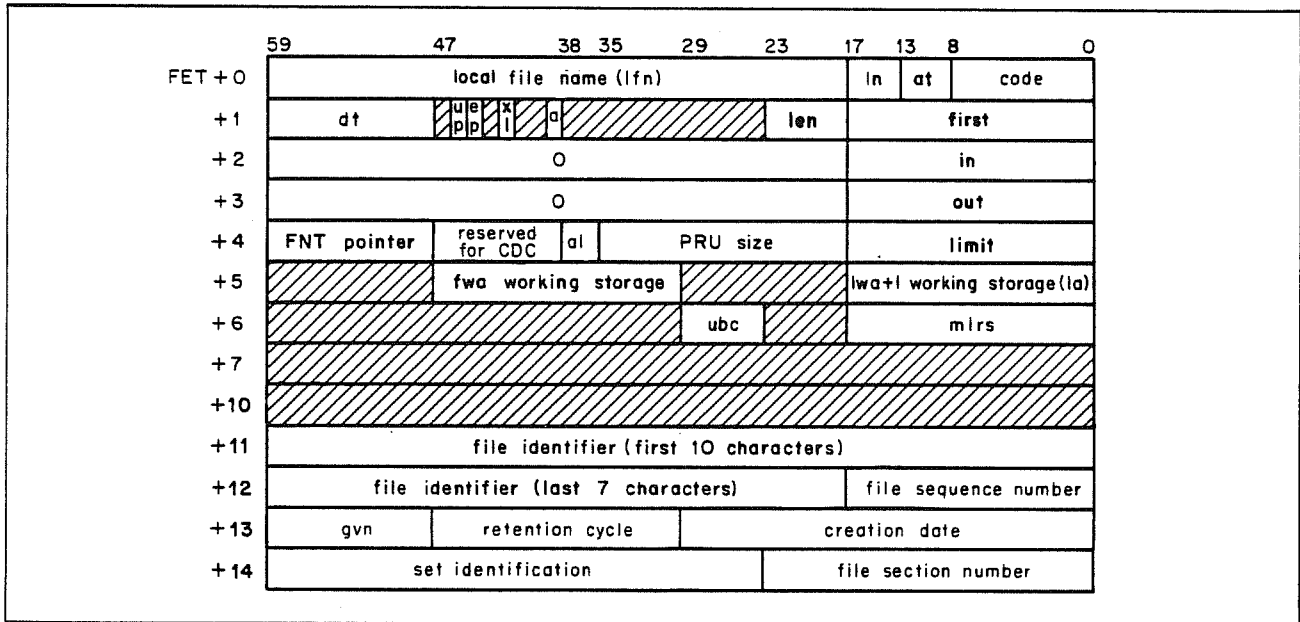

Figure 2-5. Standard FET for Labeled Magnetic Tape Files (CIO and POSMF)†

Parameter	Word (FET+n)	Position	Description
Local file name (lfn)	0	59-18	The lfn field contains one to seven alphanumeric display code characters, left-justified; unused characters are zero-filled. The lfn is the common reference point for all system communication concerning the file.
Level number (ln)	0	17-14	This is the level number for an end-of-record (EOR)/end-of-file (EOF) operation on the file. NOS uses this field for CIO operations and for distinguishing interactive input from noninteractive input (refer to CIO in section 3 and the discussion on writing interactive programs, section 12).
Abnormal termination codes (at)	0	13-9	Status information returned by the function processor when an abnormal situation or error occurs. This field is usually set by the processor when the error processing bit (ep) is set in FET+1. For some processors, at is returned in bits 17 through 9. This field is set to 228 by CIO if the ep bit is not set and an error condition is present. Refer to section 3 for the specific error codes returned.

†Refer to the LABEL and OPEN macros for a description of the FET fields used in processing ANSI labels.

<u>Parameter</u>	<u>Word (FET+n)</u>	<u>Position</u>	<u>Description</u>
Code	0	8-0	<p>Request/return code. The user program (or macro) sets this code for the request desired. The function processors alter it only if the request is not completed. For example, the user program requests a read (CIO code 010) but encounters an EOR. CIO returns a status code of 021. These codes are detailed in the function processor descriptions (refer to section 3). The following are subfields for the code parameter.</p> <p>Bit 1: file mode (fm). File mode for input/output operations on S, L, or SI tape formats only. For S or L format tapes, bit 1 is:</p> <p style="margin-left: 40px;">0 Coded 1 Binary</p> <p>Binary mode must be selected for SI tape formats or the program is aborted.</p> <p>Bit 0: interlock (ilk). FET interlock bit. Used to indicate system/user access to data associated with the file. The user program sets this bit to 0 (busy or not complete) and the processor sets it to 1 when the request is completed.</p>
Device type (dt)	1	59-48	<p>The 12-bit display code of the type of device on which the file is or will be residing (refer to Device Types in appendix E). After the file is assigned to a device, the STATUS macro or any CIO function enters the device type in this field and sets bit 59 if the device is a nonallocatable nonmass storage device.</p>
Random access (r)	1	47	<p>This bit is set if random processing is to be performed on the file. If this bit is set, the FET must be at least seven words in length.</p>
User processing (up)	1	45	<p>The user program sets this bit to control end-of-reel or end-of-device processing. When CIO encounters an end-of-reel/end-of-device, it returns an abnormal termination code of 2 (bits 13 through 9 of FET+0). For further information about end-of-reel processing, refer to the CIO CLOSER macro description.</p>

<u>Parameter</u>	<u>Word (FET+n)</u>	<u>Position</u>	<u>Description</u>
Error processing (ep)	1	44	<p>This bit is used to indicate to the function processor that the calling program processes errors that occur, such as parity errors or errors in requests to the file managers. The function processor returns the error code to the at field of FET+0. Refer to the section of this manual relating to the specific processor called for descriptions of the error codes returned. If this bit is not set, the function processor either aborts the job or requests operator intervention.</p> <p>If an unrecovered parity or block too large error occurs during a magnetic tape read operation (with the ep bit set) or if a read parity error occurs on a mass storage read operation (with ep bit set), the system performs the following steps.</p> <ol style="list-style-type: none"> 1. The data in the bad block is stored in the user program's circular buffer. 2. The value of the IN pointer prior to the read is stored in the next word in the circular buffer (pointer to the beginning of the bad data block). 3. The parity error code is set in FET+0. 4. The IN pointer is updated in the FET. This IN pointer value does not include the additional word (pointer to the beginning of the bad data block) stored in the buffer. 5. The FET completion bit is set. <p>The pointer to the bad data is returned on all reads processed by CIO for a mass storage file. If no data is transferred (correct PRU not read), the pointer points to itself, and no update of IN occurs.</p> <p>If tape error processing is inhibited (refer to the LABEL macro, section 4), the preceding steps are not performed regardless of whether or not the ep bit is set.</p>

<u>Parameter</u>	<u>Word (FET+n)</u>	<u>Position</u>	<u>Description</u>
Real time bit (rt)	1	43	When the real time bit is set, the job will not roll out and will not wait for an inaccessible device. The real time bit may be set directly in the FET by a CPU program or it may be set using one of the FET creation macros: FILEB, FILEC, RFILEB, or RFILEC.
Extended label processing (xl)	1	41	Specifies standard (xl=0) or extended (xl=1) tape label processing.
Access level bit (a)	1	39	If this bit is set, the file's security access level is to be taken from or returned to the al field in FET+4.
Flush bit (fb)	1	36	If this bit is set, the file's circular buffer is to be flushed upon abnormal termination or for terminal files when the job is rolled out.

Files that are pointed to by the list of files (refer to the SETLOF macro, section 6) and meet the following criteria are flushed with the appropriate write function.

- Original error flag (ef) is less than SPET (refer to EREXIT macro, section 6).
- No buffer parameter errors; that is, the entire FET must be within the job's field length as follows:
 - LIMIT.LE.FL
 - OUT.LT.LIMIT
 - OUT.GE.FIRST
 - IN.LT.LIMIT
 - IN.GE.FIRST
- The code field of the FET is set to one of the valid function codes that enable implicit terminal output (refer to table 3-1).
- No CIO error code is present in the FET.
- Data is in buffer.

<u>Parameter</u>	<u>Word (FET+n)</u>	<u>Position</u>	<u>Description</u>
			At the end of the job step, files are flushed with an end-of-record write (CIO function 024) unless the last function in the FET is a WRITECW (204) or WRITEN (264), in which case that function is reissued. The FET status is not changed for implicit terminal output, but the action taken by the system is the same as if a buffered write (CIO function 14 or 16) had been issued.
NOTE			
Care must be taken when selecting random files to be flushed since they could be truncated by an end-of-record write.			
FET length (len)	1	23-18	Specifies the additional length of the FET beyond normal size (five words). For example, if len = 3, FET length = 10g and FET+7 is the last usable word. Function processors require varying lengths for particular parameters.
first	1	17-0	First word address of input/output buffer (FIRST address).
in	2	17-0	The next available location for entering data into the buffer (IN address). The upper 42 bits should never be used since the function processors read and write the entire word.
out	3	17-0	The next available location for removing data from the buffer (OUT address). The upper 42 bits should never be used since the function processors read and write the entire word.
FNT pointer	4	59-48	Relative address of the local file name table (FNT) entry for the file. The system uses this pointer to reduce overhead when processing a file.

<u>Parameter</u>	<u>Word (FET+n)</u>	<u>Position</u>	<u>Description</u>
al	4	38-36	The numerical value of the file's security access level. (You can use the system OPL common deck COMCVLC to convert access level names to the corresponding numerical values, and vice versa.)
PRU size	4	35-18	Number of central memory (CM) words in a physical record unit (PRU) for the device to which the file is assigned. The PRU size for mass storage is always 100g CM words. The PRU size for magnetic tape varies according to the data format selected. Refer to appendix J for information on magnetic tape PRU size. This field is set only if the file is opened using the CIO OPEN macro.
limit	4	17-0	Last word address plus 1 of the buffer (LIMIT address). Data is never placed in or removed from LIMIT.
fwa working storage	5	47-30	First word address of working storage. Working storage is used by several of the compilers to control input/output in specific formats (blocking/unblocking). This parameter is not used by the system or the NOS common decks that refer to working storage areas. Working storage areas for use by macros (READS, READC, and so forth) require the user program to define its own working storage area and specify this area on each macro request. Pointers to working storage can be placed here for reference.
lwa+1 working storage	5	17-0	Last word address plus 1 (LWA+1) of working storage.
la	5	17-0	List address (CIO READLS and RPHRLS macros only). This points to the table of relative sector addresses.
Current random index (cri)	6	59-30	The current random index for the mass storage file being randomly accessed. The system returns the current position of the file after a random input/output request. This index is in the form of a relative sector address (rsa) from the beginning of the file. For any

<u>Parameter</u>	<u>Word (FET+n)</u>	<u>Position</u>	<u>Description</u>
			nonrandom read or write operation, the system updates this field by adding the number of sectors transferred to the existing contents of the field. For any random access or positioning operation, the value is recalculated. cri is ignored if r (FET+1) is not set.
Random rewrite request (w)	6	29	This bit is set to indicate a rewrite-in-place operation for one of the following functions: WPHR, WRITE, WRITER, WRITECW. If rr≠0 and this bit is not set, the write takes place at EOI with rr being used for the address for the return of rsa, where the write began. If w=0 and rr=0, a sequential write is performed at the current position of the file. This bit is ignored if r (FET+1) is not set.
Unused bit count (ubc)	6	29-24	Specifies the unused bit count for S and L format tapes (refer to appendix J).
Random request (rr)	6	28-0	Relative sector address (rsa) for a random input/output request. An exception is that if w=0 and the request is a write request, then rr is the address for the return of the starting rsa of the write (previous EOI). If the error processing bit (FET+1, bit 44) is set and an error occurs on a CIO request, the system returns detailed error status information to bits 11 through 0. For further information, refer to the description of CIO in section 3. rr is ignored if r (FET+1) is not set.
Maximum logical record size (mlrs)	6	17-0	Specifies the maximum physical record size for S and L format tapes. Refer to appendix J.
Index length (il)	7	35-18	Random index length. This must be set by the user program when requesting CIO OPEN to load the random index of a file or CIO CLOSE to dump the random index of a file. If r (FET+1) is not set, il is ignored.
Index first word address (if)	7	17-0	First word address of the index buffer. This is the area where CIO OPEN stores the index when opening a file or the area from which CIO CLOSE takes the index when closing a file. If r (FET+1) is not set, if is ignored.

<u>Parameter</u>	<u>Word (FET+n)</u>	<u>Position</u>	<u>Description</u>
File identifier	118	59-0	File identifier (first 10 display code characters, left-justified with display code blank fill).†
File identifier	128	59-18	File identifier (last seven display code characters, left-justified with display code blank fill).†
File sequence number	128	17-0	One- to three-digit numeric display code file sequence number (right-justified with display code zero fill).†
Generation version number (gvn)	138	59-48	One- or two-digit numeric display code generation version number (right-justified with display code zero fill).†
Retention cycle	138	47-30	One- to three-digit numeric display code retention cycle (right-justified with display code zero fill).†
Creation date	138	29-0	Creation date (two-digit numeric display code value for the year followed by a three-digit numeric display code value for the day within the year).†
Set identification	148	59-24	One- to six-character set identification (left-justified with display code blank fill).†
File section number	148	23-0	One- to four-digit numeric display code file section number (right-justified with display code zero fill).†

The r, w, and rr FET parameters affect file manipulation operations as shown in table 2-1. The effects of these parameters depend on the type of operation (read, write, or rewrite) being performed.

†Refer to the HDR1 label in Volume 3, System Commands.

Table 2-1. Effects of r, w, and rr FET Parameters on File Manipulation Operations

FET Bits				Operation	Definition
r	w	rr	cri		
0	0,1	Any	NR	Read, write, and rewrite	Operation is sequential.
1	0	0	R	Read	Reads from current position (same as sequential except cri is returned).
				Write	Sequential write is performed.
				Rewrite	Random write at current position is performed.
1	0	≠0	R	Read	Random read from rr is performed.
				Write	Write is performed at current EOI (position of file before write returned at address specified by rr).
				Rewrite	Random write or rr is performed.
1	1	0	R	Read	Reads from current position (same as sequential except cri is returned).
				Write	Sequential write is performed.
				Rewrite	Random write at current position is performed.
1	1	≠0	R	Read	Random read from rr is performed.
				Write	Random write at rr is performed.
				Rewrite	Random write at rr is performed.

NOTES:

r=1 A random operation can be performed. The system returns the current random index (cri) in FET+6 (position of file when the operation is complete).

Sequential write Writes at current position; data is followed by an EOI.

Random write Writes data without an EOI at the end (the remainder of the file, the portion following the data written, is not released).

cri R means value is returned; NR means value is not returned.

FET CREATION MACROS

The following four macros initialize FETs. They can be used to create sequential coded files, sequential binary files, random coded files, and random binary files.

FILEB

The FILEB macro creates a FET for a binary sequential file.

Macro format:

<u>Location</u>	<u>Operation</u>	<u>Variable</u>
lfn	FILEB	fwa,length,p ₁ ,p ₂ ,...,p _n

FILEC

The FILEC macro creates a FET for a coded sequential file.

Macro format:

<u>Location</u>	<u>Operation</u>	<u>Variable</u>
lfn	FILEC	fwa,length,p ₁ ,p ₂ ,...,p _n

RFILEB

The RFILEB macro creates a FET for a binary random file.

Macro format:

<u>Location</u>	<u>Operation</u>	<u>Variable</u>
lfn	RFILEB	fwa,length,p ₁ ,p ₂ ,...,p _n

RFILEC

The RFILEC macro creates a FET for a coded random file.

Macro format:

<u>Location</u>	<u>Operation</u>	<u>Variable</u>
lfn	RFILEC	fwa,length,p ₁ ,p ₂ ,...,p _n

The following parameters apply to each FET creation macro.

lfn Local file name and address of FET.

fwa First word address of CIO buffer.

length Length of the CIO buffer. Because the buffer is full when (IN=OUT-1) or (IN=LIMIT-1) and (OUT=FIRST), the buffer length should not be an exact multiple of PRU size. The following are the minimum and recommended buffer sizes for mass storage, tape, and terminal input/output.

<u>Device</u>	<u>Minimum (Octal)</u>	<u>Recommended (Octal)</u>
Mass storage	101 (without control words†)	1001 to 2001 (without control words)
	103 (with control words)	1021 to 2041 (with control words)
Tape (I and SI binary tape formats)	1001 (without control words)	3n+1 to 4n+1, where: n=1000 (without control words)
	1003 (with control words)	n=1002 (with control words)
Terminal		101 for input (larger sizes are recommended for terminals with line speeds above 1200 baud)
		301 for output

Refer to appendix J for a description of PRU sizes for S, L, and F tape formats.

† Refer to the CIO READCW (200) request for a description of control words.

Pi The following parameters can be used to set fields in the FET. They can be specified in any order.

<u>Parameter</u>	<u>Description</u>
DTY=dt	Sets the device type to dt. The user program must specify display code equivalent of dt. For example, set device type to TT by specifying DTY=2RTT or DTY=2424B. Refer to appendix E for legal device types.
EPR	Sets the error processing bit (FET+1, bit 44).
FET=len ₁	Sets the length of the FET to len ₁ .
IND=addr,len ₂	Sets the index first word address to addr and the index length to len ₂ .
LBL	Sets the FET length to 15 ₈ for tape label processing.
RTP	Sets the real time processing bit (FET+1, bit 43).
UPR	Sets the user processing bit (FET+1, bit 45).
WSA=addr,len ₃	Sets the first word address of working storage to addr and the length of working storage to len ₃ .
XL	Sets the extended label processing bit (FET+1, bit 41) and sets the FET length to 15 ₈ .

The following parameters are used for setting PFM communication words and fields (refer to chapter 5) in the FET.

IPR	Sets the interlock processing bit (FET+1, bit 42).
PFN=pfn	Sets the permanent file name in FET+10 ₈ to pfn.
PWD=pwd	Sets the permanent file password in FET+12 ₈ to pwd.
PKN=pn	Sets the pack name for access to permanent files residing on auxiliary devices in FET+14 ₈ to pn.
SAD	Sets the suppress address on the error message bit (FET+1, bit 46).
UCW=ucw	Sets the user control word (bit 59 must be set to indicate that the word contains user control information) in FET+13 ₈ to ucw.
USN=un	Sets the alternate user name in FET+11 ₈ to un.

The following example illustrates the use of FET creation macros to create an FET for sequential input/output operations.

```

BUFL    EQU    2001B
TAPE1   FILEB  BUF,BUFL,(FET=7)
BUF     BSS    BUFL
      .
      .

```

The following example creates a FET for retrieving a file from permanent file storage, loading the index block, and performing random input/output operations.

```
BUFL      EQU      2001B
INDXL     EQU      100B
TAPE1    RFILEB  BUF,BUFL,(FET=10D),(PFN=STOCKS),(IND=INDX,INDXL)
BUF       BSS      BUFL
INDX     BSS      INDXL
.
```

FET MODIFICATION MACRO

The SETFET macro modifies specified fields in a FET during program execution.

Macro format:†

<u>Location</u>	<u>Operation</u>	<u>Variable</u>
	SETFET	addr,p1,p2,...,pn

addr Address of FET to be modified.

P_i Parameters specifying fields in the FET to be modified.

The following parameters can be used to modify fields in the FET. They can be specified in any order.

NOTE

SETFET does not verify that the modified words are within the FET length.

†This macro is not available in SYSTEXT. The user program must specify systems text PSSTEXT or call common decks COMCCMD and COMCMAC (refer to appendix F). COMCMAC defines the X=pseudo macro which is used in COMCCMD.

<u>Pi</u>	<u>Description</u>
BUF=fwa,length	Changes the first word address of the CIO circular buffer to fwa and the length of the buffer to length. Thus, FIRST, IN, and OUT are changed to fwa and LIMIT is changed to fwa+length.
DTY=dt	Changes the device type to dt. The dt option is the display code equivalent of the device type, right-justified with binary zero fill in a register or a central memory location as described in SETFET Parameter Processing. Refer to appendix E for legal device types.
ERA=erad	Changes the error message return address to erad for PFM requests (refer to Error Processing in section 5).
ERP=erp	Sets the error processing, user processing, or real-time processing bit, or combinations of the error and user processing or error and real-time processing bits. The erp option can be a mnemonic as follows.

<u>erp</u>	<u>Value</u>	<u>Description</u>
U	4	Set user processing bit at FET+1, bit 45.
E	2	Set error processing bit at FET+1, bit 44.
R	1	Set real-time processing bit for PFM requests at FET+1, bit 43 (refer to section 5).
UE	6	Set both user processing bit and error processing bit.
ER	3	Set both error processing bit and real-time processing bit.

If an erp other than those listed is specified, it must be a register or central memory location containing the value of erp (refer to SETFET Parameter Processing).

LFN=lfm	Changes the local file name in FET+0 to lfm.†
PFN=pfm	Changes the permanent file name in FET+10g to pfm for PFM requests.†
PKN=pm	Changes the pack name in FET+14g to pm for PFM requests.†
PWD=pwd	Changes the password in FET+12g to pwd for PFM requests.†
UCW=ucw	Changes the user control word in FET+13g to ucw for PFM requests (bit 59 of ucw must be set if this field is to be used on a CHANGE request).†
USN=un	Changes the alternate user name in FET+11g to un for PFM requests.†

† This option is left-justified with binary zero fill in an X register or central memory location as described in SETFET Parameter Processing.

SETFET PARAMETER PROCESSING

For the DTY, ERP (when mnemonics are not used), LFN, PFN, PKN, PWD, UCW, and USN parameters, the following rules apply.

- If an option is represented by a register, the register contains the value to be placed in the FET. For example:

```
SETFET F,(LFN=X4)
```

uses the contents of X4 as the new local file name.

- If an option is represented by a constant, the constant specifies the address containing the value to be placed in the FET. For example:

```
SETFET F,(LFN=LOFN)
```

uses the contents of location LOFN as the new local file name. The file name can be specified in a literal as follows:

```
SETFET F,(LFN=6LOUTPUT)
```

- If an option is a register that is preceded by the number sign (#),[†] the register specifies the address containing the value to be placed in the FET. For example:

```
SETFET F,#B3
```

uses B3 as the address containing the value to be placed in the FET.

- If an option is a register expression or constant preceded by the number sign, it specifies the address containing the address of the value to be placed in the FET. For example:

```
SETFET F,(LFN=#FADDR)
```

uses the contents of FADDR as the address containing the value to be placed in the FET.

For the BUF and ERA parameters, the following rules apply.

- If an option is represented by a register, the register contains the value to be placed in the FET. For example:

```
SETFET F,(ERA=A5)
```

uses the contents of A5 as the new error message return address.

- If an option is represented by a constant, the constant specifies the address value to be placed in the FET (not the address containing the value). For example:

```
SETFET F,(ERA=ERRBUF)
```

uses the address ERRBUF as the new error message return address.

[†]The equivalence sign (\equiv) in the CDC graphic character set (display code value 60_g).

SETFET EXAMPLES

Example 1:

The SETFET macro can be used to take advantage of the way in which FORTRAN passes parameters to subroutines. Assume a FORTRAN program calls a COMPASS subroutine GETF to retrieve a permanent file. The call accepts three parameters to select the local file name, permanent file name, and file password:

```
CALL GETF(lfn,pfn,pwd)
```

When FORTRAN processes the call, it builds a central memory table with one entry for each parameter, terminated by a zero word. The entry contains the actual address of the parameter. Before control is passed to the subroutine, FORTRAN sets the A1 register to the first word address of the table. Thus, X1 contains the address of the first parameter. If the call to GETF is:

```
CALL GETF(DATA1,BASE1,PWD1)
```

the A1 register is the first word address of the table of addresses, X1 contains the address of DATA1, location A1+1 contains the address of the next parameter, and so on. The following SETFET macro call uses the contents of the table to build an FET.

```
SETFET F,(LFN=#X1),(PFN=#A1+1),(PWD=#A1+2)
.
.
.
F      FILEB  BUF,301B(FET=16D)
BUF    BSS    301B
```

Example 2:

Similarly, a COMPASS program could place the values in the FET as follows:

```
SA1    DATA1
SB3    BASE1
SETFET F,(LFN=X1),(PFN=#B3),(PWD=PWD1)
.
.
.
DATA1  DATA  OLDATA1
BASE1  DATA  OLBASE1
PWD1   DATA  OLPWD1
F      FILEB  BUF,301B,(FET=16D)
BUF    BSS    301B
```

This section describes the process of performing input/output (I/O) from a COMPASS program.

This section is divided into two parts, combined input/output (CIO) and data transfer. The CIO part includes those macros needed for file creation, read and write functions, and file positioning. The data transfer part includes those macros that allow the user program to transfer information between the circular buffer and a working buffer area.

The user program can perform I/O directly through FETs using CIO or with CYBER Record Manager facilities that are available to COMPASS users through COMPASS macro calls. A brief description of CYBER Record Manager features is provided later in this section.

COMBINED INPUT/OUTPUT (CIO)

The CIO read/write requests are used to transfer data between a file and a CIO circular buffer. The read requests transfer input files from a system storage medium to a CIO circular buffer. The write requests transfer output from a CIO circular buffer to a system storage medium. Also included in this group of requests are those which open and close files, those which update records in an existing mass storage file, and those which control positioning of the file.

The format of the call to CIO is:

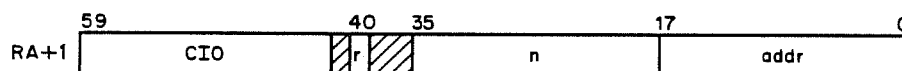

- r Auto recall option; if any value is specified for r, control is not returned to the user program until the operation is complete.
- n Count for skip operations.
- addr Address of the FET.

Word FET+0 contains the following information.



lfn Local file name.

ln Level number ($0 \leq \text{ln} \leq 178$) for an EOR/EOF operation on the file:

<u>Level Number</u>	<u>Description</u>
0	EOR operation.
1-168	Same as level 0.
178	EOF operation.

at Abnormal termination code returned by CIO:

<u>Code (Octal)</u>	<u>Description</u>
01	End of information encountered.
02	Device full/end of reel encountered.
04	Parity error.
21	End of multifile set.
22	Fatal error.
23	Random index too large for index buffer on OPEN.

code Request/return code:

<u>Bit(s)</u>	<u>Description</u>
8-2	Individual return code from a CIO function. Refer to the specific function for the bit settings and their meanings. Table 3-1 contains a summary of these codes.
1	File mode bit. Binary operation if set (applies only to SI, S, and L format tapes); coded operation if zero (applies only to S and L format tapes).

NOTE

Binary mode must be selected for SI format tapes or the job will abort.

0 Completion bit; indicates operation complete if set.

The file mode (fm) bit, bit 1 of FET+0, is not actually part of the status response, although it is returned as such. The fm bit is used by tape drivers, in some cases, to determine parity (seven-track) or whether conversion is required between character sets (nine-track). For disk I/O, the bit is carried for compatibility with tape I/O but is meaningless. The bit is set by the FILEB or FILEC macros or directly by the user program. After this it is retained as part of the return code.

The CPU program is expected to issue an even request code (bit 0=0). If it does not, a completed operation may not be detected.

CIO uses FET+5 and FET+6 in the following manner.

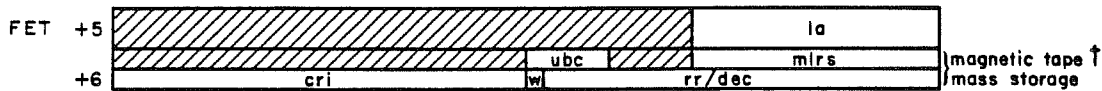

- la Address of a list of random addresses to be used with READLS or RPHRLS mass storage operations.
- ubc Unused bit count for S and L format tapes.
- mlrs Maximum PRU size for S and L format tapes.
- cri Current random index (for mass storage files only).
- w Random rewrite request (for mass storage files only).
- rr Random request (for mass storage files only): if rr≠0, and the request is a read request, rr is the random index.

If rr≠0, w=0, and the request is a write request, rr is the address for return of random index (the write operation begins at the current EOI). The index of the EOI prior to the write is returned to the calling program.

If rr≠0, w=1, and the request is a write request, rr is the random index indicating where the write will begin.

- dec Detail error return code (for mass storage files only).

<u>Code</u>	<u>Type of Error</u>
x001	Parity error.
x002	Address error.
x003	Device status error.
x004	6681 function reject or function set to mass storage device that timed out with no response.
x005	Device reserved.
x006	Device not ready.
4007	Track limit (device full).

†These fields apply only to S and L format tapes.

If, after a read error (with ep bit set), the system determines that the correct PRU was read (although it may contain incorrect data) then x above is set to 0, the data is placed in the buffer, and the file is positioned to the next PRU of the file. If the correct PRU is not read, then x is set to 4, no data is placed in the buffer, and the file is not repositioned. The cri is set as usual.

Equipment that may be accessed by CIO includes:

- Mass storage.
- Magnetic tape units.
- Terminals.

CIO FUNCTION PROCESSING

All of the CIO macros require the following two common decks for system interface.

- COMCCIO
- COMCSYS

These common decks are available to you in relocatable form on the user library SYSLIB.

If a CIO macro specifies a FET that currently does not have the completion bit (bit 0 of FET+0) set, common deck COMCCIO will wait (by performing recalls) for completion before performing the specified function.

Error processing for functions issued to CIO involves processing only those errors that occur on the specified devices which include read and write parity errors to magnetic tape. If a mass storage device returns an error status or the device driver detects an error, the system places the error status in the at (abnormal termination) field of FET+0. If the error processing bit is set in the FET+1 ep field and the FET length is greater than six, a detail error code is returned to the user program in the FET+6 dec field.

Table 3-1 lists the status response codes returned for the CIO functions, and shows which functions have the following properties:

- The system verifies the FIRST and LIMIT circular buffer parameters during the CIO operation.
- The system verifies the IN and OUT circular buffer parameters during the CIO operation.
- The system sets the IN and OUT circular buffer parameters to FIRST during the CIO operation (emptying the circular buffer).
- The function can only be performed on a file residing on a mass storage device.
- The function can only be performed on a file residing on a magnetic tape device.
- The function can be performed on a file residing on device type TT (assigned to an interactive terminal).

- The function can be performed on a file residing on device type NE.
- The data in the circular buffer of the file whose FET has the specified function will be printed at the terminal upon job step abort or job rollout if the file is included in a list of files in RA+2 or in a list specified in a SETLOF macro (refer to SETLOF macro description in section 6), and if the file is assigned to device type TT.
- The function can be performed on an execute-only file.

The status response codes shown in table 3-1 are returned the lower 18 bits of FET+0. Only those bits needed to distinguish the codes are shown; for example, 021 indicates xxx021 in bits 17 through 0 of FET+0, where xxx can have any value. The meanings of the status response codes are as follows:

<u>Meaning</u>	<u>Code(s)†</u>
EOR encountered	021
EOF encountered	740031,740271
EOI encountered	741031,741271
Rewind	051

†These codes are returned for a coded FET. The codes for a binary FET end in 3 instead of 1 (refer to the description of the code field of FET+0 at the beginning of this section).

Table 3-1. CIO Function Status Response Codes and Processing Options

CIO Function	Function Code	Status Response Codes†	Verify FIRST, LIMIT	Verify IN, OUT	Set IN=OUT=FIRST	Mass Storage Only	Magnetic Tape Only	Valid on Equip. Type TT	Valid on Equip. Type NE	Valid for Implicit Terminal Output	Can be Issued on Execute Only File
RPHR	000	021,740031,741031	X	X				X	X	X	
READ, READ-SKIP	010,020	021,740031,741031	X	X				X	X		
WRITE PRU	004		X	X				X	X	X	
WRITE, WRITE EOR, WRITE EOF	014,024,034		X	X				X	X	X	
BACKSPACE	040	051,740041						X	X		X
BACKSPACE PRU	044	051						X	X		X
REWIND	050		X		X			X	X		X
REWIND	054		X		X			X	X		X
UNLOAD	060							X	X		X
RETURN	070							X	X		X
OPEN/READ	100/300		X					X	X		
OPEN/WRITE	104		X					X	X	X	
POSITION MULTIFILE	110		X				X				
EVICT	114							X	X		X
OPEN ALTER	120		X					X	X	X	
CLOSE	130/330							X	X		
OPEN READ REWIND	140/340		X					X	X		
OPEN WRITE REWIND	144		X					X	X	X	
CLOSE REWIND	150/350		X					X	X		
OPEN ALTER REWIND	160		X					X	X	X	
CLOSE UNLOAD	170/370							X	X		
CLOSE/CLOSER RETURN	174/374							X	X		
READ CONTROL WORDS	200	740031,741031	X	X					X		
WRITE CONTROL WORDS	204		X	X					X		
READ WITH LIST	210	740031	X	X		X			X		
REWRITE, REWRITER, REWRITEF	214/224/234		X	X		X			X		
READ PRU WITH LIST	230	740031	X	X		X			X		
SKIP RECORD FORWARD	240	740271,741271, 261						X	X		X
OVERWRITE	244/254					X					
READ TO EOF	250	740031,741031	X	X				X	X		
READ CONTROL WORDS S/L TAPE	260	740271,741271	X	X			X				
WRITE CONTROL WORDS S/L TAPE	264		X	X			X				
READ TO EOI	600	741031	X	X				X	X		
SKIP RECORD BACKWARD	640	740051,740641						X	X		X

†These codes are returned for a coded FET; the codes for a binary FET end in 3 instead of 1 (refer to the description of the code field of FET+0 at the beginning of this section). The status codes for normal completion of a request are not shown. The status code for normal completion is identical to the function code, except that bit 0 of the field is set to indicate completion; for example, 261 is the status code for normal completion of function code 260.

ACCESSING FILES

The two methods used to access files assigned to a job are sequential and random access. Any file can be accessed sequentially; however, only mass storage files can be accessed randomly. When reading a file sequentially, the user program (or the system) reads all the information in the file from the current position to the end of the desired portion of the file.

When reading a file randomly, the user program (or the system) reads only the desired portion of the file. Any mass storage file can be read randomly if the relative position, from beginning-of-information (BOI), of the PRU to be read is known. The desired PRU can be read by placing the PRU number in the FET and making the proper I/O requests. The random address of a PRU is the number of PRUs that precede the PRU on the file. The first PRU that can be read or written is PRU 1. PRU 0 on all mass storage files is reserved for system use.

Several methods of random processing exist. The specific method depends on the language being used; however, the following rules apply in all cases.

- Most random I/O operations require a directory or index that contains the random disk addresses of records in the file.
- An EOR or EOF I/O operation transfers one PRU for the EOR or EOF.
- Random write operations must start within the current boundaries of the file. For example, it is not possible to randomly write PRU 20 of a file with a length of 10 PRUs. It is possible, however, to write 10 PRUs starting at PRU 10 and extend a file with a length of 10 PRUs to a length of 20 PRUs.
- When randomly rewriting data within a file, the user program must take steps to ensure that data following the area to be written is not destroyed.

Figure 3-1 illustrates a typical example of the structure of a random access file. Record 3 has random address 5. The first random address that can be read or written is address 1. The first PRU (for mass storage, a PRU is equivalent to a sector) on all mass storage files is reserved for system use.

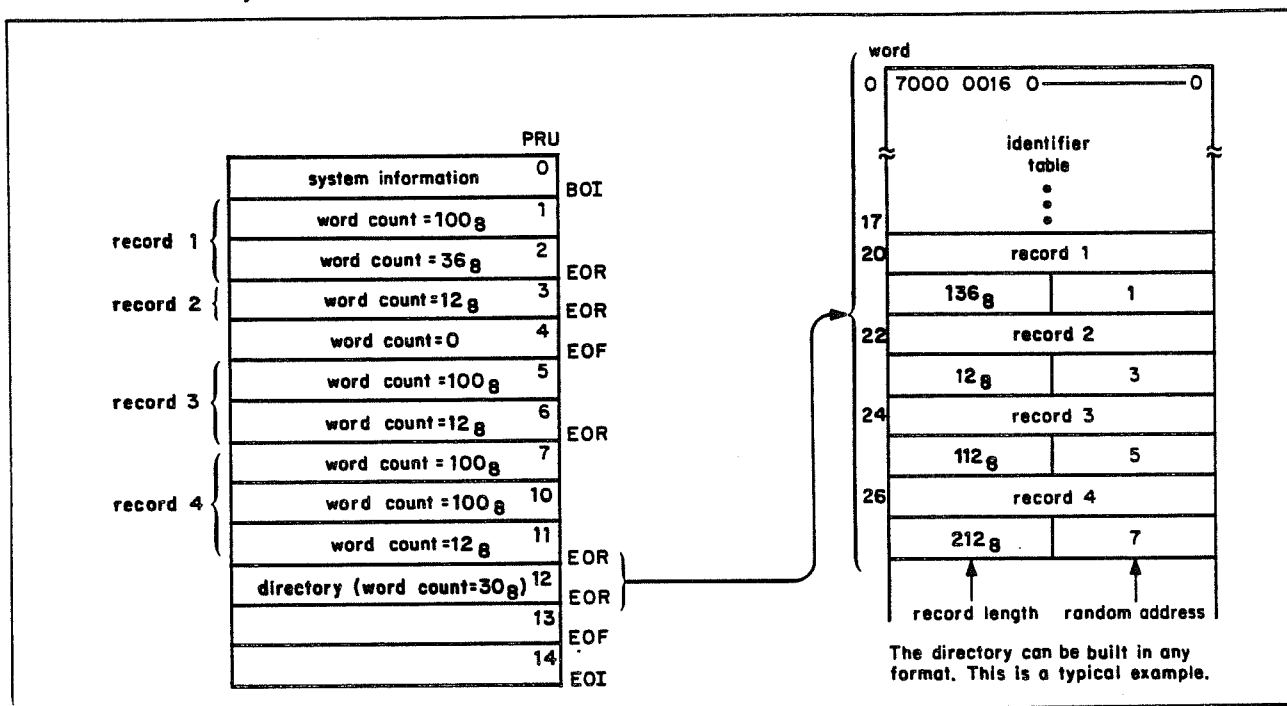

Figure 3-1. Sample Random Access File Format

READING FILES

To read record 3 sequentially, the user program rewinds the file to BOI, reads the file, and counts the number of EORs. CIO file positioning macros can be used to skip records 1 and 2; however, the primary consideration is that the data must be read to determine where record 3 begins. Once this is determined, record 3 can be read.

If a directory exists for this file, the only requirement is that the random address of record 3 be obtained from the directory and placed in the FET. The proper random read requests can then be issued. To perform this random read on record 3, the following steps are required.

- Skip to the EOI. This is done by the system without reading the entire file.
- Backspace two logical records (one record for the EOF and one for the directory). The system must read both records to perform this operation.
- Read the directory to obtain the random address to be placed in the FET.

NOTE

An EOF may or may not be present at the end of the file. The language and methods used to build the directory determine whether an EOF is present. If an EOF is not present, the directory can be read in automatically by specifying an index buffer on an OPEN request.

In summary, to access record 3 sequentially, four additional PRUs must be read. To access the record randomly, only three additional PRUs are read: two PRUs to position the file to the directory and one PRU to read the directory.

For additional random accesses to any record in the file, it is not necessary to access the directory again if it remains in central memory.

Each directory entry contains the record name, the first PRU of the record (random address), and the record length. The directory can be placed anywhere in the file. The only requirement for accessing a file randomly is that you must know where to position the file in order to read the directory. However, the directory usually precedes the EOF/EOI.

WRITING FILES

After reading and modifying record 3 of the sample file, the user program may rewrite the record in the file. If the modifications have not changed the number of PRUs required, a write operation can be used to replace the existing record with the modified record. This write operation must be issued as a random I/O operation. However, if the modifications have changed the number of PRUs required, data following the record being written is lost. For example, the size of record 3 in the sample file is 112g words or two PRUs. A maximum of 65g words can be added to the record without requiring an additional PRU and destroying data. If a random write request that adds 65g words to record 3 is issued, the file would have the following format.

record 3 {	word count=0	4	EOF
	word count=100g	5	
	word count=77g	6	EOR
	word count=100g	7	
	10		
	11		

This operation is called a rewrite in place. If the write had been issued as a nonrandom write operation, the file would have had the following format.

record 3 {	word count=0	4	EOF
	word count=100g	5	
	word count=77g	6	EOR
	7		EOI

All data following the inserted data would have been destroyed. If the word count for record 3 had been increased to 212g, a random rewrite could not have been performed without destroying PRU 7. The file would then have the following format.

record 3 {	word count=0	4	EOF
	word count=100g	5	
	word count=100g	6	EOR
	word count=12g	7	
	10		
	11		

To properly rewrite record 3 without destroying the contents of PRU 7, the user program could issue a write request at the end of the file and alter the directory to reflect the change. Figure 3-2 illustrates the updated file containing the new directory and the 212g-word modified record 3 written at the end of the file.

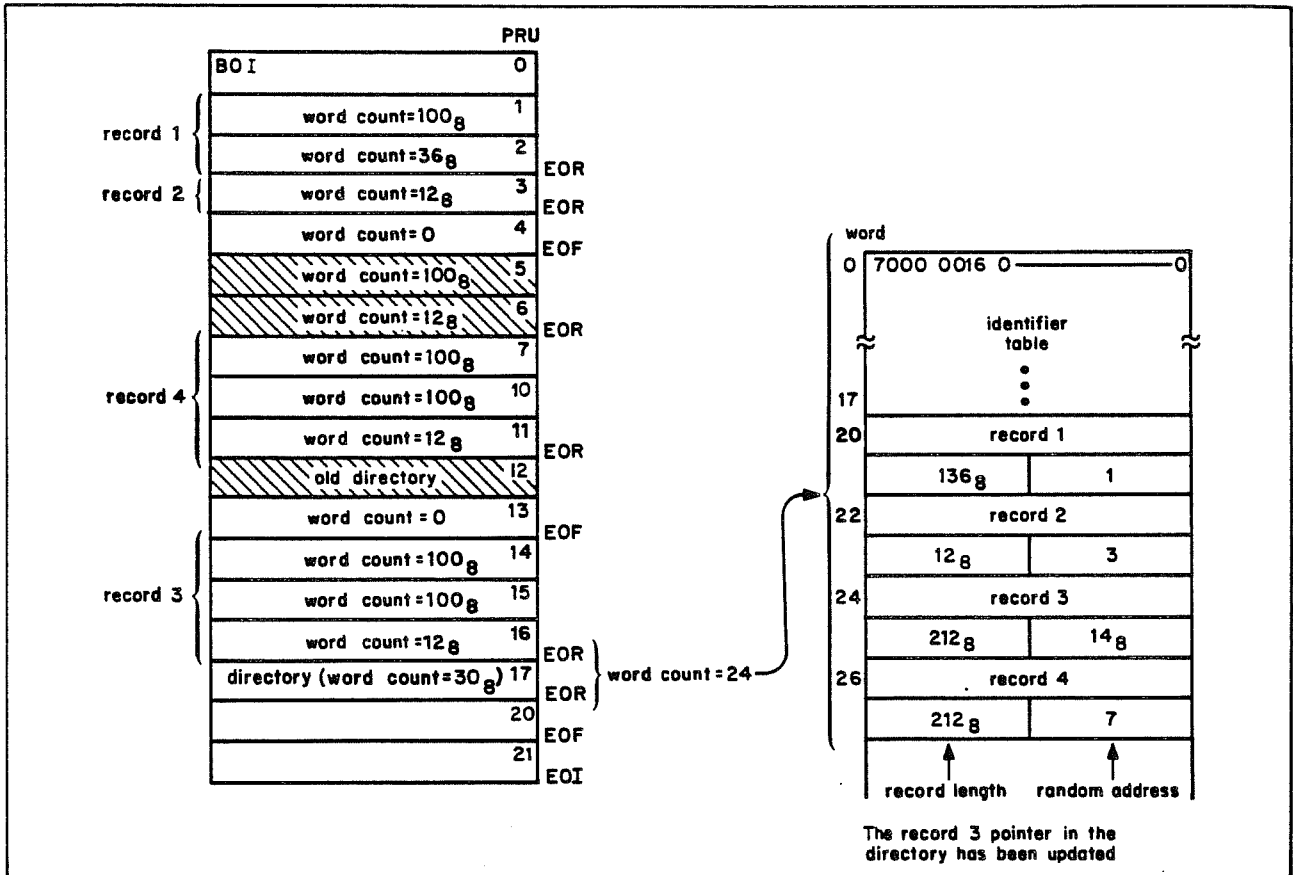

Figure 3-2. Modified Sample Random Access File Format

The shaded areas in the figure represent records that are still present in the file, but are not referenced in the new directory. These areas will not be accessed by programs that access this file randomly using the new directory.

RANDOM REQUEST PROCESSING

The user program can request that the system perform the specified read or write request at the file position specified by the random request word (FET+6). If the file specified resides on mass storage and the random processing bit is set (r parameter in FET+1), then random access to the file can be performed. For a random write operation, the remainder of the file (the portion following the data written) is not released. On a sequential write operation, this portion of the file is released.

The user program is responsible for managing the random addresses. For any CIO operation with r set in FET+1, the system returns the current random index (cri) in FET+6. The cri is the position of the file when the operation is completed.

Nonrandom write operations after a random write operation are processed as random requests. Writing continues at the current position and the remainder of the file is not released. This feature makes the recalculation of the random address unnecessary when randomly writing records larger than the CIO circular buffer size.

For a write operation with r set in FET+1, if rr=0, a sequential write is performed at the current position. If rr≠0, the action the system takes is as described for FET+6 fields earlier in this section.

For a REWRITE operation with r set in FET+1, if rr=0, a random write is performed at the current position. If rr≠0, a random write is performed at rr.

For the random file shown in figure 3-1, the following random requests (that is, r is set in FET+1) are necessary to perform the operations described. Figure 3-2 shows the modified random access file that results from performing these requests.

<u>Operation</u>	<u>rr</u>	<u>w</u>	<u>cri Returned</u>	<u>Description</u>
READ	12g	0	13g	Read directory.
WRITER	2000g	0	17g	Write new record 3 at EOI. System sets location 2000g to 14g to indicate where the write occurred.
WRITER or REWRITER	7	1	12g	Write new record 4 in place.
	7	0	12g	Word count = 212g.
WRITEF or REWRITEF	17g	1	21g	Rewrite directory.
	17g	0	21g	

The user program must account for the extra sector written for EORs and EOFs when specifying rewrite-in-place operations.

The system computes the number of sectors written as follows (all numbers are in octal):

<u>Operation</u>	<u>Formula</u>	<u>Word Count</u>	<u>Example</u>	<u>PRUs Written</u>	<u>Data Remaining in Buffer</u>
Buffer write	$n/100$	243	$243/100$	2	43
EOR write	$\frac{(n+100)}{100}$	243	$\frac{(243+100)}{100}$	3	0
		300	$\frac{(300+100)}{100}$	4	0
EOF write	$\frac{(n+200)}{100}$	243	$\frac{(243+200)}{100}$	4	0
		300	$\frac{(300+200)}{100}$	5	0

Appendix H contains examples of COMPASS programs that create, read, and write a random file.

CIO PROCESSING ON SECURED SYSTEMS

CIO performs the following additional processing on secured systems.

READING FILES

A read function (or an OPEN function that reads an index) performed on a file that has an access level higher than your job's current access level causes your job's access level to be raised to the access level of the file.

WRITING FILES

A write function (or a CLOSE function that writes an index) performed on a mass storage file with an access level lower than your job's current access level causes the file's access level to be raised to the access level of the job. Such a request on a tape file or an attached direct access file constitutes a security conflict and is rejected (unless you have special authorizations) since the access levels of these files cannot be changed while the files are attached to a job.

CREATING FILES

If CIO creates a local file as the result of a WRITE or OPEN request, the file is normally created with the same access level as the job's current access level. If the access level bit (bit 39) of FET+1 is set, however, the file is created with the access level specified in FET+4, provided that access level is valid for the job. Specifying an access level lower than the current access level of your job constitutes a security conflict, unless you have special permission.

STATUS RETURNED BY CIO

If the access level bit (bit 39) in FET+1 is set, CIO returns the current access level of the file to the access level field in FET+4 after each CIO request.

CIO OPEN AND CLOSE FUNCTIONS

Two macros are available for opening files.

- OPEN is applicable to all files.
- POSMF is applicable only to labeled multifile tapes.

Two macros are available for closing files.

- CLOSE is applicable to all files.
- CLOSER is applicable only to tape files.

POSMF is described in the discussion of file positioning functions. OPEN, CLOSE, and CLOSER are described in the following paragraphs.

In general, there is no need to explicitly open or close mass storage files. The capabilities provided by open and close functions for mass storage files can be obtained through the use of other system macros. For example, appendix H illustrates the random processing of a file without using CIO open and close functions. Also, the example in this section of data transfer macros shows how a sequential mass storage file can be read and written without using open and close functions.

OPEN

OPEN creates a file or determines certain information about a file for a job. If the file does not exist before the request to OPEN, it is created.

On a secured system, performing an OPEN function on a file with an index has the same effect on the job access level as a READ; that is, if the access level of the file is higher than the current access level of the job, the job's access level is raised to the access level of the file.

Macro format:

<u>Location</u>	<u>Operation</u>	<u>Variable</u>
	OPEN	addr,type,r
addr	Address of the FET for the OPEN request.	
type	Type of function to be performed:	
	<u>Type</u>	<u>Function (With Code in Octal)</u>
	READNR	Read, no rewind (100).
	READ	Read and rewind (140).
	WRITENR	Write, no rewind (104).
	WRITE	Write and rewind (144).
	NR	No rewind (120).
	ALTERNR	Alter, no rewind (120).
	ALTER	Alter and rewind (160).
	REELNR	Read reel, no rewind (300).
	REEL	Read reel and rewind (340).

If the user program specifies a function type of REEL (or REELNR) and the file resides on mass storage, CIO assumes the type is READ (or READNR). If the type is not specified, ALTER is assumed. The functions listed do not change the system read/write lock on the file.

For mass storage files, all rewind functions are identical as are all no-rewind functions. That is, the only effect function type has on a mass storage file is to specify whether the file is to be rewound after it is opened (READ, WRITE, ALTER, or REEL), or whether it is to remain at its current position (READNR, WRITENR, NR, ALTERNR, or REELNR).

For magnetic tape files, READ, REEL, and ALTER perform identical functions and can be used interchangeably, as can READNR, REELNR, and ALTERNR.

r Auto recall option; if any value is specified for r, control is not returned to the user program until the operation is complete.

The information supplied by OPEN includes:

- The PRU size for the device to which the file is assigned (FET+4, bits 35 through 18). The PRU size returned for a magnetic tape file depends on the tape data format (refer to appendix J).
- The type of device on which the file resides (FET+1, bits 59 through 48). Refer to appendix E for a list of supported device types. In addition, bit 59 is set if the device is a nonallocatable nonmass storage device.

The operations performed by OPEN depend on the type of device being used.

Mass Storage Operations

For mass storage files, if random processing is specified and proper pointers are set in FET+7, the last record of the file is loaded into the buffer specified. The random index on a file that is to be opened is expected to be the last record before the EOI. No EOFs may intervene. No indication of the length of the index loaded is returned other than a zero word in the buffer (OPEN clears the buffer before loading the index). If the buffer is too small to accommodate the entire index, an abnormal termination code of 23g is entered in FET+0, and the job step aborts unless the ep bit was set in FET+1. The random access bit (FET+1, bit 47) is cleared during an OPEN operation if:

- The last record before the EOI is empty.
- If the index length (FET+7, bits 18 through 35) is not zero and the index area FWA (FET+7, bits 0 through 17) is less than two or greater than the job field length, the job step aborts.
- The file does not reside on mass storage.

For all OPEN functions on mass storage, the index for a file is loaded into the index area specified.

Example:

The following example opens a random access mass storage file and reads the directory in preparation for random processing.

```
      .  
      .  
      .  
BUFL      EQU      2001B  
INDXL     EQU      100B  
FILE1     RFILEB  BUF,BUFL,(FET=8),(IND=INDX,INDXL)  
BUF       BSS      BUFL  
INDX      BSS      INDXL  
      .  
      .  
      .  
      OPEN  FILE1,,R  
      .  
      .  
      .
```

Unlabeled Tape Processing

If a no rewind option is specified (code 100, 104, 120, or 300), the tape remains at its current position. If a rewind option is specified (code 140, 144, 160, or 340), the tape is rewound to the load point of the current volume.

Nonstandard Labeled Tape Processing

Since the system cannot write nonstandard labels, the job step aborts if a WRITE (144) or WRITENR (104) function is specified for a file residing on a tape with nonstandard labels.

If a no rewind option is specified (code 100, 120, or 300), the tape remains at its current position. If a rewind option is selected (code 140, 160, or 340), the tape is rewound to the load point of the current volume.

Nonstandard labels are not read or returned to the CIO buffer. If the tape is at the load point, a subsequent read operation skips to the first tape mark before the read occurs.

Standard ANSI Labeled Tape Processing

When an ANSI labeled tape file is opened, the action the system takes depends on the xl bit (FET+1, bit 41). If xl is 0, standard label processing is performed; extended label processing is performed if xl is 1.

For standard label processing, all optional labels are ignored. If the FET for the file is at least 15g words long, FET+11g through FET+14g (refer to FET Description in section 2) contain the HDR1 data. The actual format of the HDR1 label is shown in appendix J. The HDR1 fields are described in detail in Volume 3, System Commands. All fields contain alphanumeric or numeric display code values. Alphanumeric fields are left-justified with blank fill. Numeric fields contain display code numeric digits and are right-justified with display code zero fill.

The tape remains at its current position if a no rewind option is specified (code 100, 104, 120, or 300). If a rewind option is selected (code 140, 144, 160, or 340), the tape is rewound to the load point of the current volume.

The system reads and/or verifies the HDR1 label if the tape is at the load point and a READ, REEL, or ALTER option is selected (code 100, 120, 140, 160, 300, or 340), with the following restrictions or requirements.

- If the FET length is less than 15g words, the system accepts a standard label without verification.
- If the FET length is at least 15g words, the HDR1 data in FET+11g through FET+14g is compared with that in the HDR1 label. Binary zero fields are not compared, although the actual value read is returned to the field. If any nonzero field does not match, the job step aborts.
 - A nonzero retention cycle (FET+13g, bits 47 through 30) is used to calculate an expiration date that is compared with that HDR1 field on the tape.
 - The HDR1 label is transferred to the CIO buffer (as space permits), although IN and OUT pointers are not updated to reflect the label information in the buffer.
- All optional labels are ignored.

The system writes a new HDR1 label if the tape at load point is opened for the first time with a WRITE operation specified (codes 104 or 144), and the FET length is at least 15g words. Subsequent OPEN/WRITE operations (following an OPEN/READ or OPEN/WRITE) do not update the label information, even if the file is opened, closed, and then reopened. The following restrictions or requirements apply.

- If the FET is less than 15g words in length, the previous HDR1 label information is not changed.
- If the FET length is at least 15g words, the system uses the information in FET+11g through FET+14g for the HDR1 label. If any of the FET HDR1 fields are binary zero, the system uses the default value. The current date is used instead of the create date field in the FET. A nonzero retention cycle field is used to calculate the expiration date (default is current date).
- If a nonnumeric value is encountered in a numeric field, the job step aborts.
- Previous HDR1 label expiration date is enforced; if the label date has not expired, the job step aborts.

Example:

The following example opens a magnetic tape file for standard label processing and verifies the HDR1 label against values preset by the user program (the FET parameters are described in section 2). The magnetic tape file must have previously been assigned via a LABEL command or macro.

```

      .
      .
BUFL   EQU   3001B
FET    BSS   0
TAPE1  FILEB BUF,BUFL,LBL
      ORG   FET+11B
FET11  VFD   60/OHACCOUNT FI
FET12  VFD   42/OHLE,18/OH001
FET13  VFD   12/OH01,18/OH003,30/OH79023
FET14  VFD   36/OHSETID1,24/OH0001
      ORG   *
BUF    BSS   BUFL
      .
      .
OPEN   FET,REEL,R
      .
      .

```

In the preceding example, FET+11g through FET+14g contain the HDR1 data. The tape is rewound to the load point of the current volume and the HDR1 data in the FET is compared with the HDR1 label on the tape. If any field does not match, the job step aborts; otherwise, the HDR1 label is transferred to the buffer BUF where the user can further process it (refer to appendix J for the format of the HDR1 label).

If the OPEN macro in the preceding example is changed to

```
OPEN      FET,WRITE,R
```

and the file is being opened for the first time, then the system uses the data in FET+11g through FET+14g to write a new HDR1 label on the tape.

Extended Label Processing

For extended label processing, a user label buffer, rather than the FET, is used to hold labels for processing. Extended label processing requires an FET length of at least 12g words, and an extended label buffer. Extended label processing is disabled if these requirements are not met.

The buffer location must be specified in FET+11g as follows:

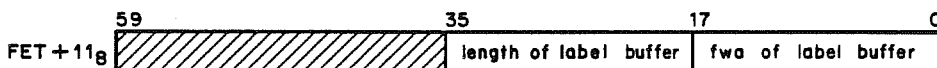

Within the buffer, each label must be preceded by a status word.



Only bits 11 through 0 should be set by the user program to show the number of characters in the label. This value must be 80 (120g), or the job step aborts.

Remaining fields may be used by the label processor. The last label should be followed by a status word containing zeros in bits 11 through 0. Each label in the buffer appears, in display code, with the same format it has on the tape.

The tape remains at its current position if a no rewind operation is specified (code 100, 104, 120, or 300). If a rewind operation is selected (code 140, 144, 160, or 340), the tape is rewound to the load point of the current volume.

If the tape is at the load point and READ, REEL, or ALTER is selected (code 100, 120, 140, 160, 300, or 340), the system reads all labels to the first tape mark and verifies the HDR1 label, with the following exceptions.

- If the label buffer does not contain an HDR1 label, the system accepts the standard label without verification.
- If the label buffer contains an HDR1 label, any nonzero field in the label buffer is compared with that HDR1 field on the tape. If any nonzero field does not match, the job step aborts.
- All labels from VOL1 through the first tape mark are transferred to the label buffer as space permits. Verification of additional labels is your responsibility.

The system writes a new HDR1 label if the tape at load point is opened for the first time with a WRITE operation specified (code 104 or 144). If the file has been opened prior to the OPEN/WRITE, the label information is not updated even if the file is opened, closed, and reopened. Further requirements and restrictions are as follows:

- VOL1 labels in the label buffer are ignored.
- If an HDR1 label is not present in the label buffer, the system uses default values to create the HDR1 label for the tape.
- If an HDR1 label is present in the label buffer, it is used to generate the HDR1 label on the tape. If any field in the label buffer is binary zero, the default value for that field is used. The current date is used instead of the create date in the buffer. The expiration date field is used; if zero, it defaults to the current date.
- If a numeric field in the HDR1 label contains a nonnumeric value, the job step aborts.
- Previous HDR1 label expiration date is enforced; if the label has not expired, the job step aborts.
- All user labels to be written must be present in the label buffer. All user volume labels (UVL1 through UVL9), additional file header labels (HDR2 through HDR9), and user header labels (UHL) in the label buffer are written to the tape. Nonapplicable labels are ignored.

Example:

The following example opens a magnetic tape file for extended label processing and verifies the HDR1 label on the tape against values preset by the user program in the label buffer (refer to appendix J for the format of the HDR1 label).

```
      .      .
      .      .
BUFL   EQU   3001B
FET     BSS   0
TAPE1  FILEB BUF,BUFL,LBL,XL
BUF     BSS   BUFL
LBUF    VFD   48/,12/80
        VFD   24/4HHDR1,36/6HACCOUN
        VFD   60/10HT FILE
        VFD   6/1H,36/6HSETID1,18/3H000
        VFD   6/1H1,24/4H0001,24/4H0001,6/1H0
        VFD   6/1H1,36/6H 79023,18/3H 79
        VFD   18/3H023,6/1H ,36/0
        BSSZ   3
FET11B  VFD   24/,18/10D,18/LBUF
      .
      .
      SA1   FET11B           SET UP FET+11B
      BX6   X1
      SA6   FET+11B
      .
      .
      OPEN  FET,READ,R
      .
      .
```

If the OPEN macro in the preceding example is changed to

```
OPEN      FET,WRITE,R
```

and the file is being opened for the first time, the system uses the data in the label buffer to generate the HDR1 label on the tape, provided all requirements and restrictions are met.

CLOSE

CLOSE terminates operations on a file.

Macro format:

<u>Location</u>	<u>Operation</u>	<u>Variable</u>
	CLOSE	addr,type,r

addr Address of the FET for the CLOSE request.

type Type of function to be performed:

<u>Type</u>	<u>Function (with Code in Octal)</u>
NR	File is not rewound (130).
REWIND	File is rewound (150).
UNLOAD	Tape file is rewound, released, and unloaded; mass storage file is released (170); it does not affect the user program's resource demand count (refer to UNLOAD macro).
RETURN	Tape file is rewound and released; mass storage file is released (174); the number of tapes or packs scheduled for the job may be decreased (refer to RETURN macro).

If type is not specified, REWIND is assumed.

r Auto recall option; if any value is specified for r, control is not returned to the user program until the operation is complete.

If the file resides on mass storage, the random processing bit is set, and the proper parameters are set in FET+7, CLOSE writes the data in the buffer specified in FET+7 at EOI of the file. This normally is the index for the file. A random index is written at the EOI only if the FET indicates that the file is random, the file's EOI position has changed since the last OPEN request, the file is not locked, and an index area is specified in bits 17 through 0 of FET+7.

On a secured system, performing a CLOSE function on a file with an index has the same effect on the file's access level as a WRITE; that is, if the access level of the file is lower than the current access level of the job, the file's access level is raised to the access level of the job.

Example:

Random processing for the program shown in the first example of the OPEN macro can be terminated as follows:

```
      .      .
      .      .
BUFL   EQU   2001B
INDXL  EQU   100B
FILE1  RFILEB BUF,BUFL,(FET=10B),(IND=INDX,INDXL)
BUF    BSS   BUFL
INDX   BSS   INDXL
      .
      .
      OPEN  FILE1,,R
      .
      .
      CLOSE FILE1,,R
      .
      .
```

In this example, the system writes the random index contained in the index buffer at the end of the file.

NOTE

CLOSE/UNLOAD and CLOSE/RETURN can no longer be used to queue files (these functions release the file from the job in the same manner as UNLOAD and RETURN, respectively). Programs using these functions should be rewritten to use the ROUTE macro if file queueing is desired.

When a magnetic tape file is closed, the action the system takes depends on the last I/O operation performed.

The system responds to a CLOSE request on a magnetic tape file in the following manner.

1. If the last operation was a write, the system performs one of the following functions.
 - If the tape is unlabeled and the data format is S, L, or F, the system writes four tape marks.
 - If the tape is unlabeled and the data format is I or SI, the system writes a tape mark, an EOF1 label, and three tape marks.
 - If the tape is labeled and standard label processing is in effect (xl, bit 41 of FET+1, not set), the system writes a tape mark, an EOF1 label, and three tape marks.

- If the tape is labeled and extended label processing is in effect (xl, bit 41 of FET+1, set), the system writes a tape mark, an EOF1 label, all user end-of-file labels (EOF2 through EOF9) and user trailer labels (UTL) present in the extended label buffer, and two tape marks. All nonapplicable labels, including EOF1 and EOF1 labels, in the extended label buffer are ignored. Refer to Extended Label Processing earlier in this section for a description of the label buffer.

If the last operation was a read and the following are true, then all labels from this tape mark (beginning with EOF1) through the next tape mark are transferred to the extended label buffer, as space permits, beginning at the first word of the buffer.

- The tape is labeled.
 - Extended label processing is in effect (xl, bit 41 of FET+1, is set).
 - A tape mark immediately follows.
2. If the no rewind (NR) option was selected, the tape remains positioned at or is repositioned to the same point as before the CLOSE was issued (to prevent the user program from going past EOI).

If the rewind (REWIND) option was selected, the system rewinds the tape to the beginning of data of the current file. This operation is performed automatically even if the current file begins on another reel.

If the unload (UNLOAD) option was selected, the system rewinds and unloads the current tape reel, releasing job and file attachment.

NOTE

If PO=U processing option was specified at tape assignment time, the tape will not be physically unloaded from the tape drive.

If the return (RETURN) option was selected, the system rewinds and unloads the current tape reel, releasing job and file attachment. The number of tapes scheduled for the job is decremented only if the total concurrent resource demand (tapes and packs)† has been satisfied.

†Refer to the RESOURC command in Volume 3, System Commands.

CLOSER

The CLOSER macro closes a magnetic tape reel.

Macro format:

<u>Location</u>	<u>Operation</u>	<u>Variable</u>
	CLOSER	addr,type,r
addr	Address of the FET.	
type	Type of operation to be performed:	
	<u>Type</u>	<u>Function (with Code in Octal)</u>
	NR	No rewind (330).
	UNLOAD	Unload (370).
	RETURN	Return (374).
	omitted	Rewind (350).

If the specified file resides on mass storage, function 350 sets the file to BOI and function 370 releases the file.

r Auto recall option; if any value is specified for r, control is not returned to the user program until the operation is complete.

When a read or write operation encounters end-of-reel, control is returned to the user program if the user processing (up) option is set in the FET. The tape is positioned so that if the user program attempts another I/O operation, the result is the same as for the previous read or write.

The CLOSER macro enables the user program to initiate end-of-reel processing. The definition of end-of-reel varies according to the processing option the user selects (refer to End-of-Tape/End-of-Reel Conditions, appendix J). The action the system takes in response to a CLOSER request depends on the following two factors:

- The last I/O operation performed.
- The user processing option (FET+1, bit 45).

The system performs the following sequence of actions during end-of-reel processing:

1. If the last operation was a write, the system performs one of the following operations.
 - If the tape is labeled, unlabeled SI, or unlabeled I format, the system writes a tape mark followed by an EOVI label and three tape marks. If the user program has specified the VSN of the next reel (refer to Volume 3, System Commands, for a description of the VSN command), an EOVI label containing that value is also written following the EOVI. User trailer labels present in the label buffer are written if extended label processing is in effect. Refer to Extended Label Processing earlier in this section for a description of the label buffer.
 - If the tape is unlabeled and the data format is S, L, or F (refer to appendix J), the system writes four tape marks.

If the last operation was a read, the system performs the following steps.

- a. If extended label processing is in effect, all labels following from EOVI to the next tape mark are returned to the extended label buffer.
 - b. If the tape has an EOVI label (except for SI unlabeled tapes) and was written under NOS, the system extracts the VSN and proceeds to step 2.
 - c. If the user has specified the VSN of the next reel, the system proceeds to step 2.
 - d. If the VSN of the next reel has not been specified and the tape has no EOVI label, the system proceeds to step 2.
2. If the user processing option was selected, the system returns control to the user with end-of-reel status set in the FET. The user processing option does not apply to the RETURN (374) function.

If the user processing option was not selected, the system returns control to the user program by setting the completion bit in the FET. In addition, if the tape is labeled and the FET length is at least 158 words, the system increments the file section number (FET+148, bits 23 through 0).

3. The system rewinds or unloads the tape as specified by the type parameter. The current reel is always unloaded if the next reel is not known or mounted.
4. The system takes the following action if the file is continued on a subsequent reel.
 - If the VSN of the next reel is known and the reel is mounted, the I/O operation continues. If the VSN is not known or the reel is not mounted, the system requests the operator to mount it (the tape must be mounted on the same drive). Any labeled tape is accepted if the next VSN is not specified.
 - If the operation is a RETURN (374), a subsequent reel is not requested. The file is returned after the EOVI label sequence is written.

CIO READ FUNCTIONS

CIO processes the following read functions.

NOTE

On a secured system, performing a read function on a file that has a higher access level than your job's current access level causes your job's access level to be raised to the access level of the file.

RPHR (000)

RPHR causes one PRU to be transferred into the circular buffer.

The status responses (bits 17 through 0 of FET+0) are:

000001†	Full sector.
000021†	EOR encountered.
740031†	EOF encountered.
741031†	EOI encountered.

Macro format:

<u>Location</u>	<u>Operation</u>	<u>Variable</u>
	RPHR	addr,r
addr	Address of the FET.	
r	Auto recall option; if r is specified, control is not returned to the user program until the operation is complete.	

READ (010)

The READ function reads information into the circular buffer. If there is room in the buffer for at least one full physical record, the system initiates reading and continues until:

- The available circular buffer space will not accommodate one full PRU.
- An end-of-record or end-of-file is encountered.
- The end-of-information is encountered.
- For S and L format tapes, one PRU is read.

The status responses (bits 17 through 0 of FET+0) are:

000011†	Buffer filled.
000021†	EOR encountered.
740031†	EOF encountered.
741031†	EOI encountered.

†This status response is returned for a coded FET. The status response for a binary FET ends in 3 instead of 1 (refer to the description of the code field of FET+0 at the beginning of this section.)

Data is not transferred after an EOR or EOF mark is encountered. For tapes that do not have a defined EOI (refer to appendix J), an operation that normally would terminate at EOI terminates instead at EOF. Also, for S and L format tapes, the unused bit count is returned to FET+6, bits 29 through 24, when the read is complete.

Macro format:

<u>Location</u>	<u>Operation</u>	<u>Variable</u>
	READ	addr,r
addr	Address of the FET.	
r	Auto recall option; if any value is specified by r, control is not returned to the user program until the operation is complete.	

READSKP (020)

READSKP performs a read function until the buffer is filled or until an EOR or EOF is encountered. If the buffer is filled before an EOR is encountered, CIO positions the file at the next EOR, EOF, or EOI, whichever is encountered first.

The status responses (bits 17 through 0 of FET+0) are:

000021†	Buffer filled or EOR encountered (file is positioned at beginning of next record).
740031†	EOF encountered.
741031†	EOI encountered.

For tapes that do not have a defined EOI (refer to appendix J), an operation that normally terminates at EOI terminates instead at EOF.

This is the only read function that performs the read operation if less than one PRU of space is available in the buffer.

†This status response is returned for a coded FET. The status response for a binary FET ends in 3 instead of 1 (refer to the description of the code field of FET+0 at the beginning of this section.)

Macro format:

<u>Location</u>	<u>Operation</u>	<u>Variable</u>
	READSKP	addr,level,r
addr	Address of the FET.	
level	Level number (0 through 178) specified in FET+0, bits 17 through 14; if a level number is specified, information is skipped until the occurrence of an EOR with a level number greater than or equal to the one specified:	
	0-16g	After the buffer is full, skip to the next EOR.
	178	After the buffer is full or a full record is placed in the buffer, skip to the next EOF.
	For S and L format tapes, only a request with level 178 is recognized; any other level in the request is ignored.	
r	Auto recall option; if any value is specified by r, control is not returned to the user program until the operation is complete.	

For S and L format tapes, the user program should set the mlrs field (FET+6, bits 17 through 0) before issuing the READSKP function. If mlrs is 0, the system assumes 512 words for an S tape and 3777778 for an L tape. Thus, if a READSKP is issued on an L tape and mlrs is 0, a block too large error occurs if a block is encountered that is larger than 3777778 CM words.

READCW (200)

Macro format:

<u>Location</u>	<u>Operation</u>	<u>Variable</u>
	READCW	addr,level,r
addr	Address of the FET.	
level	Termination level:	
	0-16g	Continue reading over EOFs (stops at EOI or buffer full). EOFs are returned in data as zero length blocks with level 178.
	178	Stop reading at next EOF. EOF status is returned to the FET, but no EOF data block (zero length and level 178) is returned to the CIO buffer.
r	Auto recall option; if any value is specified for r, control is not returned to the user program until the operation is complete.	

The READCW function performs a nonstop read of PRUs bounded by control words. The PRU format is:

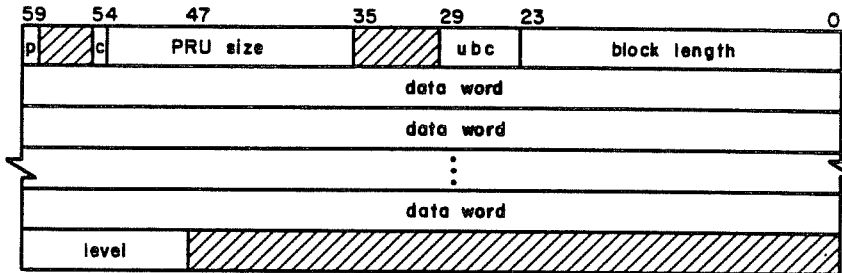

- p Parity error indication (is set for each block in error when reading with the ep bit set in the FET).
- c Bit 54 is set if coded operation (tape operations only).
- PRU size Number of CM words in each PRU on the device (refer to appendix J for a description of PRU sizes).
- ubc Unused bit count ($0 < \text{ubc} < 11$). Ignored for mass storage files. For I and SI format tapes, ubc must be 0. For F, S, and L format tape read and write operations, ubc is processed as accurately as possible within the constraints of the hardware.
- block length Count of the number of 12-bit data bytes in the PRU. For mass storage files and I and SI format tapes, it must be equal to five times the number of CM words occupied by the data.
- level Logical record level number:
 - 0-16g The PRU is an EOR.
 - 17g The PRU is an EOF.

This function allows the user program to read nonstop and detect EORs and EOFs without having to recall CIO for the next sequential read. Reading terminates normally if the buffer becomes full or if the EOI is detected. If the request is made with the level number equal to 17g (that is, FET+0, bits 17 through 14), reading stops at the next EOF.

This function may only be used with mass storage and magnetic tape devices.

READLS (210)

The READLS function reads the group of mass storage logical records specified in a list supplied by the user program. The user program must supply the address of the list in the lower 18 bits of FET+5. READLS continues reading until the list is exhausted or the buffer is filled.

Macro format:

<u>Location</u>	<u>Operation</u>	<u>Variable</u>
	READLS	addr,r

addr Address of the FET.

r Auto recall option; if any value is specified by r, control is not returned to the user program until the operation is complete.

FET+5 contains the address of the list in the following format.



r Set by CIO if this is not the initial READLS call.

la Address of the list.

The list is in the following format.

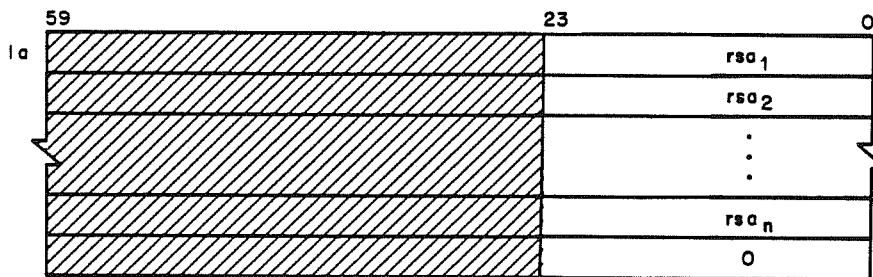

rsa_i Random sector address.

The status responses (bits 17 through 0 of FET+0) are:

740031†	Operation complete. Entire list read. The value of la in FET+5 is set to terminator word.
000211†	Operation not complete. la in FET+5 contains the address of the next entry of the list to be processed. If the buffer is full, r is set to 1. If the buffer is not full, CIO has reached an internal limit and has stopped processing the list. After emptying the buffer, the user program should call CIO again to continue processing the list.

RPHRLS (230)

The RPHRLS function reads the group of mass storage PRUs specified by a list supplied by the user program. This function performs the same operation as READLS except that each address in the list specifies a single PRU instead of a record. After the single PRU specified by each list entry is placed in the buffer, the list position is advanced.

Macro format:

<u>Location</u>	<u>Operation</u>	<u>Variable</u>
	RPHRLS	addr,r

addr Address of the FET.

r Auto recall option; if any value is specified for r, control is not returned to the user program until the operation is complete.

†This status response is returned for a coded FET. The status response for a binary FET ends in 3 instead of 1 (refer to the description of the code field of FET+0 at the beginning of this section.)

READNS (250)

The READNS function reads a file from the current position to an EOF.

The status responses (bits 17 through 0 of FET+0) are:

000251†	Buffer full.
740031†	EOF encountered.
741031†	EOI encountered.

Macro format:

<u>Location</u>	<u>Operation</u>	<u>Variable</u>
	READNS	addr,r
addr	Address of the FET.	
r	Auto recall option; if any value is specified for r, control is not returned to the user program until the operation is complete.	

†This status response is returned for a coded FET. The status response for a binary FET ends in 3 instead of 1 (refer to the description of the code field of FET+0 at the beginning of this section.)

READN (260)

The READN function reads data from an S or L format tape into the circular buffer. Reading continues until one of the following occurs:

- The buffer is full.
- An EOF is encountered.
- The EOI is encountered.

Status responses (bits 17 through 0 of FET+0) are:

000261† Buffer full.
740271† EOF encountered.
741271† EOI encountered.

Macro format:

<u>Location</u>	<u>Operation</u>	<u>Variable</u>
	READN	addr,r

addr Address of the FET.

r Auto recall option; if any value is specified for r, control is not returned to the user program until the operation is complete.

Before this function is issued, the mlrs field in FET+6, bits 17 through 0 must be set to the largest physical record that will be encountered. For S format, if mlrs is 0, the value of the maximum block is assumed to be 512 words. For L format, if mlrs is 0, the assumed maximum block is (LIMIT-FIRST-2). In addition, the file mode bit (FET+0, bit 1) must be set.

Each physical record in the circular buffer is preceded by a header word. This word is generated by the system; it does not exist on the tape. The format of the header word is:

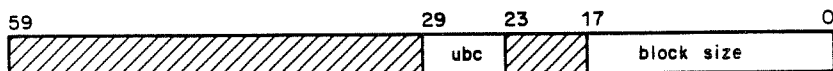

ubc Unused bit count. Number of bits in the last word that are not valid data; ubc may range from 0 to 55.

block size Number of CM words in the physical record.

After each complete physical record has been placed in the buffer, the system moves the IN pointer to reflect both the header and the data.

†This status response is returned for a coded FET. The status response for a binary FET ends in 3 instead of 1 (refer to the description of the code field of FET+0 at the beginning of this section.)

READEI (600)

The READEI function reads information into the circular buffer. Reading continues until an EOI mark is encountered or the buffer is filled. Status responses (bits 17 through 0 of FET+0) are:

000601† Buffer full.
741031† EOI encountered.

Macro format:

<u>Location</u>	<u>Operation</u>	<u>Variable</u>
	READEI	addr,r
addr	Address of the FET.	
r	Auto recall option; if any value is specified for r, control is not returned to the user program until the operation is complete.	

CIO WRITE FUNCTIONS

CIO processes the following write functions.

NOTE

On a secured system, performing a write function on a mass storage file with an access level lower than your job's current access level causes the file's access level to be raised to the level of the job. Such a request to a tape or an attached direct access file is rejected as a security conflict (unless you have special authorizations), since the access levels of these files cannot be changed while the files are attached to a job.

† This status response is returned for a coded FET. The status response for a binary FET ends in 3 instead of 1 (refer to the description of the code field of FET+0 at the beginning of this section.)

WPHR (004)

WPHR writes one physical record from the circular buffer. If the buffer contains less than one full PRU, no operation occurs.

Macro format:

<u>Location</u>	<u>Operation</u>	<u>Variable</u>
	WPHR	addr,r
addr	Address of the FET.	
r	Auto recall option; if any value is specified for r, control is not returned to the user program until the operation is complete.	

WRITE (014)

WRITE transfers the contents of the circular buffer to the specified file. Writing continues until the buffer contains less than one full PRU of data (a WRITER request empties the buffer and writes an end-of-record on the file).

Macro format:

<u>Location</u>	<u>Operation</u>	<u>Variable</u>
	WRITE	addr,r
addr	Address of the FET.	
r	Auto recall option:	
	*	The * option sets the WRITE function code (CIO function code 014g) in FET+0 and returns to the calling program. The WRITE function is not performed at this time.
		For further information concerning use of the * option, refer to WRITECW (204) later in this section.
	other	Control is not returned to the user program until the operation is complete.

For S and L format tapes, only one record is written for each request. The length of the record is determined by the value of the IN and OUT pointers.

WRITER (024)

WRITER writes the entire contents of the buffer to the file specified.† The last PRU is written as a short PRU (refer to appendix J). If the data exactly fills the last PRU, the system adds a PRU with no data to indicate the end of the record. A WRITER request with level 178 set in FET+0, bits 17 through 14, performs the same operation as a WRITEF request.

Macro format:

<u>Location</u>	<u>Operation</u>	<u>Variable</u>
	WRITER	addr,r
addr	Address of the FET.	
r	Auto recall option; if any value is specified for r, control is not returned to the user program until the operation is complete.	

WRITEF (034)

WRITEF writes the entire contents of the buffer to the specified file. The last PRU written is the end-of-file. If there is data in the buffer, the system writes the data followed by an EOR and an EOF. If the buffer is empty and the last operation was an incomplete write (last PRU written was not EOR or EOF), an EOR and an EOF are written; otherwise only an EOF is written. For S and L format tapes, data in the buffer is transferred to tape and followed by a tape mark.

Macro format:

<u>Location</u>	<u>Operation</u>	<u>Variable</u>
	WRITEF	addr,r
addr	Address of the FET.	
r	Auto recall option; if any value is specified for r, control is not returned to the user program until the operation is complete.	

†The OUT pointer is updated. The IN pointer is not changed.

WRITECW (204)

The WRITECW function performs a nonstop write of PRUs bounded by control words. The PRUs are in the same format as specified for READCW. A level number of 17g on a PRU that contains data is ignored. Data written using this function is stored on the device in the same format as if it had been written with any other write function (that is, the control words are not part of the data).

WRITECW may only be used with mass storage and magnetic tape devices.

Macro format:

<u>Location</u>	<u>Operation</u>	<u>Variable</u>
	WRITECW	addr,r

addr Address of the FET.

r Auto recall option:

* The * option sets the WRITECW function code (CIO function code 204g) in FET+0 and returns to the calling program. The WRITECW function is not performed at this time.

If the symbol WRIF\$ is defined in assembly and a data transfer common deck attempts to issue a write request (refer to Data Transfer Macros in this section), it will use the CIO request set in the FET instead of a WRITE (014g) request. The data transfer common decks, by default, issue a WRITE (014g request if WRIF\$ is not defined). The WRITE macro can be used to reset the FET after using the * option with a WRITECW, WRITEN, or REWRITE macro.

If used, this option should be issued before any writing is performed on the file.

NOTE

The appropriate data transfer common deck must be assembled within the user program (that is, the SYSLIB version cannot be used) or the WRIF\$ is meaningless.

For example, the following sequence ensures that the data transfer common deck COMCWTW issues a WRITECW request instead of a WRITE request if it is required to write the circular buffer.

```

                                IDENT  WRT
                                .
                                .
                                .
WRIF$ EQU
OPL   XTEXT  COMCWTW
                                .
                                .
                                WRITECW F,*
                                .
                                .
                                WRITEW  F,WBUF,100B
                                .
                                .
                                .
F     FILEB  FBUF,2001B,FET=13
FBUF BSS    2001B
WBUF BSS    100B
                                .
                                .
                                .
                                END    WRT
```

other Control is not returned to the user program until the operation is complete.

REWRITE (214)

REWRITE performs the same operation as the WRITE function with the exception that it causes the system to process the operation as a random function; that is, the remainder of the file following the portion written is not destroyed. If the random parameters (r, rr, and w) are not specified in the FET, the write operation takes place at the current position. If the random parameters rr and w are specified, the normal random addressing procedures are followed. The file to be rewritten must reside on mass storage. A subsequent CLOSE function will not cause an update of the random index for the file, unless another CIO write function has altered the position of EOI since the last OPEN function.

NOTE

REWRITE does not ensure that the new record being rewritten is not longer than the original record.

Macro format:

<u>Location</u>	<u>Operation</u>	<u>Variable</u>
	REWRITE	addr,r

addr Address of the FET.

r Auto recall option:

 * The * option sets the REWRITE function code (CIO function code 214g) in FET+0 and returns to the calling program. No actual REWRITE function is performed at this time.

 For further information concerning use of the * option, refer to the WRITECW macro.

 other Control is not returned to the user program until the operation is complete.

REWRITER (224)

REWRITER performs the same task as WRITER with the exceptions noted for REWRITE. The file must reside on mass storage. If the level number is 178, REWRITER performs the same operation as REWRITEF.

Macro format:

<u>Location</u>	<u>Operation</u>	<u>Variable</u>
	REWRITER	addr,r

addr Address of the FET.

r Auto recall option; if any value is specified for r, control is not returned to the user program until the operation is complete.

NOTE

The last PRU is written as a short PRU (refer to appendix J). If the data exactly fills the last PRU, the system adds a PRU with no data to indicate the end of the record.

REWRITEF (234)

REWRITEF performs the same task as WRITEF with the exceptions noted for REWRITE. The file specified must reside on mass storage. A subsequent CLOSE function will not cause an update of the random index for the file, unless another CIO write function has altered the position of EOI since the last OPEN function.

Macro format:

<u>Location</u>	<u>Operation</u>	<u>Variable</u>
	REWRITEF	addr,r

addr Address of the FET.

r Auto recall option; if any value is specified for r, control is not returned to the user program until the operation is complete.

NOTE

An extra PRU is written to specify an EOF.

OVWRITE (244, 254)

The OVWRITE macro destroys the existing contents of a mass storage file by writing a specified binary pattern of information to the file. The entire file from BOI to EOI is rewritten.

This macro overwrites local files and attached direct access permanent files. In order to overwrite an indirect access permanent file, execute an OVWRITE macro on a local copy of the file followed by a REPLACE macro.

Macro format:

<u>Location</u>	<u>Operation</u>	<u>Variable</u>
	OVWRITE	addr,pat,RETURN,r
addr		Address of the FET.
pat		The pattern of information to be written to the file. If pat is X, the file is first overwritten with binary zeros, then with binary ones, then with an alternating pattern of binary ones and zeros. If pat is omitted or if any value other than X is specified, the file is overwritten with binary zeros.
RETURN		If RETURN is specified, CIO function 254 is issued and the file is returned after processing. If RETURN is not specified, CIO function 244 is issued and the file is not returned.
r		Auto recall option; if any value is specified for r, control is not returned to the user program until the operation is complete.

WRITEN (264)

The WRITEN macro writes nonstop on an S or L formatted magnetic tape. S and L formatted tapes are described in appendix J. Writing continues until the buffer is empty or end-of-reel is encountered.

Macro format:

<u>Location</u>	<u>Operation</u>	<u>Variable</u>
	WRITEN	addr,r

addr Address of the FET.

r Auto recall option:

 * The * option sets the WRITEN function code (CIO function code 2648) in FET+0 and returns to the calling program. The WRITEN function is not performed at this time.

 For further information concerning use of the * option, refer to the WRITECW macro.

 other Control is not returned to the user program until the operation is complete.

The user program must provide a header word immediately preceding each record in the buffer. This header is not physically written on the tape. Its format is:

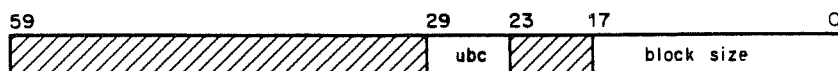

ubc Unused bit count. Number of bits that are not valid data in the last word; ubc may range from 0 to 55.

block size Number of CM words in the physical record.

The system compares the mlrs and ubc fields in FET+6 using information from this header.

The OUT pointer is not changed to reflect the move until after each complete record has been written to tape.

FILE POSITIONING FUNCTIONS

The following functions control the positioning of a file. If the FET indicates that the file is being accessed randomly, the random address of the new position (cri) is always returned.

Status responses assume coded mode (bit 1 of FET+0 clear). If binary mode is specified (bit 1 of FET+0 set), the responses end in 3 instead of 1. For example, 041 for coded mode is 043 for binary mode.

BKSP (040)

BKSP causes a file to be backspaced one logical record. If the BOI of the file (or the load point of the current volume in a multivolume tape file) is encountered before backspacing is complete, even if the file was originally at BOI, a rewind status is returned (05x). If the backspace causes the file to be positioned after BOI or exactly at BOI, a backspace status is returned (041).

If the operation terminates on an EOF, 178 is returned to the FET level number (1n) field (FET+0, bits 17 through 14).

Macro format:

<u>Location</u>	<u>Operation</u>	<u>Variable</u>
	BKSP	addr,r

addr Address of the FET.

r Auto recall option; if any value is specified for r, control is not returned to the user program until the operation is complete.

BKSPRU (044)

BKSPRU causes the file to be backspaced the specified number of physical records. If the BOI of the file (or the load point of the current volume in a multivolume tape file) is encountered before backspacing is complete, even if the file was originally at BOI, a rewind status is returned (05x). If the operation causes the file to be positioned after BOI or exactly at BOI, the backspace status is returned (045). The skip count is set in the RA+i call to CIO. (Refer to the format of the call to CIO.)

For tape files, if the operation terminates on an EOF, 17g is returned to the FET level number (ln) field (FET+0, bits 17 through 14).

Macro format:

<u>Location</u>	<u>Operation</u>	<u>Variable</u>
	BKSPRU	addr,n,r
addr	Address of the FET.	
n	Number of PRUs to backspace.	
r	Auto recall option; if any value is specified for r, control is not returned to the user program until the operation is complete.	

REWIND (050)

REWIND causes a mass storage file to be positioned at BOI.

For tape files that are multifile sets, the file is positioned to the beginning of the current file. If the tape is unlabeled, or if there is only one label at the beginning of the tape, a REWIND positions to the beginning of the first file on the tape.

If the file specified in the FET is not local to the job, no operation is performed.

In all cases, REWIND resets the IN and OUT pointers in the FET to the value of FIRST.

Macro format:

<u>Location</u>	<u>Operation</u>	<u>Variable</u>
	REWIND	addr,r
addr	Address of the FET.	
r	Auto recall option; if any value is specified for r, control is not returned to the user program until the operation is complete.	

For a mass storage file, if the random processing bit is set in the FET, the current random index (cri) is returned as the beginning of the file (random address 1).

If the file resides on magnetic tape, the action the system takes depends on the last I/O operation performed.

The system responds to a REWIND request as follows:

1. If the last operation was a write, one of the following operations is performed.
 - If the tape is labeled, the system writes a tape mark, an EOF1 label, and three tape marks.
 - If the tape is unlabeled and the data format (refer to appendix J) is S, L, or F, the system writes four tape marks.
 - If the tape is unlabeled and the data format is I or SI, the system writes a tape mark, an EOF1 label, and three tape marks.

If the last operation was a read, the system proceeds to step 2.

2. The system rewinds the tape to the beginning of data of the current file. This operation is performed automatically even if the current file begins on another reel.

UNLOAD (060)

UNLOAD causes the specified file to be rewound and unloaded. If the file resides on mass storage, UNLOAD performs the same function as RETURN. For tape files and files residing on removable packs, the UNLOAD function does not decrease the number of tape or pack resources scheduled for the job via the RESOURC command.

Macro format:

<u>Location</u>	<u>Operation</u>	<u>Variable</u>
	UNLOAD	addr,r

addr Address of the FET.

r Auto recall option; if any value is specified for r, control is not returned to the user program until the operation is complete.

If the file resides on magnetic tape, the action the system takes depends on the last I/O operation performed.

The system responds to an UNLOAD request as follows:

1. If the last operation was a write, one of the following operations is performed.
 - If the tape is labeled, the system writes a tape mark, an EOF1 label, and three tape marks.
 - If the tape is unlabeled and the data format is S, L, or F, the system writes four tape marks.
 - If the tape is unlabeled and the data format is I or SI, the system writes a tape mark, an EOF1 label, and three tape marks.

If the last operation was a read, the system proceeds to step 2.

2. The system rewinds and unloads the tape.

RETURN (070)

RETURN causes the specified file to be released from control of the job. The operation performed depends on the type of file.

<u>Type</u>	<u>Operation</u>
Input	The file name is changed to INPUT*; file space is not released and file INPUT* remains attached to the job as a local file.
Library	Job attachment is released but file space remains.
Permanent	File interlock (read/write) is cleared; job attachment is released; file space remains (if the file has been purged, the file space may be released at this time).
All others	File space and job attachment are released.

If the file resides on magnetic tape, the RETURN macro performs the same function as the UNLOAD macro. In addition, the RETURN of a magnetic tape file or your last direct access file for a particular removable disk pack decrements the resource demand count (as scheduled by the RESOURC command) only if the total concurrent resource demand (tapes and disk packs) has been satisfied. If the file is a deferred routed file (refer to section 7), the file space and job attachment are released.

Macro format:

<u>Location</u>	<u>Operation</u>	<u>Variable</u>
	RETURN	addr,r
addr		Address of the FET.
r		Auto recall option; if any value is specified for r, control is not returned to the user program until the operation is complete.

POSMF (110)

The POSMF macro opens and/or positions standard ANSI-labeled multifile magnetic tape sets to a member of the set. The file to be opened is determined by the contents of the label fields of the FET or, if the x1 bit is set, the contents of the HDR1 label in the extended label buffer. The relative position of the file within the multifile set is specified by the file sequence number field.

Macro format:

<u>Location</u>	<u>Operation</u>	<u>Variable</u>
	POSMF	addr,r

addr Address of the FET.

r Auto recall option; if any value is specified for r, control is not returned to the user program until the operation is complete.

Standard ANSI Labeled Multifile Set Processing

The PRU size (FET+4, bits 35 through 18) and device type (FET+1, bits 59 through 48) are returned to the FET as described in appendix J. The FET length must be at least 158 words.

A multifile set is positioned to read an existing file if the file sequence number in the FET is not display code 999. The following restrictions and requirements also apply.

- The tape is positioned to the first member of the multifile set whose HDR1 fields match the HDR1 data in FET+118 through FET+148. Binary zero fields are not compared. A nonzero retention cycle is used to calculate an expiration date that is compared with that on the tape. If all fields do not match, the search continues.
- If the explicit or implicit position number is greater than that of the last member file (that is, the matching HDR1 was not found), POSMF is terminated, returning an end-of-set status (218 set in bits 13 through 9 of FET+0) and updating the file sequence number field in the FET to one greater than that of the last member file. The HDR1 for the last member file is transferred to the CIO buffer, although IN and OUT are not updated. The current job step aborts.
- If the desired file is located, the HDR1 label is transferred to the CIO buffer, as space permits, although the IN and OUT pointers are not updated to reflect the label information in the buffer. Actual values read are returned to the label FET fields.
- All optional labels are ignored.

A multifile set is positioned to write a new file if the file sequence number in the FET is display code 999. Further requirements are as follows:

- The first file of a multifile set is created if all of the following are true (refer to examples 1 and 2):
 - The tape is positioned to the first file.
 - The last operation was not a write.
 - The set ID field in the initial HDR1 label on the tape is all blanks (the set ID field in the FET must be nonblank if the set is to be extended in the future).
- The multifile set is positioned to extend the set in all other cases. The tape is positioned to after the last file in the multifile set.
- The system writes a new HDR1 label to the tape with the following results.
 - The file sequence number of the new HDR1 label is set to display code 0001 for the first file, or is set to the last member sequence number plus 1 for extended files.
 - The section number in the HDR1 label is always set to display code 0001.
 - The set ID is always set to the set ID of the previous member. This ensures that the set ID is unique within a multifile set.
 - With the above exceptions, the information in FET+11₈ through FET+14₈ is used to create the HDR1 label. The default value is used for any FET HDR1 field that is binary zero. If a numeric field contains a nonnumeric value, the job step aborts.
 - The creation date field in the FET is ignored; the current date is always used.

Extended Label Multifile Set Processing

If the FET length is less than 12₈ words, the job step aborts.

The PRU size (FET+4, bits 35 through 18) and device type (FET+1, bits 59 through 48) are returned to the FET as described in appendix J.

To avoid a fatal error, an HDR1 label must be present in the extended label buffer (refer to extended label processing under the OPEN macro for a description of the extended label buffer).

A multifile set is positioned to read an existing file if the file sequence number in the buffer HDR1 label is not display code 9999. The following requirements also apply.

- The tape is positioned to the first member of the multifile set whose HDR1 label matches that in the label buffer. Binary zero fields are not compared. If the fields do not match, the search continues.
- If the explicit or implicit position number is greater than that of the last member file (that is, the matching HDR1 was not found), POSMF is terminated, returning an end-of-information status (21₈ in FET+0, bits 13 through 9).
- If the desired file is located, all labels from HDR1 through the next tape mark are transferred to the label buffer, as space permits. The user program is responsible for verification of additional labels.

A multifile set is positioned to write a new file if the file sequence number in the buffer HDR1 label is display code 9999. Further requirements or restrictions are as follows:

- The first file of a multifile set is created if all of the following are true (refer to examples 1 and 2).
 - The tape is positioned to the first file.
 - The last operation was not a write.
 - The set ID field in the existing HDR1 label on the tape is all blanks (the set ID field in the buffer HDR1 label must be nonblank if the set is to be extended in the future).
- The multifile set is positioned to extend the set in all other cases. The tape is positioned after the last file in the multifile set.
- The system writes a new HDR1 label and all additional user labels to the tape with the following results.
 - The file sequence number in the HDR1 label of the new file is set to display code 0001 for the first file or set to the last member sequence number plus 1 for extended files.
 - The file section number in the HDR1 label is always set to display code 0001.
 - The set ID is always set to the set ID of the previous member. This ensures that the set ID is unique within a multifile set.
 - With the above exceptions, the information in the extended label buffer is used to generate the HDR1 label on the tape. The default value is used for any buffer HDR1 field that is binary zero. If a numeric field contains a nonnumeric value, the job step aborts.

The creation date field in the buffer HDR1 label is ignored; the current date is always used.
 - All additional user file header labels (HDR2 through HDR9) and user header labels (UHL) in the label buffer are written to the tape. Nonapplicable labels are ignored.

Example 1:

1. BLANK,VSN=TEST,D=HY,MT.

Creates a labeled tape with SETID defaulted to blanks.

2. LABEL,TAPE,VSN=TEST,LB=KL,F=S,MT.

Causes tape to be assigned and positioned at file 1.

3. LGO.

Executes program where POSMF on file TAPE with recall specified is performed with sequence number set to 999 (or 9999) and a nonblank SETID set in the FET (or xl buffer). This causes the first file of the multifile set to be created using the label fields specified in the FET (or xl buffer).

Subsequent POSMFs with sequence number set to 999 (or 9999) cause the file to be extended since the SET ID field on the tape is not nonblank.

Example 2:

Repeat the preceding example except that a

LABEL,TAPE,VSN=TEST,SI=TESTAA,F=S,MT,W.

is performed at step 2. The POSMF in the third step extends the file set since the SETID is nonblank on the tape.

Example 3:

This example deals with a multifile set contained in two volumes with the following structure (the structure of multifile labels is outlined in Volume 3, System Commands).

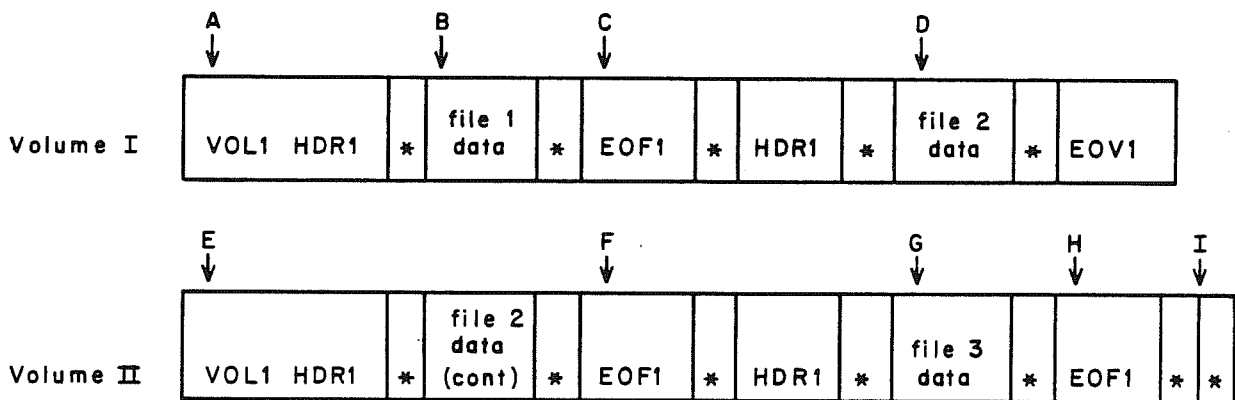

- The following steps create a multifile set with this structure.
 1. OPEN or LABEL With section number=1, sequence number not specified (default is 1).
 2. Write data (File set 1).
 3. POSMF With sequence number set to 999.
 4. Write data (Goes over end of reel) (file set 2).
 5. POSMF With sequence number set to 999.
 6. Write data (File set 3).
 7. REWIND This causes the trailer label at H to be written. The tape is then rewound to the beginning of Volume II (position E) and then the file is positioned forward to G. The tape is not necessarily at load point following a rewind of a multifile set member, rather at the start of the multifile set member. The only means, at this point, to position to the beginning of Volume I is to issue a POSMF with sequence number 1.
- If the multifile is positioned at the end of file set member 2 (F), a rewind positions the tape to the beginning of Volume I since file set member 2 begins on Volume I, and then positions Volume I to D.
- By writing over file set member 2, file set member 3 is destroyed.
- A POSMF 999 followed by a WRITE creates a file set member at I.
- To copy all three file set members, the following technique may be used.
 1. OPEN with display code 001 (or 0001) sequence number and all other label fields binary zero.
 2. READ to EOI. (C)
 3. POSMF with display code 002 (or 0002) sequence number and all other label fields binary zero. This positions to next file set member at (D).
 4. READ to EOI. (F)
 5. POSMF with display code 003 (or 0003) sequence number and all other label fields binary zero.
 6. READ to EOI. (H)

The SI (M) parameter must be present in order to position multifile labels using commands. If the QN (P) parameter is present, the multifile set is positioned to the file set member that matches the specified sequence number. If QN is not specified and the FI (L) parameter is present, the multifile set is positioned to the file set member that matches the file identifier specified. If both QN and FI are specified, a match must occur on both sequence number and file identifier. If neither QN nor FI is specified, an OPEN is done instead of a POSMF.

To extend a multifile set, QN must be set to 9999.†

Setting the QN parameter to zero advances the pointer to the next multifile. This is not true of a LABEL command.

If the SI parameter is not specified, then file positioning is not done. The R and W parameters on the LABEL command are ignored if SI is specified. The exception is if the W parameter is specified and QN<1, and it is the first OPEN on the file, then an OPEN/WRITE is performed.

Although the sequence number field in the HDRI label is four characters in length, only the rightmost three characters are used to differentiate between 999 and another valid sequence number. This occurs because on an open (POSMF), the FET field for sequence is only three characters. Therefore, if extended labels are not being used, a limit of 998 file set members per file set is enforced.

EVICT (114)

The EVICT macro is similar to the RETURN macro in that it releases file space for the specified file. It differs from RETURN in that EVICT does not release the file attachment to the job. When an EVICT is performed on a deferred routed queue file (refer to ROUTE macro, section 7), all file routing information associated with the file is cleared.

Macro format:

<u>Location</u>	<u>Operation</u>	<u>Variable</u>
	EVICT	addr,r
addr		Address of the FET.
r		Auto recall option; if any value is specified for r, control is not returned to the user program until the operation is complete.

The operation that EVICT performs depends on the file type. For the primary file and permanent files, all file space except the first track is released, job attachment remains, and an EOI is written on the first sector of the first track. For all other mass storage file types, file space is released and job attachment remains. Files for which write lockout is set are returned to the system. An EVICT of a tape file performs the same functions as the UNLOAD macro.

†When a multifile set is extended, the set ID of the new file is always set to the same value as the previous file. This ensures that the set IDs of all set members are the same.

SKIPF (240)

SKIPF causes the file to be positioned n records forward from the current position. The operation terminates when the skip count is satisfied or when EOI is encountered on a mass storage file or a tape file.

The status responses (bits 17 through 0 of FET+0) are:

0261†	Last record skipped was EOR.
740271†	Last record skipped was EOF.
741271†	EOI encountered.

Macro format:

<u>Location</u>	<u>Operation</u>	<u>Variable</u>
	SKIPF	addr,n,r
addr	Address of the FET.	
n	Number of records to skip; if n is omitted, 1 is assumed.	
r	Auto recall option; if r is specified, control is not returned to the user program until the operation is complete.	

SKIPFF (240)

SKIPFF skips forward the specified number of files.

The status responses (bits 17 through 0 of FET+0) are:

740271†	Last record skipped was EOF.
741271†	EOI encountered.

Macro format:

<u>Location</u>	<u>Operation</u>	<u>Variable</u>
	SKIPFF	addr,n,r
addr	Address of FET.	
n	Number of files to skip; if n is omitted, 1 is assumed.	
r	Auto recall option; if any value is specified for r, control is not returned to the user program until the operation is complete.	

†This status response is returned for a coded FET. The status response for a binary FET ends in 3 instead of 1 (refer to the description of the code field of FET+0 at the beginning of this section).

SKIPEI (240)

SKIPEI causes the file to be positioned at EOI. The skip count in RA+1 is set to 777777₈ to indicate a skip to EOI. The status returned in bits 17 through 0 of FET+0 is 741271. On tape files where no EOI is defined, the skip operation stops at an EOF.

Macro format:

<u>Location</u>	<u>Operation</u>	<u>Variable</u>
	SKIPEI	addr,r

addr Address of the FET.

r Auto recall option; if any value is specified for r, control is not returned to the user program until the operation is complete.

SKIPB (640)

SKIPB causes the file to be backspaced n logical records. If the BOI of the file (or the load point of the current volume in a multivolume tape file) is encountered before backspacing is complete, even if the file was originally at BOI, a rewind status (05x) is returned. If the file is positioned after BOI or exactly at BOI, backspace status is returned (641†). If the skip stops at an EOF, the level number is set to 17₈ (status returned is 740641†).

Macro format:

<u>Location</u>	<u>Operation</u>	<u>Variable</u>
	SKIPB	addr,n,r

addr Address of the FET.

n Number of records to skip backward. If n is not specified, 1 is assumed. If n=777777₈, file is rewound.

r Auto recall option; if any value is specified for r, control is not returned to the user program until the operation is complete.

†This status response is returned for a coded FET. The status response for a binary FET ends in 3 instead of 1 (refer to the description of the code field of FET+0 at the beginning of this section).

SKIPFB (640)

SKIPFB causes the specified file to be backspaced *n* files from the current position. If the skip count specified is 7777778, the file is rewound. If the BOI of the file (or the load point of the current volume in a multivolume tape file) is encountered before backspacing is complete, even if the file was originally at BOI, a rewind status (05x) is returned. Otherwise a skip status (740641†) is returned.

Macro format:

<u>Location</u>	<u>Operation</u>	<u>Variable</u>
	SKIPFB	addr,n,r
addr	Address of the FET.	
n	Skip count; if <i>n</i> is omitted, 1 is assumed.	
r	Auto recall option; if any value is specified for <i>r</i> , control is not returned to the user program until the operation is complete.	

DATA TRANSFER MACROS

NOS provides a set of macros to assist you in manipulating the following types of data.

- Data that is to be processed after being read from a file.
- Data that is to be written on a file after being processed.

To use the data transfer macros with the input/output macros, the user program must define FETs, input/output circular buffers, and working buffers. The data transfer macros enable the user program to copy data from the working buffer to the circular buffer and vice versa without having to be concerned with the circular buffer FET pointers. The macros and the associated common decks perform all activities involved with the FET pointers. Figure 3-3 illustrates a typical buffer arrangement.

In figure 3-3, to copy data from the working buffer to the circular buffer a write data transfer macro is used. In this case, data starting at the address of the working buffer is copied to the circular buffer starting at address IN. To copy data from the circular buffer to the working buffer, a read data transfer macro is used. Then data starting at the circular buffer address OUT is copied beginning at the address of the working buffer.

The working buffer is usually significantly smaller than the input/output buffer.

The user program must issue the input/output functions to initiate reading or writing between the input/output buffer and the device. However, once the function is issued, the common decks called by the data transfer macros initiate the subsequent input/output requests required to maintain the data flow until the initial function is completed; that is, until an EOR, EOF, or EOI is encountered, depending on the CIO function.

†This status response is returned for a coded FET. The status response for a binary FET ends in 3 instead of 1 (refer to the description of the code field of FET+0 at the beginning of this section).

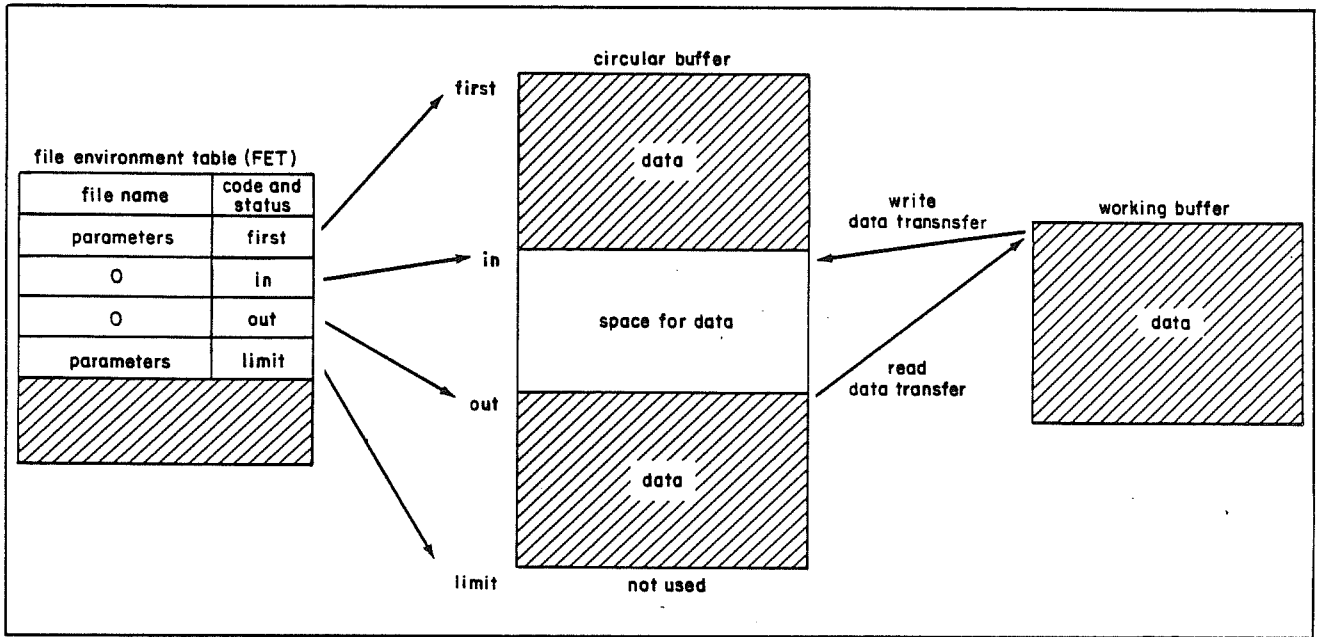

Figure 3-3. Data Transfer Buffer Arrangement

Data transfer read macros return the following information.

- (X1) = 0 if the transfer to the working buffer is complete.
- (X1) = -1 if an EOF is encountered when reading the file.
- (X1) = -2 if an EOI is encountered when reading the file.
- (X1) > 0 if an EOR is encountered on the file before the transfer to the working buffer is complete; this number is the address plus 1 in the working buffer of the last word transferred (equal to B6).

A CIO read function stops transferring data to the input/output circular buffer when an EOR, EOF, or EOI is encountered, unless the CIO function being used specifies a different termination condition (for example, READEI or READNS). Depending on the CIO read function, the EOR and/or EOF status may not be returned (for example, READEI or READNS).

Following a data transfer read function, register B6 contains the address plus 1 of the working buffer for the last word of data transferred.

The following sample program rewinds an input file named INP and an output file named OUT and copies file INP to file OUT.

```

IDENT COPYFIL
ENTRY COPYFIL
SYSCOM B1

**      ASSEMBLY CONSTANTS.

IBUFL  EQU    1001B      INPUT BUFFER LENGTH
OBUFL  EQU    2001B      OUTPUT BUFFER LENGTH
WBUFL  EQU    100B       WORKING BUFFER LENGTH

**      FETS.

I      BSS     0
INP    FILEB  IBUF,IBUFL
O      BSS     0
OUT    FILEB  OBUF,OBUFL

**      MAIN PROGRAM.

COPYFIL SB1     1
        REWIND 0
        REWIND I

COP1    READ   I           INITIATE READ OF LOGICAL RECORD
        RECALL 0

COP2    READW  I,WBUF,WBUFL
        ZR     X1,COP3     IF NOT EOR/EOF
        NG     X1,COP4     IF EOF OR EOI ENCOUNTERED

*      EOR ENCOUNTERED. COPY DATA IN WBUF TO OUTPUT FILE.

        WRITEW 0,WBUF,X1-WBUF WRITE LAST PORTION OF RECORD
        WRITER 0           WRITE END-OF-RECORD
        EQ     COP1        INITIATE READ OF NEXT RECORD

COP3    WRITEW 0,WBUF,WBUFL
        EQ     COP2        TRANSFER MORE DATA TO WBUF

COP4    SX1    X1+1
        NG     X1,COP5     IF EOI ENCOUNTERED
        WRITEF 0           WRITE END-OF-FILE
        EQ     COP1        INITIATE READ OF NEXT RECORD

COP5    ENDRUN

**      BUFFERS.

IBUF    BSS     IBUFL      INPUT BUFFER
OBUF    BSS     OBUFL      OUTPUT BUFFER
WBUF    BSS     WBUFL      WORKING BUFFER

        END     COPYFIL

```

In the previous example, if the RECALL function was not specified for the output file, the following steps could occur.

1. The user program issues the REWIND 0 function.
2. Since auto recall is not specified, the user program continues to execute.
3. At some point, the user program issues WRITEW which moves data from WBUF to the output buffer (OBUF) starting at the current IN pointer in the FET. The WRITEW macro advances the IN pointer to reflect the amount of data transferred into the buffer.
4. At this point, the system completes the REWIND function and accordingly updates the FET IN and OUT pointers to point to FIRST (empty buffer). This destroys the IN pointer updated in step 3. The data placed in the buffer is ignored.
5. On subsequent EOR operations (WRITER), the same situation could occur if the RECALL function were placed elsewhere.

```
WRITER 0
.
.           RECALL 0 must be placed here.
.
WRITEW 0,WBUF,WBUFL
.
.
.
```

Write requests in the previous example are not issued with auto recall specified because other operations (READ, for example) can be performed before it is necessary to have the write operation completed.

In the previous example, if an EOR or EOF mark is not detected, it is not necessary to reissue READ requests to fill the input/output buffer because the data transfer macros and associated common decks detect when the buffer threshold is reached. If this threshold is reached, a request is issued to CIO by the common deck. This occurs with the READC, READH, READS, and READW macros when the empty space in the buffer exceeds the threshold or with the WRITEC, WRITEH, WRITES, and WRITEW macros when data in the buffer exceeds the threshold. The threshold used is half the buffer size. That is, if the buffer is less than half full, a read request is issued; if it is more than half full, a write request is issued. The threshold is an empty buffer for read transfers or a full buffer for write transfers if any of the following conditions is met:

1. The data transfer macro is READO or WRITEO.
2. The buffer is smaller than 512 (1000g) words.
3. For read transfers, symbol RDX\$ is defined and common deck COMCRDW is assembled with the program.
4. For write transfers, symbol WTX\$ is defined and common deck COMCWTW is assembled with the program.

Assuming no EOR or EOF is encountered by the fifth time through the loop, IBUF is less than half full since 256 (400g) words were read. The READW function then issues another CIO request to transfer data from file I to circular buffer IBUF. On the ninth time through the loop, the WRITEW function issues a WRITE request to file O since OBUF is now more than half full.

For the data transfer macros, the common decks required for absolute assemblies, in addition to those specified with each macro, are:

- COMCCIO
- COMCSYS
- COMCWTW for write functions (except WRITEO)
- COMCRDW for read functions (except READO)

For relocatable assemblies, these decks are satisfied by default from the library SYSLIB. SYSLIB also satisfies the common decks specified with each macro.

In all of the macros described, the following parameter definitions apply.

addr Address of the FET.
buf Working buffer address.
n Working buffer word count.

READC

The READC macro reads one coded line from the input/output buffer to the working buffer. Data is transferred until the end of the line (0000 in bits 11 through 0) is sensed or until n words are transferred.

Macro format:

<u>Location</u>	<u>Operation</u>	<u>Variable</u>
	READC	addr,buf,n

Common deck required: COMCRDC

WRITEC

The WRITEC macro transfers a coded line image from the working buffer to the input/output buffer.

Macro format:

<u>Location</u>	<u>Operation</u>	<u>Variable</u>
	WRITEC	addr,buf

Common deck required: COMCWTC

READH

The READH macro reads a coded line with space fill from the input/output buffer to the working buffer. Data is transferred until the end of the line (0000 in bits 11 through 0) is sensed or until n words are transferred.

Macro format:

<u>Location</u>	<u>Operation</u>	<u>Variable</u>
	READH	addr,buf,n

Common deck required: COMCRDH

WRITEH

The WRITEH macro writes a coded line, deleting all trailing spaces, from the working buffer to the input/output buffer.

Macro format:

<u>Location</u>	<u>Operation</u>	<u>Variable</u>
	WRITEH	addr,buf,n

Common deck required: COMCWTH

READO

The READO macro reads one word from the input/output buffer to X6. (X1)=1 if an EOR is encountered.

Macro format:

<u>Location</u>	<u>Operation</u>	<u>Variable</u>
	READO	addr

Common deck required: COMCRDO

WRITEO

The WRITEO macro writes one word from X6 to the input/output buffer.

Macro format:

<u>Location</u>	<u>Operation</u>	<u>Variable</u>
	WRITEO	addr

Common deck required: COMCWTO

READS

The READS macro reads a coded line to a character buffer. The words are unpacked and stored in the working buffer, right-justified, one character per word, until the end-of-line byte (0000) is detected. If the coded line terminates before n characters are stored, the working buffer is blank-filled. If the value specified for n is the complement of the working buffer length, the working buffer is not blank-filled.

Macro format:

<u>Location</u>	<u>Operation</u>	<u>Variable</u>
	READS	addr,buf,n

Common deck required: COMCRDS

WRITES

The WRITES macro writes a coded line from the character buffer. The character buffer is assumed to be one character per word, right-justified. The characters are packed 10 characters per word. Trailing spaces are deleted before the characters are packed.

Macro format:

<u>Location</u>	<u>Operation</u>	<u>Variable</u>
	WRITES	addr,buf,n

Common deck required: COMCWTS

READW

The READW macro transfers n words to the working buffer from an input/output circular buffer. READW reads ahead in the input/output buffer. This could cause the program to abort if the last word address of the input/output buffer is within four words of the FL. The n parameter must be specified.

Macro format:

<u>Location</u>	<u>Operation</u>	<u>Variable</u>
	READW	addr,buf,n

Common deck required: COMCRDW

WRITEW

The WRITEW macro copies data from the working buffer to the input/output circular buffer. WRITEW writes ahead in the input/output buffer. This could cause the program to abort if the last word address of the input/output buffer is within four words of the FL. If n is greater than the length of buf, WRITEW reads beyond the end of the working buffer. The n parameter must be specified.

Macro format:

<u>Location</u>	<u>Operation</u>	<u>Variable</u>
	WRITEW	addr,buf,n

Common deck required: COMCWTW

CYBER RECORD MANAGER I/O

CYBER Record Manager (CRM) consists of a group of routines providing input/output facilities common to several products. User programs written in several higher level languages (for example, COBOL and FORTRAN) can communicate with the Record Manager through compiler language calls. COMPASS users communicate through Record Manager macros.

Features of the CRM include the following:

- Consistent error checking.
- Accommodation for label checking.
- Support of several file organizations.

CYBER Record Manager supports the following file organizations.

- Sequential files in physical order.
- Word addressable files on mass storage with continuous nonblocked data.
- Indexed sequential files in which records are physically and logically ordered by symbolic keys.
- Direct access files containing records in fixed length blocks; record location is determined by hashing a key to identify a block.
- Actual key files in which each record is stored in a location specified by the key associated with that record.

For a complete description of COMPASS macros, file organizations, and record and block formats supported by CRM, refer to the CYBER Record Manager Basic Access Methods and Advanced Access Methods reference manuals.

LOCAL FILE MANAGER

Local file manager (LFM) performs requests associated with the control of the files assigned to your job.

The format of the call to LFM is:

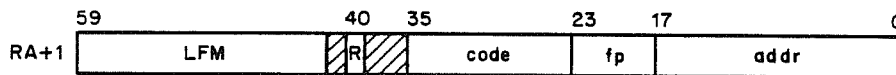

- R Auto recall bit.
- code Function code.
- fp Function parameter.
- addr Address of the FET.

All LFM requests use the following information from the FET. Some requests use additional fields; these are noted in the descriptions of the individual requests.

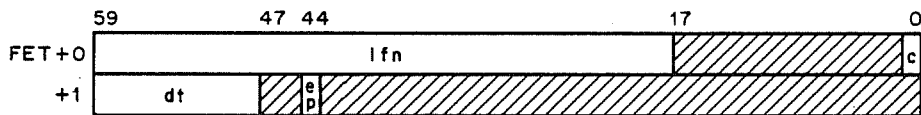

- lfn Local file name.
- c Completion bit.
- dt Device type.
- ep Error processing bit.

After the request is completed, the first word of the FET contains the following information.

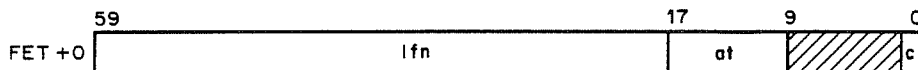

- lfn Local file name.
- at Abnormal termination code.
- c Completion bit.

The common decks required in absolute assemblies for the macros processed by LFM are:

- COMCLFM.
- COMCSYS.

For relocatable assemblies, these decks are satisfied by default from the library SYSLIB.

ERROR PROCESSING

The user program can issue requests to LFM and have control returned if certain error conditions occur. To do this, the error processor bit (ep) must be specified in FET+1. The following error codes are returned in the abnormal termination (at) code field of FET+0, bits 17 through 10.

<u>Error Code</u> (Octal)	<u>Description</u>	<u>Error Code</u> (Octal)	<u>Description</u>
1	File not found	16	I/O sequence error
2	File name error	17	Reserved for future use
3	Illegal file type	20	Reserved for future use
4	File empty	21	No mass storage available
5	Magnetic tape subsystem not active	22	Invalid file mode
6	Reserved for future use	23	FET too short
7	Illegal equipment	24	GETFNT table too large
10	Equipment not available	25	Reserved for future use
11	Duplicate file name	26	Parameter block busy
12	Invalid user access	27	Address out of range
13	Access level not valid for file	30	System error
14	Reserved for future use	31	Invalid random address
15	Resource executive (RESEX) detected an error	32	Reserved for future use
		33	Invalid file status

RENAME (000)

The RENAME function enables the user program to change the local file name of a file currently assigned to the job. The current local file name must be specified in FET+0 and the new local file name must be specified in FET+6. RENAME also changes FET+0 to contain the new file name after the function executes. Note that RENAME does not change the name of the file in the permanent file catalog.

If a file by the new file name already exists, that file is returned to the system. If the returned file was the primary file (type PTFT) and the old file was local (type LOFT), the file type of the new file will be PTFT. File types are listed in appendix E.

Macro format:

<u>Location</u>	<u>Operation</u>	<u>Variable</u>
	RENAME	addr,nfn

addr Address of the FET.
nfn New file name.

<u>Value</u>	<u>Description</u>
X1	X1 contains the new file name.
Other	Address of word containing new file name.
Not specified	FET+6 contains the new file name.

SETFS (003)

The SETFS function sets the specified status on a file.

Macro format:

<u>Location</u>	<u>Operation</u>	<u>Variable</u>
	SETFS	addr,fs

addr Address of the FET for the file.

fs File status.

Value

Description

AD Auto drop status. A file with auto drop status is automatically released when a CLEAR, NEW, OLD, RETURN(*), or UNLOAD(*) command is issued, unless otherwise specified in the command. All of your files have auto drop status set unless you set no auto drop status.

NAD No auto drop status. A file with no auto drop status is not automatically released by a CLEAR, NEW, OLD, RETURN(*), or UNLOAD(*) command.

Other Other file status values are defined in system OPL common deck COMSLFD.

SETFAL (007)

The SETFAL macro sets the security access level of a local file to the specified level. The file must be a mass storage file and may not be a direct access permanent file (use the SETPFAL macro for permanent files). This macro requires the system OPL common deck COMSMLS.

Macro format:†

<u>Location</u>	<u>Operation</u>	<u>Variable</u>
	SETFAL	addr,al

addr Address of the FET for the file.

al Security access level to be assigned to the file. al can be either the name of the access level to be assigned or the address of a word containing the numerical value of a security access level, right-justified with binary zero fill. On a secured system, the access level specified must be valid for your job (refer to Security Access Levels in section 1) and valid for the device on which the file resides.

† This macro is not available in SYSTEXT. The user program must specify systems text PSSTEXT or call common deck COMCMAC.

LOCK (010)

This function enables the user program to prevent writing on a file by setting the write lockout bit for the file. The file specified must be a local or primary type file, and must not be in execute-only mode.

Macro format:

<u>Location</u>	<u>Operation</u>	<u>Variable</u>
	LOCK	addr
addr		Address of the FET.

UNLOCK (011)

The UNLOCK function clears the write lockout bit for the specified file. The file must be a local or primary type file, and must not be in execute-only mode.

Macro format:

<u>Location</u>	<u>Operation</u>	<u>Variable</u>
	UNLOCK	addr
addr		Address of the FET.

STATUS (012)

The STATUS macro determines if a file exists. Zero is returned in bits 11 through 1 of FET+0 if the file is not found. A nonzero quantity is returned in bits 11 through 1 if the file is found. To determine the current position and status of a file, use STATUS (013).

Macro format:

<u>Location</u>	<u>Operation</u>	<u>Variable</u>
	STATUS	addr
addr		Address of the FET.

STATUS (013)

This function returns the current position and status of a mass storage or magnetic tape file. This function can be used to determine the current position of the file, the type of file, and the device on which it resides.

The device type is returned in bits 59 through 48 of FET+1 (refer to appendix E); bit 59 is set if the device is a nonmass storage and nonallocatable device.

If the access level bit (bit 39) is set in FET+1, the access level of the file is returned in bits 38 through 36 of FET+4.

The FNT word of the local FNT entry of the file is returned in FET+5; the FST word of the local FNT entry of the file is returned in FET+6. The format of the local FNT entry is described in the NOS 2 Systems Programmer's Instant.

NOS does not return the previous function code from bits 11 through 0 of the FST word. Instead, the following status information is returned to the FET.

<u>Bit(s)</u>	<u>Description</u>
11	Set if labeled tape.
10-9	Not used.
8	Set if the file is opened.
7	Set if the file is written on since last opened.
6	Set if the file is written on since attachment or creation.
5-4	Not used.
3-2	If the last operation was a read: 0 Incomplete (buffer full). 1 EOR encountered. 2 EOF encountered. 3 EOI encountered.
	If the last operation was a file positioning or write operation: 0 Incomplete (no EOR/EOF or buffer exhausted). 1 Complete.
1	Set if the last operation was a write.
0	Set if the file is not busy.

Macro format:

<u>Location</u>	<u>Operation</u>	<u>Variable</u>
	STATUS	addr,p,t

addr Address of the FET.

p If P is specified, the current position is returned. If this parameter is omitted, LFM function 12 is executed.

t If T is specified and the FET is at least 118 words long, the following information is returned to FET+108 for tape files.

<u>Bit(s)</u>	<u>Description</u>
58	Set if NOS labels are on tape.
57	Set if nonstandard labels are on tape.
56	Set if nine-track tape.
53-51	Density.†
50-48	Conversion mode.†
47-36	Processing options.†
35-30	Format.†
29-24	Noise size.†
23-0	Block size.†

REQUEST (014)

The REQUEST function requests operator assignment of equipment to a file. If the file is already assigned, the function is ignored. If dt in FET+1 is nonzero, the device assigned is of that type. If dt equals MS, a mass storage device must be assigned. The REQUEST function cannot be used to assign tape equipment.

If dt is zero, operator assignment of tape equipment is rejected and operator request for equipment continues until an acceptable device is assigned. The LABEL macro should be used for tape requests.

No special validation is required to assign allocatable devices such as mass storage or null equipment. All other equipment requires you to be validated to use nonallocatable devices.††

If the access level bit (bit 39 of FET+1) is set, the file is created with the access level from bits 38 through 36 of FET+4. On a secured system, this level must be valid for your job. If the access level bit is not specified, the file is created with no access level on an unsecured system; on a secured system, the file is created with your job's current access level.

On a secured system, operator assignment of an equipment that does not support the access level of the file is rejected.

†For further information about this field, refer to the LABEL macro description.

††Refer to the LIMITS command in Volume 3, System Commands.

Macro format:

<u>Location</u>	<u>Operation</u>	<u>Variable</u>
	REQUEST	addr,,n

addr Address of the FET.

n If this parameter is specified (any value may be used), the dayfile message indicating the equipment to which the file was assigned will not be issued.

If REQUEST is to be used to checkpoint dumps, FET+7 specifies the checkpoint mode.



cm Checkpoint† mode indicates that addr is to be used as a checkpoint file:

75g	Each time a checkpoint dump is taken, the new information is written at the BOI of addr.
76g	Each time a checkpoint dump is taken, the new information is written at the previous EOI of addr.

The user program can alternately write dumps on two checkpoint files by issuing two REQUEST macros with cm=75g. If cm=76g for alternate files or if more than two checkpoint files are specified, the job step aborts.

NOTE

On a secured system, the checkpoint file must be assigned an access level equal to the upper access level limit of your job.

REQUEST (015)

This function assigns a file to a device according to the contents of the device type field in FET+1. If the file already exists, the job step aborts.

The device type (dt) field affects the file's assignment as follows:

<u>If dt is</u>	<u>LFM assigns file to</u>
DB	885-42 Disk Storage Subsystem
DC	895 Disk Storage Subsystem
DD	834 Disk Storage Subsystem
DE	Extended Memory
DF	887 Disk Storage Subsystem, 4K Sector
DG	836 Disk Storage Subsystem
DH	887 Disk Storage Subsystem, 16K Sector
DI	844-21 Disk Storage Subsystem
DJ	844-41/44 Disk Storage Subsystem

† For further information, refer to the description of the CHECKPT macro in section 10.

<u>If dt is</u>	<u>LFM assigns file to device of preferred residence for</u>
DK	844-21 Disk Storage Subsystem
DL	844-41/44 Disk Storage Subsystem
DM	885-11/12 Disk Storage Subsystem
DP	Distributive Data Path to Extended Memory
DQ	885-11/12 Disk Storage Subsystem
DV	819 Disk Storage Subsystem
DW	819 Disk Storage Subsystem
IN	Input files
LG	Binary (executable) files
LO	Local files
MS	Any allocatable mass storage device
NE	Null equipment
OT	Output files
PY	Primary files
TP	Temporary files
TT	The terminal (interactive jobs only)

The device of preferred residence for each of these file categories is determined by the site and is not subject to user program control. The mass storage devices must also be temporary file devices.

If the device type field contains a numeric value of the form 7nnng, the file will be assigned to EST ordinal nnn. Special validation is required to use this form of the request, and nnn must be the EST ordinal of a valid mass storage device.

The LABEL macro (described in this section) should be used for tape requests.

If the access level bit (bit 39 of FET+1) is set, the file is created with the access level from bits 38 through 36 of FET+4. On a secured system, this level must be valid for your job. If the access level bit is not specified, the file is created with no access level on an unsecured system; on a secured system, the file is created with your job's current access level.

On a secured system, the system selects a device that supports the access level of the file and also meets all of the other specified criteria for the file. If no such device exists, the request is rejected.

Macro format:

<u>Location</u>	<u>Operation</u>	<u>Variable</u>
	REQUEST	addr,u,n
addr	Address of the FET.	
u	If this parameter is specified (any value may be used), the device type in FET+1 is the device to which the file is assigned. Absence of this parameter causes LFM function 014 to be issued.	
n	If this parameter is specified (any value may be used), the dayfile message indicating the device to which the file was assigned will not be issued.	

ASSIGN (020)

This function is used to access a library file. If the file is accessed from a system or library file, the return status code equals 0.

The random address of the directory is stored in FET+6.

The address bias for the directory is stored in FET+7.

This function enables the user program to access user libraries that exist either on files attached to the job or the system. The local files are searched first. Because of the structure of the system file, the address bias for the directory must be specified. For example, if the directory for SYSLIB is specified at random address 2000 (FET+6) on the system file, the bias for all entries in this directory is 1777 (FET+7). This is the address to be added to the random addresses of all routines in this directory to access the routines from the system library.

If the file specified is a system procedure file, the sign bit in FET+7 is set. If the file specified is not a system file, FET+6 and FET+7 are returned as zero. If the file specified is a relocatable file, FET+6 and FET+7 are unchanged.

Macro format:

<u>Location</u>	<u>Operation</u>	<u>Variable</u>
	ASSIGN	addr,L
addr		Address of the FET.
L		This parameter must be specified.

ENCSF (022)

This function replaces the command file. If the file is not defined, the command file is cleared.

Macro format:

<u>Location</u>	<u>Operation</u>	<u>Variable</u>
	ENCSF	addr, restore
addr		Address of the FET for the file that is to replace the current command file.
restore		Address of word containing information on position of the current command file; optional parameter.

If the restore option is selected, the location must be in the following format.

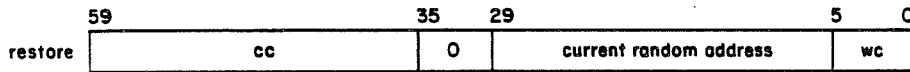

cc Command count.

wc Word count position in current sector.

PSCSF (023)

This function gives the user program the ability to control the execution of the job commands by positioning to the next command in the command file to be executed.

Macro format:†

<u>Location</u>	<u>Operation</u>	<u>Variable</u>
	PSCSF	addr

addr Address of the FET for the request.

FET+6 contains the parameters in the following format:

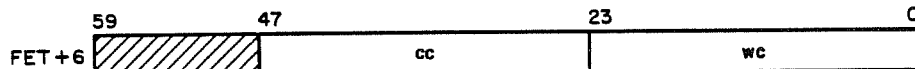

cc Command count.

wc Word count from the beginning of the file; if the word count specified exceeds the length of the file, the file is positioned at the beginning.

†This macro is not available in SYSTEXT. The user program must specify systems text PSSTEXT or call common deck COMCMAC (refer to appendix F).

LABEL (024)

The LABEL macro assigns a file to magnetic tape and processes labeled and unlabeled tapes. LABEL uses the information in FET+10₈ through FET+15₈ to create new and access existing seven- or nine-track tape files. The FET information is defined as follows:

NOTE

On systems using the Tape Management System (TMS), the FET information is defined differently. For a description of the FET information for the LABEL macro under TMS processing, refer to the NOS 2 Tape Management System (TMS) User Reference Manual.

	59	53	47	35	29	23	14	0
FET +10	flags	den	cv	po	f	noise	block size	
+11	volume serial number						fa	file section number
+12	file identifier (first 10 characters)							
+13	file identifier (last 7 characters)						file sequence number	
+14	set identifier					gyn	generation number	
+15	expiration date				creation date			

<u>Parameter</u>	<u>Word (FET+n)</u>	<u>Position</u>	<u>Description</u>
Flags	10 ₈	59	Read/write (rw) flag. Specifies the type of label processing to be performed. This bit is set if an OPEN/WRITE is to be performed; it is not set if an OPEN/ALTER is to be performed.
			For multifile set tapes, if the set identifier is specified and a file sequence number greater than 1 is specified, a POSMF is performed to position the tape to the requested multifile set. If the file sequence number is 9999, write mode is forced and the multifile set tape is extended.

<u>Parameter</u>	<u>Word (FET+n)</u>	<u>Position</u>	<u>Description</u>
		58	Label (lb) flag. If this bit is set, the tape is labeled or is to be labeled. If this bit is not set, the tape is unlabeled.
		57	Nonstandard (ns) flag. If this bit is set, the tape has or is to have nonstandard labels. If this bit is not set and bit 58 is set, the file is or is to be an ANSI-labeled tape.
		56	Tracks (tr) flag. If this bit is set, a nine-track tape is to be used. If this bit is not set, a seven-track tape is to be used. It must not conflict with track type implied by density and conversion mode.
Density (den)	10 ₈	53-51	Tape density: <ul style="list-style-type: none"> 0 Installation default. 1 556 cpi (seven-track). 2 200 cpi (seven-track). 3 800 cpi (seven-track) <li style="padding-left: 2em;">or 800 cpi (nine-track). 4 1600 cpi (nine-track). 5 6250 cpi (nine-track).
Conversion mode (cv)	10 ₈	50-48	Conversion mode: <ul style="list-style-type: none"> 0 Installation default. 1 ASCII conversion (nine-track). 2 EBCDIC conversion (nine-track).

<u>Parameter</u>	<u>Word (FET+n)</u>	<u>Position</u>	<u>Description</u>												
Processing option (po)	10 ₈	47-36	Processing options: [†]												
			<table border="1"> <thead> <tr> <th><u>Bit Set</u></th> <th><u>Description</u></th> </tr> </thead> <tbody> <tr> <td>36</td> <td>Abort on an unrecoverable read or write parity error even if the error processing bit is set.</td> </tr> <tr> <td>37</td> <td>Do not abort on an unrecoverable read or write parity error regardless of the error processing bit.</td> </tr> <tr> <td>38</td> <td>Inhibit error processing.</td> </tr> <tr> <td>39</td> <td>If the tape is mounted with the write ring in, job processing is suspended until the operator remounts the tape correctly.</td> </tr> <tr> <td>40</td> <td>If the tape is mounted with the write ring out, job processing is suspended until the operator remounts the tape correctly.</td> </tr> </tbody> </table>	<u>Bit Set</u>	<u>Description</u>	36	Abort on an unrecoverable read or write parity error even if the error processing bit is set.	37	Do not abort on an unrecoverable read or write parity error regardless of the error processing bit.	38	Inhibit error processing.	39	If the tape is mounted with the write ring in, job processing is suspended until the operator remounts the tape correctly.	40	If the tape is mounted with the write ring out, job processing is suspended until the operator remounts the tape correctly.
<u>Bit Set</u>	<u>Description</u>														
36	Abort on an unrecoverable read or write parity error even if the error processing bit is set.														
37	Do not abort on an unrecoverable read or write parity error regardless of the error processing bit.														
38	Inhibit error processing.														
39	If the tape is mounted with the write ring in, job processing is suspended until the operator remounts the tape correctly.														
40	If the tape is mounted with the write ring out, job processing is suspended until the operator remounts the tape correctly.														

† If neither bit 36, 37, nor 38 is set, abort on read or write parity error only if the error processing bit is not set. For further information about these processing options, refer to the Equipment/File Assignment Commands in Volume 3, System Commands.

<u>Parameter</u>	<u>Word (FET+n)</u>	<u>Position</u>	<u>Description</u>
Processing option (po)	10g	47-36	Processing options:

Bit Set
(Contd)

Description

- | | |
|----|--|
| 41 | Do not unload tape at end of usage. |
| 42 | If set, toggles installation default setting of the flag that controls error correction activity in GE (6250 cpi) write mode. (Contact installation personnel to determine the default setting.) The setting selected is returned after tape assignment is complete. If the installation default is 0 (allow error correction) and the user program does not toggle it or if the installation default is 1 (disable error correction) and the user program toggles it, a value of 0 is returned, indicating that hardware error correction is enabled. In this mode of operation, the system allows certain types of single-track errors to be written that can be corrected when the tape is read (on-the-fly correction). This is the recommended setting because it provides efficient throughput, error recovery, and tape usage when writing GE tapes on media that are suitable for use at 3200 fci or 6250 cpi. If the installation default is 1 and the user program does not toggle it, or if the installation default is 0 and the user program toggles it, a value of 1 is returned, indicating that hardware error correction is disabled. The system invokes standard error recovery processing when an on-the-fly error occurs when writing a GE tape, thereby reducing the amount of data that can be stored on the tape. |

<u>Parameter</u>	<u>Word (FET+n)</u>	<u>Position</u>	<u>Description</u>
Processing option (po)	10g	47-36	Processing options:
			<u>Bit Set (Contd)</u>
			<u>Description</u>
			42 Only tape that is suitable for recording at 6250 cpi should be used when this mode of operation is in effect. Refer to processing options G and H in Volume 3, System Commands, for further information.
			43 If set, toggles installation default setting of the flag that controls the issuing of tape detailed status error messages to the user control point dayfile. (Contact installation personnel to determine the default setting.) The setting selected is returned after the tape assignment is complete. If the installation default for the setting is 1 (issue a message to the user dayfile for both the first and the last attempt to read or write a bad tape block) and the user program does not toggle it, or if the installation default for the setting is 0 (do not issue the detailed status messages to user dayfile) and the user program toggles it, a value of 1 is returned, indicating that a message is to be issued to the user control point dayfile for both the first and the last attempt to read or write a bad tape block. If the installation default for the setting is 0 and the user program does not toggle it, or if the installation default for the setting is 1 and the user program toggles it, a value of 0 is returned, indicating that no tape detailed status error messages are issued to the user dayfile.
			44 Not used.

<u>Parameter</u>	<u>Word (FET+n)</u>	<u>Position</u>	<u>Description</u>																												
Processing option (po)	10 _g	47-36	Processing options: <table border="1"> <thead> <tr> <th><u>Bit Set (Contd)</u></th> <th colspan="3"><u>Description</u></th> </tr> </thead> <tbody> <tr> <td>47-45</td> <td colspan="3">These bits define the end-of-tape/end-of-reel conditions and are defined as follows:</td> </tr> <tr> <td></td> <td><u>Bit 47</u></td> <td><u>Bit 46</u></td> <td><u>Bit 45</u> <u>Option †</u></td> </tr> <tr> <td></td> <td>0</td> <td>0</td> <td>1 3</td> </tr> <tr> <td></td> <td>0</td> <td>1</td> <td>0 2</td> </tr> <tr> <td></td> <td>1</td> <td>0</td> <td>0 1</td> </tr> <tr> <td></td> <td>0</td> <td>0</td> <td>0 Default option selected according to format</td> </tr> </tbody> </table> <p>All other combinations are illegal.</p>	<u>Bit Set (Contd)</u>	<u>Description</u>			47-45	These bits define the end-of-tape/end-of-reel conditions and are defined as follows:				<u>Bit 47</u>	<u>Bit 46</u>	<u>Bit 45</u> <u>Option †</u>		0	0	1 3		0	1	0 2		1	0	0 1		0	0	0 Default option selected according to format
<u>Bit Set (Contd)</u>	<u>Description</u>																														
47-45	These bits define the end-of-tape/end-of-reel conditions and are defined as follows:																														
	<u>Bit 47</u>	<u>Bit 46</u>	<u>Bit 45</u> <u>Option †</u>																												
	0	0	1 3																												
	0	1	0 2																												
	1	0	0 1																												
	0	0	0 Default option selected according to format																												
Data format (f)	10 _g	35-30	Data format (refer to tape data formats in Volume 3, System Commands): <table border="1"> <thead> <tr> <th><u>Value</u></th> <th><u>Data Format †</u></th> </tr> </thead> <tbody> <tr> <td>0</td> <td>I</td> </tr> <tr> <td>1</td> <td>SI</td> </tr> <tr> <td>2</td> <td>F</td> </tr> <tr> <td>3</td> <td>S</td> </tr> <tr> <td>4</td> <td>L</td> </tr> </tbody> </table>	<u>Value</u>	<u>Data Format †</u>	0	I	1	SI	2	F	3	S	4	L																
<u>Value</u>	<u>Data Format †</u>																														
0	I																														
1	SI																														
2	F																														
3	S																														
4	L																														
Noise	10 _g	29-24	Noise size in frames; any block containing fewer than the specified number of frames is considered noise and is discarded by the system (refer to appendix J). A noise specification of zero causes the default noise size to be used.																												
Block size (PRU size)	10 _g	23-0	Maximum block size in frames (refer to appendix J).																												
Volume serial number	11 _g	59-24	One to six display code characters, left-justified with blank fill, that uniquely identify a reel of tape (refer to ANSI Tape Label Formats, Volume 1 Label, and VSN Command in Volume 3, System Commands). For a VSN of SCRATCH, specify a value of all blanks.																												

† For further information, refer to options 1 through 3 described in End-of-Tape/End-of-Reel Conditions, appendix J.

<u>Parameter</u>	<u>Word (FET+n)</u>	<u>Position</u>	<u>Description</u>
File accessibility (fa)	11g	23-18	One display code character indicating who may access the tape file.†
File section number	11g	14-0	Fifteen-bit binary file section number.†
File identifier	12g	59-0	File identifier (first 10 display code characters, left-justified with blank fill).†
File identifier	13g	59-18	File identifier (last seven display code characters, left-justified with blank fill).†
File sequence number	13g	14-0	Fifteen-bit binary file sequence number.†
Set identifier	14g	59-24	Six display code characters specifying the multiple set identifier, left-justified with blank fill.†
Generation version number (gvn)	14g	23-15	Nine-bit binary generation version number.†
Generation number	14g	14-0	Fifteen-bit binary generation number.†
Expiration date	15g	59-30	Five display code characters specifying the expiration date.
Creation date	15g	29-0	Creation date (two-digit numeric display code value for the year followed by a three-digit numeric display code value for the day within the year).

The specified file is assigned to tape automatically if the volume serial number is specified either in FET+11g or in a VSN command. If the VSN in FET+11g is zero and no VSN command for the file was included, the system requests the operator to assign a unit.

If dt in FET+1 is MT or NT, a tape unit must be assigned; no other specification is allowed. However, if dt is zero, the operator can assign any device and the user must be validated for this device. If the operator assigns a tape equipment when dt is zero, only a nine-track unit is accepted if the track bit, density, or conversion mode implies nine-track, and only a seven-track tape unit is accepted if the density implies seven-track; otherwise, either a seven- or nine-track tape unit can be assigned.

If the access level bit (bit 39) is set in FET+1, the access level in FET+4 is assigned to the file. On a secured system, the tape must be mounted on a unit that supports this level.

For ANSI labeled tapes, FET+11g through FET+15g contain the values LABEL uses to process HDR1 labels.

†Refer to appendix J.

Macro format:

Location	Operation	Variable
	LABEL	addr

addr Address of the FET.

If a local file with the specified file name already exists (other than a VSN entry for the file), no assignment is made and job processing continues. An OPEN or POSMF is not performed to reposition an existing tape file. To assign the file to tape, the user program should return the existing file to the system before issuing the LABEL request.

If the file is to be used for checkpoint dumps, the checkpoint mode can be specified in FET+7, bits 59 through 56. Refer to the format of FET+7 in the REQUEST macro (function 014).

Example:

The following example assigns a file to magnetic tape. The program performs the same function in assigning the tape as the following command.

```
LABEL,TAPE1,VSN=NOSVSN,PO=R,D=HY,F=I.
```

The tape is seven-track, 800 cpi, I format. The program reads file TAPE1.

```

      .
      .
      .
BUFL   EQU   3001B
FET     BSS   0
TAPE1  FILEB BUF,BUFL,LBL
        ORG   FET+8
FET8    VFD   6/20B,3/3,3/0,12/10B,6/0,6/0,24/1000B
FET9    VFD   36/DHNOSVSN,24/0
        VFD   60/0
        VFD   60/0
        VFD   60/0
        VFD   60/0
BUF     BSS   BUFL
      .
      .
      LABEL FET
      .
      .
      READ  FET
      .
      .

```

GETFNT (025)

The GETFNT macro generates a table of entries for local files based on the files' local file name table (FNT) entries.

NOS supports two formats of the GETFNT macro. The format is selected by the setting of bit 21, FET+10g. Format A is selected by setting bit 21 to zero; format B is selected by setting bit 21 to one.

Format A allows the user program to optionally specify that file status table (FST) information is to be converted to the current current random index or the file length for mass storage files, or to the block number for tape files. Format B provides all of the information that is optional in format A.

Format A returns a table of limited length; this length is specified in FET+10g. Format B fills a buffer whose length is specified in FET+10g with a number of entries, and allows the user program to issue a continuation macro call to obtain further entries.

NOTE

You are encouraged to use format B for all new programs and to convert existing programs to format B. Format A will not be supported in future NOS releases.

Macro format:†

<u>Location</u>	<u>Operation</u>	<u>Variable</u>
	GETFNT	addr

addr Address of the FET.

GETFNT obtains its input parameters from FET+10g, in the following format.

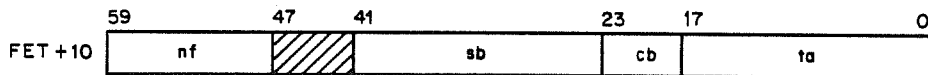

nf Maximum number of two-word entries to be returned to table. For format A, table size must be at least (nf*2+1) words; for format B, table size must be at least (nf*2+2) words. Default is 200g entries.

sb File type selection bits. A bit set to one implies the corresponding file type is selected for entry into the table. All bits set to zero indicates selection of all file types. Bit positions and corresponding file types are as follows:

<u>Bit</u>	<u>File Type††</u>	<u>Description</u>
41	--	Unused.
37	LOFT	Local.
36	SYFT	System.
35	FAFT	Fast attach file.
34	PMFT	Direct access permanent file.
33	PTFT	Primary terminal.
32	LIFT	Library.
31	--	Reserved.
30	--	Reserved.
29	QFFT	Queued file.
28	TEFT	Timed/event rollout.
27	PHQT	Punch queued file.
26	PRQT	Print queued file.
25	ROFT	Rollout.
24	INFT	Input.

†This macro is not available in SYSTEXT. The user program must specify systems text PSSTEXT or call common deck COMCMAC (refer to appendix F).

††File types are explained in appendix E.

cb Control bits:

<u>Bit(s)</u>	<u>Significance</u>
23-22	Unused.
21	If bit 21 is set, format B is returned; otherwise, format A is returned. Bits 18 and 19 are ignored if this bit is set.
20	If bit 20 is set, checkpoint file entries are returned to the table (FET length must be at least 118 words). If bit 20 is not set (0), the FNT words of checkpoint file entries are returned in FET+118, instead of the table (FET length must be at least 158 words).
19	If bit 19 is set, mass storage file FST entries are modified with file lengths in bytes 2 and 3. If bit 19 is not set, the FST entry is modified with random index in bytes 2 and 3. Bit 18 must be 0 or bit 19 is ignored. Bit 19 is ignored if bit 21 is set.
18	If bit 18 is set, no modifications are made on the FST words of the entries. If bit 18 is not set, pertinent modifications are made (such as the block number for tape files or that specified by bit 19 for mass storage files). Bit 18 is ignored if bit 21 is set.

ta Address of table.

The format A table has the following format.

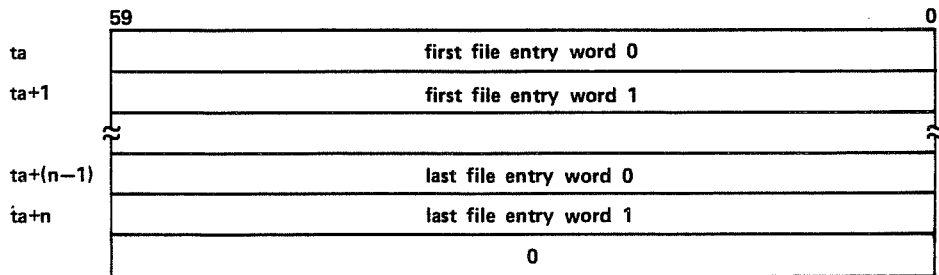

Each format A file entry has the following format.

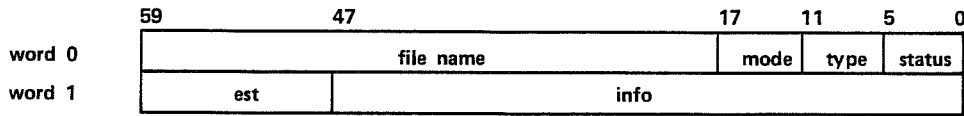

mode Mode of use allowed for the file.

<u>Bit(s)</u>	<u>Description</u>
17	Not used.
16	Set if extend-only file.
15	Set if alter-only file.
14	Set if execute-only file.
13	Not used.
12	Set if write lockout is present.

The file permission mode in which the file was attached is represented by the values of bits 16, 15, 14, and 12, as follows:

<u>Mode</u>	<u>Bits Set</u>
Write	None
Read	12
Append	16
Execute	14, 12
Modify	16, 15
Read, allow modify	16, 15, 12
Read, allow append	16, 12
Update	15
Read, allow update	15, 12

type File type.

<u>Value (Octal)</u>	<u>Description</u>
7	Rollout.
10	Library.
11	Primary terminal.
12	Direct access permanent file.
13	Fast attach.
14	System.
15	Local.
16	Reserved.
17	Input.
20	Queued file.

status Status of file.

<u>Value</u>	<u>Description</u>
0	Auto drop status.
1	User file privacy status.
2	Special system jobfile status.
3	CB checkpoint file status.
4	CK checkpoint file status.
5	Special output file status.
6	Application accounting status.
7	No auto drop status.

est Equipment status table (EST) ordinal to which file is assigned.

info For tape files (bit 18 of FET+10₈ not set):

<u>Bit(s)</u>	<u>Description</u>
47-36	MT (display code).
35-12	block count.

For tape files (bit 18 of FET+10₈ set):

<u>Bit(s)</u>	<u>Description</u>
47-36	UDT address assignment type.
35-32	Data format.

<u>Value</u>	<u>Format</u>
0	I
1	SI
2	F
3	S
4	L

31-30	Reserved.
29-12	Random address of resource file.
11-0	Zero.

For terminal files:

<u>Bit(s)</u>	<u>Description</u>
47-36	TT (display code).
35-0	Zero.

For mass storage files (bit 19 of FET+10₈ set):

<u>Bit(s)</u>	<u>Description</u>
47-36	Zero.
35-12	Current random index.
11-9	Zero.
8	If set, file is an inaccessible device.
7-0	Zero.

For mass storage files (bit 19 of FET+10₈ not set):

<u>Bit(s)</u>	<u>Description</u>
47-36	Zero.
35-12	File length in sectors.
11-9	Zero.
8	If set, file is an inaccessible device.
7-0	Zero.

The format B table has the following format.

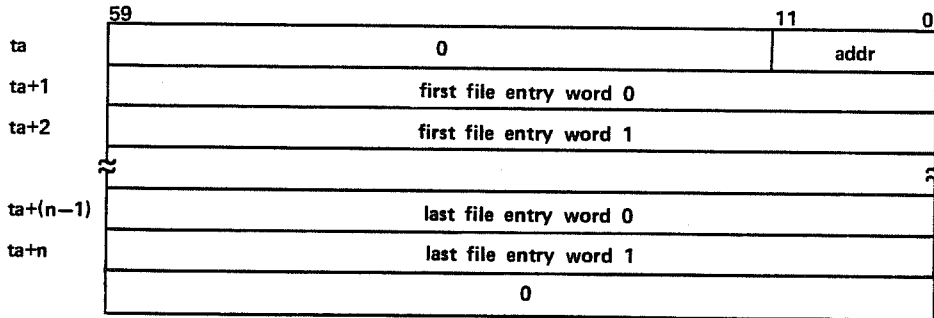

addr Relative address of the next entry in the local FNT. addr is 0 if the entire FNT has been returned.

Each format B file entry has the following format.

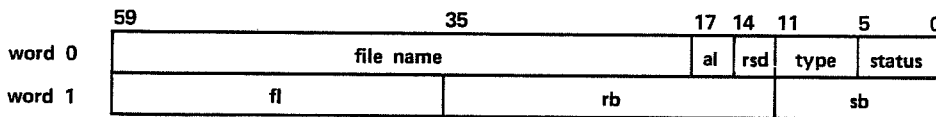

al Access level (bits 17-15).

rsd Residence (bits 14-12).

<u>Bit(s)</u>	<u>Description</u>
14-13	File residence.

<u>Value</u>	<u>Description</u>
0	Mass storage.
1	Tape.
2	TTY.
3	Other.

12 Set if write lockout is present.

type File type (bits 11-6).

<u>Value (Octal)</u>	<u>Description</u>
7	Rollout.
10	Library.
11	Primary terminal.
12	Direct access permanent file.
13	Fast attach.
14	System.
15	Local.
16	Reserved.
17	Input.
20	Queued file.

status Status of the file (bits 5-0).

<u>Value</u>	<u>Description</u>
0	Auto drop status.
1	User file privacy status.
2	Special system jobfile status.
3	CB checkpoint file status.
4	CK checkpoint file status.
5	Special output file status.
6	Application accounting status.
7	No auto drop status.

fl File length in sectors (mass storage files only; zero for other files).

rb Random index (mass storage files), or block count (tape files). Zero for other files.

sb Status bits:

<u>Bit(s)</u>	<u>Description</u>
11-9	Reserved.
8	If set, file is on an inaccessible device.
7-4	Mode of use allowed for the file.

<u>Value (Octal)</u>	<u>Description†</u>
0	Read.
1	Write.
2	Modify.
3	Append.
4	Execute.
5	Read (allow modify).
6	Read (allow append).
7	Update.
10	Read (allow update).
11-17	Reserved.

3-1 Read status (mass storage files only):

<u>Value</u>	<u>Description</u>
0	Incomplete word.
1	EOR.
2	EOF.
3	EOI.
4	BOI.

0 Set if last operation was a write.

†Refer to PFM Macro Parameter Conventions in section 5.

Upon return from GETFNT, the FET is as follows:

	59	0
FET +10	ia	
+11	cfnt	
+12	cfst	
+13	acfnt	
+14	acfst	

- ia ia is less than zero if an error is encountered (bit 18 of FET+10₈ not set).
- cfnt FNT word of the checkpoint file; cfnt is zero if there is no checkpoint file; less than zero if more than two checkpoint files encountered (bit 20 of FET+10₈ not set).
- cfst FST word of the checkpoint file.
- acfnt FNT word of the alternate checkpoint file; acfnt is zero if there is no alternate checkpoint file.
- acfst FST word of the alternate checkpoint file.

The following program example illustrates format B of the GETFNT macro (bit 21 of FET+10₈ set). This example returns three entries each time GETFNT is issued. A continuation call is issued if the addr field of the reply table is not zero, indicating that there are more local FNT entries to be returned.

```

BUFL        EQU    2001B                    BUFFER LENGTH
FET        BSS    0                        FET FOR FILE1
FILE1      FILEB  BUF,BUFL,(FET=13)
BUF        BSS    BUFL                    BUFFER
FET10B     VFD    12/3,6/,18/,6/8,18/TADDR  SELECT 3 ENTRIES PER REPLY, ALL FILE
                                          TYPES, AND FORMAT B

TADDR      BSSZ   7
           .
           .
START      SA1    FET10B
           BX6    X1                      ENTER VALUES IN FET+10B
           SA6    FET+10B
CALL       GETFNT FET                      DUMP REPLY TABLE
           SYSTEM DMD,TADDR+6,TADDR       DUMP FET
           SYSTEM DMD,FET+12,FET
           SA1    TADDR
           NZ     X1,CALL                  ISSUE CONTINUATION CALL IF ADDR
           .                               IN FIRST WORD OF TABLE .NE. ZERO
           .

```

PRIMARY (031)

The PRIMARY macro enables the user program to create or change a primary file (refer to Volume 2, Guide to System Usage, for a description of primary files). The current primary file (if any) is changed to a local (LOFT) file and the local mass storage file specified in FET+0 is made the primary file. If the specified file does not exist, an empty primary file is created.

Macro format:†

<u>Location</u>	<u>Operation</u>	<u>Variable</u>
	PRIMARY	addr

addr Address of the FET for the new primary file.

FILINFO (032)

The FILINFO macro returns information about a file to a specified reply block.

Macro format:

<u>Location</u>	<u>Operation</u>	<u>Variable</u>
	FILINFO	addr

addr Address of a five-word reply block.

Before the FILINFO macro is issued, the first word of the reply block must contain the following:

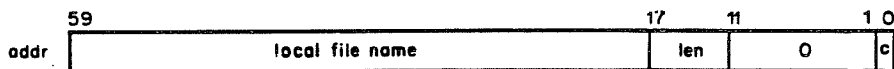

c Completion bit. This bit must be set by the user program before the macro call.

len Length of parameter block (at least five words).

†This macro is not available in SYSTEXT. The user program must specify systems text PSSTEXT or call common deck COMCMAC (refer to appendix F).

The standard reply block returned has the following format.

	59	47	35	29	17	11	5	0
addr + 0	local file name (lfn)					len	0	c
+ 1	dt	status					ft	
+ 2	EST ordinal	0						
+ 3	file length in sectors	0	current random address			0		
+ 4	reserved							

NOTE

If the specified file is not local to your job, words 1 through 4 of the parameter block are cleared. All other fields (including fields in words containing keys) are unchanged.

- c Completion bit (set when operation is complete).
 - dt The 12-bit display code of the type of device on which the file resides (refer to appendix E).
- If a file is opened but not written on and it is a mass storage file that has not been allocated tracks on a specific allocatable device, the device mnemonic is binary 0.

status

Status bits:

<u>Bit(s)</u>	<u>Description</u>
47-24	Reserved.†
23	File at EOI.†
22	File at EOF.†
21	File at BOI.†
20	Labeled tape file.
19	Nine-track tape file.
18	Seven-track tape file.
17	File open; if set, indicates a CIO OPEN function has been issued on the file without a subsequent CLOSE function.
16	File assigned to interactive terminal.
15	File on mass storage.
14	If set, file is on an inaccessible device.
13	Reserved.
12	File may be executed.
11	File in read/allow append mode (or read/allow modify mode).
10	File in read/allow update mode (or read/allow modify mode).
9	File may be altered (update, modify, or write mode).
8	File may be extended (append, modify, or write mode).
7	File may be shortened (write mode).
6	File may be read.

† File position is returned for mass storage files only. EOF status is returned if the last operation was a read, and EOF was encountered.

ft File type in one of the following octal values:

<u>File Type</u>	<u>Value</u>
Local	0
Input	1
Queued	2
(Reserved)	3
Direct access	4
(Reserved)	5
Primary	6
Library	7
Other	77

For mass storage files, bits 6 through 12 of the status field are set, depending on the file permission mode in the file's local FNT entry. For other files, only the write lockout bit in the file name table is checked. If the write lockout bit is set, read-only permission is assumed. If the write lockout bit is not set, read and write permission is set. Bits 8 through 12 apply only to mass storage files. If the following permission mode is set in the file's local FNT entry, the indicated bits are set in the status field.

<u>FNT Mode</u>	<u>Status Bits Set</u>
Read	6, 12
Write	6, 7, 8, 9, 12
Update	6, 9, 12
Append	6, 8, 12
Modify	6, 8, 9, 12
Read/allow modify	6, 10, 11, 12
Read/allow append	6, 11, 12
Read/allow update	6, 10, 12
Execute	12

For example, if read mode is set in the FNT, the user program can read (bit 6 set) or execute (bit 12 set) the file.

Word 4 (addr+4) of the reply block is currently not used; however, it is reserved for future expansion of the FILINFO macro.

The FILINFO macro optionally returns additional information for tape files. If the length (len field in addr+0) of the FILINFO reply block is greater than five, tape file information is returned corresponding to key values in each word after addr+4. The key words begin at addr+5 of the reply block and can be in any order. Keys are set by the user program in bits 4 through 0 of each key word and are returned unaltered after the request is processed. Bit 5 of the key word is set, and data fields are zeroed on return if the key is unknown to the system or is not applicable to the file type specified in addr+1. Key words with zero keys are ignored.

The following keys return the corresponding key words. Except where otherwise indicated in the descriptions, the values returned are those supplied in the ASSIGN, LABEL, or REQUEST function, and may not equal the values actually assigned to the tape file.

Key†	Returned Key Word for Tape File												
1	<table border="1"> <tr> <td style="text-align: right;">59</td> <td style="text-align: right;">11</td> <td style="text-align: right;">5</td> <td style="text-align: right;">0</td> </tr> <tr> <td style="text-align: center;">0</td> <td style="text-align: center;">f</td> <td style="text-align: center;">1</td> <td></td> </tr> </table>	59	11	5	0	0	f	1					
59	11	5	0										
0	f	1											
2	<table border="1"> <tr> <td style="text-align: right;">59</td> <td style="text-align: right;">17</td> <td style="text-align: right;">11</td> <td style="text-align: right;">8</td> <td style="text-align: right;">5</td> <td style="text-align: right;">0</td> </tr> <tr> <td style="text-align: center;">0</td> <td style="text-align: center;">e</td> <td style="text-align: center;">ltype</td> <td style="text-align: center;">den</td> <td style="text-align: center;">cv</td> <td style="text-align: center;">2</td> </tr> </table>	59	17	11	8	5	0	0	e	ltype	den	cv	2
59	17	11	8	5	0								
0	e	ltype	den	cv	2								
4	<table border="1"> <tr> <td style="text-align: right;">59</td> <td style="text-align: right;">23</td> <td style="text-align: right;">11</td> <td style="text-align: right;">5</td> <td style="text-align: right;">0</td> </tr> <tr> <td style="text-align: center;">vsr</td> <td style="text-align: center;">reel</td> <td style="text-align: center;">0</td> <td style="text-align: center;">4</td> <td></td> </tr> </table>	59	23	11	5	0	vsr	reel	0	4			
59	23	11	5	0									
vsr	reel	0	4										
148	<table border="1"> <tr> <td style="text-align: right;">59</td> <td style="text-align: right;">47</td> <td style="text-align: right;">23</td> <td style="text-align: right;">11</td> <td style="text-align: right;">5</td> <td style="text-align: right;">0</td> </tr> <tr> <td style="text-align: center;">0</td> <td style="text-align: center;">block size</td> <td style="text-align: center;">po</td> <td style="text-align: center;">noise</td> <td style="text-align: center;">14</td> <td></td> </tr> </table>	59	47	23	11	5	0	0	block size	po	noise	14	
59	47	23	11	5	0								
0	block size	po	noise	14									

The following key word is returned for all file types.

59	36	35	11	5
0	val	al	15	

Field	Key	Bit(s)	Description
f	1	11-6	Tape format: 0 Internal (I). 1 System internal (SI). 2 Foreign (F). 3 Stranger (S). 4 Long block stranger (L).
e	2	18	If set, error processing is inhibited (same as bit 14 in po field).
ltype	2	17-12	Label type: 0 Unlabeled. 1 Standard label (ANSI 1969 standard). 148 Nonstandard label.
den	2	11-9	Tape density: (Requested density for tapes assigned in write mode; actual density for tapes in read mode.) 1 556 cpi (seven-track). 2 200 cpi (seven-track). 3 800 cpi (seven-track) or 800 cpi (nine-track). 4 1600 cpi (nine-track). 5 6250 cpi (nine-track).

†The symbols for each key value are defined in common deck COMSLFM.

<u>Field</u>	<u>Key</u>	<u>Bit(s)</u>	<u>Description</u>
cv	2	8-6	Conversion mode: † 0 BCD conversion (seven-track). 1 ASCII conversion (nine-track). 2 EBCDIC conversion (nine-track).
vsn	4	59-24	Volume serial number of the currently mounted magnetic tape. This is the actual VSN, not the value from the VSN or LABEL command.
reel	4	23-12	Logical reel number of the currently mounted magnetic tape. Corresponds to the ANSI standard file section number.
block size	14 ₈	47-24	Maximum block size in central memory words. Always 1000 octal for I and SI format tapes. For F format tapes, the block size is calculated from the FC or C parameter value specified on the tape assignment command (refer to Volume 3, System Commands). For S and L format tapes, the block size returned is the size used on the last CIO operation, as determined from the default block size, mlrs field in the FET, or CIO buffer size (refer to appendix J). The field is zero if no previous CIO function has been issued on the tape file. Refer to appendix J for further information.
po	14 ₈	23-12	Processing options. Refer to the description of the po field for the LABEL macro in section 4. The 12 bits in each field have the same respective definitions. If po bit 18 (corresponding to po bit 42 for the LABEL macro) is set upon return from the FILINFO macro, GCR hardware write error correction is disabled. If po bit 19 (corresponding to bit 43 for the LABEL macro) is set upon return from the FILINFO macro, the issuing of all error recovery messages to the user dayfile is enabled.
noise	14 ₈	11-6	Noise size in frames.
val	15 ₈	35-12	Maximum size of a direct access file, based on the file owner's limits from the validation file. If the file is not a direct access file, zero is returned. If the file owner has unlimited direct access file size validation, 7777777 ₈ is returned.
al	15 ₈	11-6	Access level of the file.

† Conversion mode of labels (if any) and coded data (if any). This does not indicate whether the data on the tape is coded or binary.

PERMANENT FILE MANAGER

Permanent file manager (PFM) processes all permanent file requests. The format of the RA+1 call to PFM is as follows:

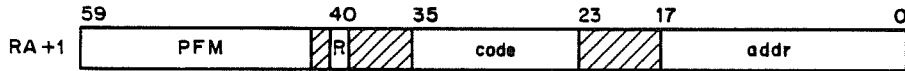

- R Auto recall bit.
- code Function code.
- addr Address of the FET.

The FET used by all PFM requests is formatted as follows. The mnemonics (CFSN, for example) are defined in common deck COMSPFM. The length of the FET is defined by the symbol CFLM.

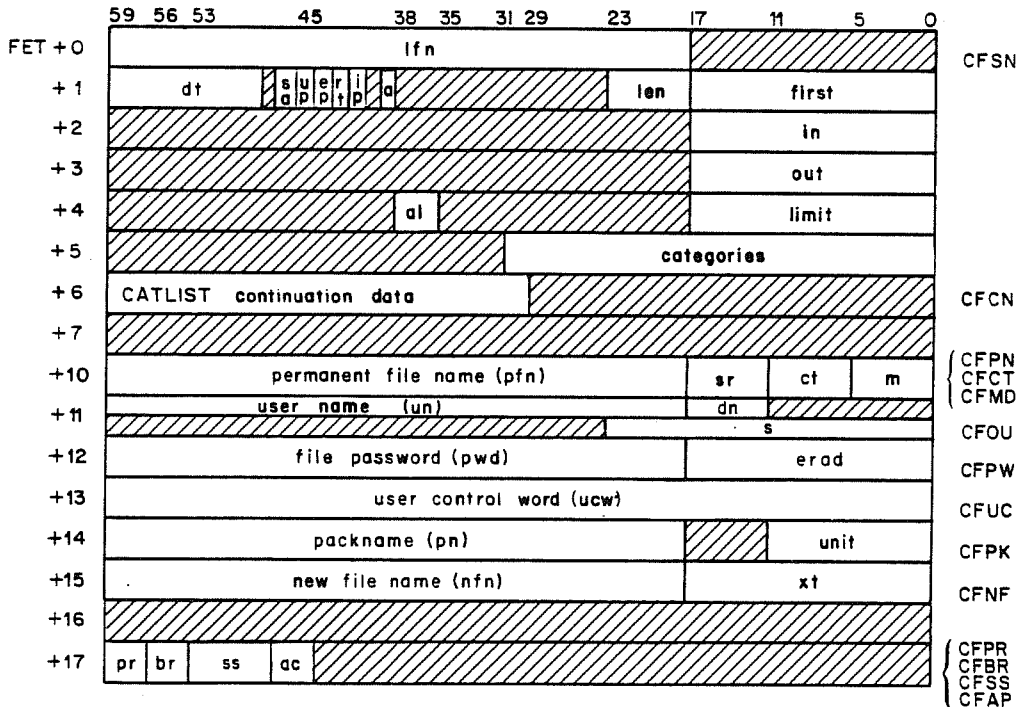

- lfn Local file name (left-justified, zero fill).
- dt Device type.
- sa Suppress address on error messages (bit 46).
- up User processing bit (bit 45).
- ep Error processing bit (bit 44).

rt	Real-time processing bit (bit 43).
ip	Interlock processing bit (bit 42).
a	Access level processing bit (bit 39).
len	FET length minus 5.
first	FIRST parameter for file's circular buffer.
in	IN parameter for file's circular buffer.
out	OUT parameter for file's circular buffer.
al	Security access level.
limit	LIMIT parameter for file's circular buffer.
categories	Security access category set (refer to SETPFAC macro).
pfm	Permanent file name (left-justified, zero fill); if pfm is zero, lfn is used as the permanent file name.
sr	Special request subfunction.
ct	File category (refer to Permission Modes, File Categories).
m	File access mode (refer to Permission Modes, File Categories).
un	Alternate user name.
dn	Device number for CATLIST option (range is 1 to 77g).
s	Number of PRUs (octal) desired for the file.
pwd	Optional file password (left-justified, zero fill).
erad	Error message return address.
ucw	User control word.
pn	Pack name of auxiliary device.
unit	Number of units of multiunit device.
nfn	New file name (refer to CHANGE macro).
xt	Expiration term or date for password or permit.
pr	Preferred residence for file (bits 59-57).
br	Backup requirement for file (bits 56-54).
ss	Interactive subsystem associated with file (bits 53-48).
ac	Alternate user CATLIST permission (bits 47-46).

For a more detailed description of the FET, refer to the discussion of the FET in section 2.

After a request to PFM is complete, the first word of the FET contains the following information.



lfn Local file name.

at Abnormal termination code.

c Bit 0 is set to 1 upon completion of the request.

The FET length may be five words, if no special options are required, or up to 208 words, depending on the special options required.

When a PFM macro request is processed, the parameter values specified are placed in their corresponding fields in the FET.

On a macro call, the register X1 may be used to specify the permanent file name (pfn); the register X2 may be used to specify the file password (pwd); and the register X3 may be used to specify the alternate user name (un). After the macro is processed, the register X2 contains the address of the FET.

The address of the FET must be supplied in the addr parameter. The call to PFM must be made with the auto recall bit set (the PFM macros automatically do this).

The system OPL common decks required for an absolute assembly of a program containing PFM requests are COMCPFM and COMCSYS. In order to use the mnemonics defined for PFM FET addresses, PFM addresses, permission modes, file categories, or error codes, the system OPL common deck COMSPFM is required for absolute or relocatable assemblies. Function mnemonics are specified in the macro descriptions. If the al parameter is specified on a SAVE, DEFINE, or SETPFAL macro, the system OPL common deck COMSMLS is required.

On a secured system, your job may not access a permanent file unless it is validated for the access level and access category set of the file. For an alternate-user access, such an invalid access attempt is treated as a file-not-found error; for an access to one of your own files, it is treated as a security conflict (refer to section 1 for a description of security conflict processing).

In addition, on a secured system your job may not make certain requests to change or access information in the Permanent File Catalog (PFC) entry. The following rules are enforced:

- CHANGE, PERMIT, and SETPFAC requests are not allowed on files with an access level lower than that of the job.
- CATLIST requests for permit information are not allowed on files with an access level higher than that of the job. Normal CATLIST requests are allowed, but the password expiration date, access category set, and user control word fields are cleared before the information is returned. If a password exists, it is returned as seven asterisks (*****).

ALTERNATE USER ACCESS PROCESSING

Another user can access one of your permanent files only if you explicitly allow it. There are two ways you can allow alternate user access:

- By declaring the file to be a public or semiprivate file. These types of files may be accessed by all users in your family. The users may access only the file in the mode you specify, and in those modes that are subsets of the specified mode. Refer to PFM Macro Parameter Conventions in this section for a description of the hierarchy of file access modes.
- By permitting a specific user to access the file with a particular access mode (by using the PERMIT command or macro). This may be done on a private or semiprivate file. On a semiprivate file, the access mode specified by PERMIT overrides the default semiprivate access mode for the file. An expiration date may be assigned to each permit entry. When this date is reached, the specified user is no longer able to access the file.

In addition, you may assign a password to each of your files. An alternate user must specify this password in order to access the file. This password may also have an expiration date. When this date is reached, alternate users are no longer able to access the file.

ERROR PROCESSING

The user program can issue requests to PFM and have control returned if certain error conditions occur. To do this, the error processing bit (ep) must be specified in FET+1. The error codes are returned in the abnormal termination (at) code field of FET+0 (bits 17 through 10).

If the user program also specifies erad in FET+12g, the error message is returned at this address instead of being issued to the user's dayfile. A maximum of five central memory words are returned. System errors are issued to the system and error log dayfiles regardless of the erad specification.

When a PFM error message is issued to the dayfile, PFM normally appends the address of the FET to the message. This produces a message of the form

```
FILE NOT FOUND, AT 000130
```

If the sa bit is specified (suppress address on error message, bit 46 of FET+1), the FET address is not added to the message. The result is the message

```
FILE NOT FOUND
```

Some PFM errors represent transient error conditions rather than true errors. When a transient error condition occurs, PFM retries the request until the transient error condition goes away. If the error goes away, the calling program never discovers that the error condition occurred - the PFM request simply takes more time to complete.

However, some programs, especially those with real-time performance requirements, may be designed to receive an error status from PFM when a transient error condition occurs. This allows the program to perform useful work while waiting for the error condition to go away, and also allows it to abandon the request after a certain number of retries.

For such specialized processing of transient error conditions, there are three bits you may set in the FET that affect PFM error processing:

- Interlock processing (ip), bit 42 of FET+1.
- Real time (rt), bit 43 of FET+1.
- User error processing (up), bit 45 of FET+1.

These bits perform a similar function in that they allow the calling program to receive status for a set of PFM errors. But each bit affects a different set of PFM errors. You may specify any or all of these bits in addition to the ep bit. If one of these bits is specified, and PFM returns an error code indicating a transient error condition, the calling program must retry the PFM request until it is successful. These bits are described below.

- ip When specified along with the ep bit, the ip bit allows the calling program to receive status for the following errors: INA (Interlock Not Available), PEA (PFM Excess Activity), PFN (Device Unavailable), and WNF (Waiting for NFL).
- rt When specified along with the ep bit, the rt bit allows the calling program to receive status for the following errors: FIN (File Interlocked), PFA (PF Utility Active), and PSI (Stage Initiated).
- up When specified along with the ep bit, the up bit allows the calling program to receive status for the following errors: FIN (File Interlocked), PFA (PF Utility Active), PFN (Device Unavailable), PSI (Stage Initiated), PWE (Waiting for Alternate Storage Exec), and WNF (Waiting for NFL). In addition, if the calling job is a subsystem, the up bit allows the calling program to receive status for the following errors: INA (Interlock Not Available) and PEA (PFM Excess Activity).

The following error codes are returned in the abnormal termination code field, described earlier in this chapter. It is recommended that the error code mnemonics defined in common deck COMSPFM be used in testing these error conditions. The mnemonics are qualified by symbol ERRMSG. For example, to set the B7 register to the value of the FBS mnemonic, use the following instruction:

```
SB7 /ERRMSG/FBS
```

NOTE

The error codes listed next are given in octal.

<u>Error Code</u>	<u>Mnemonic</u>	<u>Description</u>
1	FBS	The specified direct access file is attached with conflicting mode (file busy).
2	FNF	One of the following: <ul style="list-style-type: none">• The specified permanent file was not found.• The specified user name was not found.• You are not authorized to access the specified file.

<u>Error Code</u>	<u>Mnemonic</u>	<u>Description</u>
		<ul style="list-style-type: none"> ● The specified local file was not found (SAVE, REPLACE, or APPEND). ● An indirect access file request was issued for a direct access file. ● A direct access file request was issued for an indirect access file.
3	EFL	The file specified on a SAVE, REPLACE, or APPEND macro contains no data.
4	NMS	The file to be saved is not on mass storage. The first track of the file is not recognizable.
5	FAP	The user program has already saved or defined a file with the name specified.
6	IFT	The user program attempted to define a file that is not a local file.
7	FNE	File name contains illegal characters.
10	IUA	One of the following: <ul style="list-style-type: none"> ● You are not validated to create direct access files. ● You are not validated to create indirect access files. ● You are not validated to access auxiliary devices. ● The user program made a CATLIST request for permanent information on a file that has a higher access level than that of the job.
11	IDR	The device type (r parameter in macro calls) specified on a request for an auxiliary device cannot be recognized or does not exist in the system. If the removable auxiliary device specified by the pn parameter is not the same type as the system default, the r parameter must be included. If not, this error code is returned.
12	FTL	The local file specified for a SAVE, REPLACE, or APPEND request exceeds the length allowed, or the direct access file specified for an ATTACH in write, modify, update, or append mode exceeds the direct access file length limit for which the user is validated.

<u>Error Code</u>	<u>Mnemonic</u>	<u>Description</u>
13	ILR	One of the following: <ul style="list-style-type: none"> ● Illegal permit mode or catalog type specified. ● CATLIST request has permit specified without a file name. ● PERMIT attempted on a public file. ● DEFINE, CHANGE, or SAVE attempted with alternate user name in FET.
14	PFN	Access to the permanent file device requested is not possible. (This error code is returned only if the ip bit and/or the up bit is specified in the FET.)
15	DAD	The device on which the file resides may not contain direct access files because: <ul style="list-style-type: none"> ● The device is not specified as a direct access device in the catalog descriptor table. ● The device is not specified as ON and initialized in the catalog descriptor table. ● The device is a dedicated indirect access permanent file device.
16	PFA	Because a permanent file utility is currently active or a permanent file device is inaccessible, the operation is not attempted. The user program should retry the operation. (This error code is returned only if the rt bit and/or the up bit is specified in the FET.)
17	DTE	An error occurred in a read operation during a file transfer.
20	COF	The number of files in your catalog exceeds the limit (refer to the LIMITS command in Volume 3, System Commands).
21	COS	The cumulative size of the indirect access files in your catalog exceeds the limit (refer to the LIMITS command in Volume 3, System Commands).
22	SPN	The number of PRUs specified via the s parameter on the DEFINE macro is not available.
23	IOE	A request is attempted on a local file that is currently active. This error can occur, for example, if the user program creates two FETs for the same file and issues a second request before the first is complete.
24	--	The job's local file limit has been exceeded by an attempt to GET or ATTACH the file.
25	PRL	The job's mass storage PRU limit is exceeded during preparation of a local copy of an indirect access file.
26	PLE	Permit limit is exceeded for a private file.

<u>Error Code</u>	<u>Mnemonic</u>	<u>Description</u>								
27	PAE	One of the following: <ul style="list-style-type: none"> • An illegal function code was specified. • The FET address specified was not within the user program's field length. • The error message return address specified was not within the user program's field length. • PFM was not called with auto recall specified. 								
30	RSE	The resource executive detected a fatal error.								
31	TKL	No available space remains on the device.								
32	FLE	The length of a file does not equal the catalog length. The action taken depends on the type of request issued.								
		<table border="1"> <thead> <tr> <th><u>Request</u></th> <th><u>Action</u></th> </tr> </thead> <tbody> <tr> <td>GET</td> <td>A local file is created with length being the actual length retrieved.</td> </tr> <tr> <td>SAVE</td> <td>If file length is longer than TRT specification, file is truncated.</td> </tr> <tr> <td>REPLACE</td> <td>Same as for SAVE.</td> </tr> </tbody> </table>	<u>Request</u>	<u>Action</u>	GET	A local file is created with length being the actual length retrieved.	SAVE	If file length is longer than TRT specification, file is truncated.	REPLACE	Same as for SAVE.
<u>Request</u>	<u>Action</u>									
GET	A local file is created with length being the actual length retrieved.									
SAVE	If file length is longer than TRT specification, file is truncated.									
REPLACE	Same as for SAVE.									
33	RIN	PERMIT random address error.								
34	DAF	The system sector data for the file does not match the catalog data.								
35	RPE	The same file is found twice during a catalog search. This error can occur for APPEND or REPLACE requests after a file is found and purged and the catalog search is continued.								
36	ABT	Error flag detected at PFM control point.								
37	MSE	An error is encountered in reading or writing a portion of the permanent file catalog or permit information. A write error is encountered during the device to device transfer of an indirect access file.								
40	EDA	Error in data for file.								
41	EPT	Error in permit entries for file.								
42	EDP	Combination of errors 40 and 41.								
43	FLC	An error in the EOI position of the file was detected by recovery routines.								
44	NEM	PFM detected a fatal RESEX error. PFM does not issue a message since RESEX has issued an appropriate message. If the error processing (ep) bit is set and the erad field of FET+12 ₈ contains a valid address, the message RESEX issues is returned to that address.								
45-47	--	Reserved.								
50	FSE	Verification of the file structure or owner identification failed.								

<u>Error Code</u>	<u>Mnemonic</u>	<u>Description</u>
51	SSE	Error in system sector of indirect access file.
52	BCS	An invalid catalog or permit sector was detected while attempting to access the file.
53-70	--	Reserved.
71	PPE	The file does not reside on disk. An unrecoverable error was detected when attempting to stage the file to disk from alternate storage.
72	PSI	The file does not reside on disk. It is currently being staged from alternate storage to disk. (This error code is returned only if the rt bit and/or the up bit is specified in the FET.)
73	PWE	The file must be staged from alternate storage to disk, but the subsystem is not currently available to perform the stage operation. (This error code is returned only if the up bit is specified in the FET.)
74	FIN	The file is currently not available for write, modify, update, or append modes of access because a system utility has the file attached in utility mode. (This error code is returned only if the rt bit and/or the up bit is specified in the FET.)
75	--	Reserved.
76	--	Reserved.
77	FEO	The local file specified for a SAVE, REPLACE, or APPEND request was an execute-only file.
100	SGD	The file does not reside on disk and must be staged from alternate storage to disk, but your site has disabled staging.
101	IPA	The device number, track, and sector specified as the permanent file catalog (PFC) address are invalid.
102	PVE	The creation date and time, user index, or alternate storage address do not agree with the current PFC contents.
103	FND	Access to a file that does not reside on disk is not permitted with the current function.
104	INA	A software interlock is currently not available. (This error code is returned if the ip bit is specified in the FET. If the calling job is a subsystem, it is also returned if the up bit is specified in the FET.)
105	AIO	The disk space for a file cannot be released when the alternate storage image is labeled obsolete or the alternate storage address is not specified in the PFC.

<u>Error Code</u>	<u>Mnemonic</u>	<u>Description</u>
106	ASE	The disk space for a file cannot be released when a permanent error status is set for the alternate storage file image.
107	FTF	File name table (FNT) space is currently not available for a request that has both ep and up processing options set.
110	ICU	Verification of the PFC prohibits the setting of a new alternate storage address when the alternate storage address is defined and not labeled obsolete. Also, an existing valid disk address cannot be replaced in the PFC entry.
111	PEA	The PFM activity count is currently at its limit. (This error code is returned if the ip bit is specified in the FET. If the calling job is a subsystem, it is also returned if the up bit is specified in the FET.)
112	NVX	You are not authorized to set a password or permit expiration date.
113	DEM	The expiration date or term you specified exceeds the maximum expiration term allowed by your site.
114	JCA	Your job is not validated for the access level or access category set for the specified file.
115	LNJ	The specified access level is not valid for the calling job.
116	WDP	You are not authorized to perform the operation for one of the following reasons: <ul style="list-style-type: none"> • The local file has a higher access level than the permanent file it replaces or to which it is being appended. • The local file has a lower access level than the job on a DEFINE request. • The specified permanent file has an access level lower than that of the job on a CHANGE, PERMIT, or SETPFAC request.
117	CNJ	The specified access category set is not valid for the calling job.
120	LND	The local file access level is incompatible with the user's master device access level limits.
121	NVD	The specified access level is lower than the current file access level, and you are not authorized to lower file access levels.
122	NTD	No temporary device could be found with the correct access level.

<u>Error Code</u>	<u>Mnemonic</u>	<u>Description</u>
123	LNF	The specified access level on a SAVE request is lower than the local file access level.
124	TPE	The system encountered a temporary error that prevents it from moving your file in from alternate storage. Wait and try the request again.
125	WNF	Your job is delayed while waiting for NFL. (This error code is returned only if the ip bit and/or the up bit is specified in the FET.)

PFM MACRO PARAMETER CONVENTIONS

Several methods are available for specifying the m, ct, ss, br, pr, and ac parameters in PFM macros. You can specify either an alphabetical key or an address that contains an integer value that corresponds to a key. If an address is specified, the value must be right-justified and zero-filled in a 60-bit word. (These parameters are stored in the FET in right-justified, zero-fill format, except for the lfn, pfn, pwd, and nfn parameters which are stored in left-justified, zero-fill format.)

The values can be established with the mnemonics in the following list.

NOTE

For a CHANGE request, 40B must be added to the octal value in the following list. The macro does this automatically if you specify an alphabetic key instead of a value for the parameter.

The user program must call common deck COMSPFM to use these mnemonics (relocatable or absolute assembly). The valid mnemonics (if any), keys, and values for the m, ct, ss, br, pr, and ac macro parameters are listed.

<u>Parameter</u>	<u>Mnemonic</u>	<u>Key</u>	<u>Value (Octal)</u>	<u>Description</u>
m				File or user permission mode:
	PTWR	W	0	Allows the user program to write, read, append, execute, modify, and/or purge the file. New information can be added within the existing boundaries of the file, and the file can be extended or shortened. This mode can be specified for direct or indirect access files.
	PTRD	R	1	Allows the user program to read and/or execute the file. This mode can be specified for direct or indirect access files.
	PTAP	A	2	Allows the user program to append information to the end of the file (EOI). This mode can be specified for direct or indirect access files.
	PTEX	E	3	Allows the user program to execute the file. This mode can be specified for direct or indirect access files.

<u>Parameter</u>	<u>Mnemonic</u>	<u>Key</u>	<u>Value †</u> <u>(Octal)</u>	<u>Description</u>
	PTNU	N	4	Removes permission previously granted via PERMIT macros. This mode can be specified for direct or indirect access files.
	PTMD	M	5	Allows the user program to modify, append, read, and/or execute a direct access file. Adding new information within the existing boundaries of the file is legal, and the file size may be extended, but the file may not be shortened. For an indirect access file, this mode allows you to perform all the functions of the R (read) mode and the A (append) mode.
	PTRM	RM ††	6	Allows the user program to read and/or execute a direct access file with the implication that another user may currently be accessing the same file in M (modify), A (append), or U (update) mode. For indirect access files, this mode is the same as R (read) mode.
	PTRA	RA ††	7	Allows the user program to read and/or execute a direct access file with the implication that another user may currently be accessing the same file in A (append) mode. For indirect access files, this mode is the same as R (read) mode.

† For a CHANGE request, 40B must be added to this value. The macro does this automatically if you specify an alphabetic key (instead of a value) for this parameter.

†† Special care should be taken when using modes RM, RA, or RU. Programs using access techniques that do not expect concurrent updating of a file may get erroneous results if these modes are used. In particular, CRM AAM (refer to the CYBER Record Manager Advanced Access Methods Reference Manual) is not designed to deal with concurrent reading and updating of a file by multiple users.

Therefore, if a program using CRM AAM attempts to access a file attached in RM, RA, or RU mode while a second program using CRM AAM is accessing the file in M, A, or U mode, one or both of the jobs may be aborted and an error message may be issued stating that the file was ruined. In fact, the file may still be intact, but CRM cannot guarantee this and so will not allow the access.

<u>Parameter</u>	<u>Mnemonic</u>	<u>Key</u>	<u>Value (Octal) †</u>	<u>Description</u>
	PTUP	U	10	Allows the user program to modify, read, and/or execute a direct access file. Information may be added within the existing boundaries of the file, but the file size must be maintained. For indirect access files, this mode is the same as R (read) mode.
	PTRU	RU	11	Allows the user program to read and/or execute a direct access file with the implication that another user may currently be accessing the same file in U (update) mode. For indirect access files, this mode is the same as R (read) mode.
ct				File category:
	FCPR	P	0	Private. Private files are available for access only by the originator or those to whom the originator has explicitly granted permission (refer to the PERMIT macro).
	FCSP	S	1	Semiprivate. Semiprivate files are available for access by all users who know the file name, user name, and file password. The file owner specifies the default permitted mode of access for all users. The file owner may also specify, via the PERMIT macro or command, different permissions for different users. The system records in the file owner's catalog the user name of each user who accessed the file, the number of accesses, and the date and time of the last access.
	FCPB	PU	2	Public. Public files are available for access by all users who know the file name, user name, and file password. The file owner specifies the permitted mode of access for all users. The system records the number of times the file was accessed but does not record user names or the last access date and time.

† For a CHANGE request, 40B must be added to this value. The macro does this automatically if you specify an alphabetic key (instead of a value) for this parameter.

<u>Parameter</u>	<u>Mnemonic</u>	<u>Key</u>	<u>Value (Octal)</u>	<u>Description</u>
ss				<u>Subsystem indicator:</u>
	--	NULL	0	Null subsystem.
	--	BASIC	1	BASIC subsystem.
	--	FORT	2	FORTRAN 5 subsystem.
	--	FTNTS	3	FORTRAN Extended 4 subsystem.
	--	EXEC	4	Execute subsystem.
	--	BATCH	5	Batch subsystem.
br†				<u>Backup requirement:</u>
	BRNO	N	1	Backup is not required on a dump tape.
	BRAL	Y	2	Backup is required on a dump tape.
	BRMD	MD	3	Backup is required on a dump tape only if the file is not resident on alternate storage.
pr†				<u>Preferred residence:</u>
	RSLK	L	1	The file will be locked to disk. (Special validation is required for this option.)
	RSDS	D	2	The file should reside on disk at all times.
	RSMS	M	3	The file should reside on alternate storage when it is not being accessed.
	RSNP	N	4	No preferred residence for the file.
ac				<u>Alternate CATLIST permission:</u>
	ACNO	N	1	Alternate users may not obtain information about the file by using CATLIST (default value).
	ACYS	Y	2	Alternate users may obtain information about the file by using CATLIST.

†If this parameter is omitted or a value of 0 is specified, PFM uses the installation default value.

AUXILIARY DEVICE REQUEST

Unless you explicitly declare otherwise, all of your permanent files reside on family devices. As stated in Volume 3, System Commands, you may wish to supplement the mass storage provided by your family devices by retaining your files on auxiliary devices. (Not all users may be validated to use auxiliary devices.) There are four parameters (pn, r, un, and pwd) that uniquely identify file pfn on an auxiliary device.

- The pn parameter specifies the one- to seven-character system-defined pack name of the auxiliary device. The device can be either public or private, as defined by the installation.
- The r parameter specifies the type of auxiliary device on which the file resides or is to reside. An auxiliary device is any supported device that an installation defines as an auxiliary; it need not be a removable device.

r may be DBn, DCn, DDn, DE, DFn, DGn, DHn, DIn, DJn, DKn, DLn, DMn, DP, DQn, DV, or DW, as described for Device Types in appendix E.

If you need two or more removable auxiliary devices, or one removable auxiliary device and one or more magnetic tapes, at any one time during your job, a RESOURC command must be included (refer to Volume 3, System Commands).

An installation can provide additional continuous storage on a DB, DC, DD, DF, DG, DH, DI, DJ, DK, DL, DM, or DQ type device by combining several physical units into one logical unit. A device so defined is known as a multiunit device. To specify such a device, the r parameter must include the number of units. For example, if four 844-21 units have been combined as one multiunit device, the r parameter must be DI4. If it is not, the job step aborts.

However, if r is DB, DC, DD, DF, DG, DH, DI, DJ, DK, DL, DM, or DQ but n is omitted, the unit count is assumed to be 1.

The r parameter is required only if the desired device has a device type different from that of the installation-defined default device type, and the installation has defined the desired device as removable. However, you can be assured of always accessing the proper device by specifying this parameter. If an incorrect value is specified for r, PFM error message 11g (IDR) is issued. For all PFM macros, if pn is specified but the device is not available, the job is aborted. By setting the error processing bit (FET+1, bit 44) you can bypass the abort and direct the system to make the specified device available. If both the error processing bit and the user processing bit (FET+1, bit 45) are set, control is returned to the user program when the device is unavailable and error code 14g (PFN) is set in FET+0.

- The un parameter specifies the one- to seven-character optional user name. If the device is public, files are accessed in the same manner as specified for family devices; that is, the un parameter must be included only if you wish to access files that another user has explicitly or implicitly permitted you to use. If the device is private, there is only one owner. All other users who have the proper validation can access files on the device, but the system prevents them from creating files on that device.
- The pwd parameter specifies the one- to seven-character password associated with the file. As with files on family devices, the pwd parameter must be included only if the originator requires that a password be specified.

SAVE (001, CCSV)

The SAVE macro enables the user program to retain a copy of a temporary mass storage file as an indirect access permanent file. The original file is rewound when the copy is complete.

Macro format:

<u>Location</u>	<u>Operation</u>	<u>Variable</u>
	SAVE	addr,pfn,pwd,ucw,ct,m,pn,r,fo,ss,br,pr,xt,al,ac
addr		Address of the FET; the local file name must be set in FET+0.
pfn		Address containing the name of the file; name the file is given in the permanent file catalog.
pwd		Address containing the password to be placed with the file in the permanent file catalog.
ucw		Address containing user control word to be placed with the file in the permanent file catalog. If this word exists in the catalog, it is returned to FET+138 when the file is accessed (default=0).

ct File category:

<u>ct</u>	<u>Description</u>
P	Private file (default value).
S	Semiprivate.
PU	Public file.

Refer to PFM Macro Parameter Conventions in this section for further information.

m File mode. This parameter defines the type of access alternate users may have for semiprivate or public files.

<u>m</u>	<u>Description</u>
W	Read, write, append, purge, and execute (default value).
R	Read and execute.
A	Append.
E	Execute.
M	Read, append, and execute.
N	None.
RM	Same as R for indirect access files.
RA	Same as R for indirect access files.
U	Same as R for indirect access files.
RU	Same as R for indirect access files.

Refer to PFM Macro Parameter Conventions in this section for further information.

pn Address containing one- to seven-character pack name of the auxiliary device on which the file is to be saved.

Entering the display code character zero (left-justified, binary zero fill) in this field overrides the pack name set by the PACKNAM command or macro. This causes the file to be saved on your family device.

r Type of auxiliary device on which the file is to be saved (refer to the DEFINE macro).

fo Family option:

IP The pack name specified by a PACKNAM macro or pn parameter is ignored. PFM accesses your family.

ss Subsystem indicator. This indicator causes automatic subsystem selection when the file is retrieved using the OLD macro or command.

<u>ss</u>	<u>Description</u>
NULL	Null subsystem.
BASIC	BASIC subsystem.
FORT	FORTRAN 5 subsystem.
FTNTS	FORTRAN Extended 4 subsystem.
EXEC	Execute subsystem.
BATCH	Batch subsystem.

Refer to PFM Macro Parameter Conventions in this section for further information.

br Backup requirement. Specifies whether the file is to be backed up on a dump tape when the site dumps permanent files.

<u>br</u>	<u>Description</u>
Y	The file must be backed up on the dump tape.
MD	Backup file on dump tape only if a copy does not exist on alternate storage.
N	The file is not to be backed up on the dump tape.

Refer to PFM Macro Parameter Conventions in this section for further information.

pr Preferred residence. Specifies whether you prefer the file to reside on disk or on alternate storage.

<u>pr</u>	<u>Description</u>
M	The file should reside on alternate storage when it is not being accessed.
N	No preferred residence for the file.
D	The file should reside on disk at all times.
L	The file will be locked to disk. (Special validation is required for this option.)

Refer to PFM Macro Parameter Conventions in this section for further information.

- xt Expiration term or date for password. xt is the address of a word containing either the packed expiration date (format: yymmdd, where yy is the year minus 1970), or the expiration term, the number of days (<77778) to be added to the current date to determine the expiration date. A value of 77778 indicates a nonexpiring password. If this parameter is not specified when a password is established, the system creates a nonexpiring password. You must be validated to assign a permanent file expiration date in order to use this parameter.
- al Security access level of the file. This may be either the name of the access level or the address of a location containing the numerical value of the access level. System OPL common deck COMCVLC can be used to convert access level names to numerical values and vice versa. System OPL common deck COMSMLS is required if you specify this parameter. Using this parameter sets the access level bit (bit 39 of FET+1).
- If an access level is specified in the al field of the FET rather than as a macro parameter, your program must also set the access level bit (bit 39 of FET+1).
- On a secured system, any access level specified must be valid for your job and for the local and permanent file devices involved.
- ac Alternate CATLIST permission. Specifies whether alternate users may obtain information about the file using CATLIST.

<u>ac</u>	<u>Description</u>
N	Permission denied.
Y	Permission granted.

Refer to PFM Macro Parameter Conventions in this section for further information.

Example 1:

This example saves local file FILE in the permanent file system as a public file name DATA with read permission. The file will be backed up on a dump tape when the site dumps permanent files.

```

      SAVE  FILE,PF,,,PU,R,,,,Y
      .
      .
      .
FILE  FILEB  BUF,BUFL,(FET=16)
PF    VFD    42/OLDATA,18/0

```

Example 2:

This example performs the same function as example 1.

```

      XTEXT  COMSPFM
      .
      .
      SA1    PF
      SAVE   FILE,X1,,,,FCAT,FMOD,,,,BACK
      .
      .
FCAT      CON   FCPB
FMODE     CON   PTRD
BACK      CON   2
FILE      FILEB BUF,BUFL,(FET=16)
PF        VFD   42/OLDATA,18/0
```

Example 3:

In this example, local file TAPE1 is saved in the permanent file system as a private file name PTAPE1 with null permission. The subsystem indicator is set to the batch subsystem.

```

      SAVE   F,PF,,,,P,N,,,,BATCH
      .
      .
      F      BSS   0
TAPE1     FILEB BUF,BUFL,(FET=16)
PF        VFD   42/OLPTAPE1,18/0
```

GET (002, CCGT)

The GET macro enables the user program to obtain a temporary copy of an indirect access permanent file. If a local file by the same name already exists, it is returned as if the UNLOAD macro had been issued even if the GET is unsuccessful. The new file is set to rewound status. No interlock is provided to prevent other users from obtaining copies of the same file simultaneously.

The local file created by a GET macro call may be an execute-only file, depending on the access mode permitted to the user name associated with the user program. PFM returns the access mode of the file in the mode field (FET+10g, bits 0 through 5) if the FET is long enough; the user program can examine this field to determine the access mode. If the FET is long enough, the user control word (ucw) is returned to FET+13g, and the subsystem is returned to FET+17g, bits 59-57. Refer to PFM Macro Parameter Conventions in this section for a list of access modes and subsystems.

If the access level bit (bit 39 of FET+1) is set, the access level of the file is returned to bits 38 through 36 of FET+4.

Macro format:

<u>Location</u>	<u>Operation</u>	<u>Variable</u>
	GET	addr,pfn,un,pwd,pn,r,fo
addr	Address of the FET; the local file name must be set in FET+0.	
pfn	Address containing the name of the file; name the file is given in the permanent file catalog.	
un	Address containing the number of the alternate user whose catalog is to be searched for the file specified; if this parameter is specified, the permission mode is that which the user has been permitted for private files or that specified in the catalog for semiprivate and public files.	
pwd	Address containing the password of the file; required if un≠0 and the file requires a password.	
pn	Address containing one- to seven-character pack name of the auxiliary device from which the file is to be retrieved. Entering the display code character zero (left-justified, binary zero fill) in this field overrides the pack name set the PACKNAM command or macro. This causes the request to be processed on your family device.	
r	Type of auxiliary device on which the indirect access permanent file resides (refer to the DEFINE macro).	
fo	Family option: IP The pack name specified by a PACKNAM macro or pn parameter is ignored. PFM accesses your family.	

PURGE (003, CCPG)

The PURGE macro enables the user program to remove the specified file from the permanent file system. To purge a file in an alternate user's catalog, you must have write permission for the file or the file must be a semiprivate or public file with write mode.

Macro format:

<u>Location</u>	<u>Operation</u>	<u>Variable</u>
	PURGE	addr,un,pwd,pn,r,fo
addr		Address of the FET; the local file name must be set in FET+0. If FET+10 ₈ contains a permanent file name, that file name is used for the PURGE operation.
un		Address containing the user name of the alternate catalog for the file to be purged.
pwd		Address containing the password of the file; required if un≠0 and the file requires a password.
pn		Address containing one- to seven-character pack name of the auxiliary device on which the file resides. Entering the display code character zero (left-justified, binary zero fill) in this field overrides the pack name set by the PACKNAM command or macro. This causes the request to be processed on your family device.
r		Type of auxiliary device identified by the pn parameter (refer to the DEFINE macro).
fo		Family option: IP The pack name specified by a PACKNAM macro or pn parameter is ignored. PFM accesses your family.

An example of the use of this macro is:

```
PURGE  F
      .
      .
      .
F  FILEB  BUF,BUFL
```

These instructions purge permanent file F.

CATLIST (004, CCCT)

The CATLIST macro can be used for the following applications:

- To determine the information about one or more of your own permanent files.
- To determine the information about one or more files belonging to a specified alternate user. You will only be allowed to see information about those files which you can access and which the owner has specified you to receive (via the AC = Y parameter).
- To determine the alternate user information for a specified file that an alternate user can access or has accessed in your catalog (permit data).

The first type of application is the return of the permanent file catalog entries of all your files. If a permanent file name is specified in FET+CFPN, the catalog entry of that one file will be returned.

The format of the permanent file catalog (PFC) entry is as follows:

	59	56	53	47	44	41	38	35	23	17	11	0	
word 0	file name								user index				FCFN, FCUI
1	file length								track	sector			FCLF, FCBT, FCBS
2	random index						creation date and time						FCRI, FCCD
3	access count						data modification date and time						FCAC, FCMD
4	ct	mode	ef	ec	dn	last access date and time						FCCT, FCAM, FCEC, FCEF, FCEO, FCAD	
5							control modification date and time						FCKD
6	pr	br	ss	ac			utility control date and time						FCRS, FCBR, FCFS, FCUD, FCAP
7	file password								password exp date				FCPW
10	aflags					alt	asa						FCAF, FCAT, FCAA
11	reserved for CDC					al			access categories				FCAL, FCFC
12	charge number												FCCN
13	project number (first 10 characters)												FCP1
14	project number (second 10 characters)												FCP2
15	reserved for CDC												
16	user control word												FCUC
17	reserved for installation												FCIW

file name	Permanent file name.
user index	User index of file creator.
file length	Length in PRUs of the file.
track	Beginning track of file.
sector	Beginning sector of file (4xxx for a direct access file).
random index	Random disk address of permit sector.

creation date and time	Date and time (yymmddhhmmss in octal) when this file was first entered on the permanent file system. The year (yy) is the calendar year minus 1970.
access count	Count of accesses to file.
data modification date and time	Date and time (yymmddhhmmss in octal) when the data in this file was last modified. The year (yy) is the calendar year minus 1970. For direct access files this field is updated when the file is attached in a modifiable mode, whether or not the file is actually modified.
ct	File category (refer to PFM Macro Parameter Conventions for further information).
mode	File mode (refer to PFM Macro Parameter Conventions for further information).
ef	Error flag: 0 No error. 1 EOI changed by recovery.
ec	Error code: 0 No error. 1 Error in data for file. 2 Error in permit entries for file. 3 Error in data and permit entries for file. 4 File length error. 5-7 Reserved.
dn	Device number (0 through 778); each device within a family of permanent file devices is identified by a device number.
last access date and time	Date and time (yymmddhhmmss in octal) when this file was last accessed. The year (yy) is the calendar year minus 1970.
control modification date and time	Date and time (yymmddhhmmss in octal) when the control information (catalog entry and permit record data) for this file was last updated. This corresponds to the last time a CHANGE or PERMIT command or macro was processed for the file. The year (yy) is the calendar year minus 1970.
pr	Preferred residence for file (refer to PFM Macro Parameter Conventions in this section for further information).
br	Backup requirement for file (refer to PFM Macro Parameter Conventions in this section for further information).
ss	Subsystem code for this file (refer to PFM Macro Parameter Conventions in this section for further information).
ac	Alternate CATLIST permission for this file (refer to PFM Macro Parameter Conventions in this section for further information).

utility control date and time	Date and time (yymmddhhmmss in octal) used to determine this file's candidacy for being dumped by permanent file utilities. The year (yy) is the calendar year minus 1970.
file password	Optional password. On a secured system the password is returned as seven asterisks (*****) if a password is defined and the file has an access level higher than that of the job.
password exp date	The date on which the password expires (yymmdd in octal). The year (yy) is the calendar year minus 1970.
aflags	Alternate storage flags; used with the asa field and meaningful only if the file resides on an alternate storage device (as indicated by the alt field); refer to the NOS 2 Analysis Handbook for a complete description of this field.
alt	Alternate storage type: 0 No alternate storage copy of the file exists. 2 An alternate storage copy of the file resides on MSE.
asa	Alternate storage address; meaningful only if an alternate storage copy of the file exists (as indicated by the alt field); if asa is 0, the file does not reside on alternate storage; refer to the NOS 2 Analysis Handbook for a complete description of this field.
al	File's security access level.
access categories	Each of bits 31 through 0, if set, indicates that the corresponding category is in the security access category set for the file. The system OPL common deck COMCVLC can be used to convert an access category value to an access category name.
charge number	Charge number to which the file will be billed.
project number	Project number to which the file will be billed.
user control word	User control information (FET+l3g).

The second type of application is a CATLIST of another user's files. The system returns the permanent file catalog entries of all the user's files you are permitted to access and that are listable by another user. (A file is listable by way of CATLIST only if the owner has specified an alternate CATLIST permission [AC=Y].) If a permanent file name is specified in FET+CFPN, the catalog entry of the specified file will be returned (provided the file is listable by CATLIST and that you are permitted to access it). The following fields are cleared before the catalog entries are returned: user index, access level, access category set, password, and password expiration date.

The third type of application is a CATLIST of PERMIT data. All alternate user access entries (permit entries) for a specified file are returned. The format of an alternate user access entry is illustrated.

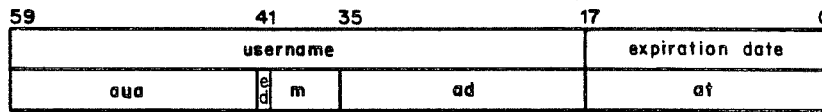

- username Alternate user name.
- expiration The date on which the permit expires [yyymmdd in octal; the year (yy) is date the calendar year minus 1970].
- aua Number of accesses the alternate user has made to the file.
- ed Bit 41; if set, indicates that an expiration date is present in bits 17-0 of the first word of the entry.
- m Permission mode (bit 40 set if this was an accounting permit and was not created by a PERMIT command or macro; bit 40 clear indicates an explicit permit set by PERMIT command or macro; bits 39 through 36 are same as mode described in first type of request).
- ad The last date the alternate user accessed the file [yyymmdd in octal; the year (yy) is the calendar year minus 1970].
- at The time of day the alternate user last accessed the file (hhmmss in octal).

Macro format: †

<u>Location</u>	<u>Operation</u>	<u>Variable</u>
	CATLIST	addr,pfn,un,m,pn,r,fo,dn
addr		Address of the FET for the CATLIST function.
pfn		Address containing the file name; if this parameter is omitted, CATLIST information for all files in your permanent file catalog (or in the catalog specified by un) is returned.
un		Address containing the name of the alternate user catalog to be searched for the catalog information. If un is omitted, your own catalog is searched.
m		If this parameter is the letter M, alternate user access information for file pfn is returned. If this parameter is specified, the pfn is required and un is ignored.

† This macro is not available in SYSTEXT. The user program must specify systems text PSSTEXT or call common deck CONCMAC (refer to appendix F).

pn Address containing one- to seven-character pack name of the auxiliary device that contains catalog information for all users with information on that device.

 Entering the display code character zero (left-justified, binary zero fill) in this field overrides the pack name set by the PACKNAM command or macro. This causes the request to be processed on your family device.

r Type of auxiliary device identified by the pn parameter (refer to the DEFINE macro).

fo Family option:

 IP The pack name specified by a PACKNAM macro or pn parameter is ignored. PFM accesses your family.

dn Request CATLIST of files on device number dn (FET+11g, bits 17 through 12). Any value may be specified.

If the status returned in FET+0 (addr parameter of the CATLIST macro), bits 9 through 0, is 0033 (EOF encountered), the user program should reissue the CATLIST macro after the buffer of entries has been processed (refer to example 1). The user program should continue this until a status of 1033 (EOI encountered) is returned. CATLIST uses the current random index field (FET+6, bits 59 through 30) to keep track of its position for continued calls. If the user program changes this field, the results of a CATLIST request may be undefined.

Information is placed in the buffer starting at IN until (IN=LIMIT-1), at which time buffer full (0033) status is set in FET+0. PFM does not process the buffer circularly; therefore, the user program must reset (IN=OUT=FIRST) before reissuing the CATLIST macro.

The following examples assume that PSSTEXT is specified at assembly.

Example 1:

The following program creates a binary file named F with permanent file catalog entries for all files in your catalog. (The system OPL must be attached to assemble this program.)

```

                IDENT      CAT,FWA
                ABS
                ENTRY      START
                SYSCOM     B1

OPL            XTEXT      COMSPFM
                ORG        112B
FWA            BSS        0
BUFL           EQU        1001B
F              FILEB      BUFL,BUFL
G              FILEB      BUFG,BUFL,FET=10D

START         SB1        1

STA1          CATLIST    G

STA2          READW      G,WBUF,NWCE      TRANSFER CATALOG ENTRY
                NG       X1,STA3         IF BUFFER EMPTY
                WRITEW   F,WBUF,NWCE
                EQ       STA2           TRANSFER NEXT CATALOG ENTRY

STA3          SX1        X1+B1
                NG       X1,STA4         IF EOI (CATLIST COMPLETE)
                SA1      G+1            RESET FET POINTERS
                SX7      X1
                SA7      A1+B1          SET IN=FIRST
                SA7      A7+B1          SET OUT=FIRST
                EQ       STA1           GET NEXT BUFFER LOAD

STA4          WRITER     F
                ENDRUN

BUFF          BSS        BUFL
BUFG          BSS        BUFL
WBUF          BSS        NWCE
OPL           XTEXT      COMCCIO
OPL           XTEXT      COMCPFM
OPL           XTEXT      COMCRDW
OPL           XTEXT      COMCSYS
OPL           XTEXT      COMCWTW

                END

```

Example 2:

The following example returns all access information for file DATA013.

```

          CATLIST  F,PF,,M
          .
          .
          .
F        FILEB    BUF,BUFL,(FET=10D)
PF       VFD      42/OLDATA013,18/O

```

Example 3:

This example returns a list of all files that you can access by way of CATLIST in the catalog of user USERABC. [A file is listable by way of CATLIST only if the owner has specified an alternate CATLIST permission (AC=Y).]

```

          CATLIST  F,,AUN
          .
          .
          .
F        FILEB    BUF,BUFL,(FET=10D)
AUN     VFD      42/OLUSERABC,18/O

```

PERMIT (005, CCPM)

The PERMIT macro enables your program to explicitly permit another user to access a private or semiprivate file in your permanent file catalog. If you wish to remove permission previously granted, you should select the negate (null) mode.

Macro format:

<u>Location</u>	<u>Operation</u>	<u>Variable</u>
	PERMIT	addr,pfn,un,m,pn,r,fo,,xt
addr		Address of the FET; the local file name must be set in FET+0.
pfn		Address containing the name of the file; name of the file is given in the permanent file catalog.
un		Address containing the user name of the user being granted permission.
m		Mode of permission being granted; if no mode is specified, W (write) is assumed.
	<u>m</u>	<u>Description</u>
	W	Read, write, modify, append, update, purge, and execute (default value).
	R	Read and execute.
	A	Append.
	E	Execute.
	N	None (negate previous permissions).
	M	Modify, append, update, read, and/or execute.

<u>m</u>	<u>Description</u>
RM	Read and/or execute, allow simultaneous access in modify, append, or update mode.
RA	Read and/or execute, allow simultaneous access in append mode.
U	Update.
RU	Read and/or execute, allow simultaneous access in update mode.

Refer to PFM Macro Parameter Conventions in this section for further information.

- pn Address containing one- to seven-character pack name of the auxiliary device on which the specified file resides.
- Entering the display code character zero (left-justified, binary zero fill) in this field overrides the pack name set by the PACKNAM command or macro. This causes the request to be processed on your family device.
- r Type of auxiliary device identified by the pn parameter (refer to the DEFINE macro).
- fo Family option:
- IP The pack name specified by a PACKNAM macro or pn parameter is ignored. PFM accesses your family.
- xt Expiration term or date for permit. xt is the address of a word containing either the packed expiration date (format: yymmdd, where yy is the year minus 1970), or the expiration term, the number of days (<77778) to be added to the current date to determine the expiration date. A value of 77778 indicates a nonexpiring password. If this parameter is not specified, the system sets a site-defined default permit expiration date. You must be authorized to assign a permanent file expiration date in order to use this parameter; also, your site may choose to limit the maximum expiration term you may specify.

An example of the use of this macro is:

```

PERMIT F,PF,AUN,A
.
.
.
F      FILEB  BUF,BUFL,(FET=10D)
PF     VFD    42/OLDATA012,18/0
AUN    VFD    42/OLUSERABC,18/0

```

This allows user USERABC to have append permission to file DATA012.

REPLACE (006, CCRP)

The REPLACE macro enables the user program to place a copy of the specified local mass storage file in the permanent file system as an indirect access file. If an indirect access permanent file with the specified name already exists in the catalog, that file will be replaced by the new file placed in the catalog as the same type of file. If the file does not exist in the catalog, a new indirect access permanent file is created as if a SAVE request had been made. Permission information and alternate user access data are not lost when the file is replaced.

Macro format:

<u>Location</u>	<u>Operation</u>	<u>Variable</u>
	REPLACE	addr, pfn, un, pwd, ucw, pn, r, fo, m
addr		Address of the FET; local file name must be set in FET+0.
pfn		Address containing the name of the permanent file to be replaced in the permanent file catalog.
un		Address containing the name of the alternate user's catalog where the file resides.
pwd		Address containing the password of the file being replaced (this may be required on an alternate user access).
ucw		Address containing user control word to place with the file; bit 59 of FET+13g must be set to retain the word with the file in the catalog.
pn		Address containing one- to seven-character pack name of the auxiliary device on which the file is to be placed. Entering the display code character zero (left-justified, binary zero fill) in this field overrides the pack name set by the PACKNAM command or macro. This causes the file to be replaced on your family device.
r		Type of auxiliary device identified by the pn parameter (refer to the DEFINE macro).
fo		Family option: IP The pack name specified by a PACKNAM macro or pn parameter is ignored. PFM accesses your family.
m		Specifies the file access mode if the file does not already exist. If m is omitted, READ is assumed. If m is: Other users can: R or READ Retrieve a copy of the file. This copy can be read RU or READUP or executed. RA or READUP RM or READMD U or UPDATE

E or EXECUTE	Retrieve a copy of the file. This copy can only be executed.
A or APPEND	Append data to the file with the APPEND command.
M or MODIFY	Retrieve a copy of the file or append data to the file. The user can enter GET, OLD, NEW and APPEND commands, but not a REPLACE command for the file.
W or WRITE	Retrieve a copy of the file, append data to it, replace it, or purge it.
N or NULL	No access is allowed.

APPEND (007, CCAP)

The APPEND macro enables a user program to add the contents of the specified local mass storage files to the end of the specified indirect access permanent file. The logical structure of the two files is retained; that is, EORs and EOFs are appended as well as data. If the working file is appended to a file in an alternate user's catalog, a password must be supplied if one is required.

Macro format:

<u>Location</u>	<u>Operation</u>	<u>Variable</u>
	APPEND	addr, pfn, un, pwd, pn, r, fo
addr		Address of the FET; name of the local file to be appended must be set in FET+0.
pfn		Address containing the name of the permanent file to which information is to be appended.
un		Address containing the name of the alternate user whose catalog contains the permanent file.
pwd		Address containing the password of the file to which information is to be appended. This must be specified if un≠0 and the file requires a password.
pn		Address containing one- to seven-character pack name of the auxiliary device on which the specified permanent file resides. Entering the display code character zero (left-justified, binary zero fill) in this field overrides the pack name set by the PACKNAM command or macro. This causes the request to be processed on your family device.
r		Type of auxiliary device identified by the pn parameter (refer to the DEFINE macro).
fo		Family option: IP The pack name specified by a PACKNAM macro or pn parameter is ignored. PFM accesses your family.

An example of the use of this macro is:†

```

APPEND F
.
.
.
F FILEB BUF,BUFL,(PFN=DATA)
.
.

```

The structure of file DATA after the APPEND macro is issued is as follows.

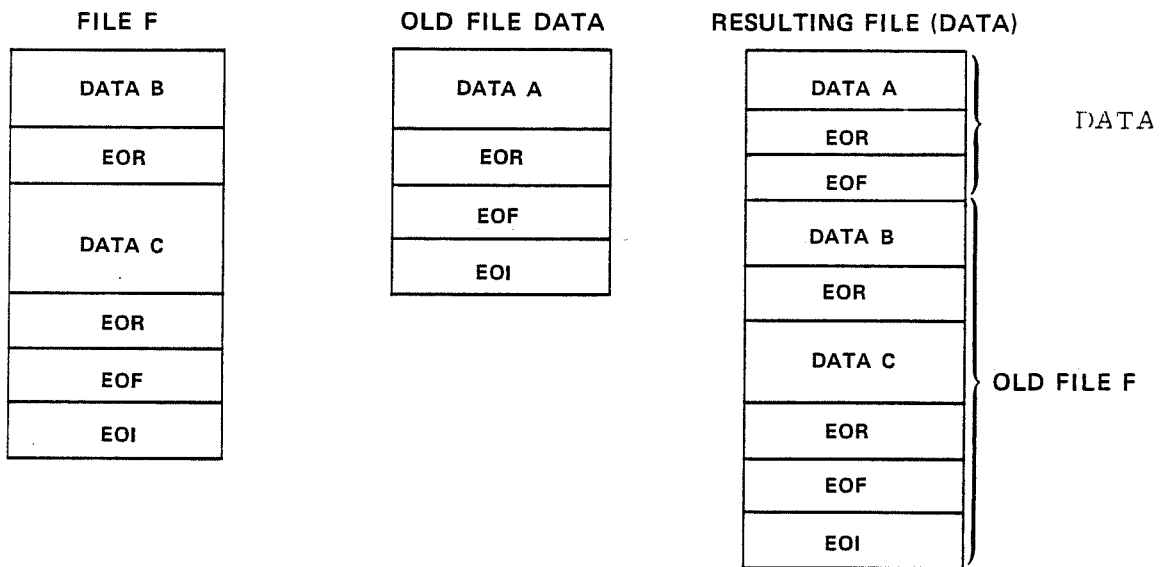

†The permanent file name can be set by FET creation macros as well as being set in the permanent file macros.

DEFINE (010, CCDF)

The DEFINE macro enables the user program to create a direct access permanent file. If the user program attempts to create a direct access file with the same name as a local file, the local file must reside on a legal permanent file device for your user name. If a local file with the same name does not exist, an empty file is created on an appropriate device.

Macro format:

<u>Location</u>	<u>Operation</u>	<u>Variable</u>
	DEFINE	addr,pfn,pwd,ucw,r,ct,m,pn,s,fo,br,pr,,xt,al,ac
addr		Address of the FET. FET+0 must contain the local file name of the file to be made a direct access file (name used when the job accesses the file).
pfn		Address containing the name of the permanent file entered in the catalog. If pfn=0, the contents of FET+0 is used for the permanent file name.
pwd		If pwd is specified, the password is retained with the file; all alternate users must supply this password when attaching file.
ucw		Address containing user control information, bit 59 of FET+13g must be set to retain this data. If this parameter is supplied, this data is retained in the catalog entry for the file and returned to FET+13g when the file is attached.
r †		Specifies the type of family or auxiliary device on which the permanent file resides or is to reside; r can be DBn, DCn, DDn, DE, DFn, DGn, DHn, DIn, DJn, DKn, DLn, DMn, DQn, DP, DW, or DV as described for Device Types in appendix E. If r is not one of these values, the value specified represents the address that contains the display code equivalent, left-justified. If the device is a multiunit type device (DBn, DCn, DDn, DFn, DGn, DHn, DIn, DJn, DKn, DLn, DMn, or DQn), n is the number of physical units which the installation has combined into one logical unit; n is converted from display code to octal and placed in FET+14g, bits 11 through 0. Also, if r is DB, DC, DD, DF, DG, DH, DI, DJ, DK, DL, DM, or DQ but n is omitted, the unit count is assumed to be 1. If r is not specified, the system default device type (or the device type specified in the last PACKNAM macro or command) is used.
ct		File category:

<u>ct</u>	<u>Description</u>
P	Private file (default value).
S	Semiprivate.
PU	Public file.

Refer to PFM Macro Parameter Conventions in this section for further information.

† If the file later resides on MSE and then is staged back to disk, it may not reside on the device type specified by the r parameter.

m File mode. This parameter defines the type of access alternate users may have for semiprivate or public files.

<u>m</u>	<u>Description</u>
W	Read, write, modify, append, update, purge, and execute (default value).
R	Read and execute.
A	Append.
E	Execute.
N	None.
M	Modify, append, update, read, and/or execute.
RM	Read and/or execute, allow simultaneous access in modify, append, or update mode.
RA	Read and/or execute, allow simultaneous access in append mode.
U	Update.
RU	Read and/or execute, allow simultaneous access in update mode.

Refer to PFM Macro Parameter Conventions in this section for further information.

pn Address containing the one- to seven-character pack name of the auxiliary device on which the direct access file is to reside.

Entering the display code character zero (left-justified, binary zero fill) in this field overrides the pack name set by the PACKNAM command or macro. This causes the file to be defined on your family device.

s Address containing the number of PRUs desired for the direct access file. The number of PRUs is in octal, right-justified. DEFINE places this value in FET+11g bits 23 through 0 (CFOU).

fo Family option:

IP The pack name specified by a PACKNAM macro or pn parameter is ignored. PFM accesses your family.

br Backup requirement. Specifies whether the file is to be backed up on a dump tape when the site dumps permanent files.

<u>br</u>	<u>Description</u>
Y	The file must be backed up on the dump tape.
MD	Backup file on dump tape only if it does not reside on alternate storage.
N	The file is not to be backed up on the dump tape.

Refer to PFM Macro Parameter Conventions in this section for further information.

pr Preferred residence. Specifies whether you prefer the file to reside on disk or on alternate storage.

<u>pr</u>	<u>Description</u>
M	The file should reside on alternate storage when it is not being accessed.
N	No preferred residence for the file.
D	The file should reside on disk at all times.
L	The file will be locked to disk. (Special validation is required for this option.)

Refer to PFM Macro Parameter Conventions in this section for further information.

xt Expiration term or date for password. xt is the address of a word containing either the packed expiration date (format: yymmdd, where yy is the year minus 1970), or the expiration term, the number of days (<7777g) to be added to the current date to determine the expiration date. A value of 7777g indicates a nonexpiring password. If this parameter is not specified when a password is established, the system creates a nonexpiring password. You must be validated to assign a permanent file expiration date in order to use this parameter; also, your site may choose to limit the maximum expiration term you may specify.

al Security access level of the file. This may be either the name of the access level or the address of a location containing the numerical value of the access level. System OPL common deck COMCVLC can be used to convert access level names to numerical values and vice versa. System OPL common deck COMSMLS is required if you specify this parameter. Using this parameter sets the access level bit (bit 39 of FET+1).

If an access level is specified in the al field of the FET rather than as a macro parameter, your program must also set the access level bit (bit 39 of FET+1).

On a secured system, any access level specified must be valid for your job and for the local and permanent file devices involved.

ac Alternate CATLIST permission. Specifies whether alternate users may obtain information about the file using CATLIST.

<u>ac</u>	<u>Description</u>
N	Permission denied.
Y	Permission granted.

Refer to PFM Macro Parameter Conventions in this section for further information.

If lfn does not exist at the time the DEFINE request is issued, the device on which pfn resides depends on the r and s parameters.

<u>r</u>	<u>s</u>	<u>Residency</u>
Specified	Not specified	The file resides on the device of type r with the most space available.
Specified	Specified	The file resides on the device of type r with the most space available, provided that device has as many PRUs available as specified by the s parameter.
Not specified	Specified	The file resides on the device with the most space available, provided that device has as many PRUs available as specified by the s parameter.
Not specified	Not specified	The file resides on the device with the most space available.

Example 1:

This defines file F as a read-only public file on a DI device. The name of the entry in the permanent file catalog is DATA. (It is assumed that the file did not exist before the DEFINE request was issued.)

```

                DEFINE F,PF,,,DI,PU,R
                .
                .
                .
F      FILEB  BUF,BUFL,(FET=9)
PF     VFD    42/OLDATA,18/O

```

Example 2:

The same operation could be accomplished by the following sequence of instructions.

```

SA1    PF
DEFINE F,X1,,,RES,FCAT,R
      .
      .
      .
F      FILEB  BUF,BUFL,(FET=9)
PF     VFD    42/OLDATA,18/O
RES    VFD    12/OLDI,48/O
FCAT   CON    FCPU
OPL    XTEXT  COMSPFM

```

Example 3:

The following sequence defines file DATA. The file will not be backed up on the archive tape if it is residing on MSE, and its preferred residence is MSE.

```

                DEFINE P,PF,,,,,,,,,MD,M
                .
                .
                .
F      FILEB  BUF,BUFL,(FET=16D)
PF     VFD    42/OLDATA,18/O

```

ATTACH (011, CCAT)

The ATTACH macro enables your program to attach the specified direct access file to your job.

A read/write interlock is provided to ensure that only one user at a time accesses the file in write mode. Several users may access the file in read mode simultaneously. You should return the file as soon as possible to enable other users to access the file. If a local file by the same name already exists, it is returned as if the UNLOAD macro had been issued even if the ATTACH is unsuccessful.

If the FET is long enough, the user control word for the file is returned to FET+138.

If the access level bit (bit 39 of FET+1) is set, the access level of the file is returned to bits 38 through 36 of FET+4.

Macro format:

<u>Location</u>	<u>Operation</u>	<u>Variable</u>
	ATTACH	addr,pfn,un,pwd,m,pn,r,fo,sr,rt
addr		Address of the FET. FET+0 must contain the local file name of the file while attached to the job.
pfn		Address containing the name of the file in the permanent file catalog. If pfn is 0, the contents of FET+0 is used for the permanent file name.
un		Address containing name of the alternate user catalog on which the file resides.
pwd		Address containing file password; entered only if un is not 0 and the file requires a password.
m		Mode of access desired:
	<u>m</u>	<u>Description</u>
	W	Read, write, modify, append, update, purge, and/or execute (default value).
	R	Read and/or execute.
	A	Append, update, read, and/or execute.
	E	Execute.
	N	None.
	M	Modify, append, update, read, and/or execute.
	RM	Read and/or execute, allow simultaneous access in modify, append, or update mode.
	RA	Read and/or execute, allow simultaneous access in append mode.
	U	Update, read, and/or execute.
	RU	Read and/or execute, allow simultaneous access in update mode.

Refer to PFM Macro Parameter Conventions in this section for further information.

pn Address containing one- to seven-character pack name of the auxiliary device on which the specified permanent file resides (refer to the DEFINE macro).

Entering the display code character zero (left-justified, binary zero fill) in this field overrides the pack name set by the PACKNAM command or macro. This causes the file to be processed on your family device.

r Type of auxiliary device identified by the pn parameter (refer to the DEFINE macro).

fo Family option:

 IP The pack name specified by a PACKNAM macro or pn parameter is ignored. PFM accesses your family.

sr Special request subfunction:

<u>sr</u>	<u>Description</u>
FA†	The file being attached must be a fast attach permanent file.
IE†	Ignore error idle status.
NF	The file being attached may not be a fast attach permanent file.

rt Real-time mode. If this parameter is specified (any value may be used), the job step is not delayed for any of the following conditions:

- The file must be staged to disk from MSE or tape alternate storage.
- A permanent file utility is currently active, preventing the ATTACH processing.
- The mass storage device on which the file resides is inaccessible.

If none of these conditions exist, the rt parameter has no meaning. If one of these conditions exists and the rt parameter is not specified, the job step is delayed until the operation is complete. If one of these conditions exists and the rt parameter is specified, the file is not attached. Instead, the operation to ensure that the file resides on disk is initiated. To complete the attach operation, another ATTACH macro with or without the rt parameter should be issued and the FET status checked to ensure that the file was accessed. The function of the rt parameter is also accomplished by setting the rt bit in the FET.

If a file is busy at the time the user program issues an ATTACH macro for the file, the system aborts the request. The user program can bypass the abort by specifying error processing (the ep bit, bit 44 of FET+1). If ep is set and the file is busy, the system returns control to the user program. The user program may then suspend the job by issuing a ROLLOUT macro. Normally, when a program issues a ROLLOUT macro to roll out a job subject to time/event dependencies, the program must include an address specifying the time period and/or event. However, when file busy status is returned, PFM sets up a time/event entry for the user program, specifying a rollout time period of 360g seconds. If the file becomes available before the time period expires, the job is rolled in at that time. The user program should then attempt the ATTACH once again.

Refer to the ATTACH command in Volume 3, System Commands, for a description of the current access modes that result when you attempt to attach an active file.

†The calling program must have an Ssj= entry point.

CHANGE (012, CCCG)

The CHANGE macro allows you to alter the attributes of one of your direct or indirect access permanent files without having to recreate the file. The pn and r parameters cannot be used to specify a new auxiliary device. They are used only to specify the auxiliary device on which ofn resides. Although all attributes that may be specified by parameters on the macro may also be specified using the appropriate fields in the FET, the file category, file access mode, file subsystem, and user control word must each have the top bit of the field set if they are to be specified in the FET for this request.

Macro format:

<u>Location</u>	<u>Operation</u>	<u>Variable</u>
	CHANGE	addr,ofn,nfn,pwd,ucw,ct,m,pn,r,fo,sr,ss,br,pr,xt,ac
addr		Address of the FET; the local file name must be set in FET+0.
ofn		Address containing the old permanent file name. If ofn is not specified, the contents of FET+0 is used instead.
nfn		Address containing the new permanent file name. If nfn is not specified, no name change takes place.
pwd		Address containing new password; replaces the old password or adds a new password if there was none before. If pwd is omitted, the contents of FET+18g bits 59 through 18 are used as the new password. If you do not wish to change the current password, either FET+12g must be set to 42/7777777777777777B,18/0 or the contents of location pwd must be set to 42/7777777777777777B,18/0.
ucw		Address of word containing user control information; bit 59 of the word must be set if this information is to be used. If ucw is not specified, the contents of FET+13g are used instead; bit 59 of FET+13g must be set in that case.
ct		File category:

<u>ct</u>	<u>Value (Octal)</u>	<u>Description</u>
P	40	Private file.
S	41	Semiprivate.
PU	42	Public file.

Refer to PFM Macro Parameter Conventions in this section for further information.

m File mode. This parameter defines the type of access alternate users may have for semiprivate or public files.

<u>m</u>	<u>Value (Octal)</u>	<u>Description</u>
W	40	Read, write, modify, append, update, purge, and execute (default value).
R	41	Read and execute.
A	42	Append.
E	43	Execute.
N	44	None.
M	45	Modify, append, update, read, and/or execute.
RM	46	Read and/or execute, allow simultaneous access in modify, append, or update mode.
RA	47	Read and/or execute, allow simultaneous access in append mode.
U	50	Update.
RU	51	Read and/or execute, allow simultaneous access in update mode.

Refer to PFM Macro Parameter Conventions in this section for further information.

pn Address containing the one- to seven-character pack name of the auxiliary device on which the file resides.

Entering the display code character zero (left-justified, binary zero fill) in this field overrides the pack name set the the PACKNAM command or macro. This causes the request to be processed on your family device.

r Address containing the type of auxiliary device identified by the pn parameter (refer to the DEFINE macro).

fo Family option:

IP The pack name specified by a PACKNAM macro or pn parameter is ignored. PFM accesses your family.

sr Special request subfunction (only one may be specified):

CE Clear file error code in the catalog entry (refer to the CATLIST macro for a description of the catalog entry).

CP Reset the charge number and project number for the file to your job's current charge and project number.

ss Subsystem indicator. This indicator causes automatic subsystem selection when the file is retrieved using the OLD macro or command.

<u>ss</u>	<u>Description</u>
NULL	Null system.
BASIC	BASIC subsystem.
FORT	FORTRAN 5 subsystem.
FTNFS	FORTRAN Extended 4 subsystem.
EXEC	Execute subsystem.
BATCH	Batch subsystem.

Refer to PFM Macro Parameter Conventions in this section for further information.

br Backup requirement. Specifies whether the file is to be backed up on a dump tape when the site dumps permanent files.

<u>br</u>	<u>Description</u>
Y	The file must be backed up on the dump tape.
MD	Back up file on dump tape only if it does not reside on alternate storage.
N	The file is not to be backed up on the dump tape.

If the backup requirement is not to be changed, the br field of the FET must be 0.

Refer to PFM Macro Parameter Conventions in this section for further information.

pr Preferred residence. Specifies whether you prefer the file to reside on disk or on alternate storage.

<u>pr</u>	<u>Description</u>
M	The file should reside on alternate storage when it is not being accessed.
N	No preferred residence for the file.
D	The file should reside on disk at all times.
L	The file will be locked to disk (special validation is required for this option).

If the preferred residence is not to be changed, the pr field of the FET must be 0.

Refer to PFM Macro Parameter Conventions in this section for further information.

xt Expiration term or date for password. xt is the address of a word containing either the packed expiration date (format: yymmdd, where yy is the year minus 1970), or the expiration term, the number of days (<7777g) to be added to the current date to determine the expiration date. A value of 7777g indicates a nonexpiring password. If this parameter is not specified when a password is established, the system creates a nonexpiring password. You must be validated to assign a permanent file expiration date in order to use this parameter; also, your site may choose to limit the maximum expiration term you may specify. This parameter may not be specified without also specifying the pwd parameter unless the file already has a password.

ac Alternate CATLIST permission. Specifies whether alternate users may obtain information about the file using CATLIST.

<u>ac</u>	<u>Description</u>
N	Permission denied.
Y	Permission granted.

Refer to PFM Macro Parameter Conventions in this section for further information.

Example 1:

This changes file DATA on auxiliary device PACK1 to FILE with read-only access.

```
CHANGE F,PF,NF,PW,,,,R,PKN
.
.
.
F      FILEB  BUF,BUFL,(FET=14D)
PF     VFD    42/OLDATA,18/O
NF     VFD    42/OLFILE,18/O
PKN    VFD    42/OLPACK1,18/O
PW     VFD    42/-0,18/O
```

Example 2:

This example changes the backup requirement of file DATA to MD (backup file on dump tape only if it does not reside on MSE) and the preferred residence to M (MSE).

```
CHANGE DATA,,,PW,,,,,,,,,MD,M
.
.
.
DATA   FILEB  BUF,BUFL,(FET=16D)
PW     VFD    42/-0,18/O
```

OLD (021, CCOD)

The OLD macro enables the user program to obtain a temporary copy of an indirect access permanent file and make it the primary file. If a local file by the same name already exists, it is returned as if the UNLOAD macro had been issued even if the OLD is unsuccessful. If a primary file exists (with a different local file name) before the OLD request, it is converted to a local (LOFT) file. The new primary file is set to rewind status. No interlock is provided to prevent other users from obtaining copies of the same file simultaneously.

The OLD macro also sets the subsystem index associated with the file.

The local file created by an OLD macro call may be an execute-only file, depending on the access mode permitted to the user name associated with the user program. PFM returns the access mode of the file in the mode field (FET+10g, bits 0 through 5) if the FET is long enough; the user program can examine this field to determine the access mode. If the FET is long enough, the user control word (ucw) is returned to FET+13g, and the subsystem is returned to FET+17g, bits 59-57.- Refer to PFM Macro Parameter Conventions in this section for a list of access modes and subsystems.

If the access level bit (bit 39 of FET+1) is set, the access level of the file is returned to bits 38 through 36 of FET+4.

Macro format:

<u>Location</u>	<u>Operation</u>	<u>Variable</u>
	OLD	addr,pfn,un,pwd,pn,r,fo
addr		Address of the FET; the local file name must be set in FET+0.
pfn		Address containing the name of the file; name the file is given in the permanent file catalog.
un		Address containing the name of the alternate user whose catalog is to be searched for the file specified; if this parameter is specified, the permission mode is that which the user has been permitted for private files or that specified in the catalog for semiprivate and public files.
pwd		Address containing the password of the file; required if un#0 and the file requires a password.
pn		Address containing one- to seven-character pack name of the auxiliary device from which the file is to be retrieved. Entering the display code character zero (left-justified, binary zero fill) in this field overrides the packname set by the PACKNAM command or macro. This causes the file to be saved on the family device of the user name associated with the user program.
r		Type of auxiliary device on which the indirect access permanent file resides (refer to the DEFINE macro).
fo		Family option: IP The pack name specified by a PACKNAM macro or pn parameter is ignored. PFM accesses your family.

SETPFAC (022,CCAC)

The SETPFAC macro enables the user program to change the security access category set of a permanent file.

If this function is to be performed on a direct access file, the file must not be attached to any job.

Macro format:

<u>Location</u>	<u>Operation</u>	<u>Variable</u>
	SETPFAC	addr,pfn,cat,pn,r
addr		Address of the FET for the file.
pfn		Address containing the name (left-justified, binary zero fill) of the permanent file whose access category set is to be changed. If this parameter is omitted, the contents of FET+0 are used for the permanent file name.
cat		Address containing the new security access category set for the file. Each of bits 0 through 31 that is set in this word sets the corresponding security access category. The access categories specified must be valid for your job (refer to Security Access Categories in section 1). The system OPL common deck COMCVLC can be used to convert access category names to numerical values and vice versa.
pn		Address containing the one- to seven-character pack name of the auxiliary device on which the file resides.
r		Type of auxiliary device identified by the pn parameter (refer to the DEFINE macro).

SETPFAL (023,CCAL)

The SETPFAL macro enables the user program to change the security access level of a permanent file. This macro requires the system OPL common deck COMSMLS.

If this function is to be performed on a direct access file, the file must not be attached to any job.

Macro format:

<u>Location</u>	<u>Operation</u>	<u>Variable</u>
	SETPFAL	addr,pfn,al,pn,r
addr		Address of the FET for the file.
pfn		Address containing the name (left-justified, binary zero fill) of the permanent file whose access level is to be changed. If this parameter is omitted, the contents of FET+0 are used for the permanent file name.
al		The security access level to be assigned to the file. al can be either the name of the security access level, or the address of a word containing the numerical value of a security access level, right-justified with binary zero fill. To convert an access level name to a numerical value (or vice versa), use system OPL common deck COMCVLC. The access level specified must be valid for your job (refer to Security Access Levels in section 1) and valid for the device on which the file resides.
pn		Address containing the one- to seven-character pack name of the auxiliary device on which the file resides.
r		Type of auxiliary device identified by the pn parameter (refer to the DEFINE macro).

The following examples show two different ways to specify an access level using the SETPFAL macro.

Example 1:

In this example, the file's access level is specified in the macro call and therefore must be an access level name.

```
      .  
      .  
      .  
OPL   XTEXT  COMSMLS  
OPL   XTEXT  COMCPFM  
TEST  FILEB  BUF,101B,(FET=13D)  
BUF   BSS    101B  
      .  
      .  
      .  
      SETPFAL TEST,,LVL3  
      .  
      .  
      .
```

Example 2:

In this example, the file's access level is specified in a separate word and therefore must be a numerical value.

```
      .  
      .  
      .  
OPL   XTEXT  COMSMLS  
OPL   XTEXT  COMCPFM  
TEST  FILEB  BUF,101B,(FET=13D)  
BUF   BSS    101B  
LEVEL CON    3  
      .  
      .  
      .  
      SETPFAL TEST,,LEVEL  
      .  
      .  
      .
```

Control point manager (CPM) enables your program to alter or interrogate parameters in your job's control point area.

Unless otherwise noted, all errors encountered by CPM cause the job step to be aborted; no user error processing is available.

The format of the call to CPM is:

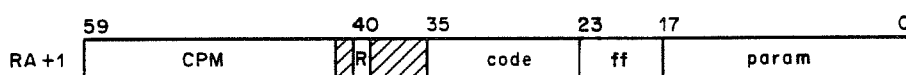

- R Auto recall bit.
- code CPM function code.
- ff Subfunction code for functions 003 and 017.
- param Parameter for the function.

Common decks required for absolute assemblies by the functions processed by CPM are COMCCPM and COMCSYS. For relocatable assemblies, these decks are satisfied by default from the library SYSLIB.

SETPR (001)

The SETPR macro decreases the CPU priority of a job. A user job cannot increase its priority.

Upon job initiation, a job is assigned the maximum priority allowed for its service class. (The installation defines these priority values.) If a job's CPU priority is lower than that of other jobs, the job is assigned control of the CPU only when jobs of a higher priority do not need it.

Macro format: †

<u>Location</u>	<u>Operation</u>	<u>Variable</u>
	SETPR	n
n		CPU priority; (1 ≤ n ≤ 708).

† This macro is not available in SYSTEXT. The user program must specify systems text PSSTEXT or call common deck COMCCMD or COMCMAC (refer to appendix F).

MODE (002)

The MODE macro defines the error conditions that cause the system to exit from normal processing and, on CYBER 180-class models, changes the instruction stack purging status of the central processor (refer to the exchange package description in appendix E).

When the error specified in a MODE macro occurs, the system sets the appropriate error flag and exits from normal processing to perform any error processing required. If an error occurs for which the user program did not select the exit mode processing, the system ignores the error and continues normal processing.

Macro format:†

<u>Location</u>	<u>Operation</u>	<u>Variable</u>
	MODE	m,n,p
m	CPU program error exit mode.	
n	This parameter is included for compatibility with earlier versions of NOS. The value supplied is ignored.	
p	Instruction stack purging (CYBER 180-class models only):	
	0	Normal instruction stack purging.
	1	Extended instruction stack purging.

The processor will exit when
this condition occurs

If m has one of these octal values

Address out of range (automatically
selected for model 176)

1, 3, 5, 7, 11, 13, 15, 17††

Operand out of range (overflow only
on model 176)

2, 3, 6, 7, 12, 13, 16, 17

Indefinite operand

4, 5, 6, 7, 14, 15, 16, 17

Underflow (model 176 only)

10, 11, 12, 13, 14, 15, 16, 17

The maximum value and default on all models except model 176 is 7, indicating that the processor exits on all conditions. The maximum value on model 176 is 17, indicating that the processor exits on all conditions. The default value on model 176 is 7, indicating that the processor exits on all conditions except underflow.

†This macro is not available in SYSTEXT. The user program must specify systems text PSSTEXT or call common deck COMCCMD or COMCMAC (refer to appendix F).

††On a model 176, the address out of range error will always cause a processor exit. Therefore, any attempt to disable this type of exit (by specifying a value not included in this set) on a model 176 will cause an informative message to be issued to the dayfile.

Instruction stack purging on CYBER 180-class models can be made normal or extended by supplying an appropriate value for p. The initial status of stack purging is site-selectable. When stack purging is normal, the processor purges the instruction stack after executing an exchange jump, return jump, unconditional branch, or extended memory read instruction. When stack purging is extended, the processor also purges the instruction stack after central memory store and conditional branch instructions. Under normal circumstances, the CYBER 180-class models processor fetches the contents of the branch destination address prior to executing the branch; this could cause programs that do code modification to fail unless stack purging is extended.

An attempt to change the stack purging status on any machine other than CYBER 180-class models aborts the program.

Null or omitted parameters remain unchanged if fewer than three values are supplied on the macro call. Changes made to exit mode or stack purging status remain in effect for subsequent job steps unless explicitly changed by a MODE or MACHINE command or a MODE macro.

Examples:

Setting m to 6 on all models other than a model 176 selects error exiting on operand out of range and indefinite operand. On a model 176, address out of range cannot be deselected; it is automatically set by the system. Setting m to 6 or 7 on a model 176 would yield the same results.

Setting m to 13g on a model 176 selects underflow and error exiting on operand out of range. Setting m to 12g would also accomplish this.

SETASL (003)

The SETASL macro allows the user program to specify the account block SRU limit for a job. The account block limit is the maximum number of SRUs that can be accumulated by a job.

If s is greater than or equal to 77770g, the account block SRU limit is set to the maximum for which you are validated (infinite if unlimited validation).

For interactive jobs, this function defines the number of SRUs allowed for a job before entry of another CHARGE command is required. For batch or interactive jobs, s represents the maximum SRU accumulation between two CHARGE commands or between one CHARGE command and the end of the job. The account block limit may not be set to a value less than the current job step limit.

Macro format:†

<u>Location</u>	<u>Operation</u>	<u>Variable</u>
	SETASL	s
s		Account block SRU limit.

†This macro is not available in SYSTEXT. The user program must specify systems text PSSTEXT or call common deck COMCCMD (refer to appendix F).

SETJSL (003)

The SETJSL macro allows the user program to specify the job step SRU limit for each step of a job, including the current job step. The job step limit is the maximum number of SRUs that can be accumulated by a single job step. The job step limit must not exceed the account block limit (refer to SETASL macro).

Each user name and each charge/project number is validated for a maximum SRU limit. If s is greater than or equal to 7777708, the job step SRU limit is set to the maximum for which you are validated (infinite if unlimited validation).

Macro format:†

<u>Location</u>	<u>Operation</u>	<u>Variable</u>
	SETJSL	s
s		Job step SRU limit.

SETTL (003)

The SETTL macro changes the user program's CPU job step time limit for each job step, including the current job step. The CPU job step time limit is the amount of time (in seconds) that a job step is allowed to use the CPU.

Each user is validated for a maximum time limit (refer to the LIMITS command in Volume 3, System Commands). If t is equal to 777778, the time limit is set to the maximum for which you are validated (infinite if unlimited validation).

Macro format:†

<u>Location</u>	<u>Operation</u>	<u>Variable</u>
	SETTL	t
t		Job step time limit (1<t<777778).

†This macro is not available in SYSTEXT. The user program must specify systems text PSSTEXT or call common deck COMCCMD (refer to appendix F).

EREXIT (004)[†]

NOS allows a user program to specify an error processing routine address. When an error occurs during program execution, the system causes the routine at that address to begin executing. If an additional error occurs while the error processing routine is executing, the job step aborts.

NOTE

An error will occur if an EREXIT macro is issued while REPRIEVE processing is in effect (REPRIEVE processing is described in section 10 of this manual). If an EREXIT macro is issued while DISTC processing is in effect, EREXIT processing will be established and DISTC processing will no longer be in effect (DISTC processing is described in section 11 of this manual).

Macro format:

<u>Location</u>	<u>Operation</u>	<u>Variable</u>
	EREXIT	addr

addr Address for error exit return.

As an example, a common procedure is for the program's preset routines to set the error exit processing.

Routine to complete processing when an error is encountered	}	ERR	SA1	BO	READ ERROR RETURN INFO	
				ENDRUN		TERMINATE PROGRAM
		PRS	SUBR			PROGRAM PRESET ROUTINE
			EREXIT	ERR		SET ERROR EXIT ADDRESS
		EQ	PRSX			
		END				

[†]It is recommended that you use extended reprieve processing (refer to section 10) rather than EREXIT wherever possible.

The following information is returned to location RA+0 if an error occurs at any time after an EREXIT request.

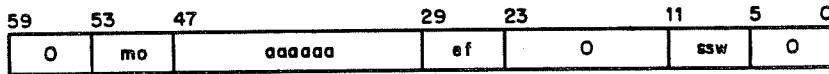

mo Mode of CPU error exit. For all computer systems except the model 176, the mode bit is set for the indicated EM register bit (refer to Exchange Package Area, appendix E).

<u>mo Bit</u>	<u>EM Bit</u>	<u>Meaning</u>
53	59	CM data error.†
52	58	CMC input error.†
51	57	EEM flag register operation parity error.†
50	50	Indefinite operand.
49	49	Operand out of range.
48	48	Address out of range.

If an mo bit is not set, the error is due to an illegal instruction.

For model 176, the following mode bits are set for the indicated PSD register bit (refer to Exchange Package Area, appendix E).

<u>mo Bit</u>	<u>PSD Bit</u>	<u>Meaning</u>
53	46	CM error condition.
52	--	Not used.
51	--	Not used.
50	38	Indefinite condition.
49	37	Overflow condition.
48	45	LCME block range condition.
48	44	CM block range condition.
48	43	LCME direct range condition.
48	42	CM direct range condition.
48	41	Program range condition.

The LCME error condition (PSD bit 47) and step condition (PSD bit 39) are not mapped to mo.

aaaaaa CPU address of the job when the error occurred.

ef Error flag. Refer to appendix E for a list of error flags.

ssw Status of sense switches.

†Models 171, 172, 173, 174, 175, 720, 730, 750, 760, 865, and 875 only.

ROLLOUT (006)

The ROLLOUT macro places a job in the rollout queue until a specified event occurs or for a fixed period of time. This function may be useful if a program requires a direct access permanent file that is currently busy.

Macro format:†

<u>Location</u>	<u>Operation</u>	<u>Variable</u>
	ROLLOUT	addr

addr Address containing the time and/or event dependencies; if addr is not specified, the job is rolled out without time or event dependencies.

The following information must be set at location addr:

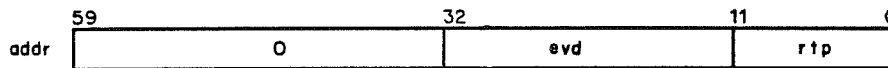

evd Event descriptor. System programs use the EESET macro†† to make entries in a system event table indicating the occurrence of an event. The system compares the specified descriptor, evd, with events recorded in the table. If a match is detected, the job becomes eligible for rollin.

evd≠0 evd and rtp are placed in the control point area (TERW). When the job rolls out, the scheduler waits for the occurrence of evd or for the time period, rtp, to elapse before initiating rollin. Because the job may roll in for two different reasons, it is the user program's responsibility to verify whether the specified event actually occurred. Refer to system OPL common deck COMSEVT for a list of events.

evd=0 The job scheduler uses the value of evd already in the control point area. This option allows the user to roll out while waiting for a system-specified event. One such event is the event that is set up when an ATTACH request fails because of a busy file (refer to section 5). In this case, the event is the return of the file.

evd=EXTM+00nng (0200nng) Specifies extended time rollout with no event dependency. The job rolls out for (7777g x nn) + rtpg job scheduler delay intervals. The symbol EXTM is defined in the system OPL common deck COMSEVT.

rtp Rollout time period in job scheduler delay intervals (roughly 1 second each)††† where 0<rtp<4095 (7777g).

If rtp is zero, the scheduler uses the value of rtp already in the control point area. If evd is also zero, the job rolls out waiting for a system specified event. If the event goes undetected or never occurs, the job rolls in after a system-determined time interval.

†This macro is not available in SYSTEXT. The user program must specify systems text PSSTEXT or call common deck COMCMAC (refer to appendix F).

††Obtain a listing of COMCMAC for internal documentation of the EESET macro and the ROLLOUT macro and for a description of valid event descriptors.

†††The value of the job scheduler delay interval varies from site to site. Contact your site analyst to determine the value at your site.

SETSSM (010)

The SETSSM macro enables the user program to set or clear the secure system memory (SSM) flag. Setting this flag prevents the dumping of any portion of the job field length.

NOTE

While the SSM flag is set, certain system requests cannot be performed (refer to Security Considerations, section 1). In addition, certain system commands cannot be issued immediately following a program in which the SSM flag is set. Refer to Security Control in Volume 3, System Commands, for a list of these commands.

Macro format:†

<u>Location</u>	<u>Operation</u>	<u>Variable</u>
	SETSSM	p
p		Clear SSM flag if lower 12 bits of p are zero; set SSM flag if lower 12 bits of p are nonzero.

† This macro is not available in SYSTEXT. The user program must specify systems text PSSTEXT or call common deck COMCMAC (refer to appendix F).

ONSW (011)

The ONSW macro sets the sense switches for a program (refer to figure E-1). This allows the user program to set switches for options for subsequent job steps in the job.

The sense switches reside both in the job's control point area and in bits 11 through 6 of RA+0 of the job field length. The field in RA+0 may be used by the user program to check sense switch settings; however, changing a bit in RA+0 will not cause the bit in the control point area to be changed. The field in RA+0 is set equal to the field in the control point area at the beginning of each job step, or if an error occurs. An ONSW (or OFFSW) request updates both fields separately.

The bit position specifies the switch to be set.

Macro format:

<u>Location</u>	<u>Operation</u>	<u>Variable</u>
	ONSW	n

n Switches to be set; $0 \leq n < 77_8$; bit 0 corresponds to switch 1, bit 1 corresponds to switch 2, and so forth. If a bit is set, the corresponding switch is set; for example, ONSW 52_8 sets switches 2, 4, and 6. If $n=77_8$, all switches are set. If $n=0$, all switches remain unchanged.

OFFSW (012)

The OFFSW macro enables the user program to clear the sense switches for the job. Refer to the description of the ONSW macro for a discussion of sense switch settings.

Macro format:

<u>Location</u>	<u>Operation</u>	<u>Variable</u>
	OFFSW	n

n Switches to be cleared; $0 \leq n < 77_8$; bit 0 corresponds to switch 1, bit 1 corresponds to switch 2, and so forth. If a bit is set, the corresponding switch is cleared; for example, OFFSW 52_8 clears sense switches 2, 4, and 6. If $n=77_8$, all switches are cleared. If $n=0$, all switches remain unchanged.

GETJN (013)

The GETJN function allows the user program to determine the job sequence name (JSN) of the job. For the format of the JSN, refer to Volume 3, System Commands.

Macro format:†

<u>Location</u>	<u>Operation</u>	<u>Variable</u>
	GETJN	addr

addr Address to receive job sequence name, left-justified.

The following information is returned to location addr:

59	jsn	35	0
----	-----	----	---

jsn Job sequence name for the job.

GETPR (015)

The GETPR function allows the user program to determine the CPU priority of the current job.

Macro format:†

<u>Location</u>	<u>Operation</u>	<u>Variable</u>
	GETPR	addr

addr Address where the CPU priority is returned.

The following information is returned to location addr:

59	0	11	0	pr
----	---	----	---	----

pr CPU priority.

† This macro is not available in SYSTEXT. The user must specify systems text PSSTEXT or call common deck COMCMAC (refer to appendix F).

GETEM (016)

The GETEM macro enables the user program to determine under what exit mode the job is currently running.

Macro format:†

<u>Location</u>	<u>Operation</u>	<u>Variable</u>
	GETEM	addr

addr Address for return of current exit mode in bits 11 through 0.

GETASL (017)

The GETASL macro returns the account block SRU limit for the job (refer to SETASL macro) to the specified address.

Macro format:†

<u>Location</u>	<u>Operation</u>	<u>Variable</u>
	GETASL	addr

addr Address to receive account block SRU limit.

The following information is returned to location addr:

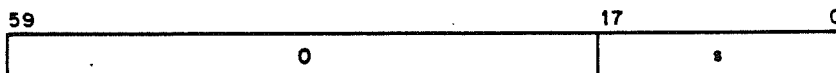

s Account block SRU limit.

†This macro is not available in SYSTEXT. The user program must specify systems text PSSTEXT or call common deck COMCMAC or COMCCMD (refer to appendix F).

GETJSL (017)

The GETJSL macro returns the job step SRU limit for the current job step (refer to SETJSL macro) to the specified address.

Macro format: †

<u>Location</u>	<u>Operation</u>	<u>Variable</u>
	GETJSL	addr

addr Address to receive job step SRU limit.

The following information is returned to location addr:



s Job step SRU limit.

GETTL (017)

The GETTL macro returns the time limit for the current job step.

Macro format: †

<u>Location</u>	<u>Operation</u>	<u>Variable</u>
	GETTL	addr

addr Address to receive time limit.

The following information is returned to location addr:

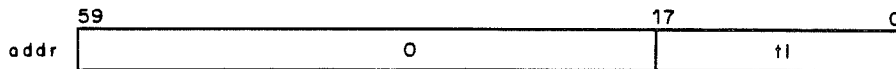

tl CPU job step time limit (in seconds).

† This macro is not available in SYSTEXT. The user program must specify systems text PSSTEXT or call common deck COMCCMD or COMCMAC (refer to appendix F).

SETLC (022)

The SETLC macro enables the user program to set the loader control word for subsequent loader requests.

Macro format:†

<u>Location</u>	<u>Operation</u>	<u>Variable</u>
	SETLC	addr

addr Address of the loader control word to be set.

The following information must be set in location addr:



<u>Field</u>	<u>Bit(s)</u>	<u>Description</u>
v	59	Map validation bit. If bit is not set, default map option is used.
l	58	If bit is set, global library set is active.
mc	57-54	Map control bits (octal): <ul style="list-style-type: none"> 00 No map is produced. 01 Statistics and errors. 02 Block assignments. 03 Partial map providing statistics, errors, and block assignments. 04 Entry points. 14 External references and entry points. 17 Full map providing information given individually by control bits 01, 02, 03, and 14.
n	53	Prevents field length reduction after relocatable load.
r	49	If bit is set, request relocatable load from user library.
u	48	If bit is set, program was loaded from a user library.
g	23-0	Global library set indicators.

The global library set indicators, contained in the loader control word (location LBlW in the user's control point area), are maintained by the SETLC macro. The user program should call the GETLC macro before using the SETLC macro to avoid destroying the library set information. With the GETLC macro, the user program can obtain the current loader control word. The program can then change the v, mc, and n fields, and issue a SETLC macro.

†This macro is not available to SYSTEXT. The user program must specify systems text PSSTEXT or call common deck COMCCMD (refer to appendix F).

SETRFL (023)

The SETRFL macro sets the initial central memory and extended memory field lengths for a job step. The specified values are used unless the system encounters one of the following:

- A system routine whose field lengths are specified during system creation.
- A routine that specifies the amount of CM or extended memory field length required in a 54 loader table (refer to CYBER Loader Reference Manual).
- An MFL or RFL command (refer to Volume 3, System Commands) or a subsequent SETMFL or SETRFL macro.

If you do not use the SETRFL function or the RFL command, the operating system determines how much field length to assign initially for each job step.

The CM field length is rounded upward to a multiple of 100g words. The extended memory field length is rounded upward to a multiple of 1000g words.

The values specified for CM field length and EM field length cannot exceed the current MFL values for the job (refer to the SETMFL macro in this section).

Macro format:†

<u>Location</u>	<u>Operation</u>	<u>Variable</u>
	SETRFL	n,m
n		New CM field length parameter.
m		New extended memory field length parameter.

NOTE

This request does not change the amount of memory currently available for use by the user program. To change the amount of memory currently available for use, use the MEMORY macro.

† This macro is not available in SYSTEXT. The user program must specify systems text PSSSTEXT or call common deck COMCCMD (refer to appendix F).

GETJCR (024)†

The GETJCR macro enables the user program to interrogate the job control registers associated with the job (refer to the description of execution control commands in Volume 3, System Commands). The last error flag encountered can also be determined.

Macro format: ††

<u>Location</u>	<u>Operation</u>	<u>Variable</u>
	GETJCR	addr

addr Address for return of the job control registers.

The following information is returned to location addr:

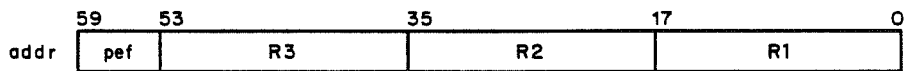

pef The last error flag encountered (refer to the EREXIT function for the values).

R3 Job control register 3.

R2 Job control register 2.

R1 Job control register 1.

† You may choose to use the GETJCI macro instead of GETJCR, since GETJCI returns more information.

†† This macro is not available in SYSTEXT. The user program must specify systems text PSSTEXT or call common deck COMCMAC (refer to appendix F).

SETJCR (025)†

The SETJCR macro enables the user program to set the job control registers for the job. Refer to the description of the GETJCR macro for the format of the word.

Macro format:††

<u>Location</u>	<u>Operation</u>	<u>Variable</u>
	SETJCR	addr

addr Address of the word containing the job control registers to be set.

The following information must be set at location addr:

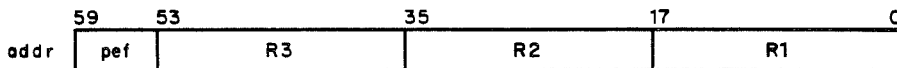

pef	Previous error flag.
R3	Job control register 3.
R2	Job control register 2.
R1	Job control register 1.

SETSS (026)

The SETSS macro changes the interactive subsystem under which your job is currently executing, provided you are validated for that subsystem.

Macro format:††

<u>Location</u>	<u>Operation</u>	<u>Variable</u>
	SETSS	ss

ss Subsystem ordinal (refer to the TSTATUS macro, section 11, for a description of subsystem ordinals).

†You should use the SETJCI macro instead of SETJCR.

††This macro is not available in SYSTEXT. The user program must specify systems text PSSTEXT or call common deck COMCMAC (refer to appendix F).

GETJO (027)

The GETJO macro returns the job origin code to the specified address.

Macro format:†

<u>Location</u>	<u>Operation</u>	<u>Variable</u>
	GETJO	addr

addr Address to receive job origin code. Refer to appendix E for legal job origin codes.

The following information is returned to location addr:

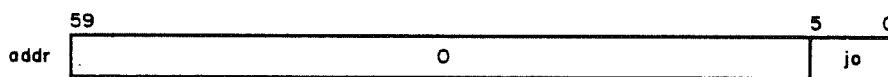

jo Job origin code.

GETJA (030)

The GETJA macro returns a five-word reply block containing job accounting information beginning at the specified address.

Macro format:†

<u>Location</u>	<u>Operation</u>	<u>Variable</u>
	GETJA	addr

addr Address of reply block.

The following information is returned to the five-word reply block beginning at location addr:

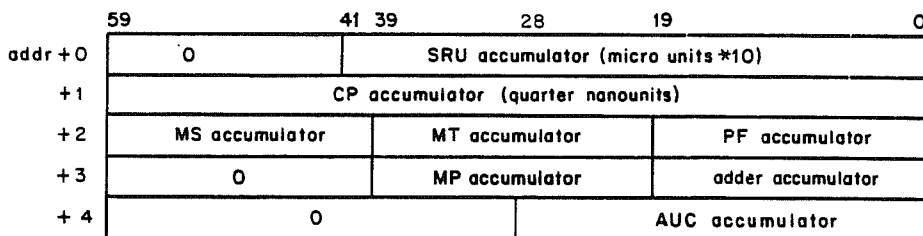

Nanounits are calculated as nanoseconds multiplied by the CPU accounting multiplier (refer to Resource Accounting in section 5 of the NOS 2 Administration Handbook).

†This macro is not available in SYSTEXT. The user program must specify systems text PSSTEXT or call common deck COMCMAC (refer to appendix F).

USECPU (031)

The USECPU macro specifies which central processor is to be used when more than one is available.

Macro format:

<u>Location</u>	<u>Operation</u>	<u>Variable</u>
	USECPU	n

<u>n</u>	<u>Description</u>
0	Either central processor can be used.
1	CPU 0 is to be used (the CPU with functional units on a 6700 or CDC CYBER 74-2x).
2	CPU 1 is to be used (the CPU without functional units on a 6700 or CDC CYBER 74-2x).

USERNUM (032)

The USERNUM macro returns the user name under which the job is running to the specified address.

Macro format:

<u>Location</u>	<u>Operation</u>	<u>Variable</u>
	USERNUM	addr

addr Address to receive the user name, left-justified and zero-filled.

GETFLC (033, 055)

The GETFLC macro returns the field length control word from the job's control point area to the specified address.

Macro format: †

<u>Location</u>	<u>Operation</u>	<u>Variable</u>
	GETFLC	caddr, eaddr

caddr Address to receive the central memory field length control word.

eaddr Address to receive the extended memory field length control word.

The GETFLC request can include either or both of the addresses. The field length control words are returned in the following format (multiply each 12-bit field by 100₈ for caddr or 1000₈ for eaddr to obtain the actual value).

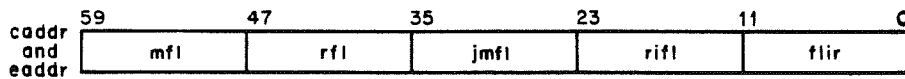

- mfl Maximum CM or extended memory field length for the current job step. This value may be reset with the MFL command (refer to Volume 3, System Commands) or the SETMFL macro.
- rfl Initial running CM or extended memory field length for a job step. This value is always less than or equal to mfl and is set with the RFL command or the SETRFL macro. A value of zero indicates that the system controls the field length.
- jmfl Maximum CM or extended memory field length for the entire job. The jmfl represents the upper bound on mfl.
- rifl CM or extended memory field length for the job when it is to be rolled in.
- flir CM or extended memory field length increase requested.

† This macro is not available in SYSTEXT. The user program must specify systems text PSSTEXT or call common deck COMCMAC (refer to appendix F).

PACKNAM (035)

The PACKNAM (035) request specifies a default pack name and device type for your job. It allows the user program to omit the pn and r parameters from PFM requests for files residing on the auxiliary device. If a PACKNAM request is in effect and you wish to access permanent files on another auxiliary device, you can either specify the pn and r parameters in the PFM request or issue another PACKNAM macro. To access permanent files on your permanent file family device while a PACKNAM request is in effect, either specify a display code zero as the pn parameter in the PFM request or issue another PACKNAM macro with a binary zero pack name.

Macro format:†

<u>Location</u>	<u>Operation</u>	<u>Variable</u>
	PACKNAM	addr

addr Address of parameter word.

Parameter word format:

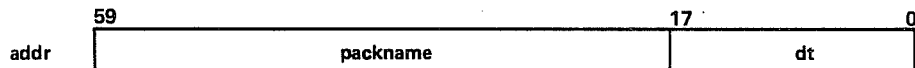

packname One- to seven-character alphanumeric pack name, left-justified, zero-filled. If this field is binary zero, any existing pack name and device type are cleared.

dt Three-character alphanumeric device type. The first two characters represent the type of auxiliary device (refer to appendix E); the third character indicates the number of spindles in a multispindle device. If the third character is omitted, the default is 1; if the entire field is zero, the default is the system pack type (set by the installation).

†This macro is not available in SYSTEXT. The user program must specify systems text PSSTEXT or call common deck COMCCMD (refer to appendix F).

PACKNAM (036)

The PACKNAM (036) request returns the default pack name and device type to the specified address.

Macro format:†

<u>Location</u>	<u>Operation</u>	<u>Variable</u>
	PACKNAM	addr,N

addr Address to which the pack name and device type are to be returned.

N Indicates that the pack name and device type are to be returned.

The following information is returned to location addr:

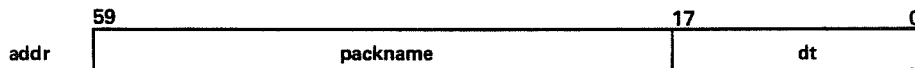

packname One- to seven-character alphanumeric default pack name, left-justified, zero-filled. (If no pack name is set, binary zero is returned.)

dt Three-character alphanumeric default device type. The first two characters represent the type of auxiliary device (refer to appendix E); the third character indicates the number of spindles in a multispindle device.

GETSS (037)

The GETSS macro returns the current subsystem ordinal to the specified address.

Macro format:††

<u>Location</u>	<u>Operation</u>	<u>Variable</u>
	GETSS	addr

addr Address to receive subsystem ordinal (refer to TSTATUS macro, section 11, for a description of subsystem ordinals).

The following information is returned to location addr:

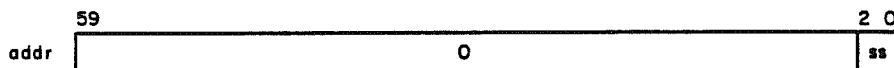

ss Subsystem ordinal.

†This macro is not available in SYSTEXT. The user program must specify systems text PSSTEXT or call common deck COMCCMD (refer to appendix F).

††This macro is not available in SYSTEXT. The user must specify systems text PSSTEXT or call common deck COMCMAC (refer to appendix F).

VERSION (044)

The VERSION macro returns the version name of the operating system (and, optionally, the system title line) from central memory to the specified location.

Macro format:†

<u>Location</u>	<u>Operation</u>	<u>Variable</u>
	VERSION	addr

addr Address of word containing macro parameters.

The following information must be specified at location addr:

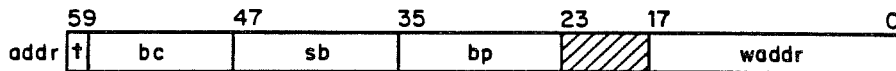

- t If set, indicates that the system title line is to be returned in addition to the operating system version name.
- bc Number of bytes†† (1 to 10 or, if t is specified, 1 to 30) to return from source field (CM location containing version name and, optionally, system title).
- sb Byte†† in source field at which to begin transfer (0 to 9 or, if t is specified, 0 to 29); the sum of bc and sb must be less than 11 (less than 31 if t is specified).
- bp Byte†† position within receiving field (waddr) at which to begin transfer (0 to 4).
- waddr Beginning address of three-word block (seven-word block if t is specified) to receive data.

†This macro is not available in SYSTEXT. The user program must specify systems text PSSTEXT or call common deck COMCCMD or COMCMAC (refer to appendix F).

††In this context, the term byte refers to a 12-bit (2-character) field. There are five bytes in a CM word, numbered from 0 to 4 from left to right.

GETLC (045)

The GETLC macro returns the loader control word to the specified address. Refer to the SETLC macro for the format of the loader control word.

Macro format: †

<u>Location</u>	<u>Operation</u>	<u>Variable</u>
	GETLC	addr

addr Address to receive the loader control word.

GETGLS (046)

The GETGLS macro returns the global library set from the job's control point area. Refer to the CYBER Loader Version 1 Reference Manual for a discussion of global library sets. A parameter word is used to specify where a list of logical file names is to be placed.

Macro format: ††

<u>Location</u>	<u>Operation</u>	<u>Variable</u>
	GETGLS	addr

addr Address of parameter word.

Parameter word format:

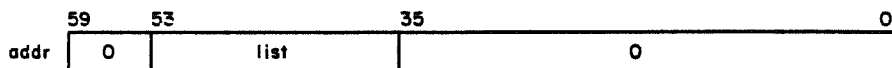

list Beginning address to which the logical file names (left-justified) contained in the global library set are written. The value of this parameter is updated to the address of the word following the last library (list+n+1) upon completion.

† This macro is not available in SYSTEXT. The user program must specify systems text PSSTEXT or call common deck COMCCMD or COMCMAC (refer to appendix F).

†† This macro is not available in SYSTEXT. The user program must specify systems text PSSTEST or call common deck COMCMAC (refer to appendix F).

The following information is returned to locations list through list+n:

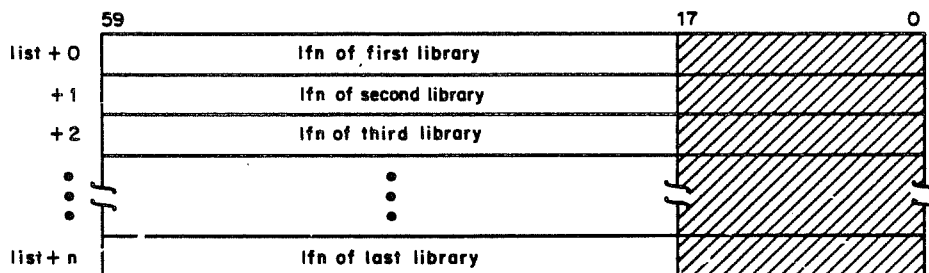

n The number of libraries defined in the global library set minus one.

lfn The name of a global local library or the name of a system library.

SETGLS (047)

The SETGLS macro enables the user program to define the global library set indicators in the job's control point area. Refer to the CYBER Loader Version 1 Reference Manual for a discussion of global library sets. A parameter word specifies where the list of logical file names used to define the global library set is located.

Macro format:†

<u>Location</u>	<u>Operation</u>	<u>Variable</u>
	SETGLS	addr

addr Address of parameter word.

Parameter word format:

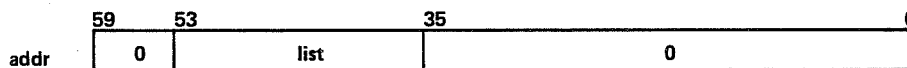

list Beginning address to which the logical file names (left-justified) contained in the global library set are written. The value of this parameter is updated to the address of the last library (list+n) upon completion. If an error is encountered, list will be the address of the lfn of the library that caused the error.

† This macro is not available in SYSTEXT. The user program must specify systems text PSSTEXT or call common deck COMCMAC (refer to appendix F).

Before calling the SETGLS macro, locations list through list+n+1 must be as follows:

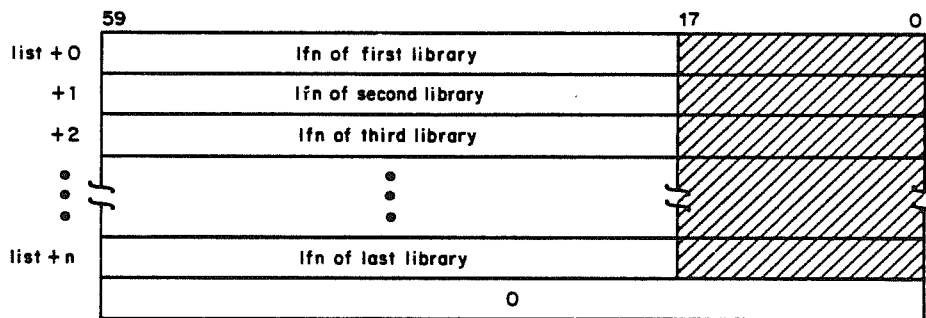

n The number of libraries in the global library set minus one.

MACHID (050)

The MACHID macro enables the user program to determine the one- or two-character machine identification.

Macro format:†

<u>Location</u>	<u>Operation</u>	<u>Variable</u>
	MACHID	addr

addr Address to receive machine identification.

The following information is returned to location addr:

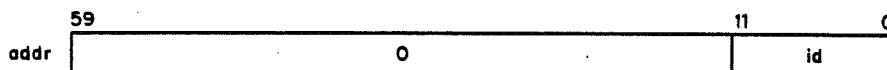

id Machine identification.

The MACHID macro returns the value specified in the MID entry of the CMRDECK.

GETACT (051)

The GETACT macro obtains information regarding outstanding system activity for your job.

Macro format:†

<u>Location</u>	<u>Operation</u>	<u>Variable</u>
	GETACT	addr

addr Address to receive information.

† This macro is not available in SYSTEXT. The user program must specify systems text PSSTEXT or call common deck COMCCMD (refer to appendix F).

The following information is returned to location addr:



sca Count of system completable activities.

ℓ Long-term activity pending.

The sca field is incremented by one for each of the following:

- PP activity outstanding. This includes any PP routines called without auto recall that have not yet completed (for example, CIO). The following PPs are not included:
 - The PP that is processing the GETACT request.
 - PPs that have moved away from your job's control point at the time the GETACT request is being processed and then move back to your job's control point.
 - For jobs running under DIS control, the PP in which DIS is executing.
- Tape I/O activity outstanding or PP routine(s) in recall. Although the tape activity is initiated through CIO requests, it is handled separately by the system and is counted here, not with the PP activity.
- The rollout flag is set for your job.
- An interactive I/O request that has been made but not yet processed.
- Any SCP wait response indicators are set.

If ℓ (bit 47) is equal to 1, a long-term activity is pending. Such an activity requires either termination by the user or operator intervention. The following are long-term activities.

- K or L console display interface.
- CFO flag set (refer to Volume 3, System Commands, for a description of CFO entries).
- A system control point (SCP) long-term connection.
- DIS.

SETMFL (052)

The SETMFL macro enables you to change the job step maximum field length (MFL) boundary (refer to GETFLC and SETRFL macros for discussion of maximum field length limit). If either parameter is 0, the maximum field length is set to your maximum allowable field length.

Macro format:†

<u>Location</u>	<u>Operation</u>	<u>Variable</u>
	SETMFL	n,m

n New maximum central memory field length limit for job step.

m New maximum extended memory FL/1000₈ limit for job step.

GETPFP (057)

The GETPFP macro returns a job's permanent file parameters (current family name, pack name, device type, user name, and user index).

Macro format:†

<u>Location</u>	<u>Operation</u>	<u>Variable</u>
	GETPFP	addr

addr Address to receive three-word table containing permanent file parameters.

The following information is returned to location addr:

	59	17	0
addr +0	family name		0
+1	pack name		device type
+2	user name		user index

†This macro is not available in SYSTEXT. The user program must specify systems text PSSTEXT or call common deck COMCCMD or COMCMAC (refer to appendix F).

GETLOF (061)

The GETLOF macro returns the list of files pointer for your job to the specified address. The list of files pointer is set with the SETLOF macro.

Macro format:†

<u>Location</u>	<u>Operation</u>	<u>Variable</u>
	GETLOF	addr

addr Address to receive the list of files pointer.

The following information is returned to location addr:



pointer Address of list of files table established with the SETLOF macro.

c Completion bit.

If the system returns 0 in the pointer field, no list of files address has been previously set (refer to description of SETLOF macro).

SETLOF (062)

The SETLOF macro enables the user program to specify a pointer to a list of files whose circular buffers will be flushed at job step abort or, for terminal files, when the job is rolled out or when the user program issues a read with recall request on INPUT.

Macro format:†

<u>Location</u>	<u>Operation</u>	<u>Variable</u>
	SETLOF	addr

addr Address containing the pointer to the list of files table.

The following information must be specified at location addr:

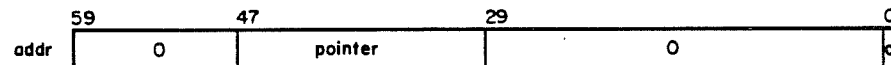

pointer Address of list of files table.

c Completion bit.

† This macro is not available in SYSTEXT. The user program must specify systems text PSSTEXT or call common deck COMCCMD (refer to appendix F).

The list of files table has the following format.

	59	17	0
pointer + 0	m	0	len
+ 1		lfn ₁	fet ₁
+ 2		lfn ₂	fet ₂
:		:	:
+ len - 2		lfn _n	fet _n
+ len - 1		0	

m Common memory manager (CMM) block indicator; setting this bit indicates that the file list is CMM controlled.

len Length of the list of files table including zero termination word.

lfn_i File name.

fet_i FET address.

The length of the list of files list must not exceed 7777₈ words.

When used with an interactive job step, the first file in the list must be the terminal output file.

During job step completion and after an error condition has occurred, the system uses the list of files to determine which files to complete for the user program. If the file name is OUTPUT or the FET has the flush bit set and the flushing criteria are met (refer to the description of the flush bit, FET Description in section 2), the data in the circular buffer is written to the specified file.

GETJCI (074)

The GETJCI macro returns job control information to the specified address.

Macro format: †

<u>Location</u>	<u>Operation</u>	<u>Variable</u>
	GETJCI	addr

addr Address of table to receive job control information.

† This macro is not available in SYSTEXT. The user program must specify systems text PSSTEXT or call common deck COMCCMD (refer to appendix F).

The following information is returned to the two words beginning at location addr.

	59	53	35	23	17	11	5	0
addr +0	efg	R1G	ccl	em	ssw	O		
+1	ef	R3	R2		R1			

- efg Global error flag (refer to Volume 3, System Commands, for a description of global error flag).
- R1G Global register.
- ccl Reserved for system use.
- em Exit mode (as described in appendix E).
- ssw Sense switches (as described for ONSW macro).
- ef The last error flag encountered (as described for EREXIT macro).
- R3 Job control register 3.
- R2 Job control register 2.
- R1 Job control register 1.

SETJCI (074)

The SETJCI macro sets job control information with values obtained from a two-word table.

Macro format: †

<u>Location</u>	<u>Operation</u>	<u>Variable</u>
	SETJCI	addr

addr Address of table specifying job control information.

The job control information must be established in the same format as that described for the GETJCI macro. The exit mode field is ignored for all jobs and the ccl field is ignored for user jobs.

† This macro is not available in SYSTEXT. The user program must specify systems text PSSTEXT or call common deck COMCCMD (refer to appendix F).

PROTECT (075)

The PROTECT macro enables the user program to select or deselect the following job control features.

- Extended memory field length preservation over job steps.
- User file privacy.

Macro format:†

<u>Location</u>	<u>Operation</u>	<u>Variable</u>
	PROTECT	em,ufp

em ON to select extended memory preservation; OFF to deselect extended memory preservation.

ufp ON to select user file privacy; OFF to deselect user file privacy.

To specify extended memory field length preservation, you must be authorized to use the PROTECT command (refer to LIMITS command in Volume 3, System Commands).

If the user program issues the PROTECT macro with the ufp parameter set to ON, all files that are subsequently created or accessed in the current job step are returned at job step termination. If a PROTECT macro with the ufp parameter set to OFF is subsequently issued in the same job step, only those files created or accessed prior to the second PROTECT macro are returned.

If the user program selects user file privacy, a checkpoint of the job step in which the PROTECT function is issued is not allowed.

SETJOB (106)

The SETJOB macro allows the user program to specify or to change the user job name (UJN), the disposition code for end-of-job output, and the end-of-job option. The user program must create a two-word parameter block containing this information before issuing the SETJOB call.

Macro format:†

<u>Location</u>	<u>Operation</u>	<u>Variable</u>
	SETJOB	addr

addr Address of parameter block.

† This macro is not available in SYSTEXT. The user program must specify systems text PSSTEXT or call common deck COMCCMD (refer to appendix F).

Parameter block format:

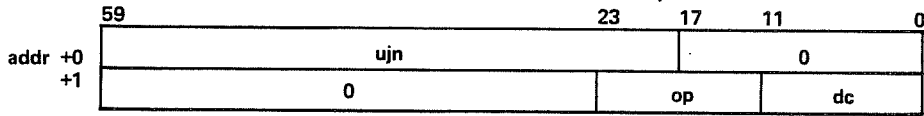

ujn One- to seven-character alphanumeric UJN for the current job (left-justified, zero-filled). If binary zero, the current UJN remains in effect. The system initially assigns each job a UJN equal to the four-character user index hash or, for batch jobs, the name specified by the Job command.

op End-of-job option.

<u>op</u>	<u>Description</u>
SU	Suspend job.
TJ	Terminate job.

dc Disposition of output at end of job.

<u>dc</u>	<u>Description</u>
DF	Default queue for job; depends on job origin type (refer to appendix E).
NO	No output.
TO	Wait queue.

If a field is set to binary zero, the corresponding option is not changed.

GETSSID (110)

The GETSSID macro returns the subsystem identifier to the specified address.

Macro format:†

<u>Location</u>	<u>Operation</u>	<u>Variable</u>
	GETSSID	addr

addr Address to which subsystem identifier is returned.

The following information is returned to location addr:



ssid Subsystem identifier.

†This macro is not available in SYSTEXT. The user program must specify systems text PSSTEXT or call common deck COMCMAC (refer to appendix F).

GETJOSC (111)

The GETJOSC macro returns the job origin and service class values to the specified address.

Macro format:†

<u>Location</u>	<u>Operation</u>	<u>Variable</u>
	GETJOSC	addr

addr Address to which job origin and service class values are returned. Refer to appendix E for a list of job origin and service class values.

The following information is returned to location addr:

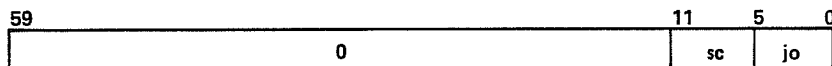

sc Service class.

jo Job origin.

SHELL (113)

The SHELL macro allows you to specify controls for a shell program (refer to Volume 3, System Commands, for a description of shell programs).

Macro format:†

<u>Location</u>	<u>Operation</u>	<u>Variable</u>
	SHELL	addr

addr Address containing control information for shell program.

†This macro is not available in SYSTEXT. The user program must specify systems text PSSTEXT or call common deck COMCMAC (refer to appendix F).

The control information at address addr must have the following format.



name One- to seven-character name of shell program.

ctrl Control information for shell program.

<u>Bit</u>	<u>Description</u>
7	Clear control information if there are SHELL load errors. (If this bit is not set, the job is terminated on a SHELL load error.)
6	Clear control information if shell program aborts. This bit must be set if a project epilogue is defined for the current account block.
5	Allow load of shell program from local file.†
4	Allow load of shell program from global library.†
3	Allow load of shell program from system library.
2	Call shell program during interactive job when there are no more commands to process.
1	Call shell program for each command outside a procedure.
0	Call shell program for each command inside a procedure.

Example:

To allow shell program ABC to be loaded from a global library and to monitor all commands, a user program could include the following statements.

```

      .
      .
      .
      SHELL  CTRL1
      .
      .
      .
CTRL  SET   1S4+1S2+1S1+1S0
CTRL1 VFD   42/3LABC,11/0,7/CTRL
      .
      .
      .
    
```

Appendix L contains an illustration of a shell program that permits the use of non-NOS syntax commands.

† A shell program loaded from a local file or global library must be in ABS or OVL format. You must ensure that there is sufficient field length if the program is to be loaded from a local file.

GETJAL (116)

The GETJAL macro returns your job's current security access level and the job's security access level limits to the specified address.

Macro format:†

<u>Location</u>	<u>Operation</u>	<u>Variable</u>
	GETJAL	addr

addr Address to which the job's security access level information is to be returned.

The following information is returned to location addr:

	59		17	11	5	0
addr	0		ll	ul	al	

ll The numerical value of the job's lower access level limit.
ul The numerical value of the job's upper access level limit.
al The numerical value of the job's current access level.

The system OPL common deck COMCVLC can be used to convert access level names to numerical values and vice versa.

On an unsecured system, GETJAL returns a zero word to location addr.

SETJAL (117)

The SETJAL macro changes the security access level of your job. This macro is valid only on a secured system.

Macro format: †

<u>Location</u>	<u>Operation</u>	<u>Variable</u>
	SETJAL	addr

addr Address of a word containing the numerical value of the new access level for the job, right-justified with binary zero fill. The access level specified must be valid for your job (refer to Security Access Levels in section 1). The access level specified may not be lower than the current job access level unless you have special authorization.

†This macro is not available in SYSTEXT. The user program must specify systems text PSSTEXT or call common deck COMCMAC.

GETUSC (123)

The GETUSC macro returns the service classes valid for the user program for a particular job origin type and indicates the upper and lower priority bounds for each of those service classes. The user program must contain a parameter block consisting of one word of parameters for the request and one word for each service class to be returned.

Macro format:†

<u>Location</u>	<u>Operation</u>	<u>Variable</u>
	GETUSC	addr

addr Address of parameter block.

Parameter block format:

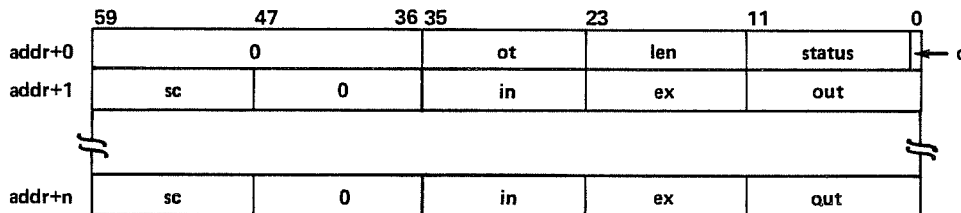

The user program enters the following information into the parameter block:

<u>Field</u>	<u>Location</u>	<u>Description</u>
ot	35-24	The job origin type for which service class information is to be returned.
len	23-12	The maximum number of service classes for which information is to be returned. The symbol MXJC, defined in common deck COMSSCD, can be used to specify the number of service classes in the system. Service classes are returned in increasing numerical order (refer to appendix E for a list of valid service classes and the numerical value associated with each class).
c	0	Completion bit (must be set to zero).

†This macro is not available in SYSTEXT. The user program must specify systems text PSSTEXT or call common deck COMCMAC (refer to appendix F).

The user program must enter zeros in the remainder of word addr+0.

The following information is returned to the parameter block:

<u>Field</u>	<u>Location</u>	<u>Description</u>
len	23-12	The actual number of service classes returned.
status	11-1	Error status.

	<u>Value</u>	<u>Description</u>
	0	No error.
	1	Value of zero specified for len.
	2	Undefined origin type.
	3	Completion bit set in request.
c	0	Completion bit (set when processing is complete).
sc	59-48	Two-character display code mnemonic for the service class.
in	35-24	Lower bound for input files in this service class.
ex	23-12	Priority upper bound; the highest possible priority for executing jobs in this service class.
out	11-0	Priority lower bound; the lowest possible priority for output files in this service class.

In the following example, the GETUSC macro is used to return information for all service classes for interactive origin type.

```

      .
      .
      .
OPL   XTEXT  COMCMAC          REQUIRED FOR GETUSC MACRO
OPL   XTEXT  COMSSCD         DEFINES MXJC
REPLY VFD    24/0,12/IAOT,12/MXJC,12/0
      BSSZ   MXJC
      .
      .
      .
GETUSC REPLY

```

SETSC (124)

The SETSC macro changes the service class of your job.

Macro format:†

<u>Location</u>	<u>Operation</u>	<u>Variable</u>
	SETSC	addr

addr Address of parameter word.

Parameter word format:

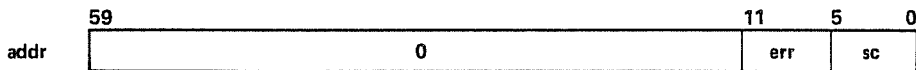

The user program enters the following information into the parameter word:

sc Mnemonic or numerical value for the service class to which the job is to be assigned (refer to appendix E for a list of valid service classes and the mnemonic and numerical value associated with each class); you must use the system OPL common deck COMSSCD in order to specify a service class mnemonic.

CPM returns the following information to the parameter word:

err Error status.

<u>Value</u>	<u>Description</u>
0	No error.
1	Undefined service class.
2	Service class not valid for user and job origin.
3	Service class full.

In the following example, the job's service class is changed to batch service class (BCSC).

```
      .  
      .  
      .  
OPL   XTEXT  COMSSCD  
OPL   XTEXT  COMCMAC  
PARAM VFD    54/0,6/BCSC  
      .  
      .  
      .  
SETSC  PARAM
```

†This macro is not available in SYSTEXT. The user program must specify systems text PSSTEXT or call common deck COMCMAC (refer to appendix F).

GETPAGE (127)

The GETPAGE macro returns page size parameters to the specified address.

Macro format:†

<u>Location</u>	<u>Operation</u>	<u>Variable</u>
	GETPAGE	addr

addr Address to which page size parameters are returned.

The following information is returned to location addr:

	59		31	27	19	11	10
addr	reserved for CDC		jd	jl	jw	res	c
	reserved for CDC		sd	sl	sw	res	

jd Job print density in lines per inch (6 or 8).
jl Job page length in lines.
jw Job page width in characters.
c Complete bit.
sd System print density in lines per inch.
sl System page length in lines.
sw System page width in characters.

SETPAGE (130)

The SETPAGE macro allows the user program to specify page size parameters to control printed output.

Macro format:†

<u>Location</u>	<u>Operation</u>	<u>Variable</u>
	SETPAGE	addr

addr Address of the word containing page size parameters. All parameters must be specified with unused fields set to binary zero.

	59		31	27	19	11	10
addr	0		jd	jl	jw	0	c

jd Job print density in lines per inch (6 or 8).
jl Job page length in lines ($16 < jl < 255$).
jw Job page width in characters ($40 < jw < 255$).
c Completion bit (must be zero on entry).

†This macro is not available in SYSTEXT. The user program must specify systems text PSSTEXT or call common deck COMCMAC.

GETLVL (133)

The GETLVL macro returns the PSR level of NOS that you are running.

Macro format:†

DSP FUNCTION

<u>Location</u>	<u>Operation</u>	<u>Variable</u>
	GETLVL	addr

addr Address of the word to which the system level is to be returned. The system level is a binary number, right-justified with binary zero fill.

GETRI (134)

The GETRI macro returns information on your job's current reprieve status to the specified address.

Macro format:

<u>Location</u>	<u>Operation</u>	<u>Variable</u>
	GETRI	addr

addr Address to which the reprieve information is to be returned.

The following information is returned to location addr:

addr	59 54 53	36 35	24 23	18 17	0
	flags	0	mask	0	eaddr

flags If bit 59 is set, EREXIT processing is enabled.
 If bit 58 is set, normal reprieve processing is enabled.
 If bit 57 is set, extended reprieve processing is enabled.
 If bit 56 is set, normal reprieve is in progress.
 If bit 55 is set, extended reprieve is in progress.

mask Normal reprieve mask bits (if normal reprieve condition is set). Zero (otherwise).

eaddr Extended reprieve parameter block address (if extended reprieve processing is enabled).

 Error exit return address (if normal reprieve processing is enabled or if EREXIT processing is enabled). Zero (otherwise).

†This macro is not available in SYSTEXT. The user program must specify systems text PSSTEXT or call common deck COMCCMD (refer to appendix F).

GETCN (136)

The GETCN macro returns the charge and project number.

The GETCN macro returns a four-word block containing the current charge and project number combination beginning at the specified address. Word four, bit 59, will be clear if this is a nonvalidated charge and project number. Word four, bit 59, will be set if these are validated numbers. (The only case in which the numbers would not have been validated is if your validation did not require you to have a valid charge and project number and your job had never issued an explicit CHARGE command.)

Macro format:

<u>Location</u>	<u>Operation</u>	<u>Variable</u>
	GETCN	addr

addr Address of the reply block.

The following information is returned to the four-word reply block beginning at location addr:

	59		0
addr+0	charge number		
addr+1	project number (first 10 characters)		
addr+2	project number (second 10 characters)		
addr+3	v	0	

v Validation bit.

CSTATUS (137)

The CSTATUS macro returns the type of the system console.

Macro format:†

<u>Location</u>	<u>Operation</u>	<u>Variable</u>
	CSTATUS	addr

addr Address of the word to which the console type is to be returned.



type Console type of primary console:

0 = CC545
1 = CC634B

†This macro is not available in SYSTEXT. The user program must specify system text PSSTEXT or call common deck COMCDM.

DSP FUNCTION

The dispose processor (DSP) performs file routing operations for NOS. DSP places a file in the specified queue at either the central site or a remote batch site. A user program can call DSP by issuing an RA+l request or a ROUTE macro. A DSP call can be made from a job of any job origin type.

NOTE

If a file is routed to an input queue, it must contain a valid USER command or the job step initiating the route will be aborted with a security conflict. Refer to section 1 of this manual for more information on security conflict processing.

The format of the call to DSP is:

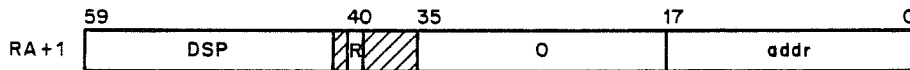

R Auto recall bit.

addr First word address of parameter block.

The user program must define a parameter block containing the following information before issuing a DSP RA+1 call or a ROUTE macro.

NOTE

Various symbols related to DSP calls and the DSP parameter block are defined in the system OPL common deck COMSDSP.

	59	57	53	47	41	35	23	17	11	0	
addr +0	lfn						ec	reserved	c		
+1	reserved		forms		disp		ex	s	ic	flags	
+2	slid			dlid			tid				
+3	ujn						reserved	priority			
+4	p	pi	spacing	service class		abort code		reserved	rc	reserved	
+5	binary card seq. error data					number of cards read					
+6	eqld						jsn				

By setting bit 6 of the flags field in addr+1, the user program can define an extended DSP parameter block containing the following information.

	59	47	23	17	11	0
addr +7	dd	raddr	0	eflags		
+10	oun			irtaddr		
+11	ofn			ertaddr		
+12	cun			cp	ssid	
+13	cfn			reserved for CDC		
+14	encrypted password for input file (SSJ= only)			reserved for CDC		
+15	reserved for CDC					
+16	reserved for installations					
+17	charge number					
+20	project number					
+21						

NOTE

In general, a field in the DSP parameter block (or extended block) will only be processed if the corresponding bit in the flags (or eflags) field is set.

- lfn Local file name of file to be routed (must be a queued file or a local file, must not reside on a removable device, and must not be an execute-only file). After the request is completed, this file name contains the JSN of the queued file (if bit 17 of flags was set).
- ec Error code returned by system when bit 12 of flags field is set (error codes described later in this section).
- c Completion bit (must be zero when function is issued - system sets bit to one when operation is complete).

forms Forms code or input flags. Two display code characters or specific bits set identifying the forms to be used for this file or other processing options. If file is routed to input queue, this field is defined as follows:

<u>Bit(s)</u>	<u>Description</u>
47-45	Reserved.
44	Send file to input queue with forced abort error code.
43	Send file to input queue even if Job command error occurs.
42	A binary card sequence error occurred or an incorrect Hollerith code was detected in the card deck.
41-36	Reserved.

Forms codes consist of two alphanumeric characters and are assigned by each installation. Forms code AC may be used on models 810 and 830 that have both a 64- and 95-character print train if the 95-character print train is required. You should contact installation personnel to determine what forms codes are available (if any).

disp Disposition code. Two alphanumeric characters specifying the disposition of the routed file.

<u>Code</u>	<u>Description</u>
IN†	Release file to input queue.
LP	Print on any line printer.
LR	Print on 580-12 line printer.
LS	Print on 580-16 line printer.
LT	Print on 580-20 line printer.
LX	Print on 5870 printer.
NO	Release file to input queue. Drop job output files at job completion.
PB	Punch system binary.
PH	Punch coded.
PL	Plotter.
PR	Same as LP.
PU	Same as PH.
P8	Punch 80 column binary.
SB	Same as PB.
SC	Rescind prior routing and change file type to local (LOFT).
TO	Input queue, output to wait queue.
TT	Wait.
WT	Same as TT.

† When a job that has been routed to IN runs to completion, the following local files (if they exist) will be routed to the appropriate queues: OUTPUT, PUNCH, PUNCHB, and P8. You can prevent this implicit file routing with the SETJOB command or macro.

ex External characteristics of print files:

<u>ex</u>	<u>Description</u>
0	Any external characteristics.
1	Not used.
2	ASCII graphic 48-character set (not supported; provided for NOS/BE compatibility).
3	CDC graphic 48-character set (not supported; provided for NOS/BE compatibility).
4	CDC graphic 63/64-character set.
5	ASCII graphic 63/64-character set.
6	ASCII graphic 95-character set.
7	Reserved.

External characteristics of punch files:

<u>ex</u>	<u>Description</u>
0	System default.
1	System binary.
2	80-column binary.
3	Not used.
4	O26 mode.
5	O29 mode.
6	ASCII.
7	Reserved.

External characteristics of plot files:

<u>ex</u>	<u>Description</u>
0	Reserved.
1	Transparent 6-bit plotter data.
2	Transparent 8-bit plotter data.
3-6	Not used.
7	Reserved.

s Forced service class flag. If set, the specified service class will be used.

ic Internal characteristics (bits 19 through 18) code:

<u>Value</u>	<u>Description</u>
0	Display code.
1	ASCII code.
2	Binary.
3	Reserved.

If ic is not specified, the system assigns a default value based on the value of ex.

<u>ex for Print Files</u>	<u>Default ic</u>
2	1
3	0
4	0
5	0
6	1

<u>ex for Punch Files</u>	<u>Default ic</u>
1	2
2	2
4	0
5	0
6	1

flags Each bit set indicates that a particular parameter is specified.

<u>Bit</u>	<u>Description</u>
17	Job sequence name assigned to queued file by system is returned to addr+0, bits 59 through 18.
16	Accounting.
15	580 PFC spacing code.
14	Repeat count.
13	UJN is specified in addr+3, bits 59 through 18.
12	No dayfile message and return error code to addr+0, bits 17 through 12.
11	Subsystem initiation.
10	Forms code.
9	Priority.
8	Internal characteristics.
7	External characteristics.
6	Extended parameter block.
5	Reserved for installations.
4	Disposition code.
3	SLID/DLID.
2	TID.
1	Route to central site.
0	Indicates either deferred ROUTE (output files only) or forced JSN flag (input files only).

The system determines the routing destination of an output file by flag bits 1 and 2 (route to central site and tid, respectively) as follows:

<u>Central Site Bit</u>	<u>tid Bit</u>	<u>Routing Activity</u>
0	0	If the calling job is of remote batch origin, the system routes output to the remote batch queue and associates with it the user name and family of the originating remote batch terminal. If the calling job is any other origin type, the system routes output to the central site queue. If the file being routed was previously routed with queuing deferred, the previously specified destination remains in effect.

slid Three-character alphanumeric logical identifier (LID) of the source mainframe for the file. The following special values may also be entered in this field.

<u>Value (Octal)</u>	<u>Description</u>
0	Get slid from job input file system sector.
1	Set slid to zero.
2	Set slid to physical identifier of this mainframe.

dlid Three-character alphanumeric logical identifier (LID) of the destination mainframe for the file. The following special values may also be entered in this field.

<u>Value (Octal)</u>	<u>Description</u>
0	Set dlid to zero.
1	Set dlid to zero.
2	Set dlid to physical identifier of this mainframe.

tid For routing to a remote batch queue, this field should contain the complement of the address of a two-word block. The first word of the block contains the family name and the second word contains the user name (both left-justified and zero-filled). This is the user name that must be used to log in at a remote terminal to get the routed file.

If the address specified by the tid field equals 77777778, the file is routed to the remote batch queue with the family and user name of the calling job.

For routing to the local batch queue, the tid contains an ID code (right-justified).

ujn The user job name (UJN) to be used instead of the job's default UJN.

<u>Central Site Bit</u>	<u>tid Bit</u>	<u>Routing Activity</u>
0	1	The system routes output according to the contents of the tid field (description follows).
1	0	The system routes output to the central site queue.
1	1	The system routes output to the central site queue if the tid field contains a valid ID code; otherwise, the system aborts the job.

priority If job priority is greater than 7760 octal, the specified priority is used for output files (otherwise field is ignored).

p Print train image flag. This flag is set whenever the pi field contains a print train image code.

pi Print train image code (0 to 7) for print files. This field is meaningful only for 512 and 580 printers.

spacing Spacing code for output files (580 PFC). Octal value from 0 to 77.

service class Two-character forced service class code in display code, specifying the service class of the routed file. Refer to appendix E for a list of valid service classes and service class codes.

abort code If bit 44 of the DSP parameter word 1 is set, the value of this field determines which message from the following table is sent to the dayfile.

<u>Value</u>	<u>Message</u>
0001	Job command error.
0002	Card reader error.
0003	Operator input termination.
0004	Disk full.
0005	Disk parity error.

rc Repeat count.

binary card sequence error data Used by the batch input/output subsystem.

eqid Equipment identifier in display code. For the Remote Batch Facility (RBF), terminal name; for the batch input/output subsystem, machine ID followed by EST ordinal of card reader; otherwise, EST ordinal of card reader, left-justified with zero-fill.

dd The data declaration in display code. Defines the data type of a file destined to a remote mainframe.

<u>dd</u>	<u>Data Type</u>
C6	6-bit character data.
C8	8-bit character data.
US	Undefined data type, structured file.
UU	Undefined data type, unstructured file.

raddr Random address of the EOI sector of the file.

eflags Flags indicating which parameters are specified in the extended parameter block.

<u>Bit</u>	<u>Description</u>
17-11	Reserved.
10	Charge/project numbers (SSJ= only).
9	Do not validate service class (SSJ= only).
8	Special requeue operation (SSJ= only).
7	Use encrypted password (SSJ= only).
6	Use origin default service class (SSJ= only).
5	Control point and subsystem identifier specified.
4	Do not validate password (SSJ= only).
3	Subsystem call (SSJ= only).
2	Creator user name and/or creator family name (SSJ= only).
1	Owner user name and/or owner family name (SSJ= only).
0	Data declaration.

oun The user name of the file owner (SSJ= entry point only).

irtaddr The first word address of the block containing the implicit remote text string for the file (SSJ= entry point only). The first word of the block contains the length of the string in characters. The rest of the block contains up to 400g display-code characters.

ofn The family name of the file owner (SSJ= entry point only).

ertaddr The first word address of the block containing the explicit remote text string for the file (SSJ= entry point only). The first word of the block contains the length of the string in characters. The rest of the block contains up to 400g display-code characters.

cun The user name of the file creator (SSJ= entry point only).

cp Control point selection (subsystem initiation).

ssid Subsystem identifier (subsystem initiation).

cfm The family name of the file creator (SSJ= entry point only).

charge number The charge number associated with the file (SSJ= entry point only).

project number The project number associated with the file (SSJ= entry point only).

ROUTE

The format of the ROUTE macro is as follows:

<u>Location</u>	<u>Operation</u>	<u>Variable</u>
	ROUTE	addr,R
addr		Address of parameter block.
R		Auto recall bit.

Example 1:

The following example routes a file named PRINTF for printing on any central site line printer.

```

      .
      .
PBLK  VFD  42/OLPRINTF,18/0
      VFD  24/0,12/2HLP,6/0,18/22B
      VFD  60/0
      VFD  60/0
      VFD  60/0
      VFD  60/0
      VFD  60/0
      .
      .
      ROUTE  PBLK,R
      .
      .

```

Example 2:

The following example performs a deferred route of a file named PRINTF in ASCII graphic 95-character set and specifies that two copies be printed.

```
      .
      .
PBLK  VFD      42/0LPRINTF,18/0
      VFD      24/0,12/2HLP,3/6,3/0,18/40221B
      VFD      60/0
      VFD      60/0
      VFD      42/0,6/1,12/
      VFD      60/0
      VFD      60/0
      .
      .
      ROUTE    PBLK,R
      .
      .
```

Example 3:

The following example routes a file named JOB1 to the input queue for processing at the central site and writes the job name assigned by the system to the user dayfile.

```
      .
      .
PBLK  VFD      42/0LJOB1,18/0
      VFD      12/0,12/1000B,12/2HIN,6/0,18/402022B
      VFD      60/0
      VFD      60/0
      VFD      60/0
      VFD      60/0
      VFD      60/0
      .
      .
      ROUTE    PBLK,R
      SA1     PBLK
      MXO     42
      BX6     X0*X1
      SA6     A1
      MESSAGE PBLK,3
      .
      .
```

ERROR PROCESSING

When an error occurs in processing a ROUTE macro or DSP call, either a dayfile message explaining the error is issued, or an error code is returned in bits 17 through 12 of addr+0. If the address of the parameter block is outside the field length of the job or if the completion bit is set when the function is issued, the job step aborts. For all other errors, the function is not executed, but error processing continues. If bit 12 of the flags field is set, an error code is returned and no dayfile message is issued. If bit 12 is not set, no error code is returned, a dayfile message is issued, and the job step aborts.

The error codes that can be returned are as follows:

<u>Error Codes</u>	<u>Description</u>
1	File name error.
2	File not on mass storage.
3	Invalid file type.
4	Reserved.
5	Route to input not immediate.
6	Immediate routing, no file.
7	Incorrect disposition code.
10	User access not valid.
11	Undefined service class.
12	Incorrect request (unconditional abort).
13	Deferred routing not allowed.
14	Incorrect data declaration.
15	Incorrect LID.
16	Cannot route job input file.
17	Completion bit already set (unconditional abort).
20	File on removable device.
21	Incorrect TID.
22	Forms code not alphanumeric.
23	Incorrect internal characteristics.
24	Queued file read error.
25	QFT full.
26	This routing not allowed.
27	Device full.
30	Mass storage error.
31	I/O sequence error (unconditional abort).
32	Job command error.
33	Too many deferred batch jobs.
34	Incorrect USER command.
35	Device inaccessible.
36	Incorrect file mode.
37	Incorrect external characteristics.
40	Incorrect origin type.
41	Incorrect spacing code.
42	Incorrect job abort code.
43	Reserved.
44	Reserved.
45	Service class incorrect for user or job origin.
46	Alternate family not allowed.
47	User security count exhausted.
50	JSN already in system.

For a complete listing of error messages, refer to appendix B.

QUEUE ACCESS INTERFACE

The queue access (QAC) interface allows a user program to interact with the executing job table (EJT) and the queued file table (QFT). The user program can specify either a single entry (file or job) in a QAC request, or a group of entries. Requests are provided that allow a user program to:

- Attach files that are in the QFT (GET request).
- Determine the status of files in the QFT and jobs in the EJT (PEEK request).
- Alter or purge files in the QFT and jobs in the EJT (ALTER request).

A user program accesses the QAC interface by issuing an RA+1 call. The format of the call is:



R Auto recall bit.

addr Address of the QAC parameter block; must be a valid address within your job's field length.

The user program must define a parameter block before issuing the RA+1 call. The first 148 words of this block are common to all requests.

NOTE

Various symbols related to QAC calls and the QAC parameter block are defined in system OPL common deck COMSQAC.

	59		47		41		35		23		20		17		11		9		0
addr + 0	lfn													err	fcn	c			
+ 1	/													len	first				
+ 2	0													in					
+ 3	0													out					
+ 4	fnt ord	ejt/qft ord	queue		/			limit											
+ 5	dest family													id	origin				
+ 6	dest un													dest ui					
+ 7	jsn						selection flags												
+ 10	queue sel		forms		disp		ec	ic	link addr										
+ 11	slid			dlid			al lb	al ub	alid addr										
+ 12	li	ui	reserved for Control Data																
+ 13	reserved for installation use																		

<u>Field</u>	<u>Description</u>
lfn	The user program sets this field for a GET request to the local file name to be given to the queued file when it is attached from the queue. If this field is set to zero, QAC assigns the job sequence name (JSN) of the file as the local file name.
err	QAC enters one of the following error codes upon completion of a request. Error codes 1 through 128 indicate nonfatal errors. During linked request processing, QAC continues with the next request when a nonfatal error is detected.

<u>err</u>	<u>Description</u>
0	The request completed without error.
1	Incorrect queue type. Indicates one of the following conditions. <ul style="list-style-type: none"> ● Undefined queue bits (addr+108) were set. ● For a GET request, the executing job queue was selected. ● Bit 0, addr+7 is set, but more than one queue was selected in addr+4. ● The user program entered an invalid queue type in the queue field of addr+4 during an interrupted PEEK request.
2	Incorrect family/user name. The specified family (addr+5) or user name (addr+6) is not active or failed validation.
3	Undefined origin type (addr+5). The specified origin type is not valid.
4	The user program sets one of the following combinations of bits. <ul style="list-style-type: none"> ● Bits 3 and 4 of the selection flags field (addr+7). ● Bits 9 and 10 of the selection flags field (addr+7). ● Bits 0 and 1 of the alter flags field (addr+148). ● Bits 10 and 11 of the alter flags field (addr+148). ● Bits 12 and 16 of the alter flags field (addr+148). ● Bits 9, 13, 14, and 15 of the alter flags field (addr+148).
5	Incorrect forms code. The forms code field (addr+178) for an ALTER request does not consist of two alphanumeric characters or a zero.

FieldDescriptionerrDescription

6	Incorrect disposition code (addr+10g, or addr+17g for an ALTER request), or the PU disposition code was selected but no external characteristics were specified to select a particular punch type.
7	File or job not found.
10g	Duplicate local file name. For a GET request, QAC refused to attach a file because the file has the same name as an existing local file. QAC enters the name of the file that caused the error in the lfn field (addr+0). This condition does not result in an error if the inhibit duplicate lfn search flag (bit 1, addr+7) is set.
11g	Incorrect batch ID. The batch ID specified (addr+5, or addr+16g for an ALTER request) is not less than 70g.
12g	Incorrect file name. The local file name (addr+0) specified for a GET request is not valid.
13g	Count of zero incorrect. The maximum number of files or jobs to be selected in a PEEK request (addr+14g and addr+15g) for at least one queue must be greater than zero.
14g	The user program did not set any alter flags (addr+14g) for an ALTER request, or the QAC buffer is not large enough to hold one PEEK reply for a PEEK request.
22g	Incorrect external characteristics. The external characteristics code (addr+17g) for an ALTER request is not valid.
23g	The user program attempted to drop an interactive job.
24g	Incorrect destination LID. The destination LID (addr+15g) for an ALTER request is not valid.
25g	Incorrect access level. Either the access level selection limits (addr+11g) or the new access level for an ALTER request (addr+17g) are not valid.
26g	Incorrect file size index. The file size index selection limits (addr+12g) are not valid.
27g	Incorrect service class. The two-character service class was not valid for the user, or not valid for the current origin type of the specified job.
30g	Service class full. The service class change cannot be made because the number of jobs with that class is already at the service limit.
31g	Cannot change class of on-line job. The service class of another on-line job cannot be changed.

<u>Field</u>	<u>Description</u>										
<u>err</u>	<u>Description</u>										
32 ₈	Undefined service class. The service class mnemonic is not defined.										
33 ₈	Job already waiting on service class. The service class change cannot be made because the job is waiting for a CLASS command in the job to complete.										
34 ₈	Cannot change class of subsystem. The service class of a job that is executing at the subsystem service class cannot be altered.										
35 ₈	The selected file could not be attached because the PRU limit for the job's mass storage was exceeded during preparation of a local copy of a queued file.										
fcn	The user program enters the function code number for the type of request.										
	<table border="0"> <thead> <tr> <th><u>Request</u></th> <th><u>fcn</u></th> </tr> </thead> <tbody> <tr> <td>ALTER</td> <td>1</td> </tr> <tr> <td>GET</td> <td>2</td> </tr> <tr> <td>PEEK</td> <td>3</td> </tr> </tbody> </table>	<u>Request</u>	<u>fcn</u>	ALTER	1	GET	2	PEEK	3		
<u>Request</u>	<u>fcn</u>										
ALTER	1										
GET	2										
PEEK	3										
c	Completion bit. The user program must set this bit to zero. QAC sets this bit to one when the request is complete.										
len	The user program enters the total length of the QAC parameter block minus 5. The value of len for each type of request is as follows:										
	<table border="0"> <thead> <tr> <th><u>Request</u></th> <th><u>len</u></th> </tr> </thead> <tbody> <tr> <td>ALTER</td> <td>14₈</td> </tr> <tr> <td>Extended GET</td> <td>116₈ †</td> </tr> <tr> <td>GET</td> <td>13₈</td> </tr> <tr> <td>PEEK</td> <td>13₈</td> </tr> </tbody> </table>	<u>Request</u>	<u>len</u>	ALTER	14 ₈	Extended GET	116 ₈ †	GET	13 ₈	PEEK	13 ₈
<u>Request</u>	<u>len</u>										
ALTER	14 ₈										
Extended GET	116 ₈ †										
GET	13 ₈										
PEEK	13 ₈										
first	The user program enters the first word address of the buffer to be used by QAC. For an ALTER request, the user program can enter messages in the buffer; for a PEEK request, QAC enters the PEEK reply block in the buffer.										
in	This field is a pointer to the next available word in the buffer to which information can be written. For a PEEK request, the user program must set this field to the same value as first.										
out	This field is a pointer to the next word that can be read from the buffer. For a PEEK request, the user program must set this field to the same value as first. For an ALTER request involving a message, the user program enters the beginning address of the message.										
fnt ord	QAC enters the FNT ordinal of a file when the file is attached from a queue.										

†Although 116₈ is used here as the total parameter block length, the actual number of words returned on an extended GET is 123₈ words. Refer to the GET request in this section.

<u>Field</u>	<u>Description</u>																				
ejt/qft ord	The user program enters the QFT ordinal of the file or the EJT ordinal of the job if QAC is to process only the file or job having this ordinal. QAC enters the QFT ordinal of a file when the file is attached during a GET request. For an initial PEEK request, the user program must set this field to zero. QAC enters the QFT or EJT ordinal of the file or job currently being examined if a PEEK request is interrupted because the QAC buffer is full. QAC enters a value of zero when the request is complete.																				
queue	QAC enters a value indicating the queue in which a file was found for a GET request, or the remaining queues to be examined for a PEEK request. The user program must set this field to zero for an initial PEEK request and must not alter its contents when issuing continuation calls. QAC enters a value of zero upon successful completion of a PEEK request.																				
	<table border="0" style="margin-left: 40px;"> <thead> <tr> <th style="text-align: left;"><u>Bit(s)</u></th> <th style="text-align: left;"><u>Queue</u></th> </tr> </thead> <tbody> <tr> <td>0</td> <td>Input queue.</td> </tr> <tr> <td>1</td> <td>Executing job queue.</td> </tr> <tr> <td>2</td> <td>Print queue.</td> </tr> <tr> <td>3</td> <td>Punch queue.</td> </tr> <tr> <td>4</td> <td>Plot queue.</td> </tr> <tr> <td>5</td> <td>Wait queue.</td> </tr> <tr> <td>6-7</td> <td>Reserved for Control Data.</td> </tr> <tr> <td>8</td> <td>Reserved for installations.</td> </tr> <tr> <td>9-11</td> <td>Reserved for Control Data.</td> </tr> </tbody> </table>	<u>Bit(s)</u>	<u>Queue</u>	0	Input queue.	1	Executing job queue.	2	Print queue.	3	Punch queue.	4	Plot queue.	5	Wait queue.	6-7	Reserved for Control Data.	8	Reserved for installations.	9-11	Reserved for Control Data.
<u>Bit(s)</u>	<u>Queue</u>																				
0	Input queue.																				
1	Executing job queue.																				
2	Print queue.																				
3	Punch queue.																				
4	Plot queue.																				
5	Wait queue.																				
6-7	Reserved for Control Data.																				
8	Reserved for installations.																				
9-11	Reserved for Control Data.																				
limit	The user program enters the limit address (LWA+1) of the buffer to be used by QAC.																				
dest family	The user program enters the destination family name if QAC is to consider only one family (the program must also set bit 3, addr+7). This represents the family under which you would have to log in to access the file or job at a remote batch terminal. A value of zero selects the default family name. QAC enters the destination family name of the file that is attached during a GET request.																				
id	The user program enters an ID code if QAC is to consider only one ID code (the user program must also set bit 4, addr+7). QAC enters the ID code of the file attached during a GET request.																				

<u>Field</u>	<u>Description</u>
origin	The user program enters a value if QAC is to examine files or jobs of only one origin type (the program must also set bit 5, addr+7; if this bit is not set, QAC examines files and/or jobs of all types). On a GET request, the origin type of the attached file is returned in this field.

<u>Origin</u>	<u>Origin type</u>
00	Caller's origin.
01	SYOT (system).
02	BCOT (local batch).
03	RBOT (remote batch).
04	IAOT (interactive).
05-77	Reserved.

dest un	The user program enters the destination user name if QAC is to consider files and/or jobs for only one destination user name (the program must also set bit 3, addr+7). This represents the user name under which you would have to log in to access the file or job at a remote batch terminal. QAC enters the user name of the file that is attached during a GET request.
------------	--

dest ui	QAC enters the destination user index of the file that is attached during a GET request. This represents the user index under which you would have to log in to access the file or job at a remote batch terminal.
------------	--

jsn	The user program enters the job sequence name (JSN) if QAC is to consider files and/or jobs for only one JSN (the user program must also set bit 6, addr+7). QAC enters the JSN of the file that is attached during a GET request.
-----	--

selection flags	The user program sets the appropriate bits in this field to limit QAC's search of jobs or files to specific types. Where noted, these bits are used in conjunction with other fields in the parameter block to specify the type of job or file QAC is to search for.
--------------------	--

<u>Bit(s)</u>	<u>Description</u>
0	Specific ordinal (addr+4) and specific queue (addr+10g).
1	Inhibit duplicate lfn search. If set, QAC will allow a file having the same name as a local file to be attached in a GET request. Otherwise, an attempt to attach such a file causes an error flag in addr+0 to be set and the request is terminated.
2	Include priority=0 in selection. If set, QAC will select files and/or jobs that have a priority of zero, provided they meet other selection criteria.
3	Destination family name (addr+5) or destination user name (addr+6).
4	ID code (addr+5).
5	Origin type (addr+5).
6	JSN (addr+7).
7	Forms code (addr+10g).
8	Disposition code (addr+10g).
9	Explicit external characteristics (addr+10g).
10	Hierarchical external characteristics (addr+10g).
11	Include ec=0 (any external characteristics) in selection hierarchy (addr+10g).

FieldDescription

<u>Bit(s)</u>	<u>Description</u>
12	Internal characteristics (addr+10g).
13	Access level (addr+11g).
14	Destination LID (addr+11g).
15	List of alternate destination LIDs (addr+11g).
16	Source LID (addr+11g).
17	Include LP disposition code in addition to disposition code selected (print files only).
18	Select only recoverable jobs (detached interactive jobs).
19	Reserved for Control Data.
20	File size index range specified.
21-32	Reserved for Control Data.
33-35	Reserved for installations.

Bits 3 and 4 may not both be set, and bits 9 and 10 may not both be set. Bit 11 can be set only if bit 9 or bit 10 is set. Bit 17 can be set only if bit 8 is set.

queue sel The user program sets one or more bits in this field to indicate which queue or queues QAC is to consider.

<u>Bit(s)</u>	<u>Queue</u>
0	Input queue.
1	Executing job queue.
2	Print queue.
3	Punch queue.
4	Plot queue.
5	Wait queue.
6-7	Reserved for Control Data.
8	Reserved for installations.
9-11	Reserved for Control Data.

forms The user program enters a two-character alphanumeric forms code if QAC is to consider only files with a particular forms code (the program must also set bit 7, addr+7). QAC enters the forms code of the file that is attached during a GET request.

disp The user program enters a two-character disposition code if QAC is to consider only files with a particular disposition code (the program must also set bit 8, addr+7). QAC enters the disposition code of the file that is attached during a GET request.

<u>disp</u>	<u>Description</u>
IN	Input queue.
LP	Print on any line printer.
LR	Print on 580-12 line printer.
LS	Print on 580-16 line printer.
LT	Print on 580-20 line printer.
LX	Print on 5870 printer.
NO	Input queue, no output.
PL	Plotter.
PR	Same as LP.
PU	Punch (specific punch type must be entered in the ec field).

<u>disp</u>	<u>Description</u>
TO	Input queue, output to wait queue.
TT	Wait queue.
WT	Same as TT.

<u>Field</u>	<u>Description</u>
ec	The user program enters an external characteristics code if QAC is to consider only files with particular external characteristics (the program must also set bit 9, or 10, addr+7). QAC enters the external characteristics code of the file that is attached during a GET request.

External characteristics of print files:

<u>ec</u>	<u>Description</u>
0	Any external characteristics.
1	Not used.
2	ASCII graphic 48-character set (not supported; provided for NOS/BE compatibility).
3	CDC graphic 48-character set (not supported; provided for NOS/BE compatibility).
4	CDC graphic 63/64-character set.
5	ASCII graphic 63/64-character set.
6	ASCII graphic 95-character set.
7	Reserved.

External characteristics of punch files:

<u>ec</u>	<u>Description</u>
0	System default.
1	System binary.
2	80-column binary.
3	Not used.
4	O26 mode.
5	O29 mode.
6	ASCII.
7	Reserved.

External characteristics of plot files:

<u>ec</u>	<u>Description</u>
0	Reserved.
1	Transparent 6-bit plotter data.
2	Transparent 8-bit plotter data.
3-6	Not used.
7	Reserved.

If the user program sets bit 9 of addr+7 (explicit external characteristics), QAC searches only for files having the external characteristic selected. If the program sets bit 10 (hierarchical external characteristics), QAC searches for files having compatible external characteristics. The following codes cause QAC to search for files in the order listed.

Field

Description

Hierarchical external characteristics for print files:

<u>ec</u>	<u>Compatible Types</u>
0	ASCII graphic 95-character set, ASCII graphic 63/64-character set, ASCII graphic 48-character set, CDC graphic 63/64-character set, CDC graphic 48-character set.
4	CDC graphic 63/64-character set, CDC graphic 48-character set.
5	ASCII graphic 63/64-character set, ASCII graphic 48-character set.
6	ASCII graphic 95-character set, ASCII graphic 63/64-character set, ASCII graphic 48-character set.

Hierarchical external characteristics for punch files:

<u>ec</u>	<u>Compatible Types</u>
2	80-column binary, system binary.
5	029, 026.
6	ASCII, 029, 026.

ic The user program enters an internal characteristics code if QAC is to consider only files with particular internal characteristics (the program must also set bit 12, addr+7). QAC enters the internal characteristics code of the file that is attached during a GET request.

<u>ic</u>	<u>Description</u>
0	6-bit display code.
1	12-bit ASCII.
2	Binary.
3	Reserved.

link addr The user program enters either zero or, in order to process linked QAC requests, the address of the next QAC parameter block. Any nonzero value entered in this field must be a valid address within the user program's field length. Upon completion of the current request, QAC checks this field. If a nonzero value is present, QAC processes the request at address link addr.

slid The user program enters the source logical identifier (LID) if QAC is to consider only files originating at a particular mainframe. This field is processed if bit 16 of the selection flags field is set. A value of zero specifies only files without a source LID. QAC enters the source LID of the file that is attached during a GET request.

dlid The user program enters the destination logical identifier (LID) if QAC is to consider only files with a particular destination LID. This field is processed if bit 14 of the selection flags field is set. A value of zero specifies only files without a destination LID; a value of *** (474747₈) specifies all files regardless of LID. QAC enters the destination LID of the file that is attached during a GET request.

If bit 14 of the selection flags field is not set on a GET request, QAC selects either a file with no destination LID or a file whose destination LID refers to the local host mainframe.

<u>Field</u>	<u>Description</u>
al lb	The user program enters the access level lower bound if QAC is to consider only files with an access level equal to or greater than a particular value (the program must also set bit 13, addr+7).
al ub	The user program enters the access level upper bound if QAC is to consider only files with an access level equal to or less than a particular value (the program must also set bit 13, addr+7).
alid addr	The user program enters the address of a list of alternate destination LIDs if QAC is to consider only files from that list of destination LIDs. The list of alternate LIDs has the following format:

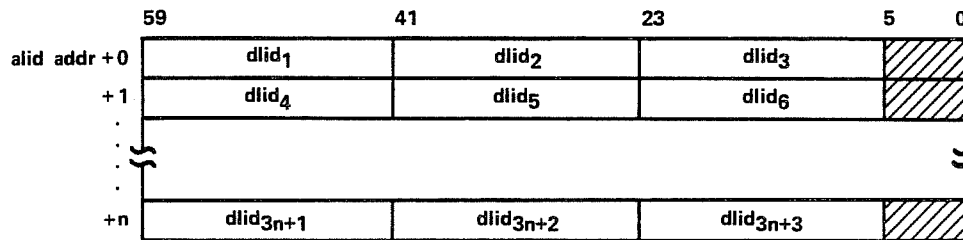

The list is terminated by the first 18-bit zero field starting at bit 59, 41, or 23.

li	The user program enters the file size index lower bound if QAC is to consider only files with a file size index within a specified range (the program must also set bit 20, addr+7). If li is specified, ui must also be specified, and li must be .LE. ui.
ui	The user program enters the file size index upper bound if QAC is to consider only files with a file size index within a specified range (the program must also set bit 20, addr+7). If ui is specified, li must also be specified, and ui must be .LE. li.

QAC REQUESTS

The following pages describe the three types of QAC requests: ALTER, GET, and PEEK. Each type of request uses a different format for the remainder of the parameter block following addr+13_g.

ALTER REQUEST

The ALTER request changes characteristics of queued files or executing jobs. The alter flags in $\text{addr}+14_8$ determine which characteristics the ALTER request is to change. QAC cannot alter the calling job.

The format of the remainder of the parameter block for an ALTER request is as follows:

	59	53	47	35	29	23	20	17	11	5	0
addr + 14	ssw						alter flags				
+ 15	new dest family							new dest lid			
+ 16	new dest un									sp cd	ID
+ 17	reserved		forms	disp	ec	al	src		rep		
+ 20	reserved for installations										

Field

Description

ssw The user program enters bit values to which the sense switch settings of jobs are to be altered. Bits 54 through 59 correspond to sense switches 1 through 6 respectively. If bit 10 of $\text{addr}+14_8$ (turn sense switches on) is set, the sense switches whose corresponding bits in this field are set to one are changed to one for the selected jobs. If bit 11 of $\text{addr}+14_8$ (turn sense switches off) is set, the sense switches whose corresponding bits in this field are set to zero are changed to zero for the selected jobs. Refer to the ONSW and OFFSW macro descriptions in section 6 for descriptions of the individual sense switches.

alter flags The user sets the appropriate bits in this field to specify the information that QAC is to alter.

Bit(s)

Description

0	Change remote family name, user name.
1	Change local batch identifier.
2	Change priority of output queue file.
3	Alter forms code.
4	Alter spacing code.
5	Alter disposition code.
6	Alter external characteristics.
7	Alter repeat count.
8	Alter access level.
9	Abort job or evict file.
10	Turn sense switches on.
11	Turn sense switches off.
12	Clear pause bit.
13	Send comment to dayfile.
14	Send comment from operator.
15	Indicate message available for aborted job.
16	Set pause bit.
17	Alter destination logical identifier.
18	Kill job.
19	Alter service class.
20-26	Reserved for Control Data.
27-29	Reserved for installations.

<u>Field</u>	<u>Description</u>
	Bit 15 can be set only if bit 9 is set. Only one of bits 13, 14, and 15 can be set. If bit 13, 14, or 15 is set, the program must enter a message in the QAC buffer defined by the fields FIRST, IN, OUT, and LIMIT.
new dest family	The user program enters the new destination family name for the files and/or jobs. The program must also set bit 0, addr+14 ₈ . QAC changes the destination family and routes the files/jobs to remote batch. The specified family must be known to the system but need not be active. If this field is selected and has a value of zero, QAC uses the family of the requesting job's control point.
new dest lid	The user program enters the new destination logical identifier (LID) for selected input and/or output files. The program must also set bit 17, addr+14 ₈ .
new dest un	The user program enters the new destination user name for the files and/or jobs. The program must also set bit 0, addr+14 ₈ . QAC changes the destination user name and routes the files/jobs to remote batch. If this field is selected and has a value of zero, QAC uses the user number associated with the job in which the user program is executing.
sp cd	The user program enters the new spacing code for the files. This field affects only print files. The program must also set bit 4, addr+14 ₈ . Values of 0 through 77 ₈ are accepted; if the value entered is not defined for the installation, the released default value (0) is used. For more information on spacing codes, refer to the NOS 2 Analysis Handbook.
id	The user program enters the identifier for the local batch queue to which the files and/or jobs are to be routed. The program must also set bit 1, addr+14 ₈ .
forms	The user program enters the new forms code for the files. This field affects only output files. The program must also set bit 3, addr+14 ₈ . This field may contain any two alphanumeric characters or zero.
disp	The user program enters the new disposition code for the files. This field affects only output files. The program must also set bit 5, addr+14 ₈ . Valid disposition codes are listed in the description of the disp field of addr+10 ₈ .
ec	The user program enters the new external characteristics code for the files. This field affects only output files. The user program must also set bit 6, addr+14 ₈ . Valid external characteristics codes are listed in the description of the ec field of addr+10 ₈ . A value of zero for a punch file selects the installation-defined default punch mode.
al	The user program enters the new access level for the files. The program must also set bit 8, addr+14 ₈ . This field may contain any value from 0 through 7. (You can convert a symbolic access level name to a numerical value, or vice versa, using system OPL common deck COMCVLC.)

<u>Field</u>	<u>Description</u>
src	The user program enters the new service class for files in the input queue and for executing jobs. The program must also set bit 19, addr+148. This field does not affect output files. The service class is specified as the first two characters in the display code of one of the service class mnemonics listed in appendix E.
rep	The user program enters the new repeat count for output files. The program must also set bit 7, addr+148. The maximum value allowed is 778.

Example:

The following program clears the pause bit in all executing jobs submitted under the same user name as the program (except the job in which the program is executing). The program also enters the message PROGRAM RESTART HAS CLEARED PAUSE BIT in the user dayfile of each job. This program uses the SYSTEM macro (refer to section 11) to issue the QAC request.

```

IDENT RESTART
ENTRY RESTART

** MESSAGE BUFFER

MSG DATA C*PROGRAM RESTART HAS CLEARED PAUSE BIT*
TAG1 EQU *-MSG

** QAC PARAMETER BLOCK

BLOCK BSS 0
      VFD 59/1,1/0          ALTER FUNCTION CODE
      VFD 36/0,6/12,18/MSG  MESSAGE BUFFER, FIRST
      VFD 42/0,18/MSG+TAG1  " , IN
      VFD 42/0,18/MSG       " , OUT
      VFD 42/0,18/MSG+TAG1+1 " , LIMIT
      VFD 60/0
      VFD 60/0
      VFD 60/0
      VFD 12/2,48/0        SELECT EXECUTING JOB QUEUE
      VFD 60/0
      VFD 60/0
      VFD 60/0
      VFD 60/220000B      CLEAR PAUSE BIT AND SEND
                          COMMENT TO DAYFILE
      VFD 60/0
      VFD 60/0
      VFD 60/0

** MAIN PROGRAM

RESTART SYSTEM QAC,R,BLOCK CALL QAC
        ENDRUN

        END RESTART

```

GET REQUEST

The GET request attaches one of your queued files to your job in read mode.

The attached file can be returned to the queue with a DSP call or a ROUTE macro. The user program can drop the attached file by issuing a RETURN macro. If the file remains attached when the job terminates, the file is returned to the queue from which it was attached.

The format of the remainder of the parameter block for a GET request is as follows:

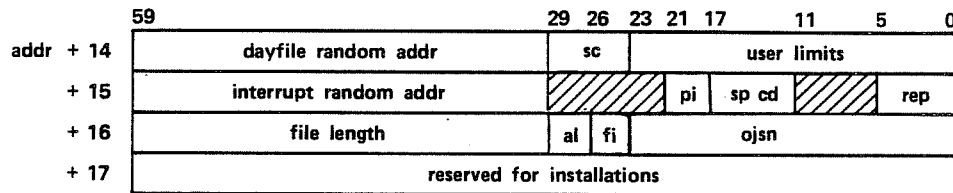

<u>Field</u>	<u>Description</u>
dayfile random addr	QAC enters the random address of the first PRU of the queued file's dayfile. If the file does not contain a dayfile, QAC enters a value of zero. This field applies only to print files.
sc	QAC enters the service class of the file. Refer to appendix E for a list of valid service classes and their corresponding 6-bit octal values.
user limits	QAC enters your authorized resource limit that applies to the type of device to which the file is routed. A value of 77777777 ₈ is defined as unlimited. This field applies only to output files.
interrupt random addr	If a GET request was previously performed on a file and the file was later returned to the queue, QAC enters file position from the time the file was returned to the queue. This value can be used to reposition the file.
pi	QAC enters the print train image code for the queued file. If nonzero, the code is biased by 10 ₈ .
sp cd	QAC enters the spacing code of the queued file. This field applies only to print files.
rep	QAC returns the repeat count specified for the queued file. This field applies only to output files.
file length	QAC enters the length of the file in PRUs.
al	QAC enters the security access level of the file.
fi	QAC enters the file size index of the file.
ojsn	QAC enters the original job sequence name (JSN) for the file. This is the JSN under which the file was created.

An extended version of the GET function can be selected by entering a length of 116g in the len field in word addr+1 of the QAC parameter block. The extended GET function returns additional accounting information and control information for remote host files.

QAC returns the following information to addr+20g through addr+122g of the QAC parameter block for an extended GET request. Extended GET request parameter block (len field of addr+1 of QAC parameter block = 116g):

	59	47	23	17	11	0
addr + 20	accounting information (word AHMT)					
+ 21	accounting information (word AHDS)					
+ 22	accounting information (word AACW)					
+ 23	owner user name					
+ 24	owner family name					
+ 25	creation user name					
+ 26	creation family name					
+ 27	remote mainframe user name					
+ 30	remote mainframe family name					
+ 31	user job name					
+ 32	data dec	0	imp length	exp length		
+ 33	implicit remote text string					
⋮						
+ 64	explicit remote text string					
+ 65						
⋮						
+116						
+117	encrypted batch password for input file (SSJ= only)			reserved for CDC		
+120	charge number					
+121						
+122	project number					

<u>Field</u>	<u>Description</u>
accounting information	Accounting words AHMT, AHDS, and AACW for the file. Refer to the NOS 2 Administration Handbook for descriptions of these words.
owner user name	The user name of the owner of the file.
owner family name	The family name of the owner of the file.
creation user name	The user name of the creator of the file.
creation family name	The family name of the creator of the file.
remote mainframe user name	For remote host files, the user name under which the file is accessed on a remote mainframe. For other files, this field has a value of zero.

<u>Field</u>	<u>Description</u>
remote mainframe family name	For remote host files, the family name under which the file is accessed on a remote mainframe. For other files, this field has a value of zero.
user job name	The user job name for the file.
data dec	Data declaration field from DSP parameter block (files routed to remote mainframe using extended DSP request only).
imp length	Character length of implicit remote text string (remote host files only).
exp length	Character length of explicit remote text string (remote host files only).
implicit remote text string	For remote host files, a string of up to 400g characters that contains parameters for the operating system under which the file was created. For other files, this field has a value of zero.
explicit remote text string	For remote host files, an optional string of up to 400g characters that form a job command in the job control language of the operating system of the mainframe that is to process the file. For other files, this field has a value of zero.
charge number	The charge number associated with the file.
project number	The project number associated with the file.

PEEK REQUEST

The PEEK request examines selected queued files or executing jobs, and returns information about those files and/or jobs to the QAC buffer. The user program specifies which files/jobs QAC is to consider by setting the appropriate selection flags and their corresponding fields in words addr+0 through addr+13g of the parameter block and selects the information about those files/jobs that QAC is to return.

You can use the PEEK request to obtain a count of queued files and executing jobs that belong to you. To do this, include a PEEK request in your program without setting any peek information bits; QAC will enter the number of queued files and executing jobs for your user name in words addr+14g and addr+15g.

When the QAC buffer is filled with PEEK reply information during a PEEK request, QAC enters the QFT or EJT ordinal of the file or job last examined in the ejt/qft ord field of addr+4 and enters the queue last examined in the queue field of addr+4. To issue a continuation call, the user program clears the completion bit (addr+0) and empties the QAC buffer by setting out (addr+3) to the value of in (addr+2). The program then reissues the RA+1 call. QAC continues its search from the file or job at which it was interrupted.

The format of the remainder of the parameter block for a PEEK request is as follows:

	59	47	35	23	11	0
addr + 14	incnt	excnt	prcnt	phcnt	plcnt	
+ 15	wtcnt			iscnt	ent length	
+ 16	peek information bits					
+ 17	reserved for installations					

<u>Field</u>	<u>Description</u>
incnt	<p>If no peek information bits are set (addr+l6g), QAC enters the number of files in the input queue that are eligible for selection. For any input queue files to be eligible for selection, the user program must set bit 0 of the queue sel field, addr+l0g.</p> <p>If any peek information bits are set, the user program must enter the maximum number of files to be selected from the input queue. When the PEEK request is completed, QAC enters the actual number of input queue files selected.</p>
excnt	This field is used in the same manner as the incnt field, except that it applies to jobs in the executing job queue. For any jobs in the executing job queue to be eligible for selection, the user program must set bit 1 of the queue sel field, addr+l0g.
prcnt	This field is used in the same manner as the incnt field, except that it applies to files in the print queue. For any print queue files to be eligible for selection, the user program must set bit 2 of the queue sel field, addr+l0g.
phcnt	This field is used in the same manner as the incnt field, except that it applies to files in the punch queue. For any punch queue files to be eligible for selection, the user program must set bit 3 of the queue sel field, addr+l0g.
plcnt	This field is used in the same manner as the incnt field, except that it applies to files in the plot queue. For any plot queue files to be eligible for selection, the user program must set bit 4 of the queue sel field, addr+l0g.
wtcnt	This field is used in the same manner as the incnt field, except that it applies to files in the wait queue. For any wait queue files to be eligible for selection, the user program must set bit 5 of the queue sel field, addr+l0g.
iscnt	This field is reserved for installations.
ent length	QAC enters the length, in words, of each reply in the PEEK reply buffer. If no PEEK information bits are set, no value is returned by QAC, and an entry length of zero is returned in the PEEK reply block. If any PEEK information bits are set, QAC creates a block of replies that all have the same length. Any words in a particular reply that are not defined for the queue type of the reply contain zeros.
peek information bits	<p>The bits in this word correspond to the octal numbers in the lower 6 bits of words in the peek reply block. Each bit set in this word causes QAC to return the information shown in the corresponding word of the peek reply block. Certain bits select information contained in more than one word in the reply block: Bit 14 selects message buffer one for the control point area (MS1W), bit 15 selects message buffer two for the control point area (MS2W), bit 18 selects dayfile messages, bit 19 selects the command buffer, bit 21 selects the implicit remote text string, and bit 22 selects the explicit remote text string.</p> <p>Symbols for these peek information bits are defined in the system OPL common deck COMSQAC.</p>

For each file or job that satisfies the selection criteria specified in the QAC parameter block, QAC returns a PEEK reply block to the QAC buffer. Each PEEK reply block has the following format.

59	57	53	47	44	41	35	29	23	17	11	5	0
jsn						ordinal			queue		0	01†
sc	ot	forms			disp	ec	ic	0		02†		
priority			fl-em		fl-cm		0		0			03†
destination family									0	0	04†	
destination user name									id	0	05†	
owner family									0	0	06†	
owner user name									cid	0	07†	
dfo	destination ui				ofc	owner ui			0		10†	
user job name									0	0	11†	
pi	sp	cd	I	0	rep	account limit			0		12†	
esto			creation date + time						0		13†	
file length					creation jsn				0		14†	
ejt stat		0	c	scheduling field					0		15†	
0								len1	1††	16††		
MS1W characters 1-10												
MS1W characters 11-20												
MS1W characters 21-30												
MS1W characters 31-40												
MS1W characters 41-50												
0								len2	1††	17††		
MS2W characters 1-10												
MS2W characters 11-20												
MS2W characters 21-30												
SRU limit									0	20†		
SRUs accumulated									0	21†		
0					alen3	len3	1		22††			
dayfile messages (first word)												
~												
dayfile messages (word len3)												
0					alen4	len4	1		23††			
commands (first word)												
~												
commands (word len4)												

†This field has a value of zero if the rest of the word contains all zeros.
 ††This field has a value of zero if the following word contains all zeros.

59	53	47	35	29	23	20	17	14	11	5	0
0	dlid			0	slid			0	24†		
0			clen		wlen		1††		25††		
implicit remote text string (characters 1-10)											
≈											
implicit remote text string (characters 251-256)											
0			clen		wlen		1††		26††		
explicit remote text string (characters 1-10)											
≈											
explicit remote text string (characters 251-256)											
remote mainframe user								0		27†	
remote mainframe family								0		30†	
0		ojsn			/	la	ua	al	0		31†
reserved for installations								1†		32†	
reserved for installations								1†		33†	

NOTE

The octal numbers in the lower 6 bits of words in the peek reply block correspond to the peek information bits in word addr+16g of the parameter block for a PEEK request. (See the description for the peek information bits field.)

<u>Field</u>	<u>Description</u>																				
jsn	The job sequence name of the selected job or file.																				
ordinal	The EJT or QFT ordinal of the selected job or file.																				
queue	The queue in which the job or file is located.																				
	<table border="0" style="margin-left: 40px;"> <thead> <tr> <th style="text-align: left;"><u>Bit(s)</u></th> <th style="text-align: left;"><u>Queue</u></th> </tr> </thead> <tbody> <tr> <td>0</td> <td>Input queue.</td> </tr> <tr> <td>1</td> <td>Executing job queue.</td> </tr> <tr> <td>2</td> <td>Print queue.</td> </tr> <tr> <td>3</td> <td>Punch queue.</td> </tr> <tr> <td>4</td> <td>Plot queue.</td> </tr> <tr> <td>5</td> <td>Wait queue.</td> </tr> <tr> <td>6-7</td> <td>Reserved for Control Data.</td> </tr> <tr> <td>8</td> <td>Reserved for installations.</td> </tr> <tr> <td>9-11</td> <td>Reserved for Control Data.</td> </tr> </tbody> </table>	<u>Bit(s)</u>	<u>Queue</u>	0	Input queue.	1	Executing job queue.	2	Print queue.	3	Punch queue.	4	Plot queue.	5	Wait queue.	6-7	Reserved for Control Data.	8	Reserved for installations.	9-11	Reserved for Control Data.
<u>Bit(s)</u>	<u>Queue</u>																				
0	Input queue.																				
1	Executing job queue.																				
2	Print queue.																				
3	Punch queue.																				
4	Plot queue.																				
5	Wait queue.																				
6-7	Reserved for Control Data.																				
8	Reserved for installations.																				
9-11	Reserved for Control Data.																				
sc	The service class of the job or file. For a list of the service class values, refer to Service Class Types in appendix E.																				
ot	The origin type of the job or file.																				

†This field has a value of zero if the rest of the word contains all zeros.
††This field has a value of zero if the following word contains all zeros.

<u>Field</u>	<u>Description</u>										
	<table border="1"> <thead> <tr> <th><u>ot</u></th> <th><u>Origin Type†</u></th> </tr> </thead> <tbody> <tr> <td>01</td> <td>SYOT (system)</td> </tr> <tr> <td>02</td> <td>BCOT (local batch)</td> </tr> <tr> <td>03</td> <td>RBOT (remote batch)</td> </tr> <tr> <td>04</td> <td>IAOT (interactive)</td> </tr> </tbody> </table>	<u>ot</u>	<u>Origin Type†</u>	01	SYOT (system)	02	BCOT (local batch)	03	RBOT (remote batch)	04	IAOT (interactive)
<u>ot</u>	<u>Origin Type†</u>										
01	SYOT (system)										
02	BCOT (local batch)										
03	RBOT (remote batch)										
04	IAOT (interactive)										
forms	The forms code for the file. Does not apply to jobs in the executing queue or files in the input queue.										
disp	The disposition code assigned to the file. Does not apply to executing jobs.										
ec	The external characteristics of the file. Does not apply to entries in the executing queue or the input queue.										
ic	The internal characteristics of the file. Does not apply to entries in the executing queue or the input queue.										
priority	The queue priority of a queue file or the CPU priority of an executing job at the time the PEEK request took place.										
fl-em	The current extended memory field length for the job. Applies only to jobs in the executing queue.										
fl-cm	The current central memory field length for the job. Applies only to jobs in the executing queue.										
destination family	The destination family for the file, if the file is not routed to a local batch device. This represents the family under which you would have to log on to a remote batch terminal in order to access the file. A value of zero is entered if the file is routed to a local batch device.										
destination user name	The destination user name for the file, if the file is not routed to a local batch device. This represents the user name under which you would have to log on to a remote batch terminal in order to access the file. A value of zero is entered if the file is routed to a local batch device.										
id	The destination batch device ID, if the file is routed to a local batch device; otherwise, zero.										
owner family	The family that owns the file or job.										
owner user name	The user name that owns the file or job.										
cid	The device ID of the device at which the file or job was created, if it was created at a local batch device; otherwise, zero.										

†Origin types returned by QAC do not have the same value as those defined in NOSTEXT.

<u>Field</u>	<u>Description</u>
dfo	The family ordinal corresponding to the destination family. A value of zero indicates no family ordinal.
destination ui	The user index corresponding to the destination user name. A value of zero indicates no user index.
ofo	The family ordinal corresponding to the owner family. A value of zero indicates no family ordinal.
owner ui	The user index corresponding to the owner user name. A value of zero indicates no user index.
user job name	The user job name associated with the file or job.
pi	The print train image code for the file. If nonzero, the code is biased by 10 ₈ .

<u>Field</u>	<u>Description</u>																		
sp cd	The spacing code for the entry. Does not apply to jobs in the executing queue or files in the input queue.																		
I	This bit is set if the file is interrupted. Applies only to output files.																		
rep	The repeat count for the entry. Does not apply to jobs in the executing queue or files in the input queue.																		
account limit	The user's validated resource limit that applies to the type of device to which the file or job is routed. A value of 77777777 ₈ is defined as unlimited. Does not apply to jobs in the executing queue or files in the input queue.																		
esto	The EST ordinal of the device on which the file resides. Does not apply to jobs in the executing queue.																		
creation date+time	The packed date and time when the file was first queued. The six 6-bit octal fields contain the following: year minus 1970, month, day, hour, minute, and second.																		
file length	The length of the file in PRUs. Does not apply to jobs in the executing queue.																		
creation jsn	The job sequence name of the job that created the file or job.																		
ejt stat	The status field of the EJT entry. Applies only to executing jobs. Bits 1 through 5 contain the EJT job status of the job. Bits 7 through 10 contain the EJT connection status of the job. Refer to appendix E for a listing of valid EJT status codes and their meanings.																		
c	CPU status. Applies only to executing jobs.																		
	<table border="1"> <thead> <tr> <th><u>Value</u></th> <th><u>Description</u></th> </tr> </thead> <tbody> <tr> <td>0</td> <td>Null status.</td> </tr> <tr> <td>1</td> <td>A status (job active in CPU 0).</td> </tr> <tr> <td>2</td> <td>B status (job active in CPU 1).</td> </tr> <tr> <td>3</td> <td>Not used.</td> </tr> <tr> <td>4</td> <td>W status (job waiting for CPU).</td> </tr> <tr> <td>5</td> <td>X status (job waiting for recall).</td> </tr> <tr> <td>6</td> <td>I status (job waiting for PP drop).</td> </tr> <tr> <td>7</td> <td>Not used.</td> </tr> </tbody> </table>	<u>Value</u>	<u>Description</u>	0	Null status.	1	A status (job active in CPU 0).	2	B status (job active in CPU 1).	3	Not used.	4	W status (job waiting for CPU).	5	X status (job waiting for recall).	6	I status (job waiting for PP drop).	7	Not used.
<u>Value</u>	<u>Description</u>																		
0	Null status.																		
1	A status (job active in CPU 0).																		
2	B status (job active in CPU 1).																		
3	Not used.																		
4	W status (job waiting for CPU).																		
5	X status (job waiting for recall).																		
6	I status (job waiting for PP drop).																		
7	Not used.																		
scheduling field	The contents of this field depend on the EJT status of the job. Applies only to jobs in the execution queue. Refer to appendix E for a description of the scheduling field associated with each EJT status code.																		
len1	The length of MS1W in words. This field always has a value of five.																		
MS1W	The message in message buffer 1 of the job's control point area. The message can contain up to 50 characters. If the message is less than 50 characters long, it is terminated by the standard display coded line terminator sequence.																		

<u>Field</u>	<u>Description</u>
len2	The length of MS2W in words. This field always has a value of three.
MS2W	The message in message buffer 2 of the job's control point area. The message can contain up to 30 characters. If the message is less than 30 characters long, it is terminated by the standard display coded line terminator sequence.
SRU limit	The job's SRU limit (from the job control point area).
SRUs accumulated	The current number of SRUs accumulated by the job (from the job's control point area).
alen3	The number of nonzero words in the dayfile message entry.
len3	The length of the dayfile message entry in words. This field always has a value of 1148.
dayfile messages	QAC enters a copy of the job's dayfile buffer. Dayfile messages have the standard display coded line format.
alen4	The number of nonzero words in the commands entry.
len4	The length of the commands in words. This field always has a value of 1108.
commands	QAC enters a copy of the job's command buffer. Commands already executed and commands not yet read into the buffer do not appear. Commands have the standard display coded line format.
dlid	Destination logical identifier for the file.
slid	Source logical identifier for the file.
clen	The length of the implicit or explicit remote text string in characters.
wlen	The length of the implicit or explicit remote text string in words.
implicit remote text string	A string of up to 4008 characters that contains parameters for the operating system under which the file was created. This string is present only for remote host files.
explicit remote text string	A string of up to 4008 characters that form a job control command in the job control language of the operating system of the mainframe that is to process the file. This string is present only for remote host files.
remote mainframe user	The user name under which you must log on to a remote batch terminal to access the file at the destination mainframe. This word is present only for remote host files.
remote mainframe family	The family name under which you must log on to a remote batch terminal to access the file at the destination mainframe. This word is present only for remote host files.
ojns	The original job sequence name under which the file was created.

<u>Field</u>	<u>Description</u>
la	The lower access level limit of the input file or job.
ua	The upper access level limit of the input file or job.
al	The current access level of the file or job.

Example:

The following program locates up to 10 executing jobs that were submitted under the same user name as the program. All information about those jobs is stored in the PEEK reply buffer and is dumped. This program uses the SYSTEM macro (refer to section 11) to issue the QAC request.

```

IDENT PEEKJOB
ENTRY MAIN

**      QAC PARAMETER BLOCK

BLOCK  BSS      0
       VFD      59/3,1/0          PEEK FUNCTION CODE
       VFD      36/0,6/11,18/REPLY PEEK REPLY BUFFER, FIRST
       VFD      42/0,18/REPLY      "           , IN
       VFD      42/0,18/REPLY      "           , OUT
       VFD      42/0,18/REPLY+1000 "           , LIMIT
       VFD      60/0
       VFD      60/0
       VFD      60/0
       VFD      12/2,48/0          SELECT EXECUTING JOB QUEUE
       VFD      60/0
       VFD      60/0
       VFD      60/0
       VFD      12/0,12/10,36/0    SELECT UP TO 10 ENTRIES
       VFD      60/0
       VFD      37/0,23/-0        SELECT ALL INFORMATION
       VFD      60/0

**      MAIN PROGRAM

MAIN   SYSTEM QAC,R,BLOCK          CALL QAC
       SYSTEM DMD,R,BLOCK+15,BLOCK DUMP UPDATED PARAMETER BLOCK
       SYSTEM DMD,R,REPLY+1000,REPLY DUMP PEEK REPLY BUFFER
       ENDRUN

**      PEEK REPLY BUFFER

REPLY  BSSZ    1001              REPLY BUFFER

       END      MAIN

```

SYSTEM TIME/DATE REQUESTS

9

NOS provides several system requests associated with the time and date. These requests are processed directly by CPUMTR. Unless otherwise noted, the only common deck required for absolute assemblies is COMCSYS.

The format of the RA+1 call to the time function processor is:

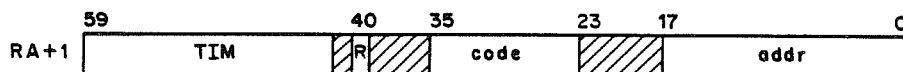

R Auto recall bit.

code Function code as follows:

<u>Code</u>	<u>Macro</u>	<u>Description</u>
0000	TIME	Accumulated CP time used by the job.
0001	DATE	Current date in display code.
0002	CLOCK	Current time of day in display code.
0003	JDATE	Current Julian date.
0005	RTIME	Elapsed real time since last deadstart.
0006	PDATE	Current date and time in packed binary form.
0007	STIME	Accumulated system resource units.
0011	HTIME	Accumulated clock cycle count for control point.
0012	HTIME	Accumulated clock cycle count since deadstart.

addr Address of a reserved one-word block that will receive the reply.

The EDATE and ETIME macros described in this section do not have an RA+1 call. They are processed by common deck COMCEDT and are used to convert the format of a date and time returned by a previous macro call.

CLOCK

In response to the CLOCK function, the system returns the current time of day in display code to location addr.

Macro format:

<u>Location</u>	<u>Operation</u>	<u>Variable</u>
	CLOCK	addr

addr Address of reply word.

Reply word format (display code):

	59	53	41	35	23	17	5	0
addr	Δ	hh	.	mm	.	ss	.	

Δ Space (display code 55g).

hh Hours.

mm Minutes.

ss Seconds.

DATE

In response to the DATE function, the system returns the current date in display code format to location addr.

Macro format:

<u>Location</u>	<u>Operation</u>	<u>Variable</u>
	DATE	addr

addr Address of reply word.

Reply word format (display code):

	59	53	41	35	23	17	5	0
addr	Δ	yy	/	mm	/	dd	.	

Δ Space (display code 55g).

yy Year (last two digits).

mm Month.

dd Day.

EDATE

EDATE converts the packed date in address pdate to display code and enters the converted date in register X6.

Macro format:†

<u>Location</u>	<u>Operation</u>	<u>Variable</u>
	EDATE	pdate

pdate Register or address containing packed date to be converted.

Format of address or register containing packed date:

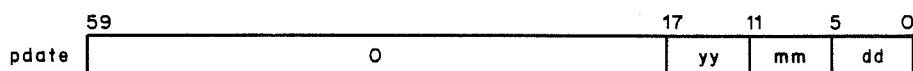

yy Year minus 1970.

mm Month.

dd Day.

Upon completion, register X6 contains the following (display code):

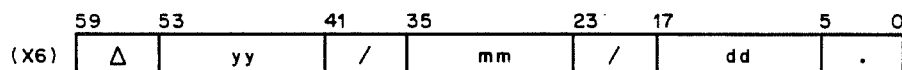

△ Space (display code 55₈).

yy Year (last two digits).

mm Month.

dd Day.

This macro requires the common decks COMCEDT and COMCCDD.

†This macro is not available in SYSTEXT. The user program must specify systems text PSSSTEXT or call common deck COMCMAC (refer to appendix F).

ETIME

ETIME converts the packed time in address ptime to display code and enters the converted time in register X6.

Macro format:†

<u>Location</u>	<u>Operation</u>	<u>Variable</u>
	ETIME	ptime

ptime Register or address containing packed time to be converted.

Format of address or register containing packed time:



hh Hours.

mm Minutes.

ss Seconds.

Upon completion, register X6 contains the following (display code):

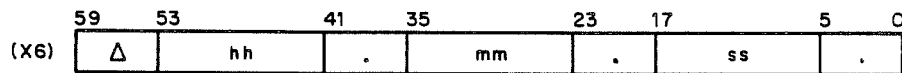

Δ Space (display code 55g).

hh Hours.

mm Minutes.

ss Seconds.

This macro requires the common decks COMCEDT and COMCCDD.

† This macro is not available in SYSTEXT. The user program must specify systems text PSSTEXT or call common deck COMCMAC (refer to appendix F).

HTIME

HTIME returns the model 176 accumulated CPU clock cycle count (if available) either for the current job or since the last system deadstart. A clock cycle on the model 176 is 27.5 nanoseconds.

Macro format:

<u>Location</u>	<u>Operation</u>	<u>Variable</u>
	HTIME	addr,op

addr Address of reply word.

op Option desired; if 0, accumulated clock cycle count for the current job is returned (function code 11); if 1, accumulated clock cycle count since the last system deadstart is returned (function code 12).

Reply word format:

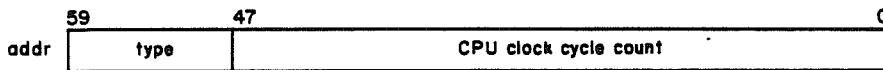

type If the model 176 CPU clock cycle count is available, type is 2000₈.
 If the model 176 CPU clock cycle count is not available, type is 6000₈.

JDATE

JDATE returns the current Julian date, in display code, to location addr.

Macro format:

<u>Location</u>	<u>Operation</u>	<u>Variable</u>
	JDATE	addr

addr Address of reply word.

Reply word format (display code):



yy Julian year.

ddd Julian day.

PDATE

PDATE returns the current date and time in binary packed format. The user program can unpack the parameters or use the EDATE and ETIME macros to do the unpacking.

Macro format:

<u>Location</u>	<u>Operation</u>	<u>Variable</u>
	PDATE	addr
addr		Address of reply word.

Reply word format:

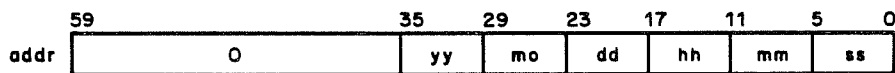

yy Year minus 1970.
mo Month.
dd Day.
hh Hours.
mm Minutes.
ss Seconds.

RTIME

RTIME returns the real-time clock reading to location addr. This is the elapsed time since deadstart.

Macro format:

<u>Location</u>	<u>Operation</u>	<u>Variable</u>
	RTIME	addr
addr		Address of reply word.

Reply word format:

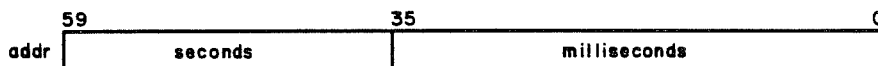

seconds Time since deadstart in seconds.
milliseconds Time since deadstart in milliseconds.

STIME

STIME returns the job's accumulated system resource units (SRUs). Refer to the NOS 2 Analysis Handbook for a description of SRUs.

Macro format:

<u>Location</u>	<u>Operation</u>	<u>Variable</u>
	STIME	addr
addr	Address of reply word.	

Reply word format:

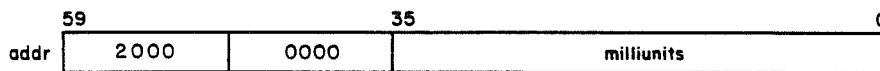

milliunits Accumulated system resource units/1000.

TIME

TIME returns the accumulated central processor time used by the job to location addr.

Macro format:

<u>Location</u>	<u>Operation</u>	<u>Variable</u>
	TIME	addr
addr	Address of reply word.	

Reply word format:

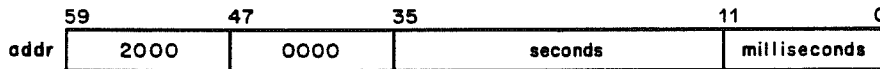

seconds Accumulated central processor time in seconds.

milliseconds Accumulated central processor time in milliseconds (modulo 1000).

NOTE

In order to use the values returned by the TIME macro to determine total accumulated central processor time, the user program must perform the following conversion:

Total time (milliseconds) = (seconds x 1000) + milliseconds.

Attempting to use bits 35 through 0 as a single quantity will produce meaningless results.

TRANSLATE CONTROL STATEMENT

Translate control statement (TCS) processes user requests to read a command from or to place a command into the stream. The only common deck required for absolute assembly is COMCSYS.

The format of the RA+1 call is:

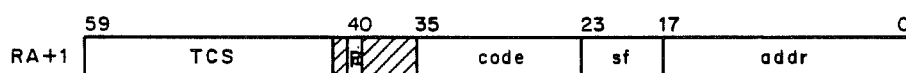

R Auto recall bit.

code Function code:

<u>Code</u>	<u>Macro</u>
004	CONTROL
005	EXCST

sf Subfunction code for the CONTROL macro. This field is not used for the EXCST macro.

<u>sf</u>	<u>Action</u>
00	Read the next command and advance the command pointer.
01	Read the next command only if it does not call for a load from a local file or from a global library set. Do not advance the command pointer.
02	Read the next command even if it calls for a load from a local file or from a global library set. Do not advance the command pointer.
4x	If the next command being read should be processed in product set format, sf should be set to 4x, where x can be 0, 1, or 2, corresponding to one of the above options. If sf is not set to 4x, command parameters are to be processed in NOS format.

addr First word address of the buffer in which the command is to be stored or from which the command is to be read.

CONTROL (004)

The CONTROL macro allows the user program to read the next command in the command stream and transfer it to a specific address. The command is checked for syntax errors, and all parameters are stored as if a program was actually loaded.

If no command exists or if SHELL program processing is in effect, binary zero words are returned to the buffer. If the next command is of the form:

```
*comments
```

the command is returned to the buffer if the comments string ends with a period or right parenthesis. Otherwise, the binary zero words are returned to the buffer.

Macro format:

<u>Location</u>	<u>Operation</u>	<u>Variable</u>
	CONTROL	addr,rss,lf,psf
addr	First word address of the buffer in which the next command is to be stored. The user program should allow room for eight words (80 characters).	
rss	If rss is specified (any value may be used), the command pointer is not advanced. This allows the user program to determine what the next command is and still allow it to be processed. If rss is not specified, the command pointer is advanced as if the command had been processed.	
lf	If rss is not specified, lf is ignored. If the following are true: <ul style="list-style-type: none">• rss is specified,• lf is not specified,• the command to be read calls for a load from a local file or from a global library set, the command is not read. If rss and lf are both specified (any value may be used for lf), the command is always read. If the command calls for a load from a local file or from a global library set, bit 17 or RA+64g is set.	
psf	If psf is specified (any value may be used), parameters are unpacked in product set format.	

The command parameters are stored in the job communication area (refer to figure E-1) beginning at ARGR (RA+2) through RA+n (n cannot exceed 63₈). These parameters are terminated by a zero word. The number of parameters stored in the job communication area is placed in the lower 18 bits of ACTR (RA+64₈). The name of the command is placed in bits 59 through 18 of PGNR (RA+64₈). The parameters are stored in either operating system or product set format, depending on psf. The command image, less any label or prefix field, is stored beginning at addr.

If the parameters are stored in operating system format, the comma, period, and right parenthesis are stored as zero. For all parameters and valid separators except the comma, their display code equivalent is stored.

If the parameters are stored in product set format, separators and terminators are stored as follows:

<u>Character</u>	<u>Code (Octal)</u>
,	1
=	2
/	3
(4
+	5
-	6
;	10
) or .	17
Others	16

The manner in which CONTROL stores the command is identical to the way the system normally processes commands, except that the command image is stored at the specified address. When the system processes a command, the command image is stored beginning at CCDR (RA+70₈). Calling the CONTROL macro does not affect the contents of CCDR.

Example:

The following program reads the next command in the command stream (advancing the command pointer), stores the parameters in operating system format, and transfers the command image to the specified buffer.

```

IDENT  CMND
ENTRY  CMND

CMBUF  BSS    8

CMND   CONTROL CMBUF
SYSTEM DMD,R,63B,2
SYSTEM DMD,R,CMBUF+7,CMBUF
ENDRUN

END    CMND

```

When the program is executed from a batch job or in a procedure file and is followed in the command stream by:

```
TEST,A=B,C=D,E,F.
```

the contents of central memory are displayed as follows:

ARGR	RA+2	0100	0000	0000	0000	0054	A	=
	+3	0200	0000	0000	0000	0000	B	
	+4	0300	0000	0000	0000	0054	C	=
	+5	0400	0000	0000	0000	0000	D	
	+6	0500	0000	0000	0000	0000	E	
	+7	0600	0000	0000	0000	0000	F	
	+10	0000	0000	0000	0000	0000		
	.							
	.							
	.							
CMBUF	+0	2405	2324	5601	5402	5603	TEST,A=B,C	
	+1	5404	5605	5606	5700	0000	=D,E,F.	
	.							
	.							
	.							

If the macro call is changed to

```
CONTROL CMBUF,,,PSF
```

the command parameters are stored in product set format and the contents of locations RA+2 through RA+10g appear as follows:

ARGR	RA+2	0100	0000	0000	0000	0002	A	B
	+3	0200	0000	0000	0000	0001	B	A
	+4	0300	0000	0000	0000	0002	C	B
	+5	0400	0000	0000	0000	0001	D	A
	+6	0500	0000	0000	0000	0001	E	A
	+7	0600	0000	0000	0000	0017	F	O
	+10	0000	0000	0000	0000	0000		

EXCST (005)

With the EXCST macro the user program specifies a buffer containing a command. Control is transferred from the calling program to the system, which reads the command, places it in the command stream, and processes it. Control is not returned to the calling program. The command must conform to NOS command format conventions described in Volume 3, System Commands.

Macro format:†

<u>Location</u>	<u>Operation</u>	<u>Variable</u>
	EXCST	addr

addr First word address of the buffer containing the command to be processed. The system begins reading at addr and continues until the end of statement (zero byte) or end of buffer (80 characters) is reached. The command must be left-justified with zero fill.

CHECKPOINT/RESTART

A job may be terminated at any time as the result of system, operator, or program error. For some jobs it becomes more advantageous to accept the overhead of checkpoint procedures than to run the risk of losing the entire job output. The checkpoint/restart feature is implemented through the CKP command or CHECKPT macro and the RESTART command. Refer to Volume 3, System Commands, for discussions of the CKP and RESTART commands.

CHECKPT

The CHECKPT macro is used for taking checkpoint dumps. The dump is written on the tape or mass storage checkpoint file specified on a REQUEST, ASSIGN, or LABEL command or REQUEST or LABEL macro. For a general description of checkpoint dumps, refer to Volume 3, System Commands. The CHECKPT macro provides you with greater control than the CKP command in specifying the type of copy to be performed.

NOTE

A checkpoint is not allowed in a program that has issued a PROTECT macro selecting user file privacy, in a program that has issued a SETSSM macro, or in a program that has been loaded from an execute-only file.

†This macro is not available in SYSTEXT. The user program must specify systems text PSSTEXT or call common deck COMCMAC (refer to appendix F).

Macro format:†

<u>Location</u>	<u>Operation</u>	<u>Variable</u>
	CHECKPT	addr, sp

addr Address of the parameter list identifying the files to be checkpointed.

sp Flag indicating whether or not all files assigned to the job are to be checkpointed. If sp is specified (any value may be used), only those files specified in the parameter block at address addr will be checkpointed. If the sp field is not specified, all local files will be checkpointed.

The format of the RA+1 call is:

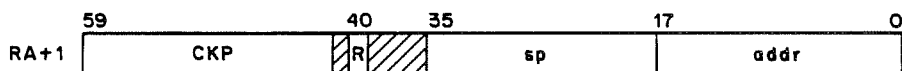

R Auto recall bit.

sp Flag indicating whether or not all files assigned to the job are to be checkpointed. If sp is specified (any value may be used), only those files specified in the parameter block at address addr will be checkpointed. If the sp field is not specified, all local files will be checkpointed.

addr Address of the parameter block identifying the files to be checkpointed.

Parameter list format:

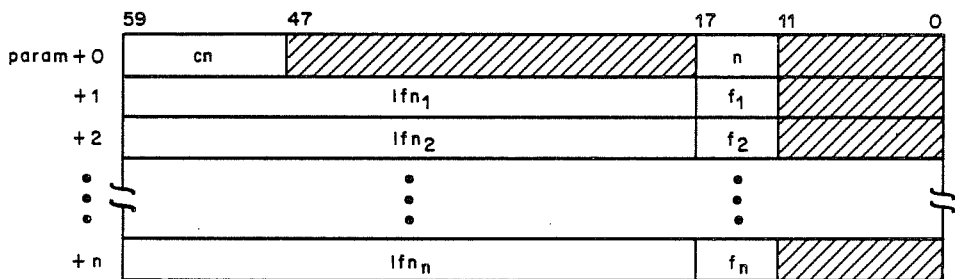

cn Latest checkpoint number.

n Octal number of entries in the parameter list ($0 < n < 77_8$).

† This macro is not available in SYSTEXT. The user program must specify systems text PSSTEXT or call common deck COMCMAC (refer to appendix F).

lfn_i Identifies file to be checkpointed; lfn_i is left-justified.

f_i Specifies the manner in which lfn_i is to be copied:

<u>f_i</u>	<u>Description</u>
0	The mass storage file is copied from the BOI to its position at checkpoint; only that portion is available for restart. RESTART positions the file at the latter point.
1	The mass storage file is copied from its position at checkpoint to the EOI; only that portion is available for restart. RESTART positions the file at the former point.
2	The entire mass storage file is copied. RESTART sets the file to its position at checkpoint time.
3	The last operation on the file determines how the mass storage file is copied.

<u>Last Operation</u>	<u>f Selected</u>
-----------------------	-------------------

Write	f _i =0
Read (EOI detected)	No copy
Read (EOI not detected)	f _i =2

4 The information table associated with the file is copied but the file itself is not copied. The information table contains FNT/FST information and the random address of the mass storage file or the block count of the magnetic tape file. RESTART retrieves the file in some cases (refer to RESTART) and sets it to its position at checkpoint time. If f_i=4 and the file is a mass storage file, RESTART assumes it is an indirect access file and issues a GET macro to obtain a working copy.

If a value other than 4 is specified for a magnetic tape file, a warning message is issued and the file is processed as if f_i =4 had been specified. f_i =4 is also forced for execute-only files.

The following list shows the type of operation CHECKPT performs for the different values of sp and n.

<u>sp</u>	<u>n</u>	<u>Operation</u>
any	0	All files assigned to the job at checkpoint time are processed according to the last operation performed.
0	≠ 0	All files assigned to the job at checkpoint time are processed. The n files included in the parameter list are processed according to their respective f values. All other files are processed according to the last operation performed.
≠ 0	≠ 0	The n files specified in the parameter list are processed according to their respective f values.

The procedure scratch files ZZZZC0, ZZZZC1, and ZZZZC2 are always checkpointed; they are copied from BOI to EOI (refer to $f_i = 2$), regardless of the sp and n values.

The INPUT, OUTPUT, PUNCH, PUNCHB, P8, and LGO files, and procedure data files ZZCLAA through ZZCLZZ are always checkpointed; they are copied according to the last operation performed (refer to $f_i = 3$), regardless of the sp and n values.

For all other files except direct access files, the default copy type is $f=4$ when $n \neq 0$. For direct access files, the type of copy CHECKPT makes depends on the access mode.

	<u>Mode</u>	<u>User Option</u>	<u>Default</u>
W	Write	Any type of copy	Copied ($f=3$)
R	Read-only	Any type of copy	Not copied ($f=4$)
E	Execute-only	Only $f=4$	Not copied ($f=4$)
A	Append-only	Any type of copy	Copied ($f=3$)
M	Modify	Any type of copy	Copied ($f=3$)
RA	Read/allow append	Any type of copy	Copied ($f=3$)
RM	Read/allow modify	Any type of copy	Copied ($f=3$)
U	Update	Any type of copy	Copied ($f=3$)
RU	Read/allow update	Any type of copy	Copied ($f=3$)

For a random file the copy type must be $f=2$ or it will be copied according to the last operation performed ($f=3$).

If $f=4$ is selected, you may have to retrieve the file yourself at restart time and select the NA and FC options on the RESTART command (refer to Volume 3, System Commands).

REPRIEVE PROCESSING

Reprieve processing (routine RPV) enables the user program to intercept interrupts prior to an abort of the program and to take corrective action. This action can be the completion of files (such as flushing buffers or closing files) and tables or it can be an attempt to correct the problem.

The format of the call to RPV is as follows:

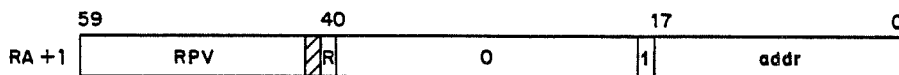

R Auto recall bit.

addr First word address of the parameter block.

RPV supports the following functions.

- SETUP
- RESUME
- IRESUME
- RESET

The SETUP function is used to initialize the parameters for the RPV interface (that is setting the mask bits that indicate which errors are to be intercepted). It also initializes all RPV data in the job's control point area; if the parameter block indicates pending interrupts or I/O requests, they are processed at that time.

The interrupt handler is that portion of your program that processes interrupts. When an error occurs, the system will interrupt your program and restart it at the address that was specified in the RPV block. At this point, your program is running in interrupt handler mode which will prevent further errors from interrupting the program until the program has completed processing the first error.

The resume functions are used to restart the program after an interrupt has been processed. Any pending interrupts that occurred during the processing of the previous interrupt are detected then and the interrupt handler is restarted to process these interrupts. Optionally, the mask bits can also be changed during a resume function. Two modes of resume are allowed: program mode and interrupt handler mode.

NOTE

If the interrupt being processed is a CPU error exit, a resume function is not possible without manipulation of the exchange package and, in most cases, is not practical even with such manipulation.

The program mode resume (RESUME) will cause the system to restart the program at the interrupt point. The interrupt handler mode will be cleared so that any additional errors will cause a new interrupt of the program. Also, any errors which occurred during interrupt handler mode processing will cause a new interrupt at this time.

The interrupt handler mode resume (IRESUME) will cause the system to restart the program at the point of interrupt, but without clearing the interrupt handler mode. This allows the program to complete the task it was engaged in before the interrupt, and to then process the error and terminate the program at some later time.

NOTE

Further interrupts will be inhibited after the IRESUME is processed. Normal processing may be resumed by issuing another REPRIEVE SETUP.

The RESET function is used to reset a previous error flag and allow the operating system error handling routines to process the error. That is, the mask bits are cleared to disable further reprieve processing and the system processes the error as if the appropriate mask bit had not been set. Pending interrupts are not processed; however, any pending RA+1 request is reset and the exchange package is reset from the reprieve parameter block.

RPVBLK

The RPBVLK macro creates a REPRIEVE parameter block.

Macro format:†

<u>Location</u>	<u>Operation</u>	<u>Variable</u>
tag	RPVBLK	xfer,xjp,chklwa
tag		Symbol for address of parameter block.
xfer		Address of error processing routine (transfer address).
xjp		Symbol for address of exchange package within parameter block (optional).
chklwa		Checksum last word address (optional).

†This macro is not available in SYSTEXT. The user program must specify systems text PSSTEXT or call common deck COMCCMD (refer to appendix F). This macro requires common deck COMSRPV.

The format of the parameter block is as follows:

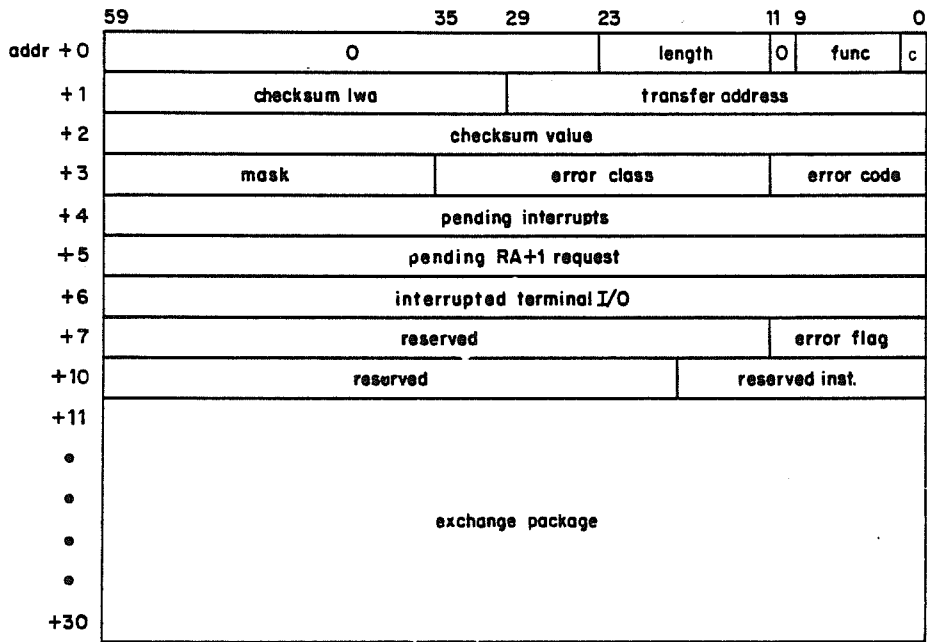

length Length of the parameter block including the exchange package area (minimum of 31g words).

func Function code:

1	SETUP.
2	Program mode resume (RESUME).
3	RESET.
4	Interrupt handler mode resume (IRESUME).

c Completion bit (set by RPV when operation is complete).

checksum lwa Specified by the user to indicate the end of the area to be checksummed and compared or set. If zero, no checksum is desired (checksum area begins at transfer address).

transfer address Address to which control is transferred when an interrupt is processed.

checksum value Either set to the checksum of the indicated area when RPV is called, or compared against the computed checksum (if checksum lwa is specified) when a reparable error is processed.

mask Indicates which types of interrupts are to be intercepted so that they may be processed in the program. If a particular bit is set in the mask, the corresponding error class will be intercepted; if a bit is clear in the mask, the corresponding error class will be processed by the system. If mask=0, extended reprieve processing is cleared.

<u>mask</u>	<u>Error Class</u>
001	CPU error exit.†
002	PP call error.
004	SRU limit.
010	Operator termination.††
020	PP abort.
040	CPU abort.
100	Normal termination.
200	Terminal interrupt.†††

error class†††† Set to the value of the mask bit which intercepts the indicated error (that is, if error x is intercepted by mask bit n, then bit n in the error class field is set). Refer to table 10-1 for a list of error classes.

error code†††† Octal code indicating error encountered. Refer to table 10-1 for a list of error codes and their meanings.

pending interrupts Used to queue pending interrupts (that is, the nth error code sets bit n in this field).

pending RA+1 request††††† Contents of RA+1 at time of interrupt. RA+1 is reset from this field on a resume or reset call.

interrupted terminal I/O††††† Contains interrupted input request if an interrupt occurs while a terminal input request is pending. The format is as follows:



error flag††††† Value of the operating system error flag at the time of the interrupt (refer to appendix E for a list of error flags).

†The MODE macro, described in section 6, can be used to specify which types of arithmetic operations will cause this error to be detected.

††NOS will allow a job to reprieve an operator KILL only once; the second time the operator KILLS the job, no reprieve processing will occur.

†††Refer to Control of Program Execution in section 12 for a description of the methods by which you can interrupt a program from a terminal.

††††Because the binary values of the error flags are subject to change in subsequent releases of NOS, you are encouraged to use the error class and error code fields for checking error status rather than the error flag field.

†††††If this field is nonzero, the FET involved has been left in a busy state. If the program wishes to use this FET within the interrupt handler (prior to doing a REPRIEVE RESUME), it is the program's responsibility to set the FET complete before trying to use it.

reserved
inst.

This area is reserved for use by the installation.

exchange
package

A copy of the exchange package at the time of the interrupt (unchanged from the executing package at the time of the error). This is the exchange package that is used when the interrupt handler is started.

Table 10-1 lists the return information for RPV error codes, classes, and flags.

Table 10-1. RPV Error Codes, Classes, and Flags

Error Code(s)	Description	Error Class	Corresponding Error Flags
0	Normal termination	100	None
1	Time limit	004	TLET
2	CPU error exit†	001	ARET, PEET, PSET
3	PP abort, SCP invalid transfer address	020	PPET, MLET, ITET
4	CPU abort	040	CPET
5	PP call error	002	PCET
6	Operator drop	010	ODET, IDET, STET
7	Operator kill	010	SSET, OKET, ORET, SYET, FSET
10	Operator rerun	010	RRET
11	Command error	040	None
12	Extended memory parity error	020	ECET
15	Auto recall error	002	None
16	Job hung in auto recall	002	RCET
17	Mass storage/service limits	004	FLET, TKET, SLET
20	PP program not in library	002	None
21	I/O limits	004	SRET
34-37	Reserved for installations	N/A	None
40	Terminal interrupt††	200	TIET, TAET
N/A	Reserved for installations	2000	None
N/A	Reserved for installations	4000	None
N/A	N/A	N/A	DRET, TJET, RAET

†The MODE macro, described in section 6, can be used to specify which types of arithmetic operations will cause this error to be detected.

†† Refer to Control of Program Execution in section 12 for a description of the methods by which you can interrupt a program from a terminal.

Refer to appendix E for a complete list of error flags and descriptions.

REPRIEVE

The REPRIEVE macro provides access to the extended reprieve processing capabilities of RPV. REPRIEVE parameters are inserted into the designated positions in the parameter block. Other fields are the responsibility of the caller.

NOTE

An error will occur if a REPRIEVE macro is issued while either DISTC or EREXIT is in effect (DISTC processing is described in section 11 of this manual; EREXIT processing is described in section 6).

Macro format:†

<u>Location</u>	<u>Operation</u>	<u>Variable</u>
	REPRIEVE	addr,type,mask
addr		Address of the parameter block.
type		Type of call: SETUP, RESET, RESUME (program mode), or IRESUME (interrupt handler mode).
mask		Desired mask setting.

The REPRIEVE macro issues the RA+1 request without using common deck COMCSYS, since that routine is not reentrant and the interrupt could have occurred there. The interrupt handler should not access any other portions of the program which are not reentrant or are shared with noninterrupt handler code.

†This macro is not available in SYSTEXT. The user program must specify systems text PSSTEXT or call common deck COMCCMD (refer to appendix F).

One way to avoid this problem is to qualify those macro calls in the interrupt handler that use COMCSYS to issue the requests, and also provide a qualified copy of COMCSYS to ensure that no conflict exists. The following example illustrates this process with the MESSAGE macro.

```
Interrupt handler code
.
.
.
QUAL    IHX
MESSAGE ERR1,3
QUAL    *
.
.
.
ERR1    DATA    C*SOME ERROR*
QUAL    IHX
QUALS   SET      0    FORCE UNQUALIFIED COMMON DECKS
OPL     XTEXT    COMCSYS
QUAL    *
.
.
.
```

Appendix M contains an illustration of extended reprieve processing.

SYSTEM REQUESTS

The following requests perform miscellaneous tasks associated with a job. Most of the requests are processed by the system monitor directly rather than by a specific function processor. The calling format is shown for each macro. Unless otherwise noted, the only common deck required for absolute assemblies is COMCSYS.

ABORT

A user program can abort itself when a program error occurs by using the ABORT macro. If the job or the current procedure contains an EXIT command, the system continues job processing with the command that immediately follows the EXIT command. This process can be altered either by reprieve processing (refer to section 10) or by using the NOEXIT command (refer to Volume 3, System Commands).

Macro format:

<u>Location</u>	<u>Operation</u>	<u>Variable</u>
	ABORT	

The format of the RA+1 call for this function is:



DAYFILE

The DAYFILE macro enables the user program to access the job dayfile. A FET of at least seven words must be specified.

A portion of the dayfile resides in the system central memory buffers. This is transferred to the buffer in the job's field length specified by the FET pointers FIRST and LIMIT. You must ensure that the buffer specified is large enough to accommodate the central memory portion of the dayfile. The released size is 1148; if the value is different at your site, you should contact your site personnel to determine what it is.

That portion of the dayfile that resides on mass storage is made available to the user program as a library file assigned to the job in read-only mode. If a local file with the same name as the file name specified already exists, it is returned. The file is positioned at BOI.

This macro requires common decks COMCSFM and COMSSFm for both relocatable and absolute assemblies and also requires common deck COMCSYS for absolute assemblies.

Macro format:†

<u>Location</u>	<u>Operation</u>	<u>Variable</u>
	DAYFILE	addr,type

addr Address of the FET for the call; name given to the mass storage portion of the file.

type USER (function 0005); attach dayfile. This is the dayfile of the job currently running.

The DAYFILE macro issues the following request to the function processor SFM.

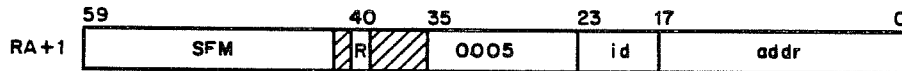

R Auto recall bit (required).

id File identification number.

addr Address of the FET for the file.

The format of the FET used by SFM is:

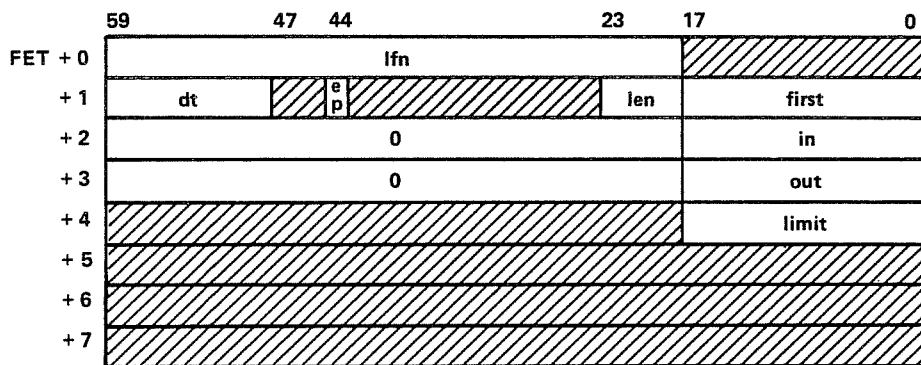

†The macro is not available in SYSTEXT. The user program must specify system text PSSTEXT or call common deck COMCMAC (refer to appendix F).

lfn Local file name of the file to which the job dayfile is to be returned.

dt Device type of the device on which the local file resides (refer to Equipment Codes in appendix E).

ep Error processing bit (refer to FET Description in section 2).

len Specifies the length of the FET beyond five words.

first First word address of input/output buffer (FIRST address).

in The next available location for entering data into the buffer (IN address).

out The next available location for removing data from the buffer (OUT address).

limit Last word address of the buffer plus 1 (LIMIT address).

The IN and OUT FET pointers are updated after this request to indicate the presence of data in the buffer.

The following example reads the user dayfile and writes it to OUTPUT (assembly of this program requires that the system OPL be attached to the job).

```

IDENT DAYF
ENTRY DAYF
SYSCOM B1
OPL      XTEXT COMSSF
**      ASSEMBLY CONSTANTS.

CBUFL   EQU    400B      CM BUFFER LENGTH
BUFL    EQU    301B      DAYFILE/OUTPUT BUFFER LENGTH
WBUFL   EQU    300B      WORKING BUFFER LENGTH

**      FETS AND CONSTANTS.

I       BSS    0          DAYFILE
SCR     FILEB  IBUF,BUFL,FET=7

O       BSS    0          OUTPUT
OUTPUT  FILEB  OBUF,BUFL,FET=7

WDCT    DATA  0          WORD COUNT OF CM BUFFER

**      MAIN PROGRAM.

DAYF    SB1    1
        DAYFILE I,USER

*       SAVE CM BUFFER PORTION OF DAYFILE.

SA1     I+1          COMPUTE CM BUFFER WORD COUNT
SA2     A1+1
SX1     X1
IX6     X2-X1
ZR      X6,DAY1      IF CM BUFFER EMPTY
SA6     WDCT
READW   I,CBUF,X6    READ CM BUFFER

*       TRANSFER MASS STORAGE PORTION OF DAYFILE.

DAY1    READ   I          INITIATE FILE READ
DAY2    READW  I,WBUF,WBUFL
        NZ     X1,DAY3    IF TRANSFER COMPLETE
        WRITEW O,WBUF,WBUFL CONTINUE TRANSFER

        EQ     DAY2

DAY3    SX2    B6-WBUF    SET WORDS TRANSFERRED
        ZR     X2,DAY4    IF NONE
        WRITEW O,WBUF,X2  EMPTY BUFFER

*       WRITE CM BUFFER PORTION OF DAYFILE.

DAY4    SA2    WDCT      GET CM BUFFER WORD COUNT
        ZR     X2,DAYS5   IF CM BUFFER EMPTY
        WRITEW O,CBUF,X2  WRITE CM BUFFER

DAY5    WRITER 0
        RETURN I
        ENDRUN

**      COMMON DECKS.

OPL     XTEXT  COMCSFM

**      BUFFERS.

IBUF    BSS    BUFL      DAYFILE BUFFER
OBUF    BSS    BUFL      OUTPUT BUFFER
CBUF    BSS    CBUFL     CM BUFFER
WBUF    BSS    WBUFL     WORKING BUFFER

END     DAYF

```



ENDRUN

The ENDRUN macro requests normal termination of a program. The system begins execution with the next command, if there is one. If there are no more commands or if the next command is an EXIT command, the system terminates the job. This process can be altered by reprove processing (refer to section 10).

Macro format:

<u>Location</u>	<u>Operation</u>	<u>Variable</u>
	ENDRUN	

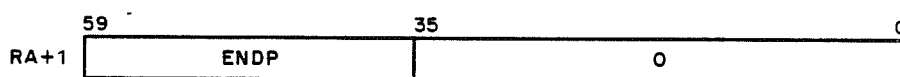
The format of the RA+1 call for this function is:



GETLIDA

The GETLIDA macro allows the user program to obtain the various attributes for a specified LID. Common decks COMSSF and COMCSFM are required for absolute and relocatable assemblies.

Macro format:†

<u>Location</u>	<u>Operation</u>	<u>Variable</u>
	GETLIDA	addr

addr Address to receive attributes of specified LID.

The format for the RA+1 call for this function is:

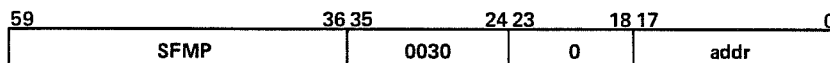

The format of addr word (before the call to COMCSFM) is:



lid User-specified lid.

†This macro is not available in SYSTEXT. The user program must specify systems text PSSTEXT or call common deck COMCMD (refer to appendix F).

The attributes of the lid are returned in the following format:

	59	4241	3029	2423	20	1817	109	0
addr	lid	attr	0	rfu	nw	rc	1	

lid User-specified lid.

attr lid attributes (zero if lid not found).

<u>Bit(s)</u>	<u>Description</u>
41	Set if host lid.
40	Set if linked lid.
39	Set if lid is enabled.
38	Set if prevalidation is required for lid.
37	Set if store and forward lid on host.
36	Set if store and forward lid on linked mainframe.
35	Set if loopback lid on host.
34-32	Reserved for CDC.
31-30	Reserved for installation.

rfu Reserved for CDC.

nw Network enabled flags.

<u>Bit(s)</u>	<u>Description</u>
20	Set if Scope 2 station is in service.
19	Set if Remote Host Facility is in service.
18	Set if Network Host Products is in service.

rc SFM response code (zero if normal termination).

GETMC

The GETMC macro allows the user program to obtain information about machine characteristics and the system environment. Common deck COMCCVL is required for absolute and relocatable assemblies.

Macro format:†

<u>Location</u>	<u>Operation</u>	<u>Variable</u>
	GETMC	addr

addr Address to receive machine characteristics.

The format of the RA+1 call for this function is:

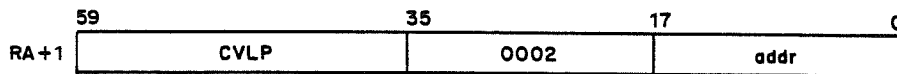

†This macro is not available in SYSTEXT. The user program must specify systems text PSSTEXT or call common deck COMCMAC (refer to appendix F).

The machine characteristics are returned in the following format.

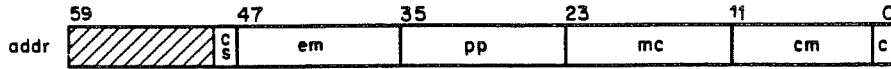

- cs If bit 48 is set, system is operating in 64-character set mode.
 If bit 48 is clear, system is operating in 63-character set mode.
- em Extended memory size/1000g.
- pp Number of PPs in system.
- mc Machine characteristics.

	<u>Bit(s)</u>	<u>Description</u>
	23-22	Unused.
	21	Set if extended memory is in ESM mode.
	20	Set if machine is a CYBER 180-class model or models 865 or 875.
	19-18	Nonzero if CPU is a model 176; zero if CPU is not a model 176.
	17	2x PP speed.
	16	Set if machine is CYBER 170, except CYBER 180-class models.
	15	Set if compare move unit (CMU) option is present.
	14	Always set to indicate that CEJ/MEJ instruction is available.
	13	Set if CPU0 has instruction stack.
	12	Set if CPU1 is present.
cm		Central memory size/200g (set to 3777g if central memory > 262K).
c		Completion bit (set when operation complete).

GETSSM

The GETSSM macro allows the user program to determine if the system is running in a secured mode.

Macro format:†

<u>Location</u>	<u>Operation</u>	<u>Variable</u>
	GETSSM	addr
addr		Address to receive system security mode.

†This macro is not available in SYSTEXT. The user program must specify systems text PSSTEXT or call common deck COMCMAC (refer to appendix F).

The system security mode is returned as follows:

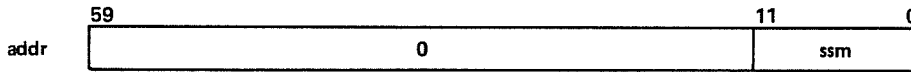

<u>ssm</u>	<u>Description</u>
0	If System is in unsecured mode.
1	If System is in secured mode.

MEMORY

The MEMORY macro enables you to determine or change the amount of central memory or extended memory associated with your job or determine the maximum amount of memory you can request.

Macro format:

<u>Location</u>	<u>Operation</u>	<u>Variable</u>
	MEMORY	type,stat,R,fl,na
type		CM or null for central memory; either is legal. ECS for extended memory.
stat		Status word address. May be omitted only if the fl parameter is specified and na is null.
R		Auto recall bit.
fl		Desired new field length which, if specified, overrides the stat word. If fl is specified, the MEMORY macro sets the upper 30 bits of the stat word to the value of fl. A negative value may not be used for fl. If the value of fl is greater than 3777778, the value must be passed to the MEMORY macro in an X register.
na		If null, the program is aborted if the request exceeds the current maximum which you are allowed. If this parameter is specified, the program is not aborted if the request exceeds the current maximum. Instead, the macro does not change the field length, and sets the stat word as defined below.

The format of stat word (if used) is:



- val Prior to the macro call, val is used to specify the desired new field length (words parameter can override this value). If val (or fl) is +0, then the current field length for the specified type is returned in this field. If bit 47 of val is set and specified type is CM, and memory reduction is honored even if no reduce has been selected (that is, no reduce override is in effect).† If val is -1, then the current maximum field length for the specified type is returned; if user ECS is disabled or not present, a value of zero is returned in val, regardless of any validated extended memory field length. If val (or fl) is greater than zero for the macro call, it contains the actual value assigned upon return. If val is -0 and type is extended memory, the field length is set to 0.
- rs These bits are reserved for system usage.
- c Completion bit. The system sets this bit when the request is complete.

If a request is given for an amount greater than the current maximum field length (refer to the NOS 2 Installation Handbook for a description of the current maximum field length) and if na is specified, then no field length change occurs and control is returned with val set to the current field length value.

If the reserved bits (rs) in the status word are used, the MEMORY request or a subsequent MEMORY request may be aborted.

The format of the RA+1 call for this function is:

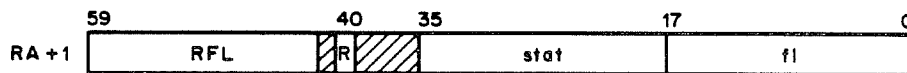

Alternate call format:††



MESSAGE

The MESSAGE function allows the user program to display a message on the system console display and enter it in a dayfile.

If the job is of system origin, including a dollar sign as the first character of the message and routing the message with option 2 causes the message to be flashed on the B display.

The maximum length of a message is 80 characters; up to 40 characters per line are displayed. The message ends with either the first word containing 12 bits of zeros in any byte or at the 80th character. Before issuing the MESSAGE function, the user program must pack the display coded message in sequential locations, beginning at location addr.

The format of the RA+1 call for this function is:

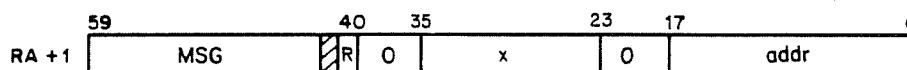

†Refer to the REDUCE (-) command in the CYBER Loader Version 1 Reference Manual.

††To maintain compatibility with NOS/BE.

Macro format:

<u>Location</u>	<u>Operation</u>	<u>Variable</u>
	MESSAGE	addr,x,R

addr Beginning address of the message. The beginning address of the message cannot be within five words of the end of the job's field length.

x Message routing option.

x=0	Message is placed in the system dayfile, the job dayfile, and job message buffer 1.
x=1	Message is placed in job message buffer 1.
x=2	Message is placed in job message buffer 2.
x=3	Message is placed in the job dayfile and displayed at line 1 of the control point.
x=4	Message is placed in the job dayfile.
x=5	Message is placed in the account dayfile.
x=6	Message is placed in the system dayfile, the job dayfile, and job message buffer 1.
x=7	Message is placed in the job dayfile and job message buffer 1.†

If x is not specified, x=0 is assumed. If x is not defined or is an incorrect positive value, x=1 is assumed. If x is a negative number, unpredictable results will occur. If x is the character string LOCAL, x=3 is used.

The job message buffers (1 and 2) allow you to display concurrently messages that enter the dayfile and those that require operator action. Message buffer 1 is normally used to display information about the current status of the executing program; for example:

SKIPPING lfn

COPYING lfn

ASSEMBLING TEST

·
·
·

Message buffer 2 is used by the system to issue error messages and warnings, and can be used by applications programs for the same purpose. Messages such as the following should be placed in message buffer 2:

BUFFER OVERFLOW, FILE lfn

FILE lfn NOT IN QUEUE

TIME LIMIT, REPRIEVE INITIATED

Message buffer 1 has a length of 50 characters (5 CM words); message buffer 2 has a length of 30 characters (3 CM words).

†Provided for compatibility with NOS/BE.

These message buffers are displayed at the system console and can be displayed by user jobs using the ENQUIRE command. If there are messages in both buffers, the message in message buffer 2 is displayed; the message in message buffer 1 is displayed only if message buffer 2 is empty (contains binary zero).

The contents of the job message buffer(s) are displayed when you enter the immediate job status command cE from an interactive terminal (refer to section 8 of Volume 3, System Commands), and when you enter the ENQUIRE,UJN or ENQUIRE,JSN=jsn command to determine the status of one of your jobs.

Only messages that are of interest to other than the job, such as the commands processed and compilers used, should be placed in the system dayfile (x=0). All messages of interest to the job, such as the path taken by the programs and the number of records copied, should be placed only in the job dayfile (x=3). All messages placed in the job dayfile (x=0 and x=3) are counted by the system. If the number of messages issued by the job exceeds the limit for which you are validated, the job aborts.

R Auto recall bit.

If the MSG RA+1 request is issued directly (not using the macro) and the upper 12 bits of the location specified by the message address are zero, then bits 47 through 30 of this location are assumed to contain the beginning address of the message. This indirect addressing method is not supported by the macro call and unpredictable results will occur if it is attempted.

MOVE

The MOVE macro moves a block of data from addr₁ to addr₂. This macro requires the common deck COMCMVE for absolute assemblies.

Macro format:

<u>Location</u>	<u>Operation</u>	<u>Variable</u>
	MOVE	count,addr ₁ ,addr ₂
count		Number of words in the block to be moved.
addr ₁		Address of the first word of the block to be moved.
addr ₂		Address of the first word of the destination.

MOVE allows overlap in data moves; that is, addr₂ can be less than addr₁ plus count.

NOTE

MOVE may access data from beyond the end of the source buffer. This could cause the program to abort if the last word address of the source buffer is within two words of the end of the program's field length.

RECALL

The RECALL macro enables the user program to relinquish the CPU until a function is completed or the CPU recall time has elapsed (delay time is set by the installation, usually 24 milliseconds). If the stat parameter is included in the call, control is not returned to the program until bit 0 of the word specified by stat is set. If stat is not included in the macro call, the program relinquishes the CPU until the delay time expires, or until a PP activity completes.

Macro format:

<u>Location</u>	<u>Operation</u>	<u>Variable</u>
	RECALL	stat

stat If this parameter is present, control is returned to the program when bit 0 of the word specified by the address stat is set. This is usually the address of a FET.

The format of the RA+1 call for this function is:

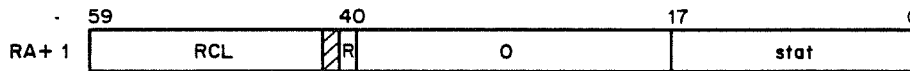

The auto recall bit, R, is set only if the stat parameter is specified.

SUBR

The SUBR macro enables the user program to distinguish between entering a subroutine and exiting from a subroutine even though control is transferred to the same address. Transfers to the subroutine are of the form:

RJ tag

Exits from the subroutine are of the form:

EQ tagX

Macro format:†

<u>Location</u>	<u>Operation</u>	<u>Variable</u>
tag	SUBR	

† This macro is not available in SYSTEXT. The user program must specify systems text PSSTEXT or call common deck COMCMAC (refer to appendix F).

SYSTEM

With the SYSTEM function, the user program can request the system to process any three-character request. Refer to Request Processors, section 1, for a list of request processors. A PP program can be called from a CPU program if the first character of the name is alphabetic. Documentation of these programs (refer to the DOCUMENT command in Volume 3, System Commands) should be consulted for the functions available (for example, LFM, CPM). These should be used when macros do not exist to issue the functions desired.

Macro format:

<u>Location</u>	<u>Operation</u>	<u>Variable</u>
	SYSTEM	req,R,p1,p2

req Three-character system request.

R Sets the auto recall bit for the request. If specified, control is returned only after the request is completed. If = is specified, no executable code is generated, but cross-references are made.

P1 Bits 17 through 0 of the request.

P2 Bits 35 through 18 of the request.

The format of the RA+1 call is:

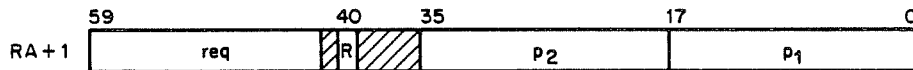

Example 1:

A CIO function request can be issued with the following SYSTEM request:

```
SYSTEM CIO,R,addr,n
```

where addr is the address of the FET for the file being read and n is the count for skip operations. If R is specified, the request is made with auto recall. When performing a CIO request in this manner, the user program must set the function code in FET+0.

Example 2:

The following shows the correct use of the = parameter:

```
SYSTEM XYZ,=
```

Routine XYZ will not actually be called, but the symbol XYZ will be created and KRONREF will recognize that this program calls XYZ.

WAIT

The WAIT macro enables the user program to relinquish the CPU and remain in recall until a specified CPU delay time has elapsed. The delay time can range from the system default recall time (10 milliseconds is the released default value) to 4095 milliseconds.

Macro format:

<u>Location</u>	<u>Operation</u>	<u>Variable</u>
	WAIT	delay

delay The maximum length of time in milliseconds that the job will remain in recall (if a value greater than 4095 is specified, the system uses the value 4095).†

The format of the RA+1 call for this function is:



†The user program may be recalled before the delay time has elapsed if high system activity exists.

USER FIELD LENGTH DUMP REQUESTS

The following requests enable you to transfer information residing in your job's field length to a file. Common deck COMCSYS is required for absolute assembly of these requests. These requests can not be made from a program in which the SETSSM macro has been executed, or from a program that was loaded from an execute-only file.

The SYSTEM macro is used to issue the user field length dump requests. Each type of request is identified by a three-character request code that appears as the first element in the variable field of the SYSTEM macro.

DUMP EXTENDED MEMORY (DEP)

This request dumps extended memory to file OUTPUT.† The format of the request is:

SYSTEM DEP,R,addr

R Auto recall bit.

addr The address of a parameter word with the following format.



fwa The address of the first word to be dumped. If this parameter is not specified, the dump begins with the first word of your job's extended memory.

lwa The address of the last word to be dumped. This parameter must be specified.

DUMP EXTENDED MEMORY WITH DISPLAY CODE (DED)

This request dumps extended memory to file OUTPUT. The dump contains display code equivalents to the right of the octal word representations. The format of the request is:

SYSTEM DED,R,addr

R Auto recall bit.

addr The address of a parameter word with the following format.

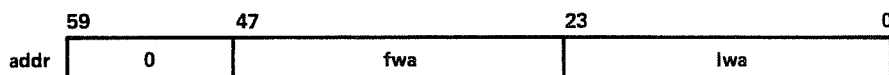

fwa The address of the first word to be dumped. If this parameter is not specified, the dump begins with the first word of your job's extended memory.

lwa The address of the last word to be dumped. This parameter must be specified.

†If the file OUTPUT is assigned to an interactive terminal, the dump is written to file ZZZDUMP instead of to OUTPUT.

BINARY DUMP OF CENTRAL MEMORY AND EXTENDED MEMORY (DMB)

This request creates a machine-readable binary dump file of your job's exchange package, central memory, and extended memory on file ZZZZDMB. File ZZZZDMB is not rewound before or after the dump; if ZZZZDMB is assigned to your terminal before the dump, the system returns it and creates a mass storage file ZZZZDMB. Each DMB request creates one logical record on ZZZZDMB. The format of the request is:

SYSTEM DMB,R,em,rn

- R Auto recall bit.
- em Determines whether the system dumps extended memory. If a nonzero integer is specified, the system dumps extended memory. If em is zero or omitted, the system dumps only the exchange package and central memory.
- rn Identifies the record name on file ZZZZDMB to which the dump will be written. rn is optional, but if it is specified it must be an octal value from 0 through 7777778. The system appends rn to the letter D to form a seven-character dump record name. If rn is greater than 3777778, the job aborts after the dump completes.

Each logical record of ZZZZDMB has the following format:

	59	53	47	35	17	0	
0	7700		0016		0		} prefix table
1	dump record name					0	
2	△	yy/mm/dd.					
3	△	hh/mm/ss.					
4	last system program called †						
5	0						
6	0						
7	0						
10	last system program called †						
11	image of last command executed ††					≈	
⋮							
⋮							
16							

†Word PGNR of the job communication area.

††Words CCDR of the job communication area.

	59		17	0	
	dump record name			0	
	59	53	47	17	0
0	ID		0		5
1	version				
2	version				
3	△	yy/mm/dd.			
4	△	hh/mm/ss.			
5	machine characteristics				
	59		47	17	0
0	XP		0		32 _g
1	exchange package				
20	A0 register				
21	A7 register				
30	RA				
31	RA+1				
32					
	59		47	17	0
0	CM		0		CM FL/100 _g
1	central memory				
n					
	59		41	17	0
0	ECS		0		EM FL/1000 _g
1	extended memory				
m					
	59		41		0
	END				0

ID table
 exchange package table
 central memory table
 extended memory table (appears only if extended memory is requested)

- n Octal number of central memory words assigned to the job.
- m Octal number of extended memory words assigned to the job.
- △ Space (display code value 55_g).

If an extended memory error occurs, the block in error will be filled with 400_g words of the following format.

59		11	0
ECSERROR		nnnn	

nnnn Word number of the block in error (starting with 1).

DUMP CENTRAL MEMORY (DMP)

This request dumps central memory of your job's exchange package to file OUTPUT. (If the file OUTPUT is assigned to the terminal, the dump is written to file ZZZDUMP instead of to OUTPUT.) The format of the request is as follows:

```
SYSTEM DMP,R,lwa,fwa
```

R	Auto recall bit.
lwa	The address of the last word to be dumped. This parameter must be specified if fwa is specified.
fwa	The address of the first word to be dumped. If this parameter is not specified but lwa is specified, the dump begins with the first word of your job's central memory.

If neither fwa nor lwa is specified, the dump includes the exchange package and 40g central memory locations before and after the program address in the exchange package. If either fwa or lwa is nonnumeric, the request is processed as if neither parameter had been specified.

DUMP CENTRAL MEMORY WITH DISPLAY CODE (DMD)

This request dumps your job's central memory or exchange package to file OUTPUT. (If the file OUTPUT is assigned to the terminal, the dump is written to file ZZZDUMP instead of the OUTPUT.) The dump contains display code equivalents to the right of the octal word representations. The format of the request is as follows:

```
SYSTEM DMD,R,lwa,fwa
```

R	Auto recall bit.
lwa	The address of the last word to be dumped. This parameter must be specified if fwa is specified.
fwa	The address of the first word to be dumped. If this parameter is not specified but lwa is specified, the dump begins with the first word of your job's central memory.

If neither fwa nor lwa is specified, the dump includes the exchange package and 40g central memory locations before and after the program address in the exchange package. If either fwa or lwa is nonnumeric, the request is processed as if neither parameter had been specified.

QUEUE FILE MANAGER

Queue file manager (QFM) performs functions associated with queue and dayfile protection. The majority of the QFM functions are for special system jobs. These functions are not discussed in this manual (refer to the NOS Version 2 Systems Programmer's Instant) since they are not available to the applications programmer. Functions available to the applications user allow a job to be rerun in the event of a system interrupt or hardware failure.

The format of the call to QFM is:

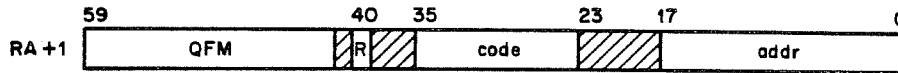

R Auto recall bit.
code Function code.
addr Address of the request.

RERUN (015)

The RERUN macro sets the job rerun status, indicating that the job may be rerun in the event of system failure. All noninteractive jobs are initially given rerun status. The RERUN macro has no effect if used from an interactive job.

Macro format: †

<u>Location</u>	<u>Operation</u>	<u>Variable</u>
	RERUN	

NORERUN (016)

The NORERUN macro clears the job rerun status (initially enabled) and prevents a job from being rerun. With this macro the user program can specify when a job may be safely rerun. For example, if a job has just updated a critical data base, it is probably desirable not to rerun the job. The user program can use the NORERUN macro to prevent this. This macro affects noninteractive jobs only. The NORERUN macro has no effect if used from an interactive job.

Macro format: †

<u>Location</u>	<u>Operation</u>	<u>Variable</u>
	NORERUN	

LOADER REQUESTS

The system provides routines to aid you in loading overlays or capsules at specific points during program execution. The overlays or capsules can reside on files attached to your job or in system libraries.

†This macro is not available in SYSTEXT. The user program must specify systems text PSSTEXT or call common deck COMCMAC (refer to appendix F).

OVERLAY

The OVERLAY macro processes a system request to the LDR processor. LDR provides the ability to load overlays to specified areas of the user program area. Depending on the parameters specified and the level of the overlay, control may or may not be returned to the calling program.

The format of the RA+1 call for this function is:†



R Auto recall bit.

addr Address of the request.

The load request consists of two to four words. The two- to four-word block must be defined by the user program for RA+1 calls, but is defined by the system when called from the OVERLAY macro (only two words used).

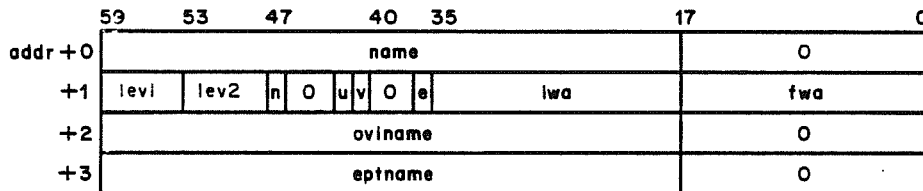

name Source of name depending on the u and n options.

lev1 First overlay level.

lev2 Second overlay level.

n Number of words in request-2 (bits 47-46).

u Load option (bit 42).

v Overlay flag (must be set to 1) (bit 41).

e Call completion flag (bit 36).

lwa Last word address available for load.

fwa The address at which the overlay is to be loaded.

ovlname Name of overlay to be loaded (if n_≥1 and u=1).

eptname Entry point name when loading multiple entry point overlay (if n=2 and u=1).

†LDV is processed by the system as the LDR call. This is to provide compatibility with the common product set.

The operation performed depends on the value of u, n, fwa, lev1, and lev2.

1. If u=0, n is ignored and name is the name of the file containing the overlay (lev1 and lev2 are required).
2. If u=1 and n=0, name is the name of an entry point in an overlay from the system library† (lev1 and lev2 are ignored unless the main program was loaded from a global library).
3. If u=1 and n≠0, ovname is the name of the overlay from the system library† (lev1 and lev2 are ignored).
4. If u=1 and n=2, eptname is the name of an entry point in an overlay from the system library† (lev1 and lev2 are ignored).
5. If fwa=0, the overlay is loaded at the address specified by the overlay. Otherwise the overlay is loaded at fwa.
6. If lev1=lev2=0, the (0, 0 overlay) control is transferred to the called overlay. Otherwise, control is returned to the caller with fwa replaced by the entry point address of the overlay.
7. If e=1, control transfers to the specified entry point, eptname, in the overlay.

Upon completion of the load, the following information is returned to the four-word block beginning at location addr:

	59	53	47	17	0
addr+0	name			0	
+1	lev1	lev2	0	eptaddr	
+2	ovname			0	
+3	eptname			0	

eptaddr Entry point address of the overlay. If n=2, eptaddr is the address of eptname.

Macro format:

<u>Location</u>	<u>Operation</u>	<u>Variable</u>
	OVERLAY	nam,lev,SYSTEM,fwa
nam	Address of file name in L format (display code, left-justified).	
lev	Level of overlay. If not specified, level 0,0 is assumed and control is automatically transferred to transfer address encountered on overlay load (usually specified on IDENT pseudoinstruction of ABS programs). For overlay level (i,j), level is defined as: lev=i*100g+j.	
SYSTEM	If SYSTEM is specified, file is loaded from system library and nam is name of overlay desired.	
fwa	If this parameter is specified, fwa is the address where the overlay is to be loaded. The file is loaded at the address specified on the overlay if this parameter is not specified.	

Common decks required are COMCOVL and COMCSYS.

†The overlay is loaded from a user global library set file if the main program was loaded from a user global library set file.

After the macro is processed, X1 contains the address of the entry in the overlay.

Example 1:

```

                                .
                                .
                                .
                            OVERLAY TEST
                                .
                                .
TEST          CON      4LTEST

```

This sequence of code loads overlay (0,0) from file name TEST and begins execution at the entry address specified by TEST.

Example 2:

```

                                .
                                .
                                .
                            OVERLAY A,0100B,S,LDA
                            SB2    X1
                            JP      B2
                                .
                                .
A              CON      5LARITH
                                .
                                .
LDA           EQU      *

```

This sequence of code loads the ARITH routine from the system, level (1,0) library at address LDA and transfers control to the routine.

If the request calls for the overlay to be loaded and executed and no fwa load address is specified in the request, the entry point address specified in the load table is used as the entry point address. If an fwa load address is specified in the request, bias the entry point address from the load table with the difference of the fwa load address specified by the request and the fwa load address specified by the load table; that is:

$$\text{Entry point address} = (\text{entry point address from load table}) + (\text{fwa load address specified in the request}) - (\text{fwa load address from load table})$$

If the request requires just an overlay load, the entry point address returned is the entry point address in the load table.

NOTE

Overlay loads from an execute-only file are always allowed in the case of a (0,0) overlay. For any other overlay, a load from an execute-only file is only allowed if the original (0,0) overlay was loaded from the same file.

LOADD

The LOADD macro allows the user program to locate procedures or fast dynamic load (FDL) capsules and have pertinent information returned to a specified address. Fast dynamic loading is a method of loading preprocessed binary routines.

The format of the RA+1 call for this function is:

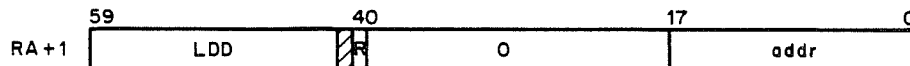

R Auto recall bit.

addr Address of parameter block.

The parameter block consists of two words in the following format.

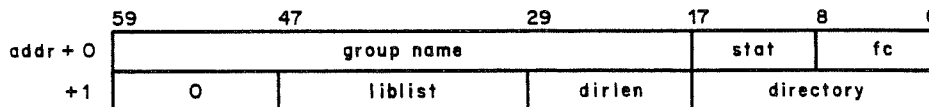

group name Name of the group of capsules or procedures for which a directory is requested.

stat Status of call (ignored during request). Upon completion of call, stat is set to one of the following values.

<u>Value</u>	<u>Description</u>
0	Function completion without error.
1	Illegal function code.
2	Bad directory address or length (address plus length must be less than or equal to field length).
3	Bad liblist address or length.

The following errors may be combined with those preceding:

10g	An entry in the library list did not correspond to any known local or system library name, or an entry specified the name of file which was not a mass storage library.
20g	The specified directory space was not large enough to contain the entire directory.

fc Function code. LDD sets bit 0 to one when the request is complete:

0	Specifies capsule (record type CAP).
404g	Specifies procedure (record type PROC).

liblist Address of a list of libraries to be searched after the global library set. Zero if no set is specified.

dirlen Length, in central memory words, of the area to receive the generated directory. Upon completion of the call, it is set to the actual length that was needed for the complete directory (may be less than or equal to the value of the original call).

directory Address of the area to receive the generated directory.

When called, LDD searches first the global library set (refer to the CYBER Loader Version 1 Reference Manual for a description of global library sets) and then the library set specified in the call. If a library file is found to contain one or more capsules belonging to the given group or the specified procedure, an entry is made in the directory. This entry is one of two different forms, depending on whether the library is a system library or a local file library. For a procedure, LDD searches the central library directory (CLD) if the specified procedure is not found elsewhere.

For a local file library the format is:

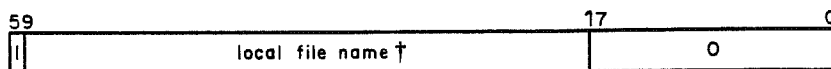

For a system library the format is:



libord The library ordinal of the library containing the capsule.

For each capsule or procedure found that belongs to the given group, LDD makes the following entry in the directory.

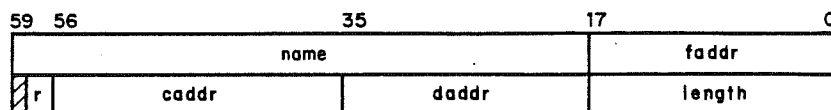

faddr Address, relative to the beginning of the directory, of the word containing the file entry associated with this capsule or procedure.

r Residence of capsule or procedure:

- 0 Mass storage.
- 1 Mass storage and CM.
- 2 Mass storage and extended memory.

†The first character of the local file name must not be numeric.

caddr CM or extended memory address of capsule or procedure.
daddr Disk address (relative PRU) of capsule or procedure.
length Length of the capsule or procedure, including header, code image, and
 relocation and linking information, but excluding the prefix table.

Macro format:†

<u>Location</u>	<u>Operation</u>	<u>Variable</u>
	LOADD	addr,R

addr Address of parameter block.

R Auto recall bit.

LOADQ

The LOADQ macro loads fast dynamic load (FDL) capsules from specified files.

The format of the RA+1 call for this function is:



R Auto recall bit.

addr Address of parameter block.

The four-word parameter block must be defined as follows:

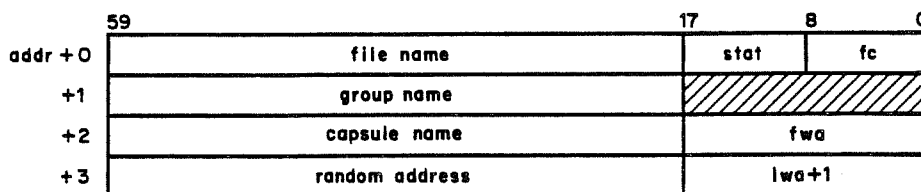

†This macro is not available in SYSTEXT. The user program must specify systems text PSSTEXT or call common deck COMCMAC (refer to appendix F).

file name Name of file containing capsule.

stat Status of LDQ call (ignored during request). Upon completion of call, stat is set to one of the following values.

<u>Value</u>	<u>Description</u>
0	Function completion without error.
1	Illegal function code.
2	Bad address (must have fwa<lwa+1<field length).
3	Nonexistent file or file not on mass storage.
4	Bad disk address (out of file bounds).
5	Capsule not found at specified location.
6	Insufficient space provided for capsule.

If either error 5 or 6 occurs, the contents of the loadable area are undefined.

fc Function code:

0 Load capsule.

LDQ sets bit zero to one when the request is complete.

group name Name of capsule group.

capsule name Name of desired capsule.

fwa First word address of the area into which the capsule is to be read.

random
address Location of capsule on specified file.

lwa+1 Last word address plus 1 of area for capsule.

LDQ reads a capsule from the specified mass storage location, removing the prefix table, but not altering the record otherwise. LDQ ensures that the location contains a capsule (60 table). LDQ also determines that the entire capsule fits into the specified area and that the name is correct.

Macro format: †

<u>Location</u>	<u>Operation</u>	<u>Variable</u>
	LOADQ	addr,R
addr	Address of parameter block.	
R	Auto recall.	

MEMORY ALLOCATION FOR OVERLAY LOADERS

The overlay loaders load records into central memory. If a record begins with an overlay table (50g-, 51g-, and 53g-identification word), it is loaded according to the relative address given in the table (figure 11-1). The beginning load address must be greater than 110g. For a 50g single entry point overlay, loading starts at origin minus one; for a 51g multiple entry point overlay, loading starts at origin minus wc minus one, where wc is the number of entry points.

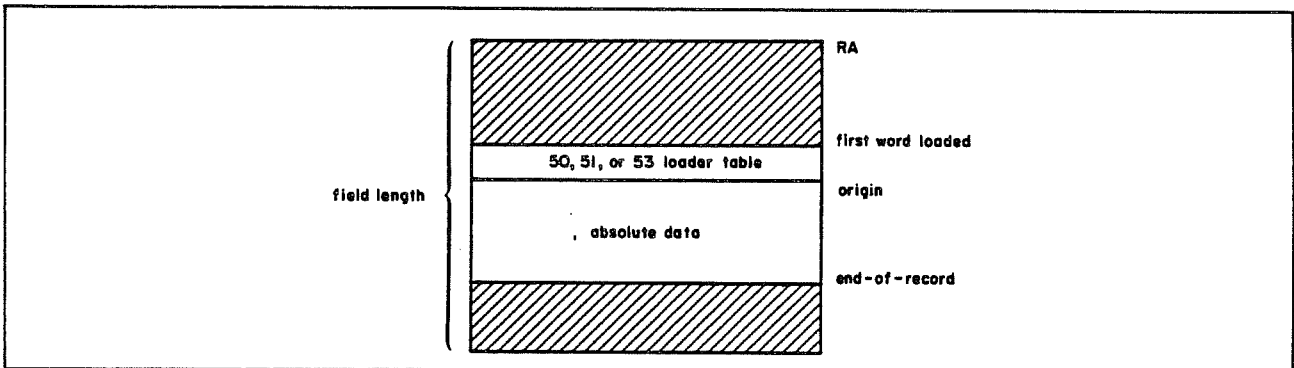

Figure 11-1. Absolute Loader Memory Assignment

† This macro is not available in SYSTEXT. The user program must specify systems text PSSTEXT or call common deck COMCMAC (refer to appendix F).

INTERACTIVE TERMINAL REQUESTS

The following requests perform functions associated with control of your interactive terminal. The calling format is shown for each macro.

NOTE

The macros described in this section are intended for use by interactive origin jobs only. The use of these macros by other job origins will be ignored.

DISTC MACRO †

The DISTC macro enables an interactive program to prevent IAF from processing terminal control keys and commands.

Capabilities similar to those provided by DISTC are available via reprieve processing (refer to Reprieve Processing, section 10). Because reprieve processing provides extended features, it should be used instead of DISTC.

Macro format: ††

<u>Location</u>	<u>Operation</u>	<u>Variable</u>
	DISTC	st, addr, INT
st	Control status:	
	ON	Activates program terminal control.
	OFF	Deactivates program terminal control.
addr	Specifies an interrupt address which the system uses to inform the program that a terminal operator attempted to interrupt or terminate the program. This parameter is valid only if st=ON. If addr is not specified, the program is not notified of attempted terminal control.	
INT	If INT is specified when terminal control is attempted, the system copies the program operating registers (exchange package)††† to the 20g-word area starting at addr. The program address is changed to addr+20g (that is, execution continues at addr+20g). If INT is not specified, the contents of addr are determined by the type of user break attempted: if user break 1, the contents of addr are set to 1. If user break 2, the contents of addr are set to 2. The program can check the location periodically to determine if the terminal operator has attempted to interrupt or terminate the program.	

† This macro will be deleted in a future version of NOS. Extended reprieve processing (refer to the REPRIEVE macro in section 10) should be used instead of DISTC.

†† This macro is not available in SYSTEXT. The user program must specify systems text PSSTEXT or call common deck COMQMAC (refer to appendix F).

††† A system request, XJR, allows the user program to restore the operating registers and resume normal processing after the interrupt processing has been completed.

The interrupt address remains the same after the program is notified of an attempted interrupt. Once a terminal control is set or cleared, that status remains in effect until:

- The program issues a DISTC macro that changes the status.
- The program terminates, which returns the terminal to command mode.
- You log off or disconnect the terminal. If the terminal was disconnected, you may recover. If the executing program is continued after recovery, the terminal control status remains as it was prior to the disconnect. If the executing program is not continued, the interrupt address is cleared.

The following is a list of terminal control sequences and their effect when you select the disable terminal control feature (the $\text{\textcircled{CR}}$ denotes the message terminator key).

<u>Phase</u>	<u>Sequence</u> †	<u>Effect</u>
Waiting for input	CTRL/T $\text{\textcircled{CR}}$ or CTRL/P $\text{\textcircled{CR}}$	You may enter this sequence at the beginning of any input line unless transparent input mode has been selected. If an interrupt address was specified, the program is notified of attempted control.
Generating output	BREAK CTRL/T $\text{\textcircled{CR}}$ or BREAK CTRL/P $\text{\textcircled{CR}}$	If an interrupt address was specified, the program is notified of attempted control. When the BREAK key is pressed, output is suspended. However, unless CTRL/T $\text{\textcircled{CR}}$ or CTRL/P $\text{\textcircled{CR}}$ is entered next, the program is not notified of an attempted terminal control. If any other sequence is entered, or if just a $\text{\textcircled{CR}}$ is entered, the program is not notified of terminal control and the output operation continues.
Executing	CTRL/T $\text{\textcircled{CR}}$ or CTRL/P $\text{\textcircled{CR}}$	If an interrupt address was specified, the program is notified of attempted control.

NOTE

An error will occur if a DISTC macro is issued while REPRIEVE processing is in effect (REPRIEVE processing is described in section 10 of this manual). The DISTC macro will be ignored if it is issued while EREXIT processing is in effect (EREXIT processing is described in section 6 of this manual).

†The termination (sometimes referred to as user break 2) sequence (that is, CTRL/T $\text{\textcircled{CR}}$) and interruption (sometimes referred to as user break 1) sequence (that is, CTRL/P $\text{\textcircled{CR}}$) may vary for different terminals. Refer to Volume 3, System Commands, for further information.

CSET MACRO

The CSET macro sets the initial and current character set mode of the terminal to either ASCII or NORMAL.

Macro format:†

<u>Location</u>	<u>Operation</u>	<u>Variable</u>
	CSET	mode,C
mode	ASCII	Set ASCII 128-character set mode.
	NORMAL	Set ASCII graphic 63/64-character set mode.
	RESTORE	Set current terminal character mode to initial terminal character mode.
C		Change initial and current terminal character mode to that specified; if C is omitted, only the current mode is changed.

NOTE

The use of this macro may cause the character mode of the terminal to switch prior to the printing of all previous output. This can be prevented by preceding the macro call with an input request with recall or with a rollout request, or by flushing the output buffer with a WRITER or WRITEF request.

PROMPT MACRO

The PROMPT macro enables or disables the issuing of the terminal input prompt (a question mark). The input prompt is turned on at the beginning of each job step.

Macro format:†

<u>Location</u>	<u>Operation</u>	<u>Variable</u>
	PROMPT	mode
mode		Input prompt mode desired:
	ON	Terminal input is requested with a question mark.
	OFF	No terminal input prompt is issued.

†This macro is not available in SYSTEXT. The user program must specify systems text PSSTEXT or call common deck COMCMAC (refer to appendix F).

SETSLSM MACRO

The SETSLM macro returns or sets the display mode of the interactive terminal associated with a job.

Macro format:†

<u>Location</u>	<u>Operation</u>	<u>Variable</u>
	SETSLSM	addr,W
addr		Address of parameter word.
W		If present, the terminal's display mode is set according to the values specified in the parameter word. If omitted, the terminal's current display mode is returned to the parameter word.

NOTE

Using the SETSLM macro to set the display mode of the interactive terminal may produce unpredictable results when NOS full screen products are used. Use the SCREEN or LINE command to set the display mode.

Parameter word format:

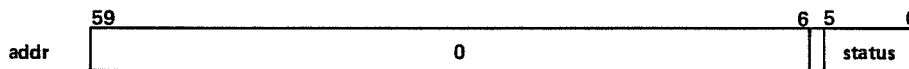

status Terminal display mode status.

<u>Bit(s)</u>	<u>Description</u>
0-5	Terminal model ordinal.

<u>Ordinal</u>	<u>Mnemonic††</u>	<u>Terminal Type</u>
0	None	Any terminal that does not support screen mode.
1	User	User-defined terminal.
2	721	CDC 721.

†This macro is not available in SYSTEXT. The user program must specify systems text PSSTEXT or call common deck COMCMAC.

††These mnemonics and their corresponding ordinals are defined in common deck COMCGTO.

Bit(s) Description

6 Terminal display mode.

<u>Value</u>	<u>Description</u>
1	Screen mode.
0	Line mode.

TSTATUS MACRO

The TSTATUS macro returns the status of the terminal. Information returned includes terminal type, the interactive subsystem being used, the terminal number, character set information, parity, whether the format effector mode is set to USER or SYSTEM, duplex and tape mode status, and the current interrupt address. If the connection status is not on-line, the only valid field is cs. All other fields are zero except the tid field which is set to blanks.

Macro format:†

<u>Location</u>	<u>Operation</u>	<u>Variable</u>
	TSTATUS	addr
addr		Address of two-word status block.

Status block format:

	59	56	53	47	43	35		17	11	0	
addr + 0	tid						sys	tn			
+ 1	0	nwk	cs	0	tc	int	tran	st			

tid Left-justified, blank-filled display code terminal type identification:

<u>Type</u>	<u>Description</u>
NAMIAF	Network terminal.
TPM	Two-port multiplexor terminal.
TTY	Stimulation or multiplexor terminal.
blank	Terminal is not on-line.

sys Subsystem ordinal:

<u>Ordinal</u>	<u>Description</u>
0	Null subsystem.
1	BASIC subsystem.
2	FORTRAN subsystem.
3	FTNITS subsystem.
4	Execute subsystem.
5	Batch subsystem.
6	Access subsystem.

tn Terminal number (octal).

† This macro is not available in SYSTEXT. The user program must specify systems text PSSTEXT or call common deck COMCMAC (refer to appendix F).

nwk Type of network:

<u>Value</u>	<u>Description</u>
0	Job not connected to NAM.
1	Job connected to NAM/CCP.
2	Job connected to NAM/CDCNET.

cs Connection status:

<u>Value (octal)</u>	<u>Description</u>
0	Not interactive.
1	Detached.
2	On-line.
3-13	Reserved for CDC.
14-17	Reserved for installation.

tc Terminal class:

<u>Class (octal)</u>	<u>Description</u>
1	M33, M35, M37, or M38 TTY
2	CDC 713-10, 722, 751-1, 752, 756
3	CDC 721, 722-30
4	IBM† 2741
5	M40 TTY
6	Hazeltine 2000
7	DEC† VT100, Televideo 924, 950, 955
10	Tektronix 4010, 4014
11	HASP Protocol (postprint format control)
12	200 User Terminal
13	CDC 714-30
14	CDC 711-10
15	CDC 714-10/20
16	HASP Protocol (preprint format control)
17	CDC 731-12, 732-12, 734
20	IBM 2780
21	IBM 3780
22	IBM 3270

int Current interrupt address if specified on DISTC macro; if INT is also specified on the DISTC macro, bit 35 is set.

tran Transmission code:

<u>Code</u>	<u>Description</u>
3	Interactive terminal (only code returned).

†DEC is a registered trademark of the Digital Equipment Corporation. IBM is a registered trademark of International Business Machines.

st Terminal status bits:

<u>Bit</u>	<u>Description</u>
0	Parity (Odd if set).
1	Initial character set (ASCII if set).
2	Current character set (ASCII if set).
3	Full duplex.
4	Tape mode.
5	Brief mode.
6	User format effector mode.
7-11	Reserved.

EFFECT MACRO

The EFFECT macro allows the user program to control the formatting of terminal output. Terminal output is normally controlled by IAF. When the mode is set to USER, the user program must supply all formatting for terminal output.

Control bytes 0001, 0002, 0003, 0005, 0010, 0013, 0014, 0015, and 0016 should not be used while the mode is set to USER. Use of these bytes may result in loss of control over the carriage. This macro affects only terminals connected to the system by way of NAM.

Macro format:

<u>Location</u>	<u>Operation</u>	<u>Variable</u>
	EFFECT	mode
mode	SYSTEM	IAF controls all formatting of terminal output.
	USER	User program controls all formatting of terminal output.
	omitted	IAF controls all formatting of terminal output.

NOTE

Only preprocess format effectors are supported in USER effect mode. The slant and period are not supported in this mode. For a list of format effectors and a discussion of the effects on a specific terminal class, refer to the NAM Version 1/CCP Version 3 Terminal Interfaces Reference Manual.

The ? prompt, normally supplied by the system to request input, is not displayed when format effectors are user-supplied.

WRITING PROGRAMS UNDER NOS

Listings of programs that use the macros and common decks described in this manual can serve as an aid to understanding many of the features described in this manual. For example, to obtain a listing of the COPYC program, enter the following commands after accessing the system OPL.†

```
MODIFY,LO=E,Z./*EDIT,COPYC
COMPASS,I,L=list,S=NOSTEXT,B=0.
ROUTE,list,DC=LP.
```

If you follow the documentation standards described in appendix I, you can use the documentation utilities to document your program. These specifications are supplied as a guide to enable you to understand the format of system programs and to give you an idea of how to structure programs.

You should organize the program area, buffers, and working storage areas in a manner that uses the least amount of memory for the shortest period of time. This provides better performance and more efficient use of system resources. Areas of code that are used once, such as preset routines, should be overlaid with buffers that are used later in the program. All main programs should be set to load past location 110g since areas before this address contain program and system parameters.†† If a program has several entry points, the origin should be higher. Placing FETs, table pointers, and other critical data areas at the beginning of the program aids in debugging because these areas do not change addresses as code in the program is changed.

PARAMETER PROCESSING

When a program is initiated, the command parameters are stored in the job communication area (refer to figure E-1) beginning at ARGR (RA+2) through RA+n (n cannot exceed 63g). These parameters are terminated by a zero word. The number of parameters stored in the job communication area is placed in the lower 18 bits of ACTR (RA+64g). The name of the command is placed in bits 59 through 18 of PGNR (RA+64g). The parameters are stored in either operating system or product set format. The command image, less any label or prefix field, is stored beginning at CCCR (RA+70g).

If the parameters are stored in operating system format, the comma, period, and right parenthesis are stored as zero. For all parameters and valid separators except the comma, their display code equivalent is stored.

† Your site must control access to the system OPL as required by the site's licensing agreement. Contact your site analyst to obtain the procedure for gaining access to the system OPL.

†† Refer to appendix E.

If the parameters are stored in product set format, separators and terminators are stored as follows:

<u>Character</u>	<u>Code (Octal)</u>
,	1
=	2
/	3
(4
+	5
-	6
;	10
) or .	17
Others	16

Parameters for user programs are normally stored in product set format. You can force operating system format in either of two ways:

- Prefix the command with a slash (/).
- For programs loaded from a global library set, include an NPC= entry point in the program.

Example:

When a program is loaded from a local file with the following command:

```
TEST,A=B,C=D,E,F.
```

the command parameters are stored in product set format and the contents of central memory are as follows:

ARGR	RA+2	0100	0000	0000	0000	0002	A	B
	+3	0200	0000	0000	0000	0001	B	A
	+4	0300	0000	0000	0000	0002	C	B
	+5	0400	0000	0000	0000	0001	D	A
	+6	0500	0000	0000	0000	0001	E	A
	+7	0600	0000	0000	0000	0017	F	0
	+10	0000	0000	0000	0000	0000		
	.							
	.							
	.							
CCDR	RA+70	2405	2324	5601	5402	5603	TEST,A=B,C	
	RA+71	5404	5605	5606	5700	0000	=D,E,F.	

If the command is changed to:

/TEST,A=B,C=D,E,F.

the command parameters are stored in operating system format and the contents of locations RA+2 through RA+10g appear as follows:

ARGR	RA+2	0100	0000	0000	0000	0054	A	=
	+3	0200	0000	0000	0000	0000	B	
	+4	0300	0000	0000	0000	0054	C	=
	+5	0400	0000	0000	0000	0000	D	
	+6	0500	0000	0000	0000	0000	E	
	+7	0600	0000	0000	0000	0000	F	
	+10	0000	0000	0000	0000	0000		

NOTE

If you are using the common deck COMCARG (refer to appendix F) for argument processing, you do not need to be concerned with the different formats, since COMCARG processes both formats correctly.

If the program with an ARG= entry point in its entry point list is loaded from a global library set, no command parameters are checked and no parameter list is stored.

SPECIAL ENTRY POINTS

Absolute programs loaded from global library sets may contain entry points to perform special functions. Special entry points are specified by the COMPASS pseudo instruction ENTRY. As shown below, they typically follow the normal entry points.

```
IDENT EXAMPLE,FWS
ABS
ENTRY A
ENTRY B
ENTRY NPC=
SYSCOM B1
.
.
.
```

The following entry points are special entry points:

ARG= Programs which do their own processing of command parameters may use this entry point. The parameters are not stored in ARGR (RA+2) as would normally occur, but rather the command image is passed in CCDR (RA+70₈). In addition to the parameters, the command image includes the program name and any prefix options (such as \$ or /).

This allows commands to contain parameters that do not conform to the normal constraints of NOS command syntax. The program name must be recognizable, that is, it must follow the same rules as a NOS file name and end with the separator

+ - " / = , (

or any other character with a display code value greater than 44₈ except

*) \$.

and blank.

MFL= Use this entry point in a program to specify the minimum field length required for execution. This entry point differs from RFL= in that the RFL= always changes the running field length to the specified value.

When a program with an MFL= entry point is executed, it determines the running field length as follows:

If MFL= is greater than 200000₈, the running field length is set to the greater of:

- The field length specified on the JOB command (byte 1, word FLCW of the control point area)
- The value of MFL= minus 200000

If MFL= is less than 200000₈, the running field length is set to the greater of:

- The current running field length
- The value of MFL=

NPC= This special entry point causes the parameter list to be stored in NOS format, not product set format. (Refer to Parameter Processing earlier in this section.)

RFL= The system uses the value of this entry point as the running field length (amount of central memory) for the job.

SDM= Use this entry point in a program if you wish to suppress the dayfile message issued by the system and issue your own dayfile messages. The system will then not issue a dayfile message of the command image when the program is executed. It is your responsibility to issue any desired dayfile messages.

An example of SDM= usage would be a command with privileged information. The program could issue a dayfile message with this information removed, and thus the dayfile would yet contain evidence of the command being executed but not the privileged information.

WRITING INTERACTIVE PROGRAMS

You may choose to write interactive programs in languages other than those oriented specifically to the terminal (for example, COMPASS). You can also convert some batch application programs to interactive programs. The following description of system conventions acquaints the user with potential problem areas in performing this conversion or in writing interactive programs.

CONVERSION PROBLEMS

The major difference between an interactive job and a batch job is in the handling of files assigned to a terminal. Since the system is designed with a common control interface to all types of equipment, the applications programmer need not be concerned about the specific piece of equipment with which the program is communicating.

Certain problems arise when application programs not written with terminal interaction in mind are converted to interactive programs. These problems are:

- Each line of terminal input is considered a logical record. This causes two basic problems.
 - First, any program that terminates input processing on an EOR processes only one line of input.
 - Second, programs that read ahead on input place a special significance on an EOR, and therefore cannot effectively interact while accepting these one-line records. This problem is minimized by the design of NOS input/output. However, when the problem does occur, it is fatal to program execution.
- Many programs output more than 72 characters per line. This may result in unacceptable output; however, this is easily corrected by using the L072 command or by reformatting the output in the program.
- Many programs perform unnecessary write requests on output. This can cause high system overhead.

Portions of the NOS standard product set are modified to correct these problems.

DEFAULT FILE ASSIGNMENTS AND SPECIAL FILE TREATMENT

All jobs interacting with your terminal have the INPUT and OUTPUT files assigned to the terminal unless you or a program assigns them to a different device. You can assign a file to the terminal by assigning a file to equipment TT using the ASSIGN command; you can assign the INPUT or OUTPUT file to mass storage by specifying a device type of MS on the ASSIGN command. A user program can make similar assignments with the REQUEST macro.

Normally, an interactive program need not check for EOI on INPUT; however, you must ensure that INPUT is checked for EOI file status if INPUT might be assigned to mass storage.

SPECIAL HANDLING

When a program makes a read request with recall on a terminal input file, the circular buffer of a terminal file can be automatically flushed (as if an EOR write had been performed) before the system issues the read request.

A program can use one of the following methods to ensure that output data is sent to the terminal in this way.

- The program can specify a list of files (refer to the SETLOF macro, section 6) from which the system determines the appropriate file name. This is the preferred method.
- The program can store FET pointers, which specify the files to be flushed, in RA+2 through RA+63₈. The FET pointer is the file name left-justified with zero-fill in bits 59 through 18 and the address of the FET in bits 17 through 0.

In using the first method, the system checks only the first file in the list. This file must meet the following criteria.

- The file must either be assigned to the terminal (device type equals TT in the FET) or, if unassigned, must be named OUTPUT.
- The file must meet the conditions described under the flush bit (refer to description of the flush bit, FET description, in section 2).

In using the second method, the system uses the first file that meets the preceding criteria.

OTHER SPECIAL HANDLING

The following additional considerations apply to the execution of interactive programs.

- An EOR or EOF write on a terminal file has no special significance except that it ensures that the buffer is dumped to the terminal.
- When terminal input data is passed to an executing program, the following convention is followed.

If the input data consists of data followed by a carriage return, the system supplies an EOR level of one (level number is in bits 17 through 14 of FET+0). If there is no data input but only a carriage return, the system supplies an EOF. The EOF will have an EOR level of 0; the FET status field will be 000031.

A program can process input from a terminal properly by sensing an EOR level of 1. The system input/output macros and common decks (except the READO macro) are coded to handle this case properly. Most of the system utilities interact with a terminal in this manner.

Input from a terminal is handled in the same manner as the CIO READSKP request. If the program's buffer is not large enough to accommodate a full line of input, the data is truncated and the excess is lost. No error code is returned.

- A program that is interacting with a terminal should not do a recall on a file assigned to a terminal if it does an EOR or EOF write on the file to clear the buffer (do not specify the r option on WRITER or WRITEF macros). If recall is specified, an extra rollout of the program may be required before the program terminates. If the conventions mentioned earlier concerning the status of output are followed, it is not mandatory to write an EOR or EOF to clear the buffer; however, if it is done without auto recall (to remain compatible for batch use, for example) as the last operation before the ENDRUN macro, little additional system overhead is incurred.
- If the conventions for special handling are followed, a job being rolled out by the system has all completed lines of data in the output buffer sent to the terminal.
- If a program aborts because an error occurs, the contents of the first message buffer of the control point area are sent to the terminal as part of the output. Messages can be placed in this area using the MESSAGE macro. Messages longer than 48 characters are truncated to 48 characters. If you are in the batch subsystem, this message buffer is always sent to your terminal at the end of each job step, except for job steps that are within a procedure file.
- If a buffer argument error is detected on an output buffer when output is being issued automatically, the output is ignored and the FET is not acted on. This error usually indicates that the executing program has destroyed part of its own field length.
- A COMPASS program can determine whether it is interacting with a terminal input or output file by checking the type of equipment to which the file was assigned (byte zero of FET+1). Refer to the common deck COMCSTF, appendix F.

PROGRAM CONTROL OF TERMINAL ACTIVITY

The remainder of this section describes methods of controlling terminal activity when connected to the Interactive Facility (IAF).

You can control terminal activity in the following ways.

- Include control bytes in your program output to control the positioning of the printing element and define alternate input modes.
- Enter various characters or sequences of characters to control program execution.
- Issue a REPRIEVE macro (refer to section 10) to disable the terminal operator's control of the user program during various phases of execution.
- Issue a CSET macro to change the character set of the terminal.
- Issue a PROMPT macro to control the issuing of the input prompt.
- Issue a TSTATUS macro to determine certain terminal characteristics.
- Issue an EFFECT macro to control the formatting of your terminal output.

CONTROL BYTES

A control byte is a 12-bit quantity, right-justified in bit position 0, 12, 24, 36, or 48 of a CM word.

NOTE

You must ensure that data is not mistaken for a control byte. For example, in the 64-character set, the characters :D at the beginning of a line and followed by an end-of-line will cause you to be logged off if they are written to the terminal output file, since the code 0004 is transmitted.

The following paragraphs describe the bytes available to a user program and their functions. Symbols for most of these control bytes are defined in the system OPL common deck COMSTCM, and may be used by COMPASS programs.

0000—End-of-Line

End-of-line generates a carriage return and line feed, positioning the terminal printing element at the beginning of the next line. An end-of-line consists of 12 to 66 bits of zero, right-justified in one or two central memory words.

0001, 0002—End-of-Block

This byte prevents the positioning of the terminal printing element at the beginning of the next line. An end-of-block byte can be used to allow the terminal user to enter input on the same line as the input request is printed. This byte must be followed by an end-of-line. If not followed immediately by a read request, any output following this byte may be lost.

0003—Auto Input

This byte is used by IAF for auto mode input. The preceding characters in the line in which this byte occurs are sent to the terminal and are also retained as the first characters of the input line. The network can retain a maximum of 10 characters. Also, note the following:

- The user may type ahead without losing data.
- This byte must be followed by an end-of-line.
- The next terminal operation must be an input request. The terminal prompt (a question mark) is suppressed. In general, if you want to suppress prompts, the PROMPT macro should be used.

Refer to Volume 3, System Commands, for further information about auto mode input.

NOTE

The 0003 control byte cannot be used in conjunction with transparent output.

0004—Log Off User

This byte disconnects the terminal from IAF and the network. This byte must be the first byte of a line and must be followed by an end-of-line.

0005—Initiate ASCII Input

This byte causes the next line of input to be translated into 6/12 display code. The terminal prompt (a question mark) is suppressed. This byte must be followed by an end-of-line. On the subsequent input, all terminal control characters or sequences (refer to Control of Program Execution in this section) and terminal definition commands are processed as they are for normal input mode unless the SE terminal definition command has been entered (refer to Volume 3, System Commands). End-of-line (normally a carriage return) terminates 0005 input mode.

If input has been typed ahead when this byte is issued, that input is translated in the old mode.

0006—Initiate Transparent Input Mode

This byte changes the input mode from normal or ASCII to transparent mode. The terminal prompt (a question mark) is suppressed. The byte must be byte 0 of the first word of a line and the word must be terminated by an end-of-line. Bytes 1 and 2 are defined as follows:

- Byte 1 Specifies the maximum number of characters (up to 7777₈) to be received before input is terminated. If byte 1 is 0, the number is assumed to be 1.
- Byte 2 Specifies the termination code. When a character is received from the terminal that matches this byte, the input operation is terminated. Depending on the parity specified for the terminal connection, the lower 8 bits of byte 2 are matched against all 8 bits of the input character, or the lower 7 bits of byte 2 are matched against the lower 7 bits of the input character. If bit 11 of this byte is set, no termination character is assumed.†

This conversion mode packs each 8 bits of data as the lower 8 bits of a 12-bit byte and sets the upper bit (bit 11). The exhaustion of the character count or the occurrence of the termination code causes the end-of-line condition to be set. A 0007 byte is forced as the first byte of input so the data is transmitted as transparent output if it is listed.

†For more information on parity options, refer to the NAM Version 1/CCP Version 3 Terminal Interface Reference Manual.

A user selected input prompt should follow the 0006 word if it is necessary to guarantee that the terminal is in transparent input mode before input is entered. For example, the following two words, when written to an ASCII-code terminal output file, switch the terminal to transparent input mode and issue three BEL characters (ASCII code 007) at which point transparent input mode is in effect.

If input has been typed ahead when this byte is issued, that input is translated in the old mode.

0006	0012	0015	0000	0000
0007	4007	4007	4007	0000

Byte 1 of the 0006 word specifies a maximum character count of 10 (12₈) and byte 2 specifies a termination character of carriage return (015₈ ASCII code). Refer to the description of the 0007 control byte for the second word.

NOTE

The use of transparent input with CYBER Record Manager and/or product set utilities (including compilers) may yield unpredictable results. It is advisable to determine how a particular product set member treats transparent input before proceeding.

0007—Initiate Transparent Output

This byte initiates transparent output. If you wish to output data formatted as described for transparent input, a 0007 byte must precede the data. This mode continues until a nontransparent output data byte is detected. While transparent output is in effect, an end-of-line will not cause termination of the transparent output to occur. This is also true for a carriage return and a line feed. The 0007 byte must be byte 0 (bits 59 through 48) of the first word of a line.

A transparent output data byte is in the format 4xxx₈, where xxx is the 8-bit octal code for the character being printed. Bits 11 through 8 of a transparent output data byte are always set to 1000₂. If this pattern is not detected, the terminal is switched to the original (normal or ASCII) output mode; this feature can be used to output normal or ASCII data immediately following transparent data without explicitly specifying a termination (end-of-line). The characters 5, 6, 7, and 8 (display codes 40₈, 41₈, 42₈, and 43₈) match the transparent mode bit pattern when in the upper half of a byte and are interpreted as transparent data. Therefore, these characters cannot be used to terminate transparent output. Once transparent output mode is terminated, it remains cleared unless resumed by a 0007 control byte.

The following word, when output from an ASCII-code terminal, produces a line feed and prints a question mark. There is no carriage return or line feed after the question mark.

0007	4012	4077	0000	0000
------	------	------	------	------

The 4012 byte produces a line feed (012 is the ASCII code for line feed) and 4077 is the question mark. Similar output can be obtained with the following:

0007 4012 7100 0000 0000

Here 71 is the display code for a question mark and 7100 is a nontransparent data byte. Transparent output is terminated at the question mark and the end-of-line produces a carriage return and line feed.

A control byte that changes the terminal input mode (0003, 0005, or 0006) prevents the system from printing a question mark in response to a program request for input. However, in all other cases, a read request on the input buffer causes the system to print a question mark at the terminal (unless the program has issued a PROMPT OFF macro).

NOTE

The use of transparent output with CYBER Record Manager and/or product set utilities (including compilers) may yield unpredictable results. It is advisable to determine how a particular product set member treats transparent output before proceeding.

0010—Terminal Redefinition for NAM/CDCNET

This byte enables you to alter the characteristics of a terminal that is connected through IAF. The 0010 byte string must have the following format:

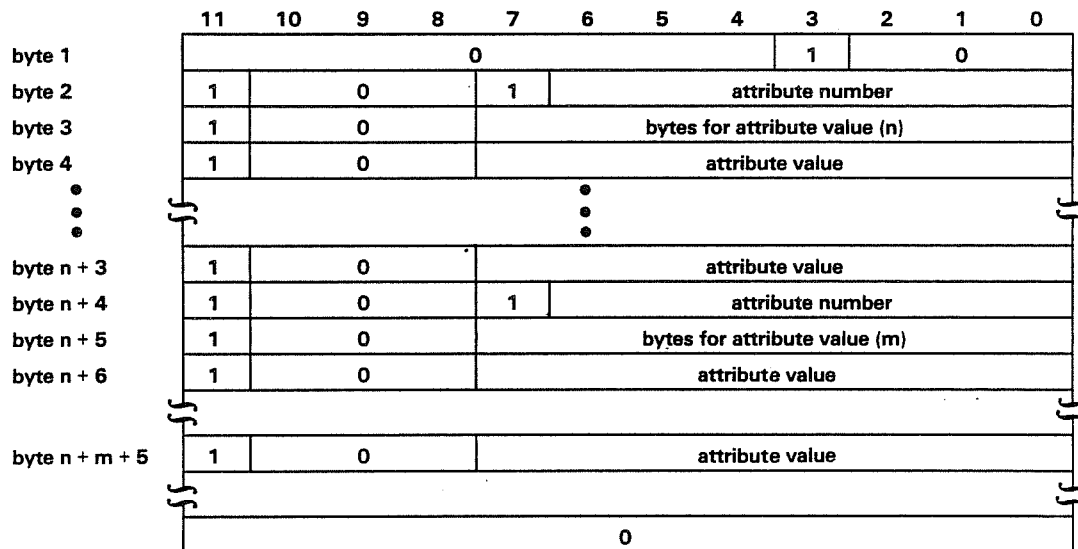

Note that the byte string begins with 0010 and ends with a zero byte (end-of-line). Additionally, the upper bit of all intervening bytes must be set to 1 to prevent a zero value from being interpreted as an end-of-line. The n and m shown above represent the number of bytes required to specify the attribute values.

Table 12-1 lists the terminal attributes along with their attribute numbers, the number of bytes required to specify the attribute values, and the allowable attribute values. For more information on the attributes--for instance, the defaults--refer to the CDCNET Terminal Interface Usage Manual.

As an example, consider the following three attributes and the desired redefinitions:

<u>Attribute</u>	<u>Attribute Number</u>	<u>Bytes Required</u>	<u>Desired Value</u>
Page width	110g	1	100 (144g)
Network control character	100g	1	% (45g)
Transparent message length	10g	2	600 (1130g)

The following 0010 control byte string would produce the desired changes:

```
0010 4310 4001 4144 4300 4001 4045 4210 4002 4130 0000
```

0011—Initiate ASCII Output

This byte is used to initiate 128-character ASCII output (6/12 display code). This byte must be byte 0 (bits 59 through 48) of the first word in the output line and applies only to the line currently being output.

0012—Reserved

This byte should not be used.

0013—End-of-String

This byte allows a user to terminate a line of output data without repositioning the terminal carriage. This byte must be followed by an end-of-line (which is ignored) and output continues with subsequent data. The 0013 byte should not be used where the effect of an end-of-line is needed (for example, the end of a logical line on a synchronous terminal).

0014—Internal End-of-Block

This byte is the first byte of a word and is followed by an end-of-line. This byte is reserved by NOS and should not be used since it may cause loss of data.

Table 12-1. NAM/CDCNET Terminal Redefinition Attributes (Sheet 1 of 2)

Attribute (Mnemonic)	Attribute Number (Octal)	Bytes for Value	Allowable Values
Attention character (AC)	106	1	Character
Attention character action (ACA)	12	1	0-9
Backspace character (BC)	104	1	Character
Backspace window (BW)	135	1	PW, 10-255
Begin line character (BLC)	103	1	Character
Break key action (BKA)	13	1	0-9
Cancel line character (CLC)	101	1	Character
Carriage return delay (CRD)	121	2	0-1000 (milliseconds)
Carriage return sequence (CRS)	115	2	Any 0-2 characters
Character flow control (CFC)	126	1	Yes (1), no (0)
Code set (CS)	130	1	ASCII (0), BPAPL (1), TPAPL (2)
Echoplex (E)	132	1	Yes (1), no (0)
End line character (ELC)	102	1	Character
End line positioning (ELP)	124	1	NONE (0), CR (1), LFS (2), CRLFS (3),
End output sequence (EOS)	114	4	Any 0-4 characters
End page action (EPA)	120	1	NONE (0), FFS (1)
End partial character (EPC)	105	1	Character
End partial position (EPP)	125	1	NONE (0), CR (1), LFS (2), CRLFS (3)
Fold line (FL)	113	1	Yes (1), no (0)
Form feed delay (FFD)	123	2	0-3000 (milliseconds)
Form feed sequence (FFS)	117	7	Any 0-7 characters
Hold page (HP)	111	1	Yes (1), no (0)
Hold page over (HPO)	112	1	Yes (1), no (0)
Input block size (IBS)	14	2	80-2000

Table 12-1. NAM/CDCNET Terminal Redefinition Attributes (Sheet 2 of 2)

Attribute (Mnemonic)	Attribute Number (Octal)	Bytes for Value	Allowable Values
Input editing mode (IEM)	2	1	NORMAL (0), TRANSPARENT (1)
Input output mode (IOM)	1	1	UNSOLICITED (0), SOLICITED (1), FULL DUPLEX (2)
Line feed delay (LFD)	122	2	0=1000 (milliseconds)
Line feed sequence (LFS)	116	2	Any 0-2 characters
Network command character (NCC)	100	1	Character
Page length (PL)	107	1	0, 2-255
Page width (PW)	110	1	0, 10-255
Parity type (P)	131	1	ZERO (0), MARK (1), EVEN (2), ODD (3), NONE (4)
Partial character forwarding (PCF)	11	1	Yes (1), no (0)
Response action (RA)	134	1	SEND (0), DISCARD (1)
Status action (SA)	133	1	SEND (0), HOLD (1), DISCARD (2)
Store backspace character (SBC)	16	1	Yes (1), no (0)
Store nuls dels (SND)	15	1	Yes (1), no (0)
Terminal model (TM)	127	25	Any 1-25 characters
Transparent character mode (TCM)	3	4	NONE (0), TERMINATE (1), FORWARD (2), FORWARD AND TERMINATE (3)
Transparent forward character (TFC)	4	4	1-4 characters
Transparent length mode (TLM)	7	1	NONE (0), TERMINATE (1), FORWARD (2), FORWARD EXACT (3)
Transparent message length (TML)	10	2	1-32, 767
Transparent terminate character (TTC)	5	4	1-4 characters
Transparent timeout mode (TTM)	6	1	NONE (0), TERMINATE (1), FORWARD (2)

0015—Executive Auto Input

This byte is used for internal auto input mode. It is reserved by NOS and should not be used since it may cause loss of data.

0016—Terminal Redefinition for NAM/CCP

This byte enables you to alter the characteristics of a terminal that is connected via IAF. The byte begins a string of 12-bit parameter/12-bit value pairs. The upper bit of each 12-bit segment must be set to prevent a zero value from being interpreted as an end-of-line. The 0016 byte string must be terminated by an end-of-line.

Table 12-2 lists terminal attributes and values allowed for each set of terminal classes. Refer to table 12-3 for mapping between NAM/CCP terminal attributes and the corresponding NAM/CDCNET terminal attributes. For default values for each terminal class, refer to Volume 3, System Commands. Refer to appendix A for the translation of ASCII characters.

Up to 18 terminal characteristic values can be changed by a single 0016 byte string. For example, to change the page width to 100 (144g), control character to %, and turn the page wait option on, issue the following string.

```
0016 4043 4144 4050 4045 4045 4001 0000 0000 0000
```

In the preceding example, each byte has the indicated meaning:

0016	Terminal redefinition control byte.
4043	Specifies page width parameter (43g).
4144	Sets page width to 100 (144g).
4050	Specifies control character parameter (50g).
4045	Sets control character to % (45g).
4045	Specifies page wait parameter (45g).
4001	Sets page wait on (1 equals yes).
00...00	End-of-line (terminates terminal redefinition control byte).

For a complete description of terminal characteristics, refer to Volume 3, System Commands.

Table 12-2. NAM/CCP Terminal Redefinition Attributes (Sheet 1 of 4)

Attribute (Mnemonic)	Attribute Number (Octal)	Terminal Classes ①	Value Range (Decimal)	Form of Input
Abort block (AB)	51	1-8,28-31(9-18)②	0 - 126	Numerical value for character ③
Blocking factor (BF)	31	1-8,10-13,15,18 (9,14,16,17)	0 - 32	Decimal number
Break as user break 1 (BR)	63	1-3,5-8,28-31 (4,9-18)	0 - 1	Yes (1), no (0)
Backspace character (BS)	47	1-8,28-31(9-18)	0 - 126	Numerical value for character ③
Interruption character (B1)	52	1-15,18,28-31 (16,17)	0 - 126	Numerical value for character ③
Termination character (B2)	53	1-15,18,28-31 (16,17)	0 - 126	Numerical value for character ③
Enable transparent user break commands	225	1-8,10-13,15	0 - 1	Yes (1), no (0)
Carriage return idle count (CI)	54	1-8,28-31(9-18)	0 - 127	Decimal number
Carriage return idle default (CA)	56	1-8,28-31(9-18)	1	CA (1)
Carriage return idle time (CRI)	223	1-8,28-31(9-18)	0 - 250	Numerical value indicating the delay time in four millisecond increments
Cancel character (CN)	46	1-15,18,28-31 (16,17)	0 - 126	Numerical value for character ③
Cursor positioning (CP)	107	1-3,5-8,28-31 (4,9-18)	0 - 1	Yes (1), no (0)
Network control character (CT)	50	1-18,28-31	0 - 126	Numerical value for character ③
Single message transparent input delimiters (DL) ④	70	1-8,28-31(9-18)	0 - 1	Character specified (1), not specified (0)

- ① Numbers in parentheses in this column indicate terminal classes for which the attribute is ignored.
 ② Ignored for packet-switching network (PSN) terminals.
 ③ Any hexadecimal value except 00 - 02, 20, 30 - 39, 3D, 41 - 5A, 61 - 7A, or 7F.
 ④ If the value of one of the fields for this parameter is changed, the values of all other fields for this parameter must also be specified.

Table 12-2. NAM/CCP Terminal Redefinition Attributes (Sheet 2 of 4)

Attribute (Mnemonic)	Attribute Number (Octal)	Terminal Classes ①	Value Range (Decimal)	Form of Input
Transparent message length upper (DL)	71	1-3,5-8,28-31 (9-18)	0 - 15	Character count (upper byte)
Transparent message length lower (DL)	72	1-3,5-8,28-31 (9-18)	0 - 255	Character count (lower byte)
Transparent message character delimiter (DL)	73	1-8,10-13,15,18,28-31(9,14,16,17)	0 - 255 ②	Numerical value for character ③
Transparent timeout mode (DL)	74	1-3,5-8,28-31 (9-18)	0 - 1	Timeout (1), no timeout (0)
Multiple-message mode (DL)	106	1-8,10-13,15,18,28-31	0	Single message (0)
End-of-block character (EB)	100	1-3,5-8,10-13,15,18,28-31	0 - 255 ②	Numerical value for character ③
End-of-block option (EBO)	101	1-3,5-8,10-13,15,18,28-31	1 - 2 ②	EL (1), EB (2)
Cursor positioning at end-of-block (CPEB)	102	1-3,5-8,10-13,15,18,28-31 (9,14,16,17,18)	0 - 3 ②	NO (0), CR (1), LF (2), CL (3)
End-of-line character (EL)	75	1-3,5-8,10-13,15,18,28-31	0 - 127 ②	Numerical value for character ③
End-of-line option (ELO)	76	1-3,5-8,10-13,15,18,28-31	1 - 2	EL (1), EB (2)
Cursor positioning at end-of-line (CPEL)	77	1-3,5-8,10-13,15,28-31 (9,14,16,17,18)	0 - 3 ②	NO (0), CR (1), LF (2), CL (3)
Echoplex mode (EP)	61	1-3,5-8,28-31 (4,9-18)	0 - 1	Yes (1), no (0)
Full ASCII input (FA)	67	1-8,10-13,15-18,28-31	0 - 1	Yes (1), no (0)
Input control (IC)	103	1-3,5-8,28-31 (4,9-18)	0 - 1	Yes (1), no (0)
Transparent input mode (XPT)	64	1-8,10-13,15,28-31	0 - 1	Transparent input (1), not transparent (0)

① Numbers in parentheses in this column indicate terminal classes for which the attribute is ignored.

② Not all values are valid for all terminal classes.

③ Any hexadecimal value except 00-02, 20, 30-39, 3D, 41-5A, 61-7A, or 7F.

Table 12-2. NAM/CCP Terminal Redefinition Attributes (Sheet 3 of 4)

Attribute (Mnemonic)	Attribute Number (Octal)	Terminal Classes ①	Value Range (Decimal)	Form of Input
Input device (IN)	65	1-8,28-31	0 - 2 ②	KB (0), PT (1), BK (2)
Line feed idle count (LI)	55	1-8,28-31(9-18)	0 - 127	Decimal number
Line feed idle default	57	1-8,28-31(9-18)	1	LA (1)
Line feed idle time (LFI)	224	1-8,28-31(9-18)	0-250	Numerical value indicating the delay time in four millisecond increments
Lockout unsolicited messages (LK)	40	1-15,18,28-31 (16)	0 - 1	Yes (1), no (0)
Multiple-message ③ transparent delimiters (XL)	70	1-8,28-31(9-18)	0 - 1	Character specified (1), not specified (0)
Transparent message length upper (XL)	71	1-3,5-8,28-31 (9-18)	0 - F	Character count (upper byte)
Transparent message length lower (XL)	72	1-3,5-8,28-31 (9-18)	0 - FF	Character count (lower byte)
Transparent message character delimiter	73	1-8,10-13,15,18, 28-31(9,14,16)	0 - FF ②	Numerical value for character ④
Transparent timeout mode (XL)	74	1-3,5-8,28-31 (9-18)	0 - 1	Timeout (1) no timeout (0)
Multiple-message mode (XL)	106	1-8,10,13,15, 28-31	1	Multiple-message (1)
Output control (OC)	104	1-3,5-8,28-31 (4,9-18)	0 - 1	Yes (1), no (0)
Output device (OP)	66	1-8,28-31(9-18)	0 - 2 ②	DI (0), PR (1), PT (2)
Parity processing (PA)	62	1-3,5-8,28-31	0 - 4	Z (0), O (1), E (2), N (3), I (4)

- ① Numbers in parentheses in this column indicate terminal classes for which the attribute is ignored.
- ② Not all values are valid for all terminal classes.
- ③ If the value of one of the fields for this parameter is changed, the values of all other fields for this parameter must also be specified.
- ④ Any hexadecimal value except 00 - 02, 20, 30 - 39, 3D, 41 - 5A, 61 - 7A, or 7F.

Table 12-2. NAM/CCP Terminal Redefinition Attributes (Sheet 4 of 4)

Attribute (Mnemonic)	Attribute Number (Octal)	Terminal Classes ^①	Value Range (Decimal)	Form of Input
Page waiting (PG)	45	1-8,10-13,15,18,28-31(9,14,16,17)	0 - 1	Yes (1), no (0)
Page length (PL)	44	1-18,28-31	0, 8 - 255 ^②	Number of physical lines
Page width (PW)	43	1-18,28-31	0, 20 - 255	Number of characters
Site-defined use	132-143	1-18,28-31	0 - 255 ^②	Site-defined
Special editing mode (SE)	60	1-8,28-31(9-18)	0 - 1	Yes (1), no (0)
Terminal class (TC)	42	1-10,28-31 ^③	1 - 15 ^②	Number of new class
Transparent mode character delimiter (XL)	105	1-8, 18-31 (9-18)	0 - 255 ^②	Numerical value for character ^④
Sticky timeout (XL)	222	1-3,5-8,28-31, (9-18)	0 - 1	Forward on timeout (1), do not forward on timeout (0)
Transmission block size upper (XBZ1)	36	1-18,28-31 ^③	0 - 7	Decimal number (upper byte)
Transmission block size lower (XBZ2)	37	1-18,28-31 ^③	0 - 255	Decimal number (lower byte)
Upline block limit	30	1-18	1 - 31 ^②	Decimal number
Full duplex (FDLX)	127	1-3,5-8,28-31 (4,9-18)	0 - 1	Yes (1), no (0)
Set terminal in solicited input mode (NTA)	160	1-8,10-13,15,18,28-31	0 - 1	Yes (1), no (0)

- ① Numbers in parentheses in this column indicate terminal classes for which the attribute is ignored.
- ② Not all values are valid for all terminal classes.
- ③ Not allowed for CDC-defined X.25 packet assembly/disassembly (PAD) terminals. For terminal class (TC) changes, refer to the NAM/CCP Host Applications Programming Reference Manual.
- ④ Any hexadecimal value except 00 - 02, 20, 30 - 39, 3D, 41 - 5A, 61 - 7A, or 7F.

Mapping Between Terminal Attributes for NAM/CCP and NAM/CDCNET

Table 12-3 lists the terminal attributes for NAM/CCP that have corresponding terminal attributes for NAM/CDCNET and shows the mapping from NAM/CCP to NAM/CDCNET.

Table 12-3. Terminal Attribute Mapping from NAM/CCP to NAM/CDCNET (Sheet 1 of 3)

NAM/CCP Attributes		NAM/CDCNET Attributes	
Number (Octal)	Mnemonic=Value	Mnemonic=Value	Number (Octal)
31	BF=0	PCF=TRUE	11
	BF=1	PCF=FALSE	
	BF=2	IBS=100 PCF=FALSE IBS=200	
40	LK=0	SA=SEND	133
	LK=1	SA=DISCARD	
43	PW=number	PW=number	110
44	PL=number	PL=number	107
45	PG=0	HP=FALSE	111
	PG=1	HP=TRUE	
46	CN=character	CLC=character	101
47	BS=character	BC=character	104
50	CT=character	NCC=character	100
54	CI=number	CRD=number * line speed factor	121
55	LI=number	LFD=number * line speed factor	122
60	SE=0	CLC=CAN	101
	SE=1	SBC=FALSE EPC=LF CLC=NUL SBC=TRUE EPC=NUL	
61	EP=0	E=FALSE	132
	EP=1	E=TRUE	
62	PA=0	P=ZERO	131
	PA=1	P=ODD	
	PA=2	P=EVEN	
	PA=3	P=NONE	
	PA=4	P=NONE	

Table 12-3. Terminal Attribute Mapping from NAM/CCP to NAM/CDCNET (Sheet 2 of 3)

NAM/CCP Attributes		NAM/CDCNET Attributes	
Number (Octal)	Mnemonic=Value	Mnemonic=Value	Number (Octal)
63	BR=0 BR=1	BKA=0 BKA=1	13
64	XPT=0 XPT=1	IEM=NORMAL IEM=TRANSPARENT	2
66	OP=0 OP=1 OP=2	FL=FALSE FL=TRUE none	113
67	FA=0 FA=1	EPC=LF SBC=FALSE SND=FALSE EPC=NUL SBC=TRUE SND=TRUE	105 16 15
70	DL(or XL)=0 DL(or XL)=1 (when number 106=0) DL(or XL)=1 (when number 106=1)	TCM=NONE TCM=TERMINATE TCM=FORWARD_TERMINATE	3
71	DL (or XL) not specified and number 72 not specified DL (or XL) specified and number 72 specified	TLM=NONE TML=value of numbers 72+256* (value of number 71)	7
72	DL (or XL) not specified and number 71 not specified DL (or XL) specified and number 71 specified	TLM=NONE TML=value of numbers 72+256* (value of number 71)	7
73	DL (or XL) specified DL (or XL) specified as CR and terminal parity=IGNORE	TFC=value of number 73 TFC=(4 ₁₆ ,84 ₁₆)	4
74	DL(or XL)=0 DL(or XL)=1 and number 106 or number 222=0 DL(or XL)=1 and number 106 and number 222=1	TTM=NONE TTM=TERMINATE TTM=FORWARD	6
75	EL=character	ELC=character	102
77	CPEL=0 CPEL=1 CPEL=2 CPEL=3	ELP=NONE ELP=CRS ELP=LFS ELP=CRLFS	124

Table 12-3. Terminal Attribute Mapping from NAM/CCP to NAM/CDCNET (Sheet 3 of 3)

NAM/CCP Attributes		NAM/CDCNET Attributes	
Number (Octal)	Mnemonic=Value	Mnemonic=Value	Number (Octal)
103	IC=0 IC=1	CFC=FALSE CFC=TRUE	126
104	OC=0 OC=1	CFC=FALSE CFC=TRUE	126
105	XL specified XL specified as CR and terminal parity=IGNORE	TTC=value of number 105 TTC=(4 ₁₆ ,84 ₁₆)	5
106	DL(or XL)=0 DL(or XL)=1 and number 73 specified but number 105 not specified DL(or XL)=1 and TML=1 DL(or XL)=1 and TML=1	TLM=TERMINATE TTC=TFC TLM=FORWARD TLM=FORWARD_EXACT	7
107	CP=0 CP=1	ELP=NONE EPP=NONE ELP=LFS EPP=CRS	124 125
127	FDLX=0 FDLX=1	IOM=SOLICITED IOM=FULLDUPLEX	1
146	PP=character	EOS=character	114
160	NTA=0 NTA=1	IOM=UNSOLICITED IOM=SOLICITED	1
222	number 74=0 number 222=1 and number 74=1 and number 106=1 number 74=1 and either number 106=0 or number 222=0	TTM=NONE TTM=FORWARD TTM=TERMINATE	6
223	CRI=number	CRD=number*4	121
224	LFI=number	LFD=number*4	122

CONTROL OF PROGRAM EXECUTION

Program execution control sequences vary depending on the type of network. The following description applies only to the NAM/CCP network. CDCNET program execution control sequences are documented in the CDCNET Terminal Interface Usage manual.

By entering various sequences of keys or commands at your terminal, you can control an interactive program during all phases of execution. The following is a list of the interruption and termination sequences and their effect on the executing program (the $\text{\textcircled{CR}}$ denotes the message terminator key).

<u>Phase</u>	<u>Sequence†</u>	<u>Effect</u>
Waiting for input	CTRL/T $\text{\textcircled{CR}}$	The program is terminated and the terminal is placed in command mode. All other entries are passed to the program as data.
Generating output	BREAK seq	Pressing the BREAK key on asynchronous terminals suspends the output operation. For synchronous terminals, output is automatically suspended on page boundaries, at which point terminal control can be attempted.

NOTE

On asynchronous terminals, output can be suspended by pressing any key that transmits a character. The character entered is also sent to IAF if a $\text{\textcircled{CR}}$ or line feed is entered. The integrity of this character is not guaranteed, and may cause the interruption sequence which follows to be ignored. It is recommended that the BREAK key be used to suspend output.

†The termination (sometimes referred to as user break 2) sequence (that is, CTRL/T $\text{\textcircled{CR}}$) and interruption (sometimes referred to as user break 1) sequence (that is, CTRL/P $\text{\textcircled{CR}}$) may vary for different terminals, and may be changed by terminal definition commands. Refer to Volume 3, System Commands, for further information. CTRL refers to the control key. Thus, CTRL/T is entered by keeping the control key depressed while pressing the T key.

<u>Phase</u>	<u>Sequence†</u>	<u>Effect</u>
--------------	------------------	---------------

Once output is suspended, further execution depends upon the subsequent sequence of keys or characters entered. Each of the following sequences has the indicated effect on the output operation.

<u>seq</u>	<u>Effect</u>
CTRL/T (CR)	This has the same effect as the termination sequence in the input phase.
CTRL/P (CR)††	<p>The output operation ceases and the terminal is placed in suspend mode. At this point IAF recognizes only:</p> <ul style="list-style-type: none"> • The P key causing a return to program control, discarding any data in the program buffer prior to the interruption sequence. • A (CR) causing output to be continued and program control to continue normally. Portions of the output may be lost when output is suspended. • Any other key (with the exception of terminal control characters and terminal definition commands) is interpreted as a request to terminate the job step.

If any other sequence of characters or keys is entered followed by a (CR), the output operation is resumed with the last partial line repeated.

Executing	CTRL/T (CR) or CTRL/P (CR)	These have the same effect as if they were entered during output phase.
-----------	----------------------------------	---

† The termination (sometimes referred to as user break 2) sequence (that is, CTRL/T (CR)) and interruption (sometimes referred to as user break 1) sequence (that is, CTRL/P (CR)) may vary for different terminals and may be changed by terminal definition commands. Refer to Volume 3, System Commands, for further information. CTRL refers to the control key. Thus, CTRL/T is entered by keeping the control key depressed while pressing the T key.

†† If the BR terminal redefinition parameter has been set to 1 or if the terminal definition command cBR=Y or TRMDEF,BR=Y has been entered, the BREAK key has the same effect as CTRL/P (CR).

REPRIEVE PROCESSING FOR USER BREAKS 1 AND 2

If the user program has selected terminal interrupt reprieve processing, control will be passed to the user's interrupt package when a user break 1 or 2 is encountered. The user program may now process the interrupt as desired.

To ignore either interrupt, a REPRIEVE RESUME call may be used. This will restart the interrupted sequence as if the interrupt had never occurred.

If the user wishes to have the system process the user break 2, a REPRIEVE RESET call will return control to the system, and the interrupt will be processed in the normal manner.

The user break 1 interrupt cannot be returned to the system by a RESET call.

If the user desires the sequence

INTERRUPTED (CR)

that is normally associated with a user break 1, the sequence will have to be emulated in the user's interrupt handler.

CHARACTER SETS

A

A character set is composed of graphic and control characters. A code set is a set of codes used to represent each character within a character set.

A graphic character may be displayed at a terminal or printed by a line printer. Examples are the characters A through Z and the digits 0 through 9. A control character initiates, modifies, or stops a control operation. An example is the backspace character that moves the terminal carriage or cursor back one space. Although a control character is not a graphic character, a terminal may produce a graphic representation when it receives a control character.

All references within this manual to the ASCII character set or the ASCII code set refer to the character set and code set defined in the American National Standard Code for Information Interchange (ASCII, ANSI Standard X3.4-1977). References in this manual to the ASCII character set do not necessarily refer to the ASCII code set.

NOS supports the following character sets.

- CDC graphic 64- (or 63-) character set.
- ASCII 128-character set.
- ASCII graphic 64- (or 63-) character set.
- ASCII graphic 95-character set.

Each installation selects either the 64-character set or the 63-character set. The differences between the two are described in Character Set Anomalies in this appendix. Any reference in this appendix to the 64-character set implies either the 63- or 64-character set, unless otherwise stated.

NOS supports the following code sets.

- 6-bit display code.
- 6/12-bit display code.
- 7-bit ASCII code.

Display code is a set of 6-bit codes from 00₈ to 77₈.

The 6/12-bit display code is a combination of 6-bit codes and 12-bit codes. The 6-bit codes are 00₈ through 77₈, excluding 74₈ and 76₈. (Refer to Character Set Anomalies for the interpretation of the 00₈ and 63₈ codes.) The 12-bit codes begin with either 74₈ or 76₈ and are followed by a 6-bit code. Thus, 74₈ and 76₈ are considered escape codes and are never used as 6-bit codes within the 6/12-bit display code set. The 12-bit codes are 7401₈, 7402₈, 7404₈, 7407₈, and 7601₈ through 7677₈. All other 12-bit codes (74xx₈ and 7600₈) are undefined.

The 7-bit ASCII code (as defined by ANSI Standard X3.4-1977) is right-justified in a 12-bit byte. Assuming that the bits are numbered from the right starting with 0, bits 0 through 6 contain the ASCII code, bits 7 through 10 contain zeros, and bit 11 distinguishes the 0000₈ code from the end-of-line byte. The 7-bit codes are 0001₈ through 0177₈ and 4000₈.

CHARACTER SET ANOMALIES

NOS interprets two codes differently when the installation selects the 63-character set rather than the 64-character set. In tables A-1, A-2, and A-3, the codes for the colon and percent graphic characters in the 64-character set are unshaded; the codes for the colon and percent graphic characters in the 63-character set are shaded.

If an installation uses the 63-character set, the colon graphic character is always represented by a 63₈ code, and the 00₈ code is undefined. However, if the installation uses the 64-character set, output of 6/12-bit display codes 7404₈ or 6-bit display code 00₈ produces a colon. In ASCII mode for interactive jobs, a colon can be input only as a 7404₈ 6/12-bit display code.

When using either the 63- or 64-character set, the use of undefined 6/12-bit display codes in output files produces unpredictable results and should be avoided.

On input, NOS recognizes alternate 029 punch codes of 11-0 for the right bracket (]) and 12-0 for the left bracket ([). The alternate codes support the COBOL sign overpunch convention and are not recommended for other uses. Refer to COBOL 5 Reference Manual.

Also, two 00₈ codes may be confused with an end-of-line byte and should be avoided (refer to appendix F for further explanation).

Translation of 7-bit ASCII to 6-bit display code causes character set folding from the 128-character ASCII set to the 63- or 64-character ASCII subset. The following special character substitutions occur:

7-Bit ASCII		6-Bit Display Code		7-Bit ASCII	
Code	Character	Code	Character	Code	Character
0140	`	74	@	0100	@
0173	{	61	[0133	[
0174	----->	75	\ ----->	0134	\
0175	}	62]	0135]
0176	~	76	^	0136	^

CHARACTER SET TABLES

This appendix contains character set tables for interactive jobs, batch jobs, and jobs involving magnetic tapes. Table A-1 is for interactive jobs, and table A-2 is for batch jobs. Table A-3 is a conversion table used to cross-reference 7-bit ASCII codes and 6/12-bit display codes and to convert ASCII codes from octal to hexadecimal.

Tables A-4, A-5, and A-6 list the magnetic tape codes and their display code equivalents.

The character set tables are designed so that you can find the character represented by a code (such as in a dump) or find the code that represents a character. To find the character represented by a code, look up the code in the column listing the appropriate code set and then find the character on that line in the column listing the appropriate character set. To find the code that represents a character, you first look up the character and then find the code on the same line in the appropriate column.

INTERACTIVE JOBS

Table A-1 shows the character sets and code sets available to you at an ASCII code terminal. When in NORMAL mode (specified by the NORMAL command†), NOS displays the ASCII graphic 64-character set and interprets all input and output as 6-bit display code. When in ASCII mode (specified by the ASCII command), NOS displays the ASCII 128-character set and interprets all input and output as 6/12-bit display code.

To determine the octal or hexadecimal ASCII code for a character, refer to table A-3. (Certain terminal definition commands require specification of an ASCII code.)

On output, the US code is reserved for network use and defined as an end-of-line. Use of this character, except in transparent mode, causes incorrect formatting and possible loss of output characters.

BATCH JOBS

Table A-2 lists the CDC graphic 64-character set, the ASCII graphic 64-character set, and the ASCII graphic 95-character sets. It also lists the code sets and card punch codes (026 and 029) that represent the characters.

The 64-character sets use display code as their code set; the 95-character set uses 7-bit ASCII code. The 95-character set is composed of all the characters in the ASCII 128-character set that can be printed at a line printer (refer to jobs using Line Printers). Only 7-bit ASCII code files can be printed using the ASCII graphic 95-character set. To print a 6/12-bit display code file (usually created by an interactive job in ASCII mode), you must convert the file to 7-bit ASCII code. To do this, you enter the FCOPY command. The 95-character set is represented by 7-bit ASCII codes 0040₈ through 0176₈.

JOBS USING LINE PRINTERS

The batch character set printed depends on the print train used on the line printer to which the file is sent (refer to section 7). The following table lists the print trains according to the associated ROUTE command EC parameter values.

† Normal and ASCII modes can also be selected via the CSET COMPASS macro.

Print Train	Route EC Values That Will Print	Route EC Value That Will Not Print	Suggested Print Band
0†	None, B4, B6	A4, A6, A9	595-1/596-1
1	None, B4, B6	A4, A6, A9	595-1/596-1
2†	None, B4, B6	A4, A6, A9	595-1/596-1
3†	None, B4, B6	A4, A6, A9	595-1/596-1
4	None, A4, A6, A9	B4, B6	595-6/596-6
5	None, A4, A6	B4, B6, A9	595-4/596-4 or 595-5/596-5
6	A9	None, B4, B6, A4, A6	595-6/596-6
7	None, B4, B6, A4, A6, A9		595-6/596-6

†These print trains are reserved for future CDC use. If specified, they have the same effect as if print train 7 was specified.

For PSU printers, the batch character sets and associated print trains are as follows:

<u>Character Set</u>	<u>533/536 Print Trains</u>
ASCII graphic 64-character set	530-1
ASCII graphic 95-character set	530-2

The characters of the default 596-1 print train are listed in the table A-2 column labeled CDC Graphic (64 Character); the 596-5 print train characters are listed in the table A-2 column labeled ASCII Graphic (64 Character); and the 596-6 print train characters are listed in the table A-2 column labeled ASCII Graphic (95 Character).

If a transmission error occurs when printing a line, the system prints the line again. The CDC graphic print train prints a concatenation symbol (↪) in the first printable column of the repeated listing of the line. The ASCII print trains print an underline () instead of the concatenation symbol.

If an unprintable character exists in a line (that is, a 7-bit ASCII code outside the range 0040₈ through 0176₈), the number sign (#) appears in the first printable column of a print line, and a space replaces the unprintable character.

To route and correctly print a 6/12-bit display code file on a line printer with the ASCII graphic 95-character set, you must convert the 6/12-bit display code file to a 7-bit ASCII code file with the FCOPY command (refer to section 9). The resulting 7-bit ASCII file can be routed to a line printer (refer to section 7) but cannot be output at an interactive terminal.

Table A-1. Character Sets for Interactive Jobs (Sheet 1 of 2)

ASCII Graphic (64 Character)	ASCII Character (128 Character)	6-Bit Display Code	6/12- Bit Display Code	7-Bit ASCII Code	ASCII Graphic (64 Character)	ASCII Character (128 Character)	6-Bit Display Code	6/12- Bit Display Code	7-Bit ASCII Code		
: colon		00†			# number sign	# number sign	60	60	0043		
Display code 00 is undefined at sites using the 63-character set.					[opening bracket	[opening bracket	61	61	0133		
A	A	01	01	0101] closing bracket] closing bracket	62	62	0135		
B	B	02	02	0102	% percent sign	% percent sign	63	63†	0045		
C	C	03	03	0103	: colon	: colon	63	63	0072		
D	D	04	04	0104	" quote	" quote	64	64	0042		
E	E	05	05	0105	_ underline	_ underline	65	65	0137		
F	F	06	06	0106	! exclamation point	! exclamation point	66	66	0041		
G	G	07	07	0107	& ampersand	& ampersand	67	67	0046		
					' apostrophe	' apostrophe	70	70	0047		
H	H	10	10	0110	? question mark	? question mark	71	71	0077		
I	I	11	11	0111	< less than	< less than	72	72	0074		
J	J	12	12	0112	> greater than	> greater than	73	73	0076		
K	K	13	13	0113	@ commercial at	@ commercial at	74†	7401	0100		
L	L	14	14	0114	\ reverse slant	\ reverse slant	75	75	0134		
M	M	15	15	0115	˘ circumflex	˘ circumflex	76†	7402	0136		
N	N	16	16	0116	; semicolon	; semicolon	77	77	0073		
O	O	17	17	0117		: colon		7404	0072		
						% percent		7404	0045		
P	P	20	20	0120		` grave accent		74†	0140		
Q	Q	21	21	0121		a			7601	0141	
R	R	22	22	0122		b			7602	0142	
S	S	23	23	0123		c			7603	0143	
T	T	24	24	0124		d			7604	0144	
U	U	25	25	0125		e			7605	0145	
V	V	26	26	0126		f			7606	0146	
W	W	27	27	0127		g			7607	0147	
X	X	30	30	0130		h			7610	0150	
Y	Y	31	31	0131		i			7611	0151	
Z	Z	32	32	0132		j			7612	0152	
0	0	33	33	0060		k			7613	0153	
1	1	34	34	0061		l			7614	0154	
2	2	35	35	0062		m			7615	0155	
3	3	36	36	0063		n			7616	0156	
4	4	37	37	0064		o			7617	0157	
5	5	40	40	0065		p			7620	0160	
6	6	41	41	0066		q			7621	0161	
7	7	42	42	0067		r			7622	0162	
8	8	43	43	0070		s			7623	0163	
9	9	44	44	0071		t			7624	0164	
+ plus	+ plus	45	45	0053		u			7625	0165	
- dash	- dash	46	46	0055		v			7626	0166	
* asterisk	* asterisk	47	47	0052		w			7627	0167	
/ slant	/ slant	50	50	0057		x			7630	0170	
(opening parenthesis	(opening parenthesis	51	51	0050		y			7631	0171	
) closing parenthesis) closing parenthesis	52	52	0051		z			7632	0172	
\$ dollar sign	\$ dollar sign	53	53	0044		{ opening brace			61†	7633	0173
= equal	= equal	54	54	0075		vertical line			75†	7634	0174
space	space	55	55	0040		} closing brace			62†	7635	0175
, comma	, comma	56	56	0054		~ tilde			76†	7636	0176
. period	. period	57	57	0056		DEL				7637	0177

†The interpretation of this character or code may depend on its context. Refer to Character Set Anomalies elsewhere in this appendix.

Table A-1. Character Sets for Interactive Jobs (Sheet 2 of 2)

ASCII Graphic (64 Character)	ASCII Character (128 Character)	6-Bit Display Code	6/12- Bit Display Code	7-Bit ASCII Code	ASCII Graphic (64 Character)	ASCII Character (128 Character)	6-Bit Display Code	6/12- Bit Display Code	7-Bit ASCII Code
	NUL		7640	4000		DLE		7660	0020
	SOH		7641	0001		DC1		7661	0021
	STX		7642	0002		DC2		7662	0022
	ETX		7643	0003		DC3		7663	0023
	EOT		7644	0004		DC4		7664	0024
	ENQ		7645	0005		NAK		7665	0025
	ACK		7646	0006		SYN		7666	0026
	BEL		7647	0007		ETB		7667	0027
	BS		7650	0010		CAN		7670	0030
	HT		7651	0011		EM		7671	0031
	LF		7652	0012		SUB		7672	0032
	VT		7653	0013		ESC		7673	0033
	FF		7654	0014		FS		7674	0034
	CR		7655	0015		GS		7675	0035
	SO		7656	0016		RS		7676	0036
	SI		7657	0017		US†		7677	0037

†Reserved for network use. Refer to Character Set Tables in this appendix.

Table A-2. Character Sets for Batch Jobs (Sheet 1 of 3)

CDC Graphic (64 Character)	ASCII Graphic (64 Character)	ASCII Graphic (95 Character)	6-Bit Display Code	6/12-Bit Display Code	7-Bit ASCII Code	Punch Code	
						026	029
: colon†	: colon†		00†			8-2	8-2
Display code 00 is undefined at sites using the 63-character set.							
A	A	A	01	01	0101	12-1	12-1
B	B	B	02	02	0102	12-2	12-2
C	C	C	03	03	0103	12-3	12-3
D	D	D	04	04	0104	12-4	12-4
E	E	E	05	05	0105	12-5	12-5
F	F	F	06	06	0106	12-6	12-6
G	G	G	07	07	0107	12-7	12-7
H	H	H	10	10	0110	12-8	12-8
I	I	I	11	11	0111	12-9	12-9
J	J	J	12	12	0112	11-1	11-1
K	K	K	13	13	0113	11-2	11-2
L	L	L	14	14	0114	11-3	11-3
M	M	M	15	15	0115	11-4	11-4
N	N	N	16	16	0116	11-5	11-5
O	O	O	17	17	0117	11-6	11-6
P	P	P	20	20	0120	11-7	11-7
Q	Q	Q	21	21	0121	11-8	11-8
R	R	R	22	22	0122	11-9	11-9
S	S	S	23	23	0123	0-2	0-2
T	T	T	24	24	0124	0-3	0-3
U	U	U	25	25	0125	0-4	0-4
V	V	V	26	26	0126	0-5	0-5
W	W	W	27	27	0127	0-6	0-6
X	X	X	30	30	0130	0-7	0-7
Y	Y	Y	31	31	0131	0-8	0-8
Z	Z	Z	32	32	0132	0-9	0-9
0	0	0	33	33	0060	0	0
1	1	1	34	34	0061	1	1
2	2	2	35	35	0062	2	2
3	3	3	36	36	0063	3	3
4	4	4	37	37	0064	4	4
5	5	5	40	40	0065	5	5
6	6	6	41	41	0066	6	6
7	7	7	42	42	0067	7	7
8	8	8	43	43	0070	8	8
9	9	9	44	44	0071	9	9
+ plus	+ plus	+ plus	45	45	0053	12	12-8-6
- dash	- dash	- dash	46	46	0055	11	11
* asterisk	* asterisk	* asterisk	47	47	0052	11-8-4	11-8-4

†The interpretation of this character or code may depend on its context. Refer to Character Set Anomalies elsewhere in this appendix.

Table A-2. Character Sets for Batch Jobs (Sheet 2 of 3)

CDC Graphic (64 Character)	ASCII Graphic (64 Character)	ASCII Graphic (95 Character)	6-Bit Display Code	6/12-Bit Display Code	7-Bit ASCII Code	Punch Code	
						026	029
/ slant	/ slant	/ slant	50	50	0057	0-1	0-1
(opening parenthesis	(opening parenthesis	(opening parenthesis	51	51	0050	0-8-4	12-8-5
) closing parenthesis) closing parenthesis) closing parenthesis	52	52	0051	12-8-4	11-8-5
\$ dollar sign	\$ dollar sign	\$ dollar sign	53	53	0044	11-8-3	11-8-3
= equal	= equal	= equal	54	54	0075	8-3	8-6
space	space	space	55	55	0040	no punch	no punch
, comma	, comma	, comma	56	56	0054	0-8-3	0-8-3
. period	. period	. period	57	57	0056	12-8-3	12-8-3
≡ equivalence	# number sign	# number sign	60	60	0043	0-8-6	8-3
[opening bracket	[opening bracket	[opening bracket	61	61	0133	8-7	12-8-2†
] closing bracket] closing bracket] closing bracket	62	62	0135	0-8-2	11-8-2†
% percent sign†	% percent sign†	% percent sign†	63†	63†	0045	8-6	0-8-4
: colon	: colon	: colon	63	63	0072	8-2	8-2
≠ not equal	" quote	" quote	64	64	0042	8-4	8-7
⤵ concatenation	underline	underline	65	65	0137	0-8-5	0-8-5
∨ logical OR	‡ exclamation point	‡ exclamation point	66	66	0041	11-0	12-8-7
∧ logical AND	& ampersand	& ampersand	67	67	0046	0-8-7	12
↑ superscript	' apostrophe	' apostrophe	70	70	0047	11-8-5	8-5
↓ subscript	? question mark	? question mark	71	71	0077	11-8-6	0-8-7
< less than	< less than	< less than	72	72	0074	12-0	12-8-4
> greater than	> greater than	> greater than	73	73	0076	11-8-7	0-8-6
≤ less or equal	@ commercial at	@ commercial at	74			8-5	8-4
≥ greater or equal	\ reverse slant	\ reverse slant	75	75	0134	12-8-5	0-8-2
- logical NOT	^ circumflex	^ circumflex	76			12-8-6	11-8-7
; semicolon	; semicolon	; semicolon	77	77	0073	12-8-7	11-8-6
		@ commercial at	74†	7401	0100		
		^ circumflex	76†	7402	0136		
		: colon†		7404†	0072		
		% percent sign		7404	0045		
		grave accent	74†	7407	0140		
		a		7601	0141		
		b		7602	0142		
		c		7603	0143		
		d		7604	0144		
		e		7605	0145		
		f		7606	0146		
		g		7607	0147		

†The interpretation of this character or code may depend on its context. Refer to Character Set Anomalies elsewhere in this appendix.

Table A-2. Character Sets for Batch Jobs (Sheet 3 of 3)

CDC Graphic (64 Character)	ASCII Graphic (64 Character)	ASCII Graphic (95 Character)	6-Bit Display Code	6/12-Bit Display Code	7-Bit ASCII Code	Punch Code	
						026	029
		h		7610	0150		
		i		7611	0151		
		j		7612	0152		
		k		7613	0153		
		l		7614	0154		
		m		7615	0155		
		n		7616	0156		
		o		7617	0157		
		p		7620	0160		
		q		7621	0161		
		r		7622	0162		
		s		7623	0163		
		t		7624	0164		
		u		7625	0165		
		v		7626	0166		
		w		7627	0167		
		x		7630	0170		
		y		7631	0171		
		z		7632	0172		
		{ opening brace	61†	7633	0173		
		vertical line	75†	7634	0174		
		} closing brace	62†	7635	0175		
		~ tilde	76†	7636	0176		

†The interpretation of this character or code may depend on its context. Refer to Character Set Anomalies elsewhere in this appendix.

Table A-3. ASCII to 6/12-Bit Display Code Conversion (Sheet 1 of 2)

ASCII Character (128 Character)	7-Bit ASCII Code		6/12-Bit Display Code	ASCII Character (128 Character)	7-Bit ASCII Code		6/12-Bit Display Code
	Octal	Hexadecimal			Octal	Hexadecimal	
NUL	4000	00	7640	0	0060	30	33
SOH	0001	01	7641	1	0061	31	34
STX	0002	02	7642	2	0062	32	35
ETX	0003	03	7643	3	0063	33	36
EOT	0004	04	7644	4	0064	34	37
ENQ	0005	05	7645	5	0065	35	40
ACK	0006	06	7646	6	0066	36	41
BEL	0007	07	7647	7	0067	37	42
BS	0010	08	7650	8	0070	38	43
HT	0011	09	7651	9	0071	39	44
LF	0012	0A	7652	: colon††	0072	3A	7404††
VT	0013	0B	7653	: colon	0072	3A	63
FF	0014	0C	7654	; semicolon	0073	3B	77
CR	0015	0D	7655	< less than	0074	3C	72
SO	0016	0E	7656	= equal	0075	3D	54
SI	0017	0F	7657	> greater than	0076	3E	73
				? question mark	0077	3F	71
DLE	0020	10	7660	@ commercial at	0100	40	7401
DC1	0021	11	7661	A	0101	41	01
DC2	0022	12	7662	B	0102	42	02
DC3	0023	13	7663	C	0103	43	03
DC4	0024	14	7664	D	0104	44	04
NAK	0025	15	7665	E	0105	45	05
SYN	0026	16	7666	F	0106	46	06
ETB	0027	17	7667	G	0107	47	07
CAN	0030	18	7670	H	0110	48	10
EM	0031	19	7671	I	0111	49	11
SUB	0032	1A	7672	J	0112	4A	12
ESC	0033	1B	7673	K	0113	4B	13
FS	0034	1C	7674	L	0114	4C	14
GS	0035	1D	7675	M	0115	4D	15
RS	0036	1E	7676	N	0116	4E	16
US†	0037	1F	7677†	O	0117	4F	17
space	0040	20	55	P	0120	50	20
! exclamation point	0041	21	66	Q	0121	51	21
" quote	0042	22	64	R	0122	52	22
# number sign	0043	23	60	S	0123	53	23
\$ dollar sign	0044	24	53	T	0124	54	24
% percent sign††	0045	25	63††	U	0125	55	25
% percent sign	0045	25	7404	V	0126	56	26
& ampersand	0046	26	67	W	0127	57	27
' apostrophe	0047	27	70	X	0130	58	30
(opening parenthesis	0050	28	51	Y	0131	59	31
) closing parenthesis	0051	29	52	Z	0132	5A	32
* asterisk	0052	2A	47	[opening bracket	0133	5B	61
+ plus	0053	2B	45	\ reverse slant	0134	5C	75
, comma	0054	2C	56] closing bracket	0135	5D	62
- dash	0055	2D	46	^ circumflex	0136	5E	7402
. period	0056	2E	57	_ underline	0137	5F	65
/ slant	0057	2F	50				

†Reserved for network use: Refer to Character Set Tables in this appendix.
 ††The interpretation of this character or code may depend on its context. Refer to Character Set Anomalies in this appendix.

Table A-3. ASCII to 6/12-Bit Display Code Conversion (Sheet 2 of 2)

ASCII Character (128 Character)	7-Bit ASCII Code		6/12-Bit Display Code	ASCII Character (128 Character)	7-Bit ASCII Code		6/12-Bit Display Code
	Octal	Hexadecimal			Octal	Hexadecimal	
` grave accent	0140	60	7407	p	0160	70	7620
a	0141	61	7601	q	0161	71	7621
b	0142	62	7602	r	0162	72	7622
c	0143	63	7603	s	0163	73	7623
d	0144	64	7604	t	0164	74	7624
e	0145	65	7605	u	0165	75	7625
f	0146	66	7606	v	0166	76	7626
g	0147	67	7607	w	0167	77	7627
h	0150	68	7610	x	0170	78	7630
i	0151	69	7611	y	0171	79	7631
j	0152	6A	7612	z	0172	7A	7632
k	0153	6B	7613	{ opening brace	0173	7B	7633
l	0154	6C	7614	vertical line	0174	7C	7634
m	0155	6D	7615	} closing brace	0175	7D	7635
n	0156	6E	7616	~ tilde	0176	7E	7636
o	0157	6F	7617	DEL	0177	7F	7637

JOBS USING MAGNETIC TAPE

Coded data to be copied from mass storage to magnetic tape is assumed to be represented in display code. NOS converts the data to external BCD code when writing a coded seven-track tape and to ASCII or EBCDIC code (as specified on the tape assignment command) when writing a coded nine-track tape.

Because only 63 characters can be represented in seven-track even parity, one of the 64 display codes is lost in conversion to and from external BCD code. The following shows the differences in conversion depending on the character set (63 or 64) which the system uses. The ASCII character for the specified character code is shown in parentheses. The output arrow shows how the 6-bit display code changes when it is written on tape in external BCD. The input arrow shows how the external BCD code changes when the tape is read and converted to 6-bit display code.

<u>63-Character Set</u>				
<u>6-Bit Display Code</u>		<u>External BCD</u>		<u>6-Bit Display Code</u>
00		16 (%)		00
33 (0)	Output →	12 (0)	← Input	33 (0)
63 (:)		12 (0)		33 (0)

<u>64-Character Set</u>				
<u>6-Bit Display Code</u>		<u>External BCD</u>		<u>6-Bit Display Code</u>
00 (:)		12 (0)		33 (0)
33 (0)	Output →	12 (0)	← Input	33 (0)
63 (%)		16 (%)		63 (%)

If a lowercase ASCII or EBCDIC code is read from a nine-track coded tape, it is converted to its uppercase 6-bit display code equivalent. To read and write lowercase ASCII or EBCDIC characters, you must assign the tape in binary mode and use the FCOPY utility (refer to Volume 3, System Commands).

Tables A-4 and A-5 show the character set conversion for nine-track tapes. Table A-4 lists the conversions to and from the 7-bit ASCII character code and 6-bit display code. Table A-5 lists the conversions between the EBCDIC character code and the 6-bit display code. Table A-6 shows the character set conversions between external BCD and 6-bit display code for seven-track tapes.

Table A-4. Nine-Track ASCII Coded Tape Conversion

7-Bit ASCII				6-Bit Display Code		7-bit ASCII				6-Bit Display Code	
Code (Hex)	Char†	Code (Hex)	Char††	Char	Code (Octal)	Code (Hex)	Char†	Code (Hex)	Char††	Char	Code (Octal)
20	space	00	NUL	space	55	3E	>	1E	RS	>	73
21	!	7D	}	!	66	3F	?	1F	US	?	71
22	"	02	STX	"	64	40	@	60	`	@	74
23	#	03	ETX	#	60	41	A	61	a	A	01
24	\$	04	EOT	\$	53	42	B	62	b	B	02
25	%	05	ENQ	%	63	43	C	63	c	C	03
25	%	05	ENQ	space††	55	44	D	64	d	D	04
26	&	06	ACK	&	67	45	E	65	e	E	05
27	'	07	BEL	'	70	46	F	66	f	F	06
28	(08	BS	(51	47	G	67	g	G	07
29)	09	HT)	52	48	H	68	h	H	10
2A	*	0A	LF	*	47	49	I	69	i	I	11
2B	+	0B	VT	+	45	4A	J	6A	j	J	12
2C	,	0C	FF	,	56	4B	K	6B	k	K	13
2D	-	0D	CR	-	46	4C	L	6C	l	L	14
2E	.	0E	SO	.	57	4D	M	6D	m	M	15
2F	/	0F	SI	/	50	4E	N	6E	n	N	16
30	0	10	DLE	0	33	4F	O	6F	o	O	17
31	1	11	DC1	1	34	50	P	70	p	P	20
32	2	12	DC2	2	35	51	Q	71	q	Q	21
33	3	13	DC3	3	36	52	R	72	r	R	22
34	4	14	DC4	4	37	53	S	73	s	S	23
35	5	15	NAK	5	40	54	T	74	t	T	24
36	6	16	SYN	6	41	55	U	75	u	U	25
37	7	17	ETB	7	42	56	V	76	v	V	26
38	8	18	CAN	8	43	57	W	77	w	W	27
39	9	19	EM	9	44	58	X	78	x	X	30
3A	:	1A	SUB	:	00	59	Y	79	y	Y	31
6-bit display code 00 is undefined at sites using the 63-character set.											
3A	:	1A	SUB	:	63	5A	Z	7A	z	Z	32
3B	;	1B	ESC	;	77	5B	[1C	FS	[61
3C	<	7B	{	<	72	5C	\	7C		\	75
3D	=	1D	GS	=	54	5D]	01	SOH]	62
						5E	^	7E	~	^	76
						5F	_	7F	DEL	_	65

†When these characters are copied from/or to a tape, the characters remain the same but the codes change from one code set to the other.

††These characters do not exist in 6-bit display code. Therefore, when the characters are copied from a tape, each 7-bit ASCII character is changed to an alternate 6-bit display code character. The corresponding codes are also changed. Example: When the system copies a lowercase a, 61₁₆, from tape, it writes an uppercase A, 01₈.

†††A 6-bit display code space always translates to a 7-bit ASCII space.

Table A-5. Nine-Track EBCDIC Coded Tape Conversion

EBCDIC				6-Bit Display Code		EBCDIC				6-Bit Display Code	
Code (Hex)	Char†	Code (Hex)	Char††	Char††	Code (Octal)	Code (Hex)	Char†	Code (Hex)	Char††	Char	Code (Octal)
40	space	00	NUL	space	55	C4	D	84	d	D	04
4A	¢	1C	IFS	[61	C5	E	85	e	E	05
4B	.	0E	SO	.	57	C6	F	86	f	F	06
4C	<	C0	{	<	72	C7	G	87	g	G	07
4D	(16	BS	(51	C8	H	88	h	H	10
4E	+	0B	VT	+	45	C9	I	89	i	I	11
4F		D0	}	!	66	D1	J	91	j	J	12
50	&	2E	ACK	&	67	D2	K	92	k	K	13
5A	!	01	SOH]	62	D3	L	93	l	L	14
5B	\$	37	EOT	\$	53	D4	M	94	m	M	15
5C	*	25	LF	*	47	D5	N	95	n	N	16
5D)	05	HT)	52	D6	O	96	o	O	17
5E	;	27	ESC	;	77	D7	P	97	p	P	20
5F	-	A1	-	-	76	D8	Q	98	q	Q	21
60	-	0D	CR	-	46	D9	R	99	r	R	22
61	/	0F	SI	/	50	E0	\	6A		\	75
6B	,	0C	FF	,	56	E2	S	A2	s	S	23
6C	%	2D	ENO	%	63	E3	T	A3	t	T	24
6D	%	2D	ENO	space†††	55	E4	U	A4	u	U	25
6E	>	1E	DEL	>	73	E5	V	A5	v	V	26
6F	?	1F	IUS	?	71	E6	W	A6	w	W	27
7A	:	3F	SUB	:	00	E7	X	A7	x	X	30
7A	:	3F	SUB	:	63	E8	Y	A8	y	Y	31
7A	:	3F	SUB	:	63	E9	Z	A9	z	Z	32
7A	:	3F	SUB	:	63	F0	0	10	DLE	0	33
7B	#	03	ETX	#	60	F1	1	11	DC1	1	34
7C	@	79	\	@	74	F2	2	12	DC2	2	35
7D	'	2F	BEL	'	70	F3	3	13	TM	3	36
7E	=	1D	IGS	=	54	F4	4	3C	DC4	4	37
7F	"	02	STX	"	64	F5	5	3D	NAK	5	40
C1	A	81	a	A	01	F6	6	32	SYN	6	41
C2	B	82	b	B	02	F7	7	26	ETB	7	42
C3	C	83	c	C	03	F8	8	18	CAN	8	43
						F9	9	19	EM	9	44

†When these characters are copied from/or to a tape, the characters remain the same (except EBCDIC codes 4A, 4F, 5A, and 5F) but the codes change from one code set to the other.

††These characters do not exist in 6-bit display code. Therefore, when the characters are copied from a tape, each EBCDIC character is changed to an alternate 6-bit display code character. The corresponding codes are also changed. Example: When the system copies a lowercase a, 81₁₆, from tape, it writes an uppercase A, 01₈.

†††All EBCDIC codes not listed translate to 6-bit display code 55₈ (space). A 6-bit display code space always translates to an EBCDIC space.

Table A-6. Seven-Track Coded Tape Conversions

External BCD	ASCII Character	6-Bit Display Code (Octal)	External BCD	ASCII Character	6-Bit Display Code (Octal)
01	1	34	40	-	46
02	2	35	41	J	12
03	3	36	42	K	13
04	4	37	43	L	14
05	5	40	44	M	15
06	6	41	45	N	16
07	7	42	46	O	17
10	8	43	47	P	20
11	9	44	50	Q	21
12†	0	33	51	R	22
13	=	54	52	!	66
14	"	64	53	\$	53
15	@	74	54	*	47
16†	%	63	55	'	70
17	[61	56	?	71
20	space	55	57	>	73
21	/	50	60	+	45
22	S	23	61	A	01
23	T	24	62	B	02
24	U	25	63	C	03
25	V	26	64	D	04
26	W	27	65	E	05
27	X	30	66	F	06
30	Y	31	67	G	07
31	Z	32	70	H	10
32]	62	71	I	11
33	,	56	72	<	72
34	(51	73	.	57
35	—	65	74)	52
36	#	60	75	\	75
37	&	67	76	^	76
			77	;	77

†As explained previously in this section, conversion of these codes depends on whether the tape is being read or written.

MESSAGES

B

This appendix lists alphabetically the dayfile messages of interest to the COMPASS applications programmer. If you encounter a diagnostic or informative message that does not appear in this appendix, consult the NOS Version 2 Diagnostic Index, which catalogs all messages produced by NOS and its products and specifies the manual or manuals in which each message is fully documented. Refer to Volume 3, System Commands, appendix B, for messages pertaining to general job processing.

In this appendix, lowercase characters are used to identify variable names or fields. All messages are sorted according to the first nonvariable word or character. Messages beginning with special characters (such as hyphens or asterisks) are sorted as if the special character(s) were not present. For example, the message

filenam ALREADY PERMANENT, AT addr.

is listed with the messages beginning with A, and the message

**** ENDING SUPPORT OF LFM FUNCTION nnB.

is listed with the messages beginning with E.

<u>MESSAGE</u>	<u>SIGNIFICANCE</u>	<u>ACTION</u>	<u>ROUTINE</u>
ACCESS CATEGORIES NOT VALID FOR JOB.	You attempted to use the SETPFAC command or macro to set one or more permanent file access categories for which you are not validated.	Retry using a set of access categories for which you are validated and that is valid for your job.	PFM
ACCESS LEVEL NOT VALID FOR FILE.	One of the following: <ul style="list-style-type: none"> - You attempted to save a local file using an access level for the permanent file that is not valid for the device on which the local file resides. - You attempted to define an existing local file as a direct access permanent file using an access level for the permanent file that is not valid for the device on which the local file resides. 	Retry using an access level for the permanent file that is not lower than the access level of the local file.	PFM
ACCESS LEVEL NOT VALID FOR JOB.	One of the following: <ul style="list-style-type: none"> - You attempted to save a local file at an access level that is not valid for your job. - You attempted to define an existing local file as a direct access permanent file at an access level that is not valid for your job. - You attempted to set an access level for a permanent file that is not valid for your job using the SETPFAL command or macro. 	Retry using a valid access level.	PFM
ACCESS LEVEL NOT VALID ON PF DEVICE.	On a SAVE, DEFINE, or SETPFAL command or macro, you specified an access level that is outside the range of access levels allowed on your permanent file device.	Inform security administrator that your permanent file device is not valid for all the access levels for which you are validated.	PFM
ACCOUNT BLOCK LIMIT.	The monitor detected the expiration of the account block SRU limit.	Reset account block SRU limit with SETASL command or macro. If the account block limit is set at its maximum, issue another CHARGE command to begin a new account block.	1AJ
ADDRESS OUT OF RANGE.	An address in a parameter block is outside the job's field length.	Specify parameter block address within field length.	LFM
filename ALREADY PERMANENT.	You have already saved or defined a file with the name specified.	Save or define file using different file name or purge existing file.	PFM
APPLICATION NAME IS REQUIRED.	You entered an APPSW command that did not specify a secondary application.	Reenter the command with the appl parameter specified.	TLX
ARG. ERROR.	LDR parameters were outside your job's field length or the central memory address in call is not within your job's field length.	Examine program to determine error.	LDR
ARITHMETIC INDEFINITE.	The CPU floating-point arithmetic unit attempted to use an indefinite operand.	Analyze the job output and dumps to determine the cause.	1AJ
ARITHMETIC OVERFLOW.	The CPU floating-point arithmetic unit received an operand too large for computation.	Analyze the job output and dumps to determine the cause.	1AJ
ARITHMETIC UNDERFLOW.	The CPU floating-point arithmetic unit received an operand too small for computation.	Analyze the job output and dumps to determine the cause.	1AJ
est, ASSIGNED TO filename.	Informative message specifying EST ordinal assigned to file filename.	None.	LFM
tttest, ASSIGNED TO filename.	Equipment type tt with EST ordinal est was assigned to file filename.	None.	LFM

<u>MESSAGE</u>	<u>SIGNIFICANCE</u>	<u>ACTION</u>	<u>ROUTINE</u>
jsn ASSIGNS EXCEED DEMANDS.	RESEX internal problems occurred. The resources actually assigned to the job with the specified job sequence name exceed the resources demanded on a RESOURC command.	Rerun the job. If the problem recurs, inform a site analyst, write a PSR and include support material so that CDC can duplicate the problem.	RESEX
ATTRIBUTE COMMANDS MUST BE OF ONE NETWORK TYPE.	Terminal attributes unique to NAM/CCP and to NAM/CDCNET were specified on the same TRMDEF command.	On the TRMDEF command, check to ensure that all terminal attributes are supported by your network type.	TRMDEF
BAD CATALOG/PERMIT SECTOR.	PFM has encountered a catalog or permit sector which does not have a valid sector length. This indicates corruption of system areas on disk.	Inform site analyst. If many of these errors occur, the site analyst should perform a full PFDUMP, total INITIALIZE, and full PLOAD on the device.	PFM
BLANK TAPE, filename AT address.	A blank tape was read. Blank tape is defined as more than 25 feet of erased tape.	Ensure correct tape is specified on command.	1MT
BLOCK SEQUENCE ERROR, filename AT address.	The block length recorded in the file did not match the length of the block read, or the block number recorded in the file did not match the system block count (this message applies to I format tapes only).	Ensure accuracy of format parameter (F) on command or macro.	1MT
BLOCK TOO LARGE, filename AT address.	The tape being read contained a data block greater in size than that allowed by the specified format or by your specification.	Ensure accuracy of format parameter (F) on command or macro.	1MT
BOT/EOT ENCOUNTERED, filename AT address.	Indicates an abnormal tape position.	Inform site analyst if persistent.	1MT
BREAKPOINT CONDITION.	The job executed an address for which a breakpoint was requested by the system.	Inform software support.	1AJ
BUFFER ARG. ERROR.	CM address in call is not less than the field length minus the word count; buffer extends past the job's field length.	Verify that operation does not reference address beyond end of buffer or job's field length.	1AJ TCS
BUFFER ARGUMENT ERROR, filename AT address.	For tape operations, this message indicates one of the following: - FET less than 7 words long for S/L format - MLRS greater than 1000 octal for S format - POSMF issued and no HDR1 label found in FET or extended label buffer	Examine program to determine error.	1MT
BUFFER CONTROL WORD ERROR, filename AT address.	Either an attempt was made to write a block smaller than the noise size on an S, L, or F format tape, or a control word error occurred in a write (such as bad byte count).	Examine program to determine error.	1MT
BUFFER CONTROL WORD ERROR ON filename AT address.	Block length specified on WRITECW operation exceeds the allowable physical record size for the device.	Correct the program that is formatting the data for the WRITECW operation.	1MS
pfn BUSY.	The specified direct access file is currently attached in an incompatible mode, or is already being accessed by 4095 users in your specified mode (R, RA, RU, or RM).	Reissue ATTACH until file becomes available, or issue ATTACH specifying WB option.	PFM
CHANNEL MALFUNCTION, filename AT address.	A hardware malfunction occurred.	Inform site analyst.	1MT
CHECKPOINT nnnn COMPLETE.	Indicates that checkpoint nnnn has completed. Issued if only one checkpoint file is present.	None.	CHKPT
CHECKPOINT nnnn COMPLETED TO filename.	Indicates that checkpoint nnnn has been completed to file filename. Issued if alternate CB checkpoint files are used.	None.	CHKPT

<u>MESSAGE</u>	<u>SIGNIFICANCE</u>	<u>ACTION</u>	<u>ROUTINE</u>
CHECKPOINT FILE ACCESS LEVEL ERROR.	In a secure system, the checkpoint file access level is not the same as the job access level limit. This is to insure that the checkpoint file is secure enough to contain all local files. The access level of the checkpoint file is not changed to this level since this is not possible for magnetic tape files or direct access permanent file, and these are the usual file types used for checkpoint files.	Insure that the access level of the checkpoint file is the same as the job access level upper limit.	CHKPT
CHKPT UNABLE TO READ TAPE.	Indicates a tape file had an unrecovered parity error when CHKPT tried to write it to the checkpoint file.	None.	CHKPT
CIO ERROR nn ON filename.	A CIO error with octal error code nn occurred while RESEX was trying to open tape file filename.	Use a different tape.	RESEX
CIO ERROR.	Updating of resource file returned error status other than end-of-device.	Rerun the job. If the problem recurs, inform a site analyst, write a PSR and include support material so that CDC can duplicate the problem.	RESEX
CKP REQUEST.	A checkpoint has been initiated.	None.	CHKPT
CM BLOCK OUT OF RANGE.	Data transfer from extended memory specified a CM address outside the job field length.	Analyze the job output and dumps to determine the cause.	1AJ
CM OR EC REQUEST EXCEEDS MAXIMUM.	Field length of more than 77000 octal (CM) or more than 7777 octal (EM) was specified in RFL command.	Retry with lower value(s).	CONTROL
CM OUT OF RANGE.	The program referenced an address outside the job CM field length.	Analyze job output and dumps to determine the cause.	1AJ
CM PARITY ERROR.	Double data parity error (two data bits failed) between central memory control (CMC) and CM as detected by the single-error correction double-error detection (SECDED) network, or a single parity error when operating in default mode (SECDED network disabled).	Inform customer engineer.	1AJ
CM RANGE EXIT MODE NOT DESELECTABLE.	You attempted to deselect system checking for CM out of range errors. This cannot be done on a model 176.	Determine if the program can run with CM range error checking. If it cannot, the program must be changed.	CPM
CMC PARITY ERROR.	The CPU sent the central memory control (CMC) data or an address having incorrect parity.	Inform customer engineer.	1AJ
CONNECT REJECT, filename AT address.	The system was unable to connect a peripheral device.	Inform site analyst.	1MT
CONTENTS NOT CHECKPOINTED FOR FILE xxxxxxx	A CHECKPT macro call or a CKP RA+1 call was made and file xxxxxx is a tape file appearing in the parameter list of the request. The manner in which the file was selected for processing was other than f=4 (position information only). Since magnetic tapes are not copied to the checkpoint file, only the position information was copied (f=4 was forced). Thus, it will be necessary to assign the tape to the restart job. If the contents of the tape is destroyed, it may not be possible to restart the checkpoint job correctly.	Save the tape for the restart job without altering the tape contents from the time of the checkpoint. To eliminate the message, select f=4 for tape files.	RESTART
CONTROL *QAC* ERROR nnn.	A system error was encountered while making a QAC monitor request.	Write a PSR and include support materials to allow CDC to duplicate the problem.	CONTROL
CONTROLLED BACKSPACE ERROR, filename AT address.	Controlled backspace operation failed during write error recovery. Position of tape is uncertain.	Inform customer engineer.	1MT
CPM - ACCESS LEVEL NOT VALID FOR JOB.	You attempted to change the job access level to a value not valid for the job.	Retry with a valid level.	CPM
CPM - ARGUMENT ERROR.	An incorrect argument was specified.	Retry the command using valid arguments.	CPM

<u>MESSAGE</u>	<u>SIGNIFICANCE</u>	<u>ACTION</u>	<u>ROUTINE</u>
CPM - INCORRECT PACK NAME.	An incorrect pack name has been specified.	Ensure that a valid pack name is used.	CPM
CPM - INCORRECT REQUEST.	A job was incorrect CPM function code, subfunction code was specified, or extended reprieve is set (for EREXIT).	Specify auto recall on monitor request call to CPM.	CPM
CPM - INVALID PAGE VALUE.	There was an error in your job page size information.	Retry with correct values.	CPM
CPM - LIBRARY NOT FOUND = Library.	The system could not find the specified library.	Ensure that the library name is correct on the command or macro.	CPM
CPM - MASS STORAGE ERROR.	A non-recoverable mass storage error is detected by CPM when attempting to access a mass storage device, or a recoverable mass storage error has occurred during a disk access attempt, causing the job to roll out and wait for the device to be repaired.	Repair the device and retry.	CPM
CPM - MASS STORAGE ERROR.	One of the following: - A nonrecoverable error occurred when your job attempted to access a mass storage device. - Your job was aborted after being rolled out due to a recoverable mass storage device error.	Inform site analyst.	CPM
CPM - MISSING *SHELL* LOAD OPTION.	You attempted to set a shell control without specifying a load option.	Specify a load option in the shell command or macro and try again.	CPM
CPM - SECONDARY USER COMMANDS DISABLED.	You entered a secondary USER command on a system that has had secondary USER commands disabled.	None.	CPM
CPM - SYSTEM ERROR.	For function 42 (Special Charge) or 106 (Set Job Characteristics), CPM was unable to read the input file.	Write a PSR and include support materials to allow CDC to duplicate the problem.	CPM
CPM - USER ACCESS NOT VALID.	1. You tried to perform a CPM operation for which you are not authorized. 2. A CPU program issued a DSDOUT or a DSDINP macro request when it did not have access to the L display CMR buffers.	Ensure that the L display utility was initiated at the system console with the appropriate commands.	CPM
CPU ERROR EXIT AT address.	The errors listed after this message occurred at address, causing job step termination.	Refer to the descriptions of the error messages issued with this message.	1AJ
CVL CALL ERROR.	If CVL was called by a user via GETMC, CVL encountered one of the following errors while processing the GETMC macro: - Recall bit was not set. - Illegal function number was specified. - Insufficient or improper combination of parameters was specified. If CVL was called by a CE via CEVAL, CVL encountered one of the following errors while processing the CEVAL macro: - Recall bit was not set. - Illegal function number was specified. - Insufficient or improper combination of parameters was specified. - The CE supplied mnemonic does not match the preassigned tape mnemonic when CVL was called by preassignment. - A tape was not preassigned when CVL was called by preassignment. - The CE attempted to load tape controlware when CVL was called by preassignment. - A labeled tape was preassigned when CVL was called by preassignment.	Correct error and rerun program.	CVL
DATA/PERMIT ERRORS.	When the specified file was loaded from tape, errors were encountered in both data and permit information.	Enter CHANGE command or macro with CE parameter to allow access to the file. Make the file local and check if data is accurate. Enter a CATLIST command to see if the permits are accurate.	PFM

<u>MESSAGE</u>	<u>SIGNIFICANCE</u>	<u>ACTION</u>	<u>ROUTINE</u>
DATA TRANSFER ERROR.	An error occurred in a read operation during a file transfer.	Inform site analyst. If many of these errors occur, the site analyst should perform a full PFDUMP, total INITIALIZE, and full PFLoad on the device.	PFM
DBest,DNdn,message.	A form of PFM error message (issued to the system dayfile, error log, and sometimes the user dayfile) identifying the mass storage equipment on which the error occurred. The equipment type DB is 885-42 disk (full track). est EST ordinal of device. dn Device number. message PFM error message.	Refer to the significance and action of the message as given in this list of error messages.	PFM
DEFAULT FAMILY USED.	You entered a FAMILY command with no parameter. The default family was used.	None.	CONTROL
DEMAND EXCEEDED.	You attempted to assign more units than were scheduled on the RESOURC command.	Increase appropriate parameter value on RESOURC command.	RESEX
DEMAND FILE ERROR.	Resource execution error was encountered. This error occurred because the demand file (RSXDid) entry does not match the job identification.	Rerun the job. If the problem recurs, inform a site analyst, write a PSR and include support material so that CDC can duplicate the problem.	RESEX
DEVICE ERROR ON FILE filename AT address.	An irrecoverable error occurred on the mass storage device containing the file filename.	Inform customer engineer.	IMS
DEVICE INACCESSIBLE - DETACH FAILED.	Your job could not be detached due to a mass storage device error.	Inform site analyst.	IAFEX
DEVICE INACCESSIBLE - LOGIN FAILED.	Login failed because of mass storage device error.	Inform site analyst.	IAFEX
DEVICE UNAVAILABLE.	One of the following: - A packname was specified for a pack that is not currently mounted. - For a DIS job, no SUI or USER command has been entered. - No permanent file device could be found for your user name. - On a secure system, no permanent file device with the proper access level could be found for your user name.	If a packname was specified, try again with the WB or NA parameter to request that the pack be mounted. For other errors, inform site operator.	PFM
DIest,DNdn,message.	A form of PFM error message (issued to the system dayfile, error log, and sometimes the user dayfile) identifying the mass storage equipment on which the error occurred. The equipment type DI is 844-21 disk (half track). est EST ordinal of device. dn Device number. message PFM error message.	Refer to the significance and action of the message as given in this list of error messages.	PFM
DIRECT ACCESS DEVICE ERROR.	One of the following occurred: - An incorrect device type was specified. - The device on which the local file resides may not contain direct access files.	Specify correct device type, or return the local file and retry.	PFM
DIRECT ACCESS FILE ERROR.	The system sector for the file contains incorrect data or cannot be read.	Inform site analyst. If many of these errors occur, the site analyst should perform a full PFDUMP, total INITIALIZE, and full PFLoad on the device.	PFM
DJest,DNdn,message.	A form of PFM error message (issued to the system dayfile, error log, and sometimes the user dayfile) identifying the mass storage equipment on which the error occurred. The equipment type DJ is 844-41/44 disk. est EST ordinal of device. dn Device number. message PFM error message.	Refer to the significance and action of the message as given in this list of error messages.	PFM

<u>MESSAGE</u>	<u>SIGNIFICANCE</u>	<u>ACTION</u>	<u>ROUTINE</u>
DKest,DNDn,message.	A form of PFM error message (issued to the system dayfile, error log, and sometimes the user dayfile) identifying the mass storage equipment on which the error occurred. The equipment type DK is 844-21 disk (full track). est EST ordinal of device. dn Device number. message PFM error message.	Refer to the significance and action of the message as given in this list of error messages.	PFM
DLest,DNDn,message.	A form of PFM error message (issued to the system dayfile, error log, and sometimes the user dayfile) identifying the mass storage equipment on which the error occurred. The equipment type DL is 844-41/44 disk (full track). est EST ordinal of device. dn Device number. message PFM error message.	Refer to the significance and action of the message as given in this list of error messages.	PFM
DMest,DNDn,message.	A form of PFM error message (issued to the system dayfile, error log, and sometimes the user dayfile) identifying the mass storage equipment on which the error occurred. The equipment type DM is 885-11/12 disk (half track). est EST ordinal of device. dn Device number. message PFM error message.	Refer to the significance and action of the message as given in this list of error messages.	PFM
DQest,DNDn,message.	A form of PFM error message (issued to the system dayfile, error log, and sometimes the user dayfile) identifying the mass storage equipment on which the error occurred. The equipment type DQ is 885-11/12 disk (full track). est EST ordinal of device. dn Device number. message PFM error message.	Refer to the significance and action of the message as given in this list of error messages.	PFM
DSP - CANNOT ROUTE JOB INPUT FILE.	An attempt was made to route the job input file.	Copy job input file to a local file and route it.	DSP
DSP - COMPLETE BIT ALREADY SET.	The complete bit was not cleared before DSP was called.	Clear complete bit before calling DSP.	DSP
DSP - DEFERRED ROUTING NOT ALLOWED.	A file cannot be deferred/routed if data declaration, or implicit/explicit remote text is specified.	Correct and retry.	DSP
DSP - DEVICE FULL.	There is no space on the device for current use.	Retry route at a later time.	DSP
DSP - DEVICE UNAVAILABLE.	DSP attempted to create a file on a device that was turned off or is currently unavailable for access.	Specify different device or contact site operator.	DSP
DSP - FILE NAME ERROR.	An attempt was made to create a file with an incorrect file name.	Specify valid file name.	DSP
DSP - FILE NOT ON MASS STORAGE.	An attempt was made to route a file not on mass storage.	Copy file to mass storage before routing.	DSP
DSP - FILE ON REMOVABLE DEVICE.	A file on a removable device cannot be routed.	Copy file to nonremovable device before routing.	DSP
DSP - FOMSM CODE NOT ALPHANUMERIC.	The forms code specification (FC=fc parameter) must consist of two alphanumeric characters.	Specify alphanumeric forms code.	DSP
DSP - I/O SEQUENCE ERROR.	A request was made on a busy file.	Wait until file is not busy.	DSP
DSP - IMMEDIATE ROUTING - NO FILE.	The specified file for the immediate routing could not be found.	Ensure that file to be routed is available to job for processing.	DSP
DSP - INCORRECT DISPOSITION CODE.	Specified disposition code is not recognized.	Verify disposition code.	DSP
DSP - INCORRECT EXTERNAL CHARACTERISTICS.	You specified an undefined external characteristic code.	Verify external characteristic code.	DSP
DSP - INCORRECT FILE TYPE.	The file being processed is not a queued file or a local file.	Ensure the file being processed is of the correct type.	DSP

<u>MESSAGE</u>	<u>SIGNIFICANCE</u>	<u>ACTION</u>	<u>ROUTINE</u>
DSP - INCORRECT INTERNAL CHARACTERISTICS.	You specified an undefined internal characteristics code.	Verify internal characteristics code.	DSP
DSP - INCORRECT JOB ABORT CODE.	Value of abort code field of DSP parameter word four is incorrect.	Verify abort code.	DSP
DSP - INCORRECT ORIGIN TYPE.	The system cannot queue the file for input with the specified origin type.	Specify valid origin type.	DSP
DSP - INCORRECT REQUEST.	One of the following: - Parameter block is not within field length. - Request was not made with auto recall.	Change parameter block addresses or specify auto recall.	DSP
DSP - INCORRECT SERVICE CLASS	The two-character service class is not valid for the user or the origin type of the file.	Correct and retry.	DSP
DSP - INCORRECT SPACING CODE.	Value specified for spacing code was greater than 77 octal.	Verify spacing code.	DSP
DSP - INCORRECT TID.	One of the following: - Username and familyname parameters were not in CM field length. - Terminal identifier (TID) is greater than or equal to IDLM for batch jobs. - The familyname or username is not valid.	Verify that TID parameters are valid.	DSP
DSP - INCORRECT USER COMMAND.	For an operation on an input file, either a USER command was not included, or the user name or password on USER command is not valid.	Verify that a USER command is present and that the user name and password are correct.	DSP
DSP - INVALID FILE MODE.	The file being processed is attached in execute-only mode.	Return the file and reattach it in other than execute-only mode.	DSP
DSP - MASS STORAGE ERROR.	A mass storage error was encountered on the file.	Write a PSR and include support materials to allow CDC to duplicate the problem.	DSP
DSP - QUEUED FILE READ ERROR.	DSP encountered an error while trying to read the system sector for a previously deferred routed file.	Attempt to recreate the output file.	DSP
DSP - ROUTE TO INPUT NOT IMMEDIATE.	You attempted to queue a file for input using a deferred ROUTE.	Change to immediate route.	DSP
DSP - THIS ROUTING NOT ALLOWED.	You attempted to change the queue disposition of a deferred routed file.	Rescind prior routing by using the SC disposition code with the ROUTE command or macro. Route the file again with the desired final disposition code.	DSP
DSP - TOO MANY DEFERRED BATCH JOBS.	You attempted to submit more deferred batch jobs than allowed by your validation limit.	Wait for jobs to complete or request a larger validation limit from site personnel.	DSP
DSP - UNDEFINED SERVICE CLASS.	The two-character service class is not defined.	Correct and retry.	DSP
DSP - USER ACCESS NOT VALID.	Caller is not validated to specify one of the following: DLID SLID Data declaration	Write a PSR and include support materials to allow CDC to duplicate the problem.	DSP
DUPLICATE FILE NAME.	The file specified already exists in the system.	Use different name in request.	LFM
DUPLICATED LINES.	Duplicate lines, which would have been printed during a dump operation, were suppressed.	None.	CPMEM
DVest,DNDn,message.	A form of PFM error message (issued to the system dayfile, error log, and sometimes the user dayfile) identifying the mass storage equipment on which the error occurred. The equipment type is 819 disk (single density). est EST ordinal of device. dn Device number. message PFM error message.	Refer to the significance and action of the message as given in this list of error messages.	PFM

<u>MESSAGE</u>	<u>SIGNIFICANCE</u>	<u>ACTION</u>	<u>ROUTINE</u>
DWest,DNdn,message.	A form of PFM error message (issued to the system dayfile, error log, and sometimes the user dayfile) identifying the mass storage equipment on which the error occurred. The equipment type DW is 819 disk (double density). est EST ordinal of device. dn Device number. message PFM error message.	Refer to the significance and action of the message as given in this list of error messages.	PFM
EC NOT VALIDATED.	The number of extended memory blocks specified on the Job command either exceeds that for which you are authorized or exceeds the machine size available to user jobs.	Check your validation with the LIMITS command.	CPM
ECS LOAD ERROR.	An error occurred during ECS load.	Inform site analyst.	1AJ
filename EMPTY.	The file specified on a SAVE command contains no data.	Verify that file contains data and retry.	PFM
ELM - ARGUMENT ERROR.	ELM was called with an incorrect device code or error block address.	Check the program that made the call.	ELM
ELM - EXTENDED MEMORY NOT ASSIGNED.	A call was made to ELM with no extended memory assigned to the job.	Check the job for extended memory assignment.	ELM
ELM - DAYFILE MESSAGE LIMIT.	The caller's dayfile limit was reached during ELM processing.	None.	ELM
END OF TAPE, filename AT address.	The end-of-tape was encountered.	Ensure that correct file manipulation operation is specified.	1MT
ENTRY POINT NOT FOUND.	The specified entry point could not be found.	Verify that entry point is valid.	1AJ
EOI CHANGED BY RECOVERY.	The file was truncated during deadstart recovery.	Use CHANGE command or macro with CE parameter to allow access to the file. Make the file local and list it to determine how much of the file was lost.	PFM
EQest xx ERROR RETRY UNDERWAY	An error has occurred while attempting to read data from, or write data to, a mass storage device; a recovery attempt is in progress. est EST ordinal of the mass storage device in use when the error occurred. xx Error type (one of the following): CH Channel parity error CS Controller stop error RA Controller memory error FT Function timeout error PE Parity error AD Address error ST Device status error RS Device reserved error CR Controller reserved error NR Device not ready error	Resubmit the job. If the error recurs, inform site analyst or customer engineer.	6DI 6DP 6DE 6DX 1MC ELM
EQest xx ERROR RETRY UNDERWAY	An error has occurred while attempting to read data from, or write data to, a mass storage device; a recovery attempt is in progress. est EST ordinal of the mass storage device in use when the error occurred. xx Error type (one of the following): CH Channel parity error CS Controller stop error RA Controller memory error FT Function timeout error PE Parity error AD Address error ST Device status error RS Device reserved error CR Controller reserved error NR Device not ready error	Resubmit the job. If the error recurs, inform site analyst or customer engineer.	6DI 6DP 6DE 6DX 1MC ELM
EQUIPMENT NOT AVAILABLE.	The requested equipment is either in use or does not exist, or no requested equipment with the proper access level can be found.	Ensure accuracy of macro or command or retry at a later time.	LFM RESEX

<u>MESSAGE</u>	<u>SIGNIFICANCE</u>	<u>ACTION</u>	<u>ROUTINE</u>
ERASE LIMIT, filename AT address.	The system made 20 erasures (10 feet of tape) without being able to successfully write the tape.	Clean tape or use different tape.	1MT
ERROR CODE ec, filename AT address.	1MT error code ec has occurred but no specific message is issued. This would normally not occur unless the job was dropped by the operator.	Inform site analyst.	1MT
ERROR - FILES(S) NOT PROCESSED.	One or more files were not checkpointed because CHKPT detected an error while getting a list of the files at the control point. This could occur if there are many local files.	Contact Central Software Support.	CHKPT
ERROR FLAG TERMINATION, filename AT address.	The job was aborted with a tape operation in progress. The operation/request is not complete. For example, the operator could kill the job while tape error recovery is in progress.	None.	1MT
ERROR FLAG TERMINATION, FILE filename AT address	The job was aborted with an input/output request in progress. The operation/request is not complete.	None.	1MS
ERROR IN FILE DATA.	When the specified file was loaded from tape, an error was encountered in the data.	Enter CHANGE command or macro with CE parameter to allow access to the file. Make the file local and ensure the accuracy of the data.	PFM
ERROR IN PERMIT DATA.	When the specified file was loaded from tape, an error was encountered in the permit entries.	Enter CHANGE command or macro with CE parameter to allow access to the file. Do a CATLIST to see if the permits are accurate.	PFM
ERROR IN ROUTE FUNCTION, LFN=filename.	Informative message issued to the system dayfile indicating that an error occurred while routing filename.	Examine the job's dayfile for a more specific error message.	DSP
ERROR ON FILE - PROFILA.	Either the profile file cannot be found or there is a bad profile file level-3 block random address.	Inform site analyst.	CPM
ERROR PROCESSING LIMIT.	Following an error, a job has tried to restart itself more than 512 times.	None.	1AJ
EXCHANGE PACKAGE/MEMORY DUMP ON FILE ZZZDUMP.	The exchange package and memory dump is written on local file ZZZDUMP because the job is of interactive origin and file OUTPUT is assigned to a terminal.	To examine the exchange package and dump, list file ZZZDUMP.	CPMEM
EXTENDED MEMORY BLOCK OUT OF RANGE.	Data transfer between CM and extended memory specified an extended memory address outside the job field length.	Analyze the job output and dumps to determine the cause of the error.	1AJ
EXTENDED MEMORY FLAG REGISTER PARITY.	Parity error detected on extended memory flag register operation.	Inform customer engineer.	1AJ
EXTENDED MEMORY OUT OF RANGE.	Job referenced extended memory address outside job field length.	Analyze the job output and dumps to determine the cause of the error.	1AJ
EXTENDED MEMORY PARITY ERROR.	ECS transfer on a model 176 failed.	Inform customer engineer.	1AJ
FAMILY NOT FOUND.	No family exists with the name you specified.	Retry with an existing family name.	CONTROL
FET ADDRESS OUT OF RANGE AT address.	FET extends past job's field length or FET address .LE. 1.	Verify that FET address is valid.	1MS
FET PARAMETER ERROR ON filename AT address.	A parameter in the FET is incorrect or the FET is not long enough for the parameter.	Verify that FET is valid.	1MS
FET TOO SHORT.	FET is not long enough for processing by requested function.	Increase FET size.	LFM
FIELD BEGINNING AT nn NO COMPARE.	Verification of label field at character position nn does not compare with that specified by the user on an OPEN statement.	None.	1MT
FILE BOI/EOI/UI MISMATCH.	Data in the system sector for file filename does not match information from the EOI sector and/or catalog information. This indicates that the file has been destroyed.	Inform site analyst. If many of these errors occur, the site analyst should perform a full PFDUMP, total INITIALIZE, and full PFLOAD on the device.	PFM

<u>MESSAGE</u>	<u>SIGNIFICANCE</u>	<u>ACTION</u>	<u>ROUTINE</u>
FILE EMPTY.	The file specified was empty.	Verify that the file contains data and retry.	LFM SFM
FILE ERROR filename.	An incorrect address was detected on file filename.	Correct error and retry.	RESTART
FILE/JOB NOT FOUND.	The specified file or job was not found in the system.	Use the ENQUIRE command to ensure job is still in the system.	CONTROL
FILE LENGTH ERROR.	The length of a file does not equal the length specified in the catalog. This indicates that the file has been destroyed.	Inform site analyst. If many of these errors occur, the site analyst should perform a full PFDUMP, total INITIALIZE, and full PFLoad on the device.	PFM
FILE NAME ERROR.	File name contains incorrect characters or contains more than seven characters.	Ensure that a valid file name is specified.	LFM LISTLB PFM
FILE NOT DISK RESIDENT.	Access to a file which does not reside on disk is not permitted with the requesting function.	Write a PSR.	PFM
FILE NOT ON MASS STORAGE.	The specified file does not reside on mass storage.	Copy file to mass storage and retry.	1AJ
FILE TOO LONG.	The local file specified for a SAVE, REPLACE, or APPEND command exceeds the length allowed or the direct access file specified for an ATTACH operation in WRITE, MODIFY, UPDATE, or APPEND mode exceeds the direct access file length limit for which you are authorized.	Reduce length of file or save as a direct access file.	PFM
FILE TOO LONG, FILE filename AT address.	The length of the direct access permanent file currently being written exceeds the direct access file length limit for which you are authorized.	Reduce the length of the file or ask site personnel for a larger direct access file length limit.	1MS
FL REQUEST BEYOND MFL (ECS).	Extended memory field length requirements for the job step exceed the extended memory field length allowed.	Increase job step extended memory field length.	1MA
FL TOO SHORT FOR PROGRAM.	The job's field length is too short for the program.	Rerun the job with larger field length specification.	1AJ 1AJ
FILE TOO SHORT FOR LOAD.	You attempted to load extended memory data beyond the job's extended memory field length.	None.	1AJ
FNT FULL.	FNT space is currently not available for a request that has both the ep and up processing options set.	Return some files and retry operation.	PFM
FORMAT REQUIRES UNLABELED TAPE.	The format specified (F) is valid only for unlabeled tapes.	The tape must be assigned as an unlabeled tape.	RESEX
FUNCTION REJECT, filename AT address.	Function was rejected (possible hardware problem).	Inform site analyst.	1MT
FWA .GE. LWA+1.	The first word address parameter was greater than the last word address parameter on DMP, DMD, DMPECS, DMDECS, LOC, or PBC command or DMP, DMD, DED, or DEP system requests.	Correct error and retry.	CPMEM
FWA/LWA .GE. FL.	Either first word address parameter of LOC or the last word address of LOC or PBC was greater than or equal to your field length.	Reduce FWA and/or LWA and retry.	CPMEM
GETFNT TABLE TOO LARGE.	The table generated by the GETFNT macro is too large to fit in the job's field length.	Specify larger GETFNT table size.	LFM
HARDWARE RERUN THRESHOLD EXCEEDED	A job will be rerun a maximum of n-1 times due to a hardware error. The default for n is 2 (defined by HRTL in common deck COMSMSC).	Analyze job dumps, maintenance registers and the error log to determine cause.	1AJ

<u>MESSAGE</u>	<u>SIGNIFICANCE</u>	<u>ACTION</u>	<u>ROUTINE</u>
HTIME NOT AVAILABLE.	The HTIME command or macro is valid only on a model 176.	None.	1AJ
I/O ON EXECUTE-ONLY FILE filename AT address.	Your job issued a CIO function not allowed on an execute-only file.	Attach file in proper mode to allow the desired operation.	1MS
I/O SEQUENCE ERROR.	Action was requested on a busy local file.	Write a PSR.	LFM PFM 1AJ
I/O SEQUENCE ERROR ON FILE filename AT address.	You attempted to perform a function on a local file before another function on the same file was complete.	Modify program to wait until each function is complete before attempting another.	1MS
IMPROPER ACCESSIBILITY.	You did not specify the correct file accessibility on the LABEL command or macro, or volume accessibility was set and you attempted to assign the tape as unlabeled from a nonsystem origin job.	Ensure accuracy of request.	RESEX
INCORRECT ACCESS LEVEL FOR EQUIPMENT.	You have specified a level outside of the equipment access level limits.	Use access level within required equipment's access level limits, or use equipment with access level required.	RESEX
INCORRECT APPLICATION ACCOUNTING REQUEST.	The application program that issued this message attempted to initiate application accounting incorrectly.	Inform data base administrator.	CPM
INCORRECT COMMON MEMORY MANAGER REQUEST.	A memory request was issued with reserved bits in the parameter block set.	Do not set reserved bits.	1MA
INCORRECT DEVICE REQUEST.	The device type (R parameter) specified on a request for an auxiliary device cannot be recognized or does not exist in the system. If the auxiliary device specified by the PN parameter is not the same type as the system or job default, the R parameter must be included.	Examine auxiliary device request and ensure its accuracy.	PFM
INCORRECT END OF JOB OPTION SPECIFIED.	The option specified is not valid for a noninteractive job.	Retry with a different option.	CPM
INCORRECT EQUIPMENT.	Equipment specified does not exist or is not allowed (for example, an interactive terminal is requested from other than interactive origin, or a tape is being requested with the REQUEST macro).	Ensure that file resides on a legal equipment type.	LFM RESEX
INCORRECT EQUIPMENT ON FILE filename AT address.	A system error.	Inform site analyst.	1MS
INCORRECT ERROR EXIT ADDRESS.	Error exit address is beyond the job's current field length.	None.	1AJ
INCORRECT EXTERNAL CALL.	RESEX did not recognize an external call.	Inform site analyst.	RESEX
INCORRECT FILE MODE.	You tried to unlock a file that was attached in execute-only mode.	None.	LFM
INCORRECT FILE NAME filename AT address.	The file name does not conform to the rules. The file name must have a maximum of seven alphanumeric characters, left-justified, with binary zero fill.	Use valid file name.	1MS
INCORRECT FILE STATUS.	Specified file status is incorrect.	Check value.	LFM
INCORRECT FILE TYPE.	The specified file is of a type not allowed in the requested operation. Possible causes include attempts to - Change a nonlocal file to file type library. - Designate a direct access file as the primary file. - Route the primary file. - Change access level of nonlocal file.	Verify that file type is appropriate.	LFM
dfn INCORRECT FILE TYPE.	The operation requested cannot be performed on the specified file because it is of the wrong file type. This message is issued when you 1) attempt to define a direct access file with the same local file name as a file currently assigned to the job that is of a file type other than local, or 2) the local file being saved is a direct access file attached in read/allow modify or read/allow append mode.	1) Define the file using a unique name, or 2) Return the file and reattach it in a different mode.	PFM

<u>MESSAGE</u>	<u>SIGNIFICANCE</u>	<u>ACTION</u>	<u>ROUTINE</u>
INCORRECT I/O REQUEST ON FILE filename AT address.	The system could not recognize the specified function code, or the code was not valid for the type of device to which the file was assigned. You attempted to write on a local file that resides on a device whose highest access level is below the current access level of your job. The system provides a dump of the FET on file OUTPUT.	Verify CIO function code being used. Lower the access level of your job, if possible, or raise the access level of the file.	1MS
INCORRECT ID CODE.	An identification code not in the range 0-67B or 77B is present on the LDI command.	Reissue the request with the correct identification code.	LDI
INCORRECT INSTRUCTION.	The CPU attempted to execute an incorrect or unavailable instruction.	Analyze job output and dumps to determine the cause of the error.	1AJ
INCORRECT LABEL TYPE, filename AT address.	Incorrect label type. The only valid label types are ANSI labeled and nonstandard labeled.	Use correct label type.	1MT
INCORRECT LOAD ADDRESS.	The load address is less than 2.	Specify larger load address and retry.	1AJ
INCORRECT MODIFICATION OF filename AT address.	Either you have attempted to shorten a modify-only file or the file cannot be modified at all.	Determine whether file can be modified.	1MS
INCORRECT RANDOM ADDRESS.	The current random address specified is zero.	Verify current random address.	LFM
INCORRECT USER ACCESS.	You are not authorized to access a restricted subsystem without proper validation.	Determine proper validation requirements.	EXINIT
INDEX ADDRESS OUT OF RANGE FOR filename AT address.	The random sector address for a random input/output request was equal to or greater than the job's field length.	Correct random sector address.	1MS
INDEX TOO LARGE ON OPEN, FILE filename AT address.	For an OPEN function, the random index length exceeded the index buffer size.	Set EP bit in FET+1 to get error status without abort or increase index buffer size.	1MS
INPUT FILE IN NO RERUN STATUS.	Informative message.	None.	QFM
INPUT FILE IN RERUN STATUS.	Informative message.	None.	QFM
INPUT LOST, REENTER LAST LINE	Your 1st line of input was lost due to an IAF internal error.	Reenter the last line. If the error recurs, inform site analyst or customer engineer.	IAFEX
INSUFFICIENT RESOURCES ON SYSTEM.	Resource demand exceeds the number of units physically available on the system.	Reduce resource demand.	RESEX
INTERLOCK NOT AVAILABLE.	A software interlock is currently not available to the requesting function with both ep and up processing options specified.	Retry function at a later time.	PFM
pfn INTERLOCKED.	The file is currently not available for WRITE, MODIFY, UPDATE, or APPEND modes of access because a system utility has attached the file in utility mode.	Retry operation later.	PFM
INVALID FILE ACCESS LEVEL.	The access level specified in the FET for an LFM request is not valid for that user, or for the equipment on which the file resided.	Correct the access level and retry.	LFM
pfn IS DIRECT ACCESS.	An indirect access file operation was attempted on a direct access file.	Use the appropriate direct access file request.	PFM
filename IS EXECUTE ONLY.	The specified local file cannot be accessed by SAVE, REPLACE, APPEND or DEFINE since it is an execute-only file.	None.	PFM
pfn IS INDIRECT ACCESS.	A direct access file operation was attempted on an indirect access file.	Use the appropriate indirect access file request.	PFM
ITF, CONNECTING TO HOST pid.	Indicates state of connection to host pid.	None.	ITF
JOB CANNOT ACCESS FILE.	The permanent file being processed has either an access level or access categories that are not valid for your job.	None. Your job can not access the file.	PFM

<u>MESSAGE</u>	<u>SIGNIFICANCE</u>	<u>ACTION</u>	<u>ROUTINE</u>
JOB CARD ERROR (jobcmdnd)	The Job command of a routed job contains an error. jobcmdnd is the first 20 characters of the Job command in error.	Correct the Job command and retry.	DSP
JOB IN NORERUN STATE ON RECOVERY.	Identifies a job recovered on level 0 or level 3 deadstart that was aborted because it was in a no-rerun mode (due to NORERUN command or macro).	Refer to the NORERUN command or macro description.	1AJ
JOB NOT RERUN.	The system was unable to successfully rerun a job because of a mass storage read error or because the QFT is full.	Resubmit the job to the system.	1AJ
JOB REPRIEVED.	The job has been successfully reprieved.	None.	1AJ
JOB RERUN.	The job has been terminated and requeued for input.	None.	1AJ
JOB STEP ABORT.	The job step was aborted due to mass storage device error.	Retry the job step. If the problem recurs, inform site analyst.	1AJ
JOB STEP EXCEEDS ACCOUNT BLOCK.	You tried to set your job step limit to a value greater than your account block limit or tried to set your account block limit to a value less than your job step limit.	Check values on SETJSL and SETASL commands.	CPM
JOB STEP LIMIT.	The monitor detected the expiration of the job step SRU limit.	Reset job step limit with SETJSL command or macro and retry. If job step SRU limit is set at maximum, request increased SRU validation.	1AJ
LABEL CONTENT ERROR, filename AT address.	A block read was the correct size for a label but one or more required fields (such as the label name) were incorrect.	Use LISTLB command to obtain label data and retry.	1MT
LABEL MISSING, filename AT address.	During a read operation, a required label was missing.	Ensure that tape has label.	1MT
LABEL NOT EXPIRED.	You attempted to write on a tape with an unexpired label.	If current contents of tape can be sacrificed, have operator blank label tape. Otherwise, wait until label has expired.	1MT
LABEL PARAMETER ERROR ON OPEN, filename AT address.	Label fields did not match on open request. An additional message, FIELD BEGINNING AT addr NO COMPARE, specifying the decimal character position in HDR1 of the first field that did not compare correctly, is also issued.	Use LISTLB command to obtain label data.	1MT
LDR ERROR.	Issued before one of the following errors: - OVERLAY NOT FOUND IN LIBRARY. - ARGUMENT ERROR.	Correct error and retry.	LDR
LFM DETECTED ERROR.	The Resource Executive (RESEX) detected an error.	Inform site analyst.	LFM
LFM ERROR.	LFM detected an error in the request. See other error messages in dayfile for more information.	Ensure that a valid LFM request is being made.	LFM
LFM INCORRECT REQUEST.	One of the following: - The function detected was not recognized as a valid LFM function. - An LFM function was issued without the auto recall bit set.	Verify that a valid LFM request is being used.	LFM
LINE WAS DISCONNECTED WHILE LOANED.	The line connection to your secondary application was broken.	Enter another APPSW command to reestablish the connection.	TLX
LOADER MISSING.	1AJ could not find BEGIN or LDR=.	Inform software support.	1AJ
LOCAL FILE LIMIT.	The job tried to create too many local files.	Reduce local file usage.	1AJ
M.T. NOT AVAILABLE ON FILE filename AT address.	The magnetic tape executive is not executing.	Inform site operator. Bring up MAGNET.	1MS

<u>MESSAGE</u>	<u>SIGNIFICANCE</u>	<u>ACTION</u>	<u>ROUTINE</u>
MAGNETIC TAPE SUBSYSTEM NOT ACTIVE.	One of the following occurred during a magnetic tape request: - There was no UDT address in the FST. - The UDT address in the FST was incorrect. - The MAG subsystem was not present.	Contact site operator to have MAGNET brought up. Otherwise contact central software support.	LFM RESEX
MASS STORAGE ERROR.	An error was encountered in reading a portion of the permanent file catalog or permit information (error log and dayfile message). This indicates a hardware problem with a disk pack or disk drive.	Inform site analyst. If many of these errors occur, the site analyst should perform a full PFDUMP, total INITIALIZE, and full PFLOAD on the device.	PFM
MESSAGE LIMIT.	The number of messages issued by the job has exceeded the limit for which you are authorized. Message functions issued by compilers or applications that run in the job's field length are also counted as job dayfile messages and thus are subject to your dayfile message limit.	Split job into two or more jobs and retry.	1AJ
MFL LESS THAN EXTENDED MEMORY MINIMUM CM FL.	To use extended memory you must have a required minimum amount of central memory field length. This message indicates that you do not have the required central memory field length.	Increase central memory field length.	1MA
MFLINK - WRONG REMOTE APPLICATION LEVEL. MFLINK - TRANSFER IMPOSSIBLE TO ST lid.	You entered an MFLINK command with ST=lid; the transfer failed because MFLINK's protocol version or level is incompatible with the Permanent File Transfer Facility (PTF) Saver software at the remote host.	Inform site analyst.	MFLINK
MISSING DEMAND FILE ENTRY.	Dayfile message indicating a RESEX internal problem. The overcommitment algorithm was initiated without a demand file entry having been defined previously.	Rerun the job. If the problem recurs, inform a site analyst, write a PSR and include support material so that CDC can duplicate the problem.	RESEX
jsn MISSING RESOURCE.	Dayfile message indicating that a RESEX internal problem occurred. RESEX expected but did not find a resource unit assigned to the job with job sequence number jsn. This could occur if the MAG subsystem was stopped while tapes were assigned.	Verify that the MAG subsystem is running and rerun the job. If the problem recurs, inform a site analyst, write a PSR and include support material so that CDC can duplicate the problem.	RESEX
MISSING VSN OR EQUIPMENT ASSIGNMENT.	Dayfile message indicating internal malfunction in RESEX (expected VSN or equipment assignment was not found).	Reenter the command or rerun the job. If the problem recurs, inform your site analyst or contact Central Software Support.	RESEX
MLF REQUEST TOO SMALL, MINIMUM USED.	The SETMFL macro (CPM function 52) attempted to specify a maximum FL value lower than the minimum required for a subsequent MFL command.	No action necessary. To prevent the message from recurring increase MFL specified in SETMFL macro to at least the minimum required for the MFL command.	CPM
MONITOR CALL ERROR, xxxx nnnnnnnn.	One of the following occurred during the processing of an monitor request: - The monitor request call was not recognized by the system. - Bad parameters were supplied in the request. - Incorrect user access was encountered. - An incorrect request was included in the request.	Examine program to determine why incorrect monitor request call is being made.	1AJ
MT,Ccc,Eec,Hhhhhhhh,B.C. RESTART.	Magnetic tape controller controlware restarted.	None.	1MT
MT,Ccc,Eec,Hhhhhhhh,BAD ERASE.	Error detected after an erase was attempted to recover a write error.	Inform site analyst.	1MT

<u>MESSAGE</u>	<u>SIGNIFICANCE</u>	<u>ACTION</u>	<u>ROUTINE</u>
MT,Ccc,Eec,Hhhhhhhh,BID RECOVERY-x.	A single block mispositioning error was recovered by block ID recovery. If x is B, the error was caused by backspacing the tape too far; if x is F, the tape was not backspaced far enough.	None.	1MT
MT,Ccc,Eec,Hhhhhhhh,BLOCK TOO LARGE.	Data block is at least one byte longer than length bbbb shown in third line of message.	None.	1MT
MT,Ccc,Eec,Hhhhhhhh,BUSY.	Unit was still busy after one second.	Inform customer engineer.	1MT
MT,Ccc,Eec,Hhhhhhhh,CHANNEL ILL.	Channel is not accepting function for status requests properly.	Inform customer engineer.	1MT
MT,Ccc,Eec,Hhhhhhhh,CON. REJ.	Connect reject; unable to connect to the unit.	Inform site analyst.	1MT
MT,Ccc,Eec,Hhhhhhhh,CON. REJ. MDI.	Connect reject; unable to connect to unit because of marginal detection indication (thermal warning). Unit turned off.	Inform customer engineer.	1MT
MT,Ccc,Eec,Hhhhhhhh,CON. REJ. OFF.	Connect reject; unable to connect to unit. Unit turned off.	Inform site analyst.	1MT
MT,Ccc,Eec,Hhhhhhhh,Fnffff,Pyyyy.	Function ffff was rejected by the controller; yyyy is the address in 1MT where the function was initiated.	Inform site analyst.	1MT
MT,Ccc,Eec,Hhhhhhhh,Lbbbb,Bnnnnn.	The length (bbbb) and block number (nnnnn) read from trailer bytes in block did not match the actual length or the block number read given in previous message line.	None.	1MT
MT,Ccc,Eec,Hhhhhhhh,LOAD CHECK.	Load sequence failed on the unit.	Push CLEAR button and reload tape, or inform site analyst.	1MT
MT,Ccc,Eec,Hhhhhhhh,MARGINAL, DOWN.	Indicates controller failure. Channel has been logically turned off and maintenance is required.	Inform customer engineer.	1MT
MT,Ccc,Eec,Hhhhhhhh,MARGINAL, OFF.	Unit has been logically turned off because of read/write failure. This occurred when a special function to check the read/write path to a unit failed during initial label scan. Maintenance is required.	Inform customer engineer.	1MT
MT,Ccc,Eec,Hhhhhhhh,NO EOP.	No end-of-operation detected from unit within 1 second.	Inform customer engineer.	1MT
MT,Ccc,Eec,Hhhhhhhh,NOISE.	A noise block was skipped on the tape.	None.	1MT
MT,Ccc,Eec,Hhhhhhhh,NOT READY.	Tape unit dropped ready status.	Make unit ready.	1MT
MT,Ccc,Eec,Hhhhhhhh,ON THE FLY.	Error was corrected as the data was read.	None.	1MT
MT,Ccc,Eec,Hhhhhhhh,POSITION LOST.	The last good block written cannot be found during write recovery.	None.	1MT
MT,Ccc,Eec,Hhhhhhhh,RECOVERED.	Previously reported error has been successfully recovered.	None.	1MT
MT,Ccc,Eec,Hhhhhhhh,STATUS.	Error type cannot be determined so actual controller status is returned.	Inform site analyst.	1MT
MT,Ccc,Eec,Hhhhhhhh,WRONG PARITY.	Tape was written in parity opposite that being read.	None.	1MT

MESSAGE	SIGNIFICANCE	ACTION	ROUTINE
MT,Ccc-e-uu,vsn,rw,est,Ss,GSgggggggg	Four or five or six-line message describing a magnetic tape hardware malfunction on a 66x or 67x tape unit. Message as illustrated indicates 7-track, model 667 or 677 unit. If NT appears in place of MT, message indicates 9-track, model 669 or 679 unit. Message is issued to error log and dayfile.	Refer to the separate listing of the last line message (MT,...,type.) for the appropriate action.	1MT
MT,Ccc,Dddd...d.			
MT,Ccc,Uuu...u,Tttt.	The first line of each message provides the following information:		
MT,Ccc,Aaaaaaaa.			
MT,Ccc,Fff,Iii,Bnnnnnn,Lbbbb,Ppppppppp	cc-e-uu Channel, equipment (tape controller), and physical unit number of tape unit on which error was encountered.		
MT,Ccc,Eec,Hhhhhhhh,type.			
or	vsn Volume serial number associated with tape on the specified unit.		
MT,Ccc-e-uu,vsn,rw,est,Ss,GSgggggggg			
MT,Ccc,Dddd...d.	rw Read (RD) or write (WR) operation; any operation not involving an actual read or write is listed as a read.		
MT,Ccc,Aaaaaaaa.			
MT,Ccc,Fff,Iii,Bnnnnnn,Lbbbb,Ppppppppp	est EST ordinal of the unit on which the tape was written. This is provided only for labeled tapes generated under NOS; otherwise, the field is blank.		
MT,Ccc,Eec,Hhhhhhhh,type.			
or	s Channel status.		
MT,Ccc,-e-uu,vsn,rw,est,Ss,GSgggggggg			
MT,Ccc,Dddd...d.	gggggggg General status of magnetic tape unit. Last byte is block ID.		
MT,Ccc,Uuu...u,Tttt.			
MT,Ccc,Fff,Iii,Bnnnnnn,Lbbbb,Ppppppppp	The MT,Ccc,Dddd...d line of the message provides the following information:		
MT,Ccc,Eed,Hhhhhhhh,type.			
or	cc Channel number; the channel number is repeated to allow the analyst to associate this message with the first message if errors are occurring on more than one tape channel at the same time.		
MT,Ccc,-e-uu,vsn,rw,est,Ss,GSgggggggg			
MT,Ccc,Dddd...d.	ddd...d Detailed status of magnetic tape unit.		
MT,Ccc,Uuu...u,Tttt.			
MT,Ccc,Fff,Iii,Bnnnnnn,Lbbbb,Ppppppppp	The MT,Ccc,Uuu...u,Tttt line of the message provides the following information:		
MT,Ccc,Eed,Hhhhhhhh,type.			
or	cc Channel number; repeated to associate this message with the previous message.		
MT,Ccc,-e-uu,vsn,rw,est,Ss,GSgggggggg			
MT,Ccc,Dddd...d.	uu...u Detailed unit status.		
MT,Ccc,Uuu...u,Tttt.			
MT,Ccc,Fff,Iii,Bnnnnnn,Lbbbb,Ppppppppp	tttt Third byte of the tape unit format parameters (refer to the magnetic tape subsystem reference manual for descriptions of unit format parameter fields).		
MT,Ccc,Eed,Hhhhhhhh,type.			
or	The MT,Ccc,Aaaaaaaa line (for FSC only) contains the additional sense byte status not placed in the detailed status or unit status fields.		
MT,Ccc,-e-uu,vsn,rw,est,Ss,GSgggggggg			
MT,Ccc,Dddd...d.	cc Channel number.		
MT,Ccc,Uuu...u,Tttt.			
MT,Ccc,Fff,Iii,Bnnnnnn,Lbbbb,Ppppppppp	aaaaaa Sense byte.		
MT,Ccc,Eed,Hhhhhhhh,type.			
or	The MT,Ccc,Fff,...,Ppppppppp line of the message provides the following information:		
MT,Ccc,-e-uu,vsn,rw,est,Ss,GSgggggggg			
MT,Ccc,Dddd...d.	cc Channel number; repeated to associate this message with the previous message.		
MT,Ccc,Uuu...u,Tttt.			
MT,Ccc,Fff,Iii,Bnnnnnn,Lbbbb,Ppppppppp	ff Software function on which the error occurred.		
MT,Ccc,Eed,Hhhhhhhh,type.			
or	ii Error iteration; number of times error has been encountered on this unit without successful recovery.		
MT,Ccc,-e-uu,vsn,rw,est,Ss,GSgggggggg			
MT,Ccc,Dddd...d.	nnnnnn Block number on which error occurred.		
MT,Ccc,Uuu...u,Tttt.			
MT,Ccc,Fff,Iii,Bnnnnnn,Lbbbb,Ppppppppp	bbbb Length of block on which error occurred in octal bytes.		
MT,Ccc,Eed,Hhhhhhhh,type.			
or	pppppppp 1MT internal error parameters.		
MT,Ccc,-e-uu,vsn,rw,est,Ss,GSgggggggg			

<u>MESSAGE</u>	<u>SIGNIFICANCE</u>	<u>ACTION</u>	<u>ROUTINE</u>
	The last line of each message provides the following information: cc Channel number; repeated to associate this message with the previous message ec Octal error code value. hhhhhhh Parameters passed to the tape unit for the format function (refer to the tape drive's hardware reference manual for descriptions of the unit format parameter fields). type Additional description of the error. Refer to individual listing of the last line message.		
MT/NT CONFLICT.	Conflict exists between 7-track and 9-track tape descriptors (track type, density, and conversion mode). For example, a request for a 9-track tape specified 200 bpi density. This message can also be issued if the device type specified in FET+1 conflicts with the track type specified in bit 56 of FET+10 octal. If dt=MT and bit 56 is set, the message is issued.	Ensure accuracy of command.	RESEX BLANK
MULTI-FILE NOT FOUND, filename AT address.	Either LISTLB has reached the end of the multifile set or the requested file was not found. The following additional messages are also given: - REQUESTED SECTION xxxx. - FOUND SECTION yyyy. or - FILE IDENTIFIER NOT FOUND. The filename, address, xxxx, and yyyy given can be ignored.	If LISTLB reached the end of the multifile set, the operation is complete and no action is required. Otherwise, ensure that the correct tape is being used and that it contains the desired file(s). All label parameters must match in order to position to the specified file.	1MT
NETWORK TYPE DOES NOT SUPPORT ATTRIBUTE COMMAND.	You attempted to enter NAM/CDCNET command from a NAM/CCP connection.	Be sure that you enter only NAM/CCP commands from a NAM/CCP connection.	TRMDEF
NO EXTENDED MEMORY.	A DMPECS or DMDECS command or DED or DEP request was entered and no extended memory field length is assigned to you.	None.	CPMEM
NO INPUT FILE FOUND.	No valid input file exists; functions cannot be performed.	Verify that input file is present.	QFM
NO MASS STORAGE AVAILABLE.	No mass storage space of the requested type could be found.	Retry later.	LFM
filename - NO TEMP DEVICE FOUND.	You attempted to create a local copy of an indirect access permanent file, but the file's access level was not within the range of valid access levels for any active temporary storage device.	Inform security administrator. The security administrator needs to configure the system so that temporary devices are available for all valid access levels.	PFM
NO WRITE ENABLE, filename AT address.	Either you attempted to write on a tape mounted with no write ring, or no write was allowed because of additional constraints described in an additional message line.	If no additional message line appears, ensure the inserting of a write ring by specifying the W processing option on the tape request (for example, PO=W on the LABEL command). Otherwise, refer to the description of the message in the additional message line.	1MT
NON-MATCHING CONVERSION.	Informative message indicating conversion mode on labeled 9-track tape differs from that specified by assignment request. System writes tape in specified mode, or reads tape with write ring out in correct mode. However, reading tape with write ring in or using wrong conversion mode generates conversion errors.	If reading tape with write ring in, return and reassign with correct conversion mode.	RESEX

<u>MESSAGE</u>	<u>SIGNIFICANCE</u>	<u>ACTION</u>	<u>ROUTINE</u>
NON-MATCHING DENSITY.	Informative message indicating that the density specified on the command or macro is not the same as the density of the assigned tape. Issued only to 9-track tapes with write ring out. 9-track tapes are read at the current density on tape. They are written at specified density if write initiated from load point; otherwise, tape is written at the current density on the tape.	None.	RESEX
NORERUN/RERUN INCORRECT FROM INTERACTIVE JOBS.	You entered a NORERUN or RERUN command from an interactive terminal. The command is ignored.	None.	QFM CONTROL
filename NOT FOUND. or username NOT FOUND.	One of the following: - The specified permanent file could not be found. - The specified user name could not be found. - You are not allowed to access the specified file. - The specified local file could not be found.	Verify that file name/ user name is correct, that access permission has been granted, and that correct access is being attempted.	PFM
filename NOT IN WRITE MODE.	The file specified in an OWRITE command or macro was not processed because you do not have write access to it.	Correct and retry.	IMS
filename NOT ON MASS STORAGE.	The file to be saved is not on mass storage; the first track of the file is not recognizable.	Verify that file is on mass storage.	PFM
filename NOT ON MASS STORAGE.	The file specified in an OWRITE command or macro was not processed because it does not reside on mass storage.	Correct and retry.	IMS
NOT VALID TO DOWNGRADE DATA.	You attempted to lower the access level of a permanent file, but you are not validated to downgrade files.	None.	PFM
NOT VALIDATED FOR REQUESTED ACCESS LEVEL.	User has specified an access level outside the user's access level validation.	Use a validated access level, or site must validate user for additional access level.	RESEX
NOT VALIDATED FOR REQUESTED APPLICATION.	You submitted an APPSW command specifying an application for which you are not validated.	Enter a LIMITS command to check your current validations. If you require validation for additional applications, see your site administration.	TLX
NOT VALIDATED FOR WRITING UNLABELED TAPES.	User has not been validated for writing on unlabeled tape.	Either use labeled tape or site must validate user for SAV=CULT MODVAL privilege.	RESEX
NOT VALIDATED TO SET XD/XT.	You specified an XD or XT parameter in a CHANGE, DEFINE or PERMIT command or macro without having validation to use these parameters.	Retry without XD or XT parameter, or obtain validation and retry.	PFM
ONLY CORRECT PARAMETERS ARE *ON* OR *OFF*.	The parameter you specified was not recognized.	Check command description and retry.	CONTROL
OPERATOR DROP.	Informative message indicating that the operator dropped the job.	None.	1AJ
OPERATOR KILL.	The operator entered a KILL command to drop the job. This disallows erexit processing. A job with extended reprieve processing is reprieved once. Exit processing is allowed.	Correct job as needed and rerun.	1AJ
OPERATOR OVERRIDE.	The operator entered an OVERRIDE command to drop the job. This disallows exit, erexit, and reprieve processing.	Correct job as needed and rerun.	1AJ
OVERLAY FILE EMPTY.	No data appears in the requested file.	Verify that overlay file is valid.	1AJ
OVERLAY FILE NOT FOUND.	The specified file was not available.	Verify that file is local to job and retry.	1AJ
OVERLAY LOST.	The specified overlay was not found.	Inform software support.	1AJ

<u>MESSAGE</u>	<u>SIGNIFICANCE</u>	<u>ACTION</u>	<u>ROUTINE</u>
OVERLAY NOT FOUND.	The specified overlay was not found.	Verify that the file with the specified overlay is local to the job.	1AJ
OVERLAY NOT FOUND IN LIBRARY - ovlname.	The overlay ovlname was not found in the system library.	Verify that call is to valid overlay.	LDR
PARAMETER BLOCK BUSY.	The completion bit of the parameter block was not set to one before the monitor request was made.	Set completion bit before making monitor request call.	LFM
PARAMETER *ON* OR *OFF* REQUIRED.	No parameter was specified on ERRMSG command.	Retry with a parameter.	CONTROL
PARAMETERS *ON* AND *OFF* ARE MUTUALLY EXCLUSIVE.	You specified both the ON and OFF parameters on the same command. Only one is allowed.	Retry with either ON or OFF.	CONTROL
PARITY ERROR, JOB HUNG.	A CM parity error occurred in the jobs field length. The job is hung to freeze the affected area.	Inform software support.	1AJ
pfn PERMANENT ERROR.	The specified direct access file resides on alternate storage and has data errors that must be corrected. The error flag must be cleared or the file must be reloaded from a backup copy.	Inform site analyst. The site analyst may be able to correct the problem with ASDEBUG or SSDEBUG; otherwise, the file must be purged or reloaded.	PFM
PERMIT LIMIT EXCEEDED.	A PERMIT command or macro cannot be processed because the file specified already has the maximum number of permits allowed.	None.	PFM
PF STAGING DISABLED.	The specified direct access file cannot be accessed since it resides on the Mass Storage Facility (MSF) and the site has temporarily disabled all MSF file staging.	Determine from site operator when MSF file staging will resume and retry the job at that time.	PFM
PF UTILITY ACTIVE.	The operation was not attempted because a permanent file utility was currently active.	Wait until PF utility is not active and retry.	PFM
PFM ARGUMENT ERROR.	One of the following conditions is true: - The PFM call block is outside of the job's field length. - An incorrect command code was specified. - Auto recall was not set when PFM was called.	Correct your program to call PFM properly.	PFM
PFM EXCESS ACTIVITY.	The PFM activity count for your permanent file family is currently at its limit. This condition is reported to the requesting program only if both ep and up processing options are set.	Retry operation later.	PFM
PFM INCORRECT REQUEST.	One of the following occurred: - A privileged command was requested by a nonvalidated program. - An incorrect backup requirement, preferred residence, or subsystem value was entered. - Incorrect command code, passed to PFM. - Incorrect permit mode or catalog type specified. - The FET for a file specified in a SETPFAC request was less than six words long.	Verify that the PFM request is valid.	PFM
PL ERROR IN DECK.	The program library specified by the P option in the KRONREF command was incorrectly formatted.	Check that the PL is a MODIFY OPL.	KRONREF
POSITION ERROR ON-filename.	File filename was not repositioned after being checkpointed because CHKPT detected an address error.	None.	CHKPT
POSITION LOST, filename AT address.	During write or read error recovery, the system could not find the last good block of data, making it impossible to successfully perform error recovery. Labels are not written after this error and existing data on the tape is not destroyed.	Retry operation on different tape or tape drive, if possible.	1MT

<u>MESSAGE</u>	<u>SIGNIFICANCE</u>	<u>ACTION</u>	<u>ROUTINE</u>
PP CALL ERROR.	The monitor detected an error in a CPU request for PP action.	Verify that correct PP call is issued.	1AJ
PRIOR TAPE ASSIGNMENT LOST.	Magnetic tape executive has been dropped along with tapes assigned. All of the job's prior tape assignments are lost.	From an interactive job, return/unload all prior tapes and reassign. A batch job aborts and must be rerun.	RESEX
PROCESSOR DETECTED MALFUNCTION	A hardware error occurred such as a data or address parity error on double bit error.	Analyze job dumps, maintenance registers and the error log to determine cause.	1AJ
PROCESSOR STATE ERROR	A hardware error, or software error resulting in a hardware error, occurred.	Analyze job output, dumps, listings, maintenance registers and the error log to determine cause.	1AJ
PROGRAM STOP.	The system processed a program stop (00) instruction.	None.	1AJ
PROGRAM STOP AT address.	The monitor detected a program stop instruction at the specified address.	None.	1AJ
PRU LIMIT, FILE filename AT address.	The job's mass storage PRU limit was exceeded during an attempt to write or extend this file.	Return one or more local files and retry.	1MS
PRUS REQUESTED UNAVAILABLE.	On a DEFINE, no device currently has available the amount of space requested by the S parameter. On a secured system, no device with the proper access level currently has the amount of space requested.	If possible, reduce the number of PRUs specified by the S parameter, or retry at another time when space might be available.	PFM
QAC BUFFER ARGUMENT ERROR.	The address in one of the QAC buffer fields (first, in, out, or limit) is incorrect.	Ensure that all four addresses are within the job's field length.	QAC
QAC INCORRECT PARAMETER BLOCK SIZE.	The value of the len field of address+1 is incorrect for the requested function.	Correct the len field or the function code.	QAC
QAC INCORRECT QUEUE ORDINAL.	The ordinal in the ejt/qft ord field of address+4 is out of range for the specified queue.	Enter a valid EJT or QFT ordinal.	QAC
QAC INCORRECT REQUEST.	One of the following occurred: - An undefined function code was entered in address+0. - An incorrect address was entered in monitor request or the link address field in address +10B, on the QAC parameter block. - The range of security access levels specified was not within the job's security access level limits. - The new security access level specified in an ALTER request was not within the security access level limits for the file's origin type, or is not allowed on the device where the file resides. - An ALTER request to change the access level of a queued file was made by a user without security administrator privileges.	Enter a valid function code, level(s), address, or access.	QAC
QAC REQUEST COMPLETION BIT SET.	The completion bit in address+0 was set for the request.	Clear the completion bit.	QAC
QFM ARGUMENT ERROR.	One of the following: - Address is outside field length. - Address is equal to 1. - Origin code is out of range. - ID code is out of range.	Verify that QFM request is valid.	QFM
QFM BUFFER ARGUMENT ERROR.	A buffer pointer did not conform to the following constraints: - FIRST .LE. IN - FIRST .LE. OUT - OUT .LE. LIMIT .LE. FL	Examine program to determine error in buffer pointers.	QFM
QFM FILE NAME ERROR.	The filename specified is not a valid file name.	Verify file name.	QFM

<u>MESSAGE</u>	<u>SIGNIFICANCE</u>	<u>ACTION</u>	<u>ROUTINE</u>
QFM I/O SEQUENCE ERROR.	Action was requested on a busy file.	Wait until file is not busy and retry.	QFM
QFM INCORRECT EQUIPMENT.	The equipment specified in FET+7 either is not mass storage or is not in the range of the EST.	Verify that correct equipment is specified in FET+7.	QFM
QFM INCORRECT QUEUE FILE ORDINAL.	The QFT ordinal of the file to be attached is out of range.	Ensure that the routine calling QFM supplies the correct ordinal.	QFM
QFM INCORRECT REQUEST.	One of the following: - Specified function was incorrect or undefined. - Job did not have SSJ= entry point. - Auto recall bit was not set.	Verify that valid QFM request is being made.	QFM
QFM USER ACCESS NOT VALID.	The user tried to perform an operation for which he is not validated (for example, attempting to run a system origin job from nonsystem origin).	Ensure accuracy of command or macro or determine proper validation requirements.	QFM
RANDOM ADDRESS NOT ON FILE filename AT address.	The random address specified was not within the bounds of the file. The system provides a dump of the FET on file OUTPUT.	Verify that random address is correct.	1MS
RANDOM INDEX ERROR.	The random disk address of the permit sector is in error (error log and dayfile message). This may be a problem with your program.	Check your program. If it does not use the CATLIST macro, inform site analyst.	PFM
READ AFTER WRITE, filename AT address.	You attempted to read a tape on which the last operation was a write.	Ensure accuracy of tape positioning commands (BKSP, BKSPRU, SKIPFB, or REWIND required to read after write).	1MT
READY DROP, filename AT address.	Unit dropped ready status.	None.	1MT
REPLACE ERROR.	The same file was found twice during a catalog search. This error can occur for APPEND or REPLACE commands or macros after a file is found and purged and the catalog search is continued (error log and dayfile message).	Inform site analyst. If many of these errors occur, the site analyst should perform a full PFDUMP, total INITIALIZE, and full PFLoad on the device.	PFM
REPRIEVE BLOCK ERROR.	An address is out of range or there is an incorrect parameter in the reprieve parameter block at the time of an error. The message is also issued if the specified reprieve address itself is out of range. (1AJ issues this message for all errors except terminal interrupts processed by 1RI.)	Ensure parameter block is correct.	1AJ
REPRIEVE CHECKSUM BAD.	The computed checksum does not agree with the checksum specified in the parameter block at the time of the error. (1AJ issues this message for all errors except terminal interrupts processed by 1RI.)	Ensure interrupt handler is still intact. Ensure that code in the area for which checksum was computed has not changed.	1AJ
REQUEST IS VALID ONLY FROM A NETWORK TERMINAL.	You attempted to enter an APPSW command from a job that was not of interactive origin type or from a terminal not connected to NAM (for example, through RDF). To use the APPSW command, your job must be of interactive origin type and your terminal must be connected to NAM.	Login to IAF from a terminal connected to NAM.	TLX
REQUEST *K* DISPLAY.	Issued by function 5 (Set Console Display Register) to DSD B and J displays when operator action is requested.	Refer to DSD K display.	CPM
REQUEST UNDEFINED ON DEVICE, filename AT address.	The specified function cannot be performed on the device on which the file resides. The system provides a dump of the FET on file OUTPUT.	Verify that valid device is specified.	1MS
RESEX ABORT - OPERATOR TERMINATION.	The operator entered a DROP, KILL or RERUN command, setting an error flag in RESEX. RESEX performed appropriate cleanup procedures before termination.	Determine reason for operator action. Rerun job if possible.	RESEX

<u>MESSAGE</u>	<u>SIGNIFICANCE</u>	<u>ACTION</u>	<u>ROUTINE</u>
RESEX ABORT - SYSTEM RESOURCE LIMIT.	RESEX terminated prematurely due to job time limit, SRU limit, or track limit. RESEX performs appropriate cleanup procedures before termination.	If error caused by SRU or time limit, increase resource limits. If caused by track limit, contact site analyst.	RESEX
RESEX ABORT - TERMINAL INTERRUPT.	Terminal user interrupted RESEX (interrupt or terminate sequence). RESEX performs appropriate cleanup procedures before termination.	None.	RESEX
RESEX FAILURE.	The resource executive (RESEX) has detected a fatal error.	Write a PSR.	PFM
RESOURCE ENVIRONMENT ERROR.	Dayfile message indicating RESEX internal problem occurred (internal environment building failed due to MST, UDT, or EST errors).	Reenter the command or rerun the job. If the problem recurs, inform your site analyst or contact Central Software Support.	RESEX
RESOURCE NEGATIVE SHARE COUNT.	Dayfile message indicating that a RESEX internal problem occurred. The resource overcommitment algorithm indicates a greater number of users are sharing a removable pack than are actually sharing the pack.	Reenter the command or rerun the job. If the problem recurs, inform your site analyst or contact Central Software Support.	RESEX
RESOURCE PF ERROR ec filename.	PFM error ec occurred when attaching resource file filename.	Rerun the job. If the problem recurs, inform a site analyst, write a PSR and include support material so that CDC can duplicate the problem.	RESEX
RESOURCE SCRATCH FILE ERROR.	Dayfile message indicating RESEX internal problem has occurred. An empty entry has been found in the overcommitment algorithm scratch file.	Rerun the job. If the problem recurs, inform a site analyst, write a PSR and include support material so that CDC can duplicate the problem.	RESEX
RETRY APPLICATION SWITCH.	An attempt to switch applications failed due to software error.	Retry the APPSW command. If the error recurs, inform your site analyst.	TLX
RFL BEYOND MFL.	The RFL request is greater than the maximum field length for a job step.	Increase maximum field length with MFL command or SETMFL macro.	CPM
ROLLOUT FILE BAD.	A job could not be rolled out correctly.	Inform site analyst. Check error log dayfile for the job that was aborted and the location of the bad rollout file.	1RI
RPV-ADDRESS OUT OF RANGE.	An address provided to RPV was out of range. This includes the following conditions: - FWA of parameter block .GE. FL - LWA of parameter block .GE. FL - Transfer address .GE. FL - Transfer address .LT. 2.	Check all addresses sent and ensure that they are within range.	RPV to RPV
RPV-CALLED WITHOUT AUTO-RECALL.	An extended RPV mode call was made without auto recall.	Ensure that auto recall bit is set.	RPV
RPV-INCORRECT CALL.	One of the followings: - An attempt was made to do a reset when no previous error existed or the previous error was pending. - An extended mode call was attempted when nonextended RPV or DISTC had already been set for the job. - A nonextended mode call was attempted when RPV extended mode had already been set in for the job. - A call was made to clear extended reprieve and there were pending interrupts present.	- Check to see if a reset is allowed. - If RPV nonextended mode has already been used, then RPV nonextended mode cannot be used in the same job. - Clear pending interrupt fEX before calling RPV. - If RPV extended mode has already been used, then RPV nonextended mode cannot be used in the same job.	RPV

<u>MESSAGE</u>	<u>SIGNIFICANCE</u>	<u>ACTION</u>	<u>ROUTINE</u>
RPV-INCORRECT FUNCTION CODE.	The function code specified in the parameter block was incorrect.	Function code in parameter block must equal 1 for setup, 2 for resume, or 3 for reset.	RPV
RPV-INCORRECT PENDING INTERRUPT.	A bit was set in the pending interrupt word of the parameter block which did not correspond to a defined error.	Check parameter block to ensure that all bits set correspond to a defined error.	RPV
RPV-INCORRECT PENDING RA+1 REQUEST.	The pending monitor request field of the parameter block contained an incorrect monitor request on a RESUME or SETUP. On a RESET, the pending monitor request is not validated because the job will not be restarted.	Check pending monitor request word in parameter block to ensure that it contains a valid call.	RPV
RPV-LWA OF CHECKSUM .LT. FWA.	The last word address of the checksum was less than the first word address.	Correct and rerun.	RPV
RPV-PARAMETER BLOCK TOO SHORT.	The length specified in the parameter block was less than 31B words.	Ensure that the length specified in the parameter block is greater than or equal to 31B.	RPV
RPV-UNDEFINED MASK.	The mask specified in the parameter block is not a legal mask.	Check mask set in parameter block to ensure that it is a valid mark.	RPV
SCP INCORRECT TRANSFER ADDRESS.	The SCP SSCR (RA + 51B) word contains incorrect parameters on the completion address for an SF.REGR, SF.SWPI or SF.SWPQ function is no longer within the SCP field length.	Correct code error in SCP.	1AJ
SECONDARY APPLICATION ABORTED CONNECTION.	You intentionally or unintentionally aborted the secondary connection. Possible causes are security conflict or entry of a BYE,ABORT command.	If the abort was unintentional and you cannot establish a cause, see your site analyst.	TLX
SECONDARY APPLICATION CONNECTION LIMIT.	The application you specified on an APPSW command is busy with the maximum allowable number of terminal connections.	Try again later.	TLX
SECONDARY APPLICATION FAILED.	Your secondary application has failed, probably due to a system problem.	Check with your site analyst or try again later.	TLX
SECONDARY APPLICATION NETTED OFF.	The application was brought down by the network operator.	Check with your site analyst or try again later.	TLX
SECONDARY APPLICATION NOT AVAILABLE.	The secondary application requested on an APPSW command is either temporarily unavailable or is not supported at your site.	Check with your site analyst.	TLX
SECONDARY APPLICATION PROCESSING COMPLETE.	The connection to your secondary application has been terminated normally.	None.	TLX
SECONDARY APPLICATION REFUSED CONNECTION.	The application refused to accept your connection, possibly as a result of a validation problem or security conflict.	Check with your site analyst.	TLX
SECURE FILES - CHECKPOINT ABORT.	Indicates a local file being checkpointed had secure file status set.	None.	CHKPT
SECURE MEMORY, DUMP DISABLED.	You either attempted to dump memory protected by the system, or entered a memory dump request after a protected command.	Refer to Security Control in NOS Reference Set, Volume 3, or user Field Length Dump Request Volume 4.	1AJ
SECURITY CONFLICT.	An attempted operation within the job would have resulted in a violation of security access levels or categories. The cause is described in the immediately preceding dayfile message.	Correct and retry.	1AJ

<u>MESSAGE</u>	<u>SIGNIFICANCE</u>	<u>ACTION</u>	<u>ROUTINE</u>
SECURITY VIOLATION ON FILE filename AT address.	One of the following: - You issued an OPEN request that specified an access level for a file that is not valid for your job. - You attempted to write on a direct access permanent file whose access level is lower than that of your job.	Set the access level of the file to the correct value and retry.	1MS
SFM ARGUMENT ERROR.	One of the following occurred: - The argument passed to SFM was out of range or the FET specified did not specify a buffer of at least 100B words. - The EST ordinal specified is undefined in the system.	Verify that SFM request is valid.	SFM
SFM BML MESSAGE LENGTH ERROR.	The specified BML message length is zero or greater than six. Legal values for length are one through six.	Specify a valid message length.	SFM
SFM - DAYFILE BUSY.	Action was requested on a busy dayfile.	Inform site analyst.	SFM
SFM DIRECT ACCESS FILE ERROR.	An error was encountered in the system sector of a direct access file.	Inform site analyst.	SFM
SFM DUPLICATE FILE FOUND.	The requested file is already attached to the control point.	Specify a unique file name.	SFM
SFM FILE NAME ERROR.	The file name, filename, passed through the FET is not a valid file name.	Specify a valid file name.	SFM
SFM FILE NOT ON MASS STORAGE.	The specified file does not reside on a mass storage device.	Specify a mass storage file.	SFM
SFM FNT FULL.	A fast attach file could not be created because the FNT was full.	Retry operation at a later time.	SFM
SFM I/O SEQUENCE ERROR.	Action has been requested on a busy file.	Wait until file is not busy and retry.	SFM
SFM INCORRECT DAYFILE CODE.	The dayfile code passed in the FET was not within range.	Inform site analyst.	SFM
SFM INCORRECT EQUIPMENT.	The specified equipment is not in the EST or is not mass storage.	Specify a valid mass storage equipment.	SFM
SFM INCORRECT FILE TYPE.	The file must be local for a system file and direct access for a fast attach file.	Specify a file of the correct file type.	SFM
SFM INCORRECT REQUEST.	One of the following occurred: - The requested function or origin type specified in the function call was not recognizable or SFM request was made and the auto recall bit was not set. - The request required an SSJ= entry point or subsystem ID, but none was present.	Verify that SFM request is valid.	SFM
SFM TRACK INTERLOCK ERROR.	Track was either interlocked when it should not have been or not interlocked when it should have been.	Contact Central Software Support.	SFM
SFM UNABLE TO INTERLOCK DEVICE.	SFM request was not performed because the selected device could not be interlocked.	Contact Central Software Support.	SFM
SFM - UNCORRECTABLE RMS ERROR.	An uncorrectable RMS error has been detected during an I/O operation.	Contact Central Software Support.	SFM
jsn SHARE TABLE MISMATCH.	Dayfile message indicating that RESEX internal problem occurred. While processing the job with the specified job sequence name.	Reenter the command or rerun the job. If the problem recurs, inform your site analyst or contact Central Software support.	RESEX
SI CODED FORMAT INCORRECT.	An attempt was made to perform a read or write operation on an SI tape with the coded bit set in the FET.	Resubmit the job with binary specified for the operation on the SI tape.	1MT
SL NOT VALIDATED.	The SRU limit requested exceeds that for which you are authorized.	Request smaller SRU limit.	CPM
STACK PURGING NOT DESELECTABLE.	You attempted to change the purging bit with the EREXIT function. This cannot be done on 6000 or CYBER 70 systems.	None.	CPM
dfn STAGE INITIATED.	The file does not reside on disk. It is currently being staged from alternate storage to disk.	Wait until stage operation is complete.	PFM

<u>MESSAGE</u>	<u>SIGNIFICANCE</u>	<u>ACTION</u>	<u>ROUTINE</u>
STATUS ERROR, filename AT address.	An error was encountered during magnetic tape processing. A second message line describes the error in more detail.	Retry or inform site analyst.	1MT
STEP CONDITION.	Step mode flag set in the PSD register caused the program to interrupt at the end of a program instruction with an exchange jump to EEA (the error exit address in the exchange package).	Inform site analyst.	1AJ
SUBSYSTEM ABORTED.	Your job was connected (either long term connection or wait response set) to a subsystem which aborted.	Retry later.	1AJ
SYSTEM ABORT.	Possible causes include the following: <ul style="list-style-type: none"> - Incorrect USER command. - Attempt to access a restricted subsystem. - Operator evicted job. - Unrecognizable error flag. - SSJ= block outside field length. - 1RI detected a bad rollout file. - 1RO detected an unrecoverable extended memory parity error during rollout of a job's extended memory field length. 	If the cause was an incorrect USER command or an attempt to access a restricted subsystem, correct the job and rerun. Otherwise, inform a site analyst.	1AJ
SYSTEM CHECKPOINT ABORT.	A subsystem has aborted due to a CHECK POINT SYSTEM request initiated by the operator.	None.	1CK
SYSTEM ERROR.	A software or hardware system error occurred. This message follows a more specific message in the dayfile.	Refer to action for the associated message.	MODVAL PFM
SYSTEM ERROR.	LFM cannot complete the requested LFM function because the calling program has a DMP= entry point.	Inform site analyst or write a PSR and include support material so that CDC can duplicate the problem.	BLANK RESEX
SYSTEM ERROR.	Requested function cannot be completed because the calling program has a DMP= entry point.	Contact Central Software Support.	LFM
SYSTEM SECTOR ERROR.	The system sector of an indirect access permanent file contains an error (error log and dayfile message). This indicates that the file has been destroyed.	Inform site analyst. If many of these errors occur, the site analyst should perform a full PFDUMP, total INITIALIZE, and full PFLOAD on the device.	PFM
SYSTEM SOFTWARE RERUN THRESHOLD EXCEEDED	A job will be rerun a maximum of n-1 times due to a hardware error. The default for n is 2 (defined by HRTL in common deck COMSMSC).	Analyze job output, dumps, and listings to determine cause.	1AJ
TAPE FORMAT PROBABLY WRONG.	This message is issued in addition to one of the following messages: <ul style="list-style-type: none"> - BLOCK SEQUENCE ERROR, filename AT addr. - BLOCK TOO LARGE, filename AT addr. - WRONG PARITY, filename AT addr. 	Ensure accuracy of format (F) parameter on command or macro.	1MT
THIS CONNECTION IS ALREADY LOANED.	This error indicates an abnormal condition is occurring in IAF.	Inform site analyst.	TLX
TIME LIMIT.	The execution time limit for a job step expired resulting in job termination.	If a time limit was set for the job, include a SETTL command requesting a longer time limit for the job step. If the job step time limit was the maximum for which you are validated, request a larger time limit or decrease the amount of processing to be performed by the job step.	1AJ
TL NOT VALIDATED.	The time limit requested exceeds that for which you are authorized.	Request smaller time limit.	CPM
TLX - ARGUMENT ERROR.	The specified function parameter address is out of range.	Specify a valid parameter address.	TLX

<u>MESSAGE</u>	<u>SIGNIFICANCE</u>	<u>ACTION</u>	<u>ROUTINE</u>
TOO MANY PERMANENT FILES.	The number of files in your catalog exceeds your limit.	Purge one or more permanent files to allow you to save or define additional files.	PFM
TOO MUCH INDIRECT ACCESS FILE SPACE.	The cumulative size of the indirect access files in your catalog exceeds your limit.	Purge or shorten one or more indirect access files to allow additional permanent file space.	PFM
TOTAL ASSIGNED COUNT ERROR.	Dayfile message indicating RESEX internal problem (sum of individual resource assigned counts differs from total assigned count in demand file entry).	Reenter the command or rerun the job. If the problem recurs, inform your site analyst or contact Central Software support.	RESEX
TOTAL DEMAND COUNT ERROR.	Dayfile message indicating RESEX internal problem occurred (sum of individual resource demand counts differs from total demand count in demand file entry).	Reenter the command or rerun the job. If the problem recurs, inform your site analyst or contact Central Software Support.	RESEX
TRACK LIMIT.	No allocatable tracks remain on your permanent file equipment (error log and dayfile message).	None; job will continue as tracks become available. If problem persists, contact central software support.	PFM
TRACK LIMIT, LVLX.	IMS is waiting for temporary file mass storage space on any mass storage device with access level LVLX.	Inform site analyst.	IMS
TRAILER BLOCK COUNT ERROR, filename AT address.	The block count in the EOF1 or EOVI label did not match the block count maintained by the tape executive during the read operation.	Inform site analyst.	1MT
UNIDENTIFIED PROGRAM FORMAT.	The file you requested to be loaded was in an unrecognizable format.	Check the format of the file.	1AJ
UNIT HUNG UP ON EOP OR BUSY, filename AT address.	Unit did not receive EOP on unit busy.	Inform site analyst.	1MT
UNNECESSARY CIO FCT. nnn ON filename AT address.	The read or write CIO function specified by nnn was unnecessary, since your I/O buffer was already full (read) or empty (write) and no data could be transferred for this CIO call. The message is issued to the job dayfile only if analyst logging is enabled on the system (console entry).	Ignore or correct program to be more efficient.	1MS
UNRECOGNIZED TERMINAL MODEL.	You entered an invalid terminal model mnemonic as a parameter in the SCREEN or LINE command.	Retry with valid mnemonic.	CONTROL
USER ACCESS NOT VALID.	You tried to perform an operation for which you are not authorized. Possible causes include attempts to access a file or equipment which you are not authorized to access.	Ensure accuracy of command or determine proper validation requirements via LIMITS command.	LFM
USER ACCESS NOT VALID.	You tried to perform an operation for which you are not authorized. Possible causes include attempts to <ul style="list-style-type: none"> - Run a system origin job from nonsystem origin. - Access a restricted subsystem without proper validation. - Enter an incorrect SRU value. - Use the V carriage control character without validation. 	Ensure accuracy of command or macro, or determine proper validation requirements via LIMITS command.	DSD EXUBUT EXCSLV MSI QFSP RESEX 1MA IAFEX
USER ACCESS NOT VALID.	The user name or password could not be validated, or a secondary USER command was encountered while secondary USER commands were disabled.	Verify that user name and password are valid. If secondary USER commands are disabled, ensure that no secondary USER commands are present.	CPM

<u>MESSAGE</u>	<u>SIGNIFICANCE</u>	<u>ACTION</u>	<u>ROUTINE</u>
USER ACCESS NOT VALID.	The SRU or time limit request is outside of your validated range.	Retry with a lower value.	CONTROL
USER ACCESS NOT VALID.	One of the following: <ul style="list-style-type: none"> - You are not authorized to create direct access or indirect access files. - You are not authorized to access auxiliary devices. - Your job made a CATLIST request for permit information on a file that has a higher access level than that of your job. 	Contact your site administration about obtaining the necessary validations. For CATLIST request, resubmit the request after raising your job's access level.	PFM
USER CANNOT SWITCH FROM SECONDARY APPLICATION.	You attempted to enter an APPSW command from a secondary application.	To return to your primary application, log out of your secondary application. If you wish to switch to a third application, you can enter another APPSW command from your primary application.	TLX
USER NOT VALIDATED FOR SECONDARY APPLICATION.	You submitted an APPSW command specifying an application for which you are not validated.	To check your current validations, enter a LIMITS command. If you require validation for additional applications, see your site administration.	TLX
USER SECURITY COUNT EXHAUSTED.	The security count for the user name specified has been decremented to zero. You are denied all access to the operating system until the operator resets your security count.	Contact site personnel to reestablish access.	CPM
VEJ - BUFFER ARGUMENT ERROR.	Dayfile message indicating that FET buffer pointers are incorrect. (FWA<LWA<FL) was not true or TID (terminal id) with complement address was not within the field length.	Write a PSR and include support materials to allow CDC to duplicate the problem.	VEJ
VEJ - INCORRECT REQUEST.	Dayfile message indicating that one of the following conditions has occurred: <ul style="list-style-type: none"> - VEJ was not called by a subsystem. - The FET address was out of range. 	Write a PSR and include support materials to allow CDC to duplicate the problem.	VEJ
VSN FILE ERROR.	Dayfile message indicating that a RESEX internal problem occurred (VSN file entry does not match job identification).	Reenter the command or rerun the job. If the problem recurs, inform your site analyst or contact Central Software Support.	RESEX
pfn WAITING ALTERNATE STORAGE EXEC.	The file must be staged from alternate storage to disk and the alternate storage executive is not currently available to perform the stage operation.	Wait for executive to be started or inform site operator that the alternate storage executive should be initialized.	PFM
WAITING FOR MAGNET.	The job is waiting for the magnetic tape subsystem to be activated.	Wait for the operator to activate MAGNET or terminate job.	RESEX
WAITING FOR NFL.	Informative message stating that your job has been delayed and/or rolled out waiting for NFL space. The job has not been aborted; it will eventually continue. The message is visible via ENQUIRE.	None.	PFM
WAITING FOR PN=packname, type.	The job is waiting for the operator to mount pack packname on device type type.	Wait until the operator mounts the requested pack or terminate job.	RESEX

<u>MESSAGE</u>	<u>SIGNIFICANCE</u>	<u>ACTION</u>	<u>ROUTINE</u>
WAITING FOR RESOURCE FILE.	The job is waiting for the resource demand file or VSN file to become available.	Wait until resource file becomes available or terminate job. To operator: If job is not rolled out and this message persists, inform site analyst or drop the job. If the operator decides to override an interrupted job at this point, the preview data in the demand file is not cleared and the E,P display continues to show the VSN request associated with the job until you log off or issue a subsequent request for tape or pack.	RESEX
WAITING FOR RESOURCES.	The job is waiting for sufficient resources to allow assignment of the tape/pack without causing a system deadlock.	Wait until the resources become available or terminate job.	RESEX
WAITING FOR VSN= vsn, type.	The job is waiting for the operator to mount the tape with VSN vsn on the specified type (MT, HD, PE, or GE). VSN= SCRATCH indicates that any scratch tape is acceptable.	Wait for the operator to mount the tape or terminate the job.	RESEX
WAITING - INACCESSIBLE DEVICE	Your job has been rolled out waiting for an inaccessible mass storage device. The device is off, down, or is encountering hardware errors.	Inform site analyst.	1RJ
WAITING ON TRACK LIMIT.	The job is waiting for additional tracks on the familyname device containing the resource demand and VSN files.	Wait for the additional tracks or terminate job.	RESEX
WRITE-DOWN OF DATA PROHIBITED.	One of the following: <ul style="list-style-type: none"> - On an APPEND or REPLACE command or macro, the access level of the local file is higher than the access level of the permanent file. - On a DEFINE command or macro, the access level of a local file having the same name as the file specified has a lower access level than the job. - On a CHANGE, PERMIT, or SETPFAC command or macro, the access level of the specified permanent file is lower than that of the job. 	Retry using a higher access level for the permanent file (APPEND or REPLACE), or change the job's access level and then retry (DEFINE, CHANGE, PERMIT, or SETPFAC).	PFM
WRITE-DOWN PROHIBITED ON FILE, filename AT address.	The access level of your job is higher than the access level of file filename, and the file is a tape file or a direct access file.	None. You may not write on this file while your job is at the current access level.	1MS
WRITE ON READ-ONLY FILE filename AT address.	Either you attempted to write on a file with write lock-out, or the direct access file was not attached in write mode.	Reattach file in write mode or clear write interlock.	1MS IAFEX
WRITE OVER LABEL ILLEGAL.	You attempted to write over the VOL1 label.	Have the operator blank label the tape.	1MT
WRITE TAPE MARK ERROR	The tape subsystem was unable to write a tape mark on the tape being written, probably as a result of a bad tape.	Replace tape and try again. If problem persists, try another tape drive. If problem still occurs, inform site analyst.	1MT
WRITEDOWN PROHIBITED ON FILE FILENAME AT address.	The access level of your job is higher than the access level of file filename, and the file is a tape file or a direct access permanent file.	None. You may not write on this file while your job is at the current access level.	1MS
WRONG PARITY, filename AT address.	A seven-track tape is being read in opposite parity from which it was written.	Ensure accuracy of format parameter (F) on command or macro.	1MT

<u>MESSAGE</u>	<u>SIGNIFICANCE</u>	<u>ACTION</u>	<u>ROUTINE</u>
XD/XT EXCEEDS MAXIMUM.	The XD parameter for a password or file permission is more than the maximum number of days past the current date, or the XT parameter is larger than the maximum allowed.	Correct XD or XT parameter and retry.	PFM
XL BUFFER/FET PARAMETER ERROR, filename AT address.	One of the following: <ul style="list-style-type: none"> - HDR1 label in extended Label buffer or FET contains a nonnumeric display code value in a numeric field. - Character count in header word preceding labels in the extended Label buffer does not equal 80. 	Correct condition that caused error and retry.	1MT
200 BPI WRITE INCORRECT.	The tape unit (667 or 677) cannot record data at 200 bpi.	Specify a different tape density.	1MT

GLOSSARY

C

Abort

To terminate a program, job, or job step when an error condition (hardware or software) exists from which the program or computer cannot recover.

Absolute Assembly

In the context of this manual, a COMPASS program assembled with the ABS pseudo instruction in which there are no references to external entry points. Compare with Relocatable Assembly.

Access Category

Refer to File Access Category, Job Access Category Set, and System Access Category Set.

Access Level

A property of each file, job, and equipment on a secured system that is used to indicate the sensitivity of information in the file or job, or the sensitivity of information that can be processed by the equipment. On a secured system, there are up to eight access levels corresponding to increasing levels of sensitivity, and each user is authorized to access some or all of those levels. Refer also to Equipment Access Levels, File Access Level, Job Access Level, and System Access Levels.

Access Level Limits

Refer to Job Access Level Limits.

Account Block

A string of commands between two CHARGE commands or between a CHARGE command and end-of-job.

Allocatable Device

A storage device allocated by the system without operator intervention that can be shared by more than one job.

Alphanumeric

Consisting of alphabetic and/or numeric characters only.

Alternate User Name

A user name specified in a permanent file request which indicates the action is to be taken on an alternate user's permanent file.

ANSI

American National Standards Institute. An organization that establishes standards for the benefit of its member organizations.

ASCII

American National Standard Code for Information Interchange. The standard character set and code used for information interchange between systems.

Auto Recall

The act of a program releasing control of the CPU until a requested function is complete. Refer to Recall.

Auxiliary Device

Mass storage device that is not part of a permanent file family. Auxiliary devices can contain direct or indirect access permanent files.

Block

A grouping of user records created for efficiency in transfer between memory and storage devices. For magnetic tapes, it is the information between interrecord gaps. Block size is specified with the LABEL macro for L format tapes.

BOI

Refer to Beginning-of-Information.

Buffer

An intermediate storage area used to compensate for a difference in rates of data flow, or times of event occurrence, when transmitting data between central memory and an external device during input/output operations.

Byte

A group of 12 bits. Five bytes comprise a 60-bit central memory word. Bytes are numbered 0 through 4 from the left.

Central Memory (CM)

The main storage device whose storage cells (words) can be addressed by a computer program and from which instructions and data can be loaded directly into registers from which the instructions can be executed or from which data can be manipulated.

Central Processor Unit (CPU)

The high-speed arithmetic unit that performs the addition, subtraction, multiplication, division, incrementing, logical operations, and branching instructions needed to execute programs.

Checkpoint

The process of writing to a magnetic tape or mass storage file a copy of your job's central memory, the system information used for job control, and the names and contents of all assigned files that are identified in a CHECKPT request.

Checkpoint File

File on which the results of a partially completed job are dumped when a checkpoint request is processed.

Checksum

A numeric value used to verify a file.

Circular Buffer

A temporary central memory storage area that contains data during input/output operations. Routines that process I/O treat the first word of the buffer area as contiguous to the last word of the buffer area.

Coded Mode

Refers to the setting of the coded mode bit in the FET of the READCW/WRITECW header word. The setting of this bit is used to interpret data as binary or coded. Coded data goes through code conversion to/from a different character set (BCD on 7-track, ASCII or EBCDIC on 9-track).

Command Record

The first, and possibly only, record of a job file consisting of command images that start with the Job command and end with the first EOR, EOF, or EOI. Also refers to a procedure containing commands.

Common Deck

A subprogram or group of macro or symbol definitions that are accessed from a program library using the Modify CALL directive or COMPASS XTEXT pseudoinstruction.

Compare/Move Unit (CMU)

The hardware that executes the CPU instructions for moving and comparing data fields consisting of strings of 6-bit characters.

COMPASS

The standard assembly language used with CYBER 170, CYBER 70, and 6000 Computer Systems. Also, the command used to assemble a program written in the COMPASS assembly language.

Control Byte

A 12-bit code that changes the current input or output mode at an interactive terminal.

Control Point

The portion of central memory that is assigned to a job. When a job is allocated a portion of central memory, it becomes eligible for assignment to the central processor for execution.

Conversion Mode

Refers to the CV parameter in the LABEL command. The conversion mode specifies the character set used to convert coded data and labels.

CPU

Refer to Central Processor Unit.

CYBER Loader

The utility that prepares programs for execution by placing program instruction and data blocks in central memory.

CYBER Record Manager (CRM)

A software product that allows a variety of record types, blocking types, and file organizations to be created and accessed. Products like COBOL 5, FORTRAN Extended 4, FORTRAN 5, Sort/Merge 4, Sort/Merge 5, ALGOL 5, and DMS 170 use CRM to manage execution time input/output. Neither the input/output of the operating system nor that of most of the system utilities such as COPY or SKIPF is implemented through CYBER Record Manager. All CYBER Record Manager file processing requests ultimately pass through the operating system input/output routines.

Dayfile

A chronological file created during job execution which forms a permanent accounting and job history record. Dayfile messages are generated by operator action or when commands are processed. A copy of the dayfile is printed with the output for each job. You must explicitly request it in an interactive job.

Default

A system-supplied option used when you do not supply the option.

Device Type Code

The 12-bit display code of the type of device upon which a file resides.

Direct Access File

A NOS permanent mass storage file that can be attached to the your job. All changes to this file are made on the file itself rather than a temporary copy of the file (compare with Indirect Access File).

Display Code

A 6-bit character code set used to represent alphanumeric and special characters.

Disposition Code

A two-character mnemonic indicating destination queue and format for processing a file named on a ROUTE function.

ECS

Extended Core Storage. Refer to Extended Memory.

Empty PRU/Record

A PRU that contains no user data. Refer also to Zero Length PRU.

End-of-File (EOF)

A boundary within a sequential file, but not necessarily the end of a file that can be referenced by name. The actual end of a named file is defined by EOI. For labeled tape, EOF and EOI (denoted by the EOF1 label) are the same. For multiframe tape files, EOF and EOI do not correspond. In the product set manuals, an end-of-file is also referred to as an end-of-partition.

End-of-Information (EOI)

The end of data on a file. Information appearing after this point is not considered part of file data. In card decks, a card with a 6/7/8/9 multiple punch in column 1. On mass storage devices, the position of the last written data. On labeled tape, it is the EOF1 label. CYBER Record Manager defines end-of-information in terms of file residency and organization.

End-of-Line (EOL)

A separator in coded files that is represented by 12 bits of zero, right-justified in a 60-bit word. In some cases, up to 66 bits of trailing zero bits are considered an end-of-line.

End-of-Record (EOR)

The terminator of a logical record. On a PRU device, a short PRU or a zero length PRU with a level designator of 0 indicates EOR. On tapes that are not PRU devices, an interrecord gap indicates EOR.

End-of-Tape (EOT)

A reflective strip near the end of a magnetic tape. It is used to signal termination of operations on a particular tape volume. At least 5.5 metres (18 feet) of tape must follow this marker.

Entry Point

A location within a program or procedure that can be referenced from other programs. Each entry point has a unique name with which it is associated. Refer to External Reference.

EOF

Refer to End-of-File.

EOI

Refer to End-of-Information.

EOL

Refer to End-of-Line.

EOR

Refer to End-of-Record.

EOT

Refer to End-of-Tape.

Equipment Access Levels

A range of access levels specified for each equipment on a secured system. In order for a file to be stored or output on a given equipment, the file's access level must be within the equipment access levels for that equipment.

Equipment Code

Refer to Device Type Code.

Equipment Status Table (EST)

A list of all peripheral devices connected to the system. Each table entry indicates the status of a particular device.

EST Ordinal

The number designating the position of an entry within the equipment status table (EST) established at each installation. Devices are identified in operator commands by EST ordinals.

Exchange Jump

Execution of a CPU program is initiated by an exchange jump. The program is defined by the contents of the exchange package area before the exchange jump took place. For the program to execute, the proper contents of its operational registers must be loaded into the CPU. These register contents are what is contained in the exchange package area associated with the program.

Exchange Package

A 208-word table containing information used in exchange jumps during job execution: contents of central processor registers, RA and FL in central memory and in extended memory, and the program address. The table is stored in the job's field length and can be printed as part of the output of a central memory dump.

Exit Mode

A group of flags that specify the types of errors that can cause the CPU to abort.

Extended Core Storage (ECS)

A type of extended memory that is an option available for 6000 Computer Systems, CYBER 70 Computer Systems, CYBER 170 Computer Systems (except for models 176), and CYBER 180-class machines. Refer to Extended Memory.

Extended Labeled Processing

A tape processing mode in which all tape labels (including optional labels) are read into a label buffer for further processing.

Extended Memory

An additional portion of memory available as an option. This memory can be used for program and data storage, but not for program execution. Special hardware instructions exist for transferring data between central memory and extended memory. Extended memory consists of either extended core storage (ECS), large-core memory extended (LCME), extended semiconductor memory (ESM), or unified extended memory (UEM).

Extended Semiconductor Memory (ESM)

A type of extended memory that is an option available for 6000 Computer Systems, CYBER 70 Computer Systems, CYBER 170 Computer Systems (except for models 176), and CYBER 180-class machines. Refer to Extended Memory.

External Reference

A reference in a program to an entry point in another program. Throughout the loading process, externals are matched to entry point (this is also referred to as satisfying externals); that is, addresses referencing externals are supplied with the correct address.

Family Device

Mass storage permanent file device associated with a specific system. A family may consist of from 1 through 63 logical devices. Normally, a system runs with one family of permanent file devices available. However, additional families may be introduced during normal operation. This enables users associated with the additional families to access their permanent files via the alternate family.

Fast Dynamic Loader (FDL)

A facility that provides fast loading and unloading of specially formatted code called capsules. The amount of memory required for job execution can be greatly reduced because capsules can be easily loaded and unloaded as needed, freeing memory for other uses.

FET

Refer to File Environment Table.

Field Length

The area in central memory allocated to a particular job; the only part of central memory that a job can directly access. Also the number of central memory words required to process a job.

Field Length Extended (FLE)

Amount of extended memory assigned to an executing job.

File

1. A set of information that begins at beginning-of-information (BOI), ends at end-of-information (EOI), and is referenced by a local file name.

2. That portion of a multifile file terminated by an end-of-file (EOF).
3. Data recorded on a magnetic tape beginning after an HDR1 label and ending before an EOF1 label.

NOS commands requiring a parameter that is a file name refer to definition 1. Commands requiring a parameter that specifies the number of files refer to definition 2. Definition 3 applies only to labeled magnetic tapes.

File Access Category

A property of a permanent file used by the creator of the file on a secured system to restrict access of the file to a particular group of users. A secured system supports up to 32 access categories, and each user is authorized to use some, all, or none of those categories. Refer also to Job Access Category Set and System Access Category Set.

File Access Level

A property of each file on a secured system used to indicate the sensitivity of information contained on the file. A file is assigned the current job access level by default when it is created or stored; the file creator may specify any access level for that file that is within the set of access levels valid for the job, the system, the file creator, and (for interactive jobs) the communication line to the host mainframe. Any user who accesses a file on a secured system must be validated for the access level of the file. Refer also to Access Level, Job Access Level, and Job Access Level Limits.

File Environment Table (FET)

A table within a program's field length that defines the current status and properties of a file being used by the program. The program communicates with operating system input/output routines through the FET. One FET exists for each file in use by the program.

File Flushing

The process of writing the contents of a file's circular buffer to mass storage when certain conditions are met.

File Name Table (FNT)

A system-managed table that contains job control information for all active files in the system. Files that are local to a job have an entry in the job's local file name table (refer to Local File Name Table); system files have an entry in the system file name table (refer to System File Name Table). Each file name table entry consists of a file name table word, a file status table word, and, for local files, a file utility table word.

File Name Table (FNT) Word

The first word of every file name table entry. This word contains the local file name, file type, and other job control information.

File Set

One or more tape files referred to by the set identifier on a tape assignment command or macro. A file set may consist of:

1. One file recorded on a single volume.
2. More than one file recorded on a single volume.
3. One file recorded on more than one volume.
4. More than one file recorded on more than one volume.

All files within a file set have the same set identifier in their HDR1 labels.

File Status Table (FST) Word

The second word of every file name table entry. This word contains information pertaining to the file's location on mass storage and other job control information.

File Utility Table (FUT) Word

The third word of every file name table entry. This word contains the 12-bit installation area for the file; the remainder of the word is reserved for future use.

FL

Refer to Field Length.

Flag

A character or bit that signals the occurrence or presence of a particular condition.

FLE

Refer to Field Length Extended.

FNT

Refer to Local File Name Table.

FNT Word

Refer to File Name Table Word.

Foreign Tape

NOS classifies all non-CDC standard tapes into either of two tape groups, foreign or stranger. The foreign tapes are defined by the F data format, which has an unknown maximum block size. Contrast with Stranger Tape.

Frame

A tape recording unit made up of 1 bit from each tape track (7 bits for 7-track tape and 9 bits for 9-track tape). Each frame on a coded tape usually represents one character.

FST Word

Refer to File Status Table Word.

Full Track (FT)

Reading/writing sequential sectors on a rotating mass storage device.

Function Processor

A system CPU or PP program that the user can call by placing a request in location RA+1. Function processors perform input/output, local and permanent file manipulations, and so on.

Generation

The position of a file within a series of files, each file developed from the preceding file. The generation number and generation version number of a tape file can be entered in its HDR1 label.

Global Library Set

An ordered set of libraries used for program loads and for satisfying externals; these libraries remain in effect throughout job execution unless specifically changed.

Half Track (HT)

Reading/writing alternate sectors on an 844 or 885 disk pack.

Indirect Access File

A NOS permanent file that is accessed by making a temporary copy of the file (GET macro). It is created or altered by saving or replacing the contents of an existing working file (REPLACE or SAVE macro).

Input File Type

Job file. Its first record is a control statement record, which may be followed by records containing data, directives, or programs used by job steps.

Interactive Programs

CPU programs in which the user and the computer communicate with each other.

Interrecord Gap

Space skipped between the writing of data blocks on magnetic tape.

Interrupt

To stop a running program in such a way that it can be resumed at a later time. Also a special control signal which, when issued, causes action as described by the program.

Job Access Category Set

On a secured system, a set of access categories is set when the job is initiated. This set is the intersection of the user's set of validated access categories and the system access category set. Refer also to File Access Category and System Access Category Set.

Job Access Level

On a secured system, each job has an access level. This is the default access level that is assigned to files that are created or stored in the job. A job's initial access level is the lower access level limit for the job. The job's access level is automatically raised to the access level of any file from which information is read. The job access level can also be changed by the user. Refer also to Job Access Level Limits.

Job Access Level Limits

An upper limit and a lower limit that determine the range of access levels that are valid for a particular job on a secured system. All files used in a given job must have an access level within the job's access level limits.

Job Step

An individual command, procedure or loader sequence. A group of job steps forms a job stream, command record, or procedure file.

Label

A block at the beginning or end of a magnetic tape volume or file, which serves to identify and/or delimit that volume or file.

Large Central Memory Extended (LCME)

A type of extended memory that is an option available for model 176. Refer to Extended Memory.

LCME

Refer to Large Central Memory Extended.

Level Designator

Refer to Level Number.

Level Number

The level number is an octal number in the terminating marker of a PRU, ranging from 00 to 17 (octal). A level 17 in an empty PRU designates an EOF. A level 0 in a short PRU designates an EOR. A level designator of 1 is used as a flag to indicate that a short PRU of data is actually a line of input data from a terminal. The level designator is returned to the FET for some read functions and to the trailing control word for a READCW function.

lfn

Refer to Local File Name.

Library

A file or collection of files containing executable programs and tables needed to locate and load the programs. A system library can contain peripheral processor programs in addition to the central processor programs. A user library is file formatted as a library but is not available to a job until it has been explicitly declared via CYBER Loader commands or macros.

Library File

Either a read-only file that can be accessed by several users simultaneously or a file you specify on a LIBRARY command.

Line

Refer to Zero-Byte Terminator and End-of-Line.

List of Files

A table containing names of files that are to be considered for file flushing.

Load Point

Metallic strip marking the beginning of the recordable portion of a magnetic tape. Data, including labels, is written after the load point. A rewind positions a single file volume to the load point.

Local File

Any file that is currently associated with a job. Local files include all temporary files and attached direct access files.

Local File Name

The file name assigned to a file while it is local (assigned) to a job. The name is contained in the local file name table.

Local File Name Table (FNT)

A system-managed table that contains the local file name, the file type, and other job control information.

Locked File

A file on which you cannot write.

Logical Identifier (LID)

A three-character alphanumeric string used to identify a particular mainframe in a loosely coupled network. LIDs are identified by your site.

Logical Record

A data grouping that consists of zero or more PRUs and ends with a short PRU or a zero-length PRU.

Macro

A sequence of source statements that are saved and then assembled whenever needed through a macro call.

MLRS

Maximum logical record size. A number that specifies the maximum size for a logical record for S and L tape formats.

Multifile File

A file containing more than one logical file. It begins at BOI and ends at EOI. On a labeled tape, a multifile file is delimited by corresponding HDR1 and EOF1 labels.

Multifile Set

A tape file set having more than one tape file.

Network

A data and message switching and routing system used to provide communication between terminals, applications, and mainframes.

Network Terminal

A terminal that communicates with the operating system through the network.

Nonallocatable Device

A device (such as a magnetic tape unit, card reader, card punch, or line printer) which can be used only by one job at a time.

Nonstandard Tape Label

A tape label format for a tape whose data cannot be processed by the system because the label is not one of the supported label types. If the tape is at load point, a subsequent read operation skips to the first tape mark.

Old Program Library (OPL)

A Modify-formatted program library that contains source code for system routines and common decks.

opdef

A sequence of source statements that are saved and then assembled whenever needed through an opdef call. Differs from a macro in that the assembler interprets the call by examining the format or syntax of the instruction rather than the contents of the operation field alone.

OPL

Refer to Old Program Library.

Overlay

One or more relocatable program modules that have been relocated and linked into a single absolute program. It can be a main, primary, or secondary overlay.

Pack Name

A one- through seven-character name that identifies the auxiliary device to be accessed in a permanent file request.

Parameter

A variable that is given a specific value for a particular purpose or process.

Parity

In writing data, an extra bit is either set or cleared in each byte so that every byte has either an odd number of set bits (odd parity) or an even number of set bits (even parity). Parity is checked on a read for error detection and possible recovery.

Password

1. A system access word that must be used in addition to the user name at login.
2. A file access word that controls access to a particular file by alternate users.

Peripheral Processor (PP)

The hardware unit within the host computer that performs physical input and output through the computer's data channels.

Permanent File

A mass storage file that is cataloged by the system so that its location and identification are always known to the system. Permanent files cannot be destroyed accidentally during normal system operation. They are protected by the system from unauthorized access according to privacy controls specified when they are created.

Permanent File Catalog (PFC)

A 16-word entry that the system maintains and uses to determine attributes of a permanent file.

Permanent File Family

Permanent files which reside on the family devices of a specific system.

Physical Record

On magnetic tape, information between interrecord gaps (refer to Block). It need not contain a fixed amount of data. For mass storage, refer to Physical Record Unit.

Physical Record Unit (PRU)

The amount of information transmitted by a single physical operation of a specified device. For mass storage files, a PRU is 64 central memory words (640 characters); for magnetic tape files, the size of the PRU depends upon the tape format. A PRU that is not full of user data is called a short PRU; a PRU that has a level terminator but no user data is called a zero-length PRU.

PP

Refer to Peripheral Processor.

Preserved File

A mass storage file that is recovered on all levels of system deadstart. These include permanent files, queued files, and system dayfiles.

Primary File

A temporary file created with either the OLD, NEW, LIB, or PRIMARY command or the PRIMARY macro for most systems. The primary file is assumed to be the file on which most operations are performed unless another file is specified. There can be only one primary file associated with a job. The primary file is rewound before each job step given.

Print File

An output file containing data to be printed at a central site or remote batch line printer.

Private Auxiliary Device

Auxiliary device associated with a specific user name. Only that user name may create files on the device, although other users may be permitted to access files which reside on the device.

Program Library

The file generated by Modify that contains the decks of line images. Line images in the program library are in a format that can be manipulated by Modify.

PRU

Refer to Physical Record Unit.

PRU Device

A magnetic tape file or a mass storage device. Records on these devices are written in physical record units (PRUs).

Pseudoinstruction

An assembler-defined instruction appearing in the operation field of a statement. It normally does not specify the assembly of a single machine instruction, but instead specifies some other assembly process (such as symbol definition or listing control).

Public Auxiliary Device

Auxiliary device available for access by all validated users knowing the correct pack name. Additional validation is required to create or replace files on an auxiliary device.

Punch File

Output file containing data to be punched on cards.

QFT

Refer to Queued File Table.

Qualified Symbol

A symbol defined when a qualifier is in effect during assembly. Through qualification, the same symbol can be referred to in different subprograms without conflict.

Queued File Table (QFT)

A central memory resident table containing a fourword entry for all active input and output queue files.

Random Access

Access method by which any record in a file can be accessed at any time. Applies only to mass storage files with an organization other than sequential. Compare with Sequential Access.

Random Address

The random address of a sector in a file is the number of sectors from the beginning of the file to that sector.

Random File

A file with an index entry to each record in the file. A file on a rotating mass storage device is a random file only when the random bit is set in the file environment table. The last record of the file is an index.

Recall

The state of a program when it has released control of the central processor until a fixed time has elapsed (periodic recall) or until a requested function is completed (auto recall). Recall is a system action request as well as an optional parameter of some file action requests.

Record

Refer to Logical Record.

Record Separator

In NOS, another name for an end-of-record (EOR).

Reel

Refer to Volume.

Reference Address (RA and RAE)

RA is the absolute central memory address that is the starting or zero relative address assigned to a program. Addresses within the program are relative to RA. RA+1 is used as the communication word between the user program and the system. RAE is the absolute extended memory starting address assigned to a program.

Register

A register is a storage device used to hold binary data. There are 24 hardware registers (eight A registers, eight B registers, and eight X registers) in the CPU that can be directly controlled by a COMPASS program. The A registers contain addresses of words in central memory, the B registers are used for incrementing and indexing, and the X registers contain operands used in calculations and the results of these calculations. Other hardware registers contain information that is used by the operating system or by system hardware.

Relative Address

All addresses in a relocatable program are relative to a base address of zero. When a relocatable program is loaded for execution, the zero base address is assigned to a reference address. At that time, all addresses in the program become relative to the reference address.

Relocatable Assembly

An assembled program that contains references to external entry points. Compare with Absolute Assembly.

Removable Device

A rotating mass storage device that the system can make unavailable. It is not necessary that the device be physically detachable from the rotating mass storage drive.

Rollout

The removal of jobs from central memory to mass storage before execution is complete, so the control point and central memory can be assigned to another job. A job is rolled out when it is waiting for an external event, when its control point and/or central memory is needed by a higher priority job, or when it exceeds its central memory time slice.

Rollout File

A file containing a job (and system information) that has been temporarily removed from the main processing area of the system.

Rotating Mass Storage (RMS)

A disk storage device.

Sector

Refer to Physical Record Unit.

Secured System

A system in which a mandatory security mechanism has been enabled during deadstart. A secured system protects information by enforcing restrictions based on access levels and access categories, and restricts many sensitive system functions to security administrators.

Security Administrator

A secured system prevents users and operators from performing certain functions that could result in the unauthorized disclosure of information. These functions can only be performed by a person who is designated a security administrator. A security administrator is always authorized to access the highest level of information stored on the system. This person performs functions in the areas of installation, user validation, system operation, and system maintenance.

Security Count

The number of security violations you have left before you are denied access to the system.

Security Unlock Status

This status of the system console applies only to a secured system and must be set by a security administrator. The console must be in security unlock status in order for the security administrator to perform certain functions that are restricted on a secured system.

Sense Switches

Six 1-bit flags located in the user's control point area and in bits 11 through 6 of RA+0 of the job field length. These bits can be used to communicate with system routines (refer to the ONSW and OFFSW macros in section 6).

Sequential Access

A method in which only the record located at the current file position can be accessed. Refer to Random Access.

Sequential (SQ) File

A file in which records are accessed in the order in which they occur. Any file can be accessed sequentially.

Short PRU

A PRU that does not contain the maximum amount of character data allowed for a PRU. Refer to Zero-Length PRU.

Special Entry Point

An entry point that enables system programs to perform special functions.

SRU

Refer to System Resource Unit.

Standard Labeled Tape

A tape with labels conforming to American National Standard Magnetic Tape Labels for Information Interchange X3.27-1969. Also called a system labeled tape.

Stranger Tape

NOS classifies all non-CDC standard tapes into either of two tape groups, foreign or stranger. The stranger tapes are defined by the S data format, which has a maximum block size of 1000₈ CM words. Contrast with Foreign Tape.

Symbol

A set of characters that identifies a value and its associated attributes.

System Access Category Set

On a secured system, a set of access categories are set during level 0 deadstart. This set may consist of some, all, or none of the 32 possible access categories. While the system is running, users may only use access categories that are within the set of system access categories. Refer also to File Access Category and Job Access Category Set.

System Access Levels

On a secured system, a range of access levels is set during level 0 deadstart. This range may contain some or all of the eight possible access levels. While the system is running, users may only use access levels that are within the range of system access levels.

System File

A file that can be accessed only by a system program.

System File Name Table

A system-managed table that contains a file name table entry for the various system files.

System Labeled Tape

Refer to Standard Labeled Tape.

System Library (SYSLIB)

The collection of tables and object language programs that reside in central memory or on mass storage and are necessary for running the operating system and its product set.

System Request

A request placed in location RA+1 for a function processor to perform a special process.

System Resource Unit (SRU)

A unit of measurement of system usage. The number of SRUs includes the central processor time, memory usage, and input/output resources used for a given job.

System Text

A set of tables containing symbol, micro, macro, and opdef definitions that can be saved on a file to be accessed by other programs.

Tape Format

A parameter that specifies the internal recording format of a magnetic tape.

Tape Mark

A delimiter written on tapes under operating system control to separate label groups, files, and/or labels. Interpretation depends on the tape format.

Temporary File

A file that is currently associated with a job and is not a permanent file. Temporary files cease to exist when they are returned to the system (either by means of a command or macro or upon job termination).

Time Slice

The amount of CPU or CM time a job is allowed to use before the system lowers its priority to allow other jobs to execute.

Timed/Event Rollout

A condition in which an executing job has been temporarily removed from central memory but will be rolled back into central memory when a specified event (such as a file is no longer busy) or a specified time period has elapsed.

UEM

Refer to Unified Extended Memory.

Unified Extended Memory

A type of extended memory that is available as an option for CYBER 180-class machines and models 865 and 875. UEM differs from other types of extended memory in that it is a portion of central memory and not a separate memory unit. Refer to Extended Memory.

Unlabeled Tape

A magnetic tape that does not have a header label. Unlabeled tapes generated by the operating system contain a trailer label similar to the trailer for a standard labeled tape.

Unsecured System

A system in which the security mechanism has not been enabled during deadstart. The restrictions based on access levels and access categories are not enforced on an unsecured system.

User Index

A unique 17-bit identifier that is associated with each user name. The user index is used by the permanent file manager to identify the device and catalog track for the user's permanent files.

Validation File

File containing validation information for all users (user names, passwords, resources allowed, and so on).

Volume

A reel of magnetic tape. A given file can be composed of more than one volume.

Volume Serial Number (VSN)

A one- through six-character identifier that identifies the volume of magnetic tape to the system.

VSN

Refer to Volume Serial Number.

Word

A group of bits that occupy a single memory cell. A central memory or extended memory word is 60 bits in length. The bits are numbered 59 through 0 starting from the left. A word is also composed of five 12-bit bytes, numbered 0 through 4 from the left.

Write Ring

A circular device inserted into a tape reel indicating to the tape unit that it can write on that reel. NOS checks for the presence of a write ring if you request it.

Zero-Byte Terminator

The 12 bits of zero in the low order position of a central memory word that are used to terminate a line of coded information. A record with such a terminator in CYBER Record Manager is a zero-byte record (Z type record).

Files created interactively at a terminal and by commands that manipulate coded lines contain zero-byte terminated records. The image of cards input through a card reader also has such a terminator.

In 6-bit display code, two colons create 12 bits of zeros in the 64-character set. If two consecutive colons occur in a file that contains zero-byte terminated records, they might be stored in the lower order portion of a word and create a zero-byte terminator.

CIO-coded I/O operations, system commands, and dayfile processing macros use files whose lines are terminated by a zero byte.

Zero-Length PRU

A PRU that contains system information, but no user data. Under NOS, a zero-length PRU defines EOF.

INTERPRETIVE MODE READING AND WRITING OF EXTENDED MEMORY

D

Interpretive mode processing of extended memory read and write operations gives the COMPASS programmer an effective means of breaking up large block extended memory transfers and processing recoverable extended memory errors. The efficiency of long extended memory transfers tends to be degraded because of PP-initiated exchange jumps which force extended memory transfers to be completely restarted. Interpretive mode processing breaks up large blocks into smaller, 400g-word blocks, thereby minimizing the effects of these exchanges. Extended memory transfer errors are retried as a block transfer and then as single word transfers if necessary. If the error is recovered, it is logged in the system error log and is transparent to the user program. Unrecoverable errors are also logged and must be processed by the user program.

The interpretive routines are available on common deck COMCECS for absolute COMPASS programs and as relocatable routines in SYSLIB for relocatable COMPASS programs. Additionally, common deck COMCECM is provided to redefine the RE and WE COMPASS instructions. COMCECM is also available on systems text ECSTEXT. Thus, for absolute COMPASS programs, the user must either make specific calls to both common decks or call COMCECS and specify S=ECSTEXT on the COMPASS command (refer to the COMPASS Reference Manual). For relocatable COMPASS programs, you need only specify ECSTEXT as an alternate systems text on the COMPASS command.

Programs using interpretive mode reading and writing of extended memory do so with the usual RE and WE COMPASS instructions. If, while in interpretive mode, you desire to perform noninterpretive reading and writing of extended memory, the RD and WT instructions must be used. These instructions are defined on common deck COMCECM. These instructions read and write extended memory directly while in interpretive mode, as in the normal execution of the RE and WE instructions.

The instructions defined in ECSTEXT and common deck COMCECM are in the following formats.

```
inst   Bj
inst   K
inst   Bj+K
```

Instruction inst is one of the following.

<u>inst</u>	<u>Description</u>
RE	Read extended memory in interpretive mode
WE	Write extended memory in interpretive mode
RD	Read extended memory noninterpretively in interpretive mode
WT	Write extended memory noninterpretively in interpretive mode

SPECIAL USER INFORMATION

E

This appendix provides special information available to the applications programmer. The following topics are described.

- Job communication area
- Exchange package area
- File types and job origin codes
- Device types
- EJT status and connection status codes
- Service class types
- EJT job scheduling data formats
- Error flags

JOB COMMUNICATION AREA

Figure E-1 illustrates the first 100₈ words of the job's field length.

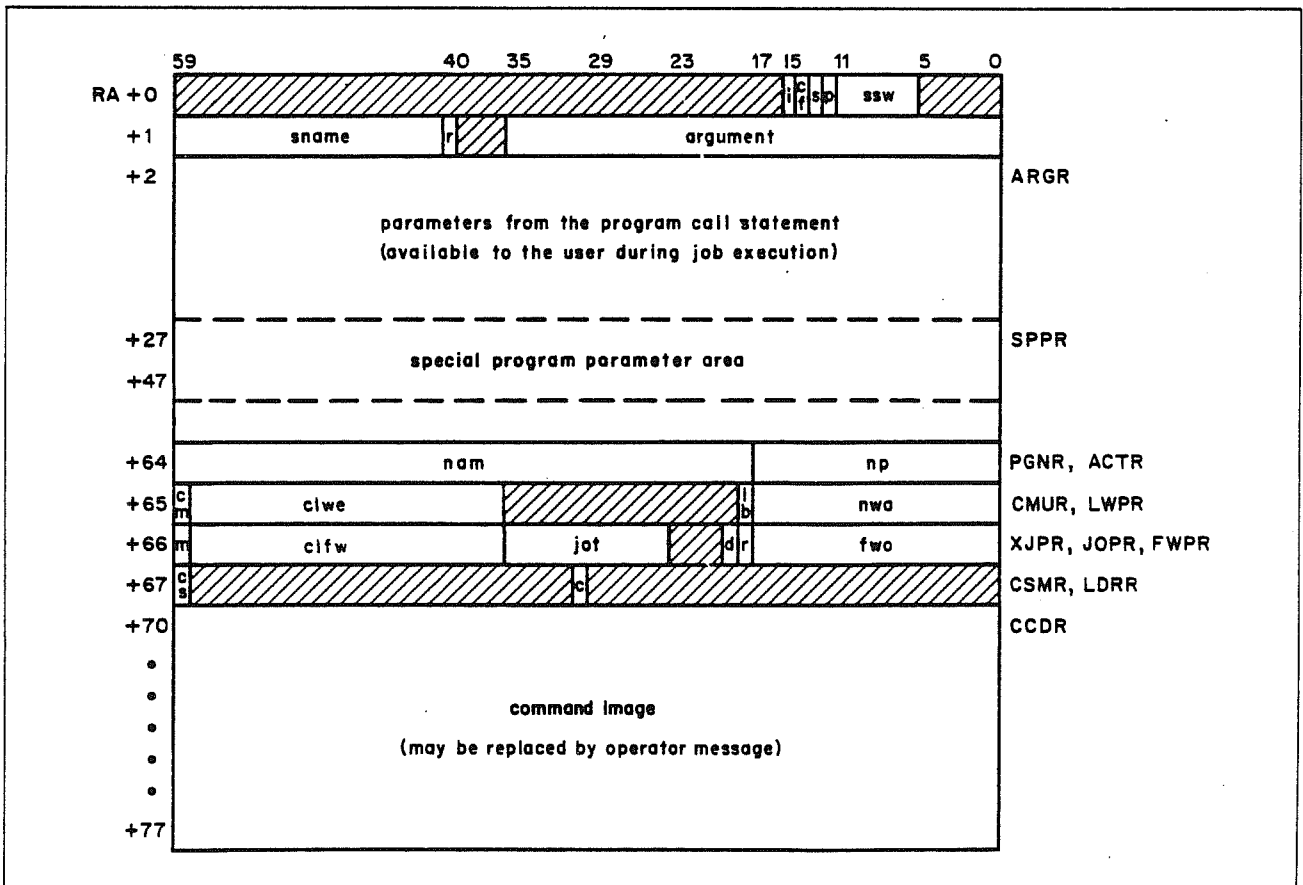

Figure E-1. Job Communication Area

<u>Word</u>	<u>System Identifier†</u>	<u>Bit(s)</u>	<u>Field</u>	<u>Significance</u>
RA+0		59-16	reserved	Reserved.
		15	i	Subsystem idledown flag.
		14	cf	CFO bit.
		13	s	Status bit for pause flag.
		12	p	Pause flag.
		11-06	ssw	Sense switches.
		05-00	reserved	Reserved.
RA+1		59-41	sname	System request name (such as CIO).
		40	r	Auto recall flag.
		39-36	unused	Reserved for future system use.
		35-00	arguments	Parameters passed to that portion of the system that processes the sname request.
RA+2 through RA+63 ₈	ARGR	59-00	params	Parameters from the program call command; available to the user during execution.
RA+64 ₈	PGNR	59-18	nam	Name of program called by command.
	ACTR	17-00	np	Number of parameters in command call.
RA+65 ₈	CMUR	59	cm	Set if the compare/move unit (CMU) is present.
	LWPR	58-36	clwe	LWA+1 of loadable area in extended memory.
		35-19	unused	Reserved for future system use.
		18	lb	Library flag: 0 Load from local file or user library. 1 Load from system library or global library set. (You can distinguish a global library load from a system library load by checking bit 48 of the word returned by the GETLC macro.)

†These symbols are available to a user program if the program calls the SYSCOM macro. The SYSCOM macro is available in both SYSTEXT and NOSTEXT.

<u>Word</u>	<u>System Identifier†</u>	<u>Bit(s)</u>	<u>Field</u>	<u>Significance</u>
		17-00	nwa	Address of next word available for loading. If Common Memory Manager is loaded in the job's field length, bits 17 through 0 contain the complement of the address of the next word available for loading (refer to the Common Memory Manager Reference Manual).
RA+66 _g	XJPR	59	m	Always set to 1 to indicate that the hardware feature CEJ/MEJ is available.
		58-36	clfw	FWA of loadable area in extended memory.
	JOPR	35-24	jot	Job origin type.
		23-20	unused	Reserved for future system use.
		19	d	DIS flag.
		18	r	RSS flag.
	FWPR	17-00	fwo	First word of object program.
RA+67 _g	CSMR	59	cs	Set if system is running in 64-character set mode.
	LDRR	58-30	unused	Reserved for future system use.
		29	c	Completion flag: 0 Load not completed. 1 Load completed.
		28-00	unused	Reserved for future system use.
RA+70 _g through RA+77 _g	CCDR	59-00	command image	Image of command currently being executed.

† These symbols are available to a user program if the program calls the SYSCOM macro. The SYSCOM macro is available in both SYSTEXT and NOSTEXT.

EXCHANGE PACKAGE AREA

Figure E-2 illustrates the exchange package area for CYBER 180-class models and models 865 and 875. This illustration and the description that follows it are intended for use by the applications programmer and, therefore, do not include descriptions of bits or fields not used by applications programs.

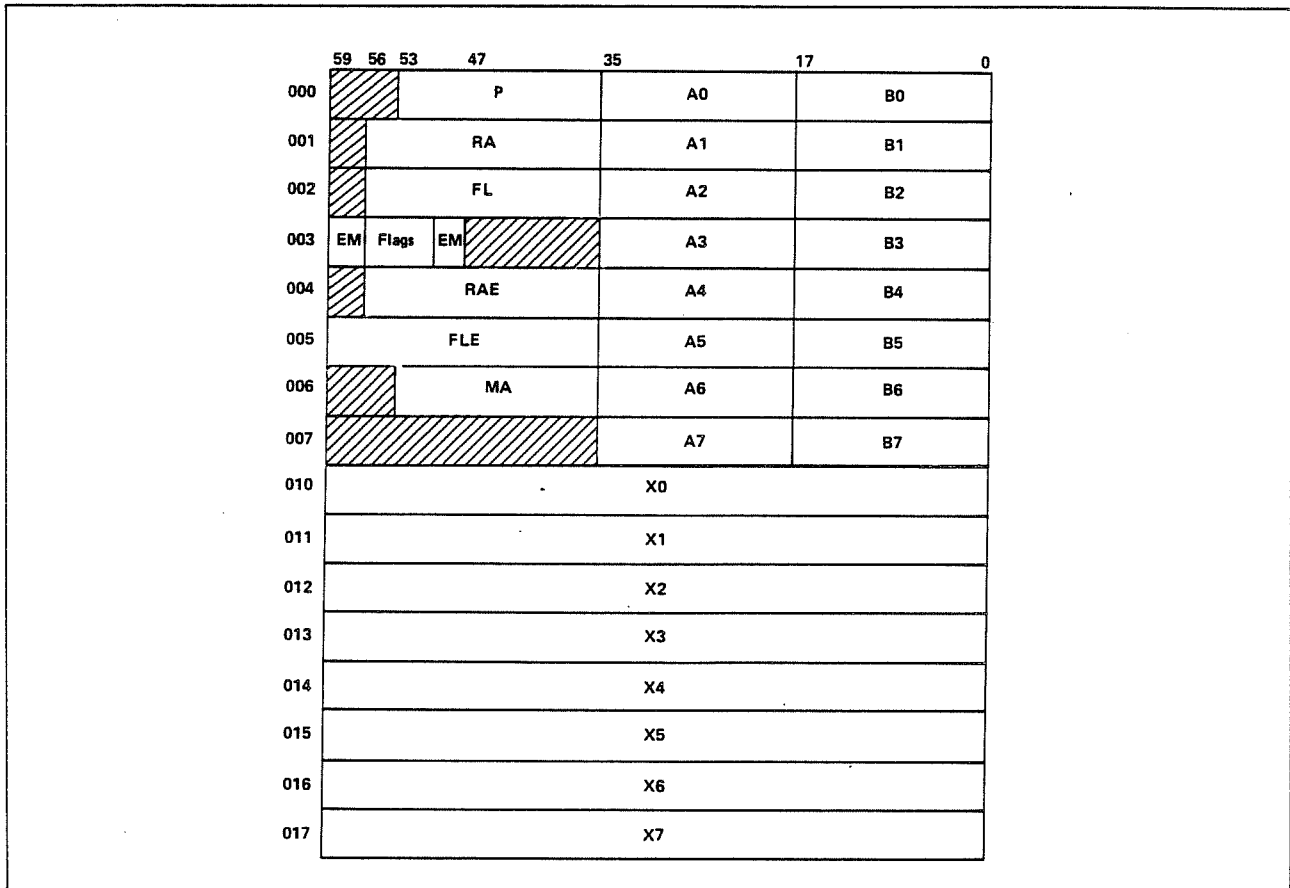

Figure E-2. Exchange Package Area

The exchange package area fields are defined as follows (fields are applicable to all NOS computer systems unless otherwise noted).

<u>Field</u>	<u>Description</u>
P	Program address ($0 \leq P < FL-1$).
A _i	Address registers.
B _i	Increment registers.
RA	Reference address for central memory.
FL	Field length for central memory.

FieldDescription

EM Exit modes. Specifies the error conditions that cause the system to exit normal processing. If a bit is set, and the corresponding error occurs, the system performs exit processing. If a bit is clear, and the corresponding error occurs, processing continues but may produce unexpected results.

Bits 48, 49, and 50 can be set and cleared by the MODE macro (refer to section 6). Bits 57, 58, and 59 are always set by the system and cannot be changed by the user.

<u>Bit(s)</u>	<u>Meaning When Bit is Set</u>
59	Exit on central memory read parity error or central memory double bit error. This bit is always set.
58	Exit on central memory write parity error. This bit is always set.
57	Exit on parity error on ECS flag register operation. This bit is always set.
50	Exit on indefinite operand.
49	All models except model 176: exit on operand out of range (infinite operand).
48	All models except model 176: exit on address out of range. Model 176: exit on underflow.†

Flags

BitDescription

56	UEM enabled.
55	Expanded addressing select (ESM mode flag).
54	Extended block copy flag.
53	Reserved.
52	Stack purging on models 815, 825, 835, 845, and 855 (reserved on other models).
51	Reserved.

COND

Error condition flags (model 176 only).

Bit(s)Description

47, 46	Reserved for Control Data.
45	Extended memory block range condition.
44	CM block range condition.
43	Extended memory direct range condition.
42	CM direct range condition.
41	Program range condition.
40	Not used.
39	Step condition.
38	Indefinite condition.
37	Overflow condition.
36	Underflow condition.

RAE

Reference address for extended memory.

FLE

Field length for extended memory. Bit 56 is zero for all applications programs.

Xi

Operand registers.

†An address out-of-range condition always causes a program exit on a model 176.

EJT CONNECTION STATUS CODES

The following EJT connection status codes are valid. (These mnemonics are defined in the system OPL common deck COMSEJT.)

<u>Code</u>	<u>Value (Octal)</u>	<u>Description</u>
NICS	0	Not interactive. There is no relationship between a job with this connection status and IAF. All batch, remote batch, and system origin jobs are assigned this connection status. A job in this state is not recoverable.
DTCS	1	Detached. A logical connection existed between a job with this type of connection status and an interactive device. However, the logical connection no longer exists (due to a detach command, line disconnect, IAF abort, or other condition). A job in this state continues to execute until an interactive request is issued. A job in this state is recoverable.
OLCS	2	On-line. A logical connection exists between a job with this type of connection status and an interactive device.
--	3-13	Reserved for Control Data.
--	14-17	Reserved for installations.

EJT JOB STATUS CODES

The following EJT job status codes are valid. (These mnemonics are defined in the system OPL common deck COMSEJT.)

<u>Code</u>	<u>Value (Octal)</u>	<u>Description</u>
PRJS	0	Preinitial job step. A job is in this state after it has been assigned to a control point for the first time. A job in this state is available to be scheduled to a control point.
EXJS	1	Executing. The job is currently at a control point.
ROJS	2	Scheduler rollout. The job was rolled out by the job scheduler because the job's scheduling priority is lower than the priority of another job in the rollout queue. A job in this status is waiting to be rolled in to a control point.
SIJS	3	SCP rollin. An SCP swapin request was issued to roll in the job. The job is currently waiting to be rolled in to a control point.
SOJS	4	SCP rollout. The job was rolled out due to an SCP swapout request. The job remains rolled out until its job status is changed to SIJS.

<u>Code</u>	<u>Value (Octal)</u>	<u>Description</u>
TOJS	5	Timed/event rollout. The job was rolled out because a timed/event was posted. The job remains rolled out until its job status is changed to ROJS.
IOJS	6	Interactive rollout. The job rolled out due to interactive I/O processing. The job remains rolled out until its job status is changed to ROJS.
DOJS	7	Disabled rollout. The job was rolled out because it was a TXOT job with no further commands to process. The job remains rolled out until the job status is changed to ROJS.
SUJS	10	Suspended rollout. The job was rolled out because it was suspended. The job remains rolled out until the job status is changed to ROJS.
ERJS	11	Media error on rollout file. The system encountered a mass storage media error during job rollin.
NVJS	12	Reserved.
PWJS	13	Preinitial wait. The job has not been through job initiation. Its input file is on an inaccessible device.
SWJS	14	Service limit wait status. The job is waiting for service limits to allow scheduling.
--	15-30	Reserved for Control Data.
--	31-37	Reserved for installations.

EJT Scheduling Data Field

The EJT scheduling data field is returned for executing jobs in a QAC PEEK request. The information in this field depends on the current stage of execution of the job.

PRJS (Preinitial Job Step)

29	23	0
0	entry time	

SOJS (SCP Rollout)

Scheduling data field not used.

EXJS (Executing)

29	17	11	0
0	control point	priority	

TOJS (Time/Event Rollout) and PWJS (Preinitial wait)

29	23	11	0
time	EST ordinal of event information	event	

ROJS (Scheduler Rollout)

29	23	0
0	entry time	

IOJS (Interactive Rollout)

29	23	11	0
word count	track	sector	

SIJS (SCP Rollin)

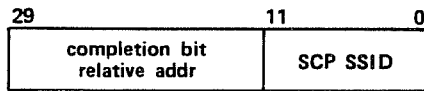

SUJS (Suspended)

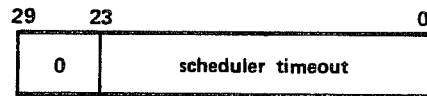

DOJS (Disabled)

Scheduling data field not used.

FILE TYPES AND ORIGIN CODES

The following file types and origin codes are used in many NOS system routines.

The following file types are valid. (These mnemonics are defined in NOSTEXT.)

<u>Type</u>	<u>Value (Octal)</u>	<u>Description</u>
--	0-6	Reserved.
ROFT	7	Rollout.
LIFT	10	Library.
PTFT	11	Primary terminal.
PMFT	12	Direct access permanent file.
FAFT	13	Fast attach file.
SYFT	14	System.
LOFT	15	Local.
--	16	Reserved.
INFT	17	Input.
QFFT	20	Deferred routed queue file.
--	21-77	Reserved.

The following job origin types are valid. (These mnemonics are defined in NOSTEXT.)

<u>Type</u>	<u>Value (Octal)</u>	<u>Description</u>
SYOT	0	System.
BCOT	1	Local batch.
RBOT	2	Remote batch (the symbol EIOT is also available but will be deleted in a future NOS release).
IAOT	3	Interactive (the symbol TXOT is also available but will be deleted in a future NOS release).

SERVICE CLASS TYPES

The following service class types are valid. The service class code is the first two letters of each service class type. These mnemonics are defined in the system OPL common deck COMSSCD.

<u>Type</u>	<u>Value (Octal)</u>	<u>Description</u>
SYSC	1	System service class. All jobs initiated by the system, except for maintenance jobs and subsystems, are assigned to this service class.
BCSC	2	Batch service class.
RBSC	3	Remote batch service class.
TSSC	4	Interactive service class.
DISC	5	Detached interactive service class.
NSSC	6	Network supervisor service class.
SSSC	7	Subsystem service class.
MASC	10	Maintenance service class.
CTSC	11	Communication task service class. All SCOPE 2 Station Facility spun-off task (SPOT) jobs and RHF service jobs are assigned to this service class.
IOSC	12	Installation service class 0.
I1SC	13	Installation service class 1.
I2SC	14	Installation service class 2.
I3SC	15	Installation service class 3.
DSSC	16	Deadstart sequencing service class.

Default Service Classes

The system assigns an initial default service class to each job and each output file. The default value depends on the job or file's origin type. Your site may choose to change its default service classes from these released defaults.

<u>Origin</u>	<u>Default Service Class</u>
SYOT	SYSC
BCOT	BCSC
RBOT	RBSC
IAOT	TSSC

DEVICE TYPES

The following device types are supported by NOS:

<u>Mnemonic</u>	<u>Code (Octal)</u>	<u>Display Equipment</u>
DBn	0402	885-42 Disk Storage Subsystem (one to three units, full-track).
DCn	0403	895 Disk Storage Subsystem (one to two units, full-track).
DDn	0404	834 Disk Storage Subsystem (one to eight units, full-track).
DE	0405	Extended memory.
DFn	0406	887 Disk Storage Subsystem 4K sector (one to three units, full-track).
DG	0407	836 Disk Storage Subsystem (one to three units, full-track)
DHn	0410	887 Disk Storage Subsystem 16K sector (one to two units, full-track).
DIIn	0411	844-21 Disk Storage Subsystem (one to eight units, half-track).
DJn	0412	844-4x Disk Storage Subsystem (one to eight units, half-track).
DKn	0413	844-21 Disk Storage Subsystem (one to eight units, full-track).
DLn	0414	844-4x Disk Storage Subsystem (one to eight units, full-track).
DMn	0415	885-1x Disk Storage Subsystem (one to three units, half-track).
DP	0420	Distributive data path to extended memory.
DQn	0421	885-1x Disk Storage Subsystem (one to three units, full-track).
DV	0426	819 Disk Storage Subsystem (one unit, full-track; model 176 only).
DW	0427	819 Double Density Disk Storage Subsystem (one unit, full-track; model 176 only).
MT	1524	Seven-track magnetic tape drive.
NE	1605	Null equipment.
NT	1624	Nine-track magnetic tape drive.
TT	2424	Interactive terminal.

ERROR FLAGS

NOS sets the following error flags in the user job's control point area. The user program can refer to these flags during error exit processing (refer to the EREXIT macro in section 6).

<u>Error Flag (Octal)</u>	<u>Mnemonic †</u>	<u>Description</u>
1	TIET	User break 1.
2	TAET	User break 2.
3	ARET	Arithmetic error.
4	ITET	SCP invalid transfer address.
5	PSET	A program stop was encountered by the CPU.
6	PPET	PP abort. A PP program requested that the job be aborted (CIO or PFM, for example).
7	CPET	CPU abort. The job issued an ABT request.
10	PCET	PP call error. The job called a nonexistent or invalid system request.
11	--	Reserved for installations.
12	--	Reserved for CDC.
13	CLET	Command limit.
14	MLET	Message limit.
15	TLET	Time limit. Job is allowed an additional 1 to 10 seconds of CPU time for error processing.
16	FLET	File limit. The job attempted to assign more active files to the job than are allowed by the validation parameter.
17	TKET	Track limit. The job requested mass storage space on a device with none available.
20	SRET	SRU limit. The job is allowed an additional 10 SRUs to complete error exit processing.
21	--	Reserved for CDC.
22	FSET	Forced error.
23	RCET	Job hung in auto recall.
24	ODET	The operator dropped the job.
25	IDET	Idle down.
26 ††	SPET	Beginning of special errors.
26	--	Reserved for installations.
27	STET	Suspension timeout (EJT error flag only).
30	ECET	ECS parity error.
31	RSET	Subsystem recovered during level 3 deadstart.
32	SSET	Subsystem abort.
33	--	Reserved for CDC.
34	RRET	Operator reran job.
35	OKET	Operator killed job.
36 †††	NRET	Beginning of non-retrievable errors.
36	--	Reserved for CDC.
37	DRET	Deadstart rerun.
40	RAET	Recovery abort.
41	JSET	Job step abort.

† In order to use the mnemonic in a COMPASS program, the program must contain an SST pseudo-instruction, and you must specify either systems text PPTEXT or NOSTEXT.

†† Error flags whose value is greater than or equal to that of SPET are considered special errors.

††† Error flags whose value is greater than or equal to that of NRET are considered to be non-retrievable errors.

<u>Error Flag (Octal)</u>	<u>Mnemonic†</u>	<u>Description</u>
42	SVET	Security conflict.
43	SYET	System abort.
44	PEET	CPU or CM parity error.††
45	SWET	Software error abort.
46	ORET	Override of error condition.
47	MXET	Maximum number of error flags.
48-77	--	Reserved.

Errors greater than or equal to SPET (26g) are considered special by certain system routines. Examples of this are as follows.

- The job advancement routine IAJ does not invoke buffer flushing when an error occurs that is SPET or greater.
- Read and write tape error recovery is terminated by an error greater than or equal to SPET.
- CIO terminates a skip operation prior to completion if the error is SPET or greater.
- Waiting for a tape to be mounted and waiting for track limit terminate only on operator drop (ODET) or an error of value SPET or greater.

†In order to use the mnemonic in a COMPASS program the program must contain an SST pseudo-instruction, and you must specify either systems text PPTXT or NOSTXT.

††Applicable to CYBER 170 Computer Systems only.

CPU COMMON DECKS

F

Appendix F lists the CPU common decks of general interest to the COMPASS programmer, including a list of those common decks that are available in relocatable form on the system library (SYSLIB). You can obtain documentation of all CPU common decks provided with the system OPL by entering the following commands after accessing the system OPL.†

```
MODIFY,Z./*EDIT,CALLCPU  
DOCUMENT.
```

In addition, by using the KRONREF utility to determine which common decks are associated with which programs, you can examine the program listings to obtain examples of the use of particular common decks.

Since common decks are continually being changed or updated, it is impossible to maintain a complete and current description of each common deck in this appendix. Thus, you should consult system listings as described above for specific information.

CPCOM

The CPCOM common deck contains macros for commonly used system requests. The macros contained in CPCOM are available in systems texts NOSTEXT and SYSTEXT. Therefore, you can access these macros either through the system OPL or by specifying the alternate systems text NOSTEXT or SYSTEXT.

The following CPCOM macros are described in the indicated sections.

<u>Macro Name</u>	<u>Description</u>	<u>Section</u>
ABORT	Abort program	11
APPEND	Append file to file	5
ASSIGN	Access library file	4
ATTACH	Attach direct access file	5
BKSP	Backspace file by logical record	3
BKSPRU	Backspace file by physical record	3
CHANGE	Alter permanent file attributes	5
CLOCK	Get time of day	9

†Your site must control access to the system OPL as required by the site's licensing agreement. Contact your site analyst to obtain the procedure for gaining access to the system OPL.

<u>Macro Name</u>	<u>Description</u>	<u>Section</u>
CLOSE	Terminate operations on file	3
CLOSER	Close magnetic tape reel	3
CONTROL	Read and/or execute command	10
DATE	Get current date	9
DEFINE	Create direct access file	5
ENDRUN	Request normal program termination	11
EREXIT	Specify error processor address	6
EVICT	Release file space, save attachment	3
FILEB	Create FET for binary sequential file	2
FILEC	Create FET for coded sequential file	2
FILINFO	Get file information	4
GET	Get copy of indirect access file	5
HTIME	Get model 176 clock cycle count	9
JDATE	Get current Julian date	9
LABEL	Assign file to magnetic tape	4
LOCK	Prevent writing on file	4
MEMORY	Set amount of memory for job	11
MESSAGE	Send message to console and dayfile	11
MOVE	Move block of data	11
OFFSW	Clear sense switches	6
OLD	Get copy of indirect access file as primary file	5
ONSW	Set sense switches	6
OPEN	Create file or get file information	3
OVERLAY	Process request to LDR processor	11
OVWRITE	Overwrite file with binary pattern	3
PDATE	Get packed date and time	9
PERMIT	Permit other user to access file	5
POSMF	Open or position multifile	3
PURGE	Remove permanent file from system	5

<u>Macro Name</u>	<u>Description</u>	<u>Section</u>
READ	Read data into circular buffer	3
READC	Read coded line from circular buffer into working buffer	3
READCW	Read PRUs bounded by control words	3
READEI	Read data to EOI	3
READH	Read coded line from circular buffer into working buffer with space fill	3
READLS	Read logical records from list	3
READN	Read S or L format tape data	3
READNS	Read file to EOF	3
READO	Read word from circular buffer into register X6	3
READS	Read and unpack coded line from circular buffer into string buffer	3
READSKP	Read until buffer full or EOR or EOF is encountered	3
READW	Read specified number of words from circular buffer into working buffer	3
RECALL	Relinquish CPU temporarily	11
RENAME	Change name of local file	4
REPLACE	Replace indirect access file with contents of local file	5
REQUEST	Assign file to device	4
RETURN	Release file from job	3
REWIND	Rewind file	3
REWRITE	Write data as random function	3
REWRITEF	Write entire circular buffer to file as random function, end with EOF	3
REWRITER	Write entire circular buffer to file as random function, end with EOR	3
RFILEB	Create FET for binary random file	2
RFILEC	Create FET for coded random file	2
ROUTE	Dispose local file to queue	7
RPHR	Transfer PRU into circular buffer	3
RPHRLS	Read PRUs from list	3

<u>Macro Name</u>	<u>Description</u>	<u>Section</u>
RTIME	Get real-time clock reading	9
SAVE	Save file as indirect access file	5
SETFS	Set file status	4
SETPFAC	Set permanent file security access categories	5
SETPFAL	Set permanent file security access level	5
SKIPB	Backspace file by records	3
SKIPEI	Skip to EOI of file	3
SKIPF	Skip file forward by records	3
SKIPFB	Backspace file by files	3
SKIPFF	Skip file forward by files	3
STATUS	Determine if file exists	4
STIME	Get job's accumulated SRUs	9
SYSCOM	Define system communication symbols	1
SYSTEM	Process system request	11
TIME	Get job's accumulated CP time	9
UNLOAD	Release file from job; do not decrement resource count	3
UNLOCK	Clear write lockout bit for file	4
USECPU	Select CPU for processing	6
USERNUM	Get user name	6
WAIT	Relinquish CPU for specified time	11
WPHR	Write physical record from circular buffer	3
WRITE	Write circular buffer to file	3
WRITEC	Write coded line image to circular buffer from working buffer	3
WRITECW	Write PRUs bounded by control words from circular buffer	3
WRITEF	Write entire circular buffer to file, end with EOF	3
WRITEH	Pack string buffer to coded line image and write to circular buffer, deleting trailing spaces	3
WRITEN	Write circular buffer to S or L tape	3
WRITEO	Write one word from register X6 to circular buffer	3

<u>Macro Name</u>	<u>Description</u>	<u>Section</u>
WRITER	Write entire circular buffer to file, end with EOR	3
WRITES	Pack string buffer to coded line image and write to circular buffer	3
WRITEW	Write specified number of words from working buffer to circular buffer	3

COMCMAC

The COMCMAC common deck contains macros (not available in SYSTEXT) for issuing system functions for system-oriented programs. The common decks for the processors used must also be called by the user program.

The macros defined in common deck COMCMAC are available in systems text PSSTEXT. Therefore, you can access these macros either through the system OPL or by specifying the alternate systems text PSSTEXT.

The following COMCMAC macros are described in the indicated sections.

<u>Macro Name</u>	<u>Description</u>	<u>Section</u>
CATLIST	Catalog user's permanent files	5
CHECKPT	Create checkpoint dump	10
CSET	Set terminal character set mode	11
DAYFILE	Access dayfile	11
DISTC	Disable terminal control	11
EDATE	Edit packed date	9
EFFECT	Set/clear format effector mode	11
ENCSF	Enter new command file	4
ETIME	Edit packed time	9
EXCST	Execute command	10
GETASL	Get account block SRU limit	6
GETCN	Get charge and project numbers	6
GETFLC	Read field length control word	6
GETFNT	Get FNT/FST entry table	4
GETGLS	Get global library set	6
GETJA	Get job accounting words	6
GETJAL	Get job security access level	6
GETJCR	Get job control registers	6
GETJN	Get job sequence name	6

<u>Macro Name</u>	<u>Description</u>	<u>Section</u>
GETJO	Get job origin code	6
GETJOSC	Get job origin and service class codes	6
GETJSL	Get job step SRU limit	6
GETLC	Get loader control word	6
GETMC	Get machine characteristics	11
GETPAGE	Get page size parameters	6
GETPFP	Get permanent file parameters	6
GETPR	Get CPU priority	6
GETRI	Get reprieve information	6
GETSS	Get subsystem	6
GETSSID	Get subsystem identifier	6
GETSSM	Get system security mode	11
GETTL	Read job step time limit	6
GETUSC	Get user service class	6
LOADD	Load fast dynamic load capsule directory	11
LOADQ	Load fast dynamic load capsules	11
NORERUN	Clear rerun status	11
PRIMARY	Make file primary	4
PROMPT	Disable/enable terminal prompt	11
PSCSF	Position command file	4
RERUN	Set rerun status	11
ROLLOUT	Roll out job	6
SETFAL	Set file security access level	4
SETGLS	Set global library set	6
SETJAL	Set job security access level	6
SETJCR	Set job control registers	6
SETJOB	Set user job name	6
SETLC	Set loader control word	6
SETPAGE	Set page size parameters	6
SETPR	Set CPU priority	6
SETSC	Set service class	6

<u>Macro Name</u>	<u>Description</u>	<u>Section</u>
SETSLM	Set screen/line mode	11
SETSS	Set subsystem	6
SETSSM	Set secure system memory	6
SUBR	Create subroutine tag	11
TSTATUS	Return terminal status	12

COMCCMD

The COMCCMD common deck contains macros (not available in SYSTEXT) for issuing special job control and accounting function requests.

The macros defined in common deck COMCCMD are available in systems text PSSTEXT. Therefore, you access these macros either through the system OPL or by specifying the alternate text PSSTEXT.

The following COMCCMD macros are described in the indicated sections.

<u>Macro Name</u>	<u>Description</u>	<u>Section</u>
GETACT	Get outstanding system activity information	6
GETEM	Get current exit mode	6
GETJCI	Get job control information	6
GETLIDA	Get LID attributes	11
GETLOF	Get list of files pointer	6
GETLVL	Get PSR level of NOS	6
MACHID	Get machine identification	6
MODE	Set exit mode flags	6
PACKNAM	Request pack name	6
PROTECT	Set extended memory field length preservation and/or user file privacy	6
REPRIEVE	Set reprieve processing	10
RPVBLK	Create reprieve parameter block	10
SETASL	Set account block SRU limit	6
SETFET	FET modification macro	2
SETJCI	Set/clear job control parameters	6
SETJSL	Set job step SRU limit	6

<u>Macro Name</u>	<u>Description</u>	<u>Section</u>
SETLOF	Set list of files pointer	6
SETMFL	Set job maximum field length	6
SETRFL	Set job step initial field length	6
SETTL	Set job step time limit	6
SHELL	Set controls for shell program	6
VERSION	Get operating system version name	6

OTHER COMMON DECKS

The following common decks are also available to you on the system OPL.

<u>Common Deck</u>	<u>Description</u>
COMCARG †	Processes an argument list by the use of an equivalence table.
COMCARM	Processes multiple word arguments.
COMCCDD †	Converts a binary integer to display code decimal digits with leading zero suppression.
COMCCFD †	Converts a 30-bit integer to display code in FORTRAN F10.3 format.
COMCCHD	Converts up to a 10-digit decimal number (40 bits) to hexadecimal display code with leading zero suppression.
COMCCIO †	Performs I/O functions.
COMCCOD †	Converts a binary integer to display code octal digits with leading zero suppression.
COMCCPA †	Converts positional arguments in an input string to keyword arguments in an output string.
COMCCPM	Calls the PP program CPM to perform tasks involving control point activity.
COMCCPT †	Copies prefix table comments to a print line.
COMCCVI	Contains formulas for converting validation index value to limit value.
COMCCVL	Common validation interface processor.
COMCDCM	Display console communication macros.
COMCDCP	Display console communication processor.
COMCDXB	Converts one word of display code digits to a binary value.

† This common deck is also available on the program library (PL) that contains the common decks that are common between products. Contact site personnel for further information.

<u>Common Deck</u>	<u>Description</u>
COMCECM	Contains macro definitions for performing interpretive mode extended memory reads and writes (refer to appendix D).
COMCECS	Processes interpretive mode extended memory read and write instructions (refer to appendix D).
COMCEDT	Edits an 18-bit packed date or time into a 10-character display coded date or time.
COMCFCE	Edits a permanent file catalog entry into a three-line output formula.
COMCGTO	Returns the terminal ordinal corresponding to the supplied terminal mnemonic or the terminal mnemonic corresponding to the supplied terminal ordinal.
COMCHXB	Converts one word of hexadecimal display code digits to a binary value; leading and trailing blanks are ignored.
COMCLFM	Processes requests for the PP program LFM.
COMCLOD	User call loader interface.
COMCMTM†	Contains macro for generation, allocation, and processing of managed tables.
COMCMTPT†	Contains routines for processing managed tables.
COMCMVE†	Moves a block of data.
COMCOVL	Requests the PP program LDR to load a specified overlay.
COMCPFM	Performs permanent file action functions by calls to the PP program PFM.
COMCPOP	Obtains parameters from a string buffer.
COMCRDC†	Reads one coded line from a CIO buffer to a working buffer.
COMCRDH†	Reads one coded line from a CIO buffer to a working buffer with trailing space fill.
COMCRDO†	Reads one word from a CIO buffer to the X6 register.
COMCRDS†	Reads one coded line from a CIO buffer to a working buffer where it is stored one character per word.
COMCRDW†	Reads the specified number of words from a CIO buffer to a working buffer.
COMCRSP	Removes secure parameters from command.
COMCSFM	Processes requests for the PP program SFM.
COMCSFN†	Replaces trailing 00 codes with 55 codes in a word.
COMCSNM	Sets name in message.

† This common deck is also available on the program library (PL) that contains the common decks that are common between products. Contact site personnel for further information.

<u>Common Deck</u>	<u>Description</u>
COMCSRT †	Identifies the format of a record from the first 64 words located in a working buffer.
COMCSSN	Skips a sequence number on a coded line if present.
COMCSST †	Sorts a table into ascending order using a shell-sorting technique.
COMCSTF †	Determines if a file is, or will be, assigned to a terminal.
COMCSYS †	Contains routines for processing system request.
COMCUPC †	Unpacks a command to individual parameters.
COMCUSB	Unpacks data block to string buffer.
COMCVDT	Converts a display-coded date (yymmdd) or time (hhmmss) to a packed binary value and checks the validity of the entry.
COMCVLC	Converts an access level or access category name to the corresponding binary value, or vice versa.
COMCWOD †	Converts a word to octal display code by an in-line sequence of shifts and masks.
COMCWTC †	Transfers one coded line in C format from a working buffer to a CIO buffer.
COMCWTH †	Transfers one coded line in H format from a working buffer to a CIO buffer; trailing spaces are deleted.
COMCWTO †	Writes one word to a CIO buffer from X6.
COMCWTS †	Transfers one coded line from a string buffer to a CIO buffer with trailing space suppression.
COMCWTW †	Transfers data from a working buffer to a CIO buffer.
COMCZAP	Z argument command processor.
COMCZTB †	Replaces all 00 codes with 55 codes in a word.

SYSLIB

The following common decks, unless otherwise noted, are assembled from the PL that contains the common common decks and are available in relocatable form on the system library SYSLIB.

<u>Common Deck</u>	<u>Entry Points</u>	<u>Description</u>
COMCCIO	CIO=	I/O function processor
COMCCPM ††	CPM=	Control point manager processor

† This common deck is also available on the program library (PL) that contains the common decks that are common between products. Contact site personnel for further information.

†† Assembled from the system OPL.

<u>Common Deck</u>	<u>Entry Points</u>	<u>Description</u>
COMCECS†	REC=, WEC=	Extended memory interpretive mode macro processors
COMCLFM†	LFM=	Local file manager processor
COMCMVE	MVE=	Move block of data
COMCOVL†	OVL=	Overlay load processor
COMCPFM†	PFM=	Permanent file processor
COMCRDC	RDC=	Read coded line, -C- format
COMCRDH	RDH=	Read coded line, -H- format
COMCRDO	RDO=	Read one word
COMCRDS	RDS=	Read coded line to string buffer
COMCRDW	LCB=, RDW=, RDX=	Read words to working buffer
COMCSYS	MSG=, RCL=, SYS=, WNB=	Process system request
COMCWTC	WTC=	Write coded line, -C- format
COMCWTH	WTH=	Write coded line, -H- format
COMCWTO	WTO=	Write one word
COMCWTS	WTS=	Write coded line from string buffer
COMCWTW	DCB=, WTW=, WTX=	Write words from working buffer

†Assembled from the system OPL.

BINARY FORMATS

G

Appendix G describes the following binary formats.

PP	CYBER 180, CYBER 170, CYBER 70, or 6000 Computer Systems PP absolute program
OPL	Modify old program library deck
OPLD	Program library directory
ULIB	User library group
TEXT	Unrecognized as binary
PROC	Procedure
	Compressed compile file

For binary formats of loader and tables, refer to the CYBER Loader Version 1 Reference Manual.

PP—CYBER 180, CYBER 170, CYBER 70, OR 6000 COMPUTER SYSTEMS PP ABSOLUTE

Binary output for a CYBER 170, CYBER 70, or 6000 Computer Systems PP program or overlay is a logical record that may contain the following:

- Prefix table
- CYBER 170, CYBER 70, or 6000 Computer Systems PP program control table
- PP text in five PP words per 60-bit CPU word

The format of the control table is:

59	41	35	23	11	0
name	00	fwa	0000	length	

<u>Bits</u>	<u>Field</u>	<u>Description</u>
59-42	name	Program name, one- to three-display code characters, left-justified with zero fill.
41-36	none	Reserved for future system use.
35-24	fwa	Origin minus 5; address at which the header word is loaded.†
23-12	none	Reserved for future system use.
11-0	length	Number of CPU words in program image (1/5 the number of PP words).

†The normal origin address for PP programs is 1100g (PPFW); however, the origin address should be greater than 5.

OPL—MODIFY OLD PROGRAM LIBRARY DECK

A Modify old program library deck is a record on a Modify library file (figure G-1) consisting of a prefix table, a modification table, and text. The prefix table contains the library creation date in word 2 and the latest modification date in word 3.

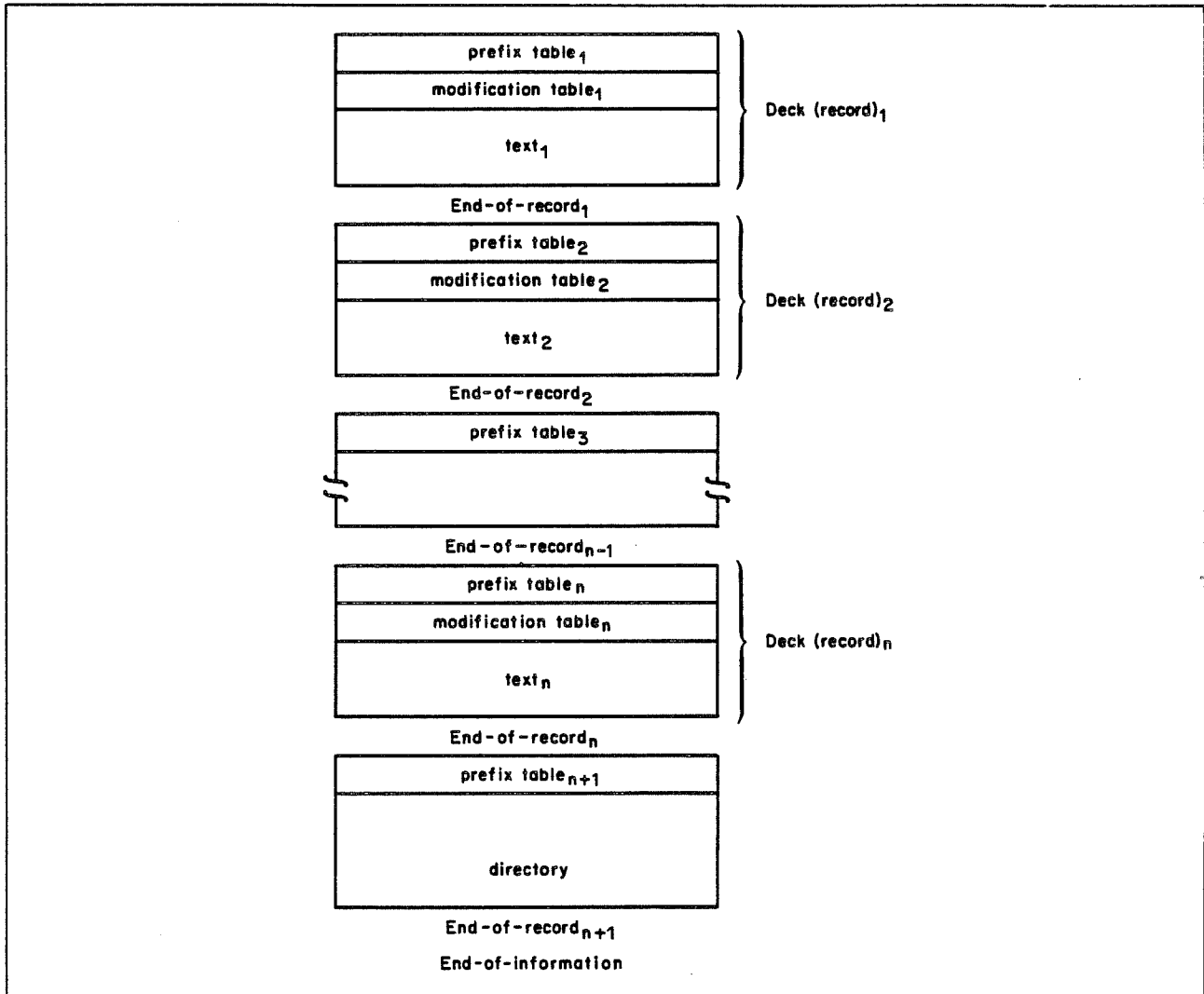

Figure G-1. Modify Library File Format

MODIFICATION TABLE FORMAT

Modification table format is shown in figure G-2.

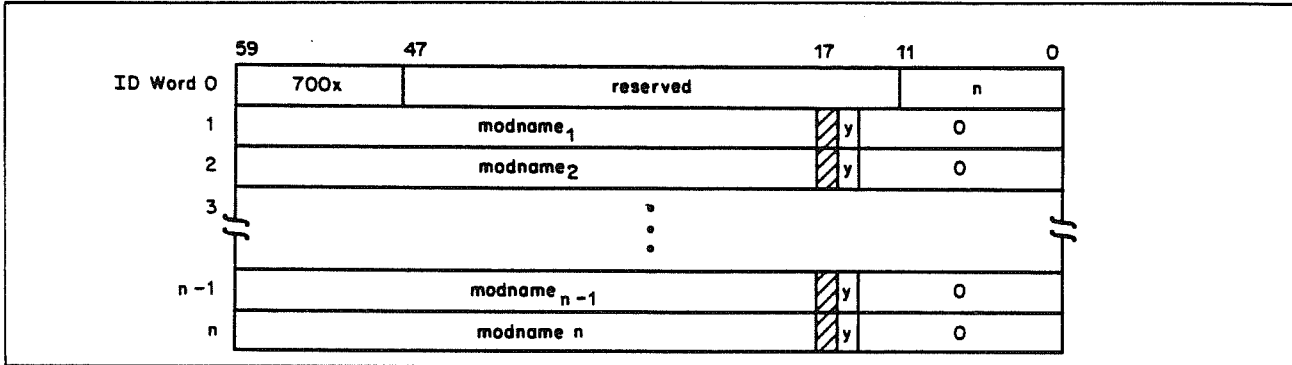

Figure G-2. Modification Table Format

<u>Word</u>	<u>Bit(s)</u>	<u>Field</u>	<u>Description</u>
ID	59-48	700X	Identifies Modify deck. Least significant digit indicates whether or not the deck is common as follows: 1 Deck is not common. 2 Deck is common.
	47-12	none	Reserved for future system use.
	11-0	n	Number of modification names in table.
word _i	59-18	modname _i	One- to seven-character modification set name. Each modification to a deck causes a new entry in this table.
	16	y _i	YANK flag: 0 Modifier not yanked. 1 Modifier yanked.

TEXT FORMAT

Text is an indefinite number of words that contain a modification history and the compressed image of each line in the deck. Text for each line is in the format shown in figure G-3.

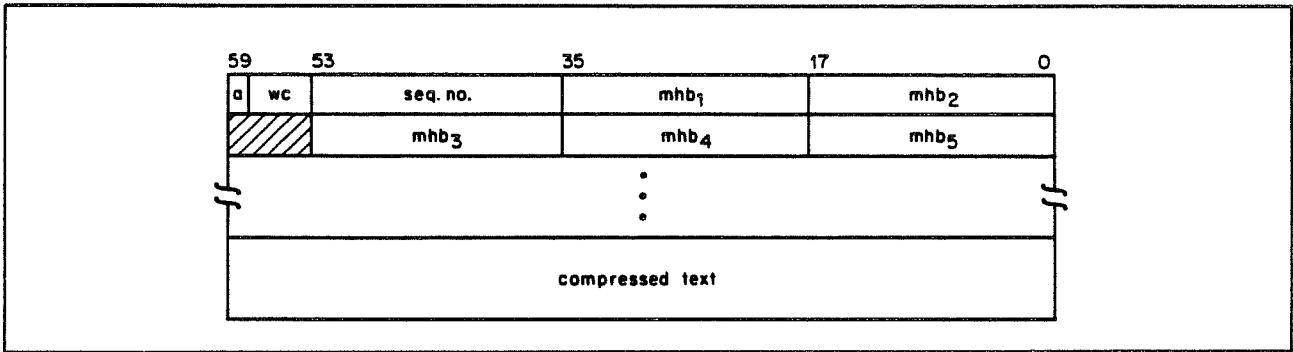
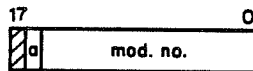

Figure G-3. Modify Text Format

<u>Bit(s)</u>	<u>Field</u>	<u>Description</u>
59	a	Activity bit: 0 Line is inactive. 1 Line is active.
58-54	wc	Number of words of compressed text.
53-36	seq. no.	Sequence number of card (octal) according to the position in the deck or modification set.
35-18 and subsequent 18-bit bytes	mhb _i	Modification history byte. Modify creates a byte for each modification set that changes the status of the card. Modification history bytes continue to a zero byte. Since this zero byte could be the first byte of a word and the compressed card image beings a new word, the modification history portion of the text could terminate with a zero word.

The format of mhb_i is:



- a Activate bit:
0 Modification set deactivated the card.
1 Modification set activated the card.
- mod. no. Index to the entry in the modification table that contains the name of the modification set that changed the card status.

Following the modification history bytes is the compressed image of the card in display code. A single space is represented by 55₈; it is not compressed. Two or more embedded spaces are replaced in the image as follows:

3 spaces replaced by 0002

4 spaces replaced by 0003

. . .
 . . .
 . . .

64 spaces replaced by 0077₈

65 spaces replaced by 007755₈

66 spaces replaced by 00770001₈

67 spaces replaced by 00770002₈, etc.

Trailing spaces are not considered as embedded and are not included in the card image. A 12-bit zero byte marks the end of the card.

NOTE

Existing 63-character set program libraries may have two spaces represented as a 0001 byte.

OPLD—PROGRAM LIBRARY DIRECTORY

The library file directory (figure G-4) contains a prefix (7700) table followed by a table containing a two-word entry for each deck in the library. Directory entries are in the same sequence as the decks on the library.

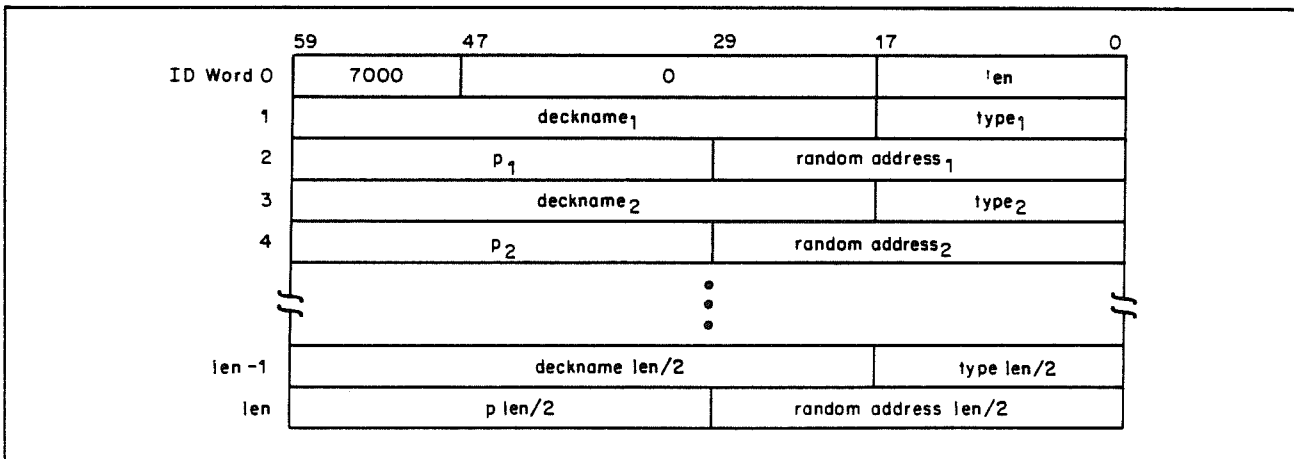

Figure G-4. Library File Directory Table

<u>Word</u>	<u>Bits</u>	<u>Field</u>	<u>Description</u>						
ID	59-48	7000	Identifies the table as a program library directory.						
	17-0	len	Directory length excluding ID word.						
1,3, ..., len-1	59-18	deckname _i	Name of the program library deck; one to seven characters, left-justified. If type _i equals 16g, this field contains the capsule name.						
	17-0	type _i	Type of record (octal): <ul style="list-style-type: none"> 0 Unrecognizable as binary program (TEXT). 1 Peripheral processor program (PP). 3 Relocatable central processor program (REL). 4 Central processor overlay (OVL). 5 User library program (ULIB). 6 Old program library deck (OPL). 7 Old program library common deck (OPLC). 10 Old program library directory (OPLD). 11 Multiple entry point overlay (ABS). 12 Peripheral processor unit program (PPU). 16 Fast dynamic load capsule (CAP). 20 Procedure (PROC). 						
2,4, ...,len	59-30	p _i	Zero for all record types except CAP (16g). If type _i equals 16g this field is defined as follows. <table border="1" style="margin-left: 40px;"> <thead> <tr> <th><u>Bits</u></th> <th><u>Description</u></th> </tr> </thead> <tbody> <tr> <td>59-48</td> <td>Ordinal to group name in ULIB record (refer to ULIB record).</td> </tr> <tr> <td>47-30</td> <td>Length of capsule.</td> </tr> </tbody> </table>	<u>Bits</u>	<u>Description</u>	59-48	Ordinal to group name in ULIB record (refer to ULIB record).	47-30	Length of capsule.
<u>Bits</u>	<u>Description</u>								
59-48	Ordinal to group name in ULIB record (refer to ULIB record).								
47-30	Length of capsule.								
	29-0	random address _i	Address of the deck relative to the beginning of the file.						

ULIB—USER LIBRARY GROUP

A user library group (figure G-5) consists of all records beginning with a ULIB-type record through the next OPLD-type record. The ULIB record format is shown in figure G-6 and the ULIB deck entry/externals format is shown in figure G-7.

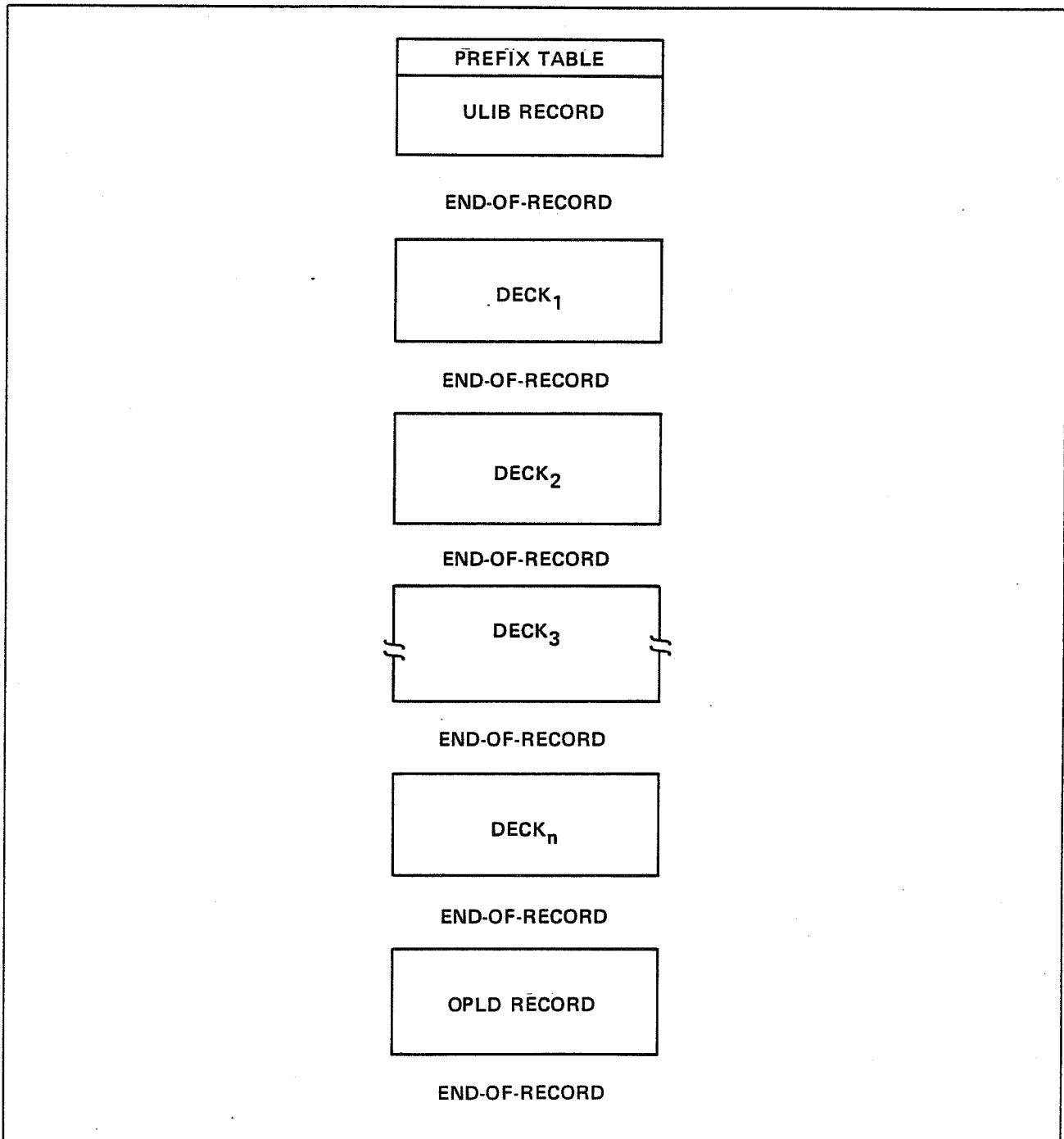
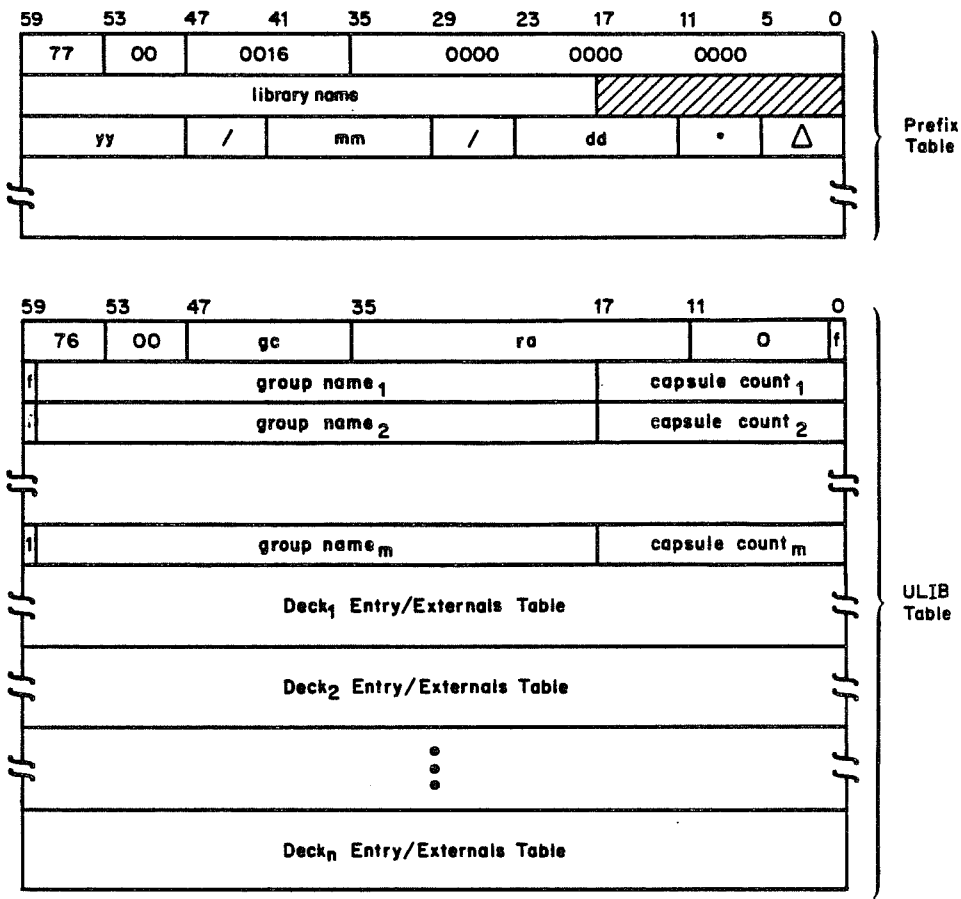

Figure G-5. User Library (ULIB) Format



gc Group count (count of different group names in ULIB) equal to m.

ra Random address of OPLD.

f Cross-reference flag:

 0 ULIB table contains cross-references.

 1 ULIB table does not contain cross-references.

group name_i Name of group.

capsule count_i Number of capsules with group name_i.

Figure G-6. ULIB Record Format

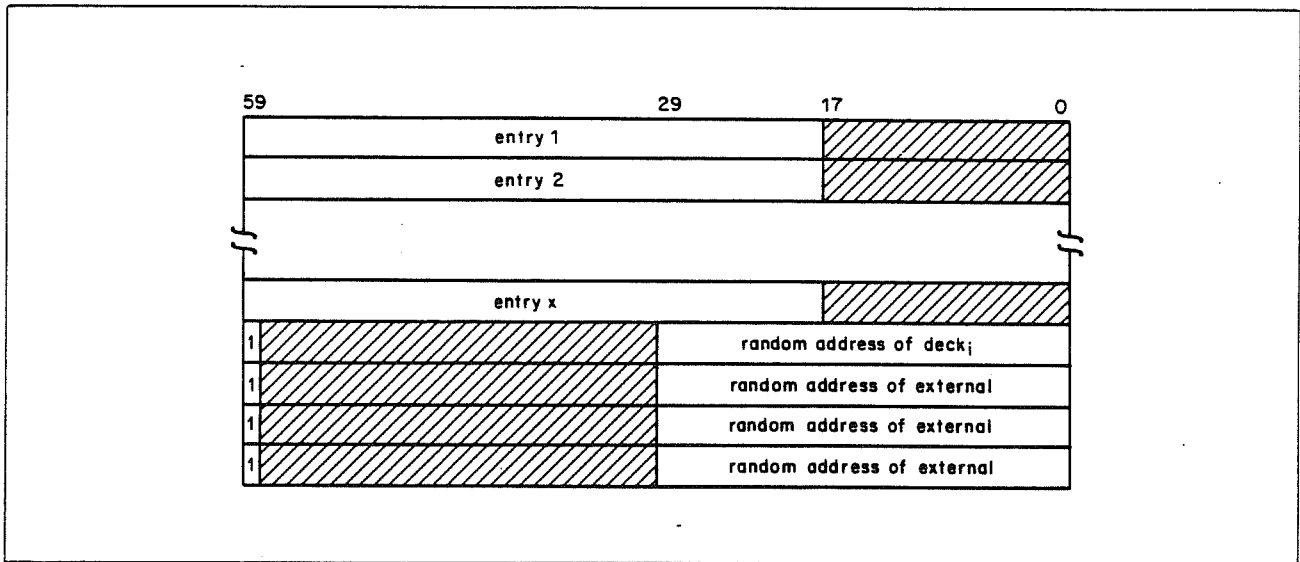

Figure G-7. ULIB Deck Entry/Externals Format

TEXT—UNRECOGNIZED AS BINARY

A text record is any record that cannot be recognized as conforming to a specific binary format. The record name is taken from the first one through seven display code characters in the record (if a prefix table is present, the record name will be taken from that table instead).

PROC—PROCEDURE

A PROC record is a special form of text record in which the first line has the following format:

`.PROC,procnam`

The record name is the one- through seven-character alphanumeric identifier `procnam`.

COMPRESSED COMPILE FILE

A compressed compile file (figure G-8) has a one-word header.

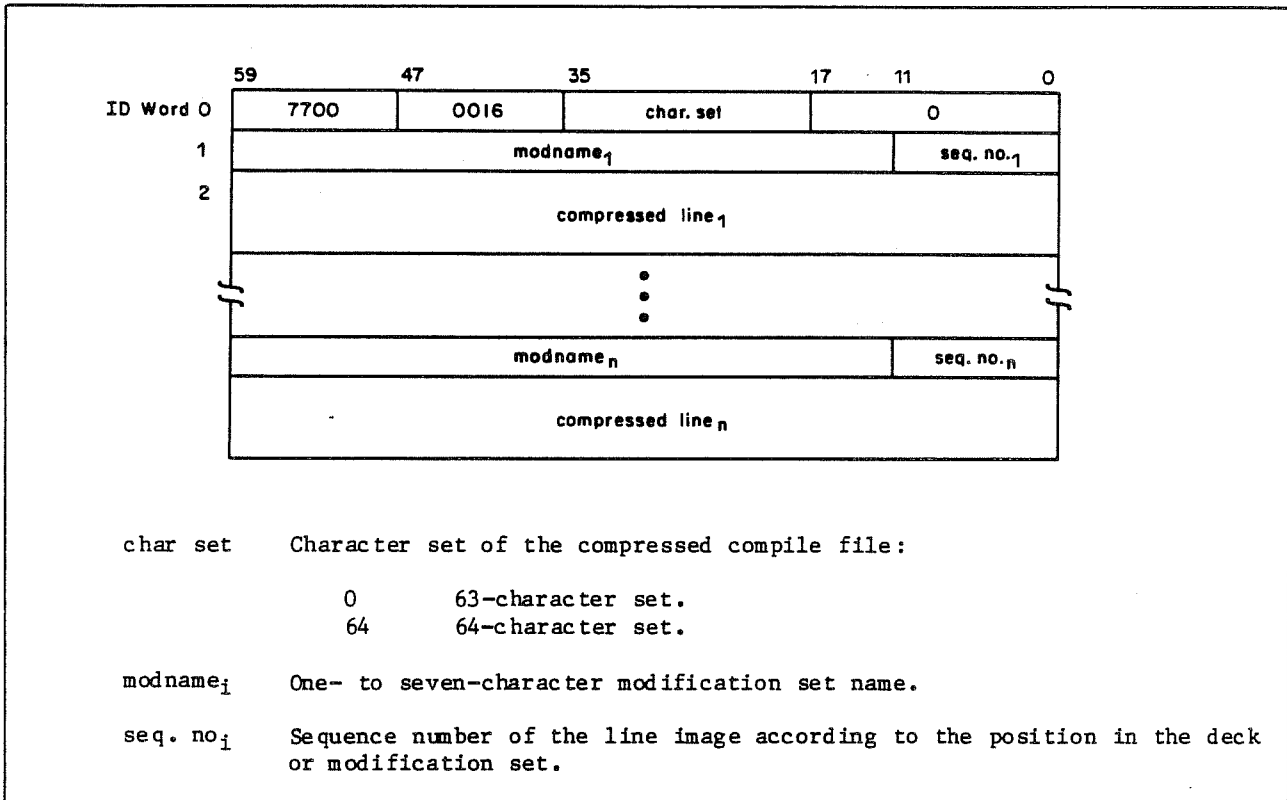

Figure G-8. Compressed Compile File Format

EXAMPLES OF RANDOM I/O

H

Appendix H contains several programs that perform the following random I/O operations.

- Create a random file
- Read a random file with list
- Write (replacing records) on a random file

The COMPASS program illustrated in figure H-1 reads the input deck in figure H-2 and creates a random file in the format illustrated in figure H-3. The resulting index directory record is also illustrated.

An example of a program which uses the READLS (read with list) macro to retrieve (read) a list of records from the same random file is illustrated in figure H-4.

Figure H-5 illustrates two ways of writing (replacing) records on a random file. The new record 1 is written at EOI; that is, at the same random address. Record 3 is written to the file by using the REWRITER macro, which rewrites in place.

```

CREATE
    IDENT  CREATE,FWA
    ABS
    SST
    TITLE  CREATE - CREATE RANDOM FILE.
    ENTRY  CREATE
    ENTRY  RFL=
    SYSCOM B1
*COMMENT  CREATE RANDOM FILE.
          COMMENT COPYRIGHT CONTROL DATA 1982.
          SPACE 4, 10
***      -CREATE - CREATE RANDOM FILE.
*        PROGRAMMER NAME. 82/04/26.
          SPACE 4, 10
***      THIS PROGRAM CREATES A RANDOM FILE AND DIRECTORY FROM
*        DATA SUPPLIED ON FILE INPUT.
*        FORMAT OF INPUT -
*          CARD 1      COLUMN 1-2   RECORD NUMBER RIGHT JUSTIFIED
*          CARD 1      COLUMN 11-20 RECORD NAME
*          CARD 2-N    COLUMN 1-80  RECORD DATA
*          CARD N      EOR
*          REPEAT SEQUENCE -
*          MAX. 64 RECORDS
*
*        FILE IS WRITTEN TO RANFILE.
          SPACE 4, 10
***      DAYFILE MESSAGES.
*
*        * INDEX OUT OF RANGE.* = INDEX INPUT .GE. 64.
*        * RANDOM FILE CREATED.* = PROGRAM COMPLETE.
          SPACE 4, 10
**       PROGRAM CONSTANTS.

IBUFL    EQU    101B      INPUT BUFFER LENGTH
INDL     EQU    101B      INDEX LENGTH
WBUFL    EQU    10B       WORKING STORAGE BUFFER LENGTH
RBUFL    EQU    1001B    FILE CREATION BUFFER
          TITLE  MAIN PROGRAM.
          ORG    110B

FWA      BSS    0
I        BSS    0          INPUT FET
INPUT    FILEB  IBUF,IBUFL
R        BSS    0
RANFILE  RFILEB RBUF,RBUFL,(IND=INDEX,INDL)
MAXI     CON    0          MAXIMUM INDEX

CREATE   SB1    1
          REWIND R
CR1      READ   I,R        READ NEXT RECORD
          READO  I
          NG    X1,CR4     IF END OF FILE
          MXO   12
          BX5   XD*X6

```

Figure H-1. COMPASS Program to Create a Random File (Sheet 1 of 3)

```

SB7  B0      SET OCTAL CONVERSION
RJ   DXB     CONVERT DIGIT
NZ   X4,ERR  IF ERROR IN RECORD NUMBER
BX5  X6      SAVE RECORD NUMBER

RECALL R
READO I      READ RECORD NAME
NG   X1,CR4  IF END OF FILE
MX0  42      SET ADDRESS OF RECORD IN INDEX
SA1  R+6
LX1  30
BX6  X0*X6
BX1  -X0*X1
BX6  X6+X1
SA6  INDEX+X5
SA1  MAXI
IX1  X1-X5
PL   X1,CR2  IF NOT LARGEST INDEX
BX6  X5      SET NEW MAX. INDEX
SA6  A1

CR2  READC I,WORK,WBUFL
NG   X1,CR4  IF END OF FILE
NZ   X1,CR3  IF END OF RECORD
WRITEC R,WORK,WBUFL
EQ   CR2

CR3  WRITER R
EQ   CR1     READ NEXT RECORD

**   WRITE INDEX.

CR4  RECALL R
SA1  MAXI
WRITEW R,INDEX,X1+1
WRITER R,R
WRITEF R,R
REWIND R
MESSAGE (=C*RANDOM FILE CREATED.)*,,R
ENDRUN

ERR  MESSAGE (C=*INDEX OUT OF RANGE.)*,,R
ABORT
SPACE 4, 10

**   COMMON DECKS.

*CALL COMCRDO
*CALL COMCCIO
*CALL COMCWTW
*CALL COMCWTC
*CALL COMCRDC
*CALL COMCSYS
*CALL COMCRDW
*CALL COMCDXB

```

Figure H-1. COMPASS Program to Create a Random File (Sheet 2 of 3)

```

USE      LITERALS

**      BUFFERS.

INDEX   BSSZ   INDL       INDEX BUFFER
IBUF    EQU    *         INPUT BUFFER
RBUF    EQU    IBUF+IBUFL RANDOM FILE BUFFER
WORK    EQU    RBUF+RBUFL WORKING BUFFER
RFL=    EQU    WORK+WBUFL JOB FL
END

```

Figure H-1. COMPASS Program to Create a Random File (Sheet 3 of 3)

```

10      REC10
THIS IS RECORD NUMBER 10.
-EOR-
03      REC3
THIS IS RECORD NUMBER 3.
-EOR-
07      REC7
THIS IS RECORD NUMBER 7.
-EOR-
02      REC2
THIS IS RECORD NUMBER 2.
-EOR-
05      REC5
THIS IS RECORD NUMBER 5.
-EOR-
01      REC1
THIS IS RECORD NUMBER 1.
-EOR-
04      REC4
THIS IS RECORD NUMBER 4.
-EOR-
06      REC6
THIS IS RECORD NUMBER 6.
-EOR-
-EOI-

```

Figure H-2. Input File for Program Creating a Random File (Figure H-1)

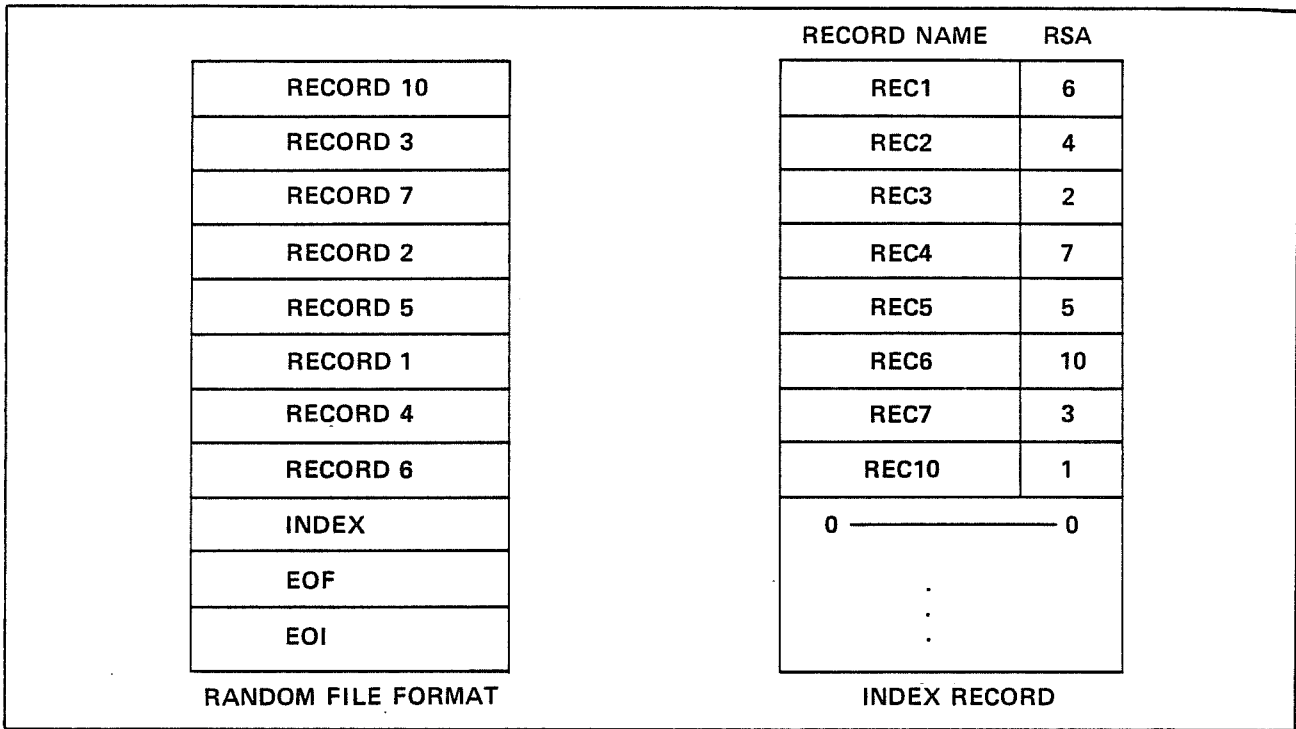

Figure H-3. Structure of the Random File Created

```

RLIST
    IDENT  RLIST,FWA
    ABS
    SST
    TITLE  RLIST - READ SELECTED LIST FROM RANDOM FILE.
    ENTRY  RLIST
    ENTRY  RFL=
    SYSCOM B1
*COMMENT  READ LIST OF RANDOM FILE.
          COMMENT COPYRIGHT CONTROL DATA 1982.
          SPACE 4, 10
***      RLIST - READ SELECTED LIST FROM RANDOM FILE.
*        PROGRAMMER NAME.          82/04/26.
          SPACE 4, 10
***      THIS PROGRAM READS A SELECTED LIST OF RECORDS
*        FROM RANDOM FILE AND WRITES THEM TO FILE OUTPUT.
*        SELECTED LIST IS -
*        3
*        7
*        4
*        10
          SPACE 4, 10
***      DAYFILE MESSAGES.
*
*        *INDEX OVERFLOW.* = INDEX BUFFER OVERFLOWED.
*        *LIST COPIED.* = PROGRAM COMPLETE.
          SPACE 4, 10
**       PROGRAM CONSTANTS.

INDL     EQU    101B    INDEX LENGTH
RBUFL    EQU    101B    RANDOM FILE BUFFER LENGTH
OBUFL    EQU    101B    OUTPUT BUFFER LENGTH
WBUFL    EQU    10B     WORKING BUFFER LENGTH
          TITLE  MAIN PROGRAM.
          ORG    110B

FWA      BSS    0

R        BSS    0
RANFILE  RFILEB  RBUF,RBUFL,(IND=INDEX,INDL)
0        BSS    0
OUTPUT   FILEB  OBUF,OBUFL
LIST     BSSZ   10B     LIST TO READ

RLIST    SB1    1
          SKIPEI R,R     POSITION TO INDEX
          BKSP   R,R
          BKSP   R,R
          READ   R,R     READ INDEX
          READW  R,INDEX,INDL
          ZR    X1,ERR   IF INDEX TOO LARGE

**       SET LIST OF RECORDS.

```

Figure H-4. COMPASS Program Using READLS Macro to Retrieve a List of Records from a Random File (Sheet 1 of 2)

```

MXD      42
SA1      INDEX+3   RECORD 3
BX6      -X0*X1
SA6      LIST
SA1      INDEX+7   RECORD 7
BX6      -X0*X1
SA6      A6+B1
SA1      INDEX+4   RECORD 4
BX6      -X0*X1
SA6      A6+B1
SA1      INDEX+10B RECORD 10
BX6      -X0*X1
SA6      A6+B1
SX6      LIST      SET ADDRESS OF LIST
SA6      R+5

**      READ LIST.

RLI1     READLS R,R
RLI2     READW  R,WORK,WBUFL
          NG    X1,RLI3   IF END OF FILE
          WRITEW O,WORK,WBUFL
          EQ    RLI2

RLI3     SX1      B6-WORK
          WRITEW O,WORK,X1
          WRITER O
          REWIND R
          MESSAGE (=C*LIST COPIED.),,R
          ENDRUN

ERR      MESSAGE (=C*INDEX OVERFLOW.),,R
          ABORT
          SPACE 4, 10

**      COMMON DECKS.

*CALL    COMCCIO
*CALL    COMCWTW
*CALL    COMCRDW
*CALL    COMCSYS
          SPACE 4, 10
          USE    LITERALS

**      BUFFERS.

INDEX    EQU    *          INDEX BUFFER
RBUF     EQU    INDEX+INDL RANDOM FILE BUFFER
OBUF     EQU    RBUF+RBUFL OUTPUT BUFFER
WORK     EQU    OBUF+OBUFL WORKING BUFFER
RFL=     EQU    WORK+WBUFL DEFAULT FL
          END

```

Figure H-4. COMPASS Program Using READLS Macro to Retrieve a List of Records from a Random File (Sheet 2 of 2)

```

REWRITE
    IDENT REWRITE,FWA
    ABS
    SST
    TITLE REWRITE - REWRITE RANDOM FILE.
    ENTRY REWRITE
    ENTRY RFL=
    SYSCOM B1
*COMMENT REWRITE RANDOM FILE
    COMMENT COPYRIGHT CONTROL DATA 1982.
    SPACE 4, 10
*** REWRITE - REWRITE RANDOM FILE.
* PROGRAMMER NAME. 82/04/26.
    SPACE 4, 10
*** THIS PROGRAM UPDATES RECORDS ON A RANDOM FILE.
* RECORD 3 IS UPDATED IN PLACE
* RECORD 1 IS REWRITTEN AT EOI
* THE DIRECTORY IS ALSO REWRITTEN
    SPACE 4, 10
*** DAYFILE MESSAGES.
* *INDEX OVERFLOW.* = INDEX TOO LARGE FOR BUFFER
    SPACE 4, 10
** PROGRAM CONSTANTS.

INDL EQU 101B INDEX LENGTH
RBUFL EQU 101B RANDOM FILE BUFFER LENGTH
TITLE MAIN PROGRAM.
ORG 110B

FWA BSS 0

R BSS 0
RANFILE RFILEB RBUF,RBUFL,(IND=INDEX,INDL)
INDS CON 0

REWRITE SB1 1
    SKIPEI R,R POSITION TO INDEX
    BKSP R,R
    BKSP R,R
    READ R,R READ INDEX
    READW R,INDEX,INDL
    ZR X1,ERR IF INDEX TOO LARGE
    BX6 X1 SAVE INDEX SIZE
    SA6 INDS

** CHANGE RECORD 3 IN PLACE.

SA1 INDEX +3 SET ADDRESS OF RECORD 3
MX0 42
BX6 -X0*X1
SA6 R+6
WRITEC R,(=C*REC3-1*)
WRITEC R,(=C*THIS IS UPDATED RECORD 3.*)
REWRITER R,R

```

Figure H-5. COMPASS Program to Replace Certain Records on a Random File (Sheet 1 of 2)

```

**      REWRITE RECORD 1 AT EOI.

      SKIPEI R,R          POSITION FILE AT EOI
      SA1   R+6
      MX0   42
      LX1   30
      SA2   INDEX+1
      BX6   X0*X2        PICK RECORD NAME
      BX1   -X0*X1
      BX6   X1+X6        REWRITE NEW ADDRESS
      SA6   A2

      WRITEC R,(=C*REC1-1*)

      WRITEC R,(=C*THIS IS UPDATED RECORD 1.*)
      WRITEC R,(=C*WRITTEN AT EOI BECAUSE LENGTH IS EXTENDED.*)
      WRITER R,R

**      REWRITE INDEX.

      SA1   INDS
      WRITEW R,INDEX,X1
      WRITER R,R
      WRITEF R,R
      REWIND R
      MESSAGE (=C*RANFILE UPDATED.)*,,R
      ENDRUN

ERR    MESSAGE (=C*INDEX OVERFLOW.)*,,R
      ABORT
      SPACE 4,10

**      COMMON DECKS.

*CALL  COMCCIO
*CALL  COMCWTC
*CALL  COMCRDW
*CALL  COMCWTW
*CALL  COMCSYS
      SPACE 4,10
      USE   LITERALS

**      BUFFERS.

INDEX EQU *
RBUF  EQU INDEX+INDL RANDOM FILE BUFFER
RFL=  EQU RBUF+RBUFL DEFAULT FL

      END

```

Figure H-5. COMPASS Program to Replace Certain Records on a Random File (Sheet 2 of 2)

PROGRAMMING STANDARDS

I

This appendix describes NOS programming standards including documentation standards and coding specifications for COMPASS programs. A COMPASS program follows these standards for one or more of the following reasons.

- To allow the correct use of the NOS documentation processor DOCUMENT
- To ease readability and modification for other programmers
- To optimize execution and memory requirements

DOCUMENTATION STANDARDS

Documentation is the presentation of information about a program in easily understandable form so that those who need to understand a program do not need to study the program itself. The program documentation is embedded within the source language of each program. The documentation should be designed to be extractable by the NOS documentation processing program DOCUMENT. This approach serves to unify the program and its documentation, making it easier and more natural to update as changes are made.

NOS documentation is of two types.

- External documentation is produced for the general user
- Internal documentation describes the internal characteristics of a program (such as register usage and subroutine entry and exit conditions)

For a detailed explanation of how to obtain external and internal documentation, refer to the description of the DOCUMENT command in Volume 3, System Commands.

External and internal documentation are further divided in the following levels of documentation.

- How the program functions (design overview)
- How the program is used (external interface)
- How the program works (internal interface)
- Information needed to modify the program (detailed code analysis)

DESIGN OVERVIEW

The design overview of a program should describe in general terms the function of the program. It should not contain any information about the input parameters, options, error conditions, or internal workings of the program.

EXTERNAL INTERFACE

The external interface description includes the following:

- Parameter definitions, formats, and contents
- Initial conditions of buffers and devices
- Status and condition information
- Programs called
- Error codes and messages
- Parameters returned

INTERNAL INTERFACE

The internal interface describes the logical flow and structure of the program, the algorithms used, and the function performed by each overlay or subroutine in the program.

DETAILED CODE ANALYSIS

The detailed code analysis consists of comments within the code itself describing the flow of the program. Comments describing the function of logical groups of instructions should be provided, and comments documenting table structures, data areas, and constants should appear on the instructions which define them. This documentation should provide enough detail so that program modifications can be made without adversely affecting existing program functions.

Figure I-1 is an example of how source code could be arranged to take advantage of the DOCUMENT features. Figure I-2 illustrates an external DOCUMENT of that program and figure I-3 illustrates an internal DOCUMENT.

COMMENT STATEMENT DOCUMENTATION

Comment statements contain only asterisks and blanks in the first 10 columns and text in columns 11 through 71 (columns 72 through 80 are not used). The following rules apply to the format of comment statements for documentation.

- Comment statements with an asterisk only in column 1 indicate that this statement is a continuation of internal and external documentation, or it is a comment statement not included in the formal documentation (that is, it is not processed by DOCUMENT).
- Comment statements with asterisks in columns 1 and 2 indicate internal documentation.
- Comment statements with asterisks in columns 1, 2, and 3 indicate that this statement and all following statements are internal and external documentation.

- A statement with four asterisks beginning in column 1 indicates that all following statements are internal documentation (whether they are comment statements or not). Documentation ends when another comment statement containing four asterisks is encountered.
- A statement with asterisks in columns 1 through 5 indicates that this and the following comment statements are internal and external documentation and provide the program overview.
- A statement with an asterisk in column 1 and blanks in columns 2 through 71 is a blank comment statement and is used as a separator to improve readability of documentation.

```

IDENT DOCTEST
ENTRY DOCTEST
SYSCOM B1
TITLE DOCTEST - DOCUMENT TEST PROGRAM.
SPACE 4,10
*** DOCTEST - DOCUMENT TEST PROGRAM.
* THIS PORTION OF THE DOCUMENTATION CONTAINS THE
* PROGRAM OVERVIEW.
*
* A. B. PROGRAMMER. 82/04/26.
SPACE 4,10
*** DOCTEST IS A COMPASS PROGRAM WHOSE DOCUMENTATION
* USES SEVERAL OF THE FEATURES PROVIDED BY THE NOS
* DOCUMENT PROCESSOR *DOCUMENT*.
SPACE 4,10
*** DAYFILE MESSAGES.
*
* * DOCTEST COMPLETE.* - INDICATES COMPLETION OF
* PROGRAM EXECUTION.
SPACE 4,10
**** ASSEMBLY CONSTANT.

THREE EQU 3 CONSTANT THREE
****
TITLE DATA STORAGE.
**
TEMP CON 0 TEMPORARY LOCATION
TSYM SPACE 4,10
** TSYM - TABLE OF SYMBOLS.
*
* T 30/ THREE, 12/ 0, 18/ TEMP
*
* THREE VALUE OF EQU SYMBOL.
* TEMP VALUE OF TEMPORARY STORAGE LOCATION.

TSYM BSS 0
VFD 30/THREE,12/0,18/TEMP
DOCTEST TITLE MAIN ROUTINE.
** DOCTEST MAIN ROUTINE.

DOCTEST SB1 1
*
* DAYFILE MESSAGE INDICATING EXECUTION IS COMPLETE.

MESSAGE DOCA,THREE
ENDRUN

DOCA DATA C* DOCTEST COMPLETE.*
SPACE 4,10
END DOCTEST

```

Figure I-1. Source Code for DOCUMENT

DOCTEST - DOCUMENT TEST PROGRAM.

82/04/26. EXTERNAL

DOCTEST - DOCUMENT TEST PROGRAM.
THIS PORTION OF THE DOCUMENTATION CONTAINS THE
PROGRAM OVERVIEW.

A. B. PROGRAMMER. 82/04/26.

DOCTEST IS A COMPASS PROGRAM WHOSE DOCUMENTATION
USES SEVERAL OF THE FEATURES PROVIDED BY THE NOS
DOCUMENT PROCESSOR *DOCUMENT*.

DAYFILE MESSAGES.

* DOCTEST COMPLETE.* - INDICATES COMPLETION OF
PROGRAM EXECUTION.

Figure I-2. External Documentation of Program

DOCTEST - DOCUMENT TEST PROGRAM

82/04/26. INTERNAL

DOCTEST - DOCUMENT TEST PROGRAM.
THIS PORTION OF THE DOCUMENTATION CONTAINS THE
PROGRAM OVERVIEW.

A. B. PROGRAMMER. 82/04/26.

DOCTEST IS A COMPASS PROGRAM WHOSE DOCUMENTATION
USES SEVERAL OF THE FEATURES PROVIDED BY THE NOS
DOCUMENT PROCESSOR *DOCUMENT*.

DAYFILE MESSAGES.

* DOCTEST COMPLETE.* - INDICATES COMPLETION OF
PROGRAM EXECUTION.

ASSEMBLY CONSTANT.

THREE EQU 3 CONSTANT THREE

DATA STORAGE.

TSYM - TABLE OF SYMBOLS.

	5	4	3	2	1	
	98765432109876543210987654321098765432109876543210					

/	THREE		/	0	/	TEMP

THREE VALUE OF EQU SYMBOL.
TEMP VALUE OF TEMPORARY STORAGE LOCATION.

DOCTEST MAIN ROUTINE.

Figure I-3. Internal Documentation of Program

TABLE GENERATION

The following points describe special statements used to produce documentation.

- Documentation statements containing cE in columns 1 and 2 cause the page to be ejected.
- Documentation statements containing cT in columns 1 and 2 produce a table.

The character c preceding an E or T statement is the key character specified by the C parameter on the DOCUMENT command (the default is an asterisk).

The cE and cT statements are recognized only if they appear within a set of consecutive statements beginning with ccc (external) or cc (internal), where c is the key character.

For example, the statement

```
*T EXAMPLE 24/PP PROGRAM, 18/PARAMETER 1, 18/PARAMETER 2
```

generates the following table.

```
          5      4      3      2      1
98765432109876543210987654321098765432109876543210
-----
EXAMPLE /PP PROGRAM          /PARAMETER 1      /PARAMETER 2      /
-----
```

The bit position header is generated each time a new block of *T statements is encountered. The header is not listed for consecutive table statements or for any statement containing a nonblank character in column 3 of the first *T statement in a block. The identifier EXAMPLE is optional.

In the statement format shown, a slash must immediately follow a bit count field; however, spaces before the bit count are ignored. All bit counts for field widths can be specified in either octal or decimal. Decimal counts are assumed in the absence of a post radix B. All table entry description statements within an *T block represent the same total number of bits as the first statement. A maximum table width of 60 bits is allowed.

The slash separates fields in the table. The bit position that the slash occupies is included in the field to its left. Single bit fields are not listed with a slash separator. Instead, they have a + below the field position. If only one table entry is listed, the + is listed both above and below the field position.

FURTHER CONSIDERATIONS

All loader control statements (overlay, section, etc.) are considered special, and their images are placed with the page number at the foot of each subprogram to which the directive applies.

All END statements are considered special since they terminate a chapter.

In COMPASS, the first TITLE statement has special meaning. Its contents (if nonblank) replace the page header. All subsequent TITLE statements are ignored.

In COMPASS, the LIST statement has special meaning. The parameters X and L on a COMPASS control statement are processed normally. If a -L is encountered, however, all documentation is suppressed until a LIST L statement is encountered. If a -X is encountered, no documentation is processed on common text CTEXT until a LIST X statement is found.

The maximum number of these LIST statements that can be processed by DOCUMENT is 24. If more than 24 LIST X, -X, L, or -L statements are encountered, the following message is issued.

```
LIST CARD LIMIT - CARD IGNORED.
```

The CTEXT and ENDX statements are bracket statements surrounding common text. No documentation is listed unless a LIST X statement is encountered.

CODING SPECIFICATIONS

The current NOS coding specifications are contained in a file called CODING. A NOS coding standard also exists for SYMPL programs; this standard is contained in a file called SYMPCOD.† These files are in 7-bit ASCII format and can be routed directly to an upper/lower case ASCII printer or edited using the full screen editor FSE.

You can convert these files to 6/12-bit display code (for use with some interactive editors or for an online manual) using the following commands:

```
ATTACH,pfn/UN=LIBRARY          (pfn is either CODING or SYMPCOD)
FCOPY,P=pfn,PC=ASCII8,N=FILE2,NC=ASCII
(save, list, or edit FILE2)
```

To convert these files to 6-bit display code (for example, if your site has only upper case print trains), enter the following commands:

```
ATTACH,pfn/UN=LIBRARY          (pfn is either CODING or SYMPCOD)
FCOPY,P=pfn,PC=ASCII8,N=FILE2,NC=DIS
(save, list, edit, or route FILE2)
```

†These files are provided to each site; you should check with your site for instructions on accessing these files. The following examples assume that your site has saved the files as direct access files under user name LIBRARY.

MAGNETIC TAPE FORMATS

J

The standard magnetic tapes used are seven-track, 1/2-inch tape and nine-track, 1/2-inch tape. Each type of tape can be written in binary or coded (except SI) mode. Unless specified otherwise, tapes are assumed to be in binary mode. You can select 200, 556, or 800 characters per inch (cpi) density for seven-track tapes, or 800, 1600, or 6250 cpi density for nine-track tapes, provided these densities are available with the hardware. Tape density can be specified by a LABEL, ASSIGN, or REQUEST command (refer to Volume 3, System Commands), the LABEL macro (refer to section 4), or an IPRDECK installation option (refer to the NOS 2 Analysis Handbook). The system normally performs automatic processing of tape parity errors and end-of-tape conditions. However, you can control the processing of these functions via the PO keyword on LABEL, ASSIGN, and REQUEST commands, the up and ep fields of the FET (FET+1, bits 45 and 44), or the LABEL macro processing options.

DATA FORMATS

Data can be recorded on magnetic tape in any of five formats.

<u>Format</u>	<u>Description</u>
I	Internal
S	Stranger
SI binary	System internal†
L	Long block stranger
F	Foreign

The system command user specifies the data format via the F keyword of a LABEL, ASSIGN, or REQUEST command. The LABEL macro user specifies the data format via FET+10g, bits 35 through 30. The following is a description of the physical and logical characteristics of each format. You can define maximum block size, end-of-reel conditions, and noise for any format via command or FET parameters; the following description of these characteristics defines the suggested (and default) values.

†NOS/BE system default tape format.

I (INTERNAL) FORMAT

<u>Characteristic</u>	<u>Description</u>
Header	Labeled or unlabeled.
Mode	Binary.
Block size (PRU size)	Actual data block size can range from 0 to 512 (1000 _g) CM words in exact multiples of CM words. All blocks except those containing labels include a 48-bit block terminator formatted as follows:

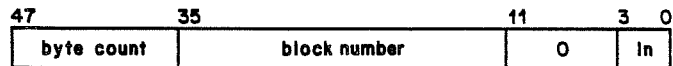

byte count Total number of bytes in the block including the block terminator.

block number Number of blocks since the last HDR1 label.

ln Level number:

0 End-of-record.

17_g End-of-file.

User-specified frame or character counts have no meaning.

Logical end-of-record	Any block with fewer than 512 (1000 _g) CM words of data is considered a logical end-of-record. During a write operation, the level number field of the block terminator contains the level number obtained from FET+0, bits 17 through 14, or the WRITECW macro control word. During read operations, the system returns end-of-record status and the contents of the block terminator level number field. If the level number is 17 _g , the system also returns end-of-file status. Some blocks may consist only of a block terminator.
Logical end-of-file	Any block consisting of only a block terminator with a level number of 17 _g is considered a logical end-of-file. The system ensures that an end-of-record always precedes an end-of-file by writing, if necessary, a block terminator with a level number of zero prior to the end-of-file.
Logical end-of-information	A tape mark followed by an EOF1 label is considered the end-of-information. This trailer sequence is generated by the system on labeled and unlabeled I and SI format tapes. The system issues a label content error if it encounters a tape mark without a valid label following it.

<u>Characteristic</u>	<u>Description</u>
End-of-reel	Refer to option 3 under End-Of-Tape/End-Of-Reel Conditions.
Noise	Any block containing fewer than eight frames for seven-track tapes or six frames for nine-track tapes is considered noise and, therefore, is ignored.
Special considerations	<ul style="list-style-type: none"> • All nine-track tapes are written in an even multiple of bytes. • On all read operations, the system checks for fill status and compares the number of bytes read and the block number expected with the byte count and block number values in the block terminator. If the specified condition does not occur, the system handles it as if it were a parity error. This method is designed to prevent dropped or fragmented blocks; in general, it provides a much higher degree of reliability than any other format.

S (STRANGER) FORMAT

<u>Characteristic</u>	<u>Description</u>
Header	Labeled or unlabeled.
Mode	Binary or coded as indicated by FET+0, bit 1.
Block size (PRU size)	<p>No explicit multiple of frames is required. The maximum block size may be specified in the mlrs field of FET+6, bits 17 through 0. If no block size is specified in the mlrs field, it is assumed to be 1000_g CM words. The maximum block size for S format is 1000_g.</p> <p>If the required block is longer than 1000_g words, the tape should be assigned in L format.</p>
Logical end-of-record	On a CIO READ (010) or READSKP (020) request, each PRU is considered an end-of-record.
Logical end-of-file	Tape mark.
Logical end-of-information	If the tape is unlabeled, there is no logical end-of-information. If the tape is labeled, the logical end-of-information is a tape mark followed by an EOF1 label.
End-of-reel	Refer to option 3 under End-of-Tape/End-of-Reel Conditions.

<u>Characteristic</u>	<u>Description</u>
Noise	Any block containing fewer than 18 frames is considered noise and, therefore, is ignored.
Special considerations	<ul style="list-style-type: none"> • Level numbers 1 through 16_g are interpreted as level number 0. • Standard code conversion is performed for seven- or nine-track tapes in coded mode. • For CIO READ (010), WRITE (014), WRITER (024), and WRITEF (034) functions, a one-block (PRU) operation is performed with the unused bit count (FET+6, bits 24 through 29) taken from and returned to the FET.

SI (SYSTEM INTERNAL) FORMAT

<u>Characteristic</u>	<u>Description</u>
Header	Labeled or unlabeled.
Mode	Binary as indicated by FET+0, bit 1. If coded mode is set on an SI tape, the system aborts the job step. (Refer to the TCOPY command description in Volume 3, System Commands, for details on reading coded SI tapes.)
Block size (PRU size)	<p>The block size can range from 0 to 512 (1000_g) CM words in exact multiples of CM words. Any block smaller than the maximum size except those containing labels contain a 48-bit block terminator. This terminator has the same format as that for I format.</p> <p>User-specified frame or character counts have no meaning.</p>
Logical end-of-record	Any block containing fewer than 512 (1000 _g) CM words represents a logical end-of-record. If a logical record consists of an exact multiple of 512 CM words, the block that denotes the logical end-of-record consists solely of a block terminator. During write operations, the level number field of the block terminator contains the level number from FET+0, bits 17 through 14, or the WRITECW macro control word. During read operations, the system returns end-of-record status and the contents of the block terminator level number field. If the level number is 17 _g , the system returns end-of-file status.
Logical end-of-file	Same as for I format.
Logical end-of-information	Same as for I format.
End-of-reel	Refer to option 3 under End-of-Tape/End-of-Reel Conditions.
Noise	Same as for I format.

<u>Characteristic</u>	<u>Description</u>
Special considerations	<ul style="list-style-type: none"> • The system writes all nine-track tapes with 3n+2 mode; that is, the system may write an extra 4 bits to tape in order to preserve the lower 4 bits of a CM word. • The system does not perform block checking via block terminators as is done for I format.

L (LONG BLOCK STRANGER) FORMAT

The characteristics and descriptions are the same as for S format tapes except that no maximum block size is defined and, if no block size is specified in the mlrs field of FET+6, bits 17 through 0, it is assumed to be:

- LIMIT-FIRST-1 for normal read/write
- LIMIT-FIRST-2 for READN/WRTTEN
- LIMIT-FIRST-3 for READCW/WRITTECW

F (FOREIGN) FORMAT

<u>Characteristic</u>	<u>Description</u>
Label	Unlabeled.
Mode	Binary or coded, as needed, for seven-track tapes and binary for nine-track tapes.
Block size (PRU size)	The block size cannot exceed the CM buffer size. No explicit multiple of frames is required. The maximum block size must be specified at tape request time. The block size is used to determine whether to continue read or write operations based on the amount of data versus the space in the buffer. For example, if the maximum block size is 1000g CM words, the read operation stops any time that less than 100lg words remain. The user must specify a buffer size equal to the largest block size.
Logical end-of-record	None.
Logical end-of-file	Tape mark.
Logical end-of-information	None.
End-of-reel	Refer to option 3 under End-of-Tape/End-of-Reel Conditions.
Noise	Any block containing fewer than 18 frames is considered noise and, therefore, is ignored.

<u>Characteristic</u>	<u>Description</u>
Special considerations	<ul style="list-style-type: none"> • For seven-track tapes, if a parity error is detected because the tape is being read in the opposite mode, the mode will be switched. • F-format operations are done only when using control word reads and writes. On read operations, the control words are transferred to the user regardless of the operation being used. <p>Labeled tapes that have been assigned as F format will have their labels treated as data.</p>

END-OF-TAPE/END-OF-REEL CONDITIONS

The following is a description of the processing options for end-of-tape (EOT) conditions. You can select one of these options by default by specifying the data format; by specifying an option via the PO keyword on a LABEL, ASSIGN, or REQUEST command; or by specifying the LABEL macro processing option field in FET+108, bits 47 through 45. In addition, the user processing bit (FET+1, bit 45) gives the user program control over end-of-reel conditions. For further information, refer to the CLOSER, REWIND, and UNLOAD macros described in section 3.

<u>Option</u>	<u>Command PO Option</u>	<u>LABEL Macro PO Bit</u>	<u>Description</u>
1	I	47	If, during a write operation, the system senses the end-of-tape, it rewrites the block on which the EOT occurred as the first block on the following reel. No trailer information is written on the current reel. During a read operation, the block on which the EOT occurred is ignored and reading continues on the next reel. If a tape mark and the EOT are sensed at the same time, the EOT is ignored.
2	P	46	If, during a write operation, the system senses the end-of-tape, the system writes a trailer sequence, consisting of a tape mark, following the block on which the EOT was sensed. Any data that occurs following the block on which EOT was sensed, yet before the tape mark, is ignored. During a read operation, the system transfers to the user the block on which the EOT was sensed. The read operation resumes on the next reel. If a tape mark and the EOT are sensed at the same time, the EOT is ignored.

<u>Option</u>	<u>Command PO Option</u>	<u>LABEL Macro PO Bit</u>	<u>Description</u>
3	S	45	If, during a write operation, the system senses the end-of-tape, the system writes a trailer sequence following the block on which the EOT was sensed. This trailer sequence consists of a tape mark followed by an EOVI label for labeled tapes and tape marks for unlabeled tapes. The next block is written on the next reel. During a read operation, the EOT is noted and the system transfers to the user the block on which the EOT was sensed plus all following blocks until a trailer sequence (as described above) is recognized. Reading resumes on the next reel.

For options 1 and 2, the system is concerned only with the block on which the EOT is sensed. If tapes written using these options are transferred to another system, any data that occurs on the reel after this block should be ignored.

HDR1 LABEL FORMAT

The format of the HDR1 label is provided here as a reference for the CIO and LFM functions described in sections 3 and 4. When the HDR1 label is returned to the circular buffer or an extended label buffer, it is in this format. For a complete description of each field and the formats of other magnetic tape labels, refer to appendix G of Volume 3, System Commands.

59	53	41	35	29	17	5	0
HDR1		file identifier (fi)					
file identifier (fi)							
fi	set identification				file section number (secno)		
secno	file sequence number		generation number		gvn		
gvn	creation date				expiration date		
expiration date		fa	block count				
system							
system		reserved					

file identifier (fi) File identifier (up to 17 display code characters, left-justified with display code blank fill).

set identification One- to six-character set identification (left-justified with display code blank fill).

file section number (secno) One- to four-digit numeric display code file section number (right-justified with display code zero fill).

file sequence number One- to four-digit numeric display code file sequence number (right-justified with display code zero fill).

generation number One- to four-digit numeric display code generation number (right-justified with display code zero fill).

gvn One- to two-digit numeric display code generation version number (right-justified with display code zero fill).

creation date Creation date (two-digit numeric display code value for the year followed by a three-digit numeric display code value for the day within the year).

expiration date Expiration date (two-digit numeric display code value for the year followed by a three-digit numeric display code value for the day within the year).

fa One display code character indicating the file accessibility to the tape.

block count Must be zeros.

system Up to 13 display code characters identifying the operating system that recorded this file.

reserved Reserved for future use.

BIBLIOGRAPHY

K

Appendix K is a bibliography of all Control Data publications that are related to NOS Version 2.

<u>Control Data Publication</u>	<u>Publication Number</u>
Advanced Tape Subsystem Reference Manual	60449600
ALGOL-60 Version 5 Reference Manual	60481600
APEX IV Reference Manual	84002550
APL Version 2 Reference Manual	60454000
APT IV Version 2 Reference Manual	17326900
BASIC Version 3 Reference Manual	19983900
Binary Maintenance Log (BML) Message Formats	60459940
COBOL Version 5 Reference Manual	60497100
Common Memory Manager Version 1 Reference Manual	60499200
COMPASS Version 3 Reference Manual	60492600
CYBER Cross System Version 1 Build Utilities Reference Manual	60471200
CYBER Cross System Version 1 Macro Assembler Reference Manual	96836500
CYBER Cross System Version 1 Micro Assembler Reference Manual	96836400
CYBER Cross System Version 1 Pascal Reference Manual	96836100
CYBER Database Control System 2 Database Administrator Reference Manual	60485200
CYBER Database Control System 2 Application Programming Reference Manual	60485300
CYBER Initialization Package (CIP) User's Handbook	60457180
CYBER Interactive Debug Version 1 Reference Manual	60481400
CYBER Loader Version 1 Reference Manual	60429800
CYBER Record Manager Advanced Access Methods Version 2 Reference Manual	60499300

<u>Control Data Publication</u>	<u>Publication Number</u>
CYBER Record Manager Basic Access Methods Version 1.5 Reference Manual	60495700
CYBER Supermini Operations Handbook User's Guide	60459850
CYBER 70 Model 71 Computer System Hardware Reference Manual	60453300
CYBER 70 Model 72 Computer System Hardware Reference Manual	60347000
CYBER 170 Computer Systems Models 171 through 175 (Levels A, B, C) Model 176 (Level A, B, C) Hardware Reference Manual	60420000
CYBER 170 Computer Systems Models 720, 730, 740, 750, and 760, Model 176 (Level B/C) Hardware Reference Manual	60456100
CYBER 170 Computer Systems Models 815 and 825 Hardware Operator's Guide	60469370
CYBER 170 Computer Systems Models 815 and 825 Hardware Reference Manual	60469350
CYBER 170 Computer Systems Models 835, 845, and 855 CYBER 180 Computer Systems Models 835, 840, 845, 850, 855, 860, and 990 CYBER 990E and 995E Computer Systems CYBER 170 State Hardware Reference Manual	60469290
CYBER 170 Computer Systems Models 835, 845, and 855 CYBER 180 Computer Systems Models 835, 845, and 855 Hardware Operator's Guide	60458390
CYBER 170 Computer Systems Models 865 and 875 Hardware Reference Manual	60458920
CYBER 180 Models 810 and 830 Computer Systems Hardware Operator's Guide	60469440
CYBER 180 Models 810 and 830 Computer Systems Hardware Reference Manual	60469420
CYBER 840A, 850A, 860A, and 870A Computer Systems Hardware Reference Manual	60463560
DataBase Utilities Version 1 Reference Manual	60498800
Data Catalogue 2 Version 1 Reference Manual	60483200
DDL Version 3 Reference Manual, Volume 1	60481900
DDL Version 3 Reference Manual, Volume 2	60482000
DDL Version 3 Reference Manual, Volume 3	60482100
FORM Version 1 Reference Manual	60496200
FORTRAN Extended Version 4 Common Library Mathematical Routines Reference Manual	60498200
FORTRAN DataBase Facility Version 1 Reference Manual	60482200
FORTRAN Extended Version 4 Reference Manual	60497800
FORTRAN Extended Version 4 to FORTRAN Version 5 Conversion Aids Program Version 1 Reference Manual	60483000

<u>Control Data Publication</u>	<u>Publication Number</u>
FORTRAN Version 5 Common Library Mathematical Routines Reference Manual	60483100
FORTRAN Version 5 Reference Manual	60481300
General Purpose Simulation System V (GPSS) General Information Manual	84003900
Information Management Facility Version 1 Application Programming Reference Manual	60484500
Magnetic Tape Subsystem Operation and Programming Manual	60403900
Message Control System Version 1 Reference Manual	60480300
Modify Version 1 Instant	60450200
Modify Version 1 Reference Manual	60450100
Network Access Method Version 1 Host Application Programming Reference Manual	60499500
Network Access Method Version 1 Network Definition Language Reference Manual	60480000
Network Access Method Version 1/CCP Version 3 Terminal Interfaces Reference Manual	60480600
NOS Version 2 Administration Handbook	60459840
NOS Version 2 Analysis Handbook	60459300
NOS Version 2 Applications Programmer's Instant	60459360
NOS Version 2 Diagnostic Index	60459390
NOS Version 2 Full Screen Editor User's Guide	60460420
NOS Version 2 Installation Handbook	60459320
NOS Version 2 Operations Handbook	60459310
NOS Version 2 Reference Set, Volume 1, Introduction to Interactive Usage	60459660
NOS Version 2 Reference Set, Volume 2, Guide to System Usage	60459670
NOS Version 2 Reference Set, Volume 3, System Commands	60459680
NOS Version 2 Reference Set, Volume 4, Program Interface	60459690
NOS Version 2 Screen Formatting Reference Manual	60460430

<u>Control Data Publication</u>	<u>Publication Number</u>
NOS Version 2 Security Administrator's Handbook	60460410
NOS Version 2 System Overview	60459270
NOS Version 2 Systems Programmer's Instant	60459370
NOS Version 2 Tape Management System (TMS) User Reference Manual	60463110
NOS Version 2 Tape Management System (TMS) Site Operations Manual	60463350
On-Line Maintenance Software Reference Manual	60454200
PERT/Time Version 2 Reference Manual	60456030
PL/I Version 1 Reference Manual	60388100
Query Update Version 3 Reference Manual	60498300
Remote Batch Facility Version 1 Reference Manual	60499600
Remote Host Facility Access Method Reference Manual	60459990
Remote Host Facility Usage	60460620
SIMSCRIPT II.5 User Information Manual	84000460
Simulator Version 1 Reference Manual	60480500
Sort/Merge Versions 5 and 1 Reference Manual	60497500
SYMPL Version 1 Reference Manual	60496400
TAF Version 1 Reference Manual	60459500
TAF Version 1 User's Guide	60459520
TAF/CRM Data Manager Version 1 Reference Manual	60459510
TOTAL - CDC Version 2 Reference Manual	76070300
Update Version 1 Reference Manual	60449900
XEDIT Version 3 Reference Manual	60455730
8-Bit Subroutines Reference Manual	60495500

SHELL PROCESSING

L

The SHELL command sets controls for a command monitoring program. The SHELL command includes:

- Name of the shell program.
- Location of shell program (local file, global library, or SYSTEM).
- Commands to monitor: commands entered from an interactive terminal, commands outside procedures, commands inside procedures.
- Optional clearing of controls if the shell program aborts.

The name of the shell program and shell control bits are stored by CPM in word SHCN of your negative field length.

When the shell program is called, the current command is passed in CCDR (locations RA+70B through RA+77B). If there is no current command (as when you are monitoring commands entered from an interactive terminal), RA+70B is zero and the current contents of MSIW from the job's control point area are passed in ARGR (locations RA+2 through RA+6).

The shell program may take any action as a result of the command. Specifically, it may issue the same or another NOS command using the EXCST macro. The shell program is not called for commands originated by the SHELL program through the EXCST macro, but is called for commands issued by user programs through the EXCST macro.

Entering

SHELL.

disables shell screening. However, if a shell program is in effect, it may not permit you to enter the SHELL command, thus preventing you from clearing the shell screening.

If you want to monitor commands entered from an interactive terminal, your shell program must also read commands from the terminal. The system loads your shell program automatically whenever your interactive job is idle (no commands or procedures are executing). Your shell program must then read the next command from file INPUT. This process circumvents the command syntax processing normally performed by IAFEX and allows your shell program to enforce optional syntax rules.

Two sample shell programs are provided: one written in COMPASS and one written in FORTRAN 5.

SHELL PROGRAM EXAMPLE USING COMPASS

The following is an example of a shell program that permits the use of non-NOS syntax commands (refer to figure L-1). In this example, a simple shell program, SHELDEM, is used to permit commands that are longer than seven characters.

The SHELL command

SHELL,SHELDEM,G,T.

causes a global library load (G option) of the shell program SHELDEM to screen commands whenever an interactive command (T option) is entered.

The valid commands created for this shell example are ASSEMBLER, DOCUMENT, and DOVEDANYA. They refer to the procedures CMSPRC, DOCPROC, and SHELL, respectively.

Since SHELDEM is loaded at the interactive end-of-job step, there are no values passed to CCDR (RA+70B). SHELDEM prompts the user with a time stamp, and then accepts the next command entered by the user. The command is processed further by executing a procedure or a NOS command associated with the command.

NOTE

For brevity, SHELDEM has been kept simple. It will not handle commands with leading blanks, \$ signs, lowercase characters, or internal blanks.

```

.PROC,SHELLP*I"DEMONSTRATION OF SHELL"
.
.IF,FILE(OPL,.NOT.AS).ATTACH,OPL/UN=LIBRARY.
MODIFY,Q,CS=NOSTEXT,Z./*CREATE,SHELDEM/*EDIT,SHELDEM
LIBEDIT,P=0,B=LGO,U=SHELBIN,N=SHELLIB,I=0.
LIBRARY,SHELLIB.
SHELL,SHELDEM,G,T.
.*
.DATA,SHELDEM
SHELDEM
        IDENT  SHELDEM,FWA
        ABS
        ENTRY  SHELDEM
        ENTRY  RFL=
        SYSCOM B1

        FWA    ORG    111B
        BSS    0

*CALL    COMCCMD
*CALL    COMCMAC
*CALL    COMSTCM

IBUFL    EQU    101B        TERMINAL INPUT BUFFER LENGTH
OBUFL    EQU    101B        TERMINAL OUTPUT BUFFER LENGTH

I        BSS    0            TERMINAL INPUT
ZZZZZII FILEC  IBUF,IBUFL,DTY=2RTT
0        BSS    0            TERMINAL OUTPUT
ZZZZZ00 FILEC  OBUF,OBUFL,DTY=2RTT

SHELDEM  SB1    1            PRESET B1=1
SHD1     RJ     GCI          GET COMMAND INPUT
        SA1    CCCR
        ZR     X1,SHD3      IF NO COMMAND
        BX6    X1
        SA6    CMDSA        ENSURE COMMAND WILL BE MATCHED
        SA5    CMDS-1      FWA OF COMMAND TABLE-1
SHD2     SA5    A5+B1
        IX3    X5-X1
        NZ     X3,SHD2      IF NOT MATCHED
        SX4    A5-CMDSA
        ZR     X4,SHD3      IF COMMAND NOT IN TABLE
RETURN  I,R          RETURN TERMINAL INPUT FILE
RETURN  O,R          RETURN TERMINAL OUTPUT FILE
EXCST  PRCT-CMDS+A5 EXECUTE CORRESPONDING PROCEDURE

```

Figure L-1. Shell Program Example Using COMPASS (Sheet 1 of 3)

```

SHD3   WRITEW O,SHDA,SHDAL UNKNOWN COMMAND
EQ     SHD1           LOOP FOR ANOTHER COMMAND

SHDA   DIS   ,* SHELDEM - UNKNOWN COMMAND.*
SHDAL  EQU   *-SHDA

CMDS   DATA L*ASSEMBLER*  VALID COMMANDS
DATA   L*DOCUMENT*
DATA   L*DOVEDANYA*  CLEAR SHELL PROCESSING
CMDSA  BSS   1           RESERVE FOR INPUT COMMAND

PRCT   DATA L*CMPSRC.*  PROCEDURES (MUST BE SAME ORDER AS CMDS)
DATA   L*DOCPROC.*
DATA   L*SHELL.*  CLEAR SHELL PROCESSING.

GCI    SUBR                GET COMMAND INPUT
SA1    GCIB                CHECK IF CALLED BEFORE
NZ     X1,GCI1
SX6    B1                 FLAG CALLED BEFORE
SA6    A1
MX6    1                 SET FLUSH BIT ON OUTPUT
LX6    36+1
SA1    0+1
BX6    X6+X1
SA6    A1
SETLOF GCIC                SET LIST OF FILES
RETURN I,R                RETURN INPUT FILE
RETURN O,R                RETURN OUTPUT FILE
REQUEST I,U,NMSG          ASSIGN INPUT TO TERMINAL
REQUEST O,U,NMSG          ASSIGN OUTPUT TO TERMINAL
WRITE  O,*                PRESET WRITE CODE FOR IMPLICIT TT OUTPUT

GCI1   PROMPT OFF          TURN OFF IAF **
CLOCK  GCIA                OUTPUT TIME PROMPT
WRITEW O,GCIA,GCIAL
READ   I                   GET COMMAND
READO  I
ZR     X1,GCI2            IF NOT (CR)
SX6    0
GCI2   SA6    CDDR
EQ     GCIX

```

Figure L-1. Shell Program Example Using COMPASS (Sheet 2 of 3)

```

GC IA   BSS   1           TIME STAMP FOR INPUT PROMPT
        VFD  12/OL>,48/OL"EB" END OF BLOCK TERMINAL CONTROL
GC IAL  EQU   *-GC IA    LENGTH OF TIME STAMP STRING
GC IB   CON   0           ZERO IF FIRST TIME IN GCI
GC IC   VFD  12/,18/GC ID,30/ LIST OF FILES POINTER
GC ID   VFD  1/,41/,18/GCIDL LIST OF FILES
        VFD  42/OLZZZZZ00,18/0
        VFD  60/
GC IDL  EQU   *-GC ID

IBUF    BSS   IBUFL      TERMINAL INPUT BUFFER
OBUF    BSS   OBUFL      TERMINAL OUTPUT BUFFER

*CALL   COMCCIO
*CALL   COMCCPM
*CALL   COMCLFM
*CALL   COMCRDO
*CALL   COMCSYS
*CALL   COMCWTW

RFL=    EQU   *           FIELD LENGTH

END

```

Figure L-1. Shell Program Example Using COMPASS (Sheet 3 of 3)

SHELL PROGRAM EXAMPLE USING FORTRAN 5

The following is an example of a shell program that prevents the user from gaining access to a particular program (in this case, program PAYROLL). In the example shown in figure L-2, entering the command PAYROLL causes the shell program to respond with the following message:

PRIVILEGED PROGRAM. TRY ANOTHER COMMAND.

```

.PROC,SHELLP*I"DEMONSTRATION OF SHELL"
.
.IF,FILE(OPL,.NOT.AS).ATTACH,OPL/UN=LIBRARY.
FTN5,I=SHELDDEM,L=LIST,X=OPL.
LIBGEN,P=SHELLIB,N=SHELBIN.
LIBRARY,SHELLIB.
SHELL,SHELDDEM,G,T.
REVERT.NOLIST.
.*
.DATA,SHELDDEM.
PROGRAM SHELDDEM
C
CHARACTER CMD*80
INTEGER END
C
READ(*,'(A)',END=100) CMD
CALL PERIOD (CMD,END)
IF (CMD.EQ.'PAYROLL.') THEN
PRINT *,'PRIVILEGED PROGRAM. TRY ANOTHER COMMAND.'
ELSE
CALL ZEROFIL(CMD,END)
CALL EXC(CMD)
ENDIF
STOP
C
100 PRINT *,'ENTER A COMMAND.'
C
END
IDENT EXC
ENTRY EXC
OPL XTEXT COMCSYS
OPL XTEXT COMCMAC
EXC EQ *
SB1 1
SA1 A1
SA5 X1
EXCST A5
EQ EXC
END
C
C
SUBROUTINE ZEROFIL
C
CHARACTER CMD*80
INTEGER END
C
DO 10 I=END+1,80
CMD(I:I)=CHAR(0)
10 CONTINUE
RETURN
END
C
C
SUBROUTINE PERIOD (CMD,END)
C

```

Figure L-2. Shell Program Example Using FORTRAN 5 (Sheet 1 of 2)

```

CHARACTER CMD*80
INTEGER END
C
DO 10 I=80,1,-1
C
IF (CMD(I:I).NE.' ') THEN
C
IF (CMD(I:I).NE.'.') THEN
CMD(I+1:I+1)='.'
END=I+1
C
ELSE
C
END=I
C
ENDIF
GOTO 20
C
ENDIF
10 CONTINUE
C
20 CONTINUE
RETURN
END

```

Figure L-2. Shell Program Example Using FORTRAN 5 (Sheet 2 of 2)

EXTENDED REPRIEVE PROCESSING

M

An example of the extended reprieve capabilities of RPV is contained in this appendix.

The COMPASS program shown in figure M-1 illustrates the following.

- The SETUP function is used to initialize the parameters for the RPV interface. The mask bits are set to intercept terminal interrupts.
- If no error occurs, a user program will loop until X1 reaches the maximum value.
- Any error causes branching to error checking. If the error is of the terminal interrupt class, the value in the operating error flag is received. If not, branching to unhandled errors occurs, and the program aborts.
- The terminal interrupt error is assumed to be a user break 1 (CTRL-P). The error is compared with the user break 1 mask. If the error is not a user break 1, a user break 2 is assumed. The error is then compared with the user break 2 mask. If the error is not a user break 2 (CTRL-T), branching to unhandled errors occurs and the program aborts.
- The type of user break and the value of X1 at the interrupt is passed to the dayfile.
- Control returns to the loop program at the point of interrupt and processing resumes.

```

.PROC, TRYRPV*I.
.HELP
.PGG 03-AUG-82 TRY OUT EXTENDED REPRIEVE TO DISTINGUISH UB1/UB2.
.ENDHELP
.REWIND,*
.IF, FILE (OPL, .NOT. AS).ATTACH, OPL /UN=LIBRARY.
COMPASS, I=C IN, L=F 1, S=NOSTEXT, S=PSSTEXT.
.LGO.
.DATA, C IN
    IDENT  TRY1
    ENTRY  TRY1
    SST                                SO CAN GET PPTXT/NOSTEXT SYMBOLS
    SYSCOM B1

OPL      XTEXT  COMSRPV

TRY1     SB1    1                      B1=1

*        SET REPRIEVE ON TERMINAL INTERRUPT(S)

        REPRIEVE TIHB, SETUP, /COMSRPV/TIMS

*        LOOP UNTIL INTERRUPTED

        BX1     X1-X1          SET X1 TO ZERO
        SX2     B1
        MX0     35
LOOP     IX1     X1+X2          LOOP UNTIL INTERRUPTED
        BX3     X0*X1
        ZR      X3, LOOP       IF MAXIMUM VALUE STILL NOT REACHED
        ENDRUN                    OTHERWISE DONE

*        BRANCH HERE ON ANY ERROR

TIH      BSS     0
        MX0     -24
        SA1     TIHB+/COMSRPV/ERCL
        LX1     -12
        BX1     -X0*X1        GET ERROR CLASS
        SX1     X1-/COMSRPV/TICL CHECK FOR TERMINAL INTERRUPT
        NZ      X1, ABT       IF NOT TERMINAL INTERRUPT
        SA1     TIHB+/COMSRPV/OSEF
        MX0     -12
        BX1     -X0*X1        GET OPERATING SYSTEM ERROR FLAG
        SA3     =C*USR BRK 1 * ASSUME USER BREAK 1 OCCURRED
        SX2     X1-TIET
        ZR      X2, TIH1      IF USER BREAK 1
        SA3     =C*USR BRK 2 * OTHERWISE USER BREAK 2
        SX2     X1-TAET
        NZ      X2, ABT       IF NOT USER BREAK 2

```

Figure M-1. Extended Reprieve Example (Sheet 1 of 2)

```

*          PROCESS TERMINAL INTERRUPT

TIH1      BSS      0
          BX6      X3          WHICH USER BREAK
          SA6      TIHA        PUT INTO MESSAGE
          SA1      TIHX+11B     X1 WHEN INTERRUPT OCCURRED

          QJAL     IHX          QUALIFY MESSAGE MACRO
          RJ       CDD
          SA6      TIHA+2
          MESSAGE  TIHA,3,R     ISSUE DAYFILE MESSAGE ABOUT USER BREAK
          QJAL     *

          REPRIEVE TIHB,RESUME,/COMSRPV/TICL CONTINUE ADDING

TIHA      DATA    H*USR BRK ??*
          DATA    H*X1 VALUE =*
          BSSZ     2          VALUE AND ZERO FOR MESSAGE ENDING

ABT       BSS      0          UNHANDLED ERROR OCCURRED
          SYSTEM   DMD,R,TIHB+/COMSRPV/REPL,TIHB
          ABORT

TIHB      RPVBLK  TIH,TIHX     TERMINAL INTERRUPT REPRIEVE BLOCK

          QJAL     IHX
QUAL$     SET      0          FORCE UNQUALIFIED COMMON DECKS
OFL       XTEXT    COMCSYS
OFL       XTEXT    COMCCDD
          QJAL     *

          END      TRY1

```

Figure M-1. Extended Reprieve Example (Sheet 2 of 2)

INDEX

- Abort C-1
- ABORT macro 11-1
- Absolute assembly C-1
- Access category C-1
- Access level C-1
- Access level limits C-1
- Accessing files 3-7
- Account block C-1
- Accounting information 6-17
- ACTR symbol 1-9; E-2
- Allocatable device C-1
- Alphanumeric C-1
- ALTER function 3-13
- Alternate
 - User access 5-4
 - User name C-1
- ALTERNR function 3-13
- ANSI C-1
- ANSI labels 3-15,46
- APPEND macro 5-30
- ARGR symbol 1-8; E-2
- ASCII
 - Defined C-1
 - Graphic character sets A-1
 - 128-character set A-1
- ASSIGN macro 4-9
- ATTACH macro 5-36
- Auto
 - Recall
 - Bit 1-3
 - Defined C-1
- Auxiliary device C-1
- Auxiliary device requests 5-14

- Backspace status 3-42
- Backspacing a file 3-42,43,53
- Bibliography K-1
- Binary dump
 - Central memory 11-17
 - Exchange package 11-17
 - Extended memory 11-17
- Binary format
 - OPL G-2
 - OPLD G-5
 - PP G-1
 - PROC G-9
 - TEXT G-9
 - ULIB G-7
- Binary formats G-1

- BKSP macro 3-42
- BKSPRU macro 3-43
- Block C-1
- BOI C-1
- Buffer
 - Circular 2-1
 - Defined C-2
 - Pointers 2-1
- Byte C-2

- *CALL directive 1-11
- CATLIST macro 5-21
- CCAC symbol 5-43
- CCAL symbol 5-44
- CCAP symbol 5-30
- CCAT symbol 5-36
- CCCG symbol 5-38
- CCCT symbol 5-21
- CCDF symbol 5-32
- CCDR symbol 1-9; E-3
- CCGT symbol 5-19
- CCOD symbol 5-42
- CCPG symbol 5-20
- CCPM symbol 5-27
- CCRP symbol 5-29
- CCSV symbol 5-15
- Central memory C-2
- Central processor unit C-2
- CHANGE macro 5-38
- Character set
 - Anomalies A-2
 - ASCII graphic 63-character set A-1
 - ASCII graphic 64-character set A-1
 - ASCII graphic 95-character set A-1
 - ASCII 128-character set A-1
 - Batch jobs A-3
 - CDC graphic 63-character set A-1
 - CDC graphic 64-character set A-1
 - Interactive jobs A-3
 - Tables A-2
- Checkpoint
 - Defined C-2
 - File C-2
- CHECKPT macro 10-5
- Checksum C-2
- CIO
 - Call format 3-1
 - CLOSE function 3-12
 - Common decks 3-4

Function processing	3-4	COMCRDC	F-9,11
OPEN function	3-12	COMCRDH	F-9,11
Processing options	3-6	COMCRDO	F-9,11
Read functions	3-24	COMCRDS	F-9,11
Request	3-1	COMCRDW	F-9,11
Status response codes	3-6	COMCRSP	F-9
Write functions	3-33	COMCSFM	F-9
CIO= entry point	F-10	COMCSFN	F-9
Circular buffer	2-1; C-2	COMCSNM	F-9
CLOCK macro	9-2	COMCSRT	F-10
CLOSE macro	3-20	COMCSSN	F-10
CLOSER macro	3-23	COMCSST	F-10
Closing a file	3-20	COMCSTF	F-10
CMUR symbol	1-9; E-2	COMCSYS	F-10,11
Code set		COMCUPC	F-10
Definition	A-1	COMCUSB	F-10
6-bit display code	A-1	COMCVDT	F-10
6/12-bit display code	A-1	COMCVLC	F-10
7-bit ASCII	A-1	COMCWOD	F-10
Coded mode	C-2	COMCWTC	F-10,11
Coding specifications	I-8	COMCWTH	F-10,11
Combined input/output	3-1	COMCWTO	F-10,11
Command record	C-2	COMCWTS	F-10,11
Comment field	I-2	COMCWTW	F-10,11
Common decks		COMCZAP	F-10
Available to user	F-1	COMCZTB	F-10
CIO	3-4	COMSPFM	5-1,10
COMCARG	F-8	CPU	1-9
COMCARM	F-8	Data transfer macros	3-58
COMCCDD	F-8	Defined	C-2
COMCCFD	F-8	Format	1-10
COMCCHD	F-8	LFM	4-1
COMCCIO	F-8,10	PFM	5-1
COMCCMD	F-7	Relocatable	F-10
COMCCOD	F-8	Usage	1-9
COMCCPA	F-8	Compare/move unit	C-2
COMCCPM	F-8,10	COMPASS	C-2
COMCCPT	F-8	Compressed compile file format	G-10
COMCCVI	F-8	Concatenation symbol	A-4
COMCCVL	F-8	Control	
COMCDCM	F-8	Program execution	12-19
COMCDCP	F-8	Words	5-2
COMCDXB	F-8	Control byte	12-7; C-2
COMCECM	D-1; F-9	Auto input	12-7
COMCECS	D-1; F-9,11	End-of-block	12-7
COMCEDT	F-9	End-of-line	12-7
COMCFCE	F-9	End-of-string	12-11
COMCGTO	F-9	Executive auto input	12-14
COMCHXB	F-9	Initiate ASCII input	12-8
COMCLFM	F-9,11	Initiate ASCII output	12-11
COMCLOD	F-9	Initiate transparent input	12-8
COMCMAC	F-5	Initiate transparent output	12-9
COMCMTM	F-9	Internal end-of-block	12-11
COMCMTP	F-9	Log off user	12-8
COMCMVE	F-9,11	Terminal redefinition	
COMCOVL	F-9,11	NAM/CCP	12-14
COMCPFM	F-9,11	NAM/CDCNET	12-10
COMCPOP	F-9	CONTROL macro	10-2

Control point C-3
Control point manager (CPM) 6-1
Conversion mode C-3
Conversion, of programs 12-4.1
CPCOM F-1
CPM
 Call format 6-1
 Common decks 6-1
CPM= entry point F-10
CPU common decks F-1
CSET macro 11-31
CSMR symbol 1-9; E-3
CSTATUS macro 6-42
CTEXT pseudoinstruction 1-12
CYBER loader C-3
CYBER record manager
 Defined C-3
 I/O 3-62

Data

 Format J-1
 Space 2-3
 Transfer macros 3-54
DATE macro 9-2
Dayfile C-3
DAYFILE macro 11-1
DCB= entry point F-11
Default
 Defined C-3
 File assignments 12-4.1
 Service classes E-9
DEFINE macro 5-32
Device type C-3; E-10
Diagnostic messages B-1
Direct access files C-3
Display code C-3
Display mode 11-29
Dispose processor (DSP) 7-1
Disposition code C-3
DISTIC macro 11-29
DOCUMENT command I-1
DOJS symbol E-7
DSP call format 7-1
DTCS symbol E-6
Dump
 Central memory 11-19
 Extended memory 11-16
 Requests 11-16

ECSTEXT 1-6; D-1
EDATE macro 9-3
EFFECT macro 11-35
EJT
 Connection status codes E-6

 Job status codes E-6
 Scheduling data field E-7
Empty PRU/record C-3
ENCSEF macro 4-10
End-of-file C-3
End-of-information C-4
End-of-line C-4
End-of-record C-4
End-of-reel J-6
End-of-tape C-4
End-of-tape processing J-6
ENDRUN macro 11-5
Entry point C-4
EOF1 label 3-21,22
EOV1 label 3-22,23
EOV2 label 3-23
Equipment access levels C-4
Equipment code C-4
Equipment status table C-4
EREXIT macro 6-5
ERJS symbol E-7
Error
 Codes
 CIO 3-2
 LFM 4-2
 PFM 5-4
 RPV 10-14
 Flag E-11
 Messages B-1
 Special E-12
Error processing 7-10
EST ordinal C-4
ETIME macro 9-4
EVICT macro 3-51
Evicting a file 3-51
Exchange jump instruction 1-1,5; C-4
Exchange package C-5; E-4,5
EXCST macro 10-5
Exit mode C-5
EXJS symbol E-6
Extended
 Core storage C-5
 Label processing 3-17,47; C-5
 Large central memory C-8
 Memory
 Defined C-5
 Transfers D-1
 Semiconductor memory C-5
Extended reprieve processing M-1
External reference C-5

F format tape J-5
Family device C-5
Fast dynamic loader C-5
FET
 Creation macros 2-14

Description	2-4	REELNR	3-13
Formats		RESET	10-8
CIO requests	3-2	RESUME	10-8
LFM requests	4-1	RETURN	3-20,23
PFM requests	5-1	REWIND	3-20
Standard	2-4	SETUP	10-8
Label macro	4-11	UNLOAD	3-20,23
Modification macro	2-17	WRITE	3-13
Pointers	12-5	WRITENR	3-13
Field length	C-5	FWPR symbol	1-9; E-3
Field length extended	C-5		
File			
Access category	C-6	Generation	C-7
Access level	C-6	GET macro	5-19
Backspacing	3-42,43,54	GETACT macro	6-25
Defined	C-5	GETASL macro	6-11
Environment table	C-6	GETCN macro	6-41
Flushing	C-6	GETEM macro	6-11
Name table	C-6	GETFLC macro	6-19
Name table word	C-6	GETFNT macro	4-18
Overwriting	3-40	GETGLS macro	6-23
Positioning functions	3-42	GETJA macro	6-17
Purging	5-20	GETJAL macro	6-35
Random	C-11	GETJCI macro	6-29
Random access	3-7	GETJCR macro	6-15
Reading	3-8.1	GETJN macro	6-10
Returning	3-45	GETJO macro	6-17
Rewinding	3-43	GETJOSC macro	6-33
Routing	7-1	GETJSL macro	6-12
Saving	5-15	GETLC macro	6-23
Sequential access	3-7	GETLIDA macro	11-5
Set	C-6	GETLOF macro	6-28
Skipping	3-52	GETLVL macro	6-40
Space, releasing	3-45,51	GETMC macro	11-7
Status table word	C-6	GETPAGE macro	6-39
Types	E-8	GETPPF macro	6-27
Utility table word	C-7	GETPR macro	6-10
Writing	3-8.1	GETRI macro	6-40
File environment table	2-1	GETSS macro	6-21
FILEB macro	2-14	GETSSID macro	6-32
FILEC macro	2-14	GETSSM macro	11-8
FILINFO macro	4-26	GETTL macro	6-12
FIRST address	2-2	GETUSC macro	6-36
Flag	C-7	Global library set	C-7
Foreign format tape	J-5		
Foreign tape	C-7	Half track	C-7
Format, magnetic tape	J-1	HDR1 label	3-16,46
Frame	C-7	HDR1 label format	J-7
Full track	C-7	HTIME macro	9-5
Function Processors	1-1; C-7		
Functions		I format tape	J-2
ALTER	3-13	IN address	2-2
ALTERNR	3-13	Indirect access files	C-7
IRESUME	10-8		
NR	3-13,20		
READ	3-13		
READNR	3-13		
REEL	3-13		

Input file type	C-7	Logical identifier	C-9
Interactive		Logical record	C-9
Programs	12-4.1; C-7	Long block stranger format tape	J-5
Terminal requests	11-29	LWPR symbol	1-9; E-2
Internal format tape	J-2		
Interrecord gap	C-7		
Interrupt	C-8		
IOJS symbol	E-7		
		MACHID macro	6-25
		Macro	C-9
		ABORT	11-1
		APPEND	5-30
		ASSIGN	4-9
		ATTACH	5-36
		BKSP	3-42
		BKSPRU	3-43
		CATLIST	5-21
		CHANGE	5-38
		CHECKPT	10-5
		CLOCK	9-2
		CLOSE	3-20
		CLOSER	3-23
		CONTROL	10-2
		CSET	11-31
		CSTATUS	6-42
		DATE	9-2
		DAYFILE	11-1
		DEFINE	5-32
		DISTC	11-29
		EDATE	9-3
		EFFECT	11-35
		ENCSF	4-10
		ENDRUN	11-5
		EREXIT	6-5
		ETIME	9-4
		EVICT	3-51
		EXCST	10-5
		FILEB	2-14
		FILEC	2-14
		FILINFO	4-26
		GET	5-19
		GETACT	6-25
		GETASL	6-11
		GETCN	6-41
		GETEM	6-11
		GETFLC	6-19
		GETFNT	4-18
		GETGLS	6-23
		GETJA	6-17
		GETJAL	6-35
		GETJCI	6-29
		GETJCR	6-15
		GETJN	6-10
		GETJO	6-17
		GETJOSC	6-33
		GETJSL	6-12
		GETLTC	6-23
		GETLIDA	11-5
		GETLOF	6-28
JDATE macro	9-5		
Job			
Access category set	C-8		
Access level	C-8		
Access level limits	C-8		
Communication area	E-1		
Control	10-1		
Step	C-8		
JOPR symbol	1-9; E-3		
L format tape	J-5		
Label	C-8		
Label buffer	3-17,47		
LABEL macro	4-11		
Label processing			
Extended	3-17,47		
Standard	3-15,46		
Large central memory extended	C-8		
LCB= entry point	F-11		
LDRR symbol	1-9; E-3		
Level designator	C-8		
Level number	C-8		
LFM			
Call format	4-1		
Common decks	4-1		
Error codes	4-2		
Request	4-1		
LFM= entry point	F-11		
Library	C-8		
Library file	C-8		
LIMIT address	2-2		
Line	C-8		
LINP symbol	1-9		
List of files	C-9		
LIST pseudoinstruction	1-12		
Load point	C-9		
LOADD macro	11-24		
Loader requests	11-20		
LOADQ macro	11-26		
Local file	C-9		
Local file manager (LFM)	4-1		
Local file name	C-9		
Local file name table	C-9		
LOCK macro	4-4		
Locked file	4-4; C-9		

GETLVL	6-40	RETURN	3-45
GETMC	11-7	REWIND	3-43
GETPAGE	6-39	REWRITE	3-38
GETPPF	6-27	REWRITEF	3-39
GETPR	6-10	REWRITER	3-39
GETRI	6-40	RFILEB	2-14
GETSS	6-21	RFILEC	2-15
GETSSID	6-32	ROLLOUT	6-7
GETSSM	11-8	ROUTE	7-8
GETTL	6-12	RPHR	3-25
GETUSC	6-36	RPHRLS	3-30
HTIME	9-5	RPVBLK	10-10
JDATE	9-5	RTIME	9-6
LABEL	4-11	SAVE	5-15
LOADD	11-24	SETASL	6-3
LOADQ	11-26	SETFAL	4-3
LOCK	4-4	SETFET	2-17
MACHID	6-25	SETFS	4-3
MEMORY	11-9	SETGLS	6-24
MESSAGE	11-10	SETJAL	6-35
MODE	6-2	SETJCI	6-30
MOVE	11-12	SETJCR	6-16
NORERUN	11-20	SETJOB	6-31
OFFSW	6-9	SETJSL	6-4
OLD	5-42	SETLC	6-13
ONSW	6-9	SETLOF	6-28
OPEN	3-13	SETMFL	6-27
OVERLAY	11-21	SETPAGE	6-39
OVWRITE	3-40	SETPFAC	5-43
PACKNAM (035)	6-20	SETPFAL	5-44
PACKNAM (036)	6-21	SETPR	6-1
PDATE	9-6	SETRFL	6-14
PERMIT	5-27	SETSC	6-38
POSMF	3-46	SETSML	11-32
PRIMARY	4-26	SETSS	6-16
PROMPT	11-31	SETSSM	6-8
PROTECT	6-31	SETTL	6-4
PSCSF	4-10	SHELL	6-33
PURGE	5-20	SKIPB	3-53
READ	3-25	SKIPEI	3-53
READC	3-58	SKIPF	3-52
READCW	3-27	SKIPFB	3-54
READEI	3-33	SKIPFF	3-52
READH	3-59	STATUS (012)	4-4
READLS	3-29	STATUS (013)	4-5
READN	3-32	STIME	9-7
READNS	3-31	SUBR	11-13
READO	3-60	SYSCOM	1-8
READS	3-60	SYSTEM	11-14
READSKP	3-26	TIME	9-7
READW	3-61	TSTATUS	11-33
RECALL	11-13	UNLOAD	3-44
RENAME	4-2	UNLOCK	4-4
REPLACE	5-29	USECPU	6-18
REPRIEVE	10-15	USERNUM	6-18
REQUEST (014)	4-6	VERSION	6-22
REQUEST (015)	4-7	WAIT	11-15
RERUN	11-20	WPHR	3-34

WRITE 3-34
 WRITEC 3-59
 WRITECW 3-36
 WRITEF 3-35
 WRITEH 3-59
 WRITEN 3-41
 WRITEO 3-60
 WRITER 3-35
 WRITES 3-61
 WRITEW 3-61
 Macro Usage 1-7
 Magnetic tape files
 ANSI standard labeled 3-15
 Evicting 3-51
 Formats J-1
 Labeling 3-15
 Multifile set 3-46
 Nonstandard labeled 3-15
 Returning 3-45
 Rewinding 3-43
 Standard FET 2-5
 Unlabeled 3-15
 Unloading 3-44
 Mass storage files
 Assignment 4-6,7
 Closing 3-20
 Evicting 3-51
 Overwriting 3-40
 Returning 3-45
 Rewinding 3-43
 Standard FET 2-4
 Unloading 3-44
 Mass storage operations 3-14
 Memory allocation for overlay loaders 11-28
 MEMORY macro 11-9
 MESSAGE macro 11-10
 Messages B-1
 MLRS C-9
 MODE macro 6-2
 MOVE macro 11-12
 MSG= entry point F-11
 Multifile
 File C-9
 Set 3-46; C-9
 Tape, positioning 3-46
 MVE= entry point F-11

 Network C-9
 Network terminal C-9
 NICS symbol E-6
 Nonallocatable device C-9
 Nonstandard tape label C-9
 NORERUN macro 11-20
 NOS Systems Texts
 ECSTEXT 1-6
 NOSTEXT 1-6

 PPTXT 1-6
 PSSTEXT 1-6
 SYSTEXT 1-6
 NOSTEXT 1-6
 NOSVER micro 1-6
 NPC= entry point 12-2
 NR function 3-13,20,23
 NVJS symbol E-7

 OFFSW macro 6-9
 OLCG symbol E-6
 OLD macro 5-42
 Old program library C-9
 ONSW macro 6-9
 Opdef C-10
 OPEN macro 3-13
 Opening a file 3-13
 Origin types E-8
 OUT address 2-2
 Overlay C-10
 Overlay loaders 11-28
 OVERLAY macro 11-21
 Overwriting file space 3-40
 OVL= entry point F-11
 OVWRITE macro 3-40

 Pack name C-10
 PACKNAM (035) macro 6-20
 PACKNAM (036) macro 6-21
 Parameter C-10
 Parameter processing 12-1
 Parity C-10
 Password C-10
 PDATE macro 9-6
 Peripheral processor C-10
 Permanent file
 Catalog C-10
 Defined C-10
 Family C-10
 Permanent file manager (PFM) 5-1
 PERMIT macro 5-27
 PFM
 Call format 5-1
 Common decks 5-1
 Error codes 5-4
 Parameters 5-10
 Request 5-1
 PFM= entry point F-11
 PGNR symbol 1-9; E-2
 Physical record C-10
 Physical record unit C-10
 Positioning a file 3-42
 POSMF macro 3-46
 PPTXT 1-6

Preserved file C-10
 Primary file C-11
 PRIMARY macro 4-26
 Print file C-11
 Print trains A-4
 Private auxiliary device C-11
 PRJS symbol E-6
 Program
 Control of execution 12-19
 Control of terminal activity 12-6
 Conversion 12-4.1
 Documentation I-1
 Library C-11
 Library directory format G-5
 Special handling 12-5
 Standards I-1
 PROMPT macro 11-31
 PROTECT macro 6-31
 PRU device C-11
 PSCSF macro 4-10
 Pseudoinstruction C-11
 PSSTEXT 1-6
 Public auxiliary device C-11
 Punch file C-11
 PURGE macro 5-20
 Purging files 5-20
 PWJS symbol E-7

QAC
 ALTER request 8-11
 Call format 8-1
 Error codes 8-2
 GET request 8-14
 Parameter block 8-1
 PEEK reply block 8-18
 PEEK request 8-16
 Request 8-1,10
 QUAL pseudoinstruction 1-13
 Qualified symbol C-11
 Queue file manager (QFM) 11-19
 Queue access interface (QAC) 8-1
 Queued file table C-11

RA.CEJ symbol 1-9
 RA.CMU symbol 1-9
 RA.MTR symbol 1-8
 Random
 Access 3-7; C-11
 Address C-11
 File C-11
 File, sample H-1
 I/O, examples H-1
 Request 3-10
 RA+1 requests, issuing 1-5

RCL= entry point F-11
 RDC= entry point F-11
 RDH= entry point F-11
 RDO= entry point F-11
 RDS= entry point F-11
 RDW= entry point F-11
 RDX= entry point F-11
 READ function 3-13
 Read functions 3-24
 READ macro 3-25
 Read/write extended memory D-1
 READC macro 3-58
 READCW macro 3-27
 READEI macro 3-33
 READH macro 3-59
 READLS macro 3-29
 READN macro 3-32
 READNR function 3-13
 READNS macro 3-31
 READO macro 3-60
 READS macro 3-60
 READSKP macro 3-26
 READW macro 3-61
 REC= entry point F-11
 Recall C-11
 RECALL macro 11-13
 Record
 Defined C-12
 Separator C-12
 Skipping 3-52
 Reel C-12
 REEL function 3-13
 REELNR function 3-13
 Reference address C-12
 Register C-12
 Relative address C-12
 Relocatable assembly C-12
 Removable device C-12
 RENAME macro 4-2
 Renaming a file 4-2
 REPLACE macro 5-29
 REPRIEVE macro 10-15
 Reprieve processing 10-8; 12-21
 Request, system 1-2
 REQUEST (014) macro 4-6
 REQUEST (015) macro 4-7
 RERUN macro 11-20
 RETURN function 3-20,23
 RETURN macro 3-45
 Returning a tape file 3-45
 REWIND function 3-20
 REWIND macro 3-43
 Rewinding a file 3-43
 REWRITE macro 3-38
 REWRITEF macro 3-39
 REWRITER macro 3-39
 RFILEB macro 2-14
 RFILEC macro 2-15

ROJS symbol E-6
 Rollout C-12
 Rollout file C-12
 ROLLOUT macro 6-7
 Rotating mass storage C-12
 ROUTE macro 7-8
 RPHR macro 3-25
 RPHRLS macro 3-30
 RPVBLK macro 10-10
 RTIME macro 9-6

 S format tape J-3
 SAVE macro 5-15
 Sector C-12
 Secured system C-12
 CIO processing 3-12
 Security administrator C-13
 Security count C-13
 Security unlock status C-13
 Sense switches C-13
 Sequential access C-13
 Sequential file C-13
 Service class, default E-9
 Service class types E-9
 Set, magnetic tape 3-46
 SETASL macro 6-3
 SETFAL macro 4-3
 SETFET macro 2-17
 SETFET parameter processing 2-19
 SETFS macro 4-3
 SETGLS macro 6-24
 SETJAL macro 6-35
 SETJCI macro 6-30
 SETJCR macro 6-16
 SETJOB macro 6-31
 SETJSL macro 6-4
 SETLC macro 6-13
 SETLOF macro 6-28
 SETMFL macro 6-27
 SETPAGE macro 6-39
 SETPFAC macro 5-43
 SETPFAL macro 5-44
 SETPR macro 6-1
 SETRFL macro 6-14
 SETSC macro 6-38
 SETSLM macro 11-32
 SETSS macro 6-16
 SETSSM macro 6-8
 SETTL macro 6-4
 SHELL macro 6-33
 Shell processing L-1
 Short PRU C-13
 SI format tape J-4
 SIJS symbol E-6
 SKIPB macro 3-53
 SKIPEI macro 3-53

SKIPF macro 3-52
 SKIPFB macro 3-54
 SKIPFF macro 3-52
 SOJS symbol E-6
 Special
 Entry points 12-3; C-13
 ARG= 12-4
 MFL= 12-4
 NPC= 12-4
 RFL= 12-4
 SDM= 12-4
 User information E-1
 SPPR symbol 1-8
 Standard labeled tape C-13
 STATUS (012) macro 4-4
 STATUS (013) macro 4-5
 STIME macro 9-7
 Stranger format tape J-3
 Stranger tape C-13
 SUBR macro 11-13
 SUJS symbol E-7
 SWJS symbol E-7
 Symbol C-13
 SYS= entry point F-11
 SYSCOM macro 1-8
 SYSLIB F-10
 System
 Access
 Category set C-13
 Levels C-13
 Communication symbols 1-8
 File C-14
 File name table C-14
 Labeled tape C-14
 Library C-14
 Request 1-1; 9-1; C-14
 Processing 1-3
 Resource unit C-14
 Text 1-6; C-14
 System internal format tape J-4
 SYSTEM macro 11-14
 SYSTEXT 1-6

 Tape
 Format C-14
 Mark C-14
 Standard labeled C-14
 Stranger C-14
 Temporary file C-14
 Terminal
 Attributes
 Mapping 12-18.1
 NAM/CCP 12-15,16,17,18
 NAM/CDCNET 12-12,13
 Control keys 12-19
 Redefinition

NAM/CCP 12-14
NAM/CDCNET 12-10
Terminal files
 Standard FET 2-4
TIME macro 9-7
Time slice C-14
Timed/event rollout C-14
TOJS symbol E-7
Translate control statement (TCS) 10-1
TSTATUS macro 11-33

UHL label 3-18
Unified extended memory C-14
Unlabeled tape C-14
UNLOAD function 3-20,23
UNLOAD macro 3-44
UNLOCK macro 4-4
Unprintable characters A-4
Unsecured system C-15
USECPU macro 6-18
User
 Header label 3-18
 Index C-15
 Library group format G-7
 Trailer label 3-22
 Volume label 3-18
User breaks 12-21
USERNUM macro 6-18
UVL label 3-18

Validation file C-15
VERSION macro 6-22
Volume C-15
Volume serial number C-15
VOL1 label 3-18

WAIT macro 11-15
WEC= entry point F-11

WNB= entry point F-11
Word C-15
WPHR macro 3-34
WRITE function 3-13
Write lockout bit 4-4
WRITE macro 3-34
Write ring C-15
WRITEC macro 3-59
WRITECW macro 3-36
WRITEF macro 3-35
WRITEH macro 3-59
WRITEN macro 3-41
WRITENR function 3-13
WRITEO macro 3-60
WRITER macro 3-35
WRITES macro 3-61
WRITEW macro 3-61
Writing programs
 Interactive 12-4.1
 NOS 12-1
WTC= entry point F-11
WTH= entry point F-11
WTO= entry point F-11
WTS= entry point F-11
WTW= entry point F-11
WTX= entry point F-11

XJ instruction 1-2,5
XJPR symbol 1-9; E-3
XTEXT pseudoinstruction 1-11

Zero-byte terminator C-15
Zero-length PRU C-15
ZZDUMP file 11-16
ZZZDDB file 11-17

63-character set A-1
64-character set A-1
95-character set A-1

Comments (continued from other side)

Please fold on dotted line;
seal edges with tape only.

FOL

FOLD

FOLI

BUSINESS REPLY MAIL
First-Class Mail Permit No. 8241 Minneapolis, MN
POSTAGE WILL BE PAID BY ADDRESSEE

CONTROL DATA
Technical Publications
ARH219
4201 N. Lexington Avenue
Arden Hills, MN 55126-9983

NO POSTAGE
NECESSARY
IF MAILED
IN THE
UNITED STATES



COMMENT SHEET

MANUAL TITLE: CDC NOS Version 2 Reference Set, Volume 4
Program Interface

PUBLICATION NO.: 60459690

REVISION: J

NAME: _____

COMPANY: _____

STREET ADDRESS: _____

CITY: _____ STATE: _____ ZIP CODE: _____

This form is not intended to be used as an order blank. Control Data Corporation welcomes your evaluation of this manual. Please indicate any errors, suggested additions or deletions, or general comments below (please include page number references).

Please Reply No Reply Necessary

NO POSTAGE STAMP NECESSARY IF MAILED IN U.S.A.

FOLD ON DOTTED LINES AND TAPE

1950

MANUAL OF THE
SOCIETY OF AMERICAN
SOCIETY OF AMERICAN
SOCIETY OF AMERICAN

THE
SOCIETY OF AMERICAN
SOCIETY OF AMERICAN
SOCIETY OF AMERICAN

THE
SOCIETY OF AMERICAN
SOCIETY OF AMERICAN
SOCIETY OF AMERICAN

THE
SOCIETY OF AMERICAN
SOCIETY OF AMERICAN
SOCIETY OF AMERICAN

