

When you're facing the Grand Challenges of science and engineering, nothing else comes close.

## The CRAY Y-MP C90 Supercomputer System



**CRAY**  
RESEARCH, INC.

## Taking on the Grand Challenges

*The U.S. Government Office of Science and Technology Policy describes a wide range of science and engineering Grand Challenges that require an unprecedented amount of computational power and capability to investigate and understand. Solving these fundamental problems is critical to sustaining and extending leadership in science and technology. Examples of Grand Challenges include:*

- Prediction of weather and global climate change*
- Determination of molecular, atomic, and nuclear structures*
- Understanding turbulence, groundwater, pollution, dispersion, and combustion systems*
- Mapping the human genome*
- Understanding the nature of new materials*
- Problems related to national security*

*Until now, the Grand Challenges could not be solved with available computational tools. As scientists and engineers begin to explore these formidable problems; the computational power of the new CRAY Y-MP C90 supercomputer coupled with Cray Research software will provide exciting new solution opportunities.*

# Introducing the CRAY Y-MP C90 Supercomputer System

In 1822, an Englishman named Charles Babbage invented the Difference Engine, the forerunner to modern computers. As the technical wonder of its age, it revolutionized the way people thought about problem solving. Now, Cray Research starts a new revolution in science and engineering with the CRAY Y-MP C90 supercomputer — a new Difference Engine for the Grand Challenges of today.

The CRAY Y-MP C90 supercomputer is a bold new engineering achievement that offers unmatched problem-solving capabilities. As the most powerful supercomputer ever offered by Cray Research, the CRAY Y-MP C90 uses many innovative technologies to deliver easy access to the highest levels of performance and reliability.

At Cray Research, we offer more than just the fastest hardware and most comprehensive software — we offer a Network Supercomputing solution that allows you to rise to the challenges of your work. As a complete system, Cray Research hardware, software, applications, and networks provide the insight you need to approach today's problems with revolutionary solutions.

## Redefining high-performance computing

As the most powerful supercomputer available for production applications, the CRAY Y-MP C90 supercomputer is a major milestone of technology leadership. It sets new standards for high performance computing with six times the peak computing power of the original CRAY Y-MP 8 system, while maintaining upward binary compatibility.

The CRAY Y-MP C90 system features an all-new central processor that provides a peak performance of 1 billion floating-point operations per second (1 GFLOPS). To achieve this performance, each CPU delivers two vector results per functional unit every clock period with a dual vector pipeline. Using 16 of these powerful processors

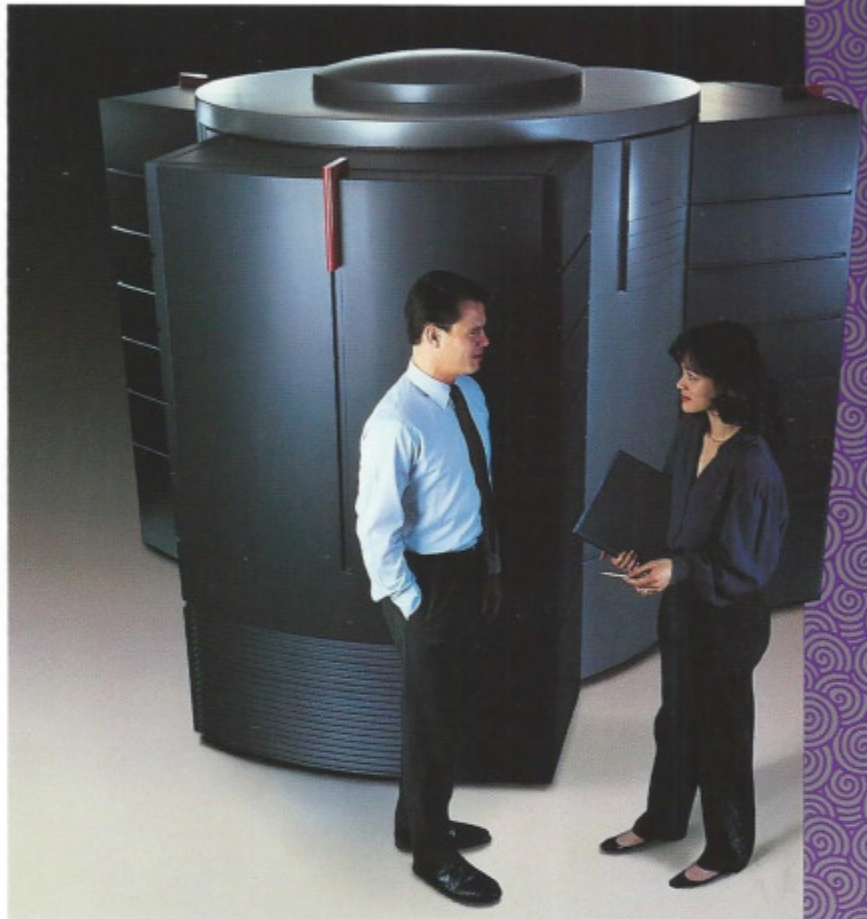

and 256 million words (2 billion bytes) of central memory, the CRAY Y-MP C90 system enables a higher level of productivity for scientists and engineers with a peak performance of 16 GFLOPS.

## CRAY Y-MP C90 system configuration

Model	CPUs	Central memory	I/O clusters	Optional SSD
CRAY Y-MP C90/16256	16	256 Mwords (2 Gbytes)	2 - 16	512, 1024, or 2048 Mwords (4, 8, or 16 Gbytes)

### CRAY Y-MP C90 highlights

- Full upward compatibility with entire CRAY Y-MP product line
- Sixteen processors
- 16 GFLOPS peak performance
- 10,000-gate Very Large Scale Integration (VLSI) gate-array circuits
- Dual vector pipelines in each CPU
- Flexible hardware chaining for vector operations
- Gather/scatter and compressed index vector support
- Flexible processor clustering for multitasking applications
- Four parallel memory ports per processor
- Liquid cooling system
- Dedicated registers for efficient interprocessor communication and control
- 256 Mwords (2 Gbytes) central memory
- Single-byte correction, double-byte detection memory protection
- Memory bandwidth of 250 Gbytes/sec
- Optional SSD with 512, 1024, or 2048 Mwords (4, 8, or 16 Gbytes)

### New technologies maximize system availability

To deliver unmatched performance and reliability, the CRAY Y-MP C90 system uses the following new technologies:

- Custom high-speed 10,000 gate-array circuits increase reliability and reduce manufacturing costs with four times the level of integration of previous devices.
- Surface-mount component assembly reduces manufacturing and reliability problems associated with chip leads.
- Multi-layer circuit boards with internal pathways prevent contaminants from corrupting signal integrity.

Peak performance alone does not ensure computational efficiency; to sustain high levels of performance, a supercomputer requires a balanced system of hardware and software where all parts are matched to provide the most useful power to the user. The balanced architecture of the CRAY Y-MP C90 system includes the following elements to ensure maximum performance:

- More parallelism than any other vector supercomputer available today.* The 16-processor CRAY Y-MP C90 features 64-way vector parallelism with two vector pipes and two functional units per CPU. Combined with its mature, production-tested multitasking software, the CRAY Y-MP C90 system makes it easy to apply the power of 64-way vector parallelism to today's most widely used science and engineering codes.
- Unprecedented memory bandwidth.* The CRAY Y-MP C90 delivers more sustained compute power to the user with four parallel memory ports per CPU and 250 Gbytes/sec of memory bandwidth.
- Unmatched I/O bandwidth.* To run efficiently, a high-speed supercomputer requires equally expansive input/output capabilities. With an aggregate I/O bandwidth of 13.6 Gbytes/sec, the CRAY Y-MP C90 system offers the most powerful and versatile I/O capabilities in the industry.
- Optional SSD Solid-state Storage Device for increased throughput.* An optional SSD Solid-state Storage Device provides very-high-speed secondary memory with up to 2 Gwords (16 Gbytes) of storage capacity. With an aggregate bandwidth of 13.6 Gbytes/sec, the SSD allows you to solve large problems in less time.

### Bridging the gap between potential and productivity

In addition to solving problems much larger than previously possible, the CRAY Y-MP C90 system can solve a greater number of problems as well. But increased productivity doesn't stop there. All Cray Research systems feature a powerful software application support environment that eliminates obstacles between you and the problems you need to solve. The application support environment offers the following advantages unique to Cray Research systems:

- Maximized throughput increases user productivity.* The CRAY Y-MP C90 delivers the maximum amount

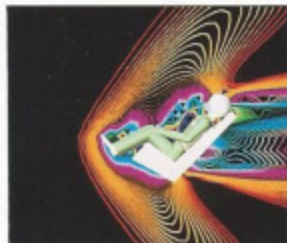

Far left, isosurfaces (yellow) representing the shock region of flow over an F-14 travelling at Mach 1.5. The exhaust represents the contours of the Mach number, computed using NEWTUN.

Left, supersonic flow over a pilot (ejected). The color contours represent the Mach number, computed using NEWTUN.

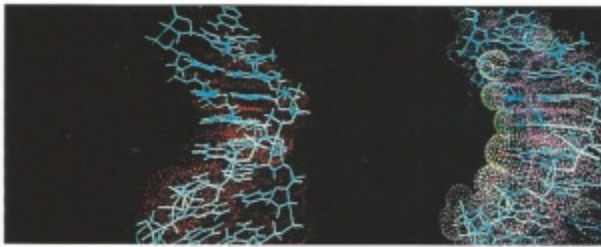

**Methylation of DNA.** The image shows methylated DNA (left) and normal DNA. Abnormal patterns of methylated DNA have been shown to occur in nearly all forms of human cancer. Computed using AMBER on CRAY Y-MP system and displayed with MIDAS on Silicon Graphics workstation.

of useful power to the user with UNICOS, the most robust and production-capable UNIX-based operating system available.

- *Proven application development environment.* UNICOS allows you to develop complex applications quickly and easily with a broad range of powerful compilers, debuggers, libraries, visualization capabilities, and distributed processing tools.
- *High-speed I/O increases performance.* The I/O capabilities of the CRAY Y-MP C90 system are enhanced further with powerful I/O software that provides exceptional throughput automatically. This software also provides simple-to-use options for reducing I/O transfers and attaining peak disk and tape transfer rates.
- *Network supercomputing delivers real supercomputing power to your desktop.* Because Cray Research supercomputers support industry standards as well as a variety of language extensions, network protocols, and utilities from other vendors, they can be integrated easily into heterogeneous computing environments.
- *A proven set of powerful applications.* Cray Research offers leading-edge, optimized applications for nearly every scientific and engineering discipline, including the most widely used third-party application programs.

### Protecting your high-end supercomputing investments

To protect your high-end supercomputing investments, the CRAY Y-MP C90 offers full upward binary compatibility with the entire CRAY Y-MP family of supercomputers. Applications developed on any CRAY Y-MP system can be run on the CRAY Y-MP C90 system.

The proven technologies of the CRAY Y-MP family of supercomputers offer the widest range of computational capabilities available. From air-cooled CRAY Y-MP EL systems to full-scale capability supercomputers like the CRAY Y-MP 8 and CRAY Y-MP C90 systems, the CRAY Y-MP family features binary-compatible performance spanning more than two orders of magnitude.

The CRAY Y-MP C90 provides an easy upgrade path from other CRAY Y-MP systems. Customers wishing to upgrade from their existing CRAY Y-MP 8E system can do so by simply swapping mainframe cabinets. The CRAY Y-MP C90 system can use existing IOS, SSD, and

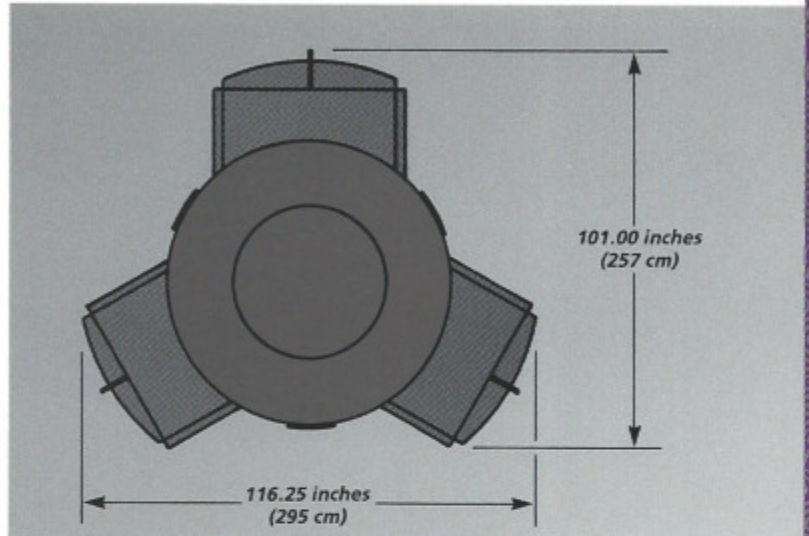

support equipment, easing system installation and providing significant cost savings.

### The best overall supercomputing solutions

To enhance productivity, all CRAY Y-MP systems can process a varied workload mix and still maintain optimal performance. While some architectures offer fast solutions for only certain types of problems, the balanced CRAY Y-MP architecture offers the highest possible performance on scalar, short vector, long vector, parallel, and highly parallel problems. Because the real problems making up a production workload consist of a varied mix of codes, the CRAY Y-MP C90 system offers the best overall performance solution.

### Physical description

The CRAY Y-MP C90 system is comprised of a mainframe cabinet and IOS cabinet. The mainframe cabinet contains the CPUs, central memory, and power supplies. The IOS cabinet contains the I/O Subsystem and optional SSD. The mainframe cabinet measures 116.25 inches wide by 101 inches deep by 85.5 inches high (2.95 m x 2.57 m x 2.17 m). The IOS cabinet measures 46 inches wide by 75.5 inches deep by 76.25 inches high (1.17 m x 1.92 m x 1.94 m).

## Advanced I/O technology

### Input/output highlights

- High performance I/O software
- Up to 16 I/O clusters
- Up to 16 channel adapters per cluster for a total of 256 channels
- Aggregate I/O bandwidth of 13.6 Gbytes/sec
- Support for high-performance disk drives
- Support for high-performance online tapes
- Support for industry-standard and proprietary networks
- Support for the ANSI standard HIPPI channel

### SSD highlights

- Improves system throughput and individual program performance
- Up to 2 Gwords (16 Gbytes) capacity
- Reliable VLSI technology
- Up to four 1800-Mbyte/sec channels to mainframe
- Aggregate SSD bandwidth of up to 13.6 Gbytes/sec
- SECCDED memory protection
- 200-Mbyte/sec channels to the IOS

### The most powerful I/O technology available

The IOS allows the central memory of the CRAY Y-MP C90 system to communicate at high speeds with networks and peripherals such as disk and tape drives.

To provide industry-leading performance, versatility, and reliability, the CRAY Y-MP C90 system uses the Model E I/O Subsystem (IOS) recently introduced with the CRAY Y-MP systems. To provide the CRAY Y-MP C90 system with massive production workload capacity, the I/O architecture delivers up to 13.6 Gbytes/sec of I/O bandwidth. This very large bandwidth allows you to connect to more peripheral devices and perform more simultaneous activities.

The IOS provides a flexible framework that can grow with your I/O and peripheral needs. The IOS is comprised of two to 16 I/O clusters (IOCs), which allow large amounts of data to be accessed with support for high-performance data transmission. Each IOC supports up to 16 channel adapters for a total of 256 channels for connection to disk storage units, tape units, and communications connections.

The standard configuration of the CRAY Y-MP C90 system includes two I/O clusters and 16 channel adapters. Additional I/O clusters and channel adapters can be configured easily at your site.

### Advanced SSD technology

The optional SSD Solid-state Storage Device is a very fast random-access device that increases system performance when used in the following ways:

- As high-speed I/O cache (ldcache)
- As secondary program memory (sds) supported by libraries and the CF77 Fortran compiling system
- As a system swap space.

The CRAY Y-MP C90 system uses the proven Model E SSD technology that allows you to improve system throughput and increase individual job performance with an aggregate bandwidth of up to 13.6 Gbytes/sec. Using VLSI chips and increased system integration, the SSD is available with up to 2 Gwords (16 Gbytes) of storage capacity.

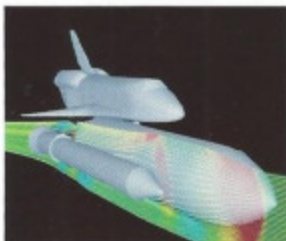

*Left, airflow around ascending space shuttle. The image was generated using Cray Research's Multipurpose Graphic System, and includes a complete shuttle, tank, and solid rocket booster.*

*Right, frontal car crash analysis model.*



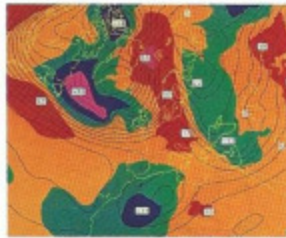
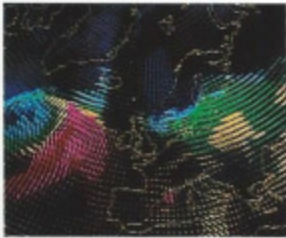

*Far left, weather forecast simulations displayed using **MAGICS**, an applications software package developed by ECMWF.*

*Left, high resolution ECMWF forecast of the thickness of the atmospheric layer between 1000 hPa and 500 hPa (solid color shading) overlaid with the height (contours) of the 500 hPa surface.*

The CRAY Y-MP C90 system communicates with the SSD through up to four 1800-Mbyte/sec channels. The SSD is connected to the IOS through 200-Mbyte/sec channels. These connections enable data to be transferred directly between an IOS and the SSD without passing through central memory, thereby increasing overall performance.

### Disk drives

Cray Research offers fast, reliable mass storage devices that provide large storage capacities in a small physical space. The CRAY Y-MP C90 system supports all current Cray Research disk storage devices including the DD-60 and DD-61 disk storage units. With the capability to support over 4 terabytes of disk storage, the CRAY Y-MP C90 gives you high-speed access to 18 times more online data than was possible with the original CRAY Y-MP Model D system.

The DD-60 disk drive offers outstanding performance and large storage capacities when matched with the I/O capability of the CRAY Y-MP C90 system and the UNICOS operating system. Each I/O cluster configured with 16 DD-60 disk drives can deliver up to 320-Mbyte/sec performance (up to 200 Mbytes/sec in each direction).

The DD-60 is a 24-Mbyte/sec disk drive with a sustained transfer rate of 20 Mbytes/sec and a capacity of 1.96 Gbytes. Disk striping provides single disk transfer rates of several times the rate of individual disk drives. Up to eight DD-60 disk drives can be connected to each disk channel adapter in the IOS.

The DD-61 disk drive delivers large storage capacities at a low cost. The DD-61 provides you with access to large amounts of data using highly reliable, 8-inch disk technology that gives the DD-61 a lower cost per Mbyte, a small footprint, and low power consumption. The DD-61 is a 3-Mbyte/sec disk drive with a sustained transfer rate of 2.6 Mbytes/sec and a capacity of 2.23 Gbytes. Up to eight DD-61 disk drives can be connected to each disk channel adapter in the integrated I/O subsystem.



*Two DE-60 disk cabinets, each containing up to eight DD-60 or DD-61 disk drives.*

## Software

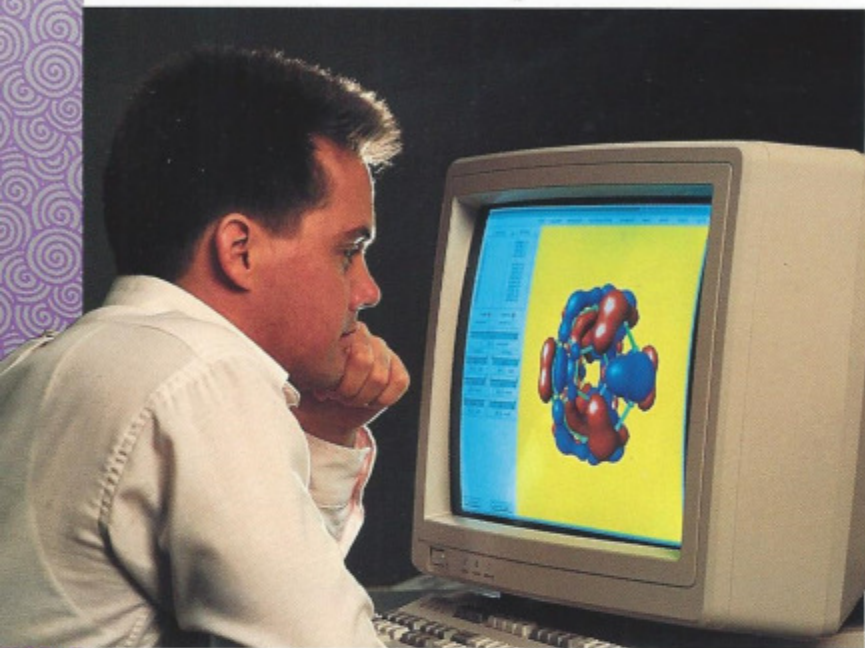

system solution, the application support environment includes UNICOS, the world's first and highest-performance UNIX-based supercomputer operating system, as well as a set of powerful compilers, development tools, high-performance libraries, and data storage systems.

### UNICOS operating system

The UNICOS operating system is the most powerful and feature-rich UNIX-based operating system available to supercomputer users. Based on the UNIX System V operating system with Berkeley extensions and numerous performance enhancements, UNICOS is an interactive and batch operating system that offers a number of advantages including high performance, full functionality, standards, and connectivity.

UNICOS is the result of hundreds of programmer years of optimizations that deliver very high performance on production workloads. Together with the powerful CRAY Y-MP C90 computer hardware and Autotasking capabilities, this performance not only provides fast turnaround on individual jobs, but also high throughput for a varied workload through sophisticated job scheduling capabilities.

### Performance-oriented, feature-rich software

The Cray Research application support environment is a complete body of performance-oriented, standards-based system software that enables users to focus on their work, not the system's requirements. As part of a total

UNICOS combines all the inherent strengths of UNIX, such as a familiar user interface, with production-oriented features including high-performance I/O, optimal memory bandwidth utilization, multiprocessing support, ANSI/IBM tape support, resource control,

### UNICOS highlights

#### Full production functionality

- Batch and interactive processing
- High-speed tape support
- Resource management
- Extensive accounting features
- Checkpoint/restart
- Networking
- Data Migration Facility (DMF)
- Online system diagnostics
- IEEE data format support
- Multi-level security

#### High performance

- Autotasking and autovectorizing features
- Efficient, asynchronous I/O
- Striped disks
- File system extensions

#### Ease of use

- Industry standard interfaces
- Compatibility across entire CRAY Y-MP product line
- Advanced program development tools
- X Window System support
- Performance analysis tools

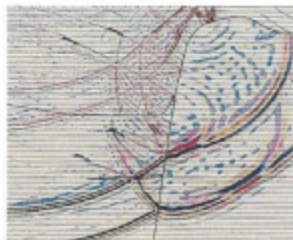

*Left, wavefield snapshots inside salt diapher. Images show how energy is reflected or refracted by subsurface geology.*

*Right, syringe rubber stopper. Image shows the component geometry.*

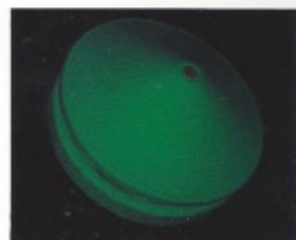



*Three-dimensional (3-D) seismic data migration. This computationally intensive process enables researchers to view geological structures for possible deposits of petroleum and natural gas. Data migrated with GEOSYS package and displayed using METAPLOT.*

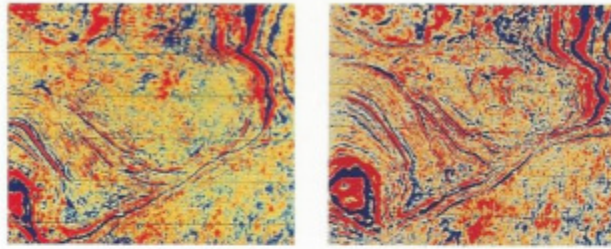

sophisticated job scheduling, tunable accounting, multi-level security, and batch processing.

To help programmers build powerful applications in less time, UNICOS includes a powerful application development toolset. Visual and line-oriented tools automatically analyze codes for programming and performance problems, offer expert advice for making improvements, and provide graphical interfaces to speed assimilation and manipulation of this information.

### Compilers

Cray Research offers the most powerful compilers in the industry, including the CF77 Fortran compiling system, the Cray Standard C Compiler, Cray Ada, and Pascal. The CF77 compiling system was the first Fortran compiler in

the industry with support for automatic parallel processing, automatic vectorization, and scalar optimization. These compiling features typically require little or no code modification by the user, and full optimization is on by default.

The CF77 5.0 compiling system ensures portability with full compliance to ANSI standard 3.9-1978. The flexibility of CF77 allows it to accept many nonstandard constructs written for compilers from other vendors.

The CF77 compiling system compiles Fortran77 programs into executable code modules that take full advantage of the CRAY Y-MP C90 vector capabilities, while its Autotasking feature further enhances performance. For those codes that are not highly vectorizable, CF77



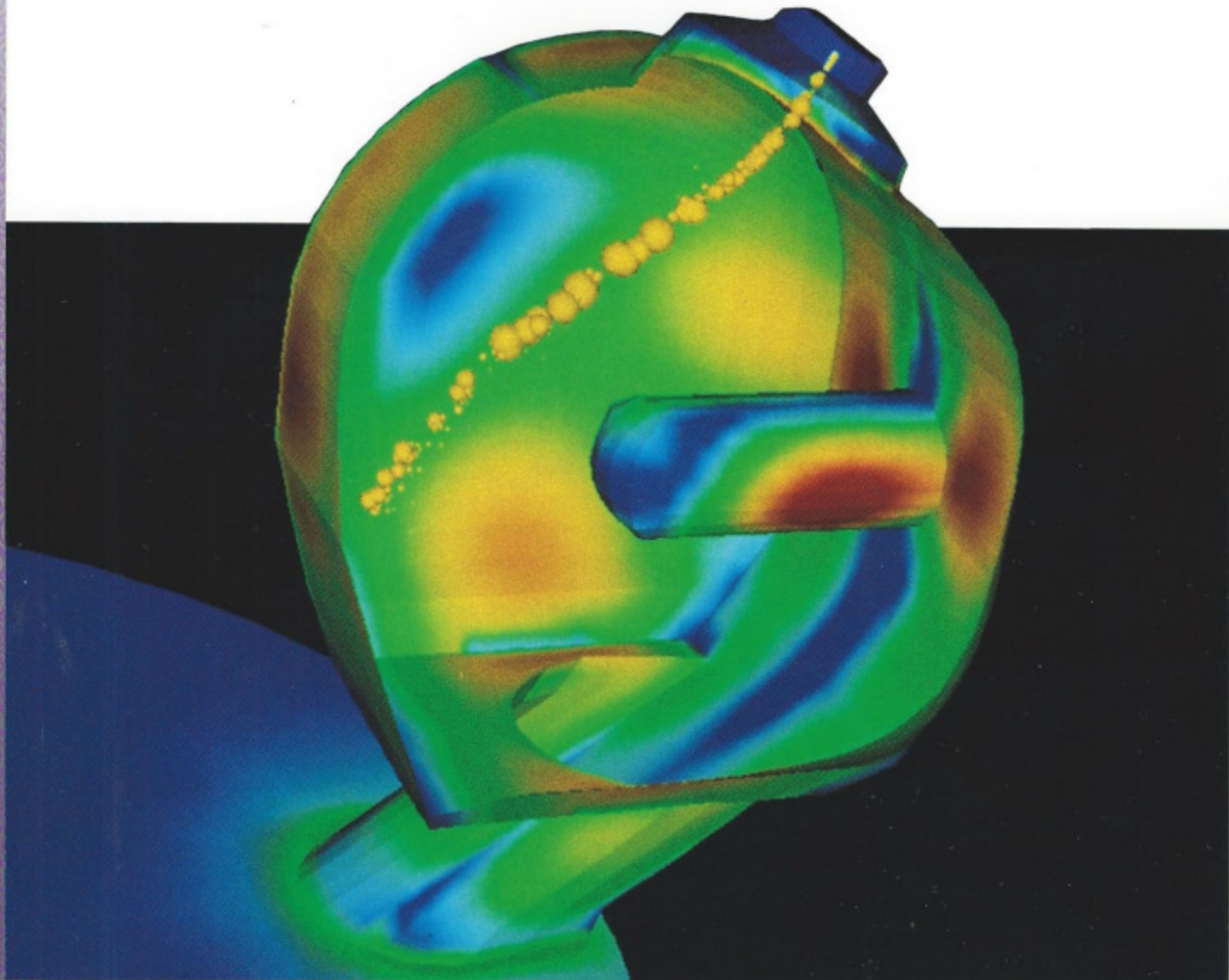

ensures the best possible execution time by providing maximized scalar optimization for the CRAY Y-MP C90 system.

Because supercomputing applications written in C language are becoming increasingly popular, Cray Research offers the highest-performance ANSI standard C compiler in the industry. The Cray Standard C compiler can be used to create portable, highly optimized code with performance comparable to Fortran programs. Like CF77, the Cray Standard C Release 3.0 compiler takes full advantage of the CRAY Y-MP C90 performance capabilities with automatic vectorization, scalar optimization, and Autotasking.

## Autotasking

The CF77 compiling system and the Cray standard C Compiler include Autotasking features that can dramatically improve performance on all CRAY Y-MP systems. The Autotasking feature divides a program into discrete tasks that can be performed concurrently on multiple processors in the CRAY Y-MP C90 system. The Autotasking features also include a convenient, powerful set of directives that allow programmers to fine-tune their code for even better performance. In production environments, this feature can be used to improve both individual job performance and overall system throughput.

*Cray Research's CRI/Turbokiva program allows scientists and engineers to model combustion phenomena with unprecedented performance, accuracy,*

*and ease of use. Above, air velocity distribution in an indirect injection diesel prechamber. Right, combustion in a four-valve gasoline engine. Far right, fuel injection, auto-ignition, and combustion in a passenger car indirect injection diesel engine.*

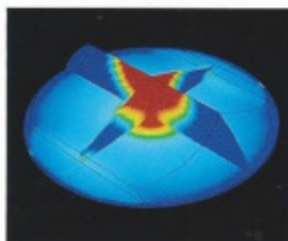

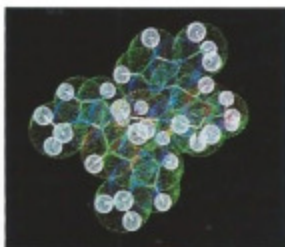
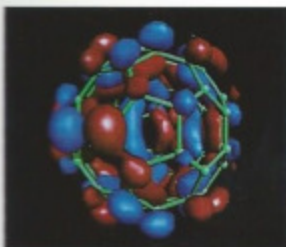

Cray Research's UniChem computational chemistry environment allows researchers to build, calculate, and visualize complex chemical systems. Below, caffeine molecule with total electron density shown in two dimensions, computed and visualized using Cray Research's UniChem computational

chemistry environment. Far left, lowest unoccupied molecular orbital (LUMO) for the C-60 molecule (Buckminsterfullerene). Left, density functional model of a copper imidazole complex displayed with a Van der Waals surface.

## UNICOS Storage System

The UNICOS Storage System is the world's first high-performance UNIX-based file server. With the UNICOS Storage System, Cray Research systems enable users to meet their computing needs while also addressing the file storage needs of their network. The UNICOS Storage System provides transparent data access, file access capabilities, system administration, and automated storage management capabilities.

## Applications

Cray Research offers leading-edge applications for nearly every scientific and engineering discipline, including the most widely used third-party application programs. These applications are used by diverse industries to accelerate product development, increase productivity, and solve basic research problems. Applications are available for

industries such as aerospace, automotive, electronics, chemistry, energy, petroleum, and defense.

To augment the utility of its supercomputers, Cray Research has developed specialized, key application packages such as:

- UniChem, Cray Research's easy-to-use supercomputing environment for computational chemistry simulation that enables researchers to explore complex chemical systems at a new level of detail from their desktops.
- CRI/TurboKiva, a powerful combustion simulation environment that provides a reliable and effective analysis tool for designing cleaner-burning internal combustion engines. CRI/TurboKiva is an enhanced engineering version of Kiva II, Los Alamos National Laboratory's public domain engine flow, spray, and chemical reaction simulation code.

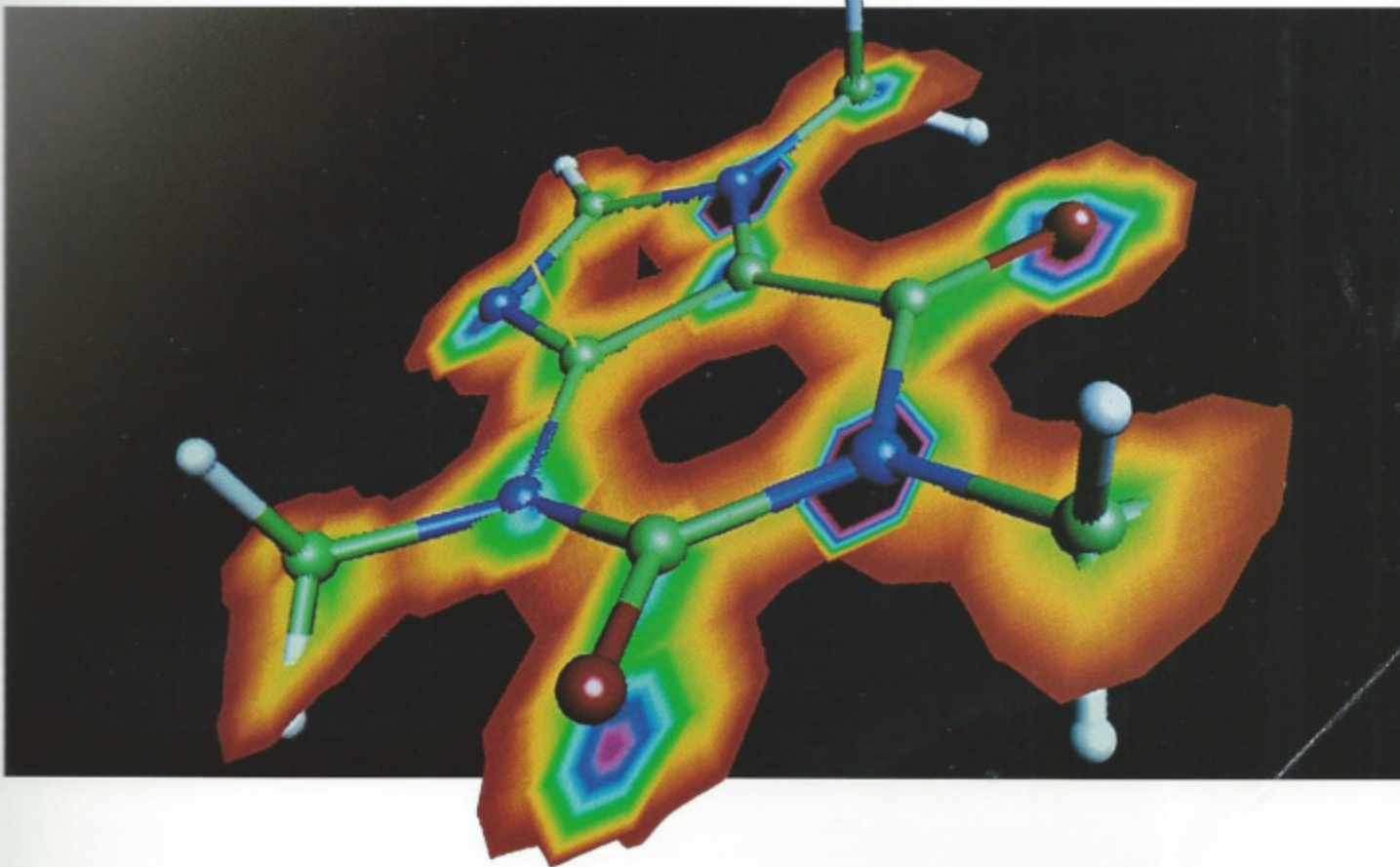



### The power of visualization

Cray Research supports the following software packages to couple the power of visualization with its supercomputers:

- Multipurpose Graphic System (MPGS)*, an interactive menu-driven engineering visualization package for use on Cray Research computer systems. MPGS works with a wide variety of engineering applications.
- AVS (Application Visualization System)*, a high-level, object-oriented environment for constructing visualization programs.
- IRIS Explorer*, a visually based, object-oriented application building environment.
- The Cray Visualization Toolkit (CVT)*, which enables users to run applications on Cray Research systems through their workstations. CVT allows users to generate graphics and graphical user interfaces easily with the following tools:
  - Release X11R4 of the X Window System
  - Sun Microsystems' XView toolkit (OPEN LOOK)
  - Open Software Foundation's (OSF) Motif 1.1 Toolkit
  - Silicon Graphics, Inc. Distributed Graphics Library (DGL)

These tools allow most applications that run on Cray Research systems to have the same "look and feel" as the most common workstation environments, making Cray Research systems even easier to use and making users more productive.

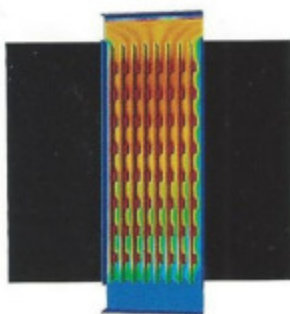

*Left, natural convection heat transfer in a three-dimensional electronics enclosure, computed using FIDAP.*

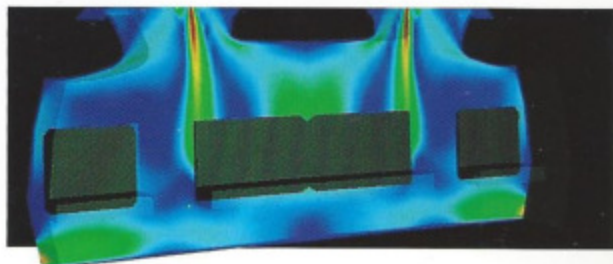

*Right, air flow in prototype B-777 aircraft cabin. Colors depict air flow velocities, calculated with FLUENT/BFC.*

# Network Supercomputing

## Delivering supercomputing power to your desktop

To bring the benefits of supercomputing to more users than ever before, Cray Research is dedicated to making its systems accessible through Network Supercomputing. Because Cray Research supercomputers support industry standards as well as a variety of language extensions, network protocols, and utilities from other vendors, they can be integrated easily into heterogeneous computing environments.

An array of communication products and protocols supported by Cray Research allows applications to be distributed within your network. Through the implementation of official, emerging, and de facto networking standards, Cray Research provides connectivity to most UNIX-based mainframes, minicomputers, and workstations. These standards include the TCP/IP networking protocol and applications, the X Window System, the Network File System, the Open Systems Interconnection (OSI) of the International Standards Organization (ISO), the

High Performance Parallel Interface (HIPPI), the Fiber Distributed Data Interface (FDDI), as well as other networking standards.

Cray Research also provides network batch software products that offer access to proprietary protocol implementations (such as SNA, DECnet, and CDCNET) through network gateways. Network batch software runs on a variety of systems and workstations to provide the logical connection to a CRAY Y-MP computer system. Standard network batch software is available for the following systems: IBM MVS and VM, CDC NOS, NOS/VE, DEC VAX/VMS, and a variety of computers and workstations running the UNIX operating system. Network batch software for Unisys and Honeywell Bull systems is available from third-party vendors.

Network Supercomputing increases user productivity by allowing access to a wide range of computing platforms for optimal workload distribution. The result is a combination of flexibility and computing power unparalleled in the computer industry.

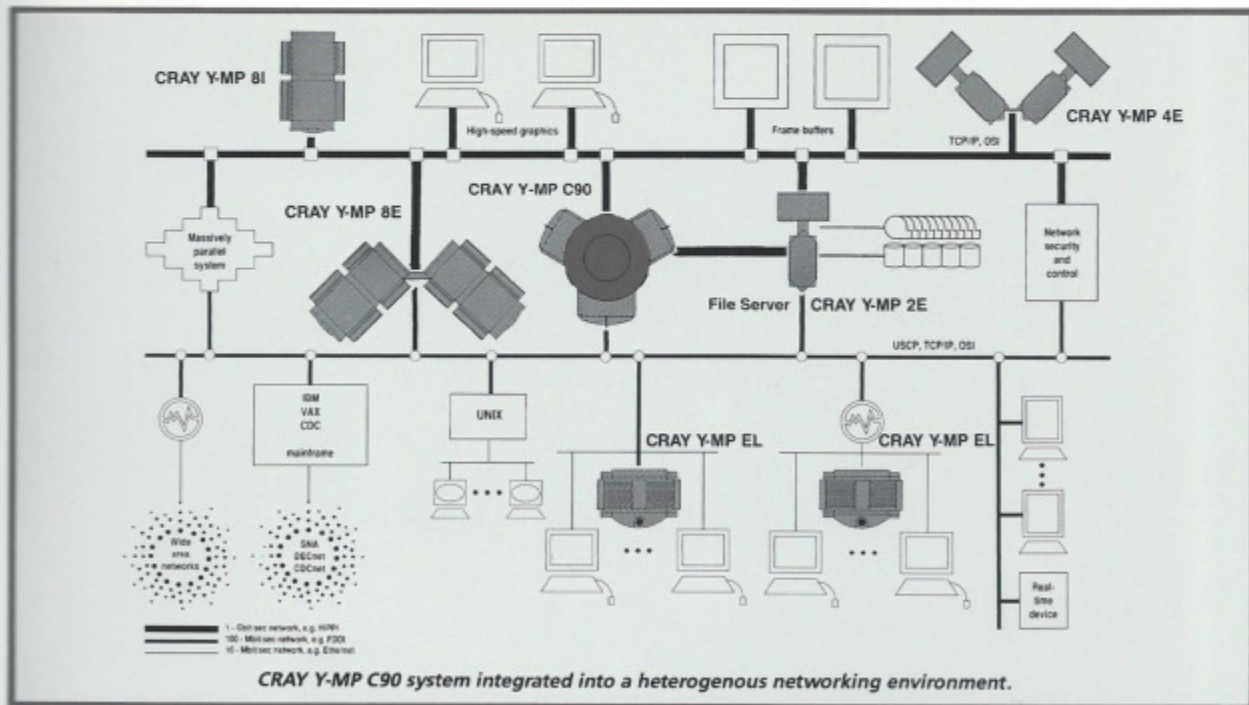

## Maximized system availability

The CRAY Y-MP C90 supercomputer uses new technologies to provide high system reliability while maintaining high performance. It includes the following design enhancements that increase its serviceability:

- *Graceful degradation of CPUs* allows CPUs to be configured in and out of the UNICOS operating system without interrupting system operation.
- *CPU isolation* allows diagnosis of isolated CPUs while other CPUs run the operating system and applications.
- *Connectorized signal, power, and cooling connections* between modules and the mainframe chassis allow for efficient removal and replacement.

Cray Research offers a wide range of maintenance options for the CRAY Y-MP C90 system to meet your needs. To assure high system availability, Cray Research has developed advanced system support tools including the new System Maintenance and Remote Test Environment (SMARTE), which provides continuous error detection and isolation. SMARTE is a UNIX-based system that schedules diagnostic activity, automatically reports errors, and provides a common X Window System interface to all online diagnostic and concurrent maintenance tools.

### The CRAY Y-MP C90 supercomputer — nothing else comes close

The CRAY Y-MP C90 system is the most powerful supercomputer available for technical computing. As part of a complete supercomputing solution, it provides the insight you need to approach today's production problems and Grand Challenges with revolutionary solutions.

For more information on the CRAY Y-MP C90 supercomputer system, contact your nearest Cray Research representative.

### CRAY Y-MP C90/16256 product specifications

#### CPU

Technology	Custom silicon 10,000 gate-array circuits
Number of CPUs	16
Vector pipes	2 per CPU
Peak performance	16 GFLOPS

#### Memory

Memory ports	4 double-word ports per CPU
Technology	15 ns BiCMOS
Memory size	256 Mwords (2 Gbytes)
Total memory bandwidth	250 Gbytes/sec

#### I/O

Number of I/O clusters	2 - 16
Total system I/O bandwidth	13.6 Gbytes/sec
HIPPI channels	100 Mbytes/sec
LOSP channels	6 or 20 Mbytes/sec
HISP channels	200 Mbytes/sec
VHISP channels	1800 Mbytes/sec

#### Optional SSD

Capacity	512, 1024, 2048 Mwords (4, 8, or 16 Gbytes)
Bandwidth	13.6 Gbytes/sec

#### Physical characteristics

Mainframe cabinet footprint area	81 ft <sup>2</sup> (7.50 m <sup>2</sup> )
IOS cabinet footprint area	23.9 ft <sup>2</sup> (2.20 m <sup>2</sup> )

Product specifications and the availability of the products are subject to change without notice.



Charge polarization in a folate molecule upon binding to the enzyme dihydrofolate reductase (DHFR). The red surface depicts regions of increased charge density; the blue surface depicts reduced density. Computed

using DMOL on CRAY Y-MP system and displayed by INSIGHT on Silicon Graphics workstation.



**CRAY**  
**RESEARCH, INC.**

655-A Lone Oak Drive  
Eagan, MN 55121  
(612) 683-3801

Supersonic flow over a pilot and F-15 aircraft, courtesy of Laurence Feldman, Fluid Dynamics International. Space shuttle courtesy of Dr. Timothy Baker and Dr. Antony Jameson, Princeton University and the NASA Johnson Space Center. Car crash model courtesy of Kia Motors. Weather forecast simulations courtesy of European Center for Medium-Range Weather Forecasts. Salt diapher images courtesy Maynard S. Redeker and Christopher P. Ross of Oryx Energy Company. Syringe rubber stopper courtesy of Becton Dickenson. Seismic migration courtesy of PRAKLA-SEISMOS GmbH. Three dimensional electronics module courtesy of Fluid Dynamics International. Airflow in B-777 aircraft courtesy of Boeing Environmental Control Systems.

CRAY, CRAY Y-MP, SSD, and UNICOS are registered trademarks, and Autotasking, CF77, CRAY Y-MP EL, CRI/TurboKiva, DD-60, DD-61, IOS, MPGS, SMARTE, and UniChem are trademarks of Cray Research, Inc. AVS is a trademark of Stardent Computer, Inc. CDC, CDCnet, NOS/BE, and NOS/VE are trademarks of Control Data Corporation. Data General is a trademark of Data General Corporation. DEC, DECnet, VAX, VAXcluster, and VMS are trademarks of Digital Equipment Corporation. Ethernet is a trademark of the Xerox Corporation. FIDAP and NEWTUN are trademarks of Fluid Dynamics International. FLUENT/BFC is a trademark of creare.x, Inc. GEOSYS is a trademark of PRAKLA-SEISMOS GmbH. IBM, MVS, and VM are trademarks of International Business Machines Corporation. IRIS Explorer is a trademark of Silicon Graphics, Inc. LANlord is a trademark of Computer Network Technology Corporation. Motorola is a trademark of Motorola, Inc. Sun Workstation is a trademark of Sun Microsystems, Inc. The Cray Research implementation of TCP/IP is based on a product from the Wollongong Group, Inc. UNIX is a trademark of UNIX System Laboratories, Inc. The X Window System is a trademark of the Massachusetts Institute of Technology.