

MICROCOPY RESOLUTION TEST CHART
NATIONAL BUREAU OF STANDARDS-1963-A

NOSC TR 1038

12

NOSC TR 1038



AD-A161 003

NINTH ANNUAL REPORT ADVANCED MAIL SYSTEMS TECHNOLOGY

Executive Summary and Appendices A-G

November 1984

Reporting Period: 1 September 1983 - 31 August 1984

Prepared by
NOSC Electromagnetic Systems and Technology Division
(Code 74)
NAVAL OCEAN SYSTEMS CENTER
San Diego, California 92152-5000

Prepared for
US POSTAL SERVICE
OFFICE OF ELECTRONIC MAIL SYSTEMS DEVELOPMENT

DTIC
SELECTED
OCT 30 1985

DTIC FILE COPY

Approved for public release; distribution is unlimited.

85 10 30 041



NAVAL OCEAN SYSTEMS CENTER SAN DIEGO, CA 92152

F. M. PESTORIUS, CAPT, USN

Commander

R.M. HILLYER

Technical Director

ADMINISTRATIVE INFORMATION

This report contains a summary of work sponsored by the Office of Electronic Mail Systems Development, Engineering Support Center of the U.S. Postal Service Agreement 104230-83-T-2925. The authorized USPS Technical Representative was A.I. Tersoff. R.O. Sheppard provided valuable assistance in defining the USPS operational characteristics and interfaces for the hardware development. The principal NOSC investigator was L.A. Wise, Image Processing and Display Branch, NOSC Code 743. Associate investigators were F.C. Martin, R.E. Laughlin, R.J. Wagar, R.W. Basinger, J.R. Evans, C.E. Dempsey, and R.G. Moreland, also in Code 743. New professionals J.E. Current and S.C. McGirr, temporarily assigned to Code 743, contributed substantially to the project software development. W.R. Robinson and A.C. Louie, Code 443, also made major contributions to the project. This report is a compilation of data generated by all team members and was approved for publication in April 1985.

Released by
F.C. Martin, Head
Image Processing and
Display Branch

Under authority of
R.L. Petty, Head
Signal Analysis and
Image Processing Division

METRIC EQUIVALENTS

To convert from	to	Multiply by
inches	mm	25.4
square inches	m ²	$\sim 6.45 \times 10^{-4}$
feet	m	$\sim 3.05 \times 10^{-1}$
miles	km	~ 1.61
pounds	kg	$\sim 4.54 \times 10^{-1}$

DISCLAIMERS

The findings in this report are not to be construed as an official U.S. Postal Service or Department of the Navy position, unless so designated by other authorized documents.

The citation of trade names and names of manufacturers in this report is not to be construed as official U.S. Government endorsement or approval of commercial products or services referenced herein.

AD-A161003

REPORT DOCUMENTATION PAGE

1a. REPORT SECURITY CLASSIFICATION UNCLASSIFIED		1b. RESTRICTIVE MARKINGS	
2a. SECURITY CLASSIFICATION AUTHORITY		3. DISTRIBUTION/AVAILABILITY OF REPORT Approved for public release; distribution is unlimited.	
2b. DECLASSIFICATION/DOWNGRADING SCHEDULE			
4. PERFORMING ORGANIZATION REPORT NUMBER(S) NOSC TR 1038		5. MONITORING ORGANIZATION REPORT NUMBER(S)	
6a. NAME OF PERFORMING ORGANIZATION Naval Ocean Systems Center	6b. OFFICE SYMBOL (if applicable) Code 732	7a. NAME OF MONITORING ORGANIZATION	
6c. ADDRESS (City, State and ZIP Code) San Diego, CA 92152-5000		7b. ADDRESS (City, State and ZIP Code)	
8a. NAME OF FUNDING/SPONSORING ORGANIZATION Office of Electronic Mail Systems Development	8b. OFFICE SYMBOL (if applicable)	9. PROCUREMENT INSTRUMENT IDENTIFICATION NUMBER	
8c. ADDRESS (City, State and ZIP Code) US Postal Service, 11711 Parklawn Ave, Rockville, MD 20852 Attn: A.I. Tersoff, Program Manager		10. SOURCE OF FUNDING NUMBERS	
		PROGRAM ELEMENT NO. FGOV	PROJECT NO. USPS
		TASK NO. 740-EE25	WORK UNIT NO. Agency Accession DN313 026
11. TITLE (Include Security Classification) ADVANCED MAIL SYSTEMS TECHNOLOGY Ninth Annual Report, Executive Summary and Appendices A-C			
12. PERSONAL AUTHOR(S) NOSC Signal Analysis and Image Processing Division			
13a. TYPE OF REPORT Annual	13b. TIME COVERED FROM <u>Sep 83</u> TO <u>Aug 84</u>	14. DATE OF REPORT (Year, Month, Day) November 1984	15. PAGE COUNT
16. SUPPLEMENTARY NOTATION			
17. COSATI CODES		18. SUBJECT TERMS (Continue on reverse if necessary and identify by block number)	
FIELD	GROUP	SUB-GROUP	
			Charge coupled devices
			Data compression
			Image acquisition
			Image processing
			Image storage
			Optical scanning
			Photodiodes
			Run length coding
			Self-scanned arrays
			Solid-state scanners
			Video processing
19. ABSTRACT (Continue on reverse if necessary and identify by block number) The objective of the effort described herein is to provide technical consultation, equipment, and support services to the U.S. Postal Service that will contribute to the development of the system definition of future electronic mail processing systems. Included in the scope of effort are investigations of high-speed image scanning technology, image frame memory storage, and image enhancement as well as fabrication of a scanner/frame-store memory test assembly. The eighth annual report briefly describes the individual efforts of the reporting period in an executive summary and provides in-depth data in three appendixes: Appendix A, Test Character Compression Study; Appendix B, USPS E-COM Logo Study; Appendix C, NOSC Logo Project Plan for Graphic Conversion Subsystem.			
20. DISTRIBUTION/AVAILABILITY OF ABSTRACT <input type="checkbox"/> UNCLASSIFIED/UNLIMITED <input checked="" type="checkbox"/> SAME AS RPT <input type="checkbox"/> DTIC USERS		21. ABSTRACT SECURITY CLASSIFICATION UNCLASSIFIED	
22a. NAME OF RESPONSIBLE INDIVIDUAL F.C. Martin		22b. TELEPHONE (include Area Code) (619) 225-6447	22c. OFFICE SYMBOL Code 732

OBJECTIVES

1. The principal objectives of this work are to provide for the US Postal Service improvements in image acquisition, compression, storage and presentation technology. Included in this scope of effort are the investigation of imaging device technology; character and pattern recognition techniques; memory technology for storage, sorting, and retrieval of messages and images; and data compression technology, including error detection and correction (EDAC). The design, fabrication, and operating support of an image acquisition work station was also included in the year's tasks.
2. Another objective is to contribute to the selection of optimum devices, equipments, and techniques for high-speed image acquisition and to provide reliable designs of high-speed image processing logic that will preserve the quality of the image while reducing the image storage and transmission requirements and that will minimize image information vulnerability to noise during processing, transmission, storage, sorting, retrieval, and reproduction.
3. The final goal is to provide support services in the form of technical consultation, test services, and facilities. Services are directed at supporting USPS technical management in reaching the goals of the USPS program in image acquisition, compression, storage and presentation technology.

RESULTS

1. The principal achievement during the reporting period was the design and development of an image acquisition work station. This work station will be utilized at the US Postal Service Engineering Support Center at Rockville, Maryland, to evaluate its adequacy for use as the Graphics Conversion Subsystem (GCS). The Graphics Conversion Subsystem may in the future form a part of the electronic computer originated mail (E-COM) System.
2. A candidate high-speed printer for the E-COM System, the Delphax Ion Deposition Printer, was evaluated. NOSC-generated logos and graphics were successfully transferred from the NOSC PDP-11/70, emulating a PDP-11/34, to the Image Generator Module and merged with the text data for printout at approximately 70 pages per second.
3. An evaluation was begun of past contractor studies for the USPS to develop a Trayed Letter Mail Counter. Comments are being prepared regarding the feasibility recommendations of the contractors, and alternate strategies are being generated for improving the accuracy of mail piece-count estimates in mail stacked in standard USPS mail trays. Laser sensors are proposed for determining count, tray volume, and degree of tray content uniformity.

NOSC PLANS

1. Continue to refine the menu structure for the Graphics Conversion Subsystem work station. Document the developed software for operation of the Datacopy, AED 1024, and Cambridge Digital processors. Ship all equipment and documentation to the USPS Engineering Support Center in Rockville, Maryland. Provide installation and startup assistance as required to complete the interface to existing E-COM equipment.
2. Complete a small review of trayed letter mail counting techniques and generate a summary report on findings. Submit the report to the USPS in Rockville, Maryland.
3. Continue to review technical literature pertinent to the generation of an optical character reader high-speed image recorder. Prepare a preliminary strawman architecture for review by USPS engineers. Acquire approved components for the image recorder and fabricate the required recorders.
4. Continue to support solutions to USPS requests for assistance in other problem areas covered by the USPS/NOSC statement of work, including memory technology, imaging devices, display technology, optical character recognition, and pattern analysis.

CONTENTS

EXECUTIVE SUMMARY . . .	Page 5
BACKGROUND . . .	5
1983/1984 GOALS . . .	5
Accomplishments . . .	5
NOSC Plans . . .	12
APPENDIX A	GRAPHICS CONVERSION SUBSYSTEM HARDWARE AND SOFTWARE . . . A-1 October 1984
APPENDIX B	DATACOPY CAMERA AS THE GRAPHICS CONVERSION SYSTEM INPUT . . . B-1 January 1984
APPENDIX C	GRAPHICS CONVERSION ACQUISITION ALTERNATIVES . . . C-1 1 March 1984
APPENDIX D	ILLUMINATION COMPUTATION PROGRAM . . . D-1 3 April 1984
APPENDIX E	AN AUTOEDIT PROGRAM . . . E-1 19 April 1984
APPENDIX F	THINNING ALGORITHM . . . F-1 1 March 1984
APPENDIX G	EXAMPLES OF FACSIMILE DATA COMPRESSION . . . G-1

EXECUTIVE SUMMARY

BACKGROUND

Through interagency task agreements, the USPS and NOSC have been cooperating in the development of high-speed image processing techniques for approximately 10 years. During this period, NOSC has participated in numerous developments for the acquisition and printing of imagery to be used for the electronic transmission of letter mail.

Because of the demanding USPS speed and resolution requirements, NOSC developed the Image Capture and Analysis System (ICAS) as a means to verify performance of imagery components at real-time rates. This equipment offers the capability to evaluate illumination sources, scanning imaging devices, analog-to-digital conversion components, memory technology, and printer equipments. Several important equipment evaluations of image acquisition and printing equipments have been successfully completed using ICAS. ICAS is fully operational and is available to support both the USPS/NOSC project and other NOSC projects as well.

1983/1984 GOALS

The principal goals for the reporting period pertained to the development of two prototype subsystems of a developmental Electronic Computer Originated Mail (E-COM) image acquisition and printing node. One subsystem is the Graphics Conversion Subsystem. The second subsystem is the Printer Subsystem.

At the end of the reporting period, two additional tasks were requested. The first of these was the review of existing documentation and specifications for a Trayed Letter Mail Counter. The second was the initiation of a major task, most of which will be accomplished during the next reporting period under a new task agreement. This task pertains to the design and fabrication of portable digital recorders for the acquisition and playback of image data acquired from optical character reader equipments now deployed at Postal Service sites.

ACCOMPLISHMENTS

As a result of several visits to the USPS Engineering Support Center at Rockville, Maryland, the NOSC team became familiar with the high-performance Hewlett Packard 2680 Laser Printer subsystem currently under evaluation for suitability as an output printer for the USPS E-COM System.

Graphics Conversion Subsystem

We also became familiar with the USPS graphics conversion work station components, including the Datacopy camera system and the Bencher copy stand at Rockville. NOSC was tasked with the problem of the design and fabrication of a new Graphics Conversion Subsystem (GCS) work station, including the selection of all components needed for the work station. The equipment was procured, interfaced and made electrically ready for the development of software required for the work station man - machine interfaces.

The function of the GCS is to provide a means for the conversion of hardcopy customer logo and graphic inputs into a digital image format so that the data can be disseminated to all print sites, stored, retrieved, merged with text information, and printed at high rates as needed.

All software was written to perform the processes of image acquisition, editing, thinning, compression, storage, and retrieval for image sizes up to 1024 by 1024 pixels. A description of the hardware and software designed for the GCS is contained in Appendix A.

The GCS work station remained at NOSC for further improvements in the man - machine interface menu and final documentation of the hardware and software for the equipment. The work station component arrangement as used at NOSC for final checkout before shipment is depicted in figure 1.

The Datacopy Camera

One of the most important components of the GCS work station is the camera used to acquire the graphics images. The USPS had been using a Datacopy camera, which was a part of the HP 2680 Laser Printing System under evaluation at the Engineering Support Center. NOSC was requested to consider the Datacopy camera as well as other alternatives for use in the work station design.

A survey of off-the-shelf sources of cameras having equivalent performance features and a review of the technical manuals for the Datacopy unit led to the selection of a camera almost identical to the one in use at Pockville.

When the camera was received, an attempt was made to perform a qualitative evaluation of its performance. Tests indicated that its resolution, electrical video bandwidth, spatial linearity, and response uniformity were very good. The camera was found to be extremely sensitive to the infrared end of the spectrum. This deficiency was greatly reduced by the acquisition of an IP filter.

In working with the camera, the two greatest frustrations were: (1) establishing the desired spatial resolution for the acquired image, and (2) achieving the optimum focus. This process was hampered by the manner in which



Figure 1. Graphics Conversion Subsystem work station.

images are acquired in the "snapshot" mode by triggering each acquisition and waiting for an image to appear on the Datacopy high-resolution monitor. Both of these adjustments are interactive. A change in the camera height to accommodate a slight adjustment in spatial resolution caused a defocussing of the image. A slight change in the focus caused a slight change in the spatial resolution.

For these reasons a decision was made to consider modifications to the camera so that indications of spatial resolution and focus may be continually monitored in real time while the adjustments are being made. Appendix B describes the modifications made to the camera so that focus adjustments can be easily optimized.

Establishment of precise spatial resolution would have required the use of an oscilloscope examination of waveforms generated by special test targets. A decision was made not to include this feature as an operator procedure at the work station. Instead, several charts were developed to provide exact camera heights for various common required spatial resolution settings. The tables presented in Appendix B are different for each lens used. Exact camera heights for common lenses and required resolutions will be refined by operator familiarity and usage. Hardware kits and instruction sets for the focus indicator were made for both Datacopy cameras and are in every day use at Rockville.

Graphics Conversion Alternatives

The USPS has devoted considerable attention to the customer interface requirements for E-COM. This concern extends beyond the existing customer procedures and technical requirements for submitting E-COM messages for transmission. The use of image information on mail pieces raises the question of the exact specification of customer graphic inputs for this purpose.

No definite conclusion has been reached on whether the customer may eventually be allowed to submit digitized graphic images. It is certain that the USPS will need an in-house capability for conversion of most customer hardcopy master images into properly scaled and edited facsimile-equivalent images.

During the previous year's study, tradeoffs were made regarding super-resolution scanning so that stored digitized graphic images could be processed for use with printers of different spatial resolutions. Because of the storage requirements, recommendations were made not to use this method. The only unresolved question was the possible benefits to the USPS and to the customer for allowing larger than 1:1 masters for customer graphics inputs.

Appendix C briefly analyzes the use of large masters for acquisition. The consequences of using or not using 3:1 or 5:1 masters are not too serious as long as the current planned logo size of 2.6 inches wide by 2.1 inches high is adhered to. The maximum copy size for 5:1 would be 13 by 10.5 inches. Full-page-width or full-page-length banner graphics, however, would present an unmanageable master size.

The analysis, presented in appendix C, finds no appreciable advantages for the use of 3:1 or 5:1 masters if the 1:1 master is of professional graphic arts quality.

Illumination Computation Program

The components of the Graphics Conversion Subsystem included the Bencher Copy Stand. As originally procured, the copy stand was equipped with two 250-watt quartz iodide lamps for reflective illumination. These were mounted approximately 44 inches apart and 20 inches above the easel surface. A back-lighted system was also included for copying transparencies.

Early in the program it was found that more illumination was required. The Nikon f 3.5 lens was used at full aperture in order to marginally obtain a full-amplitude video signal from the Datacopy camera. Losses were even more severe when the large Bencher Polariod filters were used with the illumination system. Previous tests of this particular model lens have shown some vignetting of the optical path when used at full aperture.

The illumination computation program was written to calculate possible improvements in intensity and uniformity of illumination over the area of the easel used for image acquisition. A discussion of the illumination problem and the results of the calculations are contained in Appendix D of this report.

The program results showed that the four-lamp configuration using the existing Bencher brackets allowed a spacing of 44 inches wide by 19 inches deep, and would give considerably more intensity uniformity. The intensity would also be almost doubled. Additional lamp holders and a set of four 600-watt lamps were procured for the copy stands. Full-amplitude video signals may now be obtained with the lens stopped down to f 5.6, where it achieves maximum modulation transfer function and offers greater depth of field.

The program also showed that if the copy size can be restricted to 8-1/2 by 11 inches, a significant improvement in both uniformity and brightness can be achieved by moving the lamps inward and downward to a 24- by 24-inch separation and a height of 9 inches from the easel. Variation of intensity over the 8-1/2- by 11-inch copy area would be less than 3%, including cosine-fourth losses. This modification would require only a simple mechanical bracket modification.

Autoediting

A software routine was written for the AED Color Graphics Terminal to accommodate autoediting. This work is described in appendix E. Often black or white edges of images are intended to consist of smooth horizontal or vertical lines or smooth portions of conic-section curves.

Variations in the line density of the hardcopy master, variations in the sensitivity of the imager photosites, relative positioning of the copy with respect to spatial sample domains, and system noise all can contribute to irregularities of edges of graphic images.

In the standard logo size of 624 pels width by 504 pels height (314,496 pels), there may be many hundreds of irregularities on the boundaries of detail in the images. Irregularities will be in the form of "bumps" or "dents" on otherwise regular straight or curved edges. A dent in a black edge is a bump in a white edge.

In the autoediting routine used with the AED, both single and double (two-pel) bumps and dents are correctable.

The autoediting routine is available to the operator of the GCS work station by use of the menu tree. Its use is left to the judgement of the operator. For some images having much filigree, the autoediting program may contribute little or nothing to the appearance of the image when printed. If used, an operator would normally call for the autoediting function immediately after the capture of an image by the Datacopy camera and its transfer to the AED.

The Thinning Algorithm

The two printers presently under evaluation for future USPS E-COM use are the HP 2680 and the Delphax 2460. These printers have resolutions of 180 by 180 and 240 by 240 pels/inch, respectively. Photosites in the Datacopy camera imager are 13 microns (0.00051 inches) square. When acquiring images for one of these formats, the camera height is adjusted so that each photosite collects light from exactly the proper size square on the easel.

The resulting facsimile image in the camera storage unit and the image displayed on the Datacopy high-resolution monitor maintain a very good spatial relationship to the original master image.

Because of their xerographic methods of attracting toner to the charged drum, the printers change this spatial relationship to some extent by modifying the shape and size of the printed pel. In the case of the Delphax printer, the ion generator used to store charge on the drum deposits an almost round charge packet having a diameter of 10 to 15 mils rather than the 4.167-mil square which was originally scanned. This expands the black areas of a printed image to a noticeable and perhaps objectionable extent.

The HP 2680 Laser Printer uses a deflected laser beam to discharge pel areas on the precharged drum where no toner is required. The round laser spot size is somewhat larger than the original 5.55-mil square pel. By removing too much charge, less toner is applied to the graphic image edges than intended and black areas are decreased in size.

In order to try to compensate for growth of the black areas of an image, a thinning algorithm was devised. The algorithm employs a digital 3 by 3 kernel which is applied to each pel (except the borders) of the image. The kernel recognizes the state of the center pel and its eight surrounds. If the center pel is black and on a boundary, the states of the eight surrounds are used as specific addresses to lookup tables, where decisions are made to modify or

confirm the state of the center black pel. The rules for the tables are completely documented in Appendix F.

The opposite of thinning could have been accomplished by devising a second dual lookup table for white center pels. This would have required twice the storage space in the AED memory.

The method selected for thickening in the GCS work station is to produce a ones complement (negative) of the image, and then perform the thinning on the complement image. When this image has again been complemented back to a positive, it has been thickened.

Thinning is a standard procedure on the main GCS work station menu. It is usually called for after editing has been completed. The thinning process on the AED is data dependent and requires approximately 45 seconds for a standard 624- by 512-pel image.

Facsimile Data Compression

The possible future addition of a graphics capability to the USPS E-COM system introduces concerns regarding the increased volume of digital information which affects system data transmission and storage requirements. An 80-column, 50-line alphanumeric text message transmitted using the American Standard Code for Information Interchange (ASCII) requires only 32 kbits to define the entire message.

The tentative minimum graphics area chosen by USPS to accommodate the printing of most common business logos uses a 624-pel width by 504-pel height, requiring a total of 314,496 bits. Provisions in the GCS work station allow for the processing and storage of 1024- by 1024-pel graphics.

The two-dimensional compression algorithm specified in EIA Standard RS-465 was briefly analyzed for suitability to facsimile graphic images. In addition to gaining familiarity with the algorithm, we were able to test the approximate range of compressibility by manually invoking the algorithm rules on two very simple image segments. One of the examples was a simulation of a graphic containing very high two-dimensional spatial frequency content. This would be equivalent to a segment of a customer logo having halftone or filigree content. The other example was a segment of a form having only seven vertical ruled column lines.

Compressibility of the first example was approximately 1:1, yielding no improvement in transmission or storage requirements. In the second example, the compression ratio, as expected, was a very high 50:1. We estimate that for a mix of conventional logotype graphics, the compression ratio might be between 20:1 and 50:1. This algorithm is not recommended for use if the bit error rate of the transmission channel or storage equipment is less than 10^{-8} or 10^{-9} . The results of the analysis are contained in Appendix G.

The Printer Subsystem

We were also briefed on the USPS plans to procure a Delphax Ion Deposition Printer for evaluation at Rockville as to applicability for E-COM. A similar Delphax printer was procured by USPS for evaluation at NOSC.

The USPS used a DEC PDP-11/45 as a host for the printer. NOSC had no PDP-11/45 immediately available as a host, so the NOSC PDP-11/70 was used as the host. A driver for the printer was written. Tapes containing USPS test messages could be loaded on the PDP-11/70 and transmitted to the Delphax printer where the messages were printed at approximately 70 pages per minute. We demonstrated that logo images could be merged with the text messages. Considering the throughput rate of the printer, the quality of the text and graphics outputs was quite good.

Flow charts of the processes were generated and are available at NOSC, but no detailed documentation of the printer investigation is included in this report. The Delphax printer subsystem, with the exception of the Renaissance tape drive, was shipped back to the USPS prior to the end of the reporting period.

NOSC PLANS

Image Acquisition Studies

1. Generate a candidate hardware design for an OCR test and verification equipment. This portable digital recorder must accept and replay 50 Mbytes of digital image data at rates up to 16 Mb/s.
2. Fabricate two prototype units for each of the two types of OCR equipments in the field.
3. Evaluate the operation of the prototypes with each of the two types of OCR equipments and modify software as required to insure proper operation and to satisfy the requirements for directory or header information retrieval.

Image Processing and Pattern Recognition Algorithm Analysis and Development

1. Become familiar with the OCR instruction sets and programming techniques employed.
2. Perform analysis of specific routines to concisely identify various software processes.
3. Provide suggestions for improvements to the present processes

Data Storage and Retrieval Technology

1. Continue to maintain and expand the memory components and techniques library.
2. Provide assistance to USPS in the use of a stored directory to determine a ZIP plus 4 code using outputs from the OCR equipments.

Image Presentation Studies

1. Provide assistance as required on the applicability of video display systems for presentation of addresses of rejected mail pieces and other usages within the postal system.
2. Provide assistance as required in the consideration of alternatives to printing bar codes by the use of ink jets.

APPENDIX A
GRAPHICS CONVERSION SUBSYSTEM
HARDWARE AND SOFTWARE

R.W. Basinger, L.A. Wise and J.R. Evans

October 1984

APPENDIX A CONTENTS

INTRODUCTION . . .	Page A-5
SUBSYSTEM CONFIGURATION . . .	A-5
Operational Requirements . . .	A-6
Human Factors . . .	A-6
Overall Configuration . . .	A-7
Subsystem Components . . .	A-7
Datacopy CCD camera system . . .	A-7
Cambridge Digital System 94 microcomputer . . .	A-11
AED 1024 graphics terminal . . .	A-12
DEC VT-100 terminal . . .	A-13
Dual RX02 floppy disk . . .	A-13
LA36 printer . . .	A-13
SUBSYSTEM SOFTWARE . . .	A-14
General Characteristics . . .	A-14
Disk organization . . .	A-14
Overlay structure . . .	A-15
Languages . . .	A-15
Data Structures . . .	A-16
Data tables . . .	A-16
File structures . . .	A-17
Software Device Drivers . . .	A-17
Program Modules . . .	A-18
Acquisition . . .	A-18
Alignment . . .	A-21
Image transfer . . .	A-21
Keyboard Editing . . .	A-21
Thinning . . .	A-22
Storage . . .	A-22
Retrieval . . .	A-22
Output Formatting . . .	A-22
Directory . . .	A-22
Operational Assistance . . .	A-23

APPENDIX A ILLUSTRATIONS

- A-1. GCS component interconnection . . . Page A-8
- A-2. GCS physical layout . . . A-9
- A-3. GCS software overlay structures . . . A-15
- A-4. Image plane data table organization . . . A-16
- A-5. Main GCS operational menu . . . A-19

APPENDIX A TABLES

- A-1. Major GCS Components . . . Page A-10

INTRODUCTION

For approximately the last 2 years, the US Postal Service has been operating the Electronic Computer Originated Mail (E-COM) system. Since commencement of operation, it has been felt that providing for the inclusion of customer graphics on mail transmitted via E-COM would significantly increase customer acceptance.

As part of the statement of work from the USPS to NOSC, we were tasked with the implementation of a Graphics Conversion Subsystem (GCS) to aid in the development of graphics processing as an additional offering to E-COM customers. An HP 2685 laser printing system, already in operation at the USPS Engineering Support Center, Rockville, MD, had demonstrated the feasibility of placing graphics on E-COM output. NOSC was requested to investigate the alternate technology approaches which might improve the existing capability.

The final product resulting from this task is a suite of hardware and a comprehensive software base designed to make acquisition (digitization), aesthetic enhancement, storage, and retrieval of graphics straightforward and efficient. An important design criterion concerned the human factors of the system. That is, the system should be easy to learn and operate. It is felt that this objective has been fully satisfied.

This appendix consists of two major sections. The first section presents an overall description of the GCS requirements, organization, and constraints and provides details on the system hardware, including a complete list of the hardware components and the interconnection scheme. The second section is a detailed description of the system software implementation, including the conceptual approach and actual method of implementation.

SUBSYSTEM CONFIGURATION

This section describes the rationale for the hardware selection. The first portion describes the general operational requirements and overall system configuration. Next, a more detailed description of each of the hardware components is provided.

OPERATIONAL REQUIREMENTS

Given that the E-COM service was to include logos as part of the offering to customers, it was necessary to determine the most efficient and cost-effective method of digitizing, editing (cleaning up), and storing graphics for printing by the E-COM system. In designing the GCS, some basic assumptions were made about the technical requirements for the subsystem. Most of the data for these assumptions were provided by the USPS.

The initial design goal of the GCS was to accommodate 3000 logos, each approximately 1.25 by 1.25 inches. In order to match the resolution of the Renaissance/Delphax printer that was to be used for printing the test documents, the digitized resolution was set at 240 pels per inch in each direction. This resulted in an initial requirement for approximately 43 Mbytes of on-line storage.

In addition to the storage requirements, it is necessary for the GCS to provide a wide range of logo editing capability. It must be possible to alter individual pels or, alternatively, to alter large areas with a single command. Every effort must be made to produce a digitized logo which, when printed, will look identical to the original.

HUMAN FACTORS

A basic requirement of the GCS was that it be operable with a minimum of instruction by an individual lacking computer training. In order to accomplish this, it is necessary to minimize the number of commands and manual operations required of the operator to acquire, edit, store, and retrieve logos. Commands must be either easy to remember or prompted such that no memorization of commands is necessary.

The physical layout of the GCS is such that the motions required of the operator are minimized. For example, the operator could not be required to walk across the room to scan a hardcopy graphic, then walk back to process it.

In order to satisfy the mechanical requirement, the GCS was laid out so that the operator could perform virtually all phases of logo processing without ever leaving his/her seat. The copy stand on which the digitization takes place is within easy reach of the operator's station. The Datacopy monitor is placed on a swivel platform at the far end of the work station table so that it is out of the way, but can be positioned by the operator for the best viewing angle.

The Advanced Electronic Design (AED) keyboard and display are placed directly in front of the operator to afford the easiest access to the equipment which will be used most during graphics processing. Unfortunately, however, the layout is biased in favor of right-handed operators, i.e., the

bit pad is placed in the center of the work station, to the right of the keyboard. It is hoped that this will not present a problem.

OVERALL CONFIGURATION

Given the basic design requirements, the hardware selected for the GCS consists of a Datacopy high-resolution camera system, a Bencher copy stand, a Cambridge Digital System 94 microcomputer system, an AED 1024 Color Graphics System, a DEC VT-100 terminal (GFE), a Data Systems Design PX02 lookalike (GFE) and a DEC LA36 printer (GFE). Table A-1 itemizes these components along with their approximate cost.

The three GFE items used at NOSC during the subsystem development are not included in the system delivered, but their absence should not adversely impact the operation of the GCS. The VT-100 was used only for program development, and all programs were written specifically to use the AED 1024 as the operating terminal. The RX02 was used only for partial software backup and for transferring graphics from the GCS to the Renaissance printer subsystem. This will no longer be necessary because the printer subsystem is not expected to be used further and the GCS streaming tape drive can be used for backup generation. The LA36 has been used only for program listings, not for general operation.

Figure A-1 is a block diagram of the GCS component interconnection. Note that the Cambridge Digital System 94 physically contains several of the building blocks, but is represented in its logical form, i.e., as a focal point for those building blocks. Figure A-2 is a sketch of the physical layout of the work station.

SUBSYSTEM COMPONENTS

DATACOPY CCD CAMERA SYSTEM

The Datacopy camera system is the source of the digitized graphics. The system consists of a charge-coupled device (CCD) camera, a camera controller, a framestore memory, and a high-resolution full-page monochrome monitor. In addition, a Bencher camera copy stand can be considered as part of the camera system.

Special control electronics were designed and fabricated at NOSC. The most significant addition is a focusing circuit, which allows determination of best focus based on a single meter deflection rather than the more subjective (and lengthy) process of scanning, viewing the image, rescanning, etc. The existing camera controls were also relocated to the control box containing the custom circuitry to allow centralized control of the digitizing process.

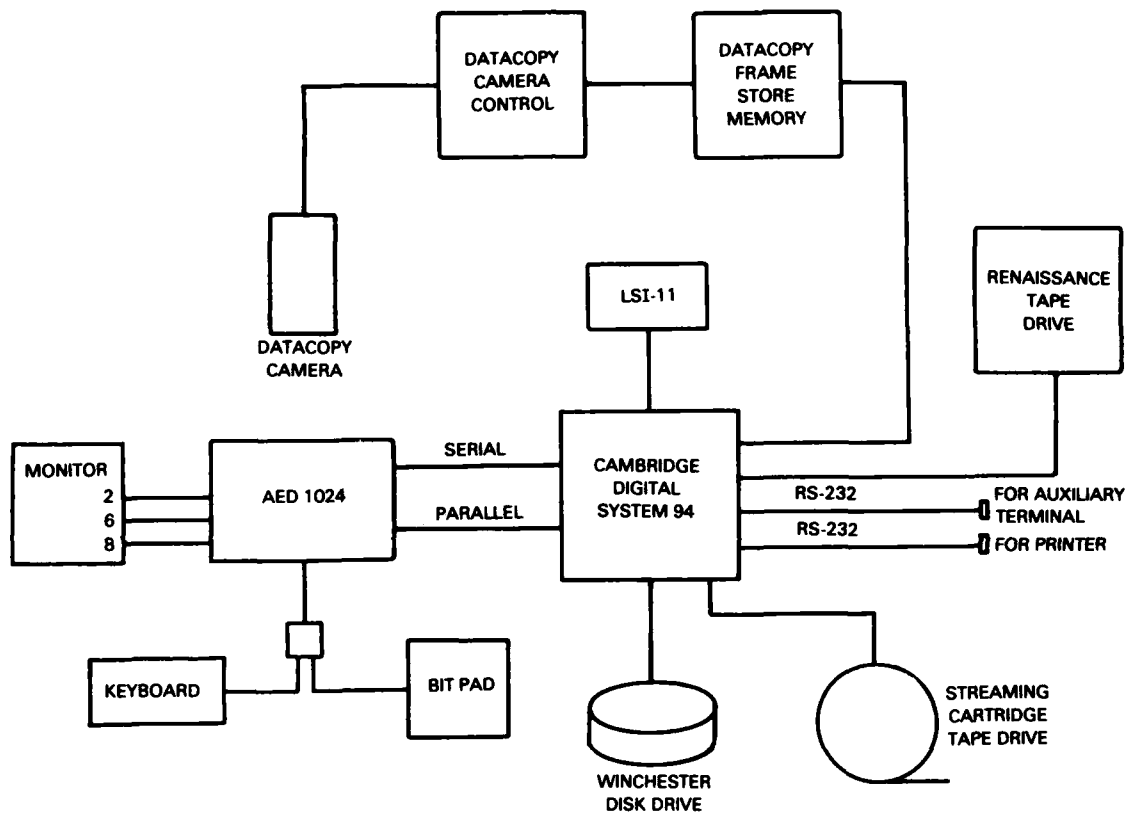

Figure A-1. GCS component interconnection.

A-9

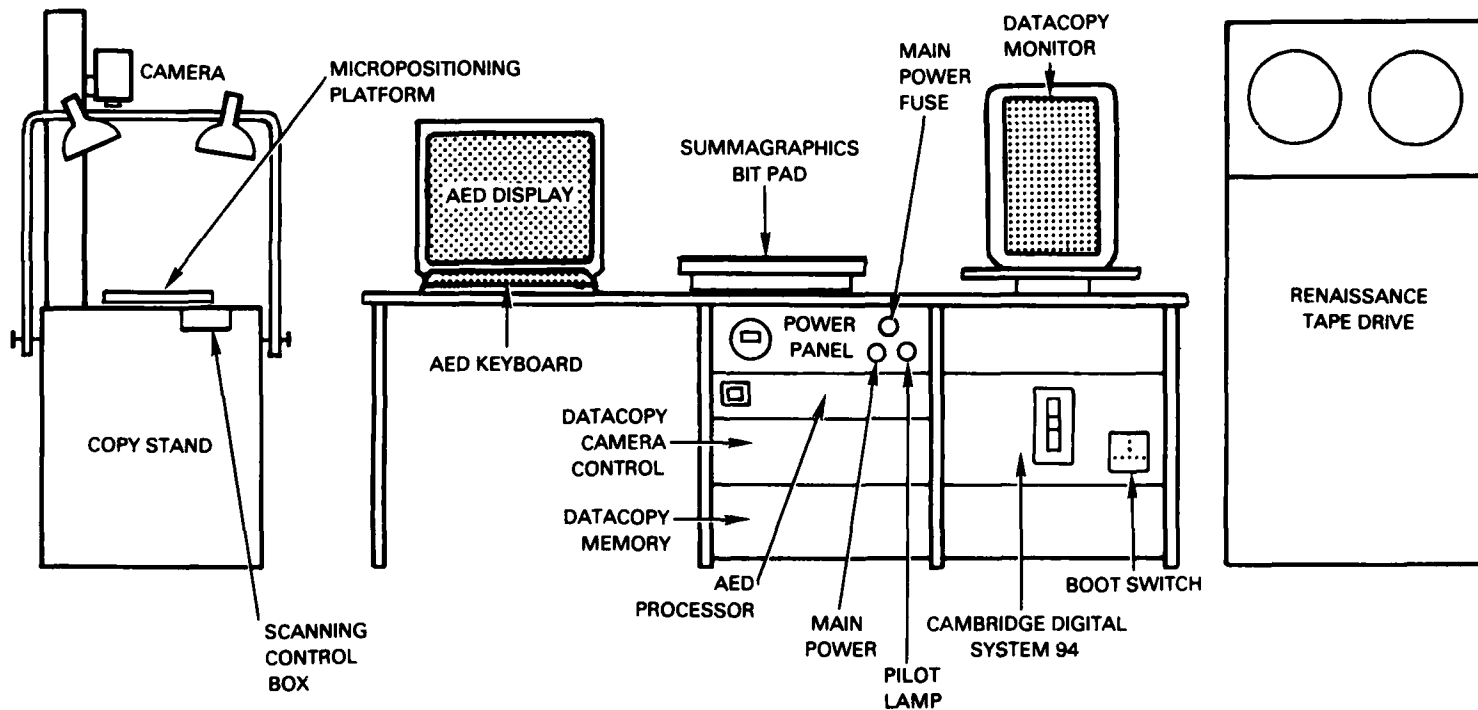

Figure A-2. GCS physical layout.

Table A-1

Major GCS Components

NAME	PART NUMBER	EST. COST
Advanced Electronic Designs 1024		
AED 1024 Processor		14,000
Mitsubishi monitor		3,000
Summagraphics Bit Pad 1		1,000
		<u>\$16,000</u>
Cambridge Digital System 94		
Digital Equipment Corporation LSI-11/23		4,000
Fujitsu M2312K Winchester disk drive		3,500
Emulex SC02/C disk controller		1,500
CDC streaming tape drive		1,500
Alloy LSI-50 streaming tape controller		1,500
Sigma 10.5" chassis incl. 9x4 LSI-11 backplane & power		2,000
		<u>\$14,000</u>
Datacopy Image Acquisition System		
Datacopy C322 electronic camera		8,000
Datacopy B521 logic unit		8,000
Datacopy D515 monitor unit		8,000
Datacopy I340 image processing unit		3,000
Interface - Datacopy to DEC Q-bus		2,000
Nikon Micro-Nikkor f3.5 55mm lens		500
		<u>\$29,500</u>
Bencher copy stand		
132-31 M2, Illuma System incl pedestal		1,225
137-50 column scale		50
137-25 copy mask set		100
138-60 polarizing light filter kit		125
		<u>\$1,500</u>
Data Systems Design DSD 480 Dual floppy disk drive with Q-bus interface		\$8,000
Digital Equipment Corporation VT-100 display terminal		\$4,000
Work station - 72 in. w x 36 in. d x 30 in. h, w/ two 19-in. integral racks		2,000
Power distribution		200
		<u>\$2,200</u>
Total Estimated Cost		<u><u>\$73,200</u></u>

The focusing and digitizing processes are quite straightforward. To focus the lens, a bar pattern is placed on the copy stand beneath the camera. A switch is set to cause the camera scan to stop at its midpoint so that the image is focused on the CCD through the most uniform portion of the lens, i.e., minimal cosine-fourth losses. The scan button is pressed to cause the imager to execute the half scan. The focusing ring on the lens is then rotated until maximum deflection is achieved on the meter. The focusing circuit causes maximum deflection when transitions are sharpest between the black and the white bars of the test pattern.

After focusing, the bar pattern is replaced with a logo original and the switch is reset to allow a full scan. The scan button must then be pressed once to cause the imager to return to its home position. The system is then ready to scan the desired graphics hardcopy.

CAMBRIDGE DIGITAL SYSTEM 94 MICROCOMPUTER SYSTEM

In order to maintain compatibility with the Renaissance/Delphax printing subsystem, a DEC LSI-11/23 microcomputer was chosen as the GCS controller. This would ease ultimate interconnection of the two subsystems for test and evaluation of the logo production and printing capabilities of the two subsystems.

In addition to compatibility with the printer subsystem, the basic storage requirement of about 43 Mbytes had to be met. Also, it was desired to provide some form of high-capacity backup for the contents of the on-line disk storage.

The critical requirements for the system controller were as follows: a microcomputer system, based on the DEC LSI-11/23 to include either the LSI-11/23 or the LSI-11/23 Plus processor; 256 kbytes of main MOS memory; a DEC RXV21 dual 8-inch floppy disk drive (or equivalent); a Winchester disk drive; a DEC DLV11-J serial I/O board (or equivalent); RT-11 software operating system; a FORTRAN IV compiler. For these reasons, a Cambridge Digital System 94 was selected as the "host" computer for the GCS.

The CD94 is a packaged system that includes a DEC LSI-11/23, a 256-kbyte memory, a 60-Mbyte Winchester technology fixed disk (and controller), a dual 8-inch floppy disk drive (and controller), and a 4-port serial interface card. The system also includes the DEC RT-11 operating system, MACRO-11 assembly language, and RT-11 FORTRAN for software development.

Selecting these components as a "package" (system) offered two major advantages. First, the system price was somewhat less than the sum of the individual components. Second, and more important, it obviated the need to purchase individual components and spend a great deal of time getting them to work together.

As may have been noted, the original requirement included a dual floppy disk drive, but the delivered system included a streaming cartridge tape in its place. This was turned to our advantage because it was decided that the tape would serve as a better backup medium for the fixed disk than would the floppy disks. In addition, we were able to borrow (GFE) a dual RX02 floppy disk drive from a NOSC-owned DEC computer system, thereby serving both needs.

AED 1024 GRAPHICS TERMINAL

For the purpose of editing logos for the best possible reproduction by the printer, a set of essential characteristics was determined. This set included a 19-inch display and at least 600- x 750-pel resolution, local pan and zoom with joystick or thumbwheel control, some local programmability (e.g., function keys), single-pel edit capability, and full display transfer in less than 15 seconds.

Several graphics terminals were evaluated for use in the GCS for the purpose of editing the softcopy images. The AED 1024 was chosen for a number of reasons. The most important of these was that it was (at the time of selection, August, 1983) the only graphics terminal that would allow direct manipulation of individual pels in the raster scan format. In addition, it was the only terminal which satisfied all other basic requirements, i.e., each of the other potential candidates omitted at least one of the requirements.

Additional advantages included prior experience at NOSC with the AED 512, which is an earlier (and smaller) model in the AED line. As a result, much of the necessary software had already been developed and was available for translation to the AED 1024 for use in the GCS.

The AED graphics terminal consists of a CRT, a 6502C microprocessor with associated RAM and ROM, and enough video memory to contain a 1024- by 1024-pel image with 8 bits of data per pel. The AED image displayed to the user is a 1024 by 768 image. To see the full virtual screen, the image can be panned by means of either the pan function built into the keyboard or a subroutine call under program control. Because each pel of the AED is an 8-bit value, it can represent one of 256 distinct user-defined color values taken from a palette of 2^{24} possible values (red= 2^8 , green= 2^8 , and blue= 2^8). The terminal also allows the user to zoom (magnify) the image by a factor of up to 16. Zooming is done by pixel replication in both the vertical and horizontal directions. This can also be accomplished by either keyboard or program control.

The AED also has 8 kbytes of RAM available for downloading of programs and data. The code downloaded is, of course, 6502 assembly language translated by a cross-assembler running on the LSI-11/23. The thinning algorithm and the autoediting functions (described in the software section) are implemented in this fashion.

The AED 1024 has a high-speed DMA port which allows data transfer at about a 512-kbyte/second rate, allowing the display to be loaded in about 0.5 second. (The Datacopy framestore memory organization has proven to be the limiting factor on transfer speed, so a full display transfer requires about 35 seconds.)

The AED 1024 has a virtual display area of 1024 x 1024 pixels and an actual display window (physical display area) of 1024 x 768 pels with local pan and zoom functions to allow access to the entire virtual area.

Although the AED 1024 lacks the joystick and function keys that were advertised (the design was changed between order placement and delivery), cursor (arrow) keys allow essentially the same operation as would be allowed with a joystick. At NOSC's request, the vendor did, however, supply a graphics tablet (at no additional charge) to provide some of the functionality lost by the omission of a joystick. This device allows somewhat smoother direct control over cursors on the display than is allowed by use of the cursor control keys.

DEC VT-100 TERMINAL

The VT-100 terminal (GFE) was selected for two very simple reasons. First, it is compatible with the LSI-11 and RT-11. Second, it was available on loan from another project at no charge. The only function of the terminal was program development, since it is compatible with DEC editor functions with which the AED 1024 is not compatible. This reduced the software development cycle significantly.

Although some modification to the software by USPS personnel is anticipated, such effort is expected to be small enough that one of the non-screen editors which can be used with the AED 1024 will suffice.

DUAL RX02 FLOPPY DISK

The RX02 (actually, a Data Systems Design lookalike) was selected for the same reasons as the VT-100. The function of the RX02 was only to provide interim backup capability and to provide a method of transferring test logos to the Renaissance printer subsystem and to the USPS. This capability should not be required in the future.

LA36 PRINTER

The LA36 printer was used only to provide software listings during program development. Any printer compatible with DEC hardware will serve just as well for this purpose, should any future software development take place at USPS facilities.

SUBSYSTEM SOFTWARE

GENERAL CHARACTERISTICS

The software for the GCS runs under the Digital Equipment Corporation's RT-11 operating system on an LSI-11/23. The software for the GCS is written in RT-11 Fortran IV, but it consists mostly of a hierarchy of routines and data structures that call upon the approximately 50 routines built into the AED 1024 firmware. To understand the software, the user should be familiar with the (AED) hardware (described above) for which it was written.

There are nine major functions that the software performs:

1. Acquisition.
2. Keyboard editing.
3. Tablet editing.
4. Thinning.
5. Storing.
6. Retrieving.
7. HP tape formatting.
8. Directory.
9. Operational assistance.

The software is menu-driven and appears to the user as a single program. However, the program actually consists of a root program and seven separate overlay routines, all under control of an executive residing in the root program.

To invoke the program it is only necessary to type "TMENU" at the system console. From that point, most GCS operations are executed by selection from various menus.

Disk organization

The System 94 Winchester disk consists of a single physical volume, but comprises three logical volumes: DMO, DM1, and DM2. DMO is used as the system disk and contains all source, text, object, library, and executable files. DM1 is used solely for logo storage. DM2 is used as an on-line backup for DMO. If DMO is damaged, then a boot can be performed on DM2, after which DMO can be formatted and DM2 can be copied to DMO using the RT-11 COPY/BOOT option.

Despite the existence of DM2 as an on-line backup, both DMO and DM1 should be periodically backed up onto magnetic tape. This can be done simply using the COPY command as follows:

```
COPY DMO: MT:
COPY DM1: MT:
```

When the system is booted (per the operators manual), DMO is assigned as SY (the system device) and DM1 is assigned as DK (the user/data device). References to logos are therefore automatically routed to DM1 and all software accesses are directed to DMO.

Overlay structure

The LSI-11 has only a 32-kword address space. The GCS software, if run contiguously would occupy approximately 50 kwords. To overcome the memory limitations of the LSI, the program is divided into modules and overlaid, as depicted in figure A-3.

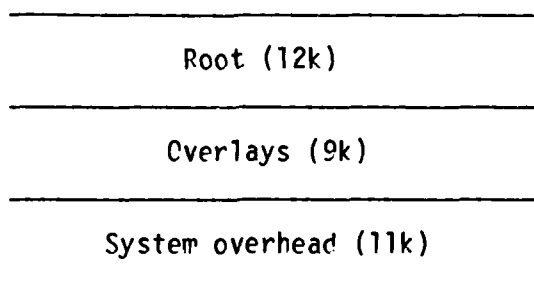

Figure A-3. GCS software overlay structure.

The FORTRAN program TMENU is the main (executive) program which controls the access to all other functions within the GCS. Together with portions of several program libraries, this program constitutes a root module in the overlay structure. The root consists of the main routine, shared data structures, and library routines which are common to at least two subroutines occupying the overlay region. The overlay region is occupied at any one time by one of the seven main subroutines that comprise the GCS software. The remaining 11 kwords are devoted to Foreground/Background system overhead. (For a detailed memory map see the RT-11 Software Support Manual.)

The Single Job Monitor was not selected because its set of system library routines is limited as compared to that of the Foreground/Background Monitor or the Extended Memory Monitor. The Foreground/Background Monitor was chosen over the Extended Memory Monitor because it uses less memory.

Languages

As mentioned, the majority of the software has been written in P1-11

FORTTRAN IV. Low-level device interface routines are written in MACPO. Two routines (automatic editing and automatic thinning) were written in 6502 assembly language, to be executed directly by the AED graphics terminal processor.

DATA STRUCTURES

In order to maintain information about the status of various components of the subsystem hardware and software, data structures have been designed into the GCS software. These structures are accessed by the appropriate major routines via calls to subroutines which access the data structures directly.

Data files maintained on the system disk have been structured to minimize the time required to transfer images to and from the AED image memory. At the same time, an attempt has been made to minimize the space required on the disk. However, this has taken second priority to the transfer time.

Data Tables

By masking certain bits within each pixel in the AED, eight different image planes can be accessed independently. This utility is used by the GCS software to store menus on bit planes 5 through 8 and to manipulate images on bit planes 1 through 4.

To facilitate zooming, panning, and switching between bit planes, a table of values (implemented in FOPTPAN) is maintained to keep track of such items as which bit plane is currently in use, to where on the screen the image has been panned, and to what zoom level that particular image plane has been set. This table of values is kept hidden from the main routine and is accessed by calls to a library of routines devoted to bit plane manipulation. A table entry appears as shown in figure A-4.

1	2	3	4	5	6	7
---	---	---	---	---	---	---

Where:

- 1 is the set color value (for text, lines, etc.)
- 2 is the write mask value
- 3 is the read mask value
- 4 is the 'X' origin register (for panning purposes)
- 5 is the 'Y' origin register
- 6 is the 'X' zoom register
- 7 is the 'Y' zoom register

Figure A-4. Image plane data table organization.

There is a total of ten such entries in the table: one for each of the eight bit planes, one to display bit planes 1 through 4 (the image planes), and one to display all eight bit planes (for diagnostic purposes).

Another table of values, these global, constitutes the dimension values of the current image being processed. The default values are 464 by 384, but these may be changed either through the variable window option of the acquisition routine or through the retrieval routine. These values are important because the thinning, autoedit, and storage routines all depend on them for proper access of the correct video memory location in the AED 1024.

The last data structure, also global, is a text buffer (dimension 81 by 20). This is used to store the menus and text that are displayed on the AED.

File Structures

Bit-mapped images are stored on and retrieved from any block-replaceable device (e.g., magnetic disk or DECTAPE). The routines that do the image I/O use the more difficult basic synchronous queued I/O instead of the more straightforward FORTRAN OTS I/O because of the tremendous disparity in speed between the two when working with images.

The file is structured in the following manner for both speed and programming considerations. The first block in the file is the header containing the dimensions of the image. These dimensions are used in deblocking the image upon retrieval. Subsequent blocks, in multiples of 16, contain an integer number of raster scans of the image in bit-mapped form. For example, the standard-size image has a raster scan length of 624 pels, or 39 words. A set of 16 blocks contains 4096 words, so it will thus hold 105 raster scans with 1 word remaining. This remainder is not used, resulting in 1.0/4096, or 0.02%, wasted space. The upper bound on wasted space is a possible raster scan of 1024 pels, or 64 words, divided by 4096, giving a result of 1.5%. This is not significant, considering the concern is more with speed of storage and retrieval than with space requirements.

SOFTWARE DEVICE DRIVERS

The LSI-11 communicates with two devices not supported by the RT-11 operating system: the AED graphics terminal and the Datacopy framestore memory. Communication with the AED is done almost exclusively through two routines: OPYTE (for out byte) and IBYTE (for in byte). OPYTE passes function calls (in mnemonic form) and data to the AED firmware. IBYTE passes data back from the AED to the calling program. A few of the MACRO-11 subroutines contain their own data transfer subroutines for the sake of simplicity.

Communication with the Datacopy framestore memory is through a fixed set of I/O registers. Because the framestore memory has no processor,

communication is limited to reading and writing to fixed memory locations within the framestore. Two routines (written in LSI-11 MACPO) that facilitate reading and writing are PPX (read pel) and WPX (write pel), but unlike OPYTE and IBYTE for the AED they are not used quite as extensively for input and output.

PROGRAM MODULES

This section comprises brief descriptions of the software operation from a programmer's point of view. The preliminary version of this documentation included operational descriptions of each of the GCS functions. Because an operators manual is provided as a separate document, these descriptions have been deleted here, except for very general statements about the use of the functions. This deletion obviates the necessity of maintaining two separate documents covering functional descriptions. The maintenance programmer should, however, be familiar with the descriptions provided in the operators manual.

In most cases, rather than completely describing program operation in the main text, references are made to subroutines documented in the operators manual. This is done to separate the overall operational descriptions from the more detailed program flow descriptions.

The TMENU routine first sets the standard window size to 464 by 384 pels. Routine SETUP is called to initialize both the color lockup table and the array TABLE. TABLE is the set of values that controls zoom, pan, read, write, and text color for each bit plane. Lastly, the main menu is presented to the user, and the routine loops continuously, calling the desired subfunctions until the user chooses to exit the program. Upon exiting, the AFD terminal is set to bit plane 2 and bit planes 1 through 8 are erased.

After initialization, the operator is presented with the main menu, from which a general functional category can be selected. The main menu appears as the root in figure A-5. Entering a number causes a subroutine overlay to be appended to the root program in the overlay area within the processor memory. A brief description of each of the routines follows.

Acquisition

The acquisition routine has two primary functions. First, it aids in the alignment of images in the Datacopy image memory for display on the Datacopy monitor. Second, and more importantly, it provides for the transfer of images from the Datacopy image memory to the AED image memory where the image can be operated upon for aesthetic improvement.

Execution of the ACQUISITION options assumes that the operator is familiar with the procedure for scanning a document in order to place an image on the Datacopy monitor. This process is described in the hardware section which covers the Datacopy hardware. (See also, AEDIN in the operators manual.)

GRAPHICS CONVERSION SUBSYSTEM

- 0. ACQUISITION
- 1. KEYBOARD EDIT
- 2. TABLET EDIT
- 3. THIN
- 4. STORE
- 5. RETRIEVE
- 6. FORMAT FOR HP
- 7. DIRECTORY
- 8. HELP
- 9. EXIT GCS

Enter the number of your choice:

Figure A-5. Main GCS operational menu.

Alignment. Selection of the alignment option from the ACQUISITION menu causes a crosshair cursor to appear on the Datacopy screen. This allows the operator to visually sight the image on the Datacopy monitor in order to determine the quality of the image alignment on the copy stand. The image may be realigned and rescanned as many times as necessary until the operator is satisfied with the alignment and threshold setting. (See, also, ALIGN in the operators manual.)

Image transfer. Following alignment, the next logical step is to transfer an appropriate portion of the image from the Datacopy memory to the AED image memory for processing. This is accomplished by executing the second option in the ACQUISITION functions menu. This transfer can utilize either a fixed-size window (image segment) or a variable-size window.

A fixed-size window represents an original document segment of 464 by 384 pels, (approximately 3 by 2 inches), whereas a variable-size window can be of any size up to 1024 by 1024 pels. After choosing the fixed-size option, a window of the appropriate dimensions appears over the image on the Datacopy monitor. By means of the arrow keys on the AED keyboard, the window can be placed over any part of the image. By simply pressing RETURN, that portion of the image within the window will be transferred to the AED image memory and displayed on the AED monitor.

Choosing the variable-size option of the menu causes a cursor to appear on the Datacopy monitor. The cursor can be moved anywhere on the screen and "anchored." Moving the cursor again causes a "rubberband" box to trace out a window of arbitrary dimensions. The corner of the window being moved can be toggled to simplify the segment selection process. After anchoring the cursor again, the operator can transfer the contents of the window to the AED. (See, also, TRANSFR in the operators manual.)

Keyboard Editing

Editing is the most comprehensive of the functions presented by the program. In fact, the editing functions require two separate main menu options (keyboard and tablet editing) due to the amount of software necessary to provide the required functionality. Although separate, because of their similarities, they will be discussed as components of one function.

To edit an image on the AED graphics terminal the image must be acquired either by means of the transfer function described in the previous subsection or by recalling an image from disk. Upon selection of the editing option, the operator is presented with an appropriate menu. The keyboard editing functions provide for gross alterations of the image, such as filling

large areas with either black or white, as well as invoking an autoedit function. The tablet editing function provides for finer controlled editing using a "paintbrush" approach.

The autoedit function is a 6502 assembly language program which runs directly on the AED microprocessor and can be used to automatically smooth edges of lines and characters by deleting preprogrammed 1- and 2-pel bumps and holes. In addition, it will automatically eliminate pels not adjacent to any others of like color (typically indicative of noise). (See, also, AEDEDT and AEDET in the operators manual.)

The autoediting program that is loaded into the AED was written in 6502 assembly language, using the editor on the RT-11 system. It was then assembled with a cross-assembler, and the object code generated was ASCII hexadecimal. The program AEDET reads the ASCII hex, converts it to binary hex (subroutine CONVHD), loads the binary hex program (AED firmware routine LMR), and then tells the 6502 processor where to jump to execute the code (JUS2). While the AED processor is busy, the AEDET routine returns control back to TMENU. TMENU polls the AED, waiting for the autoediting routine to finish before continuing.

Thinning

Because of the characteristic of most impact or pressure-fusing printers that causes pel diameter to exceed pel spacing, it was decided to provide a "thinning" routine to reduce the overall "blackness" of a logo. The thinning algorithm essentially consists of a 3- by 3-pel window which is passed over the digitized logo image, stripping off a layer of black pels according to a predetermined set of rules. The resultant thinned image has a lower density of black pels, which should compensate for the pel spread at print time.

The thinning function is a 6502 assembly language program which runs directly on the AED microprocessor that is downloaded into the AED memory at run time. Run time is a function of the number of black pixels. A moderately detailed picture takes approximately 35 seconds to thin.

The thinning routine can also be used to "thicken" an image for any printer which "prints" white pels rather than black pels. To "thicken" an image, the thinning algorithm can be invoked upon the negative of the image. The negative of the image can be obtained in a matter of seconds from the BOX routine of the edit function. After thinning the negative, the image is inverted again. Instead of a layer of black pels being removed, a layer of white pels is removed, i.e., a layer of black pels is added.

The program that is loaded into the AED was written in 6502 assembly language using the editor on the RT-11 system. It was then assembled with a cross-assembler and the object code generated was ASCII hexadecimal. The program THIN reads the ASCII hex, converts it to binary hex (subroutine CONVHD), loads the binary hex program (AED firmware routine LMR), and then

tells the 6502 processor where to jump to execute the code (JUS2). While the AED processor is busy, the THIN routine returns control back to TMENU. TMENU polls the AED, waiting for the thinning routine to finish before continuing. (See, also, THIN in the operators manual.)

Storage

The image store function allows storage on disk of either an original (possibly edited) version or a thinned version of a logo. The original image is stored in bit plane 1. This is the copy of the image which is normally processed by the edit functions. After thinning, the original image remains unaltered in bit plane 1, while a thinned copy is placed in bit plane 2. It is therefore necessary to indicate to the program which version of the image is to be stored on disk. After selection, the routine requests a file name for the image to be stored. A bit-mapped copy of the image is then written to disk (see previous subsection on file structures). Storage time for the standard-size image (496 by 624 pels) is approximately 15 seconds. (See, also, STORIT in the operators manual.)

Retrieval

The retrieval function is simply the inverse of the storage function. Either an edited version or a thinned version of the image can be retrieved. After choosing the image type, the routine requests input of the file name under which the image is stored. Retrieval takes approximately 10 seconds for a standard-size image. (See, also, RETRV in the operators manual.)

Output Formatting

The output formatting routine is used to provide nine-track magnetic tape compatible with the HP 2685 computer/laser printer system. As the PT-11 system typically writes everything in 512-byte blocks, the formatting for the HP system defaults automatically to a 512-byte block size. Record size is a power of two so that an even number of raster scans will fit into each block. For instance, in the standard window size (464 by 384 pels) each raster scan of 384 pels is elongated to a size of 512 pels by appending 128 null bytes to it.

Directory

The directory routine searches the default data disk (DK:) for files with descriptors .CPG or .THN. The file listing is placed on the AED screen for perusal. Information included with the file name consists of the file size, its creation date, and its protection status. The default data disk can be set to any directory-structured device, typically disk drives (magtapes do not qualify) through the PT-11 operating system prior to running of the GCS

software routines. For example, to make disk drive DM1: the default (which it normally is), you would type "ASSIGN DM1: DK:" at the system console. Whenever the system looks for specific image files or writes specific image files, it looks to the default data disk.

Operational Assistance

Limited operational assistance can be obtained by use of the HELP function while executing the main menu. Upon selection of the help option, the main HELP menu appears on the AED display. The HELP function provides basic instructions on the use and operation of the selected operation.

APPENDIX B

THE DATACOPY CAMERA AS THE GRAPHICS
CONVERSION SUBSYSTEM INPUT

LA Wise and FC Martin

27 January 1984

APPENDIX B CONTENTS

TECHNICAL ASSESSMENT . . .	Page B-3
Background . . .	P-3
Discussion . . .	B-3
DATACOPY CAMERA MODIFICATIONS . . .	B-7
Introduction . . .	B-7
Centering Circuit . . .	B-7
Focusing Circuit . . .	B-11
CAMERA FOCUSING PROCEDURE . . .	B-11
Sequence of Operator Steps . . .	B-17
SUMMARY . . .	B-19

APPENDIX B ILLUSTRATIONS

B-1. Infrared filter characteristics . . .	Page B-4
B-2. Oscilloscope waveforms of Datacopy camera video . . .	B-6
B-3. Centering circuit assembly . . .	B-9
B-4. Centering circuit schematic diagram . . .	B-10
B-5. Focusing circuit schematic diagram . . .	B-12
B-6. Imager video waveform showing clipping point . . .	B-13
B-7. Remote control panel . . .	B-14
B-8. Graph of camera height vs. resolution . . .	B-16

APPENDIX B TABLES

B-1. Resolution selection chart . . .	Page B-8
B-2. Datacopy camera focusing chart . . .	B-18

TECHNICAL ASSESSMENT

BACKGROUND

A suite of equipment to be used as a candidate Graphics Conversion Subsystem input has been procured at NOSC from Datacopy Corporation, Palo Alto, CA. This equipment is identical to equipment now being used at the USPS R & D Engineering Support Center, Rockville, MD, for a study of digitization of graphics inputs for incorporation with text information onto Electronic Computer Originated Mail (E-COM) messages in an experimental test-bed.

The equipment includes the following units:

Electronic Camera	Model C322
Image Processing Unit	Model I340
Storage and Display System	
Logic Unit	Model B521
Monitor Unit	Model D515

The equipment is now interconnected with the camera mounted on a Bencher Model 132-31 Copy Stand. For the acquisition of graphics from opaque copy, the copy stand is equipped with two small quartz iodide incandescent lamps. The Bencher has a back-lighted ground glass easel for use with transparencies. The camera is equipped with a flat-field Nikon 55 mm, f 3.5 Micro Nikkor lens.

DISCUSSION

Informal qualitative tests of the system have been performed, and bilevel monochrome samples from monochrome and color images have been acquired. Digitized samples made from the NOSC logo, which is primarily blue and red, indicate a strong sensitivity to red spectral components. An IR filter was procured for the unit from Datacopy. This filter modified the spectral response of the acquisition chain to the extent that acceptable monochrome replicas of the NOSC logo may be acquired. The response of the equipment is appreciably different from that of an Optical Coating Labs, Inc. (OCLI) hot mirror. Because of these differences, the spectral passbands of the Datacopy filter and the OCLI hot mirror were measured and plotted. The results are shown in figure B-1. The curves indicate that the Datacopy filter is composed of a heat-absorbing glass whose attenuation of longer wavelengths increases gradually, starting at about 600 nm. The OCLI filter, which uses quarter-wave optical coatings to reflect the longer wavelengths, provides a more uniform response in the passband, and then sharply increases the attenuation. The Datacopy filter is probably adequate for our monochrome application, but the resolution of the lens to wideband spectral sensitivity may be reduced to a small extent. A test was run using the Wratten 52 green filter and the

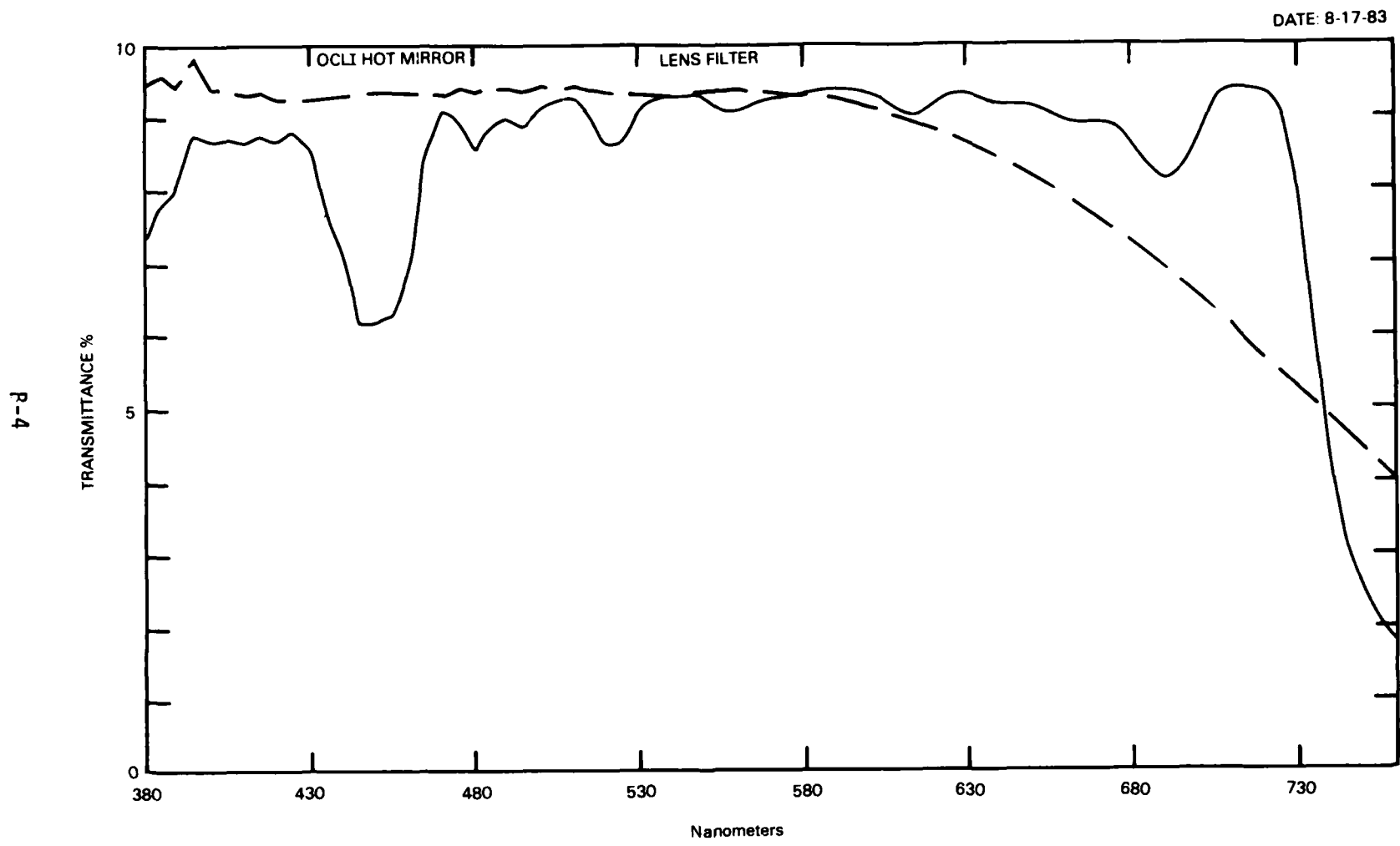

Figure B-1. Infrared filter characteristics.

Datacopy IR filter. The Bencher copy stand did not produce sufficient illumination to generate enough incoming video signal so that possible improvements in the lens resolution with narrowband illumination could be analyzed.

To evaluate the amplitude and quality of the video, a tap was added to the camera unit video circuit. The exact location of the tap is at test point TP-1 which is shown on figure 6, the video converter board (dwg. 4501095), in the Datacopy Model C322 Camera reference manual. The connection was made with a series 100-ohm resistor to a short length of RG 59 coaxial cable. Scope traces taken from the Textronix 7844 oscilloscope can be used to show several important parameters of the video signal. These are:

- Video amplitude
- Video rise time
- Response uniformity

In the camera, video at test point TP-1 is presented to a TRW Model TDC1001J successive-approximation analog-to-digital converter. The full-scale range of this converter with standard reference voltages is 0.0 volts (binary 0) to -0.5 volts (full scale, binary 255). With the proper illumination intensity and iris setting, the dynamic range of the video signal at TP-1 should approach but not saturate (exceed) both of these limits. The lens iris should be adjusted so that the peak-to-peak video amplitude with a good black-and-white target is approximately 0.5 volts. Figure B-2 (a) shows the video response across one line of scan with the dynamic range properly adjusted. The scope trace for one line of scan should cover approximately 864 μ s.

The Datacopy camera acquires an image by mechanically moving a charge coupled device (CCD) line scanner across the image plane. Exactly 2200 imagery lines having 1728 pels per line are taken in a period of about 2.5 seconds. Analog video is available at TP-1 at a rate of 2 Mpels per second.

When the camera is not capturing an image, the CCD sensor is at rest at a position ready to capture the top of a page. The CCD is being clocked and is sensing data on a fixed line even though it is not traversing down the page image plane. By using a test target having high-spatial-frequency vertical black and white bars, this output video is available for establishing focus. If a good-contrast target such as the IEEE facsimile test chart is properly positioned, the rise time of the acquired video can be observed on the scope. By adjusting the focus of the lens, the position for minimum rise time can be found. Once the focus and intensity have been established, the scanning resolution for a particular camera height can be determined.

Spatial resolution of the camera setup can be checked by using a test target having a series of vertical lines evenly spaced at 1-inch intervals. By observing the location of these line responses on the scope graticule, the scanning resolution can be determined as shown in figure B-2 (a).

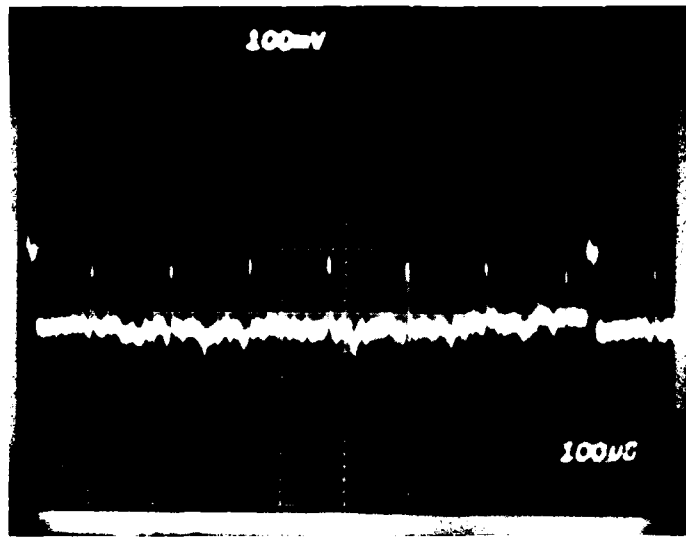

(a). One video line from the Datacopy camera.

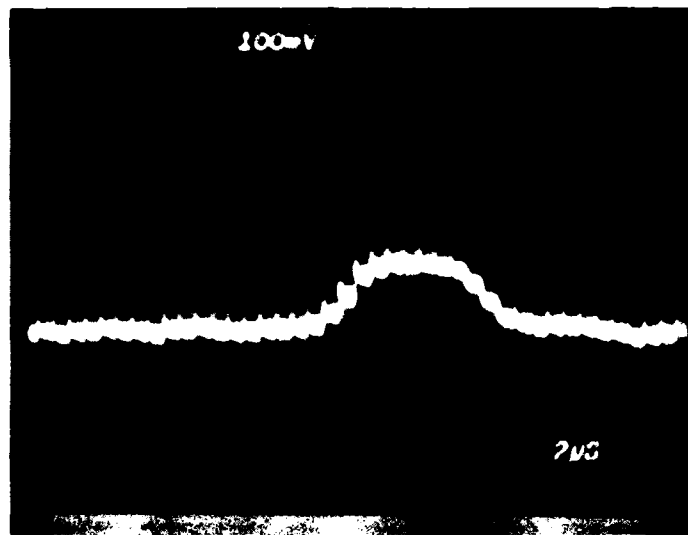

(b). Magnified Datacopy video.

Figure B-2. Oscilloscope waveforms of Datacopy camera video.

Based on the CCD output rate of 2 Mpels per second, the number of microseconds between two 1-inch target lines can be calculated. In order to keep setup complexity for the operator to a minimum, it is preferable not to change the basic sweep rate of the oscilloscope when establishing scanning resolution. A highly magnified waveform of one of the 1-inch marks is shown in figure B-2 (b). This resolution is not necessary to optimize focus. Since a scan line time is 864 μ s, a fixed sweep rate of 100 μ s per cm (1000 μ s, total), which shows an entire scan line, is recommended. The trace shown in figure B-2 (a) was taken using this sweep rate. The end of a sweep line can be seen at 864 μ s. The trace also shows the five 1-inch-interval lines in 600 μ s. This indicates that the camera was set for 240 by 240 pels per inch scanning resolution when the trace was recorded. Table B-1 shows approximate camera heights for various scan resolutions and the proper number of microseconds for a set of 1-inch target lines.

DATACOPY CAMERA MODIFICATIONS

INTRODUCTION

This section describes the modifications which were incorporated into the Datacopy cameras at both NOSC and the USPS Engineering Support Center. The modifications include a remote control panel, which was permanently affixed to the Bencher copy stand, a focus indicator circuit, and an imager centering circuit. The operation of all these circuits and controls is described. The procedures for focusing will be discussed in the next section.

CENTERING CIRCUIT

The centering circuit allows the imager to be centered in the field of view so that the lens may be focused while viewing a test target in the center of the copy stand. Without this, lens focus adjustment would be impossible for certain lens and camera height combinations since the imager would be imaging areas off the copy stand with the imager at its "home" position.

The centering circuit is installed on the camera's interface board. Figures 14 and 15 in Section 9 of the reference manual for the Model C322 electronic camera show the schematic and assembly drawings for the interface board. The interface board contains two spare IC positions. Since the centering circuit requires four ICs, a small copperclad board was used for the circuitry and attached to the camera interface board using a standard 16-pin component carrier. Figure B-3 shows the centering circuit assembly. P1 is the carrier which plugs into one of the spare IC positions on the interface board and to which the centering circuit board is soldered. Figure B-4 shows the centering circuit schematic. The two camera signals used by the centering circuit are -FEM and -SEN, frame enable and scan enable, respectively. They are available on the interface board and are routed onto the centering circuit board via the spare IC socket. Refer to table 2-1 and figures 2-5 and 2-6 in the camera reference manual for a complete description of the two signals.

Pels Per Inch	Approx. Camera Height, cm*	No. of 1-inch Target Lines	Oscilloscope Time to Scan Target Lines, μ s	Printer Usage
60	**	10	300	Printronix horizontal
72	**	10	360	Printronix vertical
114	101.6	10	360	
120	93.3	10	600	Printronix horizontal
144	80.0	10	720	Datagraphix vertical
180	65.4	9	810	HP horizontal & vertical Datagraphix vertical
200	60.1	8	800	ICAS "standard"
240	50.0	5	600	Delphax horiz. & vert.
388	35	5		
472	30	5		
993	20	5		

Notes: * The heights given here are from the easel to the face of the lens mount on the camera. Heights shown on the copy stand scale are dependent on camera mounting method and manipulators placed on the easel.

** These resolutions are not attainable on the Bencher copy stand with a 55 mm lens. They can be obtained with 28 mm or 24 mm lenses, but the resulting images will have some geometric distortion.

Table B-1. Resolution selection chart.

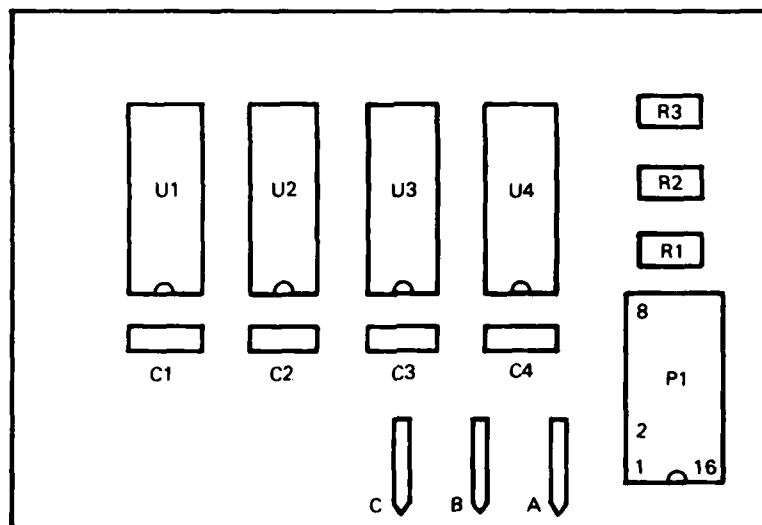

Figure B-3. Centering circuit assembly.

In the centering circuit, IC U1 is a 12-stage CMOS counter that is used to count lines during an image scan. -FEN is used to clear the counter before each scan and to enable -SEN to clock the counter during the scan. Counter outputs Q4, Q7, and Q11 are decoded to provide a pulse output at a line count of 1196. This pulse appears at the output of the four-input NAND gate (part of U3) on every scan. The 10-k pull-up resistors and the six 74L04 inverters are required to properly interface the CMOS counter to TTL logic. The centering circuit switch located in the remote control panel is used to enable or disable the -SCANSTOP signal from resetting the motor enable flip-flop on the motor and sequence control board in the camera. The schematic for this board is in figure 8a, sheet 3, in the reference manual. The motor enable flip-flop is labeled 4R-2. Pin 13 of this flip-flop was isolated from the pull-up resistor P12. A wire was then soldered onto the card at pin 13 and routed to pin A of the centering circuit board containing the -SCANSTOP signal.

FOCUSING CIRCUIT

Since the Datacopy Model C322 camera does not provide a real-time grey scale display of the image, there is no convenient way of focusing the lens without additional hardware. A focusing circuit has been designed and incorporated into the camera to provide an indication of optimum focus using a standard analog meter movement.

The focusing circuit schematic diagram is shown in figure B-5. The sampled video input to the circuit is taken from the video converter board in the camera (refer to figure 6 in the reference manual). The sampled video signal is taken off the board via 75-ohm coaxial cable to minimize noise pickup. The focus circuit board is physically connected to the I/O Board in the camera (reference manual figures 16 and 17). The power for the board is obtained from the +/- 15-volt power supply and analog ground lines on the I/O board. The FET amplifier, Q1, is used to provide video signal gain with a high input impedance to avoid excessive loading of the sampled video signal. The output of the first stage is AC-coupled into a common base amplifier, Q2. The bias on this transistor is adjustable to allow the clipping of the negative-going spikes in the video, which occur during the horizontal "retrace time" of the imager. Without clipping of these spikes, a false reading is obtained on the focus meter. A simple drawing of the video waveform is shown in figure B-6 indicating the portion of the video waveform that is clipped.

The output of the second-stage amplifier is input to the filter circuit via an emitter-follower, Q3. The high-pass filter, consisting of the 180-pF capacitor and 2.4-k resistor, has approximately a 400-kHz cutoff frequency, passing all frequencies above the cutoff. This signal is then DC-rectified, filtered, and output to a 10-microamp meter movement. The meter has a 100k-ohm potentiometer in parallel with it to allow adjustment of the meter sensitivity in case the meter reading goes off scale.

There are two adjustments on the focus circuit itself: gain and clipping level. The gain adjustment should be left on its maximum setting unless the sensitivity control on the remote control panel does not have enough range. If that happens the gain may be reduced. The clipping adjustment should be made with the lens cap on so that no light reaches the imager. Adjust the control to provide a meter reading of approximately 10% of full scale.

CAMERA FOCUSING PROCEDURE

Refer to figure B-7 for a layout of the remote control panel to be used for all future camera operations (the commands issued from the HP computer still may be used). The remote control panel contains the threshold control and CLEAR switch which previously were mounted on the Datacopy frame store memory front panel. New controls include the SCAN push button, centering circuit switch, focus meter sensitivity control and the focus meter itself. These controls are now all centrally located in a box which mounts on the Rencher copy stand so that the operator may perform all setup and scanning operations from one location, at the copy stand.

B-12

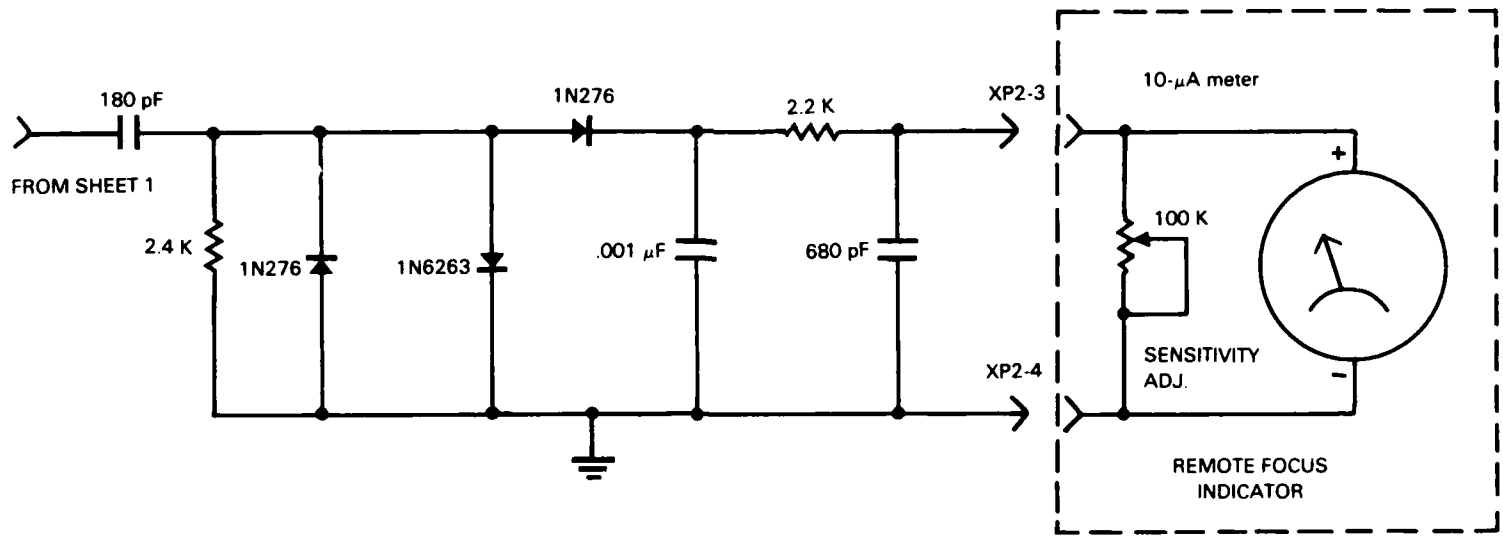

Figure B-5. Focusing circuit schematic diagram.

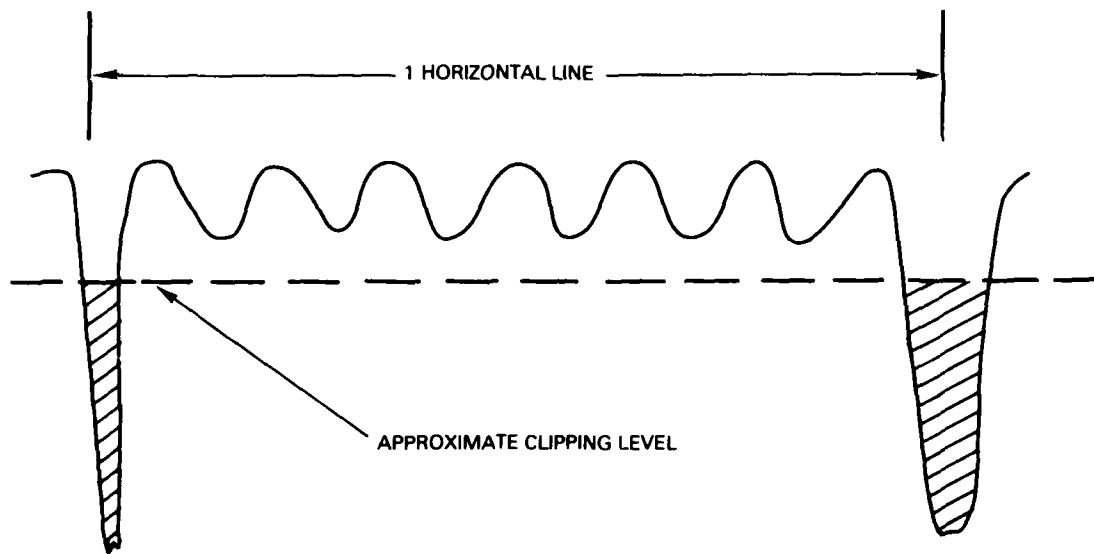

Figure B-6. Imager video waveform showing clipping point.

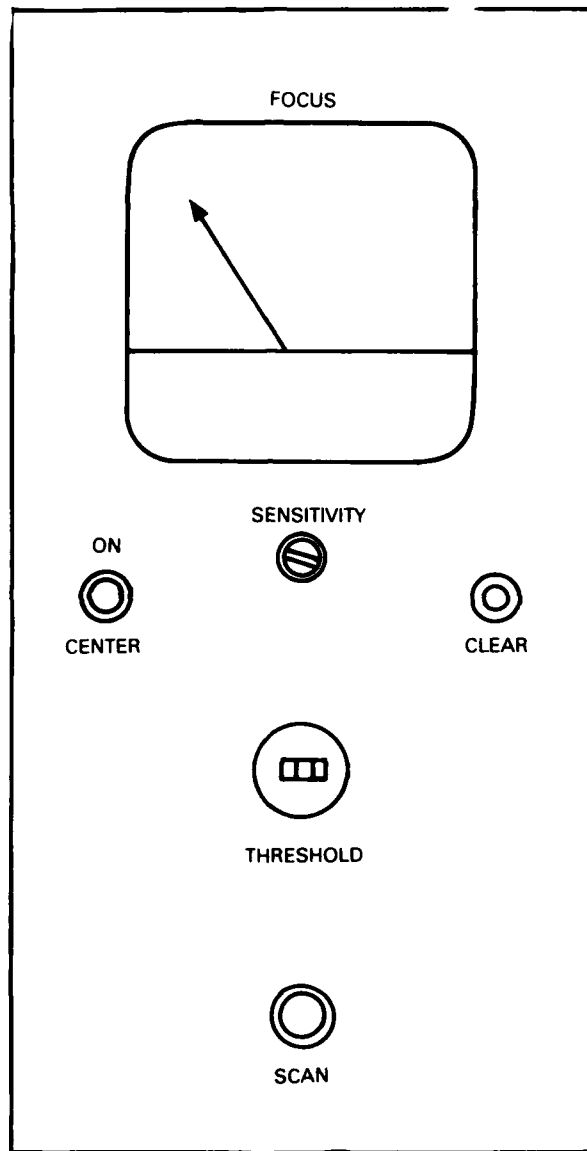

Figure B-7. Remote control panel.

The following procedure may be used to focus the camera:

a. Place a suitable test target (with fine black and white lines) on the copy stand so that the resultant image will show the lines running vertically on the display and so that the test pattern is centered in the camera field of view, i.e., centered on the copy stand.

b. To center the imager in the field of view, turn the centering circuit switch on and then press the SCAN button. This will cause the camera to scan halfway through the image and stop. The display will show half the image and will blank the lower half of the display. The last visible line scanned should contain a portion of the vertical test pattern.

c. Open the lens to its largest aperture and slowly adjust the lens focus while observing the focus meter deflection. If the deflection goes off scale, the focus meter sensitivity adjustment directly below the meter may be used to lower the reading on the meter. Optimum focus will be achieved when the meter deflection is maximized. After reaching the optimum focus, return the lens aperture to its normal setting (F5.6 is the optimum setting, providing the maximum lens MTF).

d. After focusing the lens, turn the centering circuit switch off and press the SCAN button. This will also cause half an image to be stored in the display. The imager is now at its rest position and is ready to commence normal scanning operations. Note that if the centering circuit switch is not turned off, scan operations will either scan half an image or possibly only a few lines with the rest of the display being blanked. Turning off the centering circuit switch and pressing the SCAN button once will restore the imager to its normal operation in any case.

SEQUENCE OF OPERATOR STEPS

Setup and operation of the Datacopy camera appears to be relatively simple. No major man-machine obstacles are apparent to prevent rapid familiarity with the equipment, and a reasonably high acquisition rate of camera-ready copy, regardless of the variations of the scale changes of the customer furnished imagery originals. Steps for the operator might be sequenced as follows:

1. Power up work station electronics.
2. Turn on copy stand lights.
3. Set camera height for scan resolution required as shown in table B-2.
4. Remove camera lens cap.
5. Place focus target centered on camera field of view.

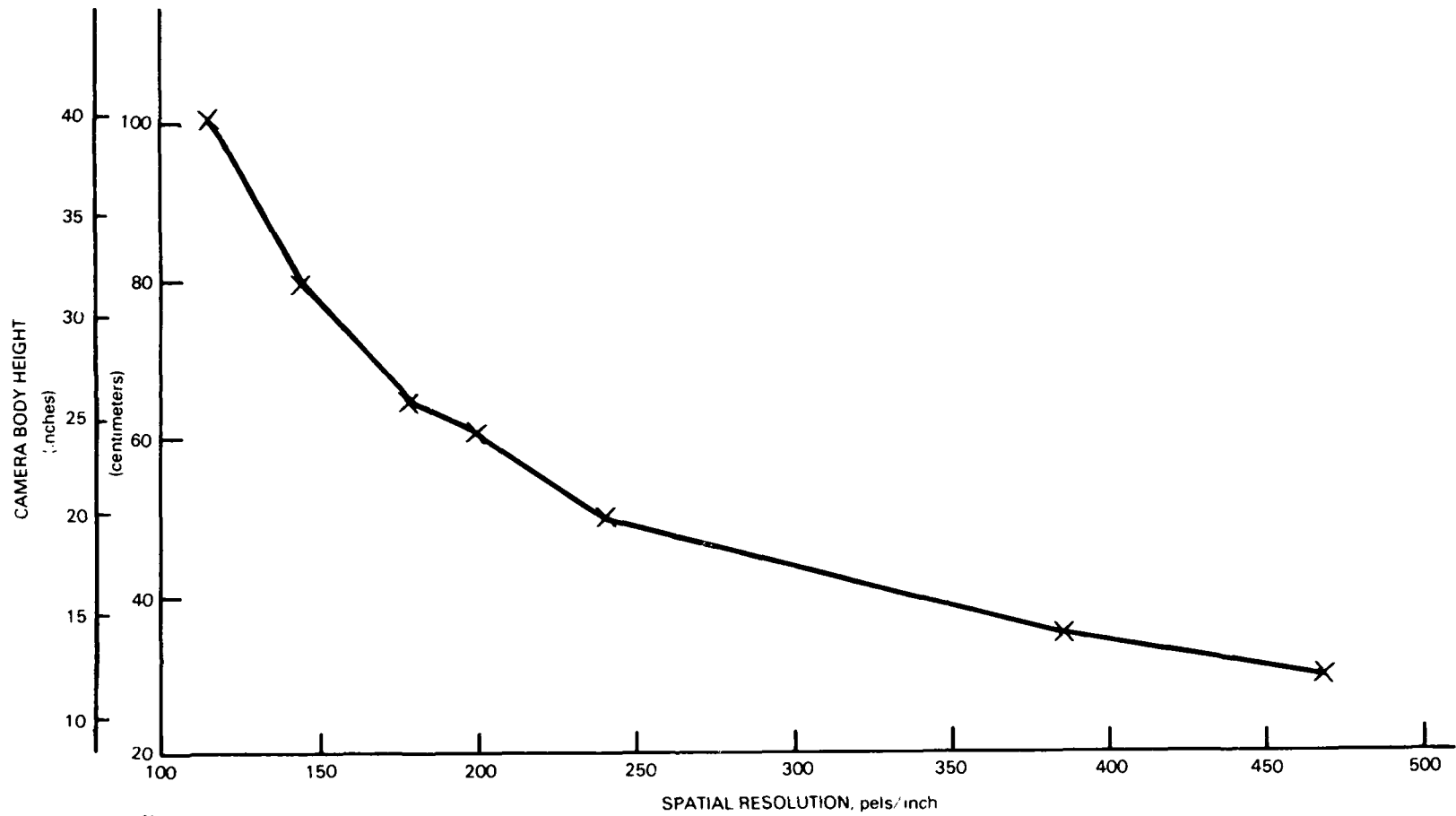

Notes:

Heights are for 55 millimeter Nikor-Micro F3.5 lens

Heights are for distance from easel to lens mount face of camera

Figure B-8. Graph of camera height vs. resolution.

6. Open lens iris to f 3.5.
7. In focus scan mode (toggle switch up), capture, store and display the test target image.
8. Rotate lens focus control for maximum focus meter deflection.
9. Observe image of test pattern on Datacopy monitor.
10. Check for proper centering and orientation of focus chart. (Only upper half of image should be displayed).
11. Adjust threshold selector for good contrast and equal width white and black vertical stripes of test image area and repeat steps 6 through 10 until displayed image looks good.
12. Stop lens aperture down to f 5.6 (assuming Polaroid filters not used).
13. Replace test image with logo master to be digitized on copy stand.
14. Revert to normal scan mode (toggle switch down) and capture full-page logo image.
14. Observe Datacopy display, checking carefully for image tilt.
15. Use easel micropositioner to rotate and translate image for best orientation of vertical and horizontal edges of logo.
16. Using touch tablet and display software, define top, bottom, and sides of desired cropped logo area.
17. Using keyboard, transfer cropped subset of logo image to the AFD display memory.
18. Using the tablet, roam over the image, inspecting edges for bumps and dents in the black/white boundaries.
19. Make a judgement decision whether, with minor cosmetic repairs, the image can be used as the final master or whether the image should be repositioned and rescanned.
20. Verify the scan resolution achieved vs. that which was desired.
21. If unsatisfactory, reset camera height and repeat the entire process, starting at step 5.

		55 mm		28 mm		24 mm		
LENS FOCAL LENGTH								
PRINTER RESOLUTION		240 p/i	180 p/i	240 p/i	180 p/i	240 p/i	180 p/i	
C C O P Y S I Z E	1 X	19.86	25.75	10.11	13.11	8.66	11.24	C A M E R A H E I G H T *
	2 X	37.55	49.34	19.12	25.12	16.38	21.53	
	5 X	90.62	120.1	46.13	61.14	39.54	52.41	

Notes: * The heights given here are from the easel to the face of the lens mount on the camera. Heights shown on the copy stand scale are dependent on camera mounting method and manipulators placed on the easel.

Table B-2. Datacopy camera focusing chart.

SUMMARY

Modifications were successfully made to the Datacopy Model C322 Electronic Camera Unit and the Model B521 Logic Unit. These modifications provided a method for an operator to acquire and verify optimum focus during operation.

The modifications consist of added electronic circuitry which detects, quantifies, and indicates high-spatial-resolution components of captured imagery. The circuits also provide the capability to reposition the sensor in the camera so that the resolution target may be positioned within the center area of the easel.

The modification circuitry was incorporated in two Datacopy camera systems, the one used for tests at NOSC and the unit used at the USPS, Rockville, in the E-COM Engineering Support Center.

APPENDIX C
GRAPHICS CONVERSION ACQUISITION ALTERNATIVES

FC Martin

1 March 1984

APPENDIX C CONTENTS

INTRODUCTION . . .	Page C-3
DISCUSSION . . .	C-3
CONCLUSIONS . . .	C-9

APPENDIX C ILLUSTRATIONS

C-1. Graphics conversion image acquisition alternatives . . .	Page C-4
C-2. Gothic 12-pitch character . . .	C-5
C-3. Example of digitized 5X character . . .	C-6
C-4. Results of minifying 5X character . . .	C-8

INTRODUCTION

Some alternatives for defining standards for the customer hardcopy inputs are worthy of some technical analysis. In the past, we have considered the possible options of restricting inputs to 1X originals, that is, hardcopy artwork having the actual size which the customer wishes to have the document printed on his messages. Alternatives to this 1:1 scale restriction have been considered such as 3X or 5X masters which would be reduced 3:1 or 5:1, respectively, in the optical or digital minification process.

DISCUSSION

The highest priority objective for this study is quality of the final printed image. The next most important goal is high customer acceptance. The third objective is good man-machine interface so that an operator does not require a high level of training in order to produce a reasonable quantity of new image samples per hour. The last goal is simplicity of the Graphics Conversion Subsystem (GCS) work station hardware. Figure C-1 shows three alternative procedural paths for the digitization of imagery data. The path following the right branch from the left-hand initial setup with 1:1 copy is obviously simpler for the work station designer and for the operator. The question remains whether the quality of the digitized image can be improved by following the other paths and, if so, by what measurable amount.

First, we should consider the digital minification advantages and disadvantages. Figure C-2 shows a text character "R" printed from a 12-pitch Gothic font. The character was chosen so that the effects of quantization with respect to a very small area of acquired image can be kept in proper perspective. The dimensions of this character on the printed page are only:

Height:	0.115 inches	27.6 pels at 1/240 inch per pel (use 28 pels)
Width:	0.0625 inches	15.0 pels at 1/240 inch per pel
Thickness:	0.0167 inches	4.0 pels at 1/240 inch per pel

In the figure C-3 example, the results of using 5X copy and setting the graphics conversion work station to digitize at 240 by 240 pels per inch are shown. Because of the large size of the original, we acquire 25 times as many pels to define the character, but the resulting image has excellent edge definition. The quanta now represent 1/1200 inch per pel. If we presented this digital representation to the Delphax printer without modification, the character "P", representing a logo subset, would be printed five times the desired size, which is the same size as the customers input hardcopy. Thus, to be used properly with the Delphax, the image must be minified by a factor of five in both the horizontal and vertical dimensions.

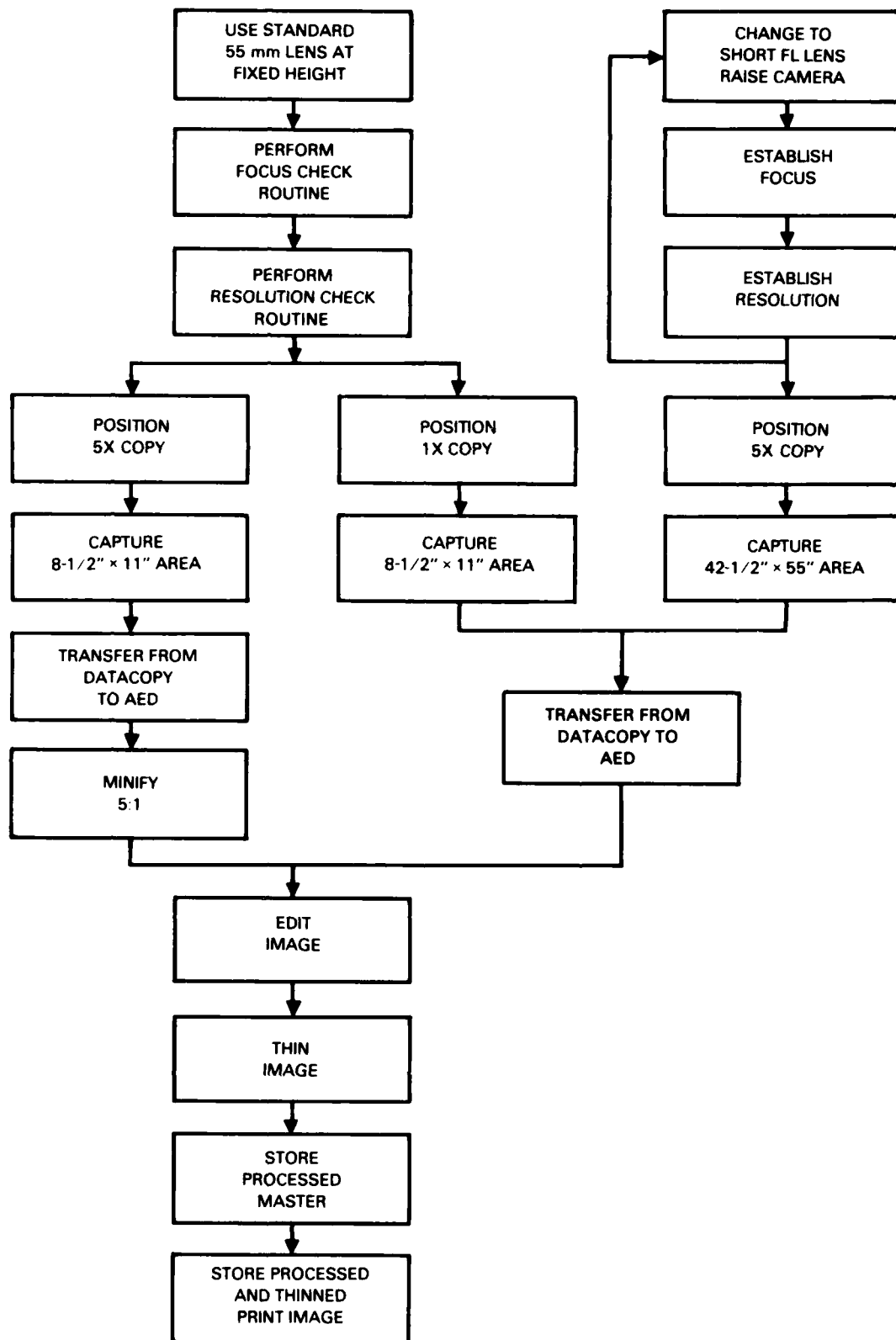

Figure C-1. Graphics conversion image acquisition alternatives.

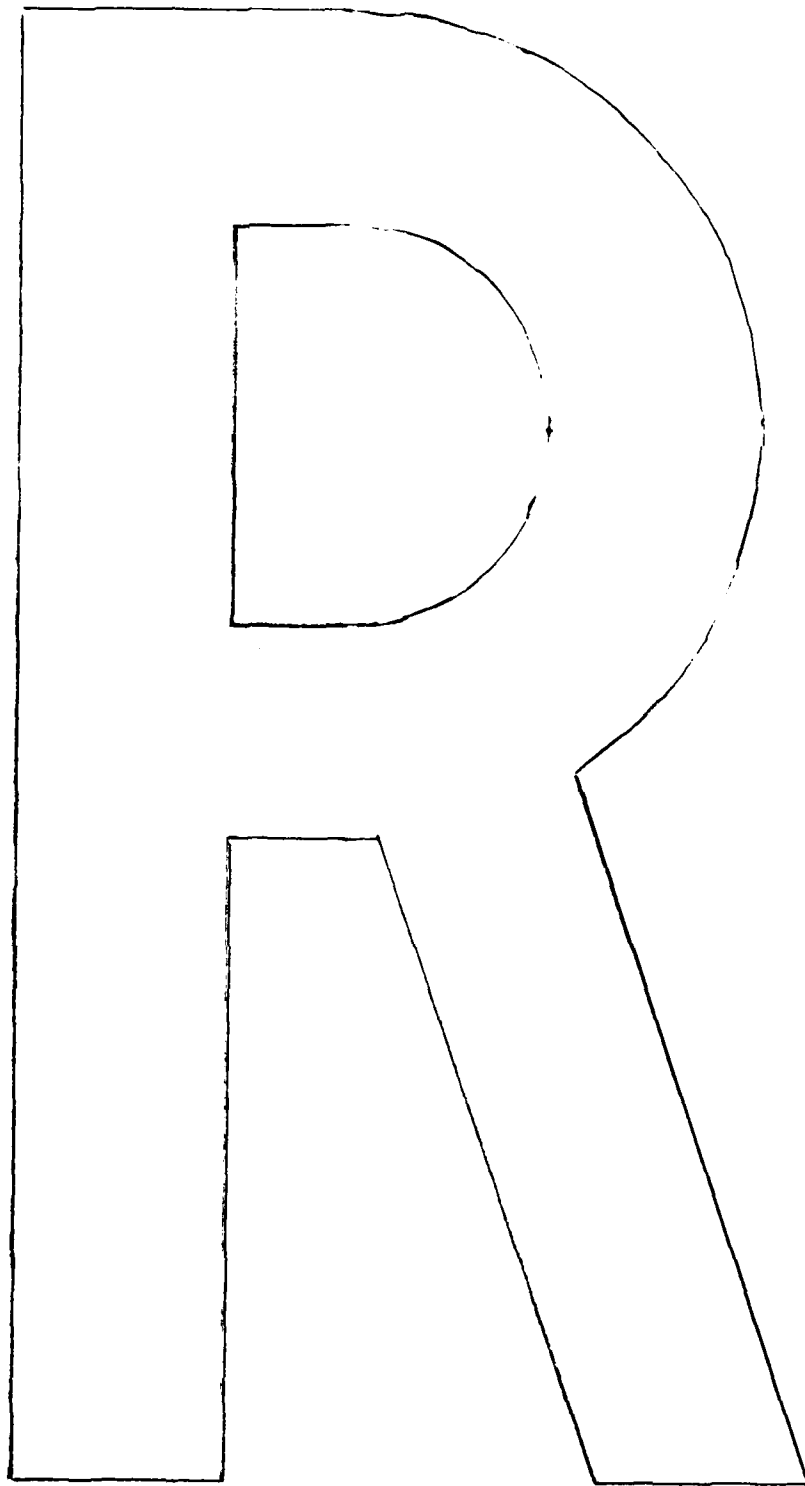

Figure C-2. Gothic 12-pitch character.

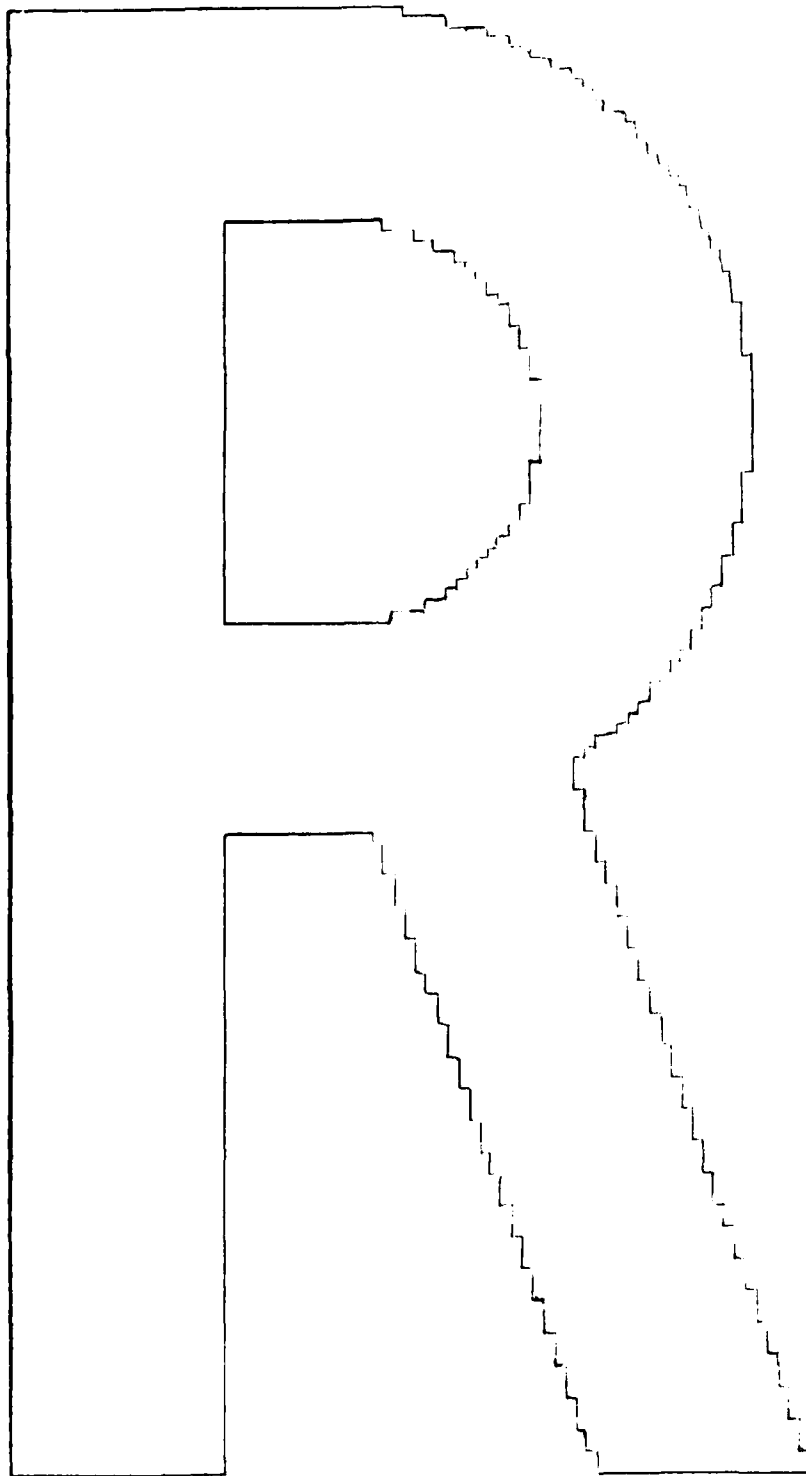

Figure C-3. Example of digitized 5X character.

In the process of minifying, the brightness values of an array (usually square) of M by N pels are summed and normalized by dividing by the number of pels included in order to provide a single-pel brightness value representing the rounded average of the M by N array. In 5- by 5-pel minification, there are 25 independent choices of starting row/column for starting the minification grid. With bilevel images, the value of the minified pel is determined by having a majority of 13 or more source pels either black or white.

Figure C-3 shows the results of minifying our character R with a 5 by 5 minification algorithm. It should be emphasized that several alternate pel patterns might have been generated, depending on which of the 25 candidate starting points were chosen. We should also remember that the consequences of selecting a different starting point on the image are, to the unaided eye, undetectable when printed.

It should be obvious that cosmetic image restoration should not be undertaken before minification. The operator would be dealing with 25 times as many pels. Secondly, the minification process may add or delete desired pels from the printed image. Figure C-3 shows the results in the upper left hand corner of the P. The outside corner matrix failed to contain 13 black source pels. Therefore, the decision process caused the matrix to be changed to white during the minifying process. Also the upper left inside corner was assigned a value of black for the same reason. For all of these reasons, it is desirable to perform the cosmetic repairs only on the 1:1 version just prior to thinning and storing for future printing.

An alternative acquisition process can be achieved by using the same 5X copy. In this case, the operator would raise the camera so that the acquired pel geometry represents scanning at 48 by 48 pels per inch. With this setup, the acquisition and printing process will result in copy having 1:1 dimensions. Spatial resolutions lower than approximately 114 pels per inch cannot be achieved on the present NOSC or USPS Bencher copy stands with a 55 mm lens due to the height excursion limitations of the camera adjustment. With a 28 mm or 24 mm lens, this low resolution may be achievable.

Given that the above premise is correct, the question arises as to why start with 5X copy in the first place.

Only one advantage is apparent. This is with respect to edge blemishes in the customer-furnished copy. If these occur, they may be reproduced at 1:1 scale in the captured image. If the input copy is 5X, the blemishes are reduced 5:1 in the acquired and minified image.

Also we should consider the disadvantages which can be summarized below:

- Must accommodate very large masters if logos are large
- Must procure and use a short focal length flat field lens or extend copy stand pedestal height
- Must relocate the pedestal back from the extended field of view

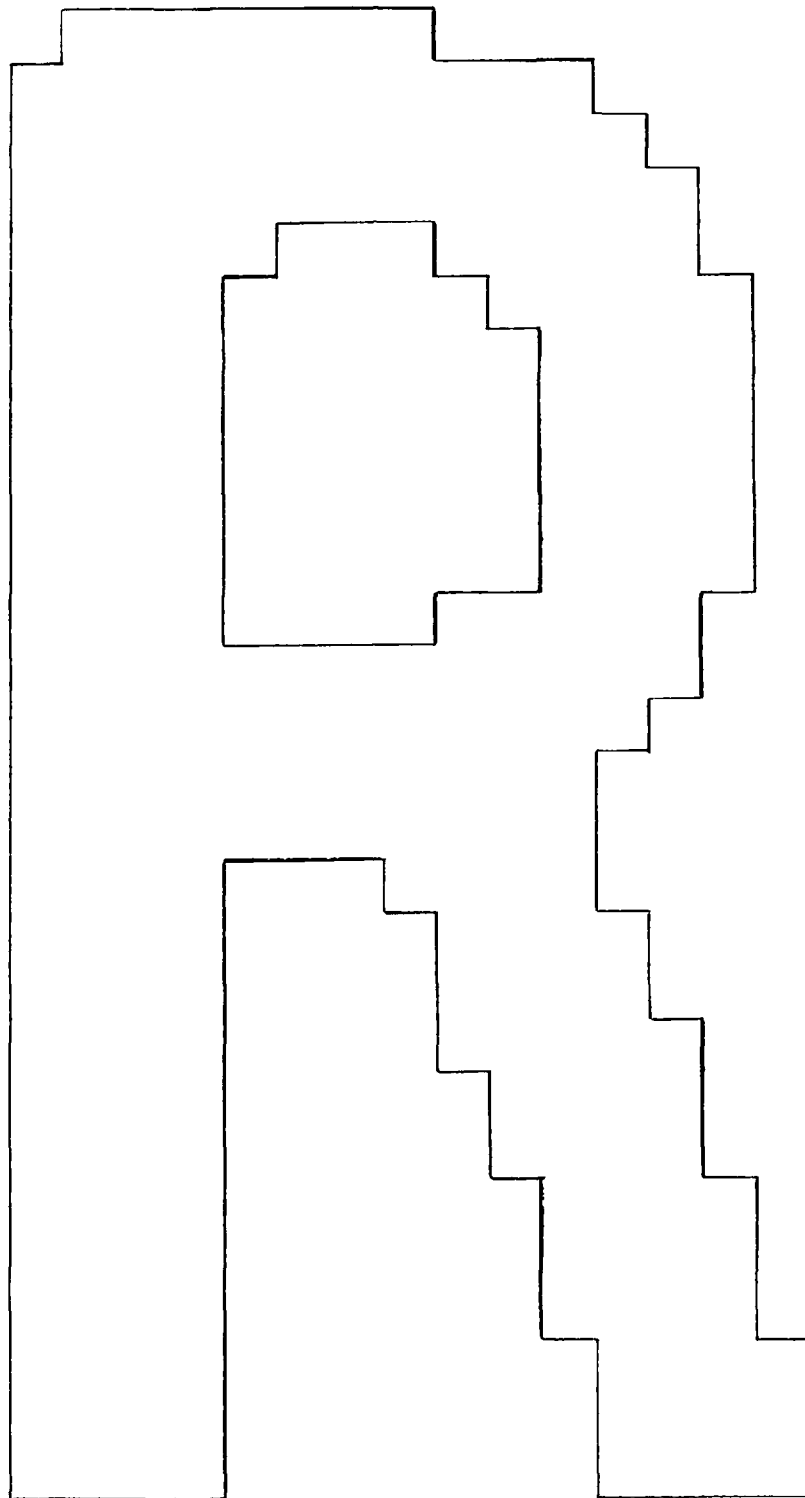

Figure C-4. Results of minifying 5X character.

CONCLUSIONS

From the results of this brief study, several conclusions can be reached. The first is that starting with a large (5:1 or 3:1) image does produce a high-quality digitized replica of the image. However, it does not necessarily guarantee the production of a superior quality digitized image after the minification process has been completed.

The larger size may help the customer in the edge definition and cosmetic qualities during the generation of his masters, but the minification process may eliminate desired black pels or generate unwanted ones. The location of the unwanted pels cannot be predicted, since they are generated by the sums and averages of square arrays (eg., 3 by 3, or 5 by 5) of pels combined and normalized in the minification process.

The establishment of a single "standard" size will greatly improve the consistency, accuracy of scale, and throughput from the GCS work station. Scale changes, refocusing and scan resolution verification are potential sources of error and significant increases in setup times.

APPENDIX D
ILLUMINATION COMPUTATION PROGRAM

FC Martin

3 April 1984

APPENDIX D CONTENTS

INTRODUCTION . . .	Page D-3
DISCUSSION . . .	D-3
CONCLUSIONS . . .	D-11
RECOMMENDATIONS . . .	D-11
ANNEX, BASIC ILLUMINATION PROGRAM . . .	D-13

APPENDIX D ILLUSTRATIONS

D-1. Sketch of the Bencher copy stand . . .	Page D-5
D-2. Sketch of the recommended mounting holes for four-lamp illumination . . .	D-6
D-3. Illumination values for "universal" four-lamp configuration . . .	D-8
D-4. Illumination values for 8-1/2- by 11-inch "model" configuration . . .	D-10

INTRODUCTION

The equipment used for accommodating the Datacopy camera and illuminating the input copy for the Graphics Conversion Subsystem is the Bencher copy stand. This unit was provided with two copy lamps, one on each side of the easel. The copy stand also is equipped with a ground glass, backlighted area to be used for acquiring transparent images. The Datacopy camera employs a charge coupled device (CCD) line imager at the focal plane, and mechanically causes the imager to move smoothly across the camera field of view. The following discussion pertains to the characterization of the available reflected illumination at the copy stand. It also discusses remedial options to improve the intensity and evenness of the available illumination.

DISCUSSION

A simple program has been written to calculate the relative values of illumination at a designated set of coordinates of the Bencher copy stand for various configurations of lamps. This program shows promise in assisting with the placement of the lamps to provide uniform output response from the camera imager for all usable locations on the copy stand easel.

Uniform response is very important, even for bilevel facsimile imagery acquisition. Variations in response at different locations affect the width of fine lines such as character stems in graphic images. In areas of less illumination on the copy stand easel, there is a tendency for lines to thicken during the thresholding process. In areas of strong illumination, lines could become thin or disappear altogether. The program presented here offers a method to evaluate the imager response to an illumination configuration without physically modelling the configuration and attempting to make measurements. It is recommended that formal measurements in conjunction with some refined location adjustments follow and confirm the calculation of results.

The lens usually used with the Datacopy camera is the Nikon 55 mm f3.5 Micro lens, which accommodates a picture angle (solid angle) of 43 degrees. To resolve 240 by 240 pels per inch with the Datacopy camera system, the camera height must be about 19 inches. At this height, a 43 degrees solid angle encompasses an image circle approximately 15 inches in diameter at the easel. At this height, the system can accommodate up to 10.58 inches square or a standard 8-1/2- by 11-inch page, which has a diagonal of 13.9 inches.

For the simple program generated, we have utilized the inverse square law spreading loss for the intensity vs distance from source parameter. That is:

$$\text{Intensity, } i = I / d^2 = I / (x^2 + y^2 + z^2)$$

Where intensity, "i" is defined as the impinging intensity resulting from the source lamp of intensity "I", striking the easel at an angle determined the lamp location, and the easel coordinates chosen.

Illumination from the two original lamps on the Bencher copy stand were barely adequate for the acquisition of images by the Datacopy camera for several reasons. First, the USPS wished to use the polarizing filters in the illumination path. Secondly, the Nikon lens has a maximum aperture of f 3.5 and provides its sharpest images at f 4.5 to f 5.6. The third reason is that when only two lamps are used, even without the polarizers and with the lens at full aperture, the amplitude of the received video did not utilize the entire voltage dynamic range of the camera signal channel. For these reasons, two additional lamps for the Bencher systems were ordered and installed on both units. Doubling the total illumination power decreased the sensitivity of the thresholding process to nonuniformity of illumination. Illuminating the document from four separated sources rather than two improved the uniformity of easel illumination.

In the BASIC program, which runs on either the Tektronix 4051 or 4054, several variables can be selected to calculate the resulting intensity at the imager. The following variables are selectable:

- C = Camera height (approx. 19 in. for 55 mm Nikon Lens & 240x240 resolution)
- W = Width between lamps or pairs of lamps (X dimension, 44 in. for Bencher)
- D = Depth between lamps or pairs of lamps (Y dimension, 19.5 in. for Bencher)
- H = Height of lamp filaments above copy (Z dimension, 20 in. for Bencher)
- I = Lamp source intensity in arbitrary units (50,000 units, this example)

A sketch of the copy stand showing the dimensions used in the program is shown in figure D-1. Figure D-2 shows the location and diameter dimensions for the recommended mounting hole location for a four-lamp illumination system using the existing Bencher lamp bracket. This arrangement is not the ideal configuration, but is adequate for experimental acquisitions where the size of the copy, the spatial resolution (lens focal length), and the camera height are not yet defined or restricted.

The program requires that the operator enter values for the above variables. It then calculates the values of illumination in four 9 by 9 arrays, producing 81 values of illumination for each array. Each array produces values for coordinates from (0,0) to (8,8). Coordinate (0,0) is immediately below the front left-hand lamp. Coordinate (8,8) is at the exact center of the copy stand. The intermediate values for width and depth (w,d) are equally spaced one-eighth-distance intervals. Since the program assumes symmetrical illumination, values of illumination for the other three quadrants can be obtained as mirror images from the array printed.

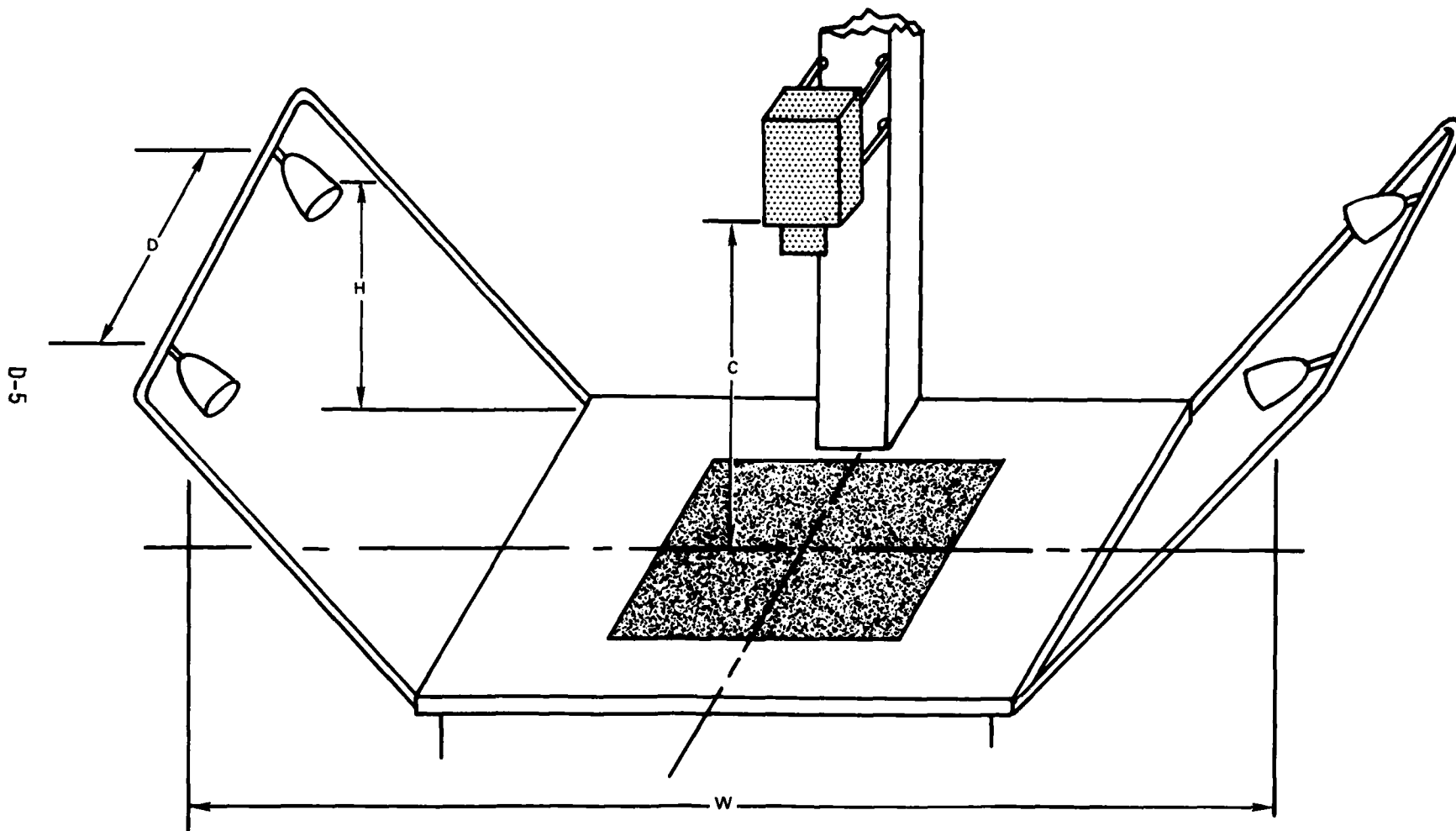

Figure D-1. Sketch of Bencher copy stand.

D-6

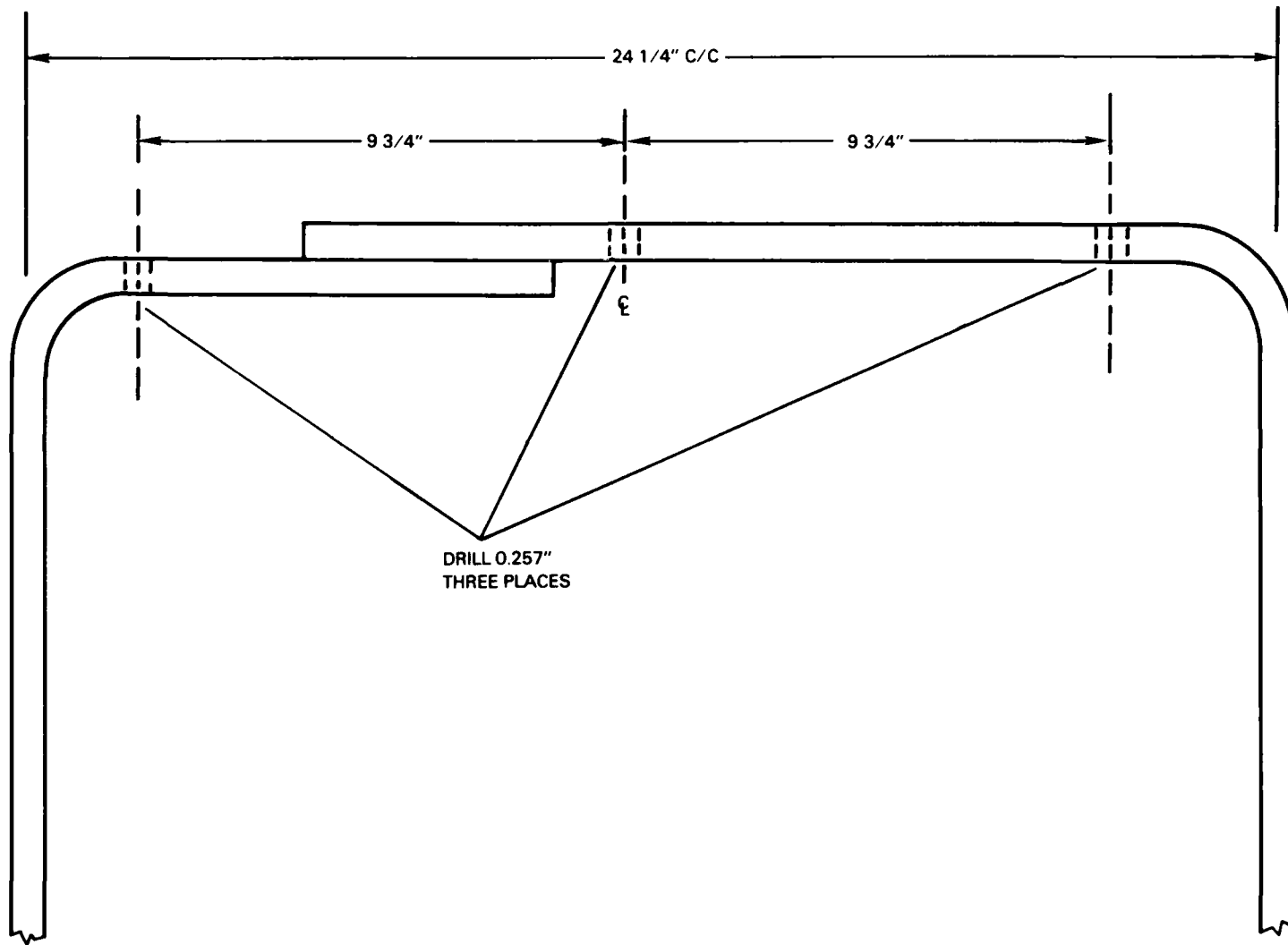

Figure D-2. Sketch of recommended mounting holes for four-lamp illumination.

The first array printed is the IMPINGING ILLUMINATION AT X, Y. This is the sum of the values of intensity impinging on the copy from all four lamps, regardless of angle of incidence. The component of this illumination from each lamp which is parallel to the surface of the illuminated document does not contribute to the illumination seen by the camera.

The second array is the CORRECTED ILLUMINATION AT X, Y. This array utilizes only the vector normal to the copy surface. This is the illumination which provides useful illumination to the camera.

In any optical system used to copy flat documents, there is a loss in intensity on the sensor as a function of the angle from the optical boresight centerline. This loss is called the cosine-fourth loss, which is the fourth power of the cosine of the angle off-axis from the lens axis centerline. The first cosine component comes from the launch angle of light from the document. The second comes from the arrival angle at the sensor. The third and fourth powers are contributions from the square of the increased distance from lens center to the copy point off-axis on the easel.

The third array calculated utilizes the values calculated in the first array but adds the effect of cosine-fourth for the camera height and angle off axis of each source calculated and outputs COS FOURTH IMPINGING ILLUMINATION. The program does not limit the calculation to the restricted solid angle of the lens system.

The final array should produce values (in arbitrary units) matching most closely the response of the image sensor in the camera for a uniformly reflective white standard test copy. We have called it the COS FOURTH CORRECTED ILLUMINATION array. This array uses the corrected illumination values generated in the second array calculated, and adds corrections for cosine-fourth loss. The array calculated is not restricted to the solid viewing angle of the lens system. It is this array in which we wish to obtain the most uniform illumination values.

As an example, figure D-3 shows the values of the computed COS FOURTH CORRECTED ILLUMINATION AT THE IMAGE SENSOR array over a quadrant of the entire 44-inch width by 19.5-inch depth under the lamps. The lamp height on the Bencher bracket is 20 inches.

The 55 mm Nikon lens will not cover this 19.5- by 44-inch area at a camera height of 19 inches, the height required to produce 240- by 240-pel resolution. The curved segment in the lower right corner of the array represents one quadrant of the 15-inch-diameter field of view of the camera set at a height of 19 inches. The variation in the ratio of X to Y scale of the printout causes the field of view curve to plot as an ellipse. Also shown in the lower right corner is a rectangle representing one quarter of an 8-1/2- by 11-inch document area. For the 15-inch diameter circular area, the variation in light intensity over the area varies + 18.8%. Over the document area, the variation is + 9.5%.

Figure D-4 shows how uniform the response of the sensor can be made by moving the lamps into a 24-inch-wide by 24-inch-deep by 9-inch-high configuration. The perimeter of the quadrant of camera field of view and the quarter-document area are shown in the lower right corner. In this configuration, the variation of illumination within the circle is $\pm 7.5\%$ and the variation over the document area is $+ 2.1\%$. It is also significant that the total illumination for this configuration is almost double (194%) of that of the standard configuration of figure D-3. This allows the lens to be set one f stop slower, increasing the resolution of the system. Also of significance is the fact that the lower lamp height used to produce the values for figure D-4 reduces the angle of incidence and any possible polarized reflectance from the copy.

In the event that a future USPS decision is reached to utilize 1:1 customer copy for graphics, it is recommended that an illumination configuration similar to that used for figure D-4 be considered.

This calculation routine has not yet been verified by accurate measurements and should be treated as a preliminary release. It should also be stated that the program assumes that the lamps are point sources rather than sources enclosed in reflectors. The actual projected intensity pattern from the lamps has not been determined and would require measurement rather than calculation. If the new Datacopy Model 611 camera is procured, 8-bit parallel outputs for the values of pel brightness over the entire field of view will be available for storage and analysis. Pel brightness histograms for standard black and standard white copy targets could be used to evaluate system uniformity of response.

Limited tests of the uniformity of illumination can be made using black standard and white standard targets, without digital acquisition of copy data. These two standards could be equipped with perhaps 25 small square or round pips placed in a 5 by 5 array on the documents. These pips should have low contrast with respect to the standard. With one pip in each document corner, one in the center, and the others equally spaced over the document, it should be possible to set the Datacopy threshold control so that the pips can be detected. With perfect illumination, all pips should be resolved at the same threshold value.

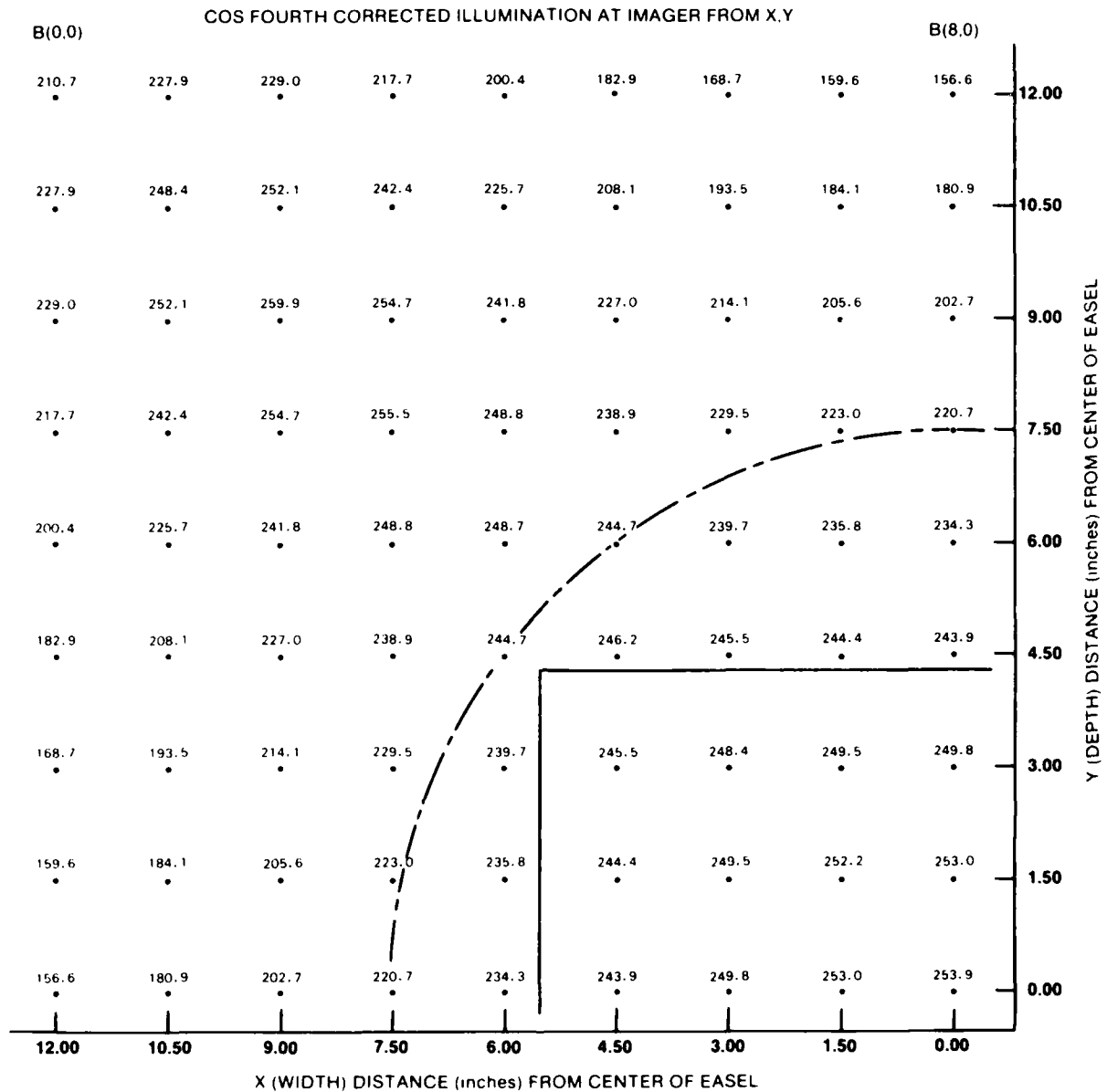

- Notes:
1. Lamp height for this array is 9 inches
 2. The curve and the rectangle represent one-fourth of: (1) the field of view and (2) an 8-1/2- by 11-inch document using the 55 mm lens with the camera set at 19 inches high.
 3. Variation of illumination within the circle is + 7.5%.
 4. Variation of illumination within the square is \pm 2.1%.
 5. Maximum illumination is 253.9 relative units.

Figure D-4. Illumination values for 8-1/2- by 11-inch "model" configuration.

CONCLUSIONS

1. The addition of a second pair of lamps to each Bencher copy stand improved both the amount and uniformity of the illumination on the easel.
2. A BASIC program for the Tektronix 4051 or 4054 Terminal is available with which to calculate the relative uniformity of illumination available to the sensor in the Datacopy camera.
3. This program is useful for copy stand design in providing realistic approximations of copy stand performance using simulated parameters for lamp height, width, and depth.

RECOMMENDATIONS

1. If the size of the graphics hardcopy input is determined to be of 1:1 scale, then a lamp configuration 24 inches deep by 24 inches wide with the lamp filaments 9 inches above the easel will provide illumination with approximately 2% variation over the scanned area, and will approximately double the available light presently available to the camera.
2. If other size masters are required, use the program to formulate the optimum layout of the four lamps.
3. Use white standard and black standard test documents with low-contrast target pips to evaluate the effectiveness of the calculated illumination configuration design.

ANNEX

BASIC ILLUMINATION PROGRAM

4 APRIL 1984
F.M.
File 11

```
100 PAGE
110 INIT
120 PRINT "THIS PROGRAM CALCULATES EASEL ILLUMINATION"
130 PRINT "WHERE DO WE PRINT? (32=SCREEN, 71=PRINTER) ";
140 INPUT Z
150 PRINT "ENTER ILLUMINATION CONSTANT, I (50000): ";
160 INPUT I
170 PRINT "ENTER LAMP HEIGHT, H ( 9): ";
180 INPUT H
190 PRINT "ENTER LAMP DEPTH SPACING, D (24.0): ";
200 INPUT D
210 PRINT "ENTER LAMP WIDTH SPACING, W (24): ";
220 INPUT W
230 PRINT "ENTER CAMERA HEIGHT, C (19) ";
240 INPUT C
250 K=9
260 J=9
270 DIM X(J), Y(K), L(J,K), M(J,K), S(J,K), A(J,K), B(J,K)
280 X=0
290 Y=0
300 Q=4
310 DIM R(Q)
320 FOR J=1 TO 9
330     Y=(J-1)*D/16
340     FOR K=1 TO 9
350         X=(K-1)*W/16
360         R(1)=SQR(X(K)2+Y(J)2+H2)
370         R(2)=SQR(X(K)2+(D-Y(J))2+H2)
380         R(3)=SQR((W-X(K))2+(D-Y(J))2+H2)
390         R(4)=SQR((W-X(K))2+Y(J)2+H2)
400         S(J,K)=SQR((D/2-(J-1)*D/16)2+(W/2-(K-1)*W/16)2+C2)
410         L(J,K)=(1/R(1)2+1/R(2)2+1/R(3)2+1/R(4)2)*I
420         M(J,K)=(1/R(1)3+1/R(2)3+1/R(3)3+1/R(4)3)*I*X
430         A(J,K)=(C/S(J,K))2*L(J,K)
440         B(J,K)=(C/S(J,K))2*M(J,K)
450     NEXT K
460 NEXT J
470 PRINT @Z: "L    IMPINGING ILLUMINATION AT X, Y  JJ"
480 PRINT @Z: "L(0,0)                                L(8,0)"
490 IMAGE 3D-D,2X,S
500 FOR J=1 TO 9
510     FOR K=1 TO 9
520         PRINT @Z: USING 490:L(J,K)
530     NEXT K
540     PRINT @Z:
550     PRINT @Z: "JJJ"
560 NEXT J
570 INPUT X$
580 PRINT @Z: "L    CORRECTED ILLUMINATION AT X, Y  JJ"
590 PRINT @Z: "M(0,0)                                M(8,0)"
```

```
500 FOR J=1 TO 9
510   FOR K=1 TO 9
520     PRINT @Z: USING 490:M(J,K)
530   NEXT K
540   PRINT @Z:
550   PRINT @Z:"JJJ"
560 NEXT J
570 INPUT X$
580 PRINT @Z:"L COS FOURTH IMPINGING ILLUM @ IMAGER FROM X,Y JJ"
590 PRINT @Z:"A(0,0)"                                     A(0,0)"
600 FOR J=1 TO 9
610   FOR K=1 TO 9
620     PRINT @Z: USING 490:A(J,K)
630   NEXT K
640   PRINT @Z:
650   PRINT @Z:"JJJ"
660 NEXT J
670 INPUT Z$
680 PRINT @Z:"L COS FOURTH CORRECTED ILLUM @ IMAGER FROM X,Y JJ"
690 PRINT @Z:"B(0,0)"                                     B(0,0)"
700 FOR J=1 TO 9
710   FOR K=1 TO 9
720     PRINT @Z: USING 490:B(J,K)
730   NEXT K
740   PRINT @Z:
750   PRINT @Z:"JJJ"
760 NEXT J
770 END
```

APPENDIX E
AN AUTOEDIT PROGRAM
FOR USPS E-COM GRAPHICS PROCESSING

SC McGirr

20 April 1984

APPENDIX E CONTENTS

INTRODUCTION . . .	Page E-3
NEEDS FOR AUTOEDITING . . .	E-3
THE ALGORITHM . . .	E-3
RESULTS . . .	E-9
ANNEX A GRAPHICS PATTERNS FOR AUTOEDITING . . .	E-11
ANNEX B ASSEMBLY LANGUAGE AUTOEDIT PROGRAM . . .	E-19

APPENDIX E ILLUSTRATIONS

E-1.	Bit assignment values for the kernel and optional windows . . .	Page E-4
E-2.	Test patterns for 1-Pel corners . . .	E-5
E-3.	Complete table of edited pels . . .	E-7
E-4.	Subset of the three tables . . .	E-8

INTRODUCTION

The purpose of this program is to assist an operator of the Graphics Conversion Subsystem in the process of refining the regularities of the boundary interface between black and white areas of graphics images. This program, written in assembly language, is integrated into the Graphics Conversion work station software and can be called by the operator to process a newly acquired image.

As graphics images are acquired, each pel is digitized by the Datacopy camera. The work station operator selects the value of a digital threshold number by observing the resulting pattern on the Datacopy display. Once this threshold appears to be satisfactory, the operator may choose to utilize the micropositioner, a copy stand manipulator which allows vernier adjustment of the translation and rotation of a document being scanned by the camera.

After the image is captured, thresholded, and stored in the Datacopy memory to the satisfaction of the operator, he can select the exact boundaries of the subset of the captured area he wishes to include in the final graphic image to be printed on the document. This subimage is then transferred to the image refresh memory of the AED 1024 graphics terminal. The operator may then inspect the details of the boundaries of the thresholded image using the zoom feature of the AED. At this time he makes a judgement decision whether to refine the document position further and recapture or to edit the presently stored subimage.

NEEDS FOR AUTGEDITING

Most graphic images of interest have regular slopes to the boundaries. Horizontal, vertical, and diagonal edges are common. Regular conic section curves are also common. In the acquisition and thresholding process, some pels which should be defined as black are thresholded as white, and white as black. Even in a small logo, such as our initial tentative standard of 624 pels width by 504 pels high (314,496 pels), there may be literally hundreds of pel irregularities in the boundaries of the graphic image. It will be of considerable advantage to the operator if a software routine within the work station can automatically search the image for single pels and doublet pel pairs at the graphic boundaries which most likely should be complemented and perform this operation without tedious operator involvement.

THE ALGORITHM

To develop the algorithm, a strategy similar to that used with the thinning algorithm has been employed. Examples of the types of boundary situations which can be identified by a simple kernel operator have been mapped and tested with a tentative truth table in an endeavor to establish a

consistent set of pattern rules which will contribute to the smoothing of image edges. One strategy which could have been used would employ a 5 by 5 kernel in which decisions whether to change the center pel would be predicated on the states of the 24 surrounding pels. This would have required a state table having 2^{24} possible values. In order to reduce the number of possible states required, an alternate approach was chosen.

A 3 by 3 basic kernel and four alternative secondary windows were selected as shown in figure E-1. One of the four windows may be called upon by a particular pattern to probe the values of the three pels to the EAST, SOUTH, WEST, or NORTH of the main kernel. In the figure, the nine pels in the 3 by 3 array are designated by numbers 1 through 9. The four alternate directional windows are also shown in the figure with their respective 3-bit number designations.

This editing routine was used with an AED 1024 display processor. The total number of combinations of the main kernel is 9 bits or 512 different patterns. The byte register in the AED processor holds only the lower 8 bits which are shifted 3 bits to the left for each center pel analysis. The ninth bit cannot be held in the byte register, but is available after shift in the carry bit register. With the pel order numbering sequence chosen, it is possible to assign numeric values for the particular combinations of black and white pels (ones and zeros) in the kernel and its window if needed.

Figure E-2 shows one of the test patterns used to generate the decision table. In the example, the nomenclature for the pattern in the upper left corner of the design image is the binary word 111011001 with an EAST window value of 001. The decimal equivalent of this binary combination of pels is 217 +, 1 E. The 217 is the value of the lower 8 significant bits. The + is the value of the ninth bit in the carry register. The 1 E represents EAST window of value decimal 1.

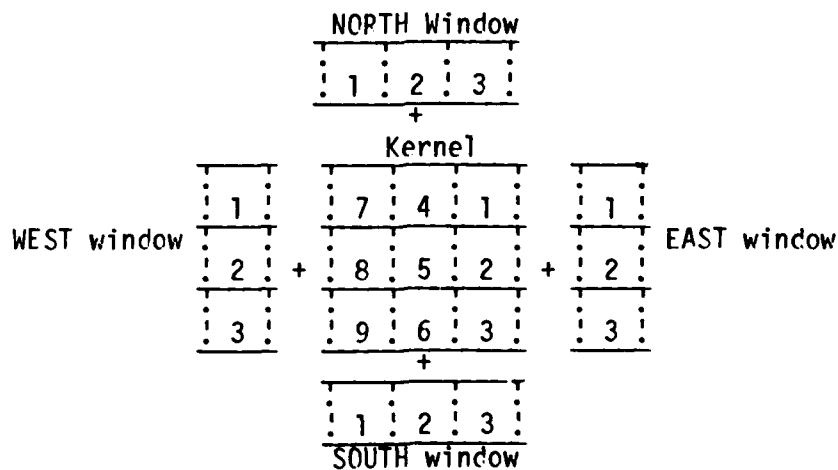

Figure E-1. Bit assignment values for the kernel and optional windows.

E-5

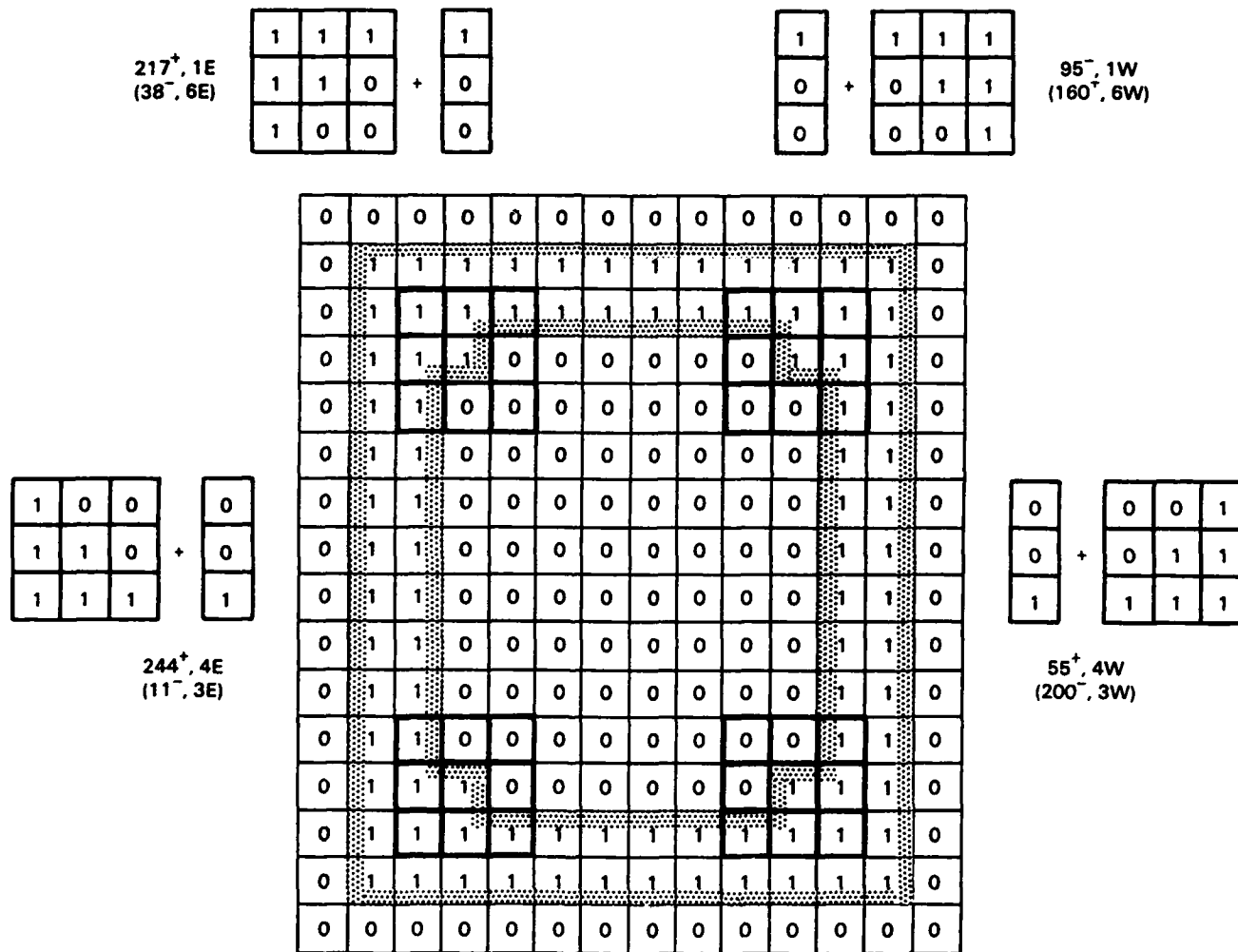

Figure E-2. Test pattern for 1-pel corners.

The rules for repair of a black edge on a white field are consistent with those for a white edge on a black field. Therefore, the ones complement of the combination 217 +, 1 E is (38 -, 6 E). This complement combination should call for a binary complementing of the center pel just as the original number called for. This symmetry allows for the use of a table with $2^8 = 256$ entries with the 38-, 6 E case (negative carry) being handled as the 217 +, 1 E case (positive carry).

Figure E-3 lists all of the non-zero tabular values for the two 256-word table. A complete set of all patterns used to generate the values for the decision tables is contained in Annex A to this appendix. Annex B lists the assembly language program used with the AED terminal to perform the editing process.

The method of decisions is shown in figure E-4. There are 256 possible combinations in the main 3 X 3 kernel ($2^8 = 256$). These values are represented by data statements in table 1 of figure E-3. All patterns in the main kernel correspond to addresses in this table. The values in this table then will indicate whether the pel is to remain unchanged (coded as 0), to be changed (coded as 1), or the decision postponed (coded as > 1). If the decision is postponed, the value in table 1 gives the address of entry to table 2. The values in the table provide information on which direction to search for more information. Addresses 0 - 7 are reserved; 8 - 127 = EAST; 128 - 191 = SOUTH; 192 - 239 = WEST; and 240 - 255 = NORTH.

A number in table 1 greater than one indicates the need to access data in one of the three windows. Windows are called when correcting double pel errors. The 3 by 3 kernel itself does not have access to the second row or column of nearest neighbors in any of the four directions, EAST, SOUTH, WEST, or NORTH. The E, S, W, or N character data in this column indicate the window direction. This is not needed by the software but is helpful for table editing. The table column also specifies the numeric value of data which may be found by sampling pels in the window. If the data found by sampling is the same as the value in column two of the table, then a complementing of the pel brightness value may be required. The next three columns of the table indicate the secondary table addresses for pel brightness reversal. Addresses 0 - 7_D have been reserved. Addresses 8 - 119_D for EAST, 120 - 191_D for SOUTH, 192 - 231_D for WEST, and 242 - 247_D for NORTH windows have been assigned.

In table 2, there are eight possible combinations representing the 1 X 3 windows (2^3). The values in table 2 will similarly represent decisions of no change (0), change pel (1), or postpone the decision (> 1). If postponed, the value in table provides the address in table 3, the final table.

As an example of how the routine operates, let us examine several lines of the table. For instance, the line having a kernel value of 5z + has no corresponding column two reference to a window. In this instance, the pel brightness should be reversed without need for further processing.

TABLE 1	
3 BY 3 KERNEL	ADDRESS TO TABLE 2
15 +	1
16 +	200
47 +	252
48 +	232
50 +	1
52 +	1
54 +	8
55 +	208
134 +	128
143 +	128
144 +	152
160 +	216
164 +	16
165 +	1
166 +	1
167 +	192
173 +	32
175 +	224
176 +	136
200 +	144
201 +	40
203 +	104
204 +	1
206 +	160
207 +	168
208 +	1
210 +	56
217 +	48
228 +	64
230 +	24
232 +	1
233 +	184
235 +	72
236 +	240
237 +	80
238 +	88
239 +	1
240 +	176
244 +	96

TABLE 2		
ADDRESS FROM TABLE 1	WINDOW VALUE	ADDRESS TO TABLE 3
8	0 F	1
	4 E	1
16	6 E	1
	7 E	1
24	6 E	1
32	7 E	1
40	3 E	8
48	1 E	24
56	0 E	1
64	6 E	1
72	3 E	1
80	0 E	1
	3 E	1
	6 E	1
	7 E	1
88	6 E	1
96	4 E	56
104	3 E	1
128	7 S	1
136	1 S	1
144	3 S	1
	7 S	1
152	1 S	1
160	7 S	1
168	0 S	1
	3 S	1
	6 S	1
	7 S	1
176	0 S	1
	1 S	1
184	3 S	1
192	6 W	1
200	4 W	1
208	4 W	64
216	6 W	32
224	6 W	1
232	4 W	1
240	3 N	1
252	6 N	1

TABLE 3		
ADDRESS FROM TABLE 2	WINDOW VALUE	CHANGED PELS.
8	3 E	1
24	1 S	1
32	3 S	1
56	1 N	1
64	4 N	1

Figure E-3.

Complete table of edited pels.

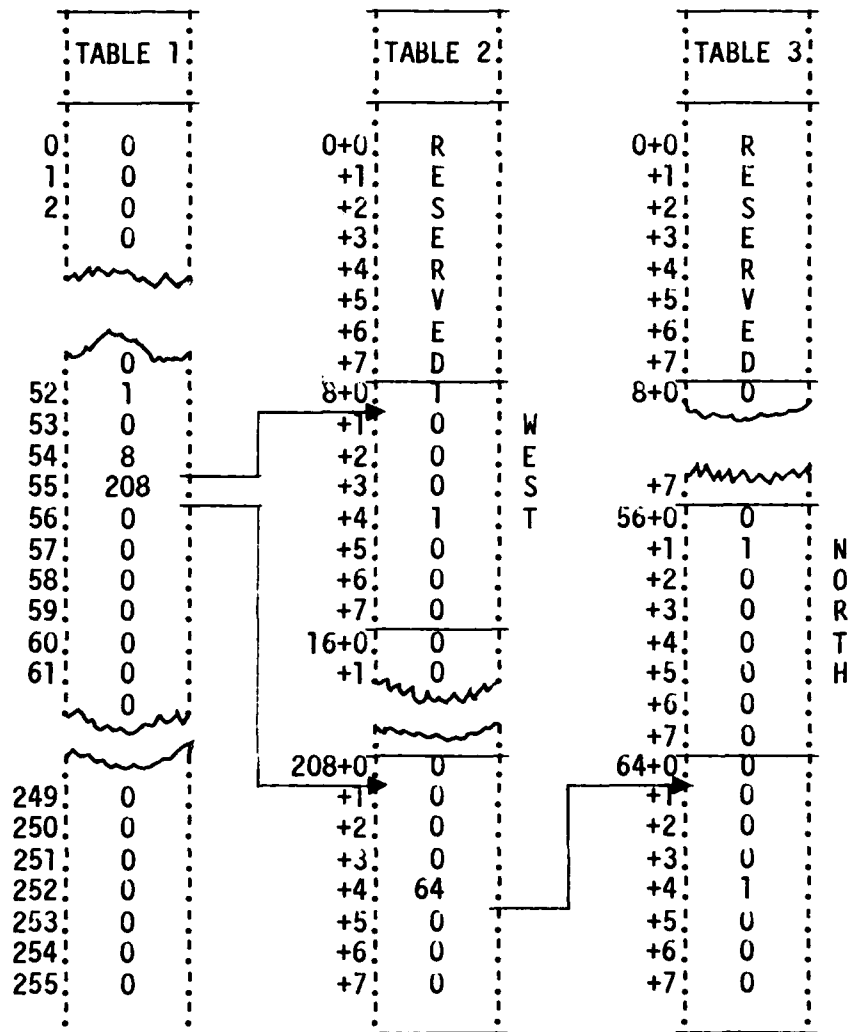

Figure E-4. Subset of the three tables.

For the line with kernel value 54, the number stored in table 1 of figure E-4 is 8. The value 8 is used as a basic address in table 2. Since 8 lies in the interval $8 - 119_D$, the window to be examined is the EAST window. Table 2 contains eight address spaces for addresses 8 through 15. Address 8 represents 0 E and address 12 represents 4 E. Only these two addresses contain values of 1. This state causes the pel value to be changed for either of these addresses.

The final example, shown in detail in figure E-4, involves the full use of the lookup tables. For a value of the kernel of 55, the number stored in table 1 is 208. The value 208 lies in the range $192 - 239_D$, which is reserved for west windows.

By going to address 208 in table 2, figure E-4 shows that for addresses 208 to 215, all values are zero except for 212, which is 208 plus WEST window value 4W. value of 64 in table 2 causes the program to go to address 64 in table 3. The value 64 in table 3 calls for an evaluation of the NORTH window. The only non-zero value occurs where the north window value is 4N. For this condition only, the center pel of the original kernel is reversed.

RESULTS

The autoedit software was almost entirely generated without access to the AED Color Graphics Terminal. Much of the time was invested in the generation of the three tables from the example figure cases in annex A.

The values for the tables are presented in the first four pages of annex B. By studying the designs of annex A, changes can be accommodated in the rules of the tables.

When the software was loaded into the AED, the program was quickly debugged and was made to run as presently configured. The run time for the routine is somewhat dependent on the data. The average time for the autoedit routine to complete the processing of a standard 624 by 504 pel graphic is approximately 2 to 4 minutes.

It is believed that the autoedit routine provides a very useful function for the operator of the Graphics Conversion Subsystem work station.

ANNEX A

GRAPHICS PATTERNS USED FOR AUTOEDIT PROGRAM

1-pel CORNERS

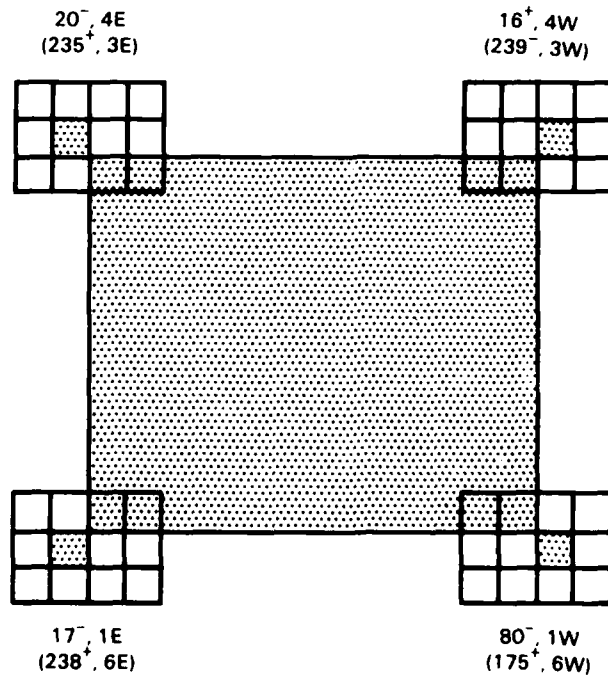
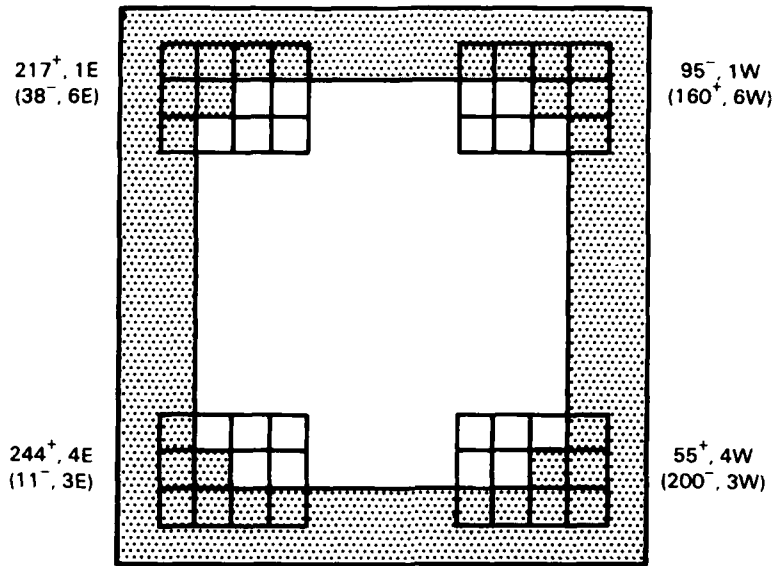

1-pel CORNERS

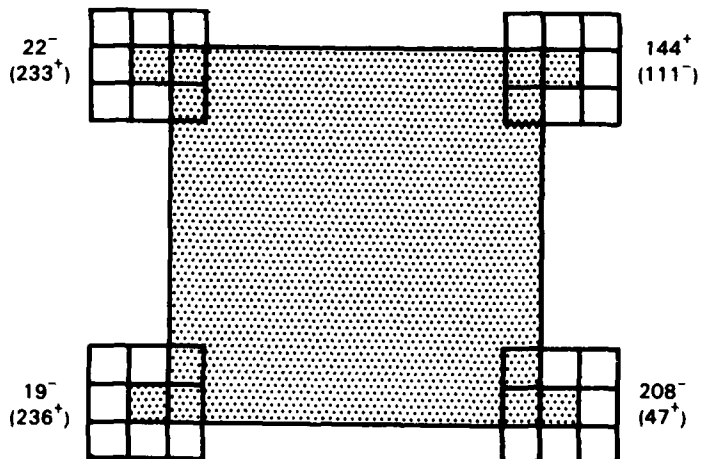
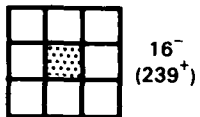
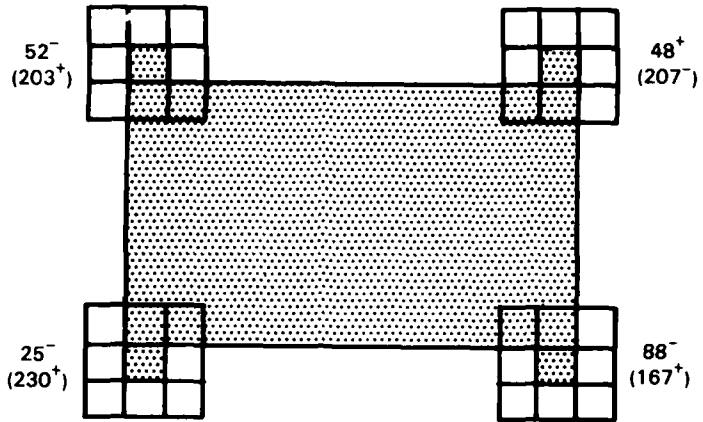

1 & 2 pel EDGES

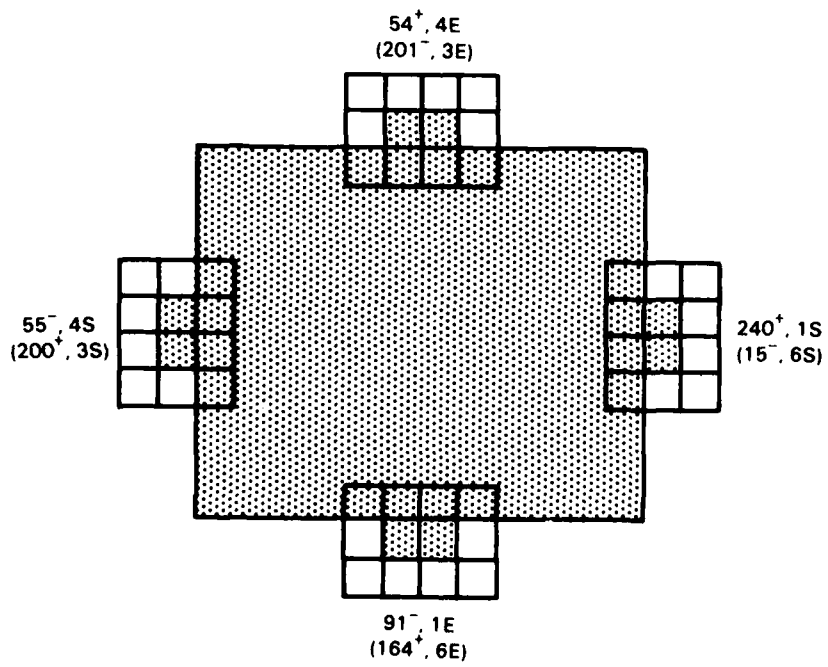
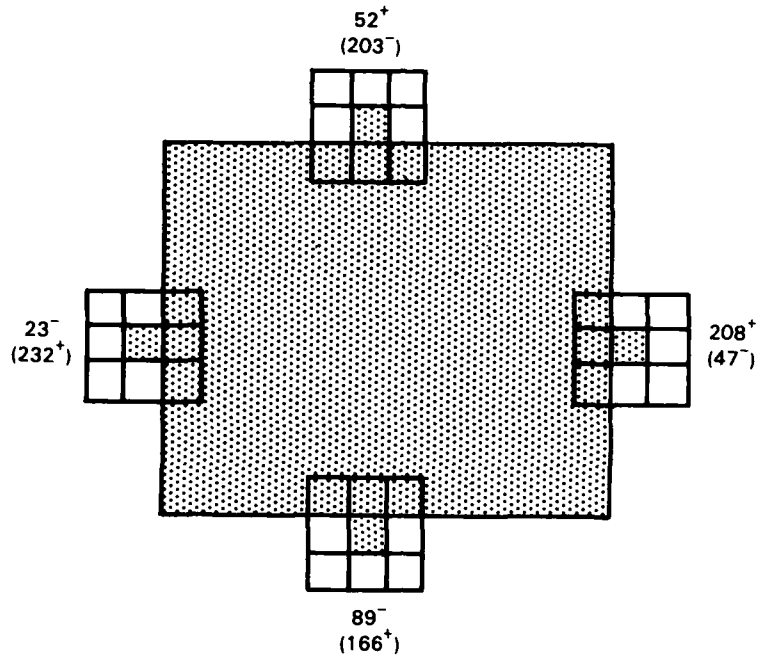

2-pel CORNERS

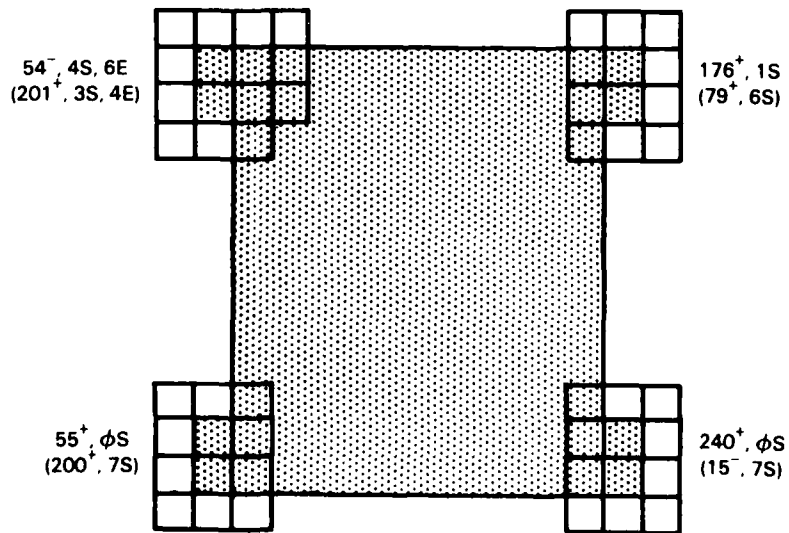
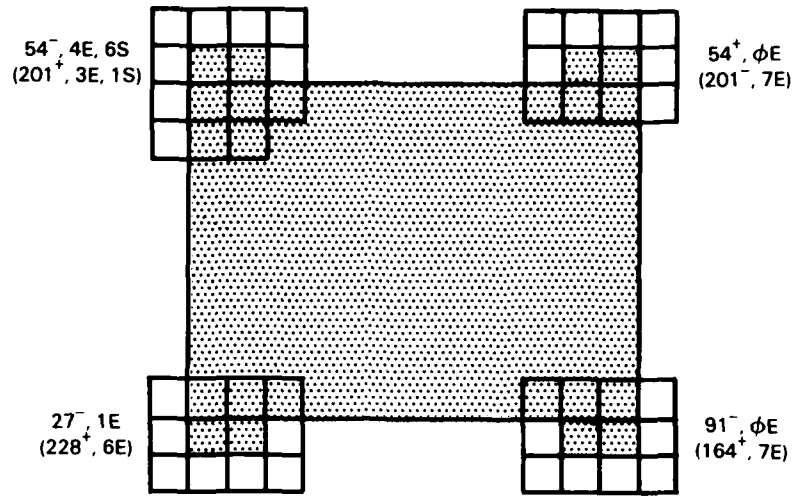

2-pel CORNERS

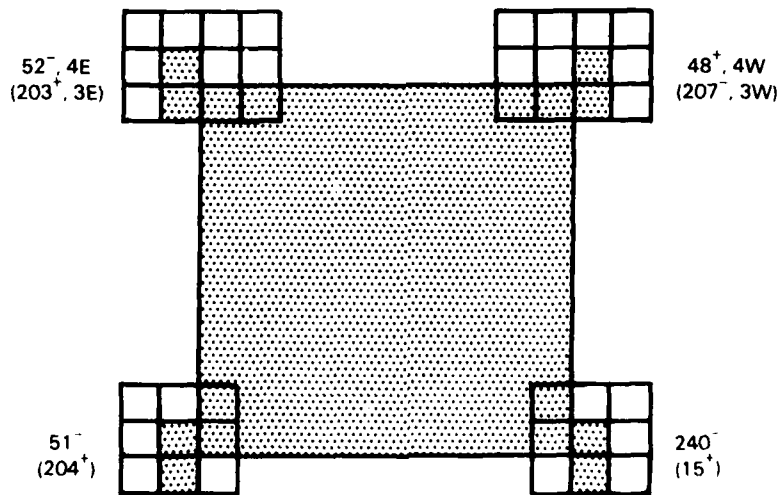
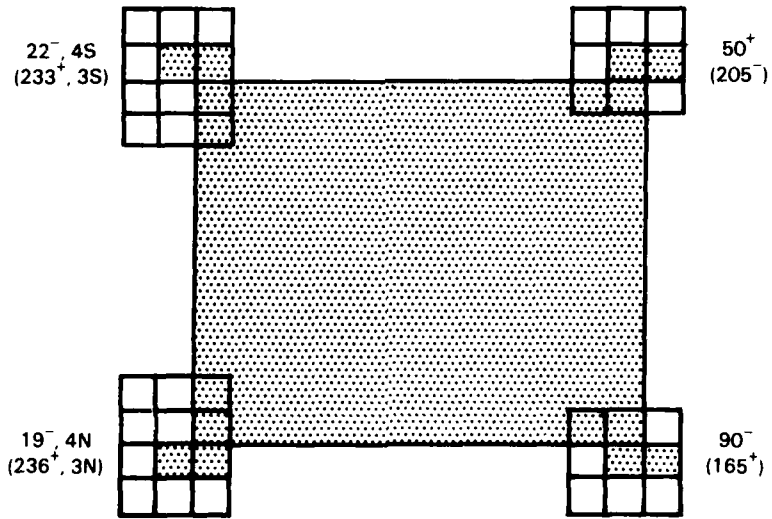

2-pel CORNERS

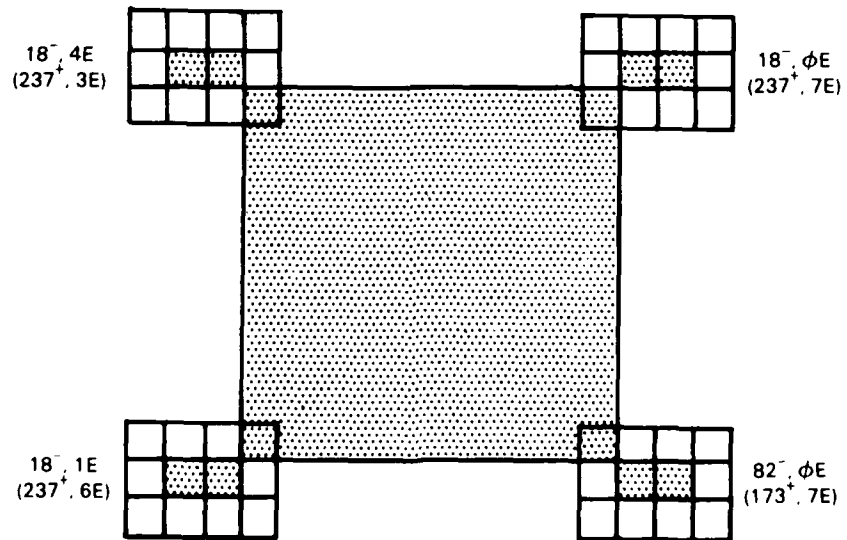
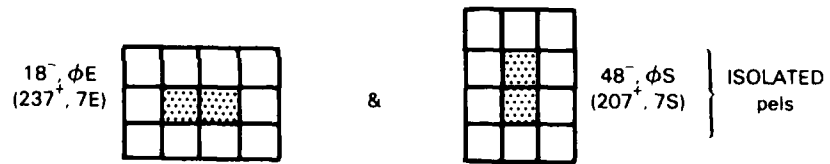
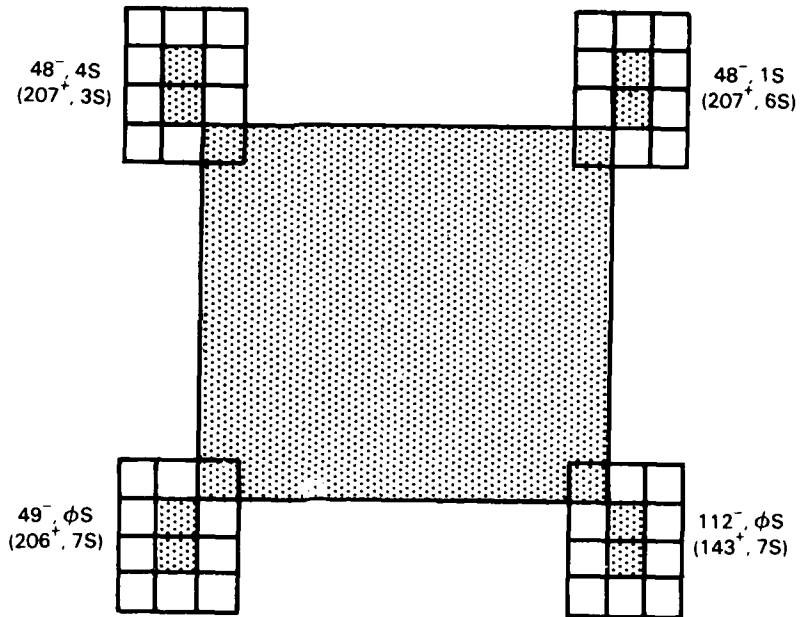

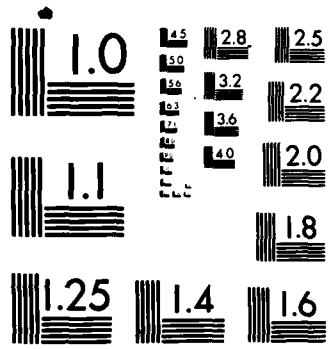

MICROCOPY RESOLUTION TEST CHART
NATIONAL BUREAU OF STANDARDS-1963-A

ANNEX B

ASSEMBLY LANGUAGE AUTOEDIT PROGRAM FOR AED

```

*
*****
*
*
*           SPATIAL FILTERING
*
*           By S. McGirr    4/84
*
*   A 6502 assembly language program designed to remove
*   one and two pel bumps from an image. The pels may be
*   isolated or on edges. The image is operated on in bit
*   plane #0 with a 3X3 window with look ahead capability.
*
*           N
*           11:2131
*           +
*   111 1714111 111
*   W121+1815121+121E  ===>
*   131 1+16131 131
*           +
*           11:2131
*           S
*****

```

```

ORG    $FF9
LIST   0
OPT    ABS

```

```

*
***** LOOK-UP TABLE 1 *****
*

```

```

                JMP    START
HFIX_LO    BSZ    1
HFIX_HI    BSZ    1
VPIX_LO    BSZ    1
VPIX_HI    BSZ    1
*
*           0 - 15
TABLE1     DATA    0,0,0,0,0,0,0,0,0
           DATA    0,0,0,0,0,0,0,0,1
*
*           16 - 31
           DATA    200,0,0,0,0,0,0,0,0
           DATA    0,0,0,0,0,0,0,0,0
*
*           32 - 47
           DATA    0,0,0,0,0,0,0,0,0
           DATA    0,0,0,0,0,0,0,0,252
*
*           48 - 63
           DATA    232,0,1,0,1,0,8,208
           DATA    0,0,0,0,0,0,0,0,0

```

```

*
*
*           64 - 79
*   DATA  0,0,0,0,0,0,0,0
*   DATA  0,0,0,0,0,0,0,0
*
*           80 - 95
*   DATA  0,0,0,0,0,0,0,0
*   DATA  0,0,0,0,0,0,0,0
*
*           96 - 111
*   DATA  0,0,0,0,0,0,0,0
*   DATA  0,0,0,0,0,0,0,0
*
*           112 - 127
*   DATA  0,0,0,0,0,0,0,0
*   DATA  0,0,0,0,0,0,0,0
*
*           128 - 143
*   DATA  0,0,0,0,0,0,128,0
*   DATA  0,0,0,0,0,0,0,128
*
*           144 - 159
*   DATA  152,0,0,0,0,0,0,0
*   DATA  0,0,0,0,0,0,0,0
*
*           160 - 175
*   DATA  216,0,0,0,16,1,1,192
*   DATA  0,0,0,0,0,32,0,224
*
*           176 - 191
*   DATA  136,0,0,0,0,0,0,0
*   DATA  0,0,0,0,0,0,0,0
*
*           192 - 207
*   DATA  0,0,0,0,0,0,0,0
*   DATA  144,40,0,104,1,0,160,168
*
*           208 - 223
*   DATA  1,0,56,0,0,0,0,0
*   DATA  0,48,0,0,0,0,0,0
*
*           224 - 239
*   DATA  0,0,0,0,64,0,24,0
*   DATA  1,184,0,72,240,80,88,1
*
*           240 - 255
*   DATA  176,0,0,0,96,0,0,0
*   DATA  0,0,0,0,0,0,0,0

```

*
 *
 ***** LOOK-UP TABLE 2 *****
 *

*
 * TABLE2 DATA 0 BYTE NOT USED
 * 0,0,0,0,0,0,0,0

* #8 ----- EAST -----
 * DATA 1,0,0,0,1,0,0,0

* #16 DATA 0,0,0,0,0,0,1,1

* #24 DATA 0,0,0,0,0,0,1,0

* #32 DATA 0,0,0,0,0,0,0,1

* #40 DATA 0,0,0,8,0,0,0,0

* #48 DATA 0,24,0,0,0,0,0,0

* #56 DATA 1,0,0,0,0,0,0,0

* #64 DATA 0,0,0,0,0,0,1,0

* #72 DATA 0,0,0,1,0,0,0,0

* #80 DATA 1,0,0,1,0,0,1,1

* #88 DATA 0,0,0,0,0,0,1,0

* #96 DATA 0,0,0,0,56,0,0,0

* #104 DATA 0,0,0,1,0,0,0,0

* #112 DATA 0,0,0,0,0,0,0,0

* #120 DATA 0,0,0,0,0,0,0,0

* #128 ----- SOUTH -----
 * DATA 0,0,0,0,0,0,0,1

* #136 DATA 0,1,0,0,0,0,0,0

* #144 DATA 0,0,0,1,0,0,0,1

* #152 DATA 0,1,0,0,0,0,0,0

* #160 DATA 0,0,0,0,0,0,0,1

* #168 DATA 1,0,0,1,0,0,1,1

* #176 DATA 1,1,0,0,0,0,0,0

* #184 DATA 0,0,0,1,0,0,0,0

```

*
* #192 ----- WEST -----
* DATA 0,0,0,0,0,0,1,0
* #200
* DATA 0,0,0,0,1,0,0,0
* #208
* DATA 0,0,0,0,64,0,0,0
* #216
* DATA 0,0,0,0,0,0,32,0
* #224
* DATA 0,0,0,0,0,0,1,0
* #232
* DATA 0,0,0,0,1,0,0,0
*
* #240 ----- NORTH -----
* DATA 0,0,0,1,0,0,0,0
* #248
* DATA 0,0,0,0,0,0,0,0
*
*
*
***** LOOK-UP TABLE 3 *****
*
* 0 BYTE NOT USED
TABLE3 DATA 0,0,0,0,0,0,0,0
*
* #8 ----- EAST -----
* DATA 0,0,0,1,0,0,0,0
* #16
* DATA 0,0,0,0,0,0,0,0
*
* #24 ----- SOUTH -----
* DATA 0,1,0,0,0,0,0,0
* #32
* DATA 0,0,0,1,0,0,0,0
*
* #40 ----- WEST -----
* DATA 0,0,0,0,0,0,0,0
* #48
* DATA 0,0,0,0,0,0,0,0
*
* #56 ----- NORTH -----
* DATA 0,1,0,0,0,0,0,0
* #64
* DATA 0,0,0,0,1,0,0,0
*
*
TMP_LO BSZ 1
TMP_HI BSZ 1
XDONE_LO BSZ 1
XDONE_HI BSZ 1
CAPX_LO BSZ 1

```

```

CAPX_HI BSZ 1
CAPY_LO BSZ 1
CAPY_HI BSZ 1
PIXEL BSZ 1
FIX_SAV BSZ 1
TEMP BSZ 1
COUNT BSZ 1
TOTAL BSZ 1
W9 BSZ 1
W3 BSZ 1
DX BSZ 1
DY BSZ 1
AB BSZ 1
*
MASK1 EQU %00000001
MASK2 EQU %00000010
*
XLO EQU @24
XHI EQU @25
YLO EQU @26
YHI EQU @27
*
VM EQU @30
*
XPOS EQU @101
XPOSH EQU @102
YPOS EQU @103
YPOSH EQU @104
*
* VECTORS TO MOVE RELATIVE AROUND WINDOW
*
DX9 DATA -1,0,0,1,0,0,1,0,0,-1
DY9 DATA -1,1,1,-2,1,1,-2,1,1,-1
*
* <-East->!<-South->!<-West->!<-North->
DX3 DATA 2,0,0,-2,1,-1,-1,1,-2,0,0,2,1,-1,-1,1
DY3 DATA -1,1,1,-1,-2,0,0,2,-1,1,1,-1,2,0,0,-2
*
RFX MACRO
JSR PT
LDA VM
STA PIXEL
ENDM
*
WFX MACRO
JSR PT
LDA PIXEL
STA VM
ENDM

```

```

*
*****
*
*****
*
*   MAIN LOOP FOR EDITING ALGORITHM
*
*   SET UP END OF ROW INDICATOR (XDONE)
*
START      LDA      HPIX_HI
           STA      XDONE_HI
           LDA      HPIX_LO
           SEC
           SBC      #1
           STA      XDONE_LO
           BCS      SK7
           DEC      XDONE_HI
*
*   INITIALIZE CAP X
*
SK7         LDA      #1
           STA      CAPX_LO
           LDA      #0
           STA      CAPX_HI
*
*   INITIALIZE CAP Y
*
           LDA      VPIX_HI
           STA      CAPY_HI
           LDA      VPIX_LO
           SEC
           SBC      #1
           STA      CAPY_LO
           BCS      LOOP
           DEC      CAPY_HI
*
*   PROCESS PIXEL
*
LOOP        JSR      MOV
           JSR      MAIN
*
*   Increment X counter ...
*
           LDA      CAPX_LO
           CLC
           ADC      #1
           STA      CAPX_LO
           BCC      SK9
           INC      CAPX_HI

```

```

*
* Test for last column ...
*
SK9      LDA      CAPX_LO
        CMP      XDONE_LO
        BNE      LOOP
        LDA      CAPX_HI
        CMP      XDONE_HI
        BNE      LOOP

*
* Reset X if at end of row
*
        LDA      #1
        STA      CAPX_LO
        LDA      #0
        STA      CAPX_HI

*
* Decrement Y counter ...
*
        LDA      CAPY_LO
        SEC
        SBC      #1
        STA      CAPY_LO
        BCS      SK10
        DEC      CAPY_HI

*
* Test for last Row ...
*
SK10     LDA      CAPY_LO
        CMP      #0
        BNE      LOOP
        LDA      CAPY_HI
        CMP      #0
        BNE      LOOP
        RTS

*
* END OF MAIN LOOP
*

```

```

*****
*
*****
*
*           SUBROUTINE MAIN
*
* MAIN PROCESSING ROUTINE FOR EDITING
*
* Determine if the window is at the start
* of a row prior to reading in new values.
*
MAIN      CLC
          LDA   CAPX_LO
          CMP   #1
          BNE   SHIFT
          LDA   CAPX_HI
          CMP   #0
          BNE   SHIFT

*
* Load all the new window values (X=1)
          LDA   #9
          STA   TOTAL
          JSR   WIND9
          JMP   XX

*
* Shift window to next position (X>1)
SHIFT     LDA   #3
          STA   TOTAL
          JSR   WIND9

*
* Locate the proper portion of Table 1
XX        LDA   AB
          BEQ   B

*
* ##### Use Table 1 for look-up #####
A         LDX   W9
          JMP   TEST0

*
* ##### Change window values 3X3 #####
B         LDA   W9
          EOR   #$FF
          TAX

*
* Take appropriate action as shown #1
TEST0    LDA   TABLE1,X
          STA   TEMP

*
          LDA   TEMP
          CMP   #0
          BNE   TEST1

```

```

*
*  ----> No Change for Pixel <----
*
*      RTS
*
*
* TEST1   LDA   TEMP
*         CMP   #1
*         BNE   EAST
*
*  ----> Change Pixel Value <----
*
*      RFX
*      LDA   PIXEL
*      EOR   #1
*      STA   PIXEL
*      WFX
*      JSR   MARK2 ;INDICATE CHANGE
*      LDA   W9
*      EOR   #16
*      STA   W9
*      RTS
*
*  -----> Postpone the decision <-----
*  Expand view of image with 1X3 window
*  8-119 E;120-191 S;192-239 W;240-255 N
EAST     LDA   TEMP
*         BMI   SOUTH
*         LDA   #0
*         STA   COUNT
*         JMP   TWO
*
* SOUTH   LDA   TEMP
*         CMP   #192
*         BPL   WEST
*         LDA   #4
*         STA   COUNT
*         JMP   TWO
*
* WEST    LDA   TEMP
*         CMP   #240
*         BPL   NORTH
*         LDA   #8
*         STA   COUNT
*         JMP   TWO
*
* NORTH   NOP
*         LDA   #12
*         STA   COUNT

```

```

*
* Load appropriate 1X3 window value
TWO      JSR    WIND3
          LDA    AB
          CMP    #1
          BEQ    ZERO

*
BB        LDA    W3
          EOR    #7
          STA    W3

*
* Take appropriate action shown #2
ZERO     LDA    TEMP
          CLC
          ADC    W3
          TAY
          LDA    TABLE2,Y
          STA    TEMP

*
          LDA    TEMP
          CMP    #0
          BNE    ONE

*
* -----> No Change for Pixel <-----
          RTS

*
* -----> Change Pixel Value <-----
ONE      LDA    TEMP
          CMP    #1
          BNE    E

*
          RFX
          LDA    PIXEL
          EOR    #1
          STA    PIXEL
          WFX
          JSR    MARK2 ;INDICATE CHANGE
          LDA    W9
          EOR    #16
          STA    W9
          RTS

*
* -----> Postpone the decision <-----
* Expand view of image with 1X3 window
* (8,16 E; 24,32 S; 40,48 W; 56,64 N)
*
E        LDA    TEMP
          CMP    #24
          BFL    S
          LDA    #0
          STA    COUNT
          JMP    THREE

```

```

*
S      LDA    TEMP
      CMP    #40
      BPL    W
      LDA    #4
      STA    COUNT
      JMP    THREE

*
W      LDA    TEMP
      CMP    #56
      BPL    N
      LDA    #8
      STA    COUNT
      JMP    THREE

*
N      LDA    #12
      STA    COUNT

*
* Load appropriate 1X3 window value
THREE JSR    WIND3
      LDA    AB
      CMP    #1
      BEQ    Z

*
BEB    LDA    W3
      EOR    #7
      STA    W3

*
Z      LDA    TEMP
      CLC
      ADC    W3
      TAX
      LDA    TABLE3,X
      STA    TEMP

*
      CMP    #0
      BNE    I

*
* -----> No Change For Pixel <-----
      RTS

*
* -----> Change Pixel Value <-----
I      RFX
      LDA    PIXEL
      EOR    #1
      STA    PIXEL
      WPX
      JSR    MARK2 ;INDICATE CHANGE
      LDA    W9
      EOR    #16
      STA    W9
      RTS

```



```

*****
*
*****
*
*           SUBROUTINE  WIND9
*
*           Find value of 9-bit window and
*           store the result in variable W9
*
WIND9      LDA    #0
           STA    AB
           STA    COUNT
*
           LDA    TOTAL
           CMP    #9
           BEQ    LOOPW9
*
           LDA    #1
           STA    DX
           LDA    #-1
           STA    DY
           LDA    #6
           STA    COUNT
           JMP    READ
*
LOOPW9     LDX    COUNT
           LDA    DX9,X
           STA    DX
           LDA    DY9,X
           STA    DY
READ       JSR    MVR
           RPX

*           Fill in W9 window values (0-> 8)
*           The highest bit will go to carry
*
           CLC
           ASL    W9
           LDA    PIXEL
           AND    #MASK1
           CMP    #1
           BNE    SKW9
*
           LDA    W9
           ORA    #1
           STA    W9
*
SKW9      INC    COUNT
           LDA    #7
           CMP    COUNT
           BPL    LOOPW9

```

```

*
      LDX   COUNT
      LDA   DX9,X
      STA   DX
      LDA   DY9,X
      STA   DY
      JSR   MVR
      RFX

*
*   Last time through loop set Flag
*
      CLC
      ASL   W9
      BCC   NOSET
      LDA   #1
      STA   AB
NOSET  LDA   PIXEL
      AND   #MASK1
      CMP   #1
      BNE   SKW9A

*
      LDA   W9
      ORA   #1
      STA   W9

*
*   Return CAP to where it originated
*   which will depend on #bits entered
*
SKW9A  INC   COUNT
      LDX   COUNT
      LDA   DX9,X
      STA   DX
      LDA   DY9,X
      STA   DY
      JSR   MVR
      RTS

```

```

*
*****
*
*****
*
*           SUBROUTINE WIND3
*
*   Find 3 bit value for IX3 accessory
*   windows and store in variable W3.
WIND3      LDA      #0
           STA      W3
           LDA      COUNT
           CLC
           ADC      #2
           STA      TOTAL
*
LOOPW3     LDX      COUNT
           LDA      DX3,X
           STA      DX
           LDA      DY3,X
           STA      DY
           JSR      MVR
           RFX
*
*   Fill in W3 one bit at a time
*
           CLC
           ASL      W3
           LDA      PIXEL
           AND      #MASK1
           CMP      #1
           BNE      SKW3
*
           LDA      W3
           ORA      #1
           STA      W3
*
SKW3       INC      COUNT
           LDA      TOTAL
           CMP      COUNT
           BPL      LOOPW3
*
*   Return CAP to where it started
*
           LDX      COUNT
           LDA      DX3,X
           STA      DX
           LDA      DY3,X
           STA      DY
           JSR      MVR
           RTS

```

```
*
*
*****
```

```
*
*
* SUBROUTINE PT - AED OVERHEAD
*
*
```

```
PT      LDA      XPOS
        STA      XLO
        LDA      XPOSH
        STA      XHI
```

```
*
        LDA      YPOS
        STA      YLO
        LDA      YPOSH
        STA      YHI
```

```
*
        RTS
```

```
*
*
*****
```

```
*
*
* SUBROUTINE MOV - MOVE ABSOLUTE
*
*
```

```
MOV     LDA      CAPX_LO
        STA      XPOS
        STA      XLO
```

```
*
        LDA      CAPX_HI
        STA      XPOSH
        STA      XHI
```

```
*
        LDA      CAPY_LO
        STA      YPOS
        STA      YLO
```

```
*
        LDA      CAPY_HI
        STA      YPOSH
        STA      YHI
```

```
*
        RTS
```

```

*
*
*****
*
*
*   SUBROUTINE MVR - MOVE RELATIVE
*
*
MVR      LDA      DX
        BPL      NXT1
        JSR      MXN
        JMP      TESTDY

*
NXT1     BEQ      TESTDY
        JSR      MXP

*
TESTDY   LDA      DY
        BPL      NXT2
        JSR      MYN
        JMP      MVRDN

*
NXT2     BEQ      MVRDN
        JSR      MYP
MVRDN    JSR      MOV
*
        RTS

*
*
*   SUBROUTINE MXP (DX > 0)
*   USED BY MVR
*
MXP      LDA      CAPX_LO
        CLC
        ADC      DX
        STA      CAPX_LO
        BCC      CT1

*
        INC      CAPX_HI

*
CT1      RTS

*
*
*   SUBROUTINE MXN (DX < 0)
*   USED BY MVR
*
MXN      LDA      DX
        EOR      #$FF
        CLC
        ADC      #1
        STA      DX
        LDA      CAPX_LO
        SEC
        SBC      DX
        STA      CAPX_LO
        BCS      CT3

```

```

*          DEC      CAPX_HI
*
* CT3          RTS
*
*
*
* SUBROUTINE MYF (DY > 0)
*   USED BY MVR
*
* MYF          LDA      CAPY_LO
*              CLC
*              ADC      DY
*              STA      CAPY_LO
*              BCC      CT2
*
*              INC      CAPY_HI
*
* CT2          RTS
*
*
* SUBROUTINE MYN (DY < 0)
*   USED BY MVR
*
* MYN          LDA      DY
*              EOR      #FFF
*              CLC
*              ADC      #1
*              STA      DY
*              LDA      CAPY_LO
*              SEC
*              SBC      DY
*              STA      CAPY_LO
*              BCS      CT4
*
*              DEC      CAPY_HI
*
* CT4          RTS
*
*
*
*
* SUBROUTINE DIAG
*   USED FOR DEBUGGING PURPOSES
*
* MARK2        RFX
*              LDA      PIXEL
*              EOR      #2
*              STA      PIXEL
*              WFX
*              RTS
*
*
*
* *****
*
*              END

```

APPENDIX F
THINNING ALGORITHM

JE Current

1 March 1984

APPENDIX F CONTENTS

BACKGROUND . . .	Page F-3
APPROACH . . .	F-3
ALGORITHM DETAILS . . .	F-6
RESULTS . . .	F-14

APPENDIX F ILLUSTRATIONS

F-1	Sample test image . . .	Page F-4
F-2	Thinned version of test image . . .	F-4
F-3	The complete kernel for black edge reduction . . .	F-7
F-4	Kernel plots for conversion to thinning tables . . .	F-8
F-5	Comparison of thinned and unthinned images printed on the Delphax printer . . .	F-15

APPENDIX F TABLES

F-1	Primary thinning of algorithm table . . .	Page F-9
F-2	Secondary thinning algorithm . . .	F-12

BACKGROUND

The choice of spatial resolution for scanning is usually matched to the pel resolution of the printer. The two printers presently under consideration for E-COM applications are the Delphax 2460 and the HP2680. The resolution of the HP2680 is 180 by 180 pels per inch. The resolution of the Delphax printer is 240 by 240 pels per inch.

To achieve a magnification ratio of 1:1 between the customer's logo or banner hardcopy and the printed image on the output message, the camera height on the copy stand is usually adjusted so that the camera pel resolution is equal to the printer pel resolution. This precludes the need for a scale-changing magnification or minification routine. These routines add imperfections to the image and require time-consuming computer processes. The image imperfections, the hardware needed for the scale change, and the time and operator skill required to produce the conversion, can be avoided if the camera and printer pel resolutions are matched.

The next concern is the ratio of the size of acquired pels to the size of the printed pel. In the Graphics Conversion Subsystem, the Datacopy camera contains a Fairchild linear charge coupled device (CCD) whose pel size is 13 by 13 microns (0.51 by 0.51 mils) square on 13-micron centers.

With the Delphax Ion Deposition printer, the 240 by 240 pels per inch deposits pels on 4.167-mil centers. Unfortunately, the ion deposition unit does not produce square 4.167-mil pels. Instead, it produces almost round pels having a diameter between 10 and 15 mils. Text font and logo images, particularly those having filigree patterns, tend to fill in white areas with the large black circular pels. The corresponding printed text character stems fatten to have a bold text appearance. Logo images darken appreciably and much detail may be lost.

APPROACH

To correct for this spread function during the printing process, a thinning algorithm was developed to operate on the captured digital replica of the original image.

The final thinning algorithm used in the Graphics Conversion Subsystem consisted of a 3 X 3 kernel in which the eight pels surrounding the center pel are used to determine whether or not to modify the center pel. When the center pel of the 3 X 3 array is white it is never changed. If it is black, the states of the eight surrounding pels are checked. Pels in the surrounding area are numbered clockwise starting with the pel to the left of the center pel. Black pels are given a value of one, and white pels are given a value of zero. The candidate algorithm was tested on a simple block pattern shown in figure F-1.

	Column																						
	1	2	3	4	5	j-1	j	j+1	j+2	j+3	j+4	j+5											
Row k-3	B	!	W	W	!	B	B	!	W	!	B	!	W	W	!	B	B	!	W	!	B		
Row k-2	B	!	W	W	!	B	B	!	W	!	B	!	W	W	!	B	B	!	W	!	B		
Row k-1	B	!	W	W	!	B	B	!	W	!	B	!	W	W	!	B	B	!	W	!	B		
Row k	B	B	B	B	!	W	!	B	!	W	!	B	B	B	!	W	W	!	B	!	W	!	B
Row k+1	B	B	B	B	!	W	!	B	B	B	B	B	B	!	W	W	!	B	!	W	W		

Figure F-1. Sample test image.

The sample test image segment shown above is as would be received from the graphic conversion process. This is the version of the graphic that will be used for display refresh. The reason that this version is acceptable for the refresh is that the pel size for the high resolution display is approximately the size of the pel area covered by the sensor photosite. A second version containing the generated thinned image will be sent to the printer. Thus the displayed image presented to the operator has the appearance of the original image and the one which will be printed after thinning. The kernel is shown at image position j+1, k+1 (lower right corner). The kernel is operating on pel j, k (center of kernel). Black pels above and to the left of pel j, k in this matrix may have been changed to white as a result of thinning. Pel j, k and those to the right and below have not yet been processed for thinning.

The results of the thinning process on the sample test image segment are shown in figure F-2 below. The pels denoted by the W have been modified from black to white from the test image matrix above. The border pels (e.g, column 1 or row 1) cannot be changed by the algorithm.

Row k-3	B	!	W	W	<u>W</u>	!	B	!	<u>W</u>	W	!	B	!	W	W	<u>W</u>	!	B	!	<u>W</u>	W	!	B
Row k-2	B	!	W	W	<u>W</u>	!	B	!	<u>W</u>	W	!	B	!	W	W	<u>W</u>	!	B	!	<u>W</u>	W	!	B
Row k-1	B	!	W	W	<u>W</u>	!	B	!	<u>W</u>	W	!	B	!	W	W	<u>W</u>	!	B	!	<u>W</u>	W	!	B
Row k	B	!	<u>W</u>	<u>W</u>	<u>W</u>	W	!	B	!	W	!	B	B	B	!	W	W	!	B	!	W	!	B
Row k+1	B	B	B	B	!	W	!	B	B	B	B	B	B	!	W	W	!	B	!	W	W		

Figure F-2. Thinned version of test image.

Reading the clockwise sequence of the pel states generates an 8-bit binary word (byte). This byte is used as an address to a stored truth table. The truth table usually provides an unconditional decision to change the black center pel to white or to allow it to remain black. On some patterns, more data regarding the former values of previously thinned pels are needed to prevent the complete erosion of thin lines or sharp points. These values are checked from memory and sent to a conditional secondary truth table, where a final decision is made to modify or let stand the black state of the center pel.

The entire image, except for the outside rows and columns of an image area, are converted row by row from the second line to the next-to-the-last line.

For operator convenience in monitoring the thinning process, displays from the unmodified image plane and the thinned image plane are presented on the screen in two different colors. Where thinning has occurred around black areas, a third color is generated. This allows the operator to examine the effects of the process. On the Graphics Conversion Subsystem work station, the original image is presented in red, the thinned image is presented in green. Unchanged areas appear in black and yellow. Changed reds are shown in green.

The HP2680 printer uses a laser scanning principle to write print images on the charged drum. In contrast to the Delphax ion engine, the laser light shines on areas where printing is not wanted. Spot growth of the laser beam diameter has the opposite effect to spot growth on the Delphax ion beam. In this case, the white areas suffer from the area growth, causing images and character stems to appear to be washed out.

Images for the HP2680 may be corrected with a "thickening" algorithm, in which the role of black and white pels are reversed. It was found that a simpler solution is to use the same algorithm for generating image data for both printers. When the image is to be printed on the Delphax, the procedure is exactly as described previously. When data is to be printed on the HP laser printer, two additional steps are added. The first is to generate a negative (ones complement) of the image. Then the thinning process is applied to the negative. After thinning the image is reversed back to a positive and sent to the HP2680 for printing.

Preliminary analysis of the fidelity of images acquired, thinned, and printed in this fashion indicates that the likeness of the printed image to the input hardcopy image is very good.

Thought has been given to generating alternate truth tables which modify one side and the top of black areas rather than on both sides plus the top and bottom. These can be generated and installed in the GCS in a reasonably short programming time span. Tests thus far indicate that thinning on both sides, top, and bottom produce very accurate replicas of the original hardcopy image.

ALGORITHM DETAILS

An analysis of the 3 by 3 algorithm is shown in figure F-3. In the 51 squares shown in figure F-3a, all combinations of black and white pels are represented. Number sets above the 3 X 3 array patterns represent the series of sequences of black pels around the center pel for each of the 51 squares. For example, 3/1/1 above the kernel in row 3, column 3 indicates that around the perimeter there is a sequence of three consecutive neighboring black pels followed by a white, a black, a white, and one more black.

The number to the right of the kernel indicates the number of ways in which the combination can be permuted. In the example above of the kernel in row 3, column 3, the black corner pel could be in any of the four corners.

The sums of rows of permutations are shown at the right of the figure. The total number of permutations is 256.

In figure F-3(b), the eight permutations of one of the 51 operators, row 4, column 6, are shown. Eight is the maximum number of permutations that any pattern can attain. Fewer are encountered where permuted shifts of the eight surrounding pels through 90°, 180°, and 270° before and after mirror-image flips match an already existing pattern.

Figure F-4 shows the relationship between a pattern resulting from operating with the kernel on all possible 3 by 3 image pel combinations and the resulting 8-bit binary number obtained by designating black perimeter pels to be "ones," white perimeter pels to be "zeros," and assigning bit positions starting clockwise from the left side center pel designated as the least significant bit (LSB).

The reason for starting with the pel to the left of the center pel and counting clockwise for increasing bit positions is because any or all of the four LSB pels could have been altered by previous operations of the 3 by 3 kernel. All of the row above the present center pel position has been through the thinning process. Also, all of the row to the left of the center pel has been through the process. The three pels across the bottom of the 3 by 3 array and the pel to the right of the center pel have not yet been subjected to the thinning operation.

Figure F-4 shows a list of decimal numbers under each of the 51 configurations. These decimal numbers represent the decimal value of binary numbers generated from the peripheral pel values. This figure was used to develop the truth table, figure F-1. Numbers to the right of the array designate the assigned action for the pel array. A "one" in this position assigns an action in the truth table (table F-1) to leave the black pel black. A "zero" in this position designates the action to change the pel to white.

The pattern in the left-most column of row B includes asterisks after the numbers 15 and 135. The asterisk indicates that the "one" normally assigning the pel to remain black is not to be automatically assigned for this permutation. The secondary truth table must be consulted to determine which of the previously scanned pels have been changed from black to white, and the decision made accordingly.

	1	2	3	4	5	6	7	8
ROW A	$\frac{B^3}{255}$	$\frac{WB^3}{127}$	$\frac{B^3B}{191^*}$	$\frac{WB^3B}{63^*231^*}$	$\frac{WB^3B}{31^*}$	$\frac{WB^3B}{62}$	$\frac{WB^3B}{95}$	$\frac{B^3WB}{175}$
	$\frac{B^3B}{223}$	$\frac{B^3B}{247=1}$	$\frac{B^3B}{251}$	$\frac{WB^3B}{159^*249}$	$\frac{WB^3B}{199}$	$\frac{WB^3B}{227^*}$	$\frac{B^3B}{215}$	$\frac{WB^3B}{235}$
	$\frac{B^3B}{253=1}$	$\frac{B^3B}{254}$	$\frac{B^3B}{254}$	$\frac{WB^3B}{207^*252}$	$\frac{WB^3B}{241}$	$\frac{WB^3B}{248}$	$\frac{WB^3B}{245}$	$\frac{B^3WB}{250}$
	$\frac{B^3B}{15^*135^*}$	$\frac{B^3B}{61}$	$\frac{B^3B}{47}$	$\frac{WB^3B}{111}$	$\frac{WB^3B}{14}$	$\frac{WB^3B}{7^*}$	$\frac{B^3B}{46}$	$\frac{B^3B}{57}$
	$\frac{B^3B}{30}$	$\frac{B^3B}{79}$	$\frac{B^3B}{122}$	$\frac{WB^3B}{123}$	$\frac{WB^3B}{56}$	$\frac{WB^3B}{28}$	$\frac{B^3B}{58}$	$\frac{B^3B}{78}$
ROW B	$\frac{WB^3B}{29}$	$\frac{WB^3B}{94}$	$\frac{WB^3B}{158}$	$\frac{WB^3B}{183}$	$\frac{WB^3B}{131}$	$\frac{WB^3B}{112}$	$\frac{WB^3B}{139}$	$\frac{WB^3B}{147}$
	$\frac{WB^3B}{60}$	$\frac{WB^3B}{94}$	$\frac{WB^3B}{229}$	$\frac{WB^3B}{183}$	$\frac{WB^3B}{237}$	$\frac{WB^3B}{193}$	$\frac{WB^3B}{142}$	$\frac{WB^3B}{226}$
	$\frac{WB^3B}{120}$	$\frac{WB^3B}{121}$	$\frac{WB^3B}{244}$	$\frac{WB^3B}{189}$	$\frac{WB^3B}{246}$	$\frac{WB^3B}{224}$	$\frac{WB^3B}{193}$	$\frac{WB^3B}{232}$
	$\frac{WB^3B}{15^*135^*}$	$\frac{WB^3B}{61}$	$\frac{WB^3B}{151}$	$\frac{WB^3B}{111}$	$\frac{WB^3B}{219}$	$\frac{WB^3B}{14}$	$\frac{WB^3B}{7^*}$	$\frac{WB^3B}{46}$
	$\frac{WB^3B}{30}$	$\frac{WB^3B}{79}$	$\frac{WB^3B}{211}$	$\frac{WB^3B}{122}$	$\frac{WB^3B}{203}$	$\frac{WB^3B}{123}$	$\frac{WB^3B}{222}$	$\frac{WB^3B}{56}$
ROW C	$\frac{WB^3B}{29}$	$\frac{WB^3B}{114}$	$\frac{WB^3B}{93^*}$	$\frac{WB^3B}{174}$	$\frac{WB^3B}{103}$	$\frac{WB^3B}{205}$	$\frac{WB^3B}{110}$	$\frac{WB^3B}{206}$
	$\frac{WB^3B}{71}$	$\frac{WB^3B}{197}$	$\frac{WB^3B}{156=0}$	$\frac{WB^3B}{117^*}$	$\frac{WB^3B}{186}$	$\frac{WB^3B}{115}$	$\frac{WB^3B}{217}$	$\frac{WB^3B}{155}$
	$\frac{WB^3B}{92}$	$\frac{WB^3B}{209}$	$\frac{WB^3B}{201}$	$\frac{WB^3B}{213^*}$	$\frac{WB^3B}{234}$	$\frac{WB^3B}{118}$	$\frac{WB^3B}{220}$	$\frac{WB^3B}{179}$
	$\frac{WB^3B}{23}$	$\frac{WB^3B}{113}$	$\frac{WB^3B}{39}$	$\frac{WB^3B}{87}$	$\frac{WB^3B}{171}$	$\frac{WB^3B}{55}$	$\frac{WB^3B}{157}$	$\frac{WB^3B}{59}$
	$\frac{WB^3B}{29}$	$\frac{WB^3B}{116}$	$\frac{WB^3B}{114}$	$\frac{WB^3B}{93^*}$	$\frac{WB^3B}{174}$	$\frac{WB^3B}{103}$	$\frac{WB^3B}{205}$	$\frac{WB^3B}{110}$
ROW D	$\frac{WB^3B}{12}$	$\frac{WB^3B}{129}$	$\frac{WB^3B}{44}$	$\frac{WB^3B}{176}$	$\frac{WB^3B}{49}$	$\frac{WB^3B}{145}$	$\frac{WB^3B}{50}$	$\frac{WB^3B}{152}$
	$\frac{WB^3B}{24}$	$\frac{WB^3B}{192}$	$\frac{WB^3B}{104}$	$\frac{WB^3B}{194}$	$\frac{WB^3B}{70}$	$\frac{WB^3B}{196}$	$\frac{WB^3B}{98}$	$\frac{WB^3B}{200}$
	$\frac{WB^3B}{3}$	$\frac{WB^3B}{48}$	$\frac{WB^3B}{11}$	$\frac{WB^3B}{134}$	$\frac{WB^3B}{19}$	$\frac{WB^3B}{76}$	$\frac{WB^3B}{35}$	$\frac{WB^3B}{137}$
	$\frac{WB^3B}{6}$	$\frac{WB^3B}{96}$	$\frac{WB^3B}{26}$	$\frac{WB^3B}{161}$	$\frac{WB^3B}{25}$	$\frac{WB^3B}{100}$	$\frac{WB^3B}{38}$	$\frac{WB^3B}{140}$
	$\frac{WB^3B}{12}$	$\frac{WB^3B}{129}$	$\frac{WB^3B}{44}$	$\frac{WB^3B}{176}$	$\frac{WB^3B}{49}$	$\frac{WB^3B}{145}$	$\frac{WB^3B}{50}$	$\frac{WB^3B}{152}$
ROW E	$\frac{WB^3B}{108}$	$\frac{WB^3B}{102}$	$\frac{WB^3B}{99}$	$\frac{WB^3B}{173}$	$\frac{WB^3B}{109}$	$\frac{WB^3B}{8}$	$\frac{WB^3B}{4}$	$\frac{WB^3B}{40}$
	$\frac{WB^3B}{177}$	$\frac{WB^3B}{153}$	$\frac{WB^3B}{141}$	$\frac{WB^3B}{182}$	$\frac{WB^3B}{181}$	$\frac{WB^3B}{32}$	$\frac{WB^3B}{10}$	$\frac{WB^3B}{130}$
	$\frac{WB^3B}{198}$	$\frac{WB^3B}{204}$	$\frac{WB^3B}{216}$	$\frac{WB^3B}{218}$	$\frac{WB^3B}{214}$	$\frac{WB^3B}{128}$	$\frac{WB^3B}{64}$	$\frac{WB^3B}{160}$
	$\frac{WB^3B}{27}$	$\frac{WB^3B}{51}$	$\frac{WB^3B}{54}$	$\frac{WB^3B}{107}$	$\frac{WB^3B}{91}$	$\frac{WB^3B}{2}$	$\frac{WB^3B}{1}$	$\frac{WB^3B}{10}$
	$\frac{WB^3B}{108}$	$\frac{WB^3B}{102}$	$\frac{WB^3B}{99}$	$\frac{WB^3B}{173}$	$\frac{WB^3B}{109}$	$\frac{WB^3B}{8}$	$\frac{WB^3B}{4}$	$\frac{WB^3B}{40}$
ROW F	$\frac{WB^3B}{18}$	$\frac{WB^3B}{72}$	$\frac{WB^3B}{33}$	$\frac{WB^3B}{132}$	$\frac{WB^3B}{36}$	$\frac{WB^3B}{144}$	$\frac{WB^3B}{9}$	$\frac{WB^3B}{66}$
	$\frac{WB^3B}{33}$	$\frac{WB^3B}{132}$	$\frac{WB^3B}{36}$	$\frac{WB^3B}{144}$	$\frac{WB^3B}{9}$	$\frac{WB^3B}{66}$	$\frac{WB^3B}{34}$	$\frac{WB^3B}{136}$
	$\frac{WB^3B}{36}$	$\frac{WB^3B}{144}$	$\frac{WB^3B}{9}$	$\frac{WB^3B}{66}$	$\frac{WB^3B}{34}$	$\frac{WB^3B}{136}$	$\frac{WB^3B}{5}$	$\frac{WB^3B}{20}$
	$\frac{WB^3B}{9}$	$\frac{WB^3B}{66}$	$\frac{WB^3B}{34}$	$\frac{WB^3B}{136}$	$\frac{WB^3B}{5}$	$\frac{WB^3B}{20}$	$\frac{WB^3B}{17}$	$\frac{WB^3B}{68}$
	$\frac{WB^3B}{18}$	$\frac{WB^3B}{72}$	$\frac{WB^3B}{33}$	$\frac{WB^3B}{132}$	$\frac{WB^3B}{36}$	$\frac{WB^3B}{144}$	$\frac{WB^3B}{9}$	$\frac{WB^3B}{66}$
ROW G	$\frac{WB^3B}{170}$	$\frac{WB^3B}{85}$	$\frac{WB^3B}{0}$	$\frac{WB^3B}{0}$	$\frac{WB^3B}{0}$	$\frac{WB^3B}{0}$	$\frac{WB^3B}{0}$	$\frac{WB^3B}{0}$
	$\frac{WB^3B}{170}$	$\frac{WB^3B}{85}$	$\frac{WB^3B}{0}$	$\frac{WB^3B}{0}$	$\frac{WB^3B}{0}$	$\frac{WB^3B}{0}$	$\frac{WB^3B}{0}$	$\frac{WB^3B}{0}$
	$\frac{WB^3B}{170}$	$\frac{WB^3B}{85}$	$\frac{WB^3B}{0}$	$\frac{WB^3B}{0}$	$\frac{WB^3B}{0}$	$\frac{WB^3B}{0}$	$\frac{WB^3B}{0}$	$\frac{WB^3B}{0}$
	$\frac{WB^3B}{170}$	$\frac{WB^3B}{85}$	$\frac{WB^3B}{0}$	$\frac{WB^3B}{0}$	$\frac{WB^3B}{0}$	$\frac{WB^3B}{0}$	$\frac{WB^3B}{0}$	$\frac{WB^3B}{0}$
	$\frac{WB^3B}{170}$	$\frac{WB^3B}{85}$	$\frac{WB^3B}{0}$	$\frac{WB^3B}{0}$	$\frac{WB^3B}{0}$	$\frac{WB^3B}{0}$	$\frac{WB^3B}{0}$	$\frac{WB^3B}{0}$

Figure F-4. Kernel plots for conversion to thinning tables.

MSB	LSB		MSB	LSB		
.000	0 0 0 0 0 0 0	0	3G	.043	0 0 1 0 1 0 1 1 0	6B
.001	0 0 0 0 0 0 1	1	7E	.044	0 0 1 0 1 1 0 0 0	2D
.002	0 0 0 0 0 1 0	1	6E	.045	0 0 1 0 1 1 0 1 0	8D
.003	0 0 0 0 0 1 1	1	1D	.046	0 0 1 0 1 1 1 0 0	7B
.004	0 0 0 0 0 1 0 0	1	7E	.047	0 0 1 0 1 1 1 1 0	3B
.005	0 0 0 0 1 0 1	0	3F	.048	0 0 1 1 0 0 0 0 1	1D
.006	0 0 0 0 1 1 0	1	1D	.049	0 0 1 1 0 0 0 1 0	3D
.007	0 0 0 0 1 1 1	2	6B	.050	0 0 1 1 0 0 1 0 0	4D
.008	0 0 0 1 0 0 0	1	6E	.051	0 0 1 1 0 0 1 1 0	2E
.009	0 0 0 1 0 0 1	0	1F	.052	0 0 1 1 0 1 0 0 0	5D
.010	0 0 0 1 0 1 0	0	8E	.053	0 0 1 1 0 1 0 1 0	7D
.011	0 0 0 1 0 1 1	0	2D	.054	0 0 1 1 0 1 1 0 0	3E
.012	0 0 0 1 1 0 0	1	1D	.055	0 0 1 1 0 1 1 1 0	5C
.013	0 0 0 1 1 0 1	0	5D	.056	0 0 1 1 1 0 0 0 1	5B
.014	0 0 0 1 1 1 0	1	5B	.057	0 0 1 1 1 0 0 1 0	8B
.015	0 0 0 1 1 1 1	10	1B	.058	0 0 1 1 1 0 1 0 0	7B
.016	0 0 1 0 0 0 0	1	7E	.059	0 0 1 1 1 0 1 1 0	6C
.017	0 0 1 0 0 0 1	0	4F	.060	0 0 1 1 1 1 0 0 1	1B
.018	0 0 1 0 0 1 0	0	1F	.061	0 0 1 1 1 1 0 1 0	2B
.019	0 0 1 0 0 1 1	0	3D	.062	0 0 1 1 1 1 1 0 1	6A
.020	0 0 1 0 1 0 0	0	3F	.063	0 0 1 1 1 1 1 1 1	4A
.021	0 0 1 0 1 0 1	0	8F	.064	0 1 0 0 0 0 0 0 1	7E
.022	0 0 1 0 1 1 0	0	5D	.065	0 1 0 0 0 0 0 1 0	3F
.023	0 0 1 0 1 1 1	1	1C	.066	0 1 0 0 0 0 1 0 0	1F
.024	0 0 1 1 0 0 0	1	1D	.067	0 1 0 0 0 0 1 1 0	5D
.025	0 0 1 1 0 0 1	0	3D	.068	0 1 0 0 0 1 0 0 0	4F
.026	0 0 1 1 0 1 0	0	2D	.069	0 1 0 0 0 1 0 1 0	8F
.027	0 0 1 1 0 1 1	0	1E	.070	0 1 0 0 0 1 1 0 0	3D
.028	0 0 1 1 1 0 0	1	6B	.071	0 1 0 0 0 1 1 1 1	1C
.029	0 0 1 1 1 0 1	1	1C	.072	0 1 0 0 1 0 0 0 0	1F
.030	0 0 1 1 1 1 0	1	1B	.073	0 1 0 0 1 0 0 1 0	5F
.031	0 0 1 1 1 1 1	26	5A	.074	0 1 0 0 1 0 1 0 0	7F
.032	0 1 0 0 0 0 0	1	6E	.075	0 1 0 0 1 0 1 1 0	8D
.033	0 1 0 0 0 0 1	0	1F	.076	0 1 0 0 1 1 0 0 0	3D
.034	0 1 0 0 0 1 0	0	2F	.077	0 1 0 0 1 1 0 1 0	7D
.035	0 1 0 0 0 1 1	0	4D	.078	0 1 0 0 1 1 1 0 0	8B
.036	0 1 0 0 1 0 0	0	1F	.079	0 1 0 0 1 1 1 1 0	2B
.037	0 1 0 0 1 0 1	0	5F	.080	0 1 0 1 0 0 0 0 0	3F
.038	0 1 0 0 1 1 0	0	4D	.081	0 1 0 1 0 0 0 1 0	8F
.039	0 1 0 0 1 1 1	1	2C	.082	0 1 0 1 0 0 1 0 0	5F
.040	0 1 0 1 0 0 0	0	8E	.083	0 1 0 1 0 0 1 1 0	7D
.041	0 1 0 1 0 0 1	0	7F	.084	0 1 0 1 0 1 0 0 0	8F
.042	0 1 0 1 0 1 0	0	6F	.085	0 1 0 1 0 1 0 1 0	2G

Table F-1. Primary thinning table.

MSB		LSB		MSB		LSB	
086	0	1	0	1	0	1	0
087	0	1	0	1	0	1	1
088	0	1	0	1	1	0	0
089	0	1	0	1	1	0	1
090	0	1	0	1	1	0	1
091	0	1	0	1	1	0	1
092	0	1	0	1	1	0	0
093	0	1	0	1	1	0	1
094	0	1	0	1	1	1	0
095	0	1	0	1	1	1	1
096	0	1	1	0	0	0	0
097	0	1	1	0	0	0	1
098	0	1	1	0	0	1	0
099	0	1	1	0	0	1	1
100	0	1	1	0	0	1	0
101	0	1	1	0	0	1	0
102	0	1	1	0	0	1	1
103	0	1	1	0	0	1	1
104	0	1	1	0	1	0	0
105	0	1	1	0	1	0	0
106	0	1	1	0	1	0	1
107	0	1	1	0	1	0	1
108	0	1	1	0	1	1	0
109	0	1	1	0	1	1	0
110	0	1	1	0	1	1	0
111	0	1	1	0	1	1	1
112	0	1	1	1	0	0	0
113	0	1	1	1	0	0	1
114	0	1	1	1	0	0	1
115	0	1	1	1	0	0	1
116	0	1	1	1	0	1	0
117	0	1	1	1	0	1	0
118	0	1	1	1	0	1	1
119	0	1	1	1	0	1	1
120	0	1	1	1	0	0	0
121	0	1	1	1	0	0	1
122	0	1	1	1	0	1	0
123	0	1	1	1	0	1	1
124	0	1	1	1	1	0	0
125	0	1	1	1	1	0	1
126	0	1	1	1	1	1	0
127	0	1	1	1	1	1	1
128	1	0	0	0	0	0	0
7D	1	29	1	0	0	0	0
3C	1	30	1	0	0	0	0
5D	1	31	1	0	0	0	0
7D	1	32	1	0	0	0	0
8D	1	33	1	0	0	0	0
5E	1	34	1	0	0	0	0
1C	1	35	1	0	0	0	0
3C	1	36	1	0	0	0	0
2B	1	37	1	0	0	0	0
7A	1	38	1	0	0	0	0
1D	1	39	1	0	0	0	0
5D	1	40	1	0	0	0	0
4D	1	41	1	0	0	0	0
3E	1	42	1	0	0	0	0
3E	1	43	1	0	0	0	0
7D	1	44	1	0	0	0	0
2E	1	45	1	0	0	0	0
5C	1	46	1	0	0	0	0
2D	1	47	1	0	0	0	0
8D	1	48	1	0	0	0	0
6D	1	49	1	0	0	0	0
4E	1	50	1	0	0	0	0
1E	1	51	1	0	0	0	0
5E	1	52	1	0	0	0	0
6C	1	53	1	0	0	0	0
4B	1	54	1	0	0	0	0
6B	1	55	1	0	0	0	0
1C	1	56	1	0	0	0	0
2C	1	57	1	0	0	0	0
5C	1	58	1	0	0	0	0
1C	1	59	1	0	0	0	0
3C	1	60	1	0	0	0	0
5C	1	61	1	0	0	0	0
8C	1	62	1	0	0	0	0
1B	1	63	1	0	0	0	0
2B	1	64	1	0	0	0	0
3B	1	65	1	0	0	0	0
4B	1	66	1	0	0	0	0
5A	1	67	1	0	0	0	0
7A	1	68	1	0	0	0	0
4A	1	69	1	0	0	0	0
2A	1	70	1	0	0	0	0
6E	1	71	1	0	0	0	0
7D	1	29	1	0	0	0	0
8E	1	30	1	0	0	0	0
5B	1	31	1	0	0	0	0
1F	1	32	1	0	0	0	0
5D	1	33	1	0	0	0	0
2D	1	34	1	0	0	0	0
1B	1	35	1	0	0	0	0
2F	1	36	1	0	0	0	0
4D	1	37	1	0	0	0	0
6F	1	38	1	0	0	0	0
7B	1	39	1	0	0	0	0
4D	1	40	1	0	0	0	0
3E	1	41	1	0	0	0	0
7B	1	42	1	0	0	0	0
6A	1	43	1	0	0	0	0
1F	1	44	1	0	0	0	0
3D	1	45	1	0	0	0	0
7F	1	46	1	0	0	0	0
8B	1	47	1	0	0	0	0
5F	1	48	1	0	0	0	0
7D	1	49	1	0	0	0	0
8D	1	50	1	0	0	0	0
2B	1	51	1	0	0	0	0
4D	1	52	1	0	0	0	0
2E	1	53	1	0	0	0	0
6D	1	54	1	0	0	0	0
6C	1	55	1	0	0	0	0
2C	1	56	1	0	0	0	0
5C	1	57	1	0	0	0	0
3B	1	58	1	0	0	0	0
4A	1	59	1	0	0	0	0
8E	1	60	1	0	0	0	0
2D	1	61	1	0	0	0	0
6F	1	62	1	0	0	0	0
7B	1	63	1	0	0	0	0
7F	1	64	1	0	0	0	0
8D	1	65	1	0	0	0	0
6D	1	66	1	0	0	0	0
3B	1	67	1	0	0	0	0
6F	1	68	1	0	0	0	0
6D	1	69	1	0	0	0	0
1G	1	70	1	0	0	0	0
4C	1	71	1	0	0	0	0

Table F-1. (Continued).

T	X								
2	1	42	1	82	1	122	1	162	0
3	1	43	0	83	1	123	0	163	1
4	1	44	1	84	1	124	1	164	1
5	1	45	1	85	1	125	1	165	1
6	1	46	1	86	1	126	1	166	0
7	0	47	1	87	0	127	1	167	1
8	1	48	1	88	1	128	1	168	1
9	1	49	1	89	1	129	1	169	1
10	1	50	1	90	1	130	1	170	1
11	1	51	0	91	1	131	1	171	1
12	1	52	1	92	1	132	1	172	1
13	1	53	1	93	1	133	1	173	0
14	1	54	1	94	1	134	1	174	1
15	1	55	1	95	0	135	0	175	1
16	1	56	1	96	1	136	1	176	1
17	1	57	1	97	1	137	1	177	1
18	1	58	1	98	1	138	0	178	1
19	1	59	1	99	1	139	1	179	1
20	1	60	1	100	1	140	0	180	1
21	1	61	1	101	1	141	1	181	1
22	1	62	1	102	0	142	0	182	0
23	0	63	1	103	0	143	0	183	1
24	1	64	1	104	1	144	0	184	1
25	1	65	1	105	1	145	1	185	1
26	0	66	0	106	1	146	1	186	1
27	0	67	1	107	0	147	1	187	1
28	0	68	1	108	1	148	1	188	1
29	0	69	1	109	0	149	1	189	1
30	0	70	1	110	1	150	0	190	1
31	1	71	1	111	1	151	0	191	1
32	1	72	1	112	1	152	0	192	1
33	1	73	1	113	0	153	1	193	1
34	1	74	0	114	1	154	1	194	1
35	0	75	1	115	1	155	1	195	1
36	0	76	1	116	1	156	1	196	1
37	0	77	1	117	1	157	1	197	1
38	1	78	1	118	1	158	0	198	0
39	1	79	1	119	1	159	0	199	0
40	1	80	1	120	1	160	0	200	1
41	1	81	1	121	1	161	0	201	1

Table F-2. Secondary thinning table.

Table F-1 lists the entire 256 states of the 3 by 3 kernel. The left column of the table shows the decimal number of the state; the next column list the binary equivalent of this number. The third column of the table assigns the action to be taken regarding the center pel. A "zero" or a "one" in this column indicates, respectively, whether to change the pel in white or leave it black. The fourth and right-most column provides the cross address in figure F-3 of the pattern indicated..

In some addresses, a number other than one or zero in column three indicates a requirement to check the secondary table for a final decision or whether or not to change a pel from black to white.

In the use of the truth table, the binary number of column two becomes the address. The contents of column three, the two unconditional states one or zero, or the conditional state address are stored at the addresses.

For example, at address 007, the table refers to address 0z in the secondary listing, table F-2.

At address 2 of table F-2, there is a block of eight subaddresses related to the base address 2. These eight possible values relate to the previous value of the three (in this case) LSB, table F-1, before they were changed by thinning.

After the tables were developed using values selected by the designers, the tables and a test program were written for the USPS Tektronix 4054 terminal. This program and the truth tables were tested on a number of selected image patterns. Where improvements were needed, values in the primary and secondary truth tables were modified into the present configuration.

The program was then entered into the AED 1024s of the Graphics Conversion Subsystem where effects of thinning of numerous images could be examined at very high zoom magnification. One or two more changes were added to the truth tables to refine them to their present state. As mentioned at the beginning of this discussion, other sets of tables having about one-half of the effect of these could be generated by making only half of the present changes. For instance, thinning only on the top and left of black image areas and character stems or the bottom and right edge only would produce about half the effort of the present algorithm. Changes to the primary and secondary truth tables could probably be completed and entered into the system in one or two man-weeks.

RESULTS

Results of the tests were quite favorable. When the thinning algorithm was incorporated into the software of the Graphics Conversion Subsystem it was given the status of a major work station menu item.

Subimages of graphics captured by the Datacopy camera can be transferred in any size or shape up to 1024 pels wide by 1024 pels high. Here the subimages are edited, then thinned.

To give the operator an accurate view of his graphic, an unthinned version of the image is presented on the AED 1024 monitor. The image which is subsequently sent to the Delphax printer, is the thinned one.

Comparisons of an unthinned graphic image with the same graphic thinned once and thinned twice are shown in figure F-5. The masters of these figures are somewhat less dense than the reproductions shown. The reproduction process for this report also "thickens" images.

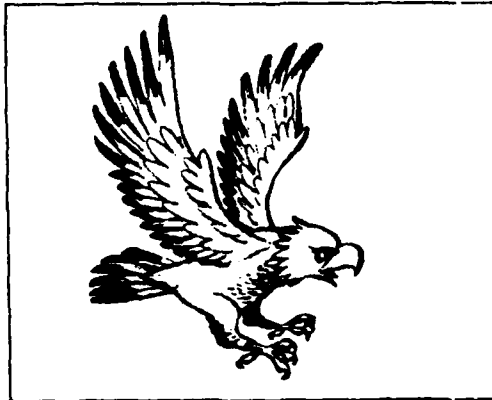

Unthinned graphic image

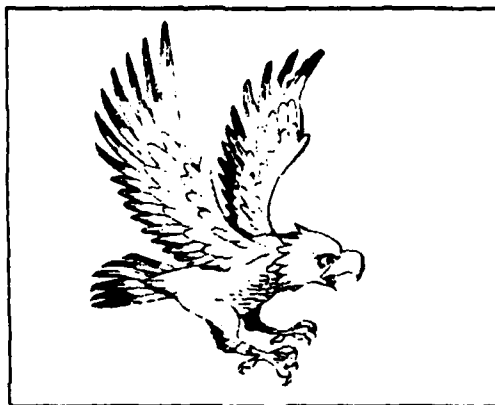

Once-thinned graphic

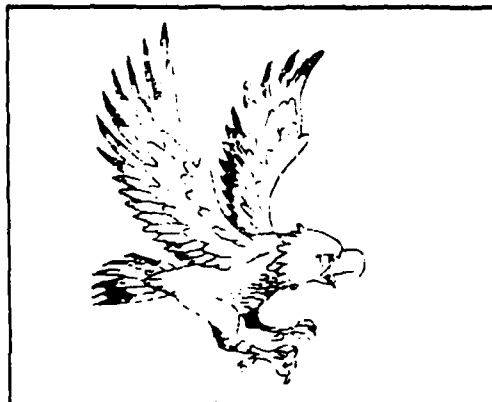

Twice-thinned graphic

Figure F-5. Comparison of thinned and unthinned images printed on the Delphax printer.

APPENDIX G
EXAMPLES OF FACSIMILE DATA COMPRESSION
USING THE TWO-DIMENSIONAL ALGORITHM OF EIA RS-465

FC Martin

December 1983

APPENDIX G CONTENTS

INTRODUCTION . . .	Page G-3
DISCUSSION . . .	G-3
Example 1 . . .	G-4
Example 2 . . .	G-8
CONCLUSIONS . . .	G-9

APPENDIX G ILLUSTRATIONS

G-1.	NOSC purchase requisition . . .	Page G-10
G-2.	Two-dimensional coding flow diagram . . .	G-11

INTRODUCTION

This appendix analyzes two examples of facsimile graphic data. In the examples, the images are each compressed using the two-dimensional (2-D) compression algorithm defined in section 4.2.1.3 of EIA Specification RS-465.

DISCUSSION

The first of these is a hypothetical subsection of a lacy logo. The subsection is 32 pels in length and 4 lines in height. It has many short runs and an average run length of 4.55 pels per run. Such an example may be encountered in logos containing filigree or shading patterns rather than bold block images. This 128-pel image subset required 124 bits to define using the 2-D encoding algorithm. This represents a compression ratio of only 1.03:1.

When a complex compression algorithm is used in the presence of possible noise, a 1-bit error can produce an image that is badly damaged. For a single-bit error, K lines (four in our case) could be obliterated. If the image were transmitted without compression, the same bit error may be almost undetectable. For this reason, it may be practical to test images for compressibility and then make a choice as to whether to transmit and/or store the image data in compressed or uncompressed form. It is of interest to note that the 2-D compression algorithm, at least for this complex example, did not yield a compression ratio of less than unity.

A second example was chosen to test a very favorable candidate for 2-D compressibility. An area of a NOSC procurement form which includes only seven vertical lines was used. If this form were generated by scanning a hardcopy original, the compressibility might be somewhat lower than we have calculated for the example. A computer-generated form will have perfect column redundancy as we have used in the example chosen. The computer-generated version will also have a better physical appearance. For this example, we achieved excellent compressibility. The compression ratio is approximately 50:1.

These two examples tend to bracket the practical limits of 2-D compressibility using RS-465. We feel that almost all real E-Com logo and forms graphics will yield compression ratios between those of the two examples. For this reason, we intend to continue the evaluation of the RS-465 2-D algorithm as time will permit. Future steps will include: (1) considering the benefits of writing compressibility software for the AED or Cambridge Digital processors; (2) testing a number of samples of actual logo and form data; (3) if the results are encouraging, searching for off-the-shelf equipment which encodes and decodes the 2-D RS-465 format at speeds required for E-COM applications, and: (4) if the pay-off seems high but no equipments are found off-the shelf, recommending that NOSC fabricate a pair of prototype converters for use in the prototype Printing Subsystem test setup.

EXAMPLE 1

A HYPOTHETICAL 32-PEL LACY LOGO SAMPLE

```

0 1 2 3 4 5 6 7 8 9 10 11 12 13 14 15 16 17 18 19 20 21 22 23 24 25 26 27 28 29 30
- 0 0 0 0 1 1 0 0 0 0 1 1 1 1 1 1 1 1 0 0 1 0 0 0 0 0 1 1 1 1
- 0 0 0 1 1 1 1 0 0 1 1 1 1 1 1 1 0 0 0 1 1 0 0 0 0 1 1 1 1 1
- 1 1 1 1 1 1 1 1 1 1 0 1 1 1 1 0 0 0 0 0 0 0 0 0 0 0 0 0 0 0 1
- 0 1 1 1 1 1 0 0 0 0 0 0 1 1 1 1 1 0 0 0 0 0 0 0 0 0 0 0 0 0 0
    
```

For the examples, $K = 4$. This requires that row 1 be compressed as variable run length code using modified Huffman Code as listed in paragraph 4.1 of RS-465. The other three rows will be encoded in accordance with par. 4.2.1.3 on two-dimensional coding. For this discussion, a "1" is black and a "0" is white.

To start compression of a document an end-of-line (EOL) code is required. This is:

00000000001 (eleven 0's and one 1).

Encoding of the first row:

```

0 1 2 3 4 5 6 7 8 9 10 11 12 13 14 15 16 17 18 19 20 21 22 23 24 25 26 27 28 29 30
- 0 0 0 0 1 1 0 0 0 0 1 1 1 1 1 1 1 1 0 0 1 0 0 0 0 0 1 1 1 1
    4W      2B      4W              8B              2W  1B      5W      5B
    1011    11     1011              000101          0111 010    1100      0011
    
```

Encoding of the second row:

```

0 1 2 3 4 5 6 7 8 9 10 11 12 13 14 15 16 17 18 19 20 21 22 23 24 25 26 27 28 29 30
- 0 0 0 0 1 1 0 0 0 0 1 1 1 1 1 1 1 1 0 0 1 0 0 0 0 0 1 1 1 1
- 0 0 0 1 1 1 0 0 1 1 1 1 1 1 1 0 0 0 1 1 0 0 0 0 0 1 1 1 1 1
    a0      a1      a2      VL(1):Vertical:VL(2)      VL(1)  V(0)      VL(1)  VL(1)
           010      011      010              000010    010      1        010      010
    
```

Encoding of the Third Row:

```

0 1 2 3 4 5 6 7 8 9 10 11 12 13 14 15 16 17 18 19 20 21 22 23 24 25 26 27 28 29 30
- 0 0 0 1 1 1 1 0 0 1 1 1 1 1 1 1 0 0 0 1 1 0 0 0 0 1 1 1 1 1
- 1 1 1 1 1 1 1 1 1 1 0 1 1 1 1 0 0 0 0 0 0 0 0 0 0 0 0 0 0 0 1
a0 a1 a2
VL(3) : Vertical
000010

```

```

0 1 2 3 4 5 6 7 8 9 10 11 12 13 14 15 16 17 18 19 20 21 22 23 24 25 26 27 28 29 30
- 0 0 0 1 1 1 1 0 0 1 1 1 1 1 1 1 0 0 0 1 1 0 0 0 0 1 1 1 1 1
- 1 1 1 1 1 1 1 1 1 1 0 1 1 1 1 0 0 0 0 0 0 0 0 0 0 0 0 0 0 0 1
a0 a1 a2
Pass
0001

```

```

0 1 2 3 4 5 6 7 8 9 10 11 12 13 14 15 16 17 18 19 20 21 22 23 24 25 26 27 28 29 30
- 0 0 0 1 1 1 1 0 0 1 1 1 1 1 1 1 0 0 0 1 1 0 0 0 0 1 1 1 1 1
- 1 1 1 1 1 1 1 1 1 1 0 1 1 1 1 0 0 0 0 0 0 0 0 0 0 0 0 0 0 0 1
a0 a1 a2
Horizontal: H + M(1B) + M(1W)
: 001, 010, 000111

```

```

0 1 2 3 4 5 6 7 8 9 10 11 12 13 14 15 16 17 18 19 20 21 22 23 24 25 26 27 28 29 30
- 0 0 0 1 1 1 1 0 0 1 1 1 1 1 1 1 0 0 0 1 1 0 0 0 0 1 1 1 1 1
- 1 1 1 1 1 1 1 1 1 1 0 1 1 1 1 0 0 0 0 0 0 0 0 0 0 0 0 0 0 0 1
a0 a1 a2
Vertical VL(1)
010

```

```

0 1 2 3 4 5 6 7 8 9 10 11 12 13 14 15 16 17 18 19 20 21 22 23 24 25 26 27 28 29 30
- 0 0 0 1 1 1 1 0 0 1 1 1 1 1 1 1 0 0 0 1 1 0 0 0 0 1 1 1 1 1
- 1 1 1 1 1 1 1 1 1 1 0 1 1 1 1 0 0 0 0 0 0 0 0 0 0 0 0 0 0 0 1
a0 a1 a2
Pass
0001

```

```

0 1 2 3 4 5 6 7 8 9 10 11 12 13 14 15 16 17 18 19 20 21 22 23 24 25 26 27 28 29 30
- 0 0 0 1 1 1 1 0 0 1 1 1 1 1 1 1 0 0 0 1 1 0 0 0 0 1 1 1 1 1
- 1 1 1 1 1 1 1 1 1 1 0 1 1 1 1 0 0 0 0 0 0 0 0 0 0 0 0 0 0 0 1
a0 a1 a2
Horizontal: H + M(8W) + M(21)
: 001, 10011, 010

```

Encoding of the Fourth Row:

0	1	2	3	4	5	6	7	8	9	10	11	12	13	14	15	16	17	18	19	20	21	22	23	24	25	26	27	28	29	30
-	1	1	1	1	1	1	1	1	1	1	0	1	1	1	1	0	0	0	0	0	0	0	0	0	0	0	0	0	0	1
-	^{b1} 0	1	1	1	1	1	0	0	0	0	^{b2} 0	0	1	1	1	1	1	0	0	0	0	0	0	0	0	0	0	0	0	

^{a0} ^{a1} ^{a2}
 $V_R(1) : \text{Vertical}$
 011

0	1	2	3	4	5	6	7	8	9	10	11	12	13	14	15	16	17	18	19	20	21	22	23	24	25	26	27	28	29	30
-	1	1	1	1	1	1	1	1	1	1	0	1	1	1	1	0	0	0	0	0	0	0	0	0	0	0	0	0	0	1
-	0	1	1	1	1	1	0	0	0	0	0	^{b1} 0	^{b2} 1	1	1	1	1	0	0	0	0	0	0	0	0	0	0	0	0	

^{a0} ^{a1} ^{a2}
 $H+M(5B)+M(6W)$
 001, 0011, 1110

0	1	2	3	4	5	6	7	8	9	10	11	12	13	14	15	16	17	18	19	20	21	22	23	24	25	26	27	28	29	30
-	1	1	1	1	1	1	1	1	1	1	0	1	1	1	1	0	0	0	0	0	0	0	0	0	0	0	0	0	0	1
-	0	1	1	1	1	1	0	0	0	0	0	0	1	1	1	^{b1} 1	0	0	0	0	0	0	0	0	0	0	0	0	0	^{b2} 0

^{a0} ^{a1}
 $V_R(2)$
 000011

0	1	2	3	4	5	6	7	8	9	10	11	12	13	14	15	16	17	18	19	20	21	22	23	24	25	26	27	28	29	30
-	1	1	1	1	1	1	1	1	1	1	0	1	1	1	1	0	0	0	0	0	0	0	0	0	0	0	0	0	0	1
-	0	1	1	1	1	1	0	0	0	0	0	0	1	1	1	1	0	0	0	0	0	0	0	0	0	0	0	0	0	^{b1} 0

^{a0}
 $V_R(2)$
 000011

BIT COUNT OF COMPRESSED FORMAT

4W	1101	04
2B	11	02
4W	1101	04
8B	000101	06
2W	0111	04
1B	010	03
5W	1100	04
5B	0011	04
		<hr/>
		31

V _L (1)	010	03
V _P (1)	011	03
V _L (1)	010	03
V _L (2)	000010	06
V _L (1)	010	03
V(0)	1	01
V _L (1)	010	03
V _L (1)	010	03
		<hr/>
		25

V ₁ (3)	000010	06
Pass	0001	04
H+M(1B)+M(1W)	001,	03
	010,	03
	000111	06
V _L (1)	010	03
Pass	0001	04
H+M(8W)+M(2B)	001,	03
	10100,	05
	010	03
		<hr/>
		40

V _R (1)	011	03
H+M(5B)+M(6B)	001,	03
	0011,	04
	1110	04
V _R (2)	000011	06
V _R (2)	000011	06
		<hr/>
		26

Data Bit Total = 122

There is an end of line, EOL, at the end of each of the four lines. There is also a set of 6 EOLs at the end of a page. Overhead of this type will be required for almost any compression algorithm.

EXAMPLE 2

NOSC Purchase Requisition Form Vertical Column Spacing

There are seven vertical lines on the form shown in figure G-1. In this example we wish to determine the compression ratio obtained for encoding the seven lines, using the two-dimensional compression algorithm of RS-465. Each line is approximately 2 pels wide. The lines are spaced at the following distances (in inches) from the left edge:

0.48
4.15
4.50
5.00
5.85
6.55
7.22

Column heading text and horizontal lines, which constitute the top of a form, will have unique compression codes for a few lines. The horizontal lines will have an extremely high compression ratio. The column heading text will have a fairly low ratio. For the large number of rows defining the long vertical column lines, the compressibility can be determined by the table which follows.

<u>Inches</u>	<u>Run Length</u>	<u>Runs</u>	<u>Makeup Code</u>	<u>Terminating Code</u>	<u>Bits</u>
0.48	115W	64+51	11011	01010100	13
0.49	2B	2		11	2
4.15	878W	832+46	011010010	00000101	17
4.16	2B	2		11	2
4.50	83W	64+19	11011	0001100	12
4.51	2B	2		11	2
5.00	118W	64+54	11011	00100101	13
5.01	2B	2		11	2
5.85	202W	192+10	010111	00111	11
5.86	2B	2		11	2
6.55	166W	128+38	10010	00010111	13
6.56	2B	2		11	2
7.22	158W	128+30	10010	00000011	13
7.23	2B	2		11	2
8.50	306W	256+50	0110111	01010011	15

Total Bits=2040

Total Compressed Bits=121

The first line of the identical lines which follow required 120 bits to encode. The subsequent three identical lines are composed of V(0) codes from RS 465 table 3, page 11. Since there are 7 vertical lines (14 runs per row), and each V(0) requires simply the code "1", only 14 bits are required to define a repeat line. For K = 4, the total bits for four-line sequences is 121 bits plus 3 X 14 bits (163 bits total). This is a four-line average of less than 41 bits per line and yields a compression ratio of $2040/40.75 = 50:1$.

CONCLUSIONS

The EIA RS-465 two-dimensional algorithm for facsimile compression appears to be a promising candidate compression strategy for USPS E-COM graphic images.

The large areas of black texture found, which extend over many rows and columns of pels, are present in many governmental, institutional, and industrial logos. These features should yield compressibility improvements by means of two-dimensional compression algorithms.

Compression techniques requiring dependency on long sequences of digital information are extremely susceptible to catastrophic and unrecoverable damage to imagery in the presence of bit errors and are not recommended for noisy communication channels or marginal storage media unless error detection and correction provisions are added to the system.

An example of a very lacy logo has been shown to have a compression ratio of approximately 1:1. An example of vertical ruled lines in a typical business form has been shown to have a compression ratio of approximately 50:1.

If graphics are used in the future E-COM system, the two-dimensional EIA RS-465 compression algorithm should be considered as a candidate. More statistical information is needed to verify that compression ratios of between 10:1 and 50:1 may be achievable.

STUB REQUISITION
 NOSC-SD 4235/4 (REV. 11-83)

See NOSC/INST 4200.5 for
 Preparation Instructions

Page of

1. CODE		STUB NUMBER	
2. ESTIMATED COST			
REQUISITION/PROCUREMENT NUMBER			
DISCOUNT TERMS		DELIVERY DATE	
ACCOUNTABLE PROPERTY		PEC	
CONTRACTOR		PHONE NUMBER	
NAME OF CONTACT		3. FROM REQUESTER'S NAME	
4. EXTENSION		5. OTHER THAN NOSC (Complete Block 28)	
6. JOB ORDER		7. FUND EXPIRATION DATE	
8. FUNDED BY PROJECT ORDER? <input type="checkbox"/> NO <input type="checkbox"/> YES		DATE/SIGNATURE OF BUYER	
9. TYPE OF FUNDING <input type="checkbox"/> OVERHEAD <input type="checkbox"/> ROT&E <input type="checkbox"/> O&MN <input type="checkbox"/> OTHER		10. GFE/GFM AUTHORIZED? <input type="checkbox"/> NO <input type="checkbox"/> YES (Give Sponsor order No.)	
11. SELF SOURCE? <input type="checkbox"/> NO <input type="checkbox"/> YES (Attach justification)		12. ACCEPT SUBSTITUTE? <input type="checkbox"/> NO <input type="checkbox"/> YES	
13. DATE MAT'L REQUIRED MONTH DAY YEAR		14. PRIORITY (11/18, justify in blk 29)	
15. DELIVER TO NAME		16. EXTENSION	
17. CODE		18. LOCATION <input type="checkbox"/> T <input type="checkbox"/> B <input type="checkbox"/> S <input type="checkbox"/> OTHER	
19. BLUG/TRAILER		20. ROOM	
*REQUESTER'S CERTIFICATION The requester signing in Block 21 certifies that this procurement conforms to the sponsor's intended use of the funds cited herein.			21. *REQUESTER'S SIGNATURE
22. DATE		23. APPROVAL SIGNATURE	
24. DATE		25. INTERNAL APPROVAL SIGNATURE	
26. CODE		27. DATE	
28. APPROPRIATION SUBHEAD		OBJ CL BU CONT NO AAA TYPE PAA COST CODE	
29. A ITEM	B DESCRIPTION (Stock No., Manufacturer, Model/Part No., Etc.) SINGLE SPACE INFO ON EACH ITEM, TRIPLE SPACE BETWEEN ITEMS For additional items, use Continuation form NOSC-SD 4235/4A		
	C R/N	D UNIT OF ISSUE	E ESTIMATED UNIT PRICE
			F QUANTITY
			G UNIT PRICE
			H TOTAL COST
(Encoded Line Set)			
30. PROCUREMENT SERVICE CENTER JOB ORDER		31. PROCUREMENT SERVICE CENTER FEE	
32. RECEIPT SIGNATURE		33. DATE RECEIVED	
34. <input type="checkbox"/> Cannot meet date material required through supply system <input type="checkbox"/> No standard stock material is suitable <input type="checkbox"/> Material is not available Naval Supply Center, San Diego			

*R = Recurring Demand. N = Non-recurring Demand

1

Figure G-1. NOSC purchase requisition.

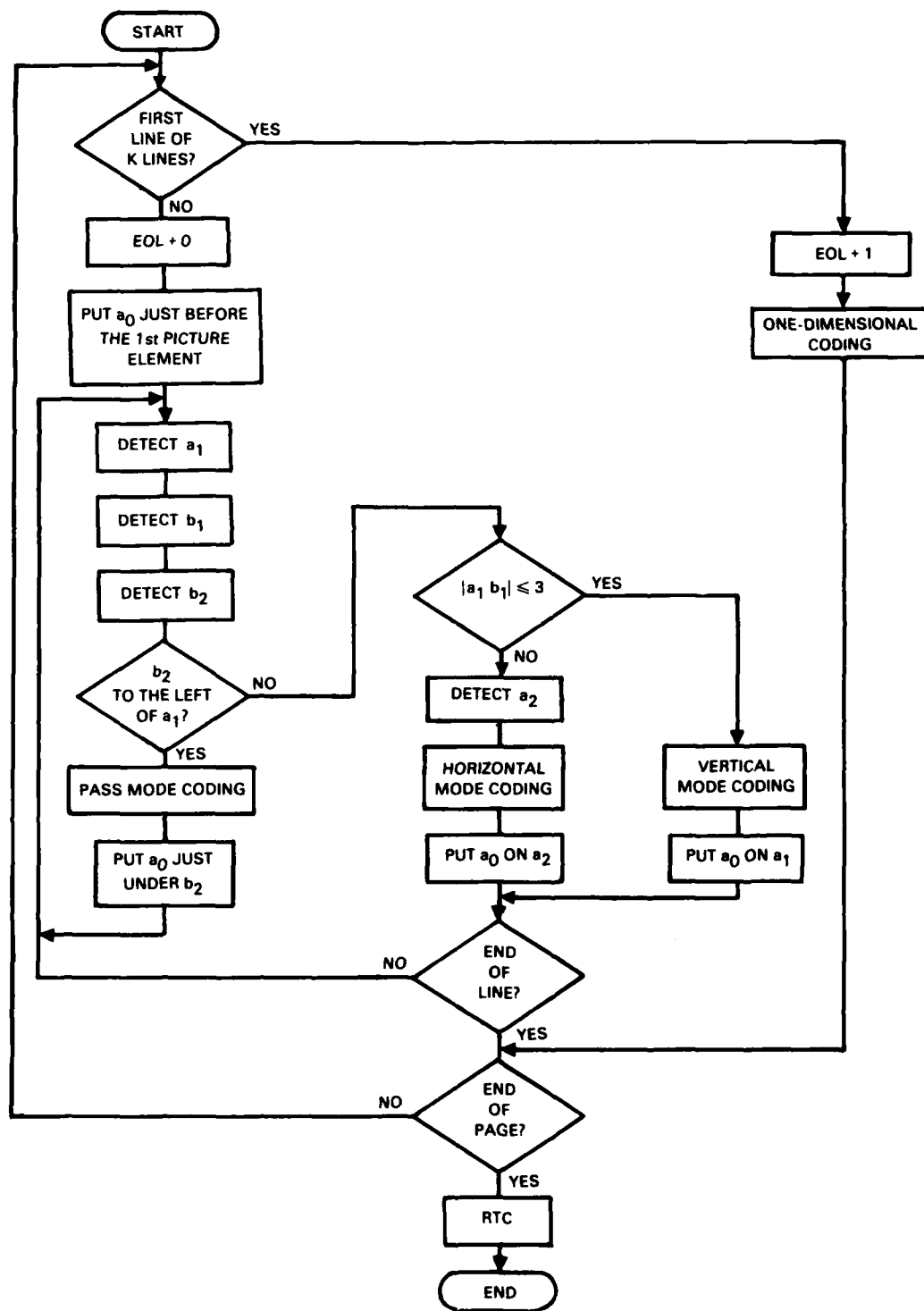

Figure G-2. Two-dimensional coding flow diagram.

END

FILMED

12-85

DTIC