

F-03 (550)
Rev. 6/64

MICROTAPE

555 TAPE TRANSPORT / 550 TAPE CONTROL / PROGRAMS

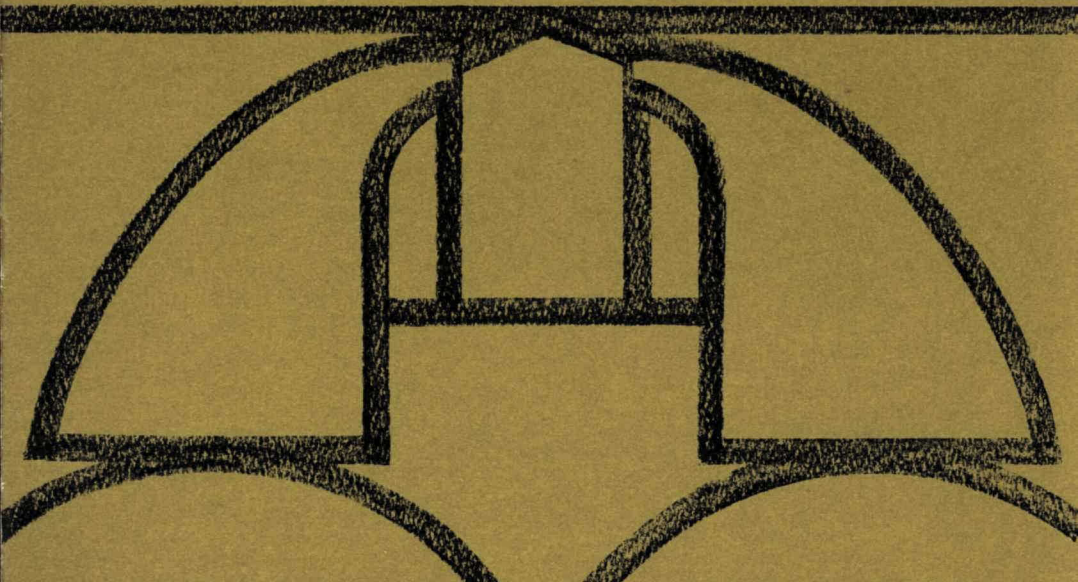

DIGITAL EQUIPMENT CORPORATION • MAYNARD, MASSACHUSETTS

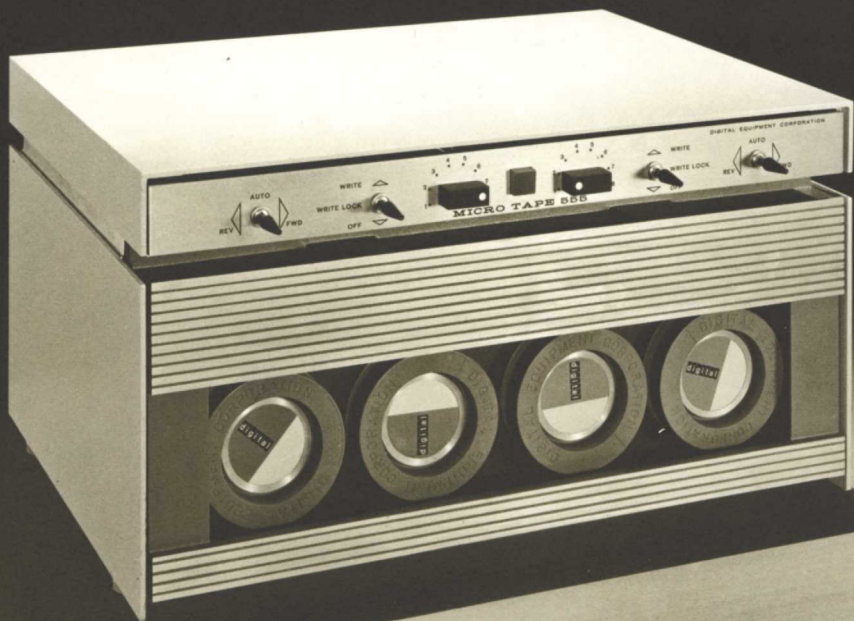

MICROTAPE

... a fast, reliable, low cost in-out facility and updating device.

Microtape represents a significant new concept in magnetic tape systems. Its simplicity of mechanical design coupled with an ingenious tape format and unusual method of recording, bring to industry a fast, convenient, reliable low cost in-out facility and updating device. Special features include:

FIXED POSITION ADDRESSING Permits selective updating of taped information. Units as small as a single word may be placed on tape without disturbing adjacent information.

SIMPLE TRANSPORT MECHANISM Keeps the cost of the unit low without loss of reliability. Microtape's simple drive system, which requires no capstans, no pressure pad, and no mechanical buffering, reduces tape and head wear.

POCKET-SIZE REELS Handy to carry, easy to load. Each 3½ inch reel holds up to 3 million bits, the equivalent of 4,000 feet of paper tape, assuming 6-bit words are used. The compact transport occupies less than two cubic feet, fits standard rack mounts.

BI-DIRECTIONAL OPERATION Saves time, provides easy access to stored information. Reading, writing, and searching may be conducted in either direction.

REDUNDANT, PHASE RECORDING Insures transfer reliability, reduces problem of skew in bi-directional operation. Each tape track is redundantly paired with a second, non-adjacent track. Use of phase (rather than amplitude) recording greatly reduces drop-outs due to variations in amplitude.

PRE-RECORDED TIMING AND MARK TRACKS Simplify programming. Relieve the programmer of the responsibility of furnishing timing or counting instructions and permit block and word addressability.

PRE-TESTED SUBROUTINES Pre-programmed subroutines are available for information storage and retrieval, maintenance, and diagnostic functions.

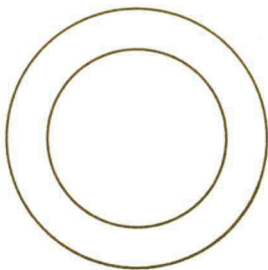

3

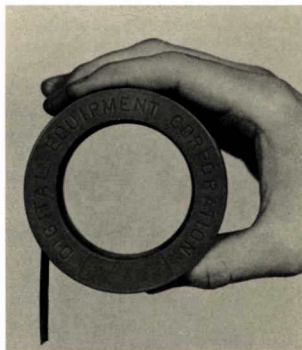

MICROTAPE DUAL TRANSPORT 555

The Microtape Type 555 Dual Tape Transport consists of two logically independent tape drives capable of handling 260 foot reels of $\frac{3}{4}$ inch, 1.0 mil Mylar tape. The bits are recorded in the Manchester or Phase Recording system at a density of 375 ± 60 bits per track inch at a speed of 80 inches per second. An effective information transfer rate of 90,000 bits per second is achieved. Individual 18 bit words which are assembled by the Tape 550 Microtape Control arrive at the computer approximately every 200 microseconds; for example, a 256 word block will be transferred in 53 milliseconds. The Control permits searching, reading and writing in either direction. Tape motion starts upon command and continues until stopped by the program or end of tape indications.

The Type 555 Transport allows simultaneous writing in three redundantly recorded information tracks while at the same time reading in two other redundantly recorded control tracks. Fixed addressing enables the Microtape system to replace individual words or blocks of information on the tape.

MICROTAPE CONTROL 550

(Word Organized Program Interrupt Mode for PDP-1, PDP-4)

The Microtape Control Type 550 will operate up to four Type 555 Dual Tape Transports (8 drives) transferring binary data between tape and computer. By using the automatic Mark track decoding of the control and the program interrupt facility of the computer to signal the occurrence of data words, errors, or block ends, computation in the main program can continue during tape operations. Information can be transferred with programmed checking by using the subroutines which are provided with the equipment. Format control tracks, tailored to individual use by establishing any desired block lengths can also be written with the subroutines provided. The Control allows reading and writing of any number of words at one mode command irrespective of the block length. Assembly of lines on the tape into 18 bit computer words in either direction is performed automatically by the Control. Status bits available to the program specify the current condition of the Control and error indications.

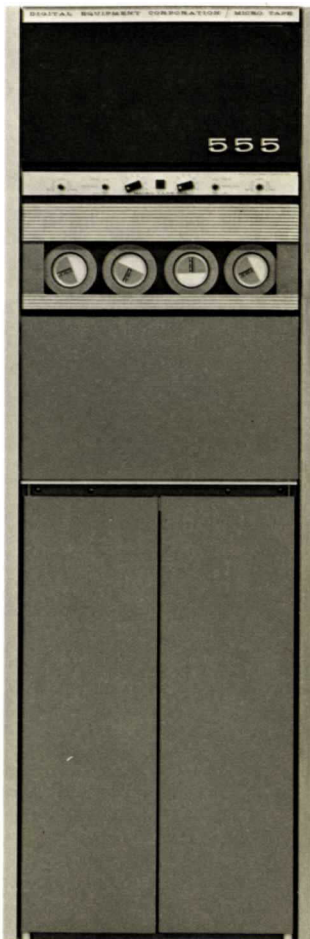

AVAILABLE PROGRAMS

Three main groups of Programs are provided with the Microtape Systems for both the PDP-1 and the PDP-4. They include a basic set of subroutines for searching, reading and writing; a set of maintenance and diagnostic routines (MICROTOG); and a program for easy storage and retrieval of information via the computer console (MICROTRIEVE).

PDP-1

The basic subroutines are designed to read or write any number of words in either direction depending on the current position of the tape and the direction in which it must be searched. Data will be transferred starting with the beginning or ending of the area in core storage based on whether the tape is moving in the forward or reverse directions respectively. This allows the direction of reading to be independent of the direction of writing without destroying the normal order of the words in memory. The read and write subroutines automatically enter the search subroutine to find the block requested. When the transfer is completed the tape is stopped and a register is set to indicate the status of both the subroutines and the Microtape. All blocks are written with the correct check sum and checked when read.

Incomplete blocks are filled with zeroes when writing and these zeroes are ignored when reading. Should any error occur, a return is made to a pre-designated location with the tape stopped and the contents of the status register in the IO. The two main restrictions are, that the programmer must indicate the block length by presetting a register once, and that all blocks must be of that same length. Programs have been written in MACRO for both the single channel and 16 channel sequence break systems. Multiprogramming is permitted only during searching however as the total machine time is pre-empted during actual data transfer. The sub-

routines are used by both MICROTOG and MICROTRIEVE which are explained below.

A sample sequence of instructions for transferring core locations 1000 through 1777 beginning with block 100 on tape unit 1 would appear as follows:

```
LIO (1)      /Unit Number
LAC (100)    /Block Number
JDA MMT      /Transfer to subroutine
1000         /Starting Address
1777         /Ending Address Inclusive
MWR          /Or MRD for Reading
JMP ERR      /Error Return
```

MICROTOG is a collection of fairly short programs which allow the user to perform various Microtape functions using the test word switches on the console. Programs available include those which create the Mark track and block format, read or write designated portions of the tape, write specified patterns on designated blocks in either direction, sum check designated blocks in either direction, "rock" the tape in various modes for specified times or distances, and an exerciser which writes and sum checks designated areas of the tape in both directions with changing patterns. Errors are completely analyzed and typed out together with the number of the block causing the error and the status of the Microtape system at the time of the error. Detailed descriptions of the various sub-programs are available.

MICROTRIEVE allows the user to save or retrieve data using Microtape and parameters set in the test word switches. It is available for high and low memory. When storing data the program will search for the block indicated and write the indicated area together with some control data. The computer halts with the number of the last block used, which is displayed in the AC. The information is retrieved, by setting the correct parameters in the TW switches.

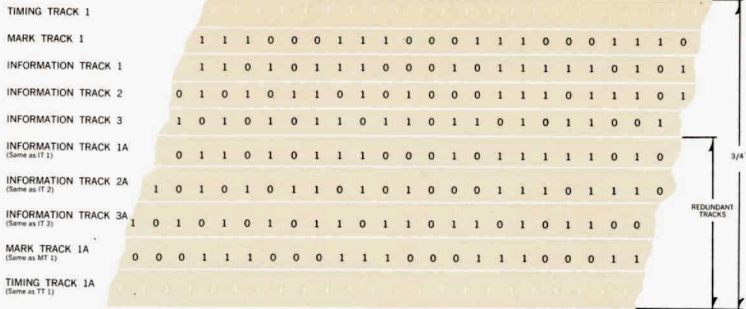

Figure 1 Track Allocation Showing Redundantly Paired Tracks

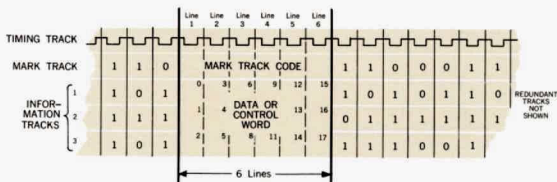

Figure 2 Basic Six Line Tape Unit

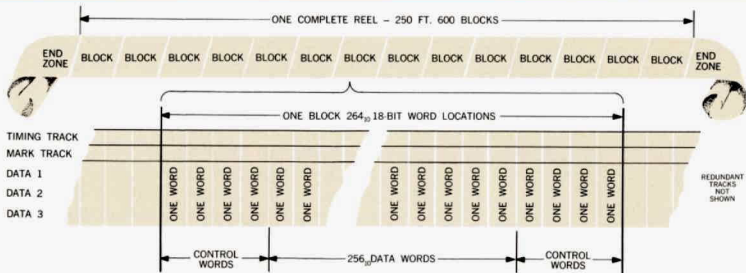

Figure 3 Control And Data Word Assignments

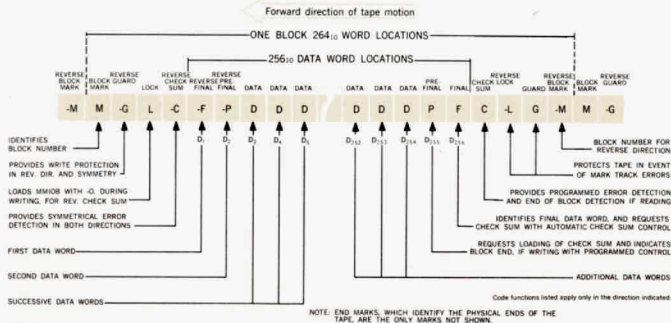

Figure 4 Microtape Mark Track Format (Assumes 256₁₀ Data Words Per Block)

... a significant new concept in magnetic tape systems

MICROTAPE FORMAT

Microtape utilizes a ten track recording head to read and write five duplexed channels. Three of these track pairs are available for data, the two remaining pairs are used for timing and mark information. Duplication of each track by a second, non-adjacent track wired in series, and its relative placement on the tape, eliminates most drop-outs and minimizes the effect of skew. (See Figure 1.)

Six successive lines on the tape represent the basic unit of storage and contain one 18-bit word (Data or Control) which is assembled by the computer, a 6-bit Mark track code, and 6 timing marks or bits. (See Figure 2.)

Depending upon the format used, a complete reel of tape contains 600 information blocks.* (See Figure 3.) Microtape has no inter-record gaps however, the information portions of adjacent blocks

MODES OF OPERATION

There are three main programmed modes of operation which require the user to transfer information between the Microtape system and the central computer. These are the "Search", "Read", and "Write" modes. (A fourth mode, "Move", simply moves the tape without supplying or requesting information and is used primarily for re-winding.)

When the system is ready to transfer information, certain flags or status bits are set.* When these occur, the programmer must either load new information to be written, or unload information just read, within a specified time to prevent loss of information and error indications.

PROGRAM INTERRUPT LOGIC

In the Read and Write modes, Data flags and associated program interrupts are generated (every 200 microseconds), as each 18-bit word is ready for transfer between Microtape's Input-Output Buffer (MMIOB) and the computer. In the Search mode, Data flags are raised as each block address is read (every 53 milliseconds). Block End flags which occur

are separated by Control words. There are two types of words located on the information tracks: Data words and Control words. Control words record address and checking information and Data words contain stored information. Both are assembled by the Control from six successive lines on the tape.

MARK TRACK — KEY TO THE SYSTEM

Key to the system is Microtape's pre-recorded Mark track which is used to raise flags in the program, create sequence breaks, detect block mark numbers and block ends, and protect control portions of the tape. In addition, the Mark track provides Microtape with automatic bi-directional compatibility, variable block format, and end of tape sensing. (See Figure 4.)

*For the purpose of understanding, the term "block" refers to a record on the tape consisting of 256₁₀ eighteen bit words plus associated Control words. Note however, that there is nothing inherent in the present system, or necessarily desirable, about blocks with the indicated length.

during reading signify that the end of the block has been reached and that the check sum is ready for transfer. During writing, a Block End flag signifies the end of the block and is a request to load the programmed check sum word for recording on tape. Error flags are raised by end sensing, missed transfer, Mark track errors, or tape unable conditions.

UNIT SELECTION

Any one of Microtape's 8 tape drives may be selected for use by the programmer. After using a particular drive, the programmer has the following choices: 1) he may stop the drive currently being used and select a new drive, or 2) select another drive while permitting his original selection to continue running. This is a particularly useful feature when rapid searching is desired since several transports may be used simultaneously. Caution must be exercised however, for although the earlier drive continues to run, no end detection or other sensing is taking place.

*If the program interrupt mode is being used, assume that the setting of any of the flags or status bits mentioned also causes a sequence break in which the cause of the break must be determined.

AVAILABLE PROGRAMS (continued)

PDP-4

8 The basic PDP-4 subroutines for reading, writing, or searching allow the user to specify the total number of words to be transferred irrespective of the block format on the tape. Searching can occur in either direction, and the search routine can be used independently to position the tape or is used automatically by the read and write subroutines. Transfer of data in this program, however, will occur only with the tape moving in the forward direction. If the number of words specified is not a multiple of the aggregate block lengths, the final block is filled with zeroes which are ignored upon reading. The subroutines use the program interrupt during searching, but will pre-empt the computer during the actual transfer of data. One auto-index register is used and must be defined by the main program and "DISMIS" must be defined as a jump to the routine which dismisses the interrupt. When the transfer is completed a programmed status register is set and a return is made to the main program with the tape stopped. Errors are detected, coded numerically, saved in status bits and indicated by a pre-designated error return. The programmer can decode the error and proceed in any manner desired. Approximately 400₈ words of storage are used. A sample sequence of instructions for transferring core locations 1000 through 1777 beginning with block 100 on tape unit 1 would appear as follows:

JMS MMWRS	/Or MMRDS for Reading
LAW 100	/Or LAC (100) Block Number
JMP ERR	/Error Return
10000	/Unit Selection
LAW 1000	/Or 1000, Core Starting Address
LAW 1777	/Or 1777, Core Final Address

MICROTOG for the PDP-4 is a collection of short programs which allow the user to perform various Microtape functions using the Accumulator Switches on the console. A brief description of the types of programs is given under the description of MICROTOG for the PDP-1.

MICROTRIEVE for the PDP-4 allows the user to save or retrieve data using the Accumulator Switches on the console. To store data the user specifies the unit, block number and starting and ending core locations. The data will be saved together with appropriate control information and sum checked. To retrieve the data only the unit and starting block need be specified since the control information will be used to guarantee that a correct starting block was requested, and the starting core location and amount of data which must be read. Messages typed after reading or writing indicate the operation, tape blocks used and the total check sum for verification purposes. All errors are fully analyzed as in MICROTOG. Tapes are available for 4K or 8K memories and for the first or second Microtape controls.

Additional programs for Microtape are presently being developed and will be added to our program library as soon as they become available.



MICROTAPE INSTRUCTION LIST

PDP-1 MNEMONIC	PDP-1 BINARY	PDP-4 MNEMONIC	PDP-4 BINARY	FUNCTION
<i>mrd</i>	720501	<i>mmerd</i>	707512	READ. Clears IO or AC and transfers one word from MMIOB to bits 0-17 of IO (PDP-1) or AC (PDP-4).†
<i>mwr</i>	720601	<i>mmwr</i>	707504	WRITE. Transfers one word from bits 0-17 of IO (PDP-1) or AC (PDP-4) to MMIOB.†
<i>mse</i>	720301	<i>mmse</i>	707644	SELECT. Connects the unit designated in bits 2-5 of the IO (PDP-1) or AC (PDP-4) to the Microtape Control.†
<i>mlc</i>	720401	<i>mmic</i>	707604	LOAD CONTROL. Sets the Microtape Control to the proper mode and direction from bits 12-17 of the IO (PDP-1) or AC (PDP-4), as follows:† Bit 12 = Go (Go = Stop) Bit 13 = Reverse Bit 14 = Spare Bits 15-17 = Mode: 0 = Move 1 = Search 2 = Read 3 = Write 4 = Spare 5 = Read through block ends 6 = Write through block ends 7 = Write timing and mark track i.e. 42 = Read Forward 62 = Read Reverse 43 = Write Forward 41 = Search Forward 61 = Search Reverse
<i>mrs</i>	720701	<i>mmrs</i>	707612	READ STATUS. Clears the IO or AC and transfers the Microtape status conditions into bits 0-8 of the IO (PDP-1) or AC (PDP-4) as follows: Bit 0 = Data Flag Bit 1 = Block End Flag Bit 2 = Error Flag Bit 3 = End of Tape Bit 4 = Timing Error Bit 5 = Reverse Bit 6 = Go Bit 7 = Mark Track Error Bit 8 = Tape Unable
		<i>mmdf</i>	707501	Skip on Microtape Data Flag. In Search Mode: Block mark number should be unloaded via (<i>m</i>) <i>mrd</i> instruction. In Read Mode: Data or Reverse Check Sum should be unloaded via (<i>m</i>) <i>mrd</i> instruction. In Write Mode: Data should be loaded via (<i>m</i>) <i>mwr</i> instruction.
		<i>mmbf</i>	707601	Skip on Microtape Block End Flag. In Read Mode: Unload forward Check Sum via (<i>m</i>) <i>mrd</i> instruction. In Write Mode: Load calculated forward Check Sum via (<i>m</i>) <i>mwr</i> instruction.
		<i>mmef</i>	707541	Skip on Microtape Error Flag. Timing Error, Mark Track Error, End Tape, or Tape Unable Condition has occurred. Use (<i>m</i>) <i>mrs</i> instruction to detect specific error.

†*mmse* and *mmic* clear the Error Flag and error status bits (EOT, TIMING MTE, UNAB) and *mmse*, *mmic*, *mmerd*, and *mmwr* clear the Data and Block End Flags.

MICROTAPE OPERATION CHART 550 CONTROL

FLAG	In the Move Mode	In the Search Mode	In the Read Mode	In the Write Mode
<p>DATA FLAG</p> <p>cleared on <i>mmrd</i> <i>mmwr</i> <i>mmic</i> <i>mmse</i></p> <p>This flag causes a program interrupt on PDP-4 or a sequence break on PDP-1.</p>	<p>No Data Flags raised. Tape motion is continuous until End Marks are sensed at far end of tape.</p>	<p>Data Flag means that the MIOB contains a Block Number. Write mode may be specified within 400 microseconds for data transfer the block. Read mode may be specified within 600 microseconds.* Any other mode (including Stop), may be commanded at any time. Transfer of Block Number must be completed in 53 milliseconds to avoid a MISS.†</p>	<p>Data Flag means that MIOB contains a Data word. An <i>mmrd</i> must be given within 200 microseconds for data transfer. First Data Flag in block indicates Reverse Check Sum. Change to other modes possible within 200 microseconds. If Write mode is desired, a one word delay occurs after <i>mmwr</i> is given. O→GO (STOP), is permitted at this point. Complete block must be read, however to obtain error check.</p>	<p>Data Flag means that MIOB is ready for Data word. An <i>mmwr</i> must be given within 200 microseconds for data transfer. Initial (—0) Check Sum is written automatically. First flag in block is a request for first Data word. Change of mode possible within 200 microseconds. Since tape system is bidirectional, the initial Check Sum written may be placed at either Forward or Reverse Check Sum location in the block, depending only on direction commanded. Change of mode commanded at last Data word (D₂₄) is delayed while Check Sum is written. STOP command not permitted in normal programming.</p>
<p>BLOCK FLAG</p> <p>cleared on <i>mmrd</i> <i>mmwr</i> <i>mmic</i> <i>mmse</i></p> <p>This flag causes a program interrupt on PDP-4 or a sequence break on PDP-1.</p>	<p>Should not occur.</p>	<p>Should not occur.</p>	<p>Block Flag means that Check Sum is in MIOB. First Data Flag of next block will automatically occur in 1.4 milliseconds unless STOP is commanded. Change to Search mode must be made in next 800 microseconds in order to catch next mark. Change to Write mode must be made within next 1.2 milliseconds in order to start new block (not recommended. Block Number should be checked by Search mode).</p>	<p>Block Flag means that Check Sum should be loaded into MIOB with an <i>mmwr</i>. First Data Flag of next block will occur in 1.6 milliseconds. Change to Search mode must be made within 1.2 milliseconds to read next Block Number. Preferred method of stopping is to change to Search mode, then check succeeding Block Number for correctness before stopping. STOP may be commanded after 400 microseconds if desired.</p>
<p>ERROR FLAG</p> <p>cleared on <i>mmse</i> <i>mmic</i> (also clears MISS, END, MTE)</p> <p>This flag causes a program interrupt on PDP-4 or a sequence break on PDP-1.</p>	<p>Error Flag means that an error has occurred. An <i>mmrs</i> command will load AC bits 0-8‡ with status information. (END and UNABLE are only possible errors.) END Status bit is set when tape reaches far end. Error Flag is raised. Tape stops automatically. UNABLE Status bit is set when improper unit selection occurs.</p>	<p>Error Flag means that an error has occurred. An <i>mmrs</i> command will load AC bits 0-8‡ with status information. (END, UNABLE and MISS are only possible errors.) END Status bit is set when tape reaches far end. Error Flag is raised. Tape stops. MISS Status bit is set when a Data or Block Flag has not been cleared from previous use. UNABLE Status bit is set when improper unit selection occurs.</p>	<p>Error Flag means that an error has occurred. An <i>mmrs</i> command will load AC bits 0-8‡ with status information. (END, MISS, UNABLE, Mark Track Error (MTE) are only possible errors.) END status bit is set when tape reaches far end. Error Flag is raised. Tape stops. MISS status bit is set when a Data or Block Flag has not been cleared from previous use. MTE Status bit is set upon discovery of certain Mark Track and timing track errors. UNABLE Status bit is set when improper unit selection occurs or when the WRITE LOCK switch is on when in Write mode. No writing occurs.</p>	

*All times are nominal for forward direction. In reverse direction, add $\pm 20\%$.

†MISS indicates a programmed timing error; i.e., information will be lost (missed) because the routine is taking too long to transfer data to or from the buffer.

‡Operation for the PDP-1 is similar except that the IO is referenced rather than the AC and the Microtape flags are read into the IO and sampled rather than using Skip On Microtape Flag instructions.

MICROTAPE SPECIFICATIONS

CAPACITY

- a. 577₁₀ blocks of 256₁₀ words (18 bits).
- b. 768 6-bit characters per block or 256₁₀ 18-bit Data words. (Any block length possible.)
- c. 260 feet of 3/4 inch tape on 3 1/2 inch reel. 1.0 mil Mylar.
- d. 375 (± 60) 3-bit characters per inch.
- e. 3 x 10⁶ bits per reel assembled into computer length words by control.

TRANSFER RATE

- a. 15 KC character rate.
- b. In reverse, transfer rates vary 20% as reels change diameter.
- c. 256₁₀ words read or written in 53 milliseconds. When moving forward.
- d. Transfer requires 60% of cycles for PDP-4. (No interrupt.)
- e. Transfer requires 60-70% of cycles for PDP-1. (Without interrupt.)
- f. Transfer requires 70% of cycles for PDP-1. (With interrupt.)

ADDRESSING

- a. Mark and timing track allow search for particular block and word.
- b. 40 seconds "Worst Case" access. Average 20 seconds. Typical 5 seconds.
- c. Start time is <300 milliseconds, stop time is <150 milliseconds, turn-around time is <300 milliseconds.
- d. Start and stop distances are approximately <8 inches.
- e. When a command to reverse direction is given at a certain tape location, the system is up to speed when that same location passes the head after turn around.

COMPUTER TIMING CONSIDERATIONS

- a. Search
PDP-1 requires 7 sequence break memory cycles every 53 milliseconds to compare block mark code. PDP-4 requires 12 memory cycles every 53 milliseconds to compare block mark code.
- b. Transfer
Program interrupts occur every 200 ± 10 μ sec when traveling in forward direction. In reverse, timing varies from 160 to 240 μ sec per word depending on location on reel.

PHYSICAL SPECIFICATIONS

555 TRANSPORT

- a. 12" x 19" for dual transport.
- b. Weight 65 lbs.
- c. Power requirements: 115 Volts DC, 60 cycle, 1.5 amperes, idle, 3.2 amperes maximum.

550 CONTROL

- a. 16" x 19" for control which operates four dual 555 transports. (Requires 3 rack panels plus space for two standard I-O plugs.)
- b. Power requirements: 115 Volts AC, 60 cycle, 4 amperes. The Type 728 and 734 Power Supplies and Type 811C Power Control are included with the 550 Control.

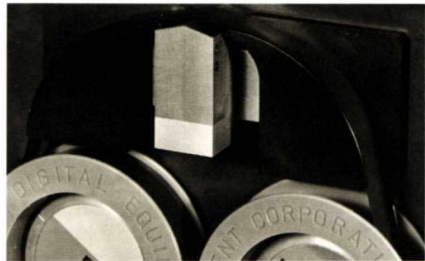

digital

**EQUIPMENT
CORPORATION**

MAYNARD, MASSACHUSETTS

Los Angeles • Palo Alto • Pittsburgh
Washington, D.C. • Parsippany, N.J.
Chicago • Ottawa • Munich, Germany
Reading, England • Sydney, Australia