

2640B/N/S

Display Terminal

Reference Manual



2640B/N/S

Display Terminal

Reference Manual



HEWLETT-PACKARD COMPANY
19400 HOMESTEAD ROAD, CUPERTINO, CA. 95014

NOTICE

The information contained in this document is subject to change without notice.

HEWLETT-PACKARD MAKES NO WARRANTY OF ANY KIND WITH REGARD TO THIS MATERIAL, INCLUDING, BUT NOT LIMITED TO, THE IMPLIED WARRANTIES OF MERCHANTABILITY AND FITNESS FOR A PARTICULAR PURPOSE. Hewlett-Packard shall not be liable for errors contained herein or for incidental or consequential damages in connection with the furnishing, performance or use of this material.

Hewlett-Packard assumes no responsibility for the use or reliability of its software on equipment that is not furnished by Hewlett-Packard.

This document contains proprietary information which is protected by copyright. All rights are reserved. No part of this document may be photocopied, reproduced or translated to another program language without the prior written consent of Hewlett-Packard Company.

This manual contains detailed programming and accessory information for the HP 2640B, HP 2640N, and HP 2640S Display Terminals. It is written to provide a system programmer with the information needed to use the terminal in a variety of applications. Extensive information explaining the operation of the terminal's data communication function is provided in a separate section.

The HP 2640N and HP 2640S terminals use special Danish/Norwegian and Swedish/Finnish character sets for both the keyboard and display characters. The graphic symbols for some of the ASCII character codes have been changed to provide these special character graphics.

The programming functions selected by these ASCII codes remain the same. All references in this manual to ASCII characters used in escape or control sequences will use the standard ASCII character graphic. A table of the changed character graphics is given below.

OCTAL VALUE	DECIMAL VALUE	ASCII GRAPHIC	2640N GRAPHIC	2640S GRAPHIC
133	91	[Æ	Ä
134	92	\	Ø	Ö
135	93]	Å	Å
136	94	^	Û	^
173	123	{	æ	ä
174	124		ø	ö
175	125	}	å	å
176	126	~	ü	—

In addition, the placement of characters on the terminal keyboard has been altered on the HP 2640N and HP 2640S terminals to accommodate the new graphic characters. Additional information on the HP 2640N and HP 2640S is contained in the respective User Manual.

This manual assumes that you are already familiar with operating the terminal from the keyboard. Operating information is given in the following manuals:

- 2640B — HP 2640B Display Terminal User's Manual (02640-90109).
- 2640N — HP 2640N Display Terminal User's Manual (02640-90111).
- 2640S — HP 2640S Display Terminal User's Manual (02640-90113).

The HP 2640 Service Manual (02640-90115) provides a discussion of troubleshooting, repair, and theory of operation for all of the above terminals.

HOW TO USE THIS MANUAL

This manual describes all of the terminal's programmable features. The various functional groups such as display control and communications are described in separate sections. If you have not used an HP terminal before you should read Section I for a brief overview of the terminal and its capabilities. If you are familiar with the HP 2640 series terminals you can use the index at the back of the manual to locate answers to specific questions.

This manual is made up of the following sections and appendices:

Section I General Description. — This section provides a brief description of the terminal, its operating modes, and overall capabilities.

Section II Terminal Control Functions. — This section contains information for programmatically controlling the terminal's various switch settings.

PREFACE

Section III Display Memory Functions. — This section contains information for controlling the terminal display. Included are cursor sensing and positioning, fields, edit operations, and display enhancements.

Section IV Device Control. — This section describes how to control an optional printer.

Section V Data Communications. — This section describes the terminal's communication function and gives procedures for configuring the terminal to meet various communication requirements.

Section VI Status. — This section describes how to obtain and interpret terminal status.

Section VII Installation. — This section contains step-by-step procedures for installing and configuring the terminal and its accessories.



Appendix A Applications. — This appendix contains examples of various terminal applications.

Appendix B Reference Tables. — This appendix contains condensed reference information for all of the terminal's features.

Appendix C Communications Flowcharts. — This appendix contains flowcharts of the communication function.

TERMS AND CONVENTIONS

The descriptions in this manual use the following text conventions:

<character>^c or  <character> — When a character is shown followed by a superscript *c* or is shown preceded by the  key, it indicates a control character. Control characters are normally generated from the keyboard by holding the  key down while pressing the character.

Example: G^c = bell character

[<>] — The right and left bracket, less than, and greater than characters are used to set off variable parameters in some escape code sequences. These characters are added for descriptive purposes and are not a part of the escape sequence. They should not be transmitted.

CONTENTS

Section I	Page	Section IV	Page
GENERAL DESCRIPTION		DEVICE CONTROL	
Introduction	1-1	Introduction	4-1
Mainframe	1-1	Performing Print Operations	4-1
Terminal Bus	1-2	Control Characters	4-1
Terminal Memory	1-2	Forms Mode	4-2
Input/Output Modules	1-2	Performing Video Copy Operations	4-2
CRT Monitor	1-2		
The Raster	1-2		
Alphanumeric and Microvector			
Character Sets	1-3	Section V	Page
Display Features and Alternate		DATA COMMUNICATIONS	
Character Sets	1-3	Introduction	5-1
Keyboard	1-3	Connecting Terminals to a Computer	5-1
The Firmware	1-3	Networks	5-1
System Monitor	1-3	Interfaces	5-1
I/O Subsystem	1-4	Interface Signals	5-4
Cursor Movement	1-4	Modems	5-4
Display Memory Management	1-4	Communication Protocols	5-5
Data Communications	1-5	Basic Communications	5-5
		Operating at High Speeds	5-5
		Character Mode	5-8
		Multicharacter Transfers	5-8
		Block Mode	5-8
		Full Duplex Operation	5-11
		Teletype Compatible Communications	5-11
		Half Duplex Operation	
		(202 Modem Compatibility)	5-11
		Configuration	5-16
Section II	Page	Section VI	Page
TERMINAL CONTROL FUNCTIONS		STATUS	
Introduction	2-1	Introduction	6-1
Keyboard Latching Keys	2-1	Interpreting Status	6-1
Keyboard Interface Switches	2-1	Terminal Status	6-12
Function Keys	2-2		
Additional Control Functions	2-2		
Bell	2-2		
Send Display	2-2		
Keyboard Disable/Enable	2-2		
Reset Terminal	2-2		
Self-Test	2-2		
Modem Disconnect	2-2		
Program Down Load	2-2		
Section III	Page	Section VII	Page
DISPLAY MEMORY FUNCTIONS		INSTALLATION	
Introduction	3-1	Introduction	7-1
Display Control	3-1	Opening the Terminal	7-2
Column Addressing	3-2	Grounding Requirements	7-6
Cursor Sensing	3-2	Selecting Line Voltage	7-6
Cursor Positioning	3-2	Accessory Installation Procedures	7-7
Absolute Addressing	3-2	64 Character Lower Case ROM	7-7
Relative Addressing	3-2	HP 13231A Display Enhancements	7-8
Other Cursor Operations	3-2	HP 13232 Cable Assemblies	7-9
Tabs	3-4	HP 13234A (4K) Terminal Memory Module	7-10
Edit Operations	3-4	HP 13238A Terminal Duplex Register	7-11
Moving Text Blocks	3-4	HP 13240A I/O Extender	7-12
Forms Mode (Format Mode)	3-5	HP 13245A Character Set Generation Kit	7-13
Protected Fields	3-5	HP 13246A/B Printer Subsystem (9866)	7-14
Unprotected Fields	3-5	HP 13250B Serial Printer Interface	7-14
Display Enhancements	3-5	Accessories	7-14
Alternate Character Sets	3-6	HP 13349A Printer Subsystem (9871)	7-14
Selecting Alternate Sets	3-6	Power Supply Adjustment	7-14
Using Alternate Sets	3-6	Selecting Optional Operating Functions	7-15

CONTENTS (continued)

Data Communications Cabling	7-21	Appendix A	Page
Interface Signals	7-21	APPLICATIONS	A-1
Logic Levels	7-21	Appendix B	Page
Cable Types	7-21	REFERENCE TABLES	B-1
Communications Cabling	7-22	Appendix C	Page
Fabricating Your Own Data Communications		COMMUNICATIONS FLOWCHARTS	C-1
Cable	7-22		
Self-Test	7-22		

ILLUSTRATIONS

Title	Page	Title	Page
Terminal Architecture	1-1	Mainframe Top Part Locations	7-5
Basic Character Cell and Half-Shift	1-2	Fuse Positions for 115 VAC and 230 VAC	
System Monitor Basic Loop	1-3	Line Voltage	7-6
Display Memory Linked LIST Structure	1-4	Display Control PCA Component Locations	7-7
Row Addressing	3-1	Display Expansion PCA Jumper and ROM	
Column Addressing	3-2	Socket Locations	7-9
Character Set Locations	3-6	Top Plane Assembly Removal	7-9
Example Using the Math Set	3-7	Control Memory PCA Jumper Socket Location	7-10
Example Using the Large Character Set	3-7	4K Memory PCA Jumper Socket Location	7-11
Math Set Elements	3-8	Memory Maps and Corresponding Memory	
Large Character Set Elements	3-9	Addressing Jumper Positions for 1K,	
Line Drawing Set	3-10	5K, and 8K	7-11
Terminal Network Configurations	5-1	Terminal Duplex Register PCA	
Block Transfer Enabled by the ENTER Key	5-8	Jumper Configuration	7-12
Block Transfer Enabled by the Computer	5-9	Typical Strapping Option Switch Assembly	7-16
Block Mode Operation	5-9	Keyboard Interface PCA Strapping Options	7-16
Example of Format Mode with Page Strapping	5-10	Extended Asynchronous Communications	
Main Channel Protocol	5-12	PCA Strapping Options	7-19
Sample Data Transfers Using Main		Standard Communications Cabling	7-23
Channel Protocol	5-13	Current Loop Cabling	7-23
Reverse Channel Protocol	5-14	Modem By-Pass Cabling	7-23
Sample Data Transfers Using		Assembling the PCA Hood Connector	7-24
Reverse Channel Protocol	5-15	Assembling the RS232C Connector	7-25
Data Communications Configuration Flowchart	5-17	Self-Test Patterns	7-25
Terminal Status Example	6-2	Self-Test Flowchart	7-26
Terminal Status Bytes	6-3	Large Character Set Utility Routine	A-1
Opening the Terminal	7-2	Communication Flowcharts	C-3
Mainframe Bottom Part Locations	7-3	Keyboard Communication Switches Flowcharts	C-6

TABLES

Title	Page	Title	Page
Keyboard Switches	2-1	Keyboard Interface PCA Strapping	7-16
Keyboard Interface Switch Summary	2-1	13250B Extended Asynchronous Communications Interface Strapping Options	7-19
Cursor/Display Operations	3-3	EIA RS232C and CCITT V24 Interface Data and Control Signals	7-21
Edit Operations	3-4	Data Communications Signal Levels	7-21
Optional Printers	4-1	Parts for Fabricating Your Custom Data Communications Cable	7-22
Data Communicaiton Interfaces	5-1	Data Communications PCA Signal Names	7-22
Data Communication Interface Capabilities	5-2	Programmer's Reference Table	B-1
Keyboard Communications Switches	5-3	ASCII Code Chart	B-3
Keyboard Interface Switch Summary	5-4	Coding the Large Character Set	B-4
Modems	5-4	Specifications	B-6
Protocol Characteristics	5-5	ASCII Character Set	C-1
Processing Times for Selected Terminal Functions ..	5-5		
Keyboard Interface PCA Options	5-6		
Display Expansion PCA Jumper Protocol	7-9		
HP 13232 Cable Assemblies	7-10		

GENERAL DESCRIPTION

INTRODUCTION

The terminal uses a microprocessor under firmware control. It operates in character or block mode, with full editing capability. The terminal is designed for such applications as data entry and preparation, information display and editing, interactive programming, data communications, and time-sharing operations.

Data communications accessories are also available to provide a choice of communications capability. The standard terminal is teletypewriter compatible (EIA RS232-C serial asynchronous, ASCII, half or full duplex). It operates at speeds up to 2400 bits per second, and transmits either character-by-character as a fully interactive terminal or operates on variable length blocks of information. Optional capabilities include 20 mA current loop. The terminal can be used with a wide selection of modems over dialed or leased lines.

A block diagram of the terminal is shown in figure 1-1. There are three major and mechanically independent sections: keyboard, CRT monitor, and mainframe. The specific functional properties of the terminal are determined by firmware programs resident in ROM (read-only-memory). It is these programs, occupying up to 8K bytes of ROM, that make it possible for the terminal to have many powerful features such as self test, dynamic memory allocation, transparent control codes, and off-screen storage.

MAINFRAME

The heart of the system is the mainframe section, which can be considered a microcomputer system. In the mainframe is the power supply and a bus-oriented logic system containing the microprocessor, program and data memory, video display subsystem, keyboard interface, and data communications interface. Up to seven slots are

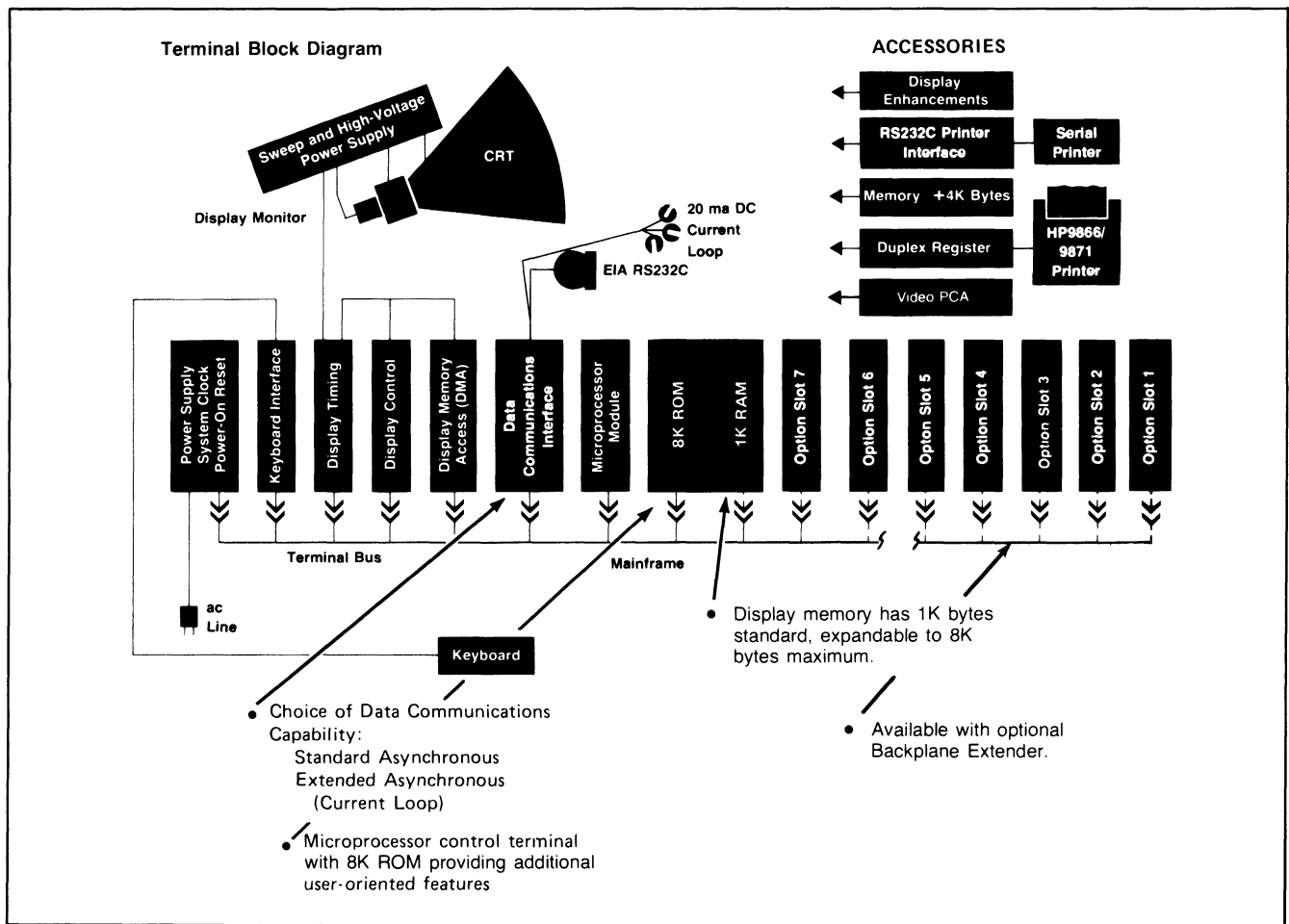

Figure 1-1. Terminal Architecture

General Description

available for options and accessories. All mainframe modules are functionally, mechanically, and electrically independent, giving a high degree of flexibility and reducing service time.

TERMINAL BUS

A major element of the logic system is the terminal bus (a printed circuit board with connectors) which is attached to the bottom of the mainframe and to the power supply. The bus distributes power to the individual modules and provides data, address, and control lines for communication between the various logic functions. The terminal bus provides communication paths between processor, memory, input/output, and display refresh on a shared basis.

All modules are slot-independent and carry their own select code or memory address. There are only two rules: group the three display modules together, and leave no empty slots between the power supply and the last module.

A bus access cycle begins when a requesting module determines it needs the terminal bus for instruction or data fetch or input/output. If the terminal bus is busy, the requesting module must wait until it is available. To determine who gets the bus next, a priority chain has been incorporated. The modules nearest the power supply are first in the priority chain, and a module wanting the bus next breaks the chain for modules farther away from the power supply.

TERMINAL MEMORY

Like any other computer system, the microcomputer module is useful only if it has a program to execute and memory in which to store data. This is the function of the terminal memory modules, which are two types, read/write or random-access memory (RAM) and read-only memory (ROM). The RAM stores display characters and data; the ROM stores terminal programs (firmware). Terminal programs are called firmware because the ROM makes them more permanent than software but less permanent than hardware. One half of the available memory is dedicated to ROM or program memory and the balance of the available memory locations can be used for RAM. All of the terminal memory is MOS semiconductor memory.

Optional 4K RAM modules are added when more random-access memory is required for display and data storage.

INPUT/OUTPUT MODULES

Also a part of the logic system are several terminal input/output modules: the keyboard interface PCA, the data communications PCA, the eight-bit duplex register PCA (used for the HP 9866A and HP 9871A Printer interface), and the serial printer interface PCA. These never request

control of the bus, but all must respond to commands from the microcomputer and its programs.

The basic I/O commands output data or control from the microprocessor and input data or status from the interface module. Each of the I/O cards has different data and control formats, but all are controlled by the microcomputer. Each I/O module has a rear edge connector for the attachment of a connector hood and cable assembly to carry the signals out the back of the terminal.

The display subsystem has two functions that use the bus. Cursor control is an output function and the DMA refresh is a bus requestor for memory read operations.

CRT MONITOR

The CRT monitor section contains sweep and high voltage circuits, the high-resolution, low-profile cathode-ray tube, and fan.

THE RASTER

The terminal uses raster scan deflection method, similar to that used in television sets. In a raster scan display, the electron beam traverses the screen in a series of closely spaced horizontal lines, starting from the top. Characters are formed from line segments and dots produced by turning the beam intensity on and off at appropriate times.

The terminal uses a low-profile CRT to keep overall height to a minimum while maintaining a screen capacity of 1920 characters, partitioned into 24 rows of 80 characters each. All of the character positions are fundamentally rectangles 7 dots wide by 9 scan lines high. Four additional scan lines beneath the 7x9 matrix are used for the descender areas of lower-case characters, for underlining, and for the blinking underscore cursor. One other dot is used on either side for character-to-character spacing, and one scan line is reserved at the top and bottom for row-to-row spacing. This results in a character cell of 9 dots by 15 scan lines replicated over the entire screen area (see figure 1-2).

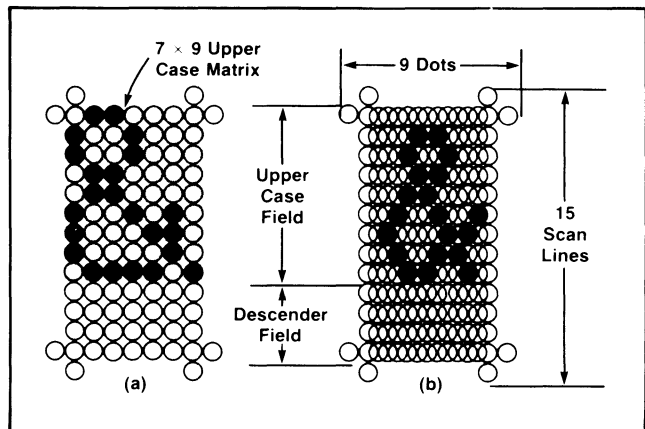

Figure 1-2. Basic Character Cell and Half-Shift

ALPHANUMERIC AND MICROVECTOR CHARACTER SETS

Two types of character sets can be stored within the terminal: alphanumeric sets and microvector sets. Alphanumeric sets support the primary use of the terminal, displaying textual and numeric information. Characters are designed around a basic 7×9 dot matrix with provision for lower-case descenders. The characters are embellished by use of the half-shift. With this type of set the character-to-character spacing of two dots is hardwired. This prevents the design of characters that would form continuous horizontal lines. However, all 15 scan lines of the row are available so that vertically contiguous symbol segments can be designed. An example of this is the three-row-high integral sign found in the math symbol set.

Microvector sets use the entire 9-dot-by-15-scan-line character cell without the half-shift. This allows characters to be designed with both horizontal and vertical continuity. This type of set finds its greatest application where a minimal set of graphic kernels is needed to represent more complex pictorial information. The figure on page 3-6 illustrates the use of the line drawing set in representing a form.

DISPLAY FEATURES AND ALTERNATE CHARACTER SETS

The basic terminal has 64 alphanumeric characters (128 optional) and one display feature, inverse video fields (black characters on white backgrounds). With the addition of the display enhancement board, up to three additional 128-character sets can be stored within the terminal. Three display features are also added: half-bright, underline, and blinking fields. All sixteen possible combinations of the four display features can be applied to any character or characters on the screen. No displayable character positions are required to start, stop, or modify either the features or the character sets. Therefore, consecutive characters on the screen may be from different sets or have different display features.

KEYBOARD

The processor scans the keyboard at discrete intervals for a depressed key. Each key is assigned a position in a matrix of 16 columns and 8 rows. This matrix provides a reference to a look-up table that the firmware uses to display the character and/or send the ASCII code over the data communications line.

THE FIRMWARE

SYSTEM MONITOR

The system monitor is a section of the firmware that dispatches data within the terminal. The processor normally executes a basic loop, in which it scans the

keyboard and the data communications interface and waits for something to happen (see figure 1-3) When a character is received from either the keyboard or the data communications interface, a general character interpretation routine is executed to determine the action to be taken. The monitor then performs the specified functions, such as putting a character on the display, transmitting a character over the data communications interface, or moving the cursor. When this has been completed, the monitor returns to the basic scan loop to look for the next input.

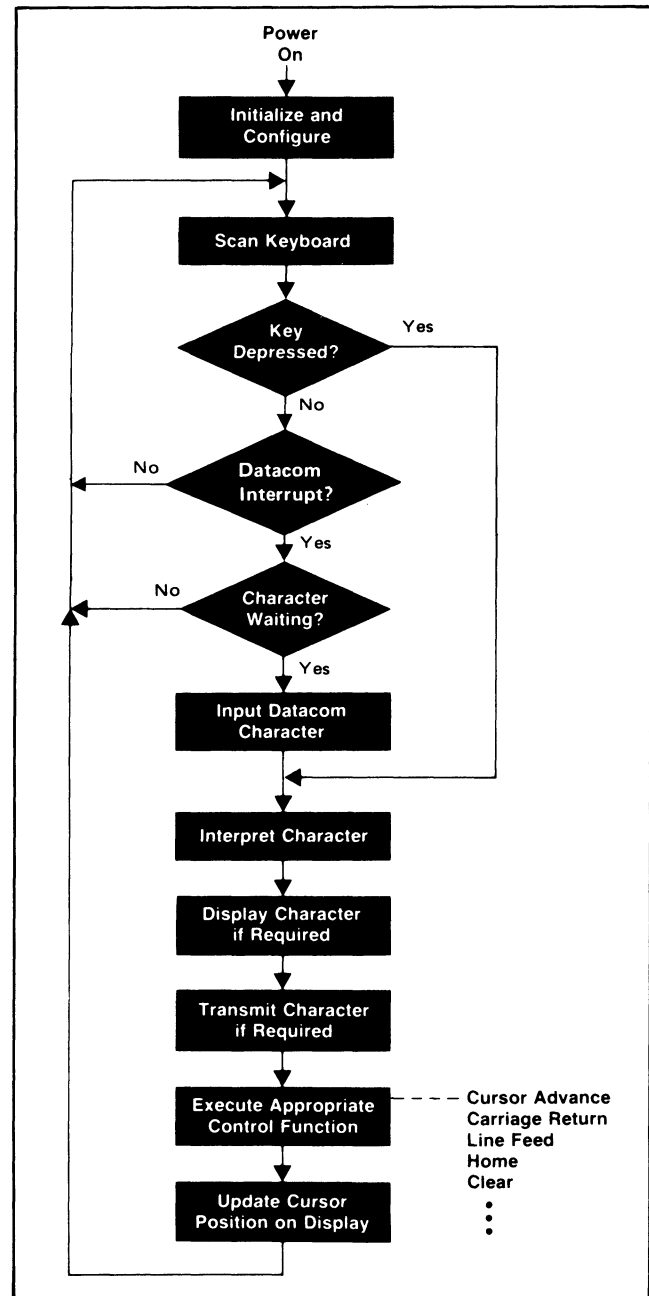

Figure 1-3. System Monitor Basic Loop

I/O SUBSYSTEM

The I/O subsystem contains the firmware required for performing all input/output functions. The firmware operates under both scan and interrupt methods. The keyboard is scanned at regular intervals as well as inputs from the data communications interface. If a new key depression is detected, the key number associated with this key is calculated and used as an index into a table that assigns a code to the key. If the key is one of the ASCII keys, the proper code is determined based on the state of the CNTRL, SHIFT, and CAPS LOCK keys.

If the key in question is not one of the ASCII keys, the firmware may be required to generate a multiple character sequence consisting of an ASCII escape character followed by one or more characters that define the escape sequence. Keys in a third group do not generate codes at all, but simply perform internal terminal functions, such as BLOCK MODE, REMOTE, and CAPS LOCK.

I/O associated with the display is minimal because the display memory access module (DMA) causes the display to be refreshed without processor intervention. Display I/O control mainly involves transmitting the cursor coordinates to the display whenever necessary.

CURSOR MOVEMENT

The firmware contains many subroutines for moving the cursor on the display. All cursor movement is handled by the firmware. When a character is typed on the keyboard and appears on the display, the cursor moves to the next column position because a cursor advance subroutine has been executed and has calculated a new cursor position. Similar subroutines exist for moving the cursor up, down, right, left, and home. The tab function is also a firmware routine; it uses a one-bit-per-column table to determine the next tab stop.

DISPLAY MEMORY MANAGEMENT

A large part of the firmware is devoted to management of the display memory. Most conventional terminals use a byte of display memory for every displayable position on the CRT screen. If there are many short lines, as is frequently the case, there is a substantial amount of unused memory. The terminal does not allocate memory for character positions to the right of the last character entered, so this memory is available for other purposes. Turn on and turn off of the various display enhancements and character set selections, or start and end of unprotected fields between individual characters can be accomplished without an intermediate blank character position. With these features, the address of a character occupying a given row and column cannot be directly computed without some sort of scanning process.

The display memory consists basically of a linked list of fixed-sized blocks of RAM (see figure 1-4). This list is set

up in such a way that the DMA can start at the first address on the screen and follow the list to produce an entire screen of information. All memory not currently allocated for display use is kept on a free-storage link list. Individual rows are linked with next and preceding rows, while blocks within a row are linked only in a forward direction. The storage allocated for a row may be as little as one block (16 bytes), or much larger than 80 characters, depending upon the number of displayable and nondisplayable characters needed to create the row on the CRT.

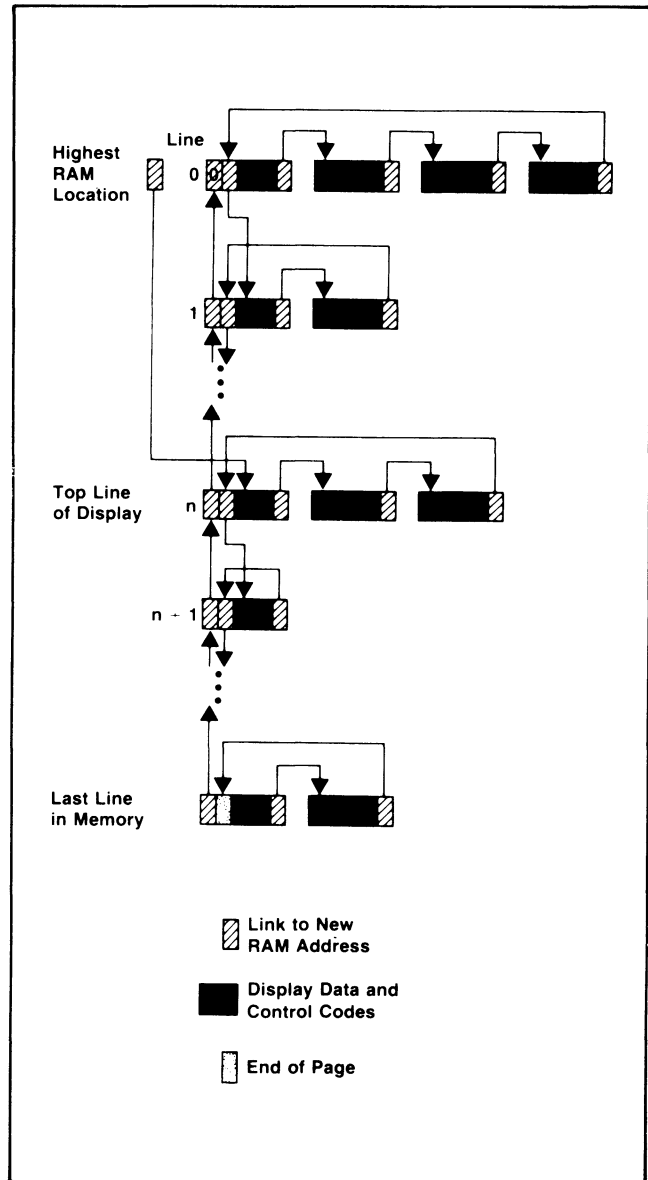

Figure 1-4. Display Memory Linked List Structure

The firmware finds the address corresponding to a given character position by starting at the last known position and moving through the list either backward or forward until it finds the new address. If the end of the list is found before the row in question has been found, blocks are removed from the free-storage list and used to create new

rows. Once the correct row has been found, the firmware searches for the cursor column. If the end of the row is found before the column has been found, additional blocks are removed from the free-storage list and used to build the length of the row out to the column required. Whenever a block is required and free list is empty, an existing row must be released from display memory. This row is the first row of memory if the addition is at the end of memory, and is the last row of memory if a row other than the last row is being lengthened.

DATA COMMUNICATIONS

Data communications in the terminal is both a hardware and a firmware function. The data communications interface is a basic terminal module. This module has the necessary logic to interface the terminal bus to the communication line.

The communication interface accepts parallel data from the terminal, serializes it, and adds framing or synchronizing bits (start and stop). It performs the reverse process on incoming data, converting serial data to parallel and removing start and stop bits. The interface can generate and check parity and can also detect data overruns. A status word keeps the processor informed of the status of the interface.

The terminal firmware for communications has three main functions. First, the program reads the control settings on the keyboard, keyboard interface, and the data communications interface. Second, it processes input characters and transmits output characters. Many decisions are made on incoming characters, especially on control characters. The third function is modem control using control lines on the communications interface. Direct connections to a computer and Bell 103 type modems require a minimum of firmware control while Bell 202 type modems require more control. A more detailed description of the data communications operation is given in section v.

TERMINAL CONTROL FUNCTIONS





INTRODUCTION

This section describes the terminal's control settings and various other control functions. The settings consist of keyboard switches and keyboard Interface switches.

KEYBOARD LATCHING KEYS

The keyboard switch settings are listed in table 2-1. The operation of some of the switches varies slightly depending on whether the terminal is set for REMOTE or LOCAL operation or is in FORMAT or Non-FORMAT mode. Additional information on REMOTE operation and FORMAT mode is given in Sections V and III respectively.

Table 2-1. Keyboard Switches

SWITCH	FUNCTION
	When depressed this switch causes the terminal to automatically generate a Line Feed character following a Carriage Return.
	When depressed this switch places the terminal in Block Mode. Typed data is displayed but not transmitted to the computer until requested by the computer or until the  key has been pressed and the computer has responded. When the key is up the terminal is in Character Mode and data is transmitted as it is typed.
	When depressed this switch causes the alphabetic keys to generate the uppercase characters. The @ , ^ , [, \ , and] keys are locked in lower case. The remaining keys operate normally.
	When depressed this key places the terminal in Remote (on-line) operation. Data entered from the keyboard is sent to the computer and the computer can send data including terminal control sequences to the terminal.

KEYBOARD INTERFACE SWITCHES

The switches on the Keyboard Interface allow you to alter terminal operation for specific applications. Table 2-2 contains a summary of the switches and their function. A more complete description of the switches is given in Section VII.

Table 2-2. Keyboard Interface Switch Summary

SWITCH	FUNCTION
A	Function key transmission
B	Space overwrite latch
C	Cursor end-of-line wraparound
D	Page Mode
E	Reverse action of CNTL key when used with F ₁ - F ₈ .
F	2640/2644 Handshake protocol
G	Block transfer handshake
H	Inhibit DC2
J,K,L,M, N,P,Q,W	(not used)
R	Circuit Assurance
S T	Switches S and T are used to select Main Channel protocol options.
U	CPU break
V	Carrier Detect
X	Data Speed select
Y	Transmit LED
Z	Parity

FUNCTION KEYS

The terminal has eight function keys $\boxed{f_1}$ - $\boxed{f_8}$. These keys can be used to send a two character escape code sequence to the computer. The character sequences are as follows:

$\boxed{f_1}$	= ESC p	$\boxed{f_5}$	= EXC t
$\boxed{f_2}$	= ESC q	$\boxed{f_6}$	= ESC u
$\boxed{f_3}$	= ESC r	$\boxed{f_7}$	= ESC v
$\boxed{f_4}$	= ESC s	$\boxed{f_8}$	= ESC w

The function keys are normally used to select local terminal functions such as display enhancements and format control (see Section III). When the operator holds the $\boxed{\text{CNTRL}}$ key down and presses one of the function keys, the associated escape sequence is sent to the computer. The escape sequence can then be used to cause an application program to branch to a particular subroutine. This allows the keys to be used as a "menu" list of special commands. Note that the use of the CNTRL key can be reversed using switch E on the Keyboard Interface PCA.

Examples of typical uses for the escape code sequences are as follows:

$\boxed{f_1}$	= ESC p	= Select first subroutine
$\boxed{f_2}$	= ESC q	= Select second subroutine
$\boxed{f_3}$	= ESC r	= Call second application program
$\boxed{f_4}$	= ESC s	= Terminate program

ADDITIONAL CONTROL FUNCTIONS

In addition to the control settings there are several control operations that can be controlled programmatically. These control functions are as follows:

- Bell — G^c
- Send Display — ESC d
- Keyboard Disable — ESC c
- Keyboard Enable — ESC b
- Reset Terminal (Full) — ESC E
- Terminal Self-Test — ESC z
- Modem Disconnect — ESC f
- Program Down Loading — ESC & b

BELL

The G^c character causes the terminal to "beep". A beep is automatically generated at the end of each unprotected field in format mode and as the cursor passes within eight positions of the right margin.

SEND DISPLAY

The ESC d sequence causes the terminal to send a block of display memory data to the computer. The data sent depends on the Line/Page setting of Keyboard Interface switch D and whether the terminal is in format mode or not.

Data is transmitted beginning at the current cursor position. If the terminal is strapped for page, data is transmitted until the end of the current display. If strapped for line, transmission stops at the end of the current line for non-format mode or at the end of the current field if in format mode.

KEYBOARD DISABLE/ENABLE

The terminal keyboard can be locked by sending an ESC c. It must then be unlocked by sending an ESC b or by pressing the RESET TERMINAL key.

RESET TERMINAL

A programmatic "Full Reset" can be made by sending an ESC E to the terminal.

A full reset has the same effect as turning power on and causes the screen and memory are cleared. Format mode and display functions, are turned off or set to their default values.

SELF-TEST

The Terminal Self-Test can be executed by sending an ESC z. Descriptions of the self-test is given in section VII.

MODEM DISCONNECT

The terminal can be directed to "hang up" the modem by sending an ESC f. The terminal does this by lowering the CD (Data Terminal Ready) line for 1 second.

PROGRAM DOWN LOAD

The ESC & b sequence allows special diagnostic programs to be loaded into the terminal and executed. The escape sequence must precede the program to be loaded. This function can be used by HP diagnostics only.

DISPLAY MEMORY FUNCTIONS

INTRODUCTION

This section contains information for controlling the terminal's display memory functions. The display memory functions change the position of display data or assign special attributes to blocks or fields of display data. The special attributes alter the way data is displayed or transmitted. These functions consist of the following groups:

- Display Control
- Edit Functions
- Forms Mode
- Display Enhancements
- Alternate Character Sets

The following paragraphs describe how to control the display memory functions from a computer program. Each of the display functions can also be entered from the terminal keyboard. In addition to escape sequences, most of the display memory functions have been assigned to special keys on the keyboard. Refer to the User's Manual for a description of keyboard functions.

DISPLAY CONTROL

The display control functions are made up of cursor and display positioning operations. The individual functions available are as follows:

- Cursor Sensing
 - Absolute
 - Relative
- Cursor Positioning
 - Move Cursor Absolute
 - Move Cursor Relative

- Space
- Backspace
- Set Tab
- Clear Tab
- Tab
- Home Up
- Home Down

- Display Positioning
 - Roll Up
 - Roll Down
 - Next Page
 - Previous Page
 - Display Lock (Memory Lock)

Display memory positions can be addressed using absolute or relative coordinate values. Display memory is made up of 80 columns (0-79) and a number of rows determined by the memory options installed in the terminal. There can be as many as 90 lines of 80 characters (4 screens). The amount of memory in the terminal can be determined from byte 0 of the terminal status (refer to section VI). The types of addressing available are:

- Absolute
- Screen Relative
- Cursor Relative

Figure 3-1 illustrates the way the three types of addressing affect row or line numbers. The cursor is shown positioned in the fourth row on the screen. Screen row 0 is currently at row 6 of display memory. In order to reposition the cursor to the first line of the screen the following three destination rows could be used:

- a. Absolute: row 6
- b. Screen Relative: row 0
- c. Cursor Relative: row -3

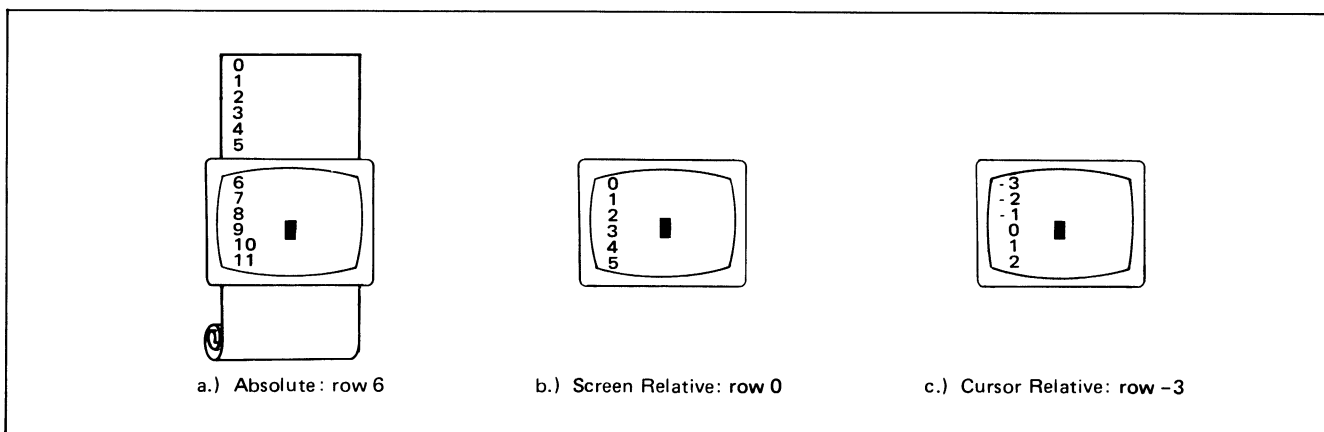

Figure 3-1. Row Addressing

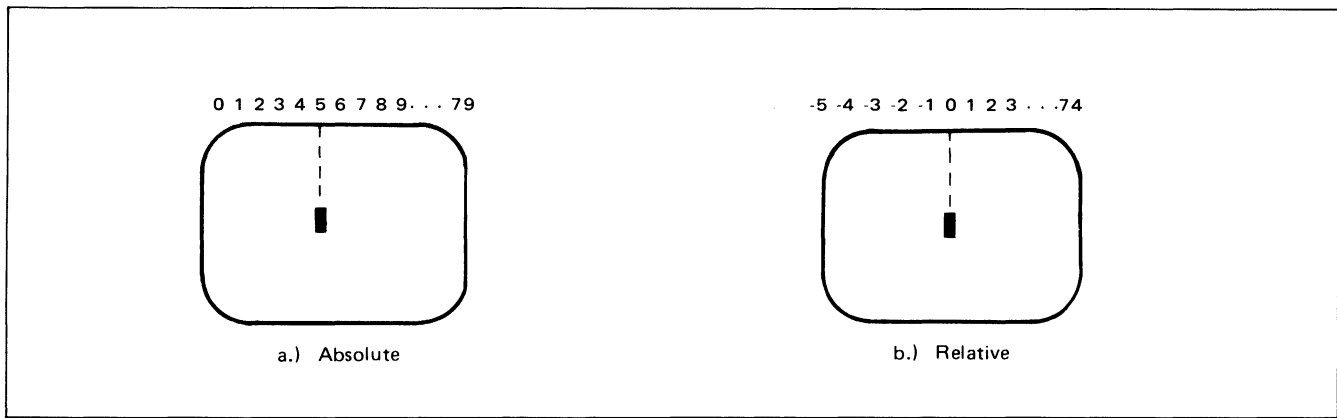

Figure 3-2. Column Addressing

COLUMN ADDRESSING

Column addressing is accomplished in a manner similar to row addressing. There is no difference between screen and cursor relative column addressing. Figure 3-2 illustrates the difference between absolute and relative addressing. The cursor is shown in column 5.

Whenever the row or column addresses exceed those available, the largest possible value is substituted. This means that in relative addressing, the cursor cannot be moved to a row position that is not currently displayed. For example, in figure 3-1c a relative row address of -10 would cause the cursor to be positioned at the top of the current screen (relative row -3). Column positions are limited to the available screen positions (0 to 79 in figure 3-2a and -5 to 74 in figure 3-2b). The cursor cannot be wrapped around from column 0 to column 79 by specifying large negative values for relative column positions.

CURSOR SENSING

The current position of the screen cursor can be sensed. The position returned can be the absolute position in display memory or the location relative to the current screen position. (Absolute and relative addresses are discussed under Cursor Addressing.)

Absolute Sensing **ESC a**

Example: The cursor is at column 20, row 40.

computer: **ESC a**

terminal: **ESC & a 020c 040R**

Relative Sensing **ESC `**

Example: The cursor is again at column 20, row 40, but screen row 0 begins at row 35 of display memory.

computer: **ESC `**

terminal: **ESC & a 020c 005R**

CURSOR POSITIONING

The cursor can be positioned directly by giving memory or screen coordinates, or by sending the escape codes for any of the keyboard cursor positioning operations.

ABSOLUTE ADDRESSING

The cursor can be positioned to any displayable position using absolute coordinates. Absolute cursor positioning is accomplished using the following sequence:

ESC & a <row number> r <column number> C

where:

row number is 0 to 127. Row numbers greater than 127 will cause the cursor to remain in the current row.

column number is 0 to 79

Example: Position the cursor at row 35, column 6.

ESC & a 35r 6C

RELATIVE ADDRESSING

The cursor can be positioned to any position currently displayed on the screen by using relative coordinates. (\pm row, \pm column).

Example: The cursor is currently at row 7 and column 10 of the screen. Move the cursor to row 9, column 6.

ESC & a +2r -4C

OTHER CURSOR OPERATIONS

In addition to positioning the cursor using coordinates, you can use a variety of keyboard equivalent operations. These operations normally require only one or two characters to be sent to the terminal. Table 3-1 lists each of the operations together with its code and a brief description.

Table 3-1. Cursor/Display Operations

FUNCTION	CODE	DESCRIPTION
Cursor		
Line Feed	LF (J ^c)	Move the cursor to the next line.
Return	CR (M ^c)	Return the cursor to the left margin and clears messages.
	ESC G	Move cursor to first column of current row.
Backspace	BS (H ^c)	Move the cursor one column to the left.
↑	ESC A	Move the cursor up one row.
↓	ESC B	Move the cursor down one row.
→	ESC C	Move the cursor right one column.
←	ESC D	Move the cursor left one column.
Home Up Cursor	ESC H	Move cursor to the beginning of the first line in display memory. Refer to Format Mode.
Home Down Cursor	ESC F	Move the cursor to the beginning of the line following the last data in display memory.
Tabs		
Tab	HT (I ^c) or ESC I	Move the cursor forward to the next tab position.
Set Tab	ESC 1	Place a tab at the current cursor column.
Clear Tab	ESC 2	Clear any tab at the current cursor column.
Display		
Clear Display	ESC J	Clear display memory from the cursor position to the end of memory.
Clear Remaining Line	ESC K	Clear current line beginning at the column containing the cursor.
Roll Up	ESC S	Roll the screen up one row.
Roll Down	ESC T	Roll the screen down one row.
Next Page	ESC U	Roll the screen up 24 rows.
Previous Page	ESC V	Roll the screen down 24 rows.
Memory Lock	ESC l	Turn on memory lock (overflow protect).
	ESC m	Turn off memory lock. Refer to the User Manual for additional information on Memory Lock.

TABS

SETTING TABS. To set a tab, move the cursor to the desired column and send ESC 1. Once a tab is set, the tab function or `␣` key can be used to move the cursor to the next tab setting.

USING TABS. Once tab positions have been set you can tab in the same manner that you would on a typewriter. If there are no tab positions to the right of the cursor a tab function will result in a carriage return and line feed.

CLEARING TABS. You can clear individual tabs by moving the cursor to the tab position and send ESC 2.

EDIT OPERATIONS

The terminal allows you to edit data displayed on the screen. This can be done by simply overstriking the old data. In addition, several edit operations are available. These edit operations are listed in table 3-2.

MOVING TEXT BLOCKS

You can move blocks of text or data using Memory Lock.

Example: In the following text, move the paragraphs into the proper order. The current top of screen is Rev 1 of display memory.

Initial order:

```
(Top of screen) 3. This is paragraph 3. It
                  should be last in the
                  group.
                  2. This is paragraph 2. It
                  should be second.
                  1. This is paragraph 1. It
                  should be first (blank
                  line)
```

Step 1. Position the cursor in the first line of paragraph 2.

Step 2. Turn on Memory Lock.

Step 3. Roll up the display until the remaining paragraphs have rolled up under the cursor position and off the screen (4 lines).

Step 4. Turn off Memory Lock.

Step 5. Home the cursor.

The display should appear as follows:

```
(Top of screen) 2. This is paragraph 2. It
                  should be second.
                  1. This is paragraph 1. It
                  should be first.
                  3. This is paragraph 3. It
                  should be last in the
                  group.
```

Table 3-2. Edit Operations

FUNCTION	CODE	DESCRIPTION
Insert Line	ESC L	The line containing the cursor and all lines below it are rolled down one line. A blank line is inserted where the line containing the cursor was. The cursor is moved to the left margin of the blank line.
Delete Line	ESC M	The line containing the cursor is deleted. The lines below the cursor are rolled up and the cursor is positioned at the left margin.
Insert Character	ESC Q	Turn on Insert Character Mode (and indicator). New characters will be inserted in the line at the current cursor position. Characters that are moved past the right margin are lost.
	ESC R	Turn off Insert Character Mode (and indicator).
Delete Character	ESC P	The character at the current cursor position is deleted. Characters to the right of the cursor are moved one column to the left.

Step 6. Now move paragraph 1 by positioning the cursor in the first line of paragraph 1 and turning on Memory Lock.

Step 7. Roll up the display until the cursor is in the first line of paragraph 3.

Step 8. Turn off Memory Lock and home the cursor. The paragraphs should now be in order.

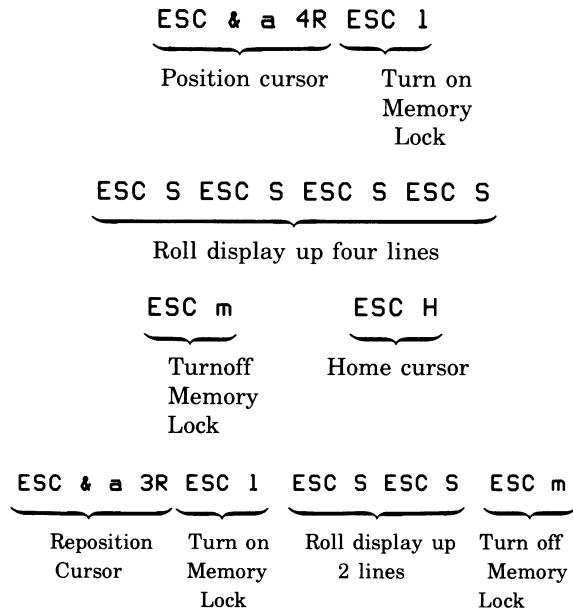

FORMS MODE (FORMAT MODE)

In Forms Mode the terminal prevents you from overwriting or transmitting data in protected fields. Forms mode is normally entered under control of the computer. Forms Mode is turned on by sending ESC W. Normal operation is returned with ESC X.

PROTECTED FIELDS

Fields can be protected so that displayed data cannot be overwritten or sent to a computer. When the terminal is placed in "Forms Mode" (Format Mode) all character positions on the screen are protected except those fields that have been specifically defined as "unprotected".

UNPROTECTED FIELDS

Data can be written into unprotected fields in the normal manner. After reaching the end of an unprotected field, the cursor moves to the beginning of the next unprotected field. The tab functions can be used to move from one unprotected field to the beginning of the next unprotected field. Fields are defined as "unprotected" by using ESC [at the start of the field. ESC] or the end of the line is used to end the field.

In the following figure only the fields shown in black are unprotected. Even if the operator moves the cursor to a protected field and types a character the cursor will move to the nearest unprotected field before displaying the character.

FORM #1876R

Vendor Name		Address		City	State	Zip
PACIFIC TOOL INC		1273 CRECENT WAY		SAN JOSE	CALIFORNIA	95131
Voucher	Date	Units	Purchase And Assembly Details		Post Ref.	Post.
07	16 1976	98	FINISHED STEEL CASTINGS		874738	65.88
03	19 1976	749	TAPE TRANSPORT BACKPLATES		875483	9753.88
02	28 1976	13	MILLED FLANGE ASSEMBLY		748563	877.44
	19					
	19					
HILBERT PALMAD			ENTERED BY H.C. DOUGLAS		DATE 04 14 1976	

Example: Define column 1 through 9 of line 3 as "Unprotected".

- Step 1.** Position the cursor at column 1 in line 3.
- Step 2.** Send ESC [.
- Step 3.** Move the cursor to column 10 of line 3.
- Step 4.** Send ESC].

Now try turning on Forms Mode (ESC W) and sending data. Note that data can only be entered into the unprotected field. (Remember to turn off Forms Mode with ESC X.)

DISPLAY ENHANCEMENTS

The standard terminal can display data using inverse video (black on white). In addition, if your terminal has the 13231A Display Enhancement accessory you can also use half bright, underline, and blinking characters. Each character position on the screen can be displayed with various combinations of these features.

- **Half Bright** — characters are displayed at half intensity (grey).
- **Underline** — an underline is displayed below the normal character.
- **Inverse Video** — the screen is white and characters are black.
- **Blinking** — characters including the inverse video, underline, and half bright features blink.

Display Memory Functions

The display enhancements are used by assigning one or more of them to a field. The selection sequence is: ESC & d <enhancement character>.

The enhancement character (@, A through O) is used to select the combination of display enhancements to be assigned to the field. The following table lists the enhancement character for each of the combinations. The field is ended by selecting another enhancement, the end of the current line, or by ESC & d@.

		ENHANCEMENT CHARACTER															
		@	A	B	C	D	E	F	G	H	I	J	K	L	M	N	O
Half-Bright										X	X	X	X	X	X	X	X
Underline						X	X	X	X					X	X	X	X
Inverse Video			X	X				X	X			X	X			X	X
Blinking		X		X		X		X		X		X		X		X	
End Enhancement	X																

Example: Define columns 10 through 14 of line 5 to be inverse video and blinking.

Step 1. Position the cursor at column 10 in line 5.

Step 2. Send ESC & d C

Step 3. Move the cursor to column 15 in line 5.

Step 4. Send ESC & d @ (this ends the enhancements). The field should be white.

Step 5. Send the word TERMINAL beginning in column 9 of line 5. It should appear as shown below. (If your terminal does not have the 13231A accessory installed the characters will not blink.)

```

      1      1
      0      5
      ↓      ↓
TERMINAL
  
```

ALTERNATE CHARACTER SETS

The terminal can display up to four different character sets. Each character set can contain up to 128 characters or symbols. In addition to the Math, Line Drawing, and Large Character sets available as options, you can create character sets tailored for special applications. Contact your nearest Hewlett-Packard Sales Office for additional information on special character sets.

Switching from one character set to another can be done on a character-by-character basis. For example, a character from the Math Symbol Set can be displayed next to characters from the basic set. This is done by defining one or more character positions in a line to be from alternate character sets. (Each group of characters can be thought of as a field.)

NOTE

The following discussion assumes that the Math and Line Drawing character sets are present and are installed as alternate sets A and B respectively.

SELECTING ALTERNATE SETS

To use optional character sets, first select the character set to be used as the alternate. (With the terminal in its initial state, character set A is defined to be the alternate.) An alternate set is selected with the following sequence:

Esc) <set> . where set = $\begin{cases} @ & \text{or} \\ A & \text{or} \\ B & \text{or} \\ C \end{cases}$

Note that if @ is used, the basic terminal set would be selected as the alternate. To find out which character set corresponds to @, A, B, or C, generate the test pattern by pressing the $\boxed{\text{TEST}}$ key). This displays the order of the character sets as shown below.

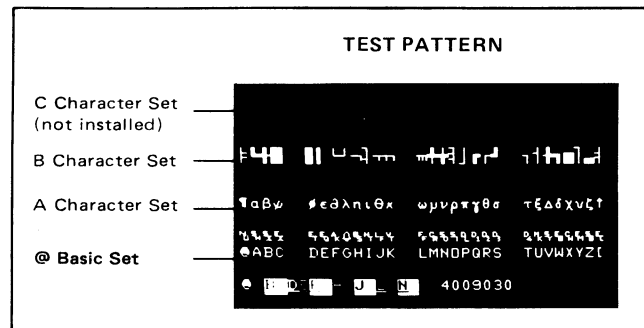

Figure 3-3. Character Set Locations

USING ALTERNATE SETS

Once the alternate character set is defined, you can switch from the basic to the alternate set with a N^c (SO).

The terminal automatically returns to the base set at the end of a line. To return to the base set within a line, send a O^c (SI). This means that you must send another N^c to turn on the alternate set if it extends to the next line.

Example: Define the Math Set as the alternate character set.

From the test pattern the Math Symbol Set is found to be the A alternate character set.

An alternate set is selected with the following sequence:

ESC) A

To display $A\alpha B\beta$ send the following sequence:

A N^c A O^c B N^c B

The screen should display $A\alpha B\beta$:

$A\alpha B\beta$

Once a field has been defined as from the alternate set the field moves with the display. To change to a different alternate character set another ESC) <set> sequence must be sent.

Once a field in display memory has been defined as an alternate character field, it will continue to display alternate characters whenever data is written in the field until the terminal is reset.

The Math Set is useful for applications requiring the use of equations or formulas. The elements of the optional Math Symbol Set are shown in figure 3-6. An example of the use of the Math Set is shown in figure 3-4.

$$\int_0^{\infty} \int_0^{\infty} \begin{bmatrix} -h & \frac{\partial \psi}{\partial t} \\ \frac{\partial \psi}{\partial t} & E \psi \end{bmatrix} dv = \int_0^{\infty} \int_0^{\infty} \begin{bmatrix} \psi & E \psi \\ E \psi & \psi \end{bmatrix} dv$$

Figure 3-4. Example Using the Math Set

The Large Character set allows you to create alphabetic characters that are three times the size of normal characters. The elements of the Large Character set are shown in figure 3-7. An example of how to use the Large Character Set to build the character "B" is shown in figure 3-5. Table B-3 in Appendix B shows the keys required to build each character.

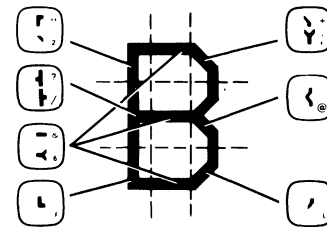
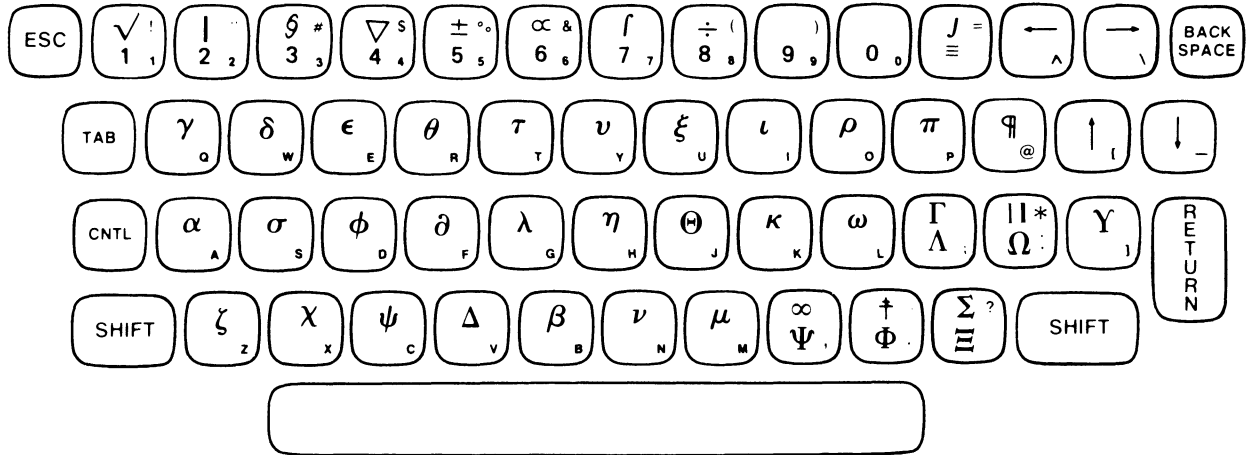
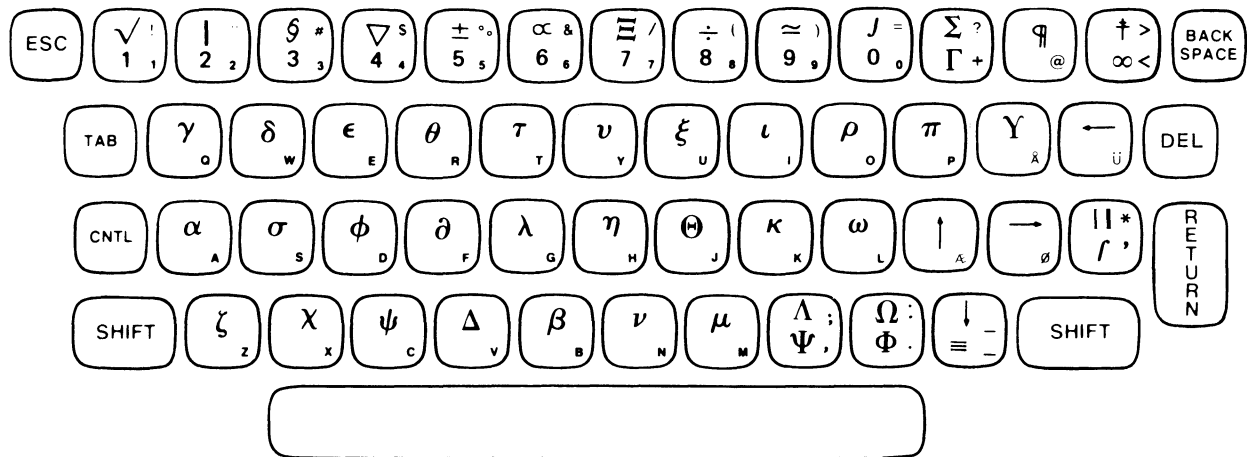

Figure 3-5. Example Using the Large Character Set

The Line Drawing Set provides a limited graphics capability. Simple line drawings and fairly complex forms for data entry applications can be generated. The elements of the optional Line Drawing Set are shown in figure 3-8 a. Figure 3-8 b shows how the Line Drawing Set can be used to build a data entry form.



2640B



2640N

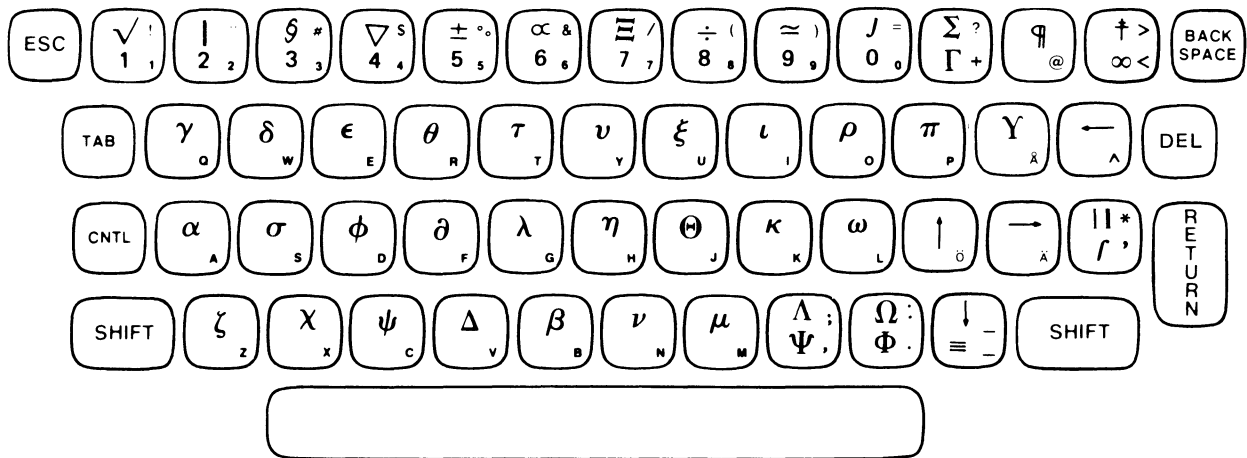

2640S

Figure 3-6. Math Set Elements

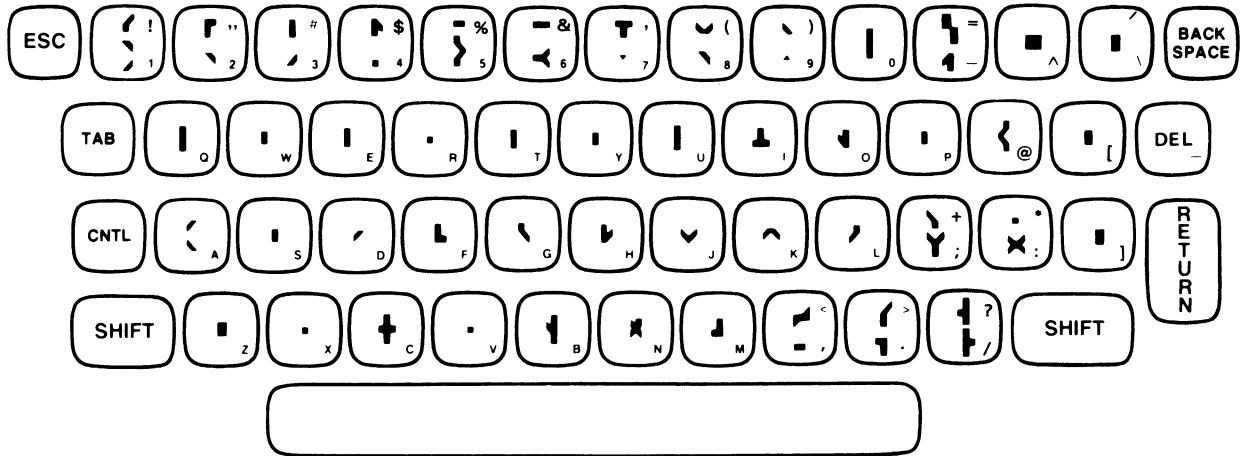

2640B

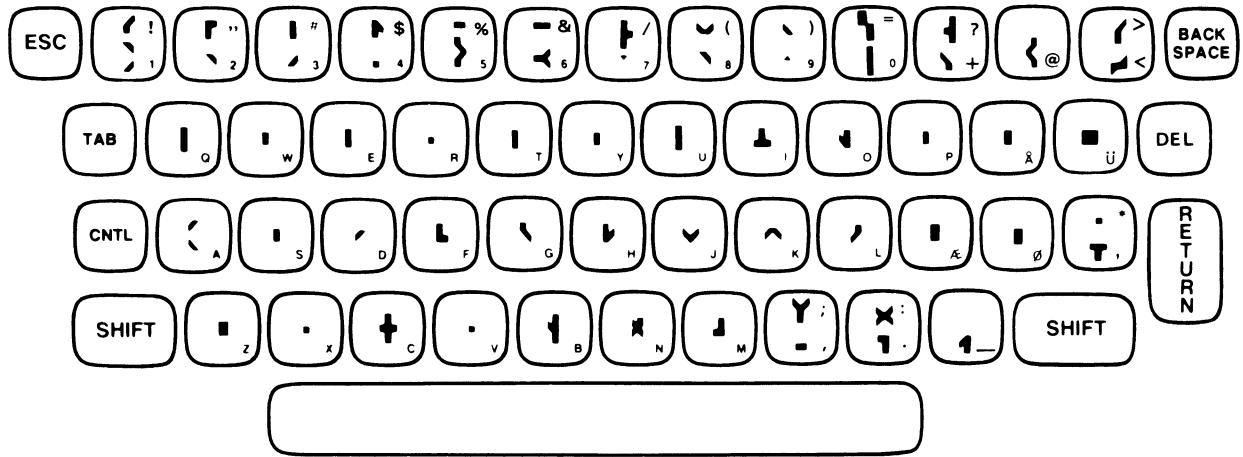

2640N

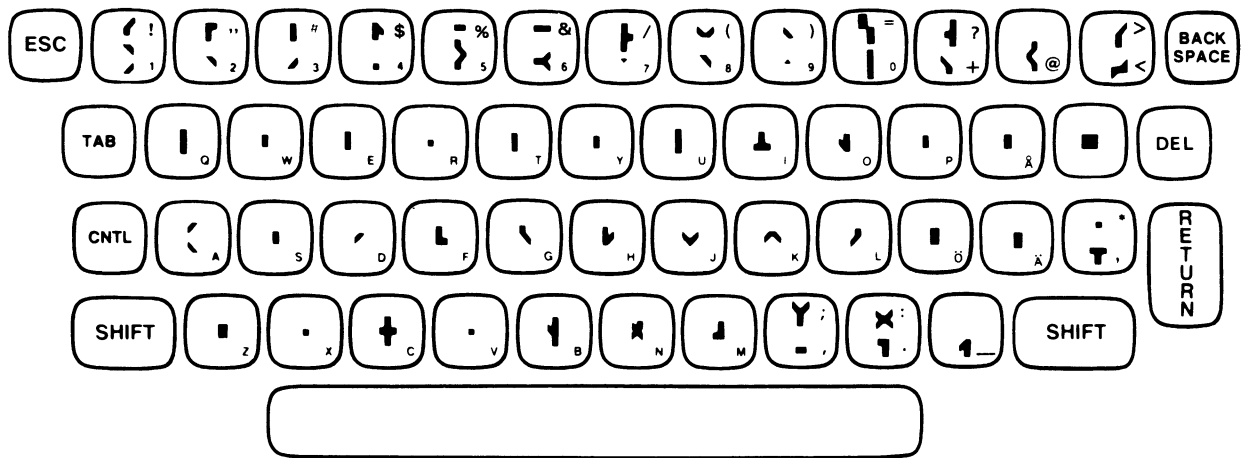

2640S

Figure 3-7. Large Character Set Elements

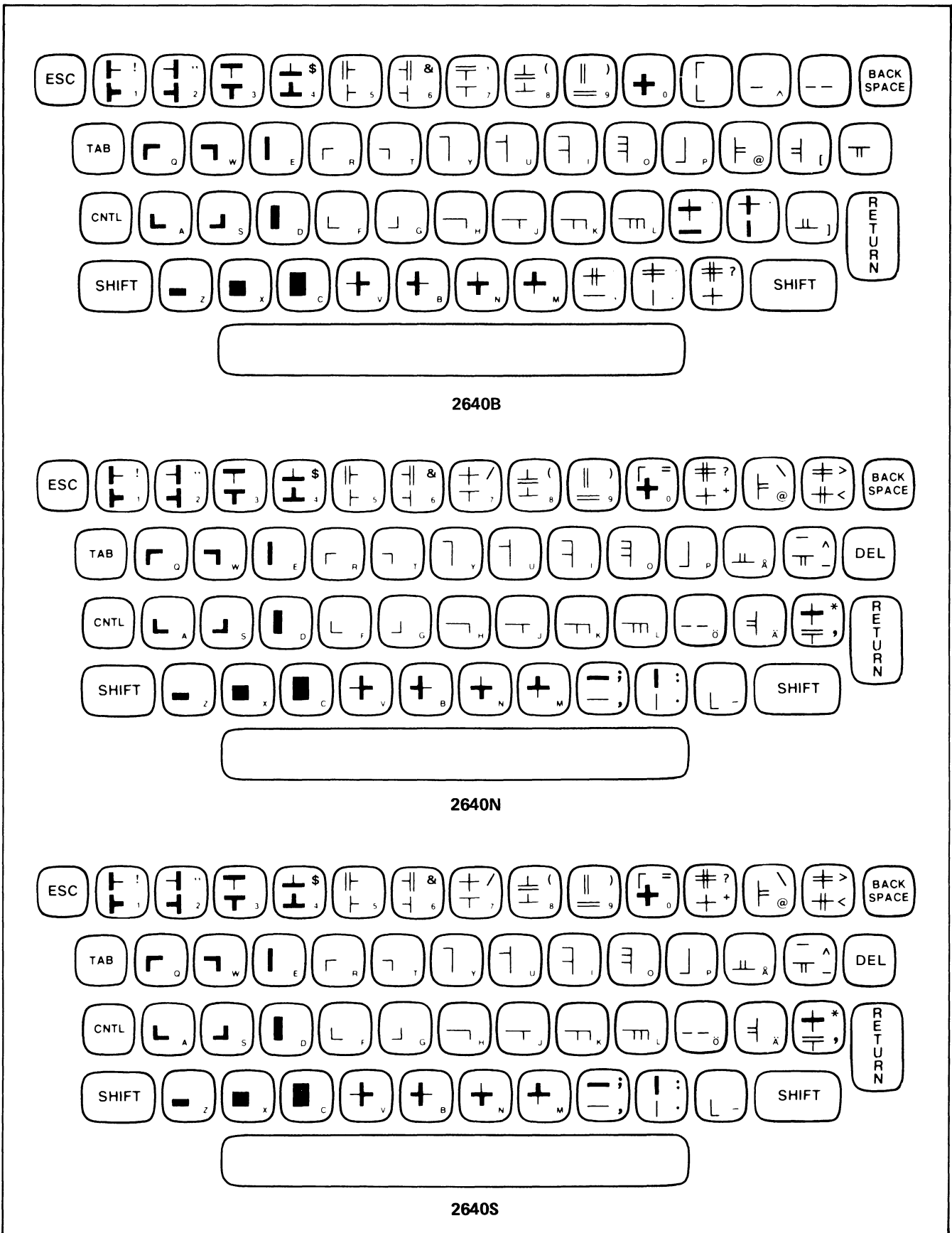

Figure 3-8a. Line Drawing Set

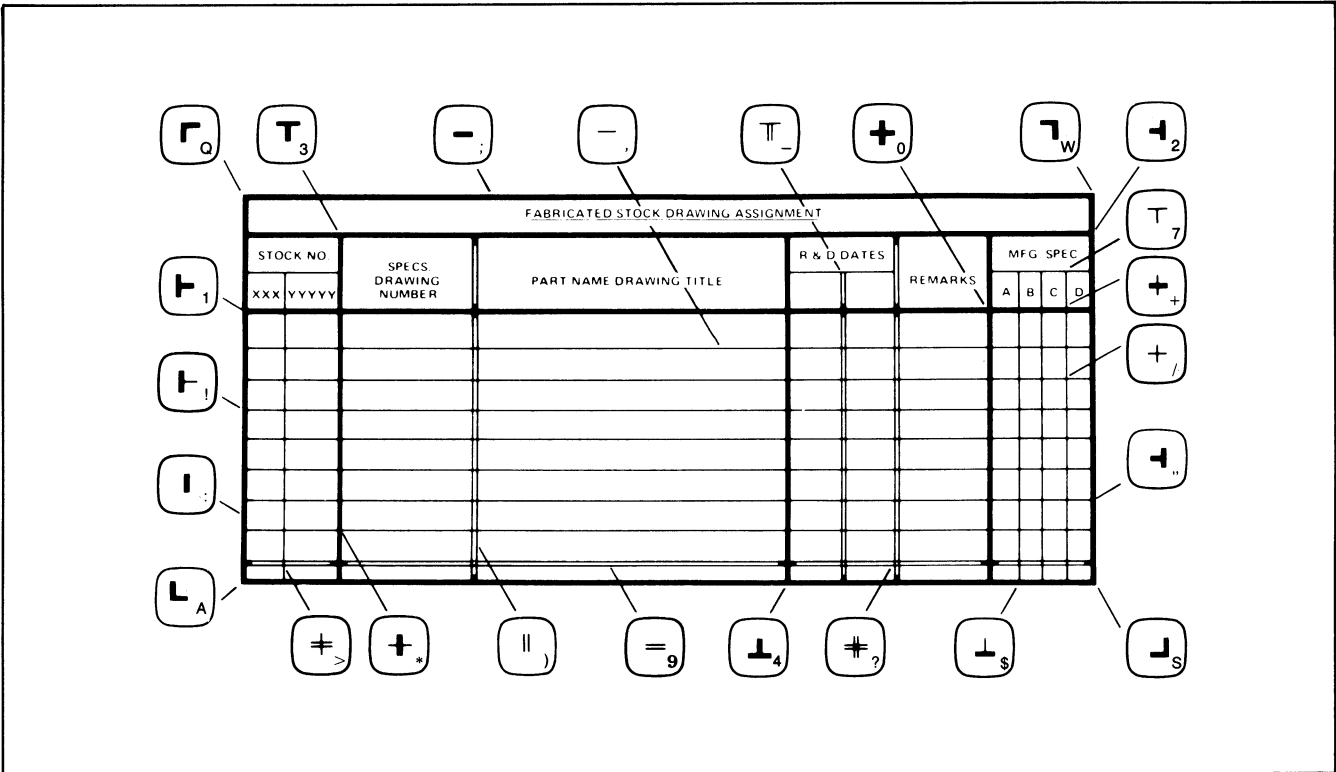

Figure 3-8b. Line Drawing Set

INTRODUCTION

This section describes how to use the terminal with an optional printer. The terminal can be used with Hewlett-Packard 9866 and 9871 printers as well as most printers using an RS232 type interface. A list of some of the printers that can be used with the terminal is given in table 4-1. Additional information on installation is contained in section VII.

After all of the data has been sent to the printer, the terminal sends a form feed command to the printer. This causes most printers to eject a blank page.

The print operation causes the terminal to "Home Up" the cursor and then send the entire contents of display memory to the printer. Each line of output is followed by a carriage return and a line feed.

PERFORMING PRINT OPERATIONS

A print operation is requested by a program by sending the characters ESC 0 to the terminal. The terminal operator can trigger the print operation by pressing the  key.

CONTROL CHARACTERS

All ASCII control characters (Null, Esc, Us, etc.) are sent to the printer as blanks or spaces.

Table 4-1. Optional Printers

PRINTER	DESCRIPTION	INTERFACE/SUBSYSTEM
Serial-RS232		
G.E. Terminet	Prints at rates up to 30 characters per second.	13250B Interface (order printer separately)
Parallel		
HP 9866	Thermal matrix printer allows quiet printing of up to 6 lines of 80 characters per second.	13246A/B Subsystem
HP 9871	Prints at rates of up to 30 characters per second.	13349A Subsystem
OKI CP110	Prints matrix characters at rates up to 110 characters per second.	13238A Interface (order printer separately)
Video		
Tektronix 4632	Video hardcopy unit produces hardcopy of terminal displays including display enhancements and alternate character sets.	13254A Interface (order hard copy unit separately)

FORMS MODE

If the terminal is in Forms Mode, data in protected fields is converted to blanks before being sent to the printer. This allows you to use preprinted forms on the printer and only output the data used to fill in the form.

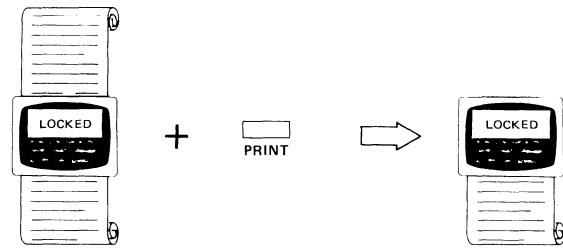
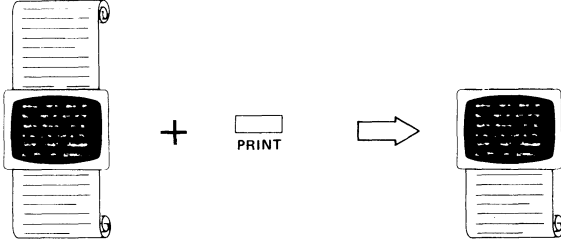

The locked portion of the display is then output first followed by the remaining data in display memory.

MEMORY LOCK

When the Memory Lock feature is used, print operations cause the locked portion of the screen to be moved to the beginning of display memory when the terminal performs the "Home Up" operation. (Refer to the discussion "Moving Text Blocks" in section III.)

PERFORMING VIDEO COPY OPERATIONS

Video copy operations are performed with the same escape sequence used in print operations, ESC 0. This will cause the terminal to perform a "Home Up" operation before printing. Only the first 24 lines (1 screen) will be copied. In order to copy any portion of display memory outside of the first 24 lines, the operator must position the display and manually activate the copy unit using its COPY button.

DATA COMMUNICATIONS

SECTION

V

INTRODUCTION

This section describes the terminal's data communications capabilities and operating requirements. The topics include interface specifications, network considerations, point-to-point operation, and communication configuration status. In addition, examples are included for typical network applications.

CONNECTING TERMINALS TO A COMPUTER

The terminal can be configured to work in a variety of computer applications. Your communication needs can be met by selecting a particular interface, modem, and protocol (communication control program).

NETWORKS

The terminal can be connected in a variety of network configurations. Figure 5-1 illustrates the following configurations:

- Hardwired to a computer (figure 5-1A)
- Connected to a computer through a modem (figure 5-1B)

INTERFACES

The terminal can be used with a variety of communication interfaces. A list of available interfaces and a brief description of each is given in table 5-1. The interfaces are

the Basic Asynchronous and 13250B Extended Asynchronous. A list of some of the capabilities of these interfaces is given in table 5-2.

Once the interface has been selected, the terminal can be configured to operate with a variety of protocols, parities, and data formats. This is done by setting switches or jumpers on the interfaces.

The Installation section contains complete lists of the possible switch settings for each of the interfaces together with brief descriptions of the switches. Also included in the Installation section are procedures for setting these switches.

Some of the communication features can be selected from the Keyboard and the Keyboard Interface PCA. Tables 5-3 and 5-4 provide lists of these switches together with brief descriptions.

Table 5-1. Data Communication Interfaces

Basic	Standard Asynchronous Communications Interface. Standard RS232C communications interface.
13250B	Extended Asynchronous Communications Interface. Provides either standard RS232C or 20 mA current loop communications. It allows split speed and custom baud rates.

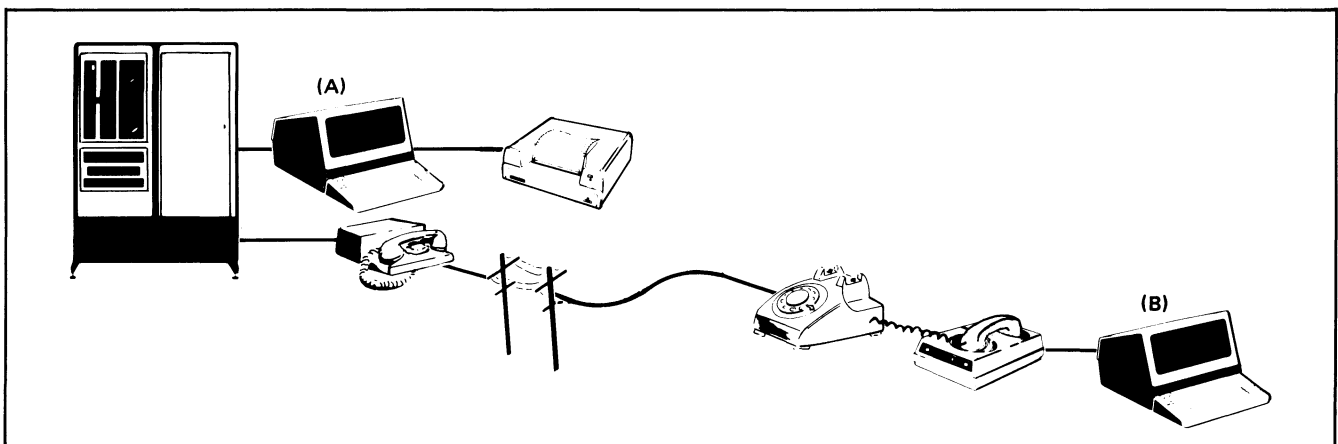
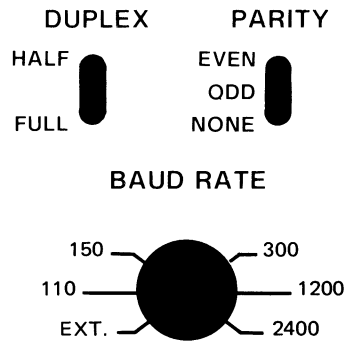

Figure 5-1. Terminal Network Configurations

Table 5-2. Data Communications Interface Capabilities

DATA COMMUNICATIONS FEATURES	Interface	
	Basic	13250B
Transfer Rate: 110, 150, 300, 1200, 2400 bits per second and external clocking (110-2400) Custom transfer rates within 1% from 37.5 to 2400 bits per second Split speed transmit/receive capability	X	X X X
EIA RS232-C	X	X
Teletypewriter compatible	X	X
ASCII	X	X
20 mA DC Current Loop		X
Transmission Modes:		
Character Transfer	X	X
Block Transfer	X	X
Half-duplex	X	X
Full-duplex	X	X
Asynchronous	X	X
Hardwired to computer; dialed (switched) or leased line	X	X
Modem Compatibility:		
Bell 103A, 202D, 202C, 202S, 202T (Asynchronous)	X	X
Vadic 3400 (Asynchronous)	X	X
Choice of main channel or reverse channel line turnaround for 202 modems	X	X
Disconnect		X
Error Checking:		
VRC, choice of parity generation/checking	X	X

Table 5-3. Keyboard Communications Switches



DUPLEX Switch. HALF: Typed characters are processed by the terminal and transmitted to the computer. FULL: Typed characters are transmitted to the computer and not processed by the terminal until returned from the computer. (This function is ignored in Block Mode.)

PARITY Switch. When set to EVEN/ODD/NONE, even/odd/no parity is transmitted for each character. Incorrect parity: a "—" (or a "■" with Option -001) is displayed.

BAUD RATE Switch. Selects data transmission rate of 110, 150, 300, 1200, 2400 baud. EXT: any rate between 110 and 2400 can be selected from an external source. The 110 baud rate uses 2 stop bits per character; all others use one stop bit.



The terminal is in Remote (on-line) operation. Otherwise, the terminal is in local (off-line) operation.



When the terminal is in Block Mode, typed data is displayed but not transmitted to the computer until requested by the computer or until after the  key has been pressed and the computer has responded. Otherwise, the terminal is in Character Mode and data is transmitted as typed. (See "Block Mode")



Transmits a BREAK signal to interrupt computer operation. (Transmits a 200 ms space on the asynchronous data communication line and sets secondary channel low for 200 ms.)

TRANSMIT

The indicator will be lighted when a data link exists for transmission between the terminal and the computer during modem operation. The Clear to Send line of the RS232C interface is high.

On-Line Mode

- Character Mode, Format Off. The entire line containing the cursor is transmitted as a block.
- Character Mode, Format On. Unprotected characters from the cursor position to the end of the unprotected field are block transmitted. The cursor is left at the first character position after the end of the field.
- Block Mode, Format Off. After receiving a DC1 from the computer informs the computer by transmitting a DC2 control character (or DC2 CR(LF) with Line Strapping – see "Strapping Options") that the terminal is ready to transmit characters from the cursor to the end of the line or memory (dependent on Line Page strapping).
- Block Mode, Format On. After receiving a DC1 from the computer, informs the computer by transmitting a DC2 (or DC2 CR(LF) with Line Strapping) that the terminal is ready to transmit line current field, or all unprotected fields from the cursor to the end of memory, each delimited by a unit separator, US (dependent on Line/Page strapping).

INTERFACE SIGNALS

The signals available on each of the communication interfaces are listed in the Installation section. This information can be used to verify interface compatibility or to fabricate special interface cables.

MODEMS

The terminal can be used with a variety of modems depending on the requirements of the given configuration or network. Table 5-5 contains a list of modems and the configurations in which they can be used.

Table 5-4. Keyboard Interface Switch Summary

SWITCH	FUNCTION	SWITCH	FUNCTION
A	Function key transmission	R	Circuit Assurance
B	Space overwrite latch	S	(Switches S and T are used to select
C	Cursor end-of-line wraparound	T	Main Channel options.)
D	Page mode	U	CPU break
E	Reverse action of CNTL key when used with F ₁ - F ₈ .	V	Carrier Detect
F	2640/2644 Handshake protocol	X	Data speed select
G	Block transfer handshake	Y	Transmit LED
H	Inhibit DC2	Z	Parity

Table 5-5. Modems

MODEM	DATA RATE (BITS/SEC)	LINE TYPE: DIALED/LEASED	DUPLEX FULL/HALF	WIRES 2/4	REV. CHAN.
Asynchronous					
Bell 103A	300	D/L	H/F	2	No
Bell 202S Bell 202C	1200	D	H	2	Option
Bell 202T Bell 202D	1200 (1)	L	H/F	2/4	Option
Vadic VA3400	1200	D	F	2	No
Notes:					
1 C2 line conditioning allows operation at 1800 bits/sec.					

COMMUNICATION PROTOCOLS

Control of computer-terminal communications is required for the orderly transfer of data. This control is provided in the form of a protocol or a set of rules and procedures. The protocol used determines who sends and who receives during each phase of communication. In addition the protocol normally provides for an orderly recovery from communication errors.

The protocols available with the terminal allow operation ranging from simple full duplex teleprinter compatibility to Bell 202 half duplex operation. The various protocols can be selected by installing the proper interface. The terminal and the interface can then be configured to meet your specific requirements.

The major characteristics of the available protocols are listed in table 5-6. The following paragraphs discuss each of these protocols.

Table 5-6. Protocol Characteristics

Basic	Standard communication protocol is teletype compatible or can use the DC1 character to trigger multicharacter transfers.
Main Channel	Communication protocol uses special framing characters to control line turn-around.
Reverse Channel	Uses a secondary channel signal to give line turn-around.

Note that in addition to these protocols the terminal contains a basic communications capability using standard RS232C communication signals.

Basic Communications is a term used to refer to point-to-point or single terminal communications. The terminal can be connected directly to a computer (hardwired) or through a modem. In most block applications the terminal can use a simple "handshake" protocol with the ASCII DC1 character. This protocol can be used with Bell 103 or equivalent modems (full-duplex operation). There are two additional protocols available, Main Channel and Reverse Channel. These protocols are normally only used with Bell 202 or equivalent modems (half-duplex operation).

The remainder of this section provides descriptions and samples of control and data transfer sequences for various protocols. Included are examples of typical communication programs. Detailed flowcharts of the various protocols are given in Appendix C.

BASIC COMMUNICATIONS

The terminal can operate character-by-character as a completely interactive terminal or on a block of data at a time. Block transfers allow data to be composed and edited at the terminal allowing the user to verify and correct data before sending it to the computer.

OPERATING AT HIGH SPEEDS

If the number of characters sent to the terminal in one sequence exceeds 80, the required terminal processing time may cause some of the characters to be lost. (This usually does not occur at data rates of 1200 baud or less.) The symptom of this problem is the appearance of the ■ (delete) or - characters.

There are two ways of insuring that this problem will not arise:

- It is possible to use a call-and-answer procedure between the terminal and the computer. If the computer sends an ENQ (octal 5) character after sending 80 characters, the terminal will respond with the ACK (octal 6) after it has processed the characters. The computer can then send the next block of characters. This is the recommended technique.
- Alternately, delays can be inserted in the application or system software after each 80 character transfer from the computer to the terminal. Transmitting NULL characters (octal 0) is one way to accomplish this. Each NULL character has the effect of a 4 millisecond delay when operating at 2400 baud. As an aid in calculating needed time delays, a list of processing times for various terminal functions is provided in table 5-7. The times listed are typical and can vary greatly depending on such factors as the number of characters in the terminal memory or on the display, and the current operating mode.

Table 5-7. Processing Times for Selected Terminal Functions

TERMINAL FUNCTION	TYPICAL REQUIRED TIME (MILLISECONDS)
Cursor up/down	5
Cursor left	5
Home	200 (Format Mode only)
Erase-to-end-of-line	8 (Format Mode only)
Delete character	32
Format on	200
Line feed	38
Insert character	44
Horizontal tab	33 (Format Mode only)
Reset Terminal	200 (minimum)

Table 5-8. Keyboard Interface PCA Options

SWITCH	OPTION	NORMAL OPERATION (SWITCH CLOSED)	OPERATION WITH SWITCH OPEN
A	Function Key Transmission	The escape code sequence generated by the major function keys (such as, ROLL UP, ROLL DOWN, etc.) are executed locally, but not transmitted to the computer.	The escape code sequences generated by all keys are transmitted to the computer. If operating in half duplex, the function is also executed locally.
B	Space Overwrite (SPOW) Latch Enable	Spaces typed will overwrite existing characters.	When the SPOW latch is off, overwriting occurs as normal. When the SPOW latch is on, spaces cause the cursor to forward but not overwrite any existing characters. The SPOW latch is turned on by a Carriage Return, and off by a Line Feed, Home or Tab.
C	Cursor End-of-Line Wrap Around	At the end of each line, a local Carriage Return and Line Feed are generated; the cursor moves to the beginning of the next line.	A Carriage Return and Line Feed are not generated at the end of each line. The cursor remains in and overwrites column 80.
D	Block Mode, Page	The terminal is set to transfer a line at a time in Block Mode.	Entire pages of information are transferred in Block Mode.
E	Reverse Sense of CNTL key.	The terminal sends escape code sequences for the F ₁ -F ₈ keys when they are pressed while holding the CNTL key down. If the CNTL key is not pressed, the functions printed below the keys are performed.	Operation is reversed. The functions printed below the keys are performed when the function keys are pressed while holding the CNTL key down. If the CNTL key is not pressed, the terminal sends the escape code sequences associated with the F ₁ -F ₈ keys.
F	2640/2644 Protocol Handshake	A DC2 character is sent when the ENTER key is pressed. If strapped for page (switch D) the terminal will also send a DC2 when the F ₁ -F ₈ keys are pressed. ESC E will not clear terminal memory.	The DC2 character is sent only in response to a DC1 character from the computer. ESC E will have the same effect as RESET TERMINAL.
G	Block Transfer Handshake	In Block Mode, all data transfers to the computer are sent upon receipt of a DC1 from the computer.	All Block Mode transfers (i.e., cursor sense, terminal and device status, display memory, and function keys) are preceded by a DC2. The terminal sends the DC2 upon receipt of a DC1 from the computer. After the CPU receives the DC2 from the terminal, another DC1 is required to trigger transmission of data from the terminal.
H	Inhibit DC2	During Block Mode Handshake transfers, the terminal sends a DC2 in response to a DC1 prior to sending data. (See Block Transfer Handshake strapping above.)	A DC1 from the computer is not required to trigger data transfers to the computer. Also, the DC2 from the terminal is not sent during Block Mode Transfer handshakes. (See Block Transfer Handshake strapping above.) Additionally, when the  key is pressed in Block Mode the cursor will be placed in the first column before transmission occurs if operating in Line/Field Mode (switch D closed) or Home'd if operating in Page Mode (switch D open.) Opening both switches G and H eliminate the terminal's use of the Handshake protocol entirely.

Table 5-8. Keyboard Interface PCA Options (Continued)

SWITCH	OPTION	NORMAL OPERATION (SWITCH CLOSED)	OPERATION WITH SWITCH OPEN
R	Circuit Assurance	The transition from receive state to transmit state occurs after both CB (106) (Clear to Send) and SB (122) (Secondary Receive Data) go on within 2.6 seconds. Otherwise, the terminal returns to the receive state.	The transition from receive state to transmit state occurs after CB (106) (Clear to Send) goes on.
S, T	Main Channel Protocol	Non-main channel protocol (both switches closed).	<p>S-closed, T-open: Main channel with STX/ETX as Start of Data and End of Data.</p> <p>S-open, T-closed: Main channel with EOT as End of Data.</p> <p>S-open, T-open: Main channel with ETX as End of Data.</p>
U	CPU Break	The CPU can interrupt the terminal while it is in the transmit state. The CPU initiates an ON to OFF transition of the SB (122) (Secondary Receive Data) line. The terminal responds by turning off CA (105) (Request to Send) and going to the receive state.	The terminal ignores all transitions on the SB (122) (Secondary Receive Data) line from the modem in the transmit state.
V	Carrier Detect	When the terminal is in the receive state, an ON to OFF transition of CF (109) (Carrier Detect) line from the modem causes the terminal to go into the transmit state. Transitions of CF have no effect while the terminal is in the transmit state.	Transitions of CF (109) (Carrier Detect) line have no effect on the terminal.
X	Data Speed Select	Holds data speed signal low (CH (111) = 0).	Sets data speed signal high (CH (111) = 1).
Y	Transmit LED	The TRANSMIT light on the keyboard is turned on when CB (106) (Clear to Send) line from the modem is high. It is turned off when the CB (106) line goes low.	The TRANSMIT light on the keyboard is turned on when the CC (107) (Data Set Ready) line from the modem is high and the 13250B Extended Asynchronous Communications Interface PCA is used. It is turned off when the CC line goes low.
Z	Parity	<p>The PARITY switch on the terminal keyboard is affected as follows:</p> <p>No Parity: Send 8 bits and receive 8 bits. Force bit 8 to zero. No check for parity error.</p> <p>Odd Parity: Send 7 data bits + odd parity. Receive 7 data bits + odd parity. Check for parity error.</p> <p>Even Parity: Send 7 data bits + even parity. Receive 7 data bits + even parity. Check for parity error.</p>	<p>No Parity: Send 8 bits and receive 8 bits. Force bit 8 to one on send. No check for parity error.</p> <p>Odd Parity: Send 7 bits + odd parity. Receive 7 bits. No check for parity error.</p> <p>Even Parity: Send 7 data bits + even parity. Receive 7 data bits. No check for parity error.</p>

CHARACTER MODE

In Character Mode operation (BLOCK MODE key up), the terminal sends characters to the computer as they are typed. This mode of operation can be used for conversational exchanges with the computer.

Example:

```

Computer:   Please type your company name
User types: AJAX
Computer:   What file number would you
            like from the AJAX library?
User types: 12345
and so on   ...
    
```

MULTICHARACTER TRANSFERS

There are certain functions that always result in multicharacter (block) data transfers.

- special function keys
- status requests
- cursor sensing
- all transfers while in Block Mode

In order for the terminal to make a block transfer, it must first be enabled and then triggered by the computer. Transfers are enabled by the ENTER or special function keys while the terminal is in Block Mode (see figure 5-2). When the transfer is enabled from the keyboard, the terminal sends a DC2 character to the computer to indicate that a data block is ready for transmission. (This process can be modified by strap settings on the Keyboard Interface, refer to section VII.) The transfer can also be enabled from the computer by an escape sequence requesting status (ESC ^), cursor sensing (ESC a), or display transmission (ESC d) as shown in figure 5-3.

When the transfer is enabled the keyboard is locked out until the transfer is complete. Enabling sequences should not be entered from the keyboard because they will cause the keyboard to be locked until the computer responds with a DC1 character.

Once a block transfer has been enabled, it must be triggered by the computer before the block of data is actually sent. The computer triggers the transfer by sending a DC1 character when it is ready to receive the data. The terminal also assumes that it has received the trigger when it is first powered up or fully reset, or when the REMOTE key is pressed (down).

The computer software must support the handshaking process used in multiple character transfers. The DC2 character must be recognized as a request to send data and the DC1 character must then be sent to trigger the transfer after buffers have been allocated to receive the data. Additional software support may be needed depending on your need for terminal control. There are straps on the Keyboard Interface that can be used to modify the handshaking process. These are discussed later in this section.

NOTE

The computer should not be allowed to echo back information that has been transmitted as a block from the terminal.

BLOCK MODE

When the terminal is in Block Mode (BLOCK MODE key down), characters are not transmitted as they are typed. Instead, the user can input data to the terminal, then edit and correct the data before sending it to the computer using the ENTER key. The data can be grouped into convenient blocks, either lines or pages (refer to the configuration procedures later in this section). Block Mode operation allows you to efficiently utilize computer and communication facilities.

The size of the block of information transferred in BLOCK MODE, and the control characters used to separate fields and to terminate blocks differ somewhat, depending on the Line/Page Strapping of the terminal and whether or not the terminal is operating in FORMAT MODE. Figure 5-4 illustrates these differences.

In the example in figure 5-5, the user has an application in which order data is to be entered in the same format as a standard company form.

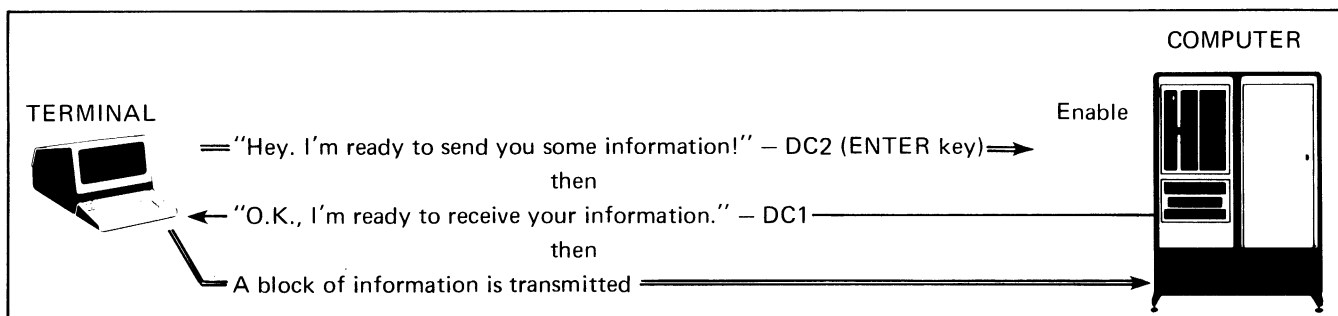

Figure 5-2. Block Transfer Enabled By The ENTER Key

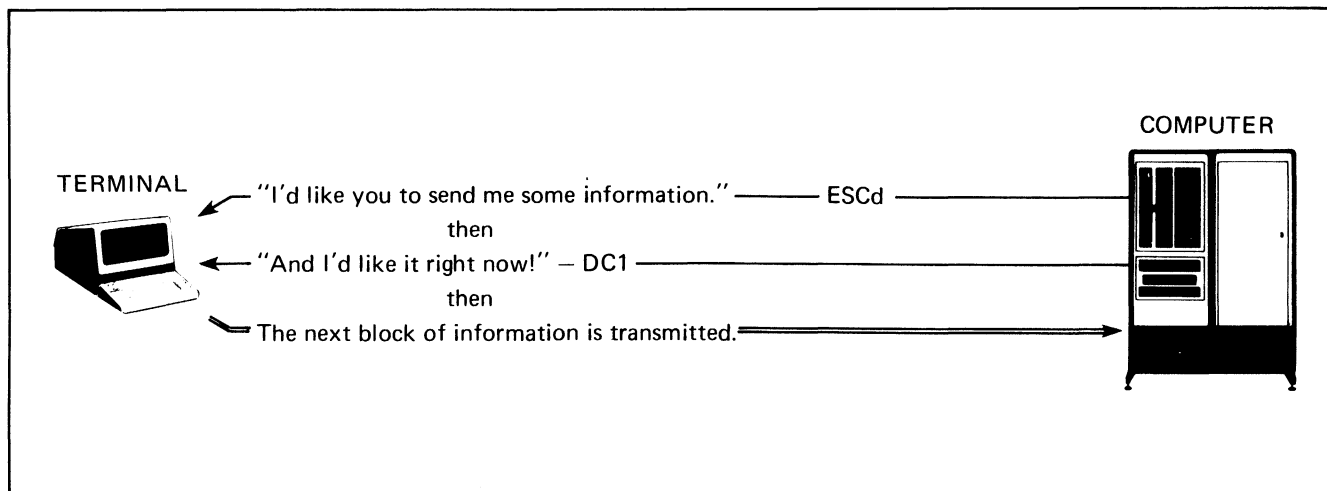

Figure 5-3. Block Transfer Enabled By The Computer

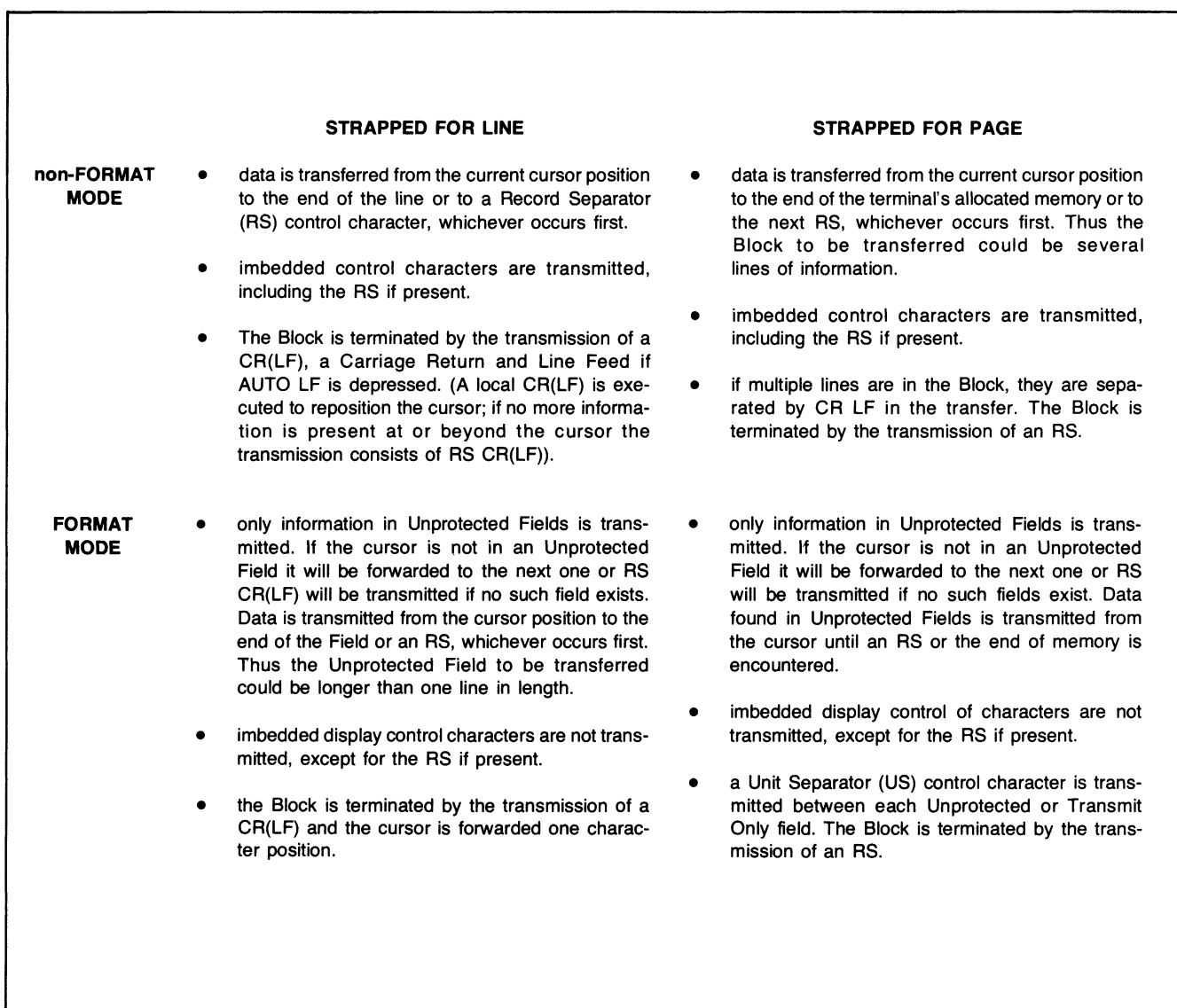

Figure 5-4. Block Mode Operation

STEP 1. The user presses the Special Function key, which he has previously programmed in a remote computer routine to both automatically display the form shown and turn on FORMAT MODE. (REMOTE and BLOCK MODE are depressed.)

STEP 2. All areas of the display have been programmed to be protected except for the dark fields within the form itself. Thus, as data is typed at the keyboard only these dark areas can be written into. The cursor automatically will tab from one field to the next when a field boundary is encountered or by use of the



key. The user now inputs data from the keyboard:

ORDER #	COMPANY NAME	SHIPPING ADDRESS: STREET			
█-█	██████████	████████████████████			
DATE	BILLING #	CITY	STATE	ZIP	
█/█/█	█-█-█-█	██████████	█	████	
ITEM #	PRODUCT NAME	PRICE	QNTY	TOTAL	CODE
█	██████████	█	█	█	█
			+	=	
			+	=	
			+	=	
			+	=	

The complete form would look as follows:

ORDER #	COMPANY NAME	SHIPPING ADDRESS: STREET			
01-2345	HEWLETT-PACKARD	11000 WOLFE ROAD			
DATE	BILLING #	CITY	STATE	ZIP	
08/XX/75	01-23-456-789012	CUPERTINO	CA	95014	
ITEM #	PRODUCT NAME	PRICE	QNTY	TOTAL	CODE
0123AB456	SCREW DRIVER	\$509.95	*+10	= \$5099.95	ABCDE
7890CD123	SOCKET WRENCH	\$8.00	*+5	= \$40.00	ABCDE
4567EF390	PRECISION COMPASS	\$12.95	*+10	= \$129.50	FGHIJ
			+	=	

STEP 3. After filling out the form and correcting any noticed errors, the  key is pressed once. The following sequence of events would then occur:

- The terminal transmits a DC2.
- Computer software recognizes the DC2 and responds with a DC1.

- The terminal receives the DC1 and transmits all data as one Block, fields separated by US's and the Block terminated by an RS:

STEP 4. The form full of data has been transmitted to the computer. The user could then Home the cursor, hit , to clear only the data from the form in FORMAT MODE, and enter a second set of data inputs — repeating the sequence and reusing the form.

Figure 5-5. Example of Format Mode with Page Strapping

FULL DUPLEX OPERATION

In full duplex operation, the characters which are typed at the keyboard are transmitted to the computer and are not displayed unless they are returned by the computer. This setting is ignored when in Block Mode.

TELETYPE COMPATIBLE COMMUNICATIONS

In teletype compatible (full duplex, character mode) applications, the terminal can be quickly configured for use by following the instructions given in the Installation section. Note that if block data transfers are used the computer should be programmed to use the simple DC1/DC2 protocol described under Block Transfers.

HALF DUPLEX OPERATION (202 MODEM COMPATIBILITY)

In half duplex operation, data is sent in only one direction at a time. In order to change the direction of data flow, a line turn around must occur. This means that the sender becomes the receiver and the receiver becomes the sender. Line turn arounds are controlled by half duplex line protocols. Both the computer and the terminal must use the same protocol otherwise malfunction and loss of data will result.

Initially the terminal is in the transmit state. While in this state the terminal will ignore data sent from the computer. The terminal will remain in the transmit state until one or more of the following occur:

- An ON to OFF transition on the SB (CCITT 122) line (Reverse Channel)
- The user sends an end of data character from the keyboard (control-C, control-D)
- An end of data character (ETX or EOT) is sent (Main Channel)

The above conditions cause the terminal to switch to the receive state.

The terminal then receives and processes data until one of the following occurs:

- An ON to OFF transition of the CF (CCITT 109) line (Reverse Channel)
- An end of data character (ETX or EOT) is received (Main Channel)
- An ETX is entered at the keyboard.

The terminal then requests the computer or modem for permission to transmit. The computer or modem responds by turning on the CB (CCITT 106) and SB (CCITT 122) lines. (If the computer or modem does not respond within

2.6 seconds the terminal will return to the receive state.) If the computer is ready the terminal will begin to send any data present in its output buffer.

The terminal provides a range of half duplex line protocols, including Bell 202 modem compatible protocols. These protocols are selected by switch settings on the Keyboard Interface PCA. Table 5-8 contains a list of the communication switches that are used to select half-duplex protocols.

Half-duplex operation can be controlled either by RS232C signal lines or by control characters in the data being transferred or by a combination of characters and signals. The Main Channel protocol uses control characters while the Reverse Channel protocol uses control signal lines.

MAIN CHANNEL (CHARACTER CONTROL) PROTOCOL. The Main Channel protocol is for use in half-duplex or Bell 202 modem equivalent networks where secondary channel signals are not available. The Main Channel protocol uses control characters to "frame" each data transmission. These framing characters indicate to the receiving station that a data transmission has begun or ended.

An ASCII STX (octal 002) character can be used to indicate the start of a data transmission. An ASCII ETX (octal 003) or EOT (octal 004) character is used to indicate the end of a data transmission. When these characters are received they are used to perform a line turn-around.

The following switch settings should be made on the Keyboard Interface PCA to operate using the Main Channel protocol:

SWITCH	SETTING	DESCRIPTION
R	Open	
S,T	Closed, Open Open, Closed Open, Open	<STX> data <ETX> data <EOT> data <ETX>

Note that at least one of the S or T switches must be open to select Main Channel protocol.

Example:

U,V,W,X,Y,Z All Open — Variations of the Main Channel Protocol are discussed under Other Protocols and in Appendix C.

The operation of the Main Channel protocol is shown in figure 5-6. Sample data transfers are shown in figure 5-7. Figures 5-7a and 5-7b illustrate the line turn-around that occur during a log-on sequence when in character mode. Figures 5-7c and 5-7d illustrate the transfers that occur during block mode operation.

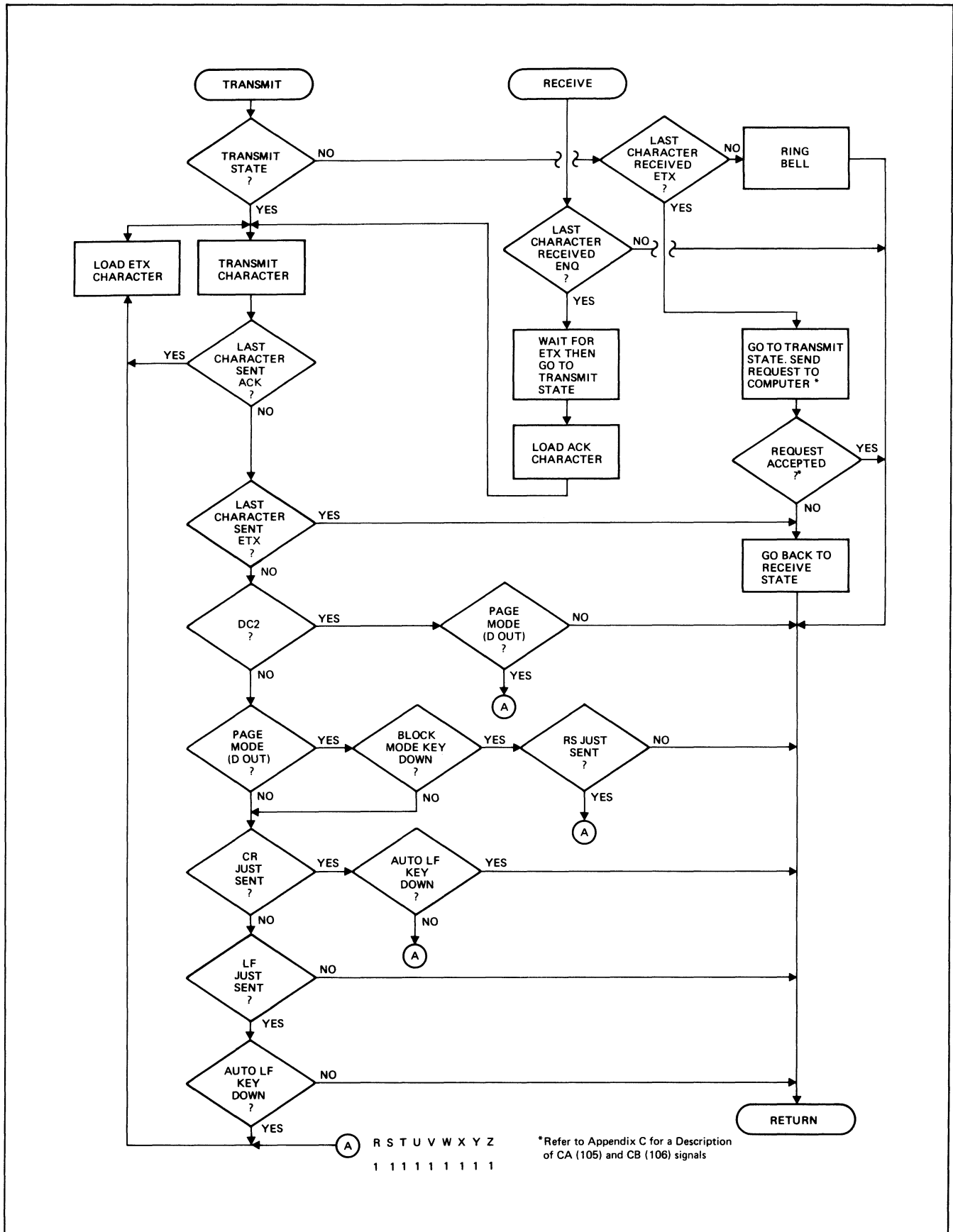

Figure 5-6. Main Channel Protocol

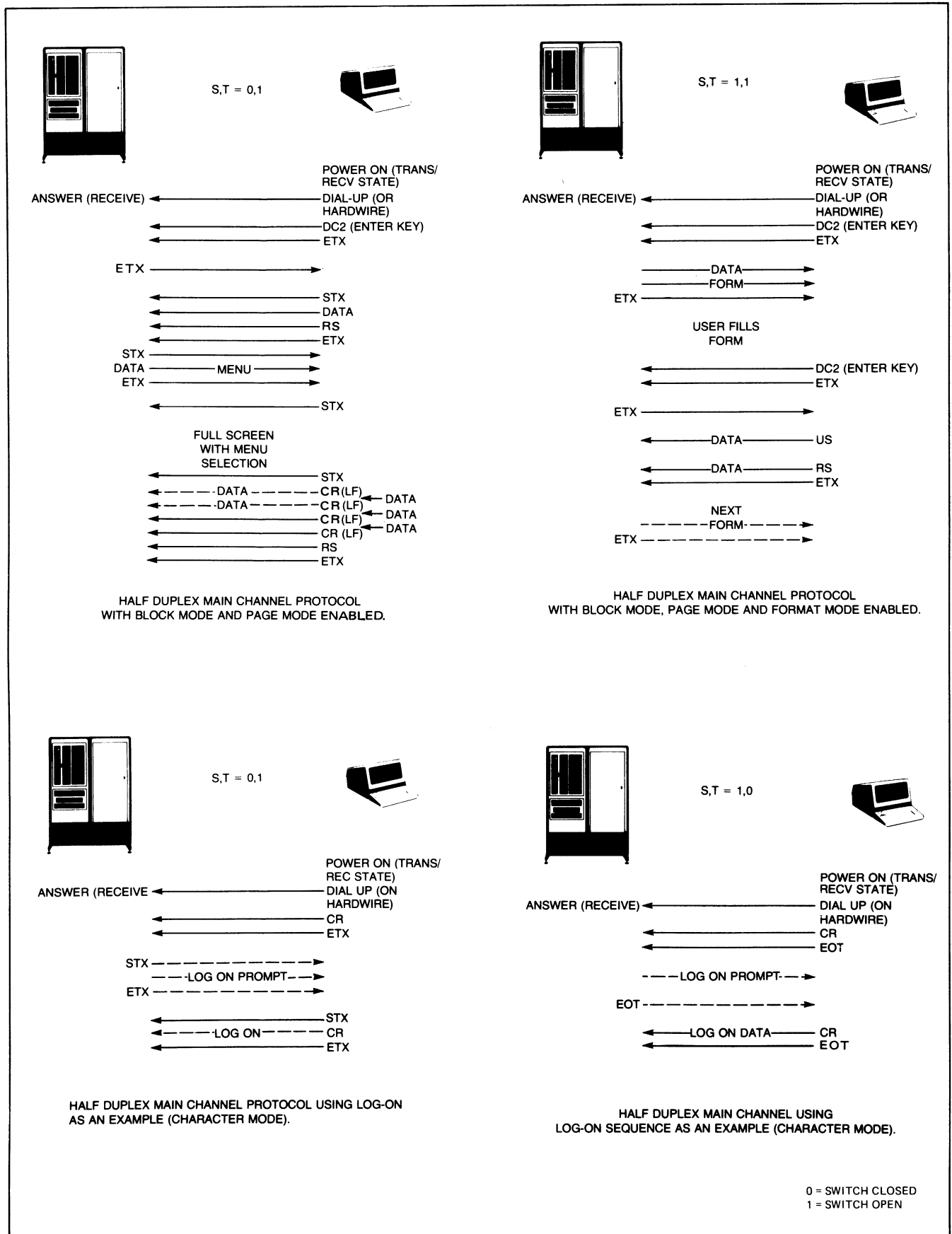

Figure 5-7. Sample Data Transfers Using Main Channel Protocol

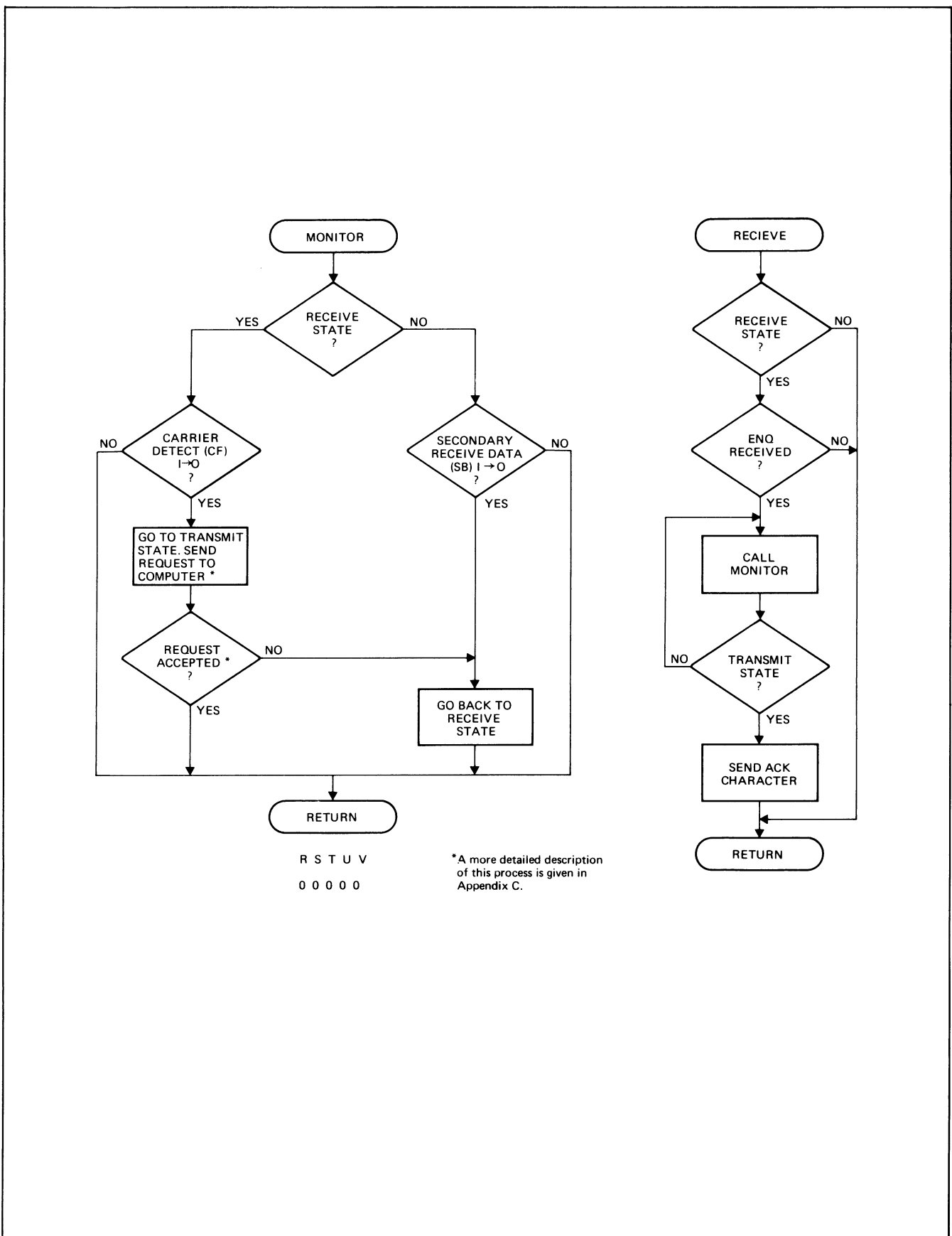

Figure 5-8. Reverse Channel Protocol

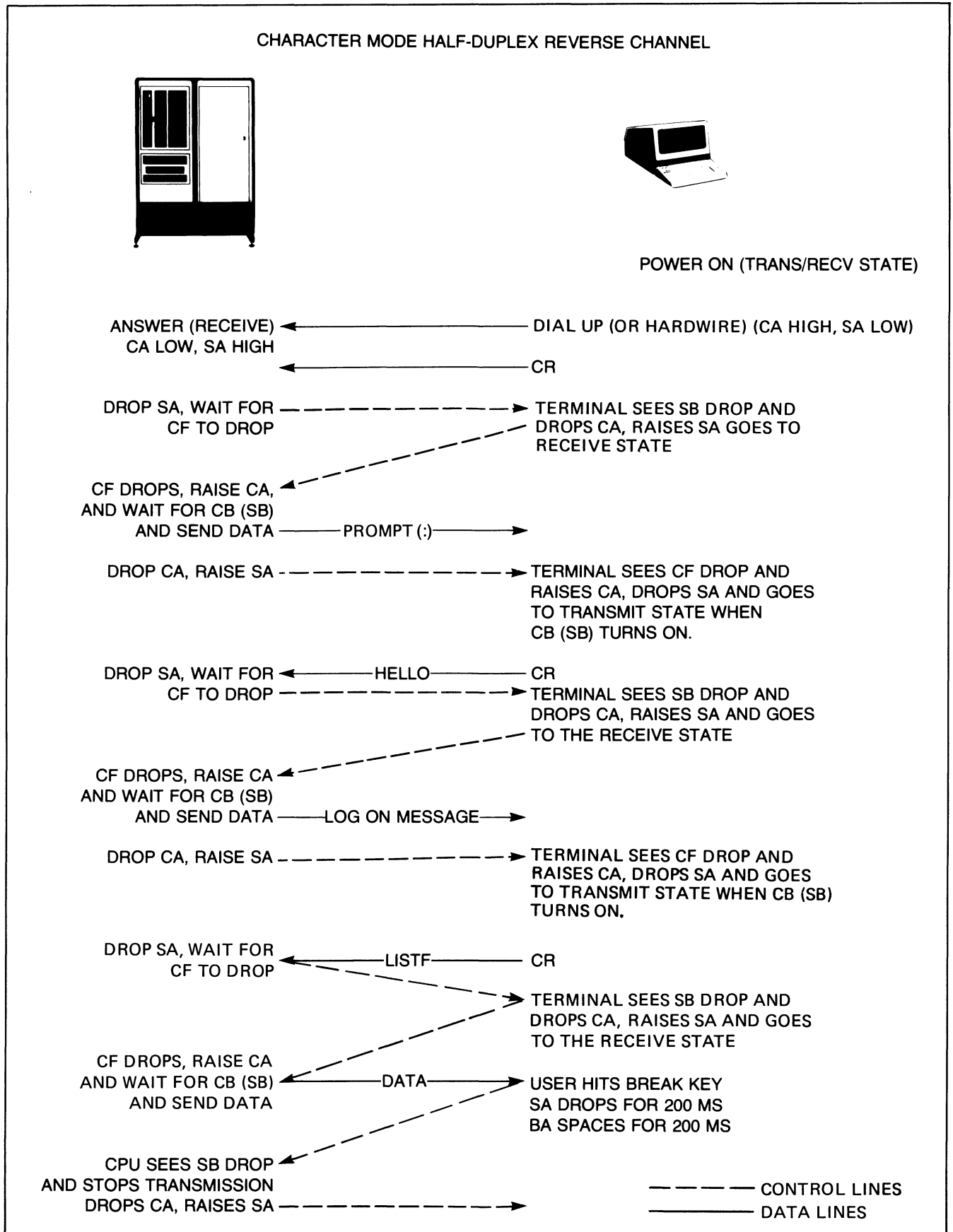

Figure 5-9. Sample Data Transfers Using Reverse Channel Protocol

REVERSE CHANNEL (SIGNAL LINE CONTROL) PROTOCOL. The Reverse Channel protocol is for use in half-duplex or Bell 202 modem equivalent networks where secondary channel signals are available. The Reverse Channel protocol uses changes on secondary channel lines SA (CCITT 120) and SB (CCITT 122) to control line turn-arounds.

The following settings should be made on the Keyboard Interface PCA to operate using the Reverse Channel protocol.

SWITCH	SETTING	DESCRIPTION
R	Closed	Monitor the SB line
S,T	Closed, Closed	Reverse Channel (no framing characters)
U	Closed	Watch for computer interrupts (SB drops)
V	Closed	Watch for the Carrier Detect (CF) signal to drop.

Example:

W,X,Y,Z All Open — Variations of the Reverse Channel protocol are discussed under Other Protocols and in Appendix C.

The operation of the Reverse Channel protocol is shown in figure 5-8. Sample data transfers are shown in figure 5-9.

OTHER PROTOCOLS. In addition to the Main and Reverse Channel protocols you can select various features of both to configure a custom protocol to suit your own requirements. A flowchart of the overall Basic Communications function including the Half-Duplex settings is given in Appendix C. You can create a custom protocol using this flowchart and the switch descriptions in table 5-8.

CONFIGURATION

A procedure for configuring the terminal is given in figure 5-10.

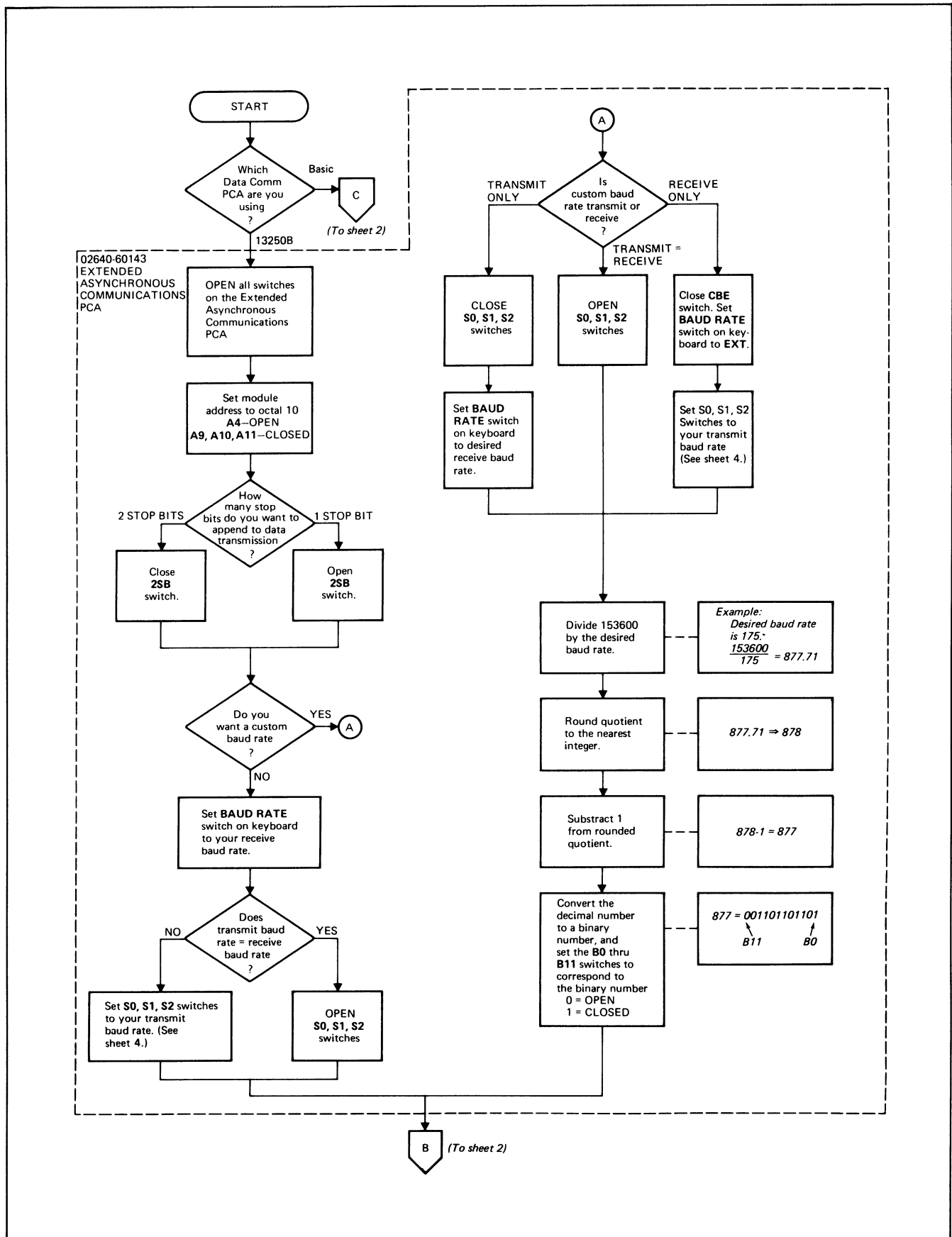

Figure 5-10. Data Communications Configuration Flowchart (Sheet 1 of 4)

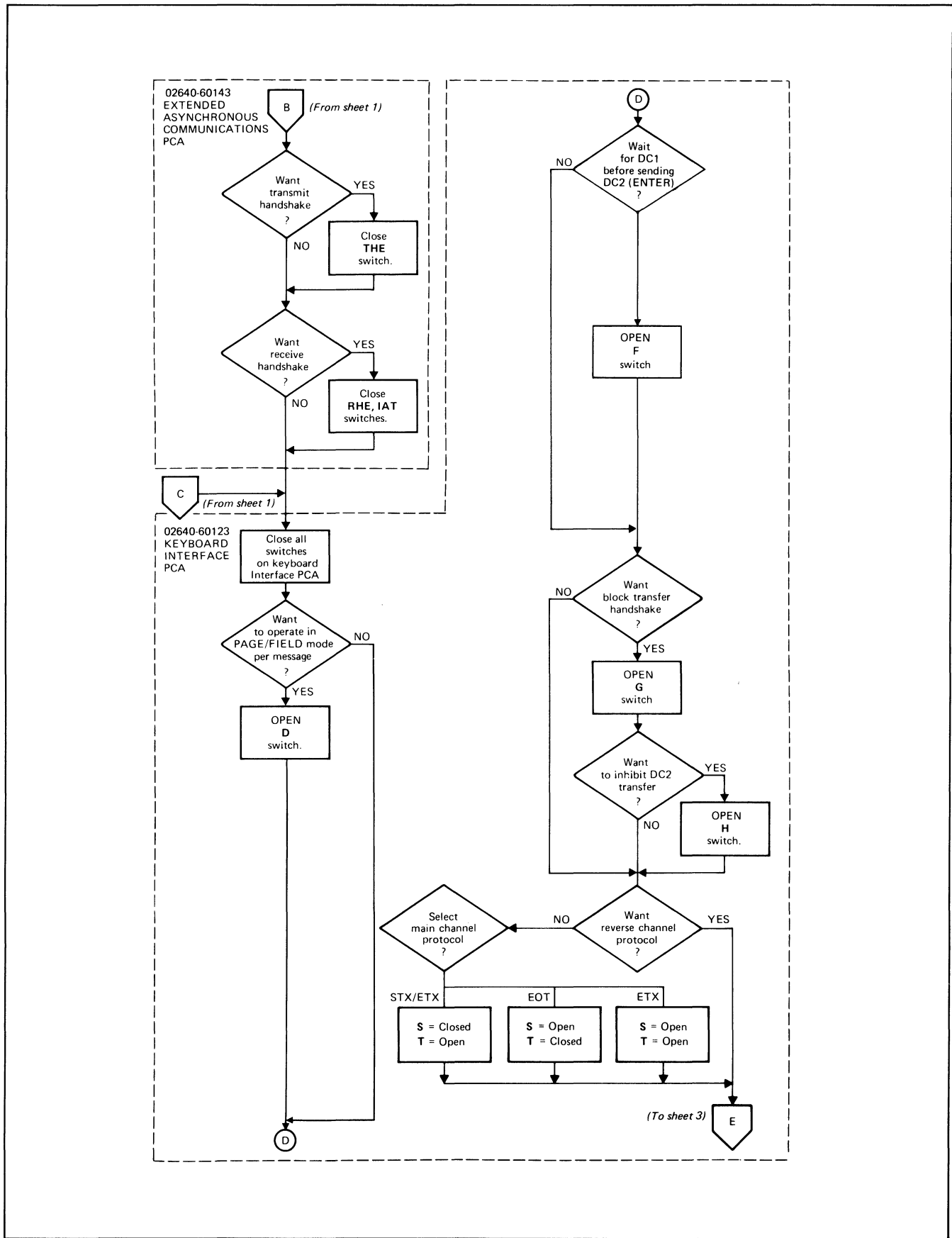

Figure 5-10. Data Communications Configuration Flowchart (Sheet 2 of 4)

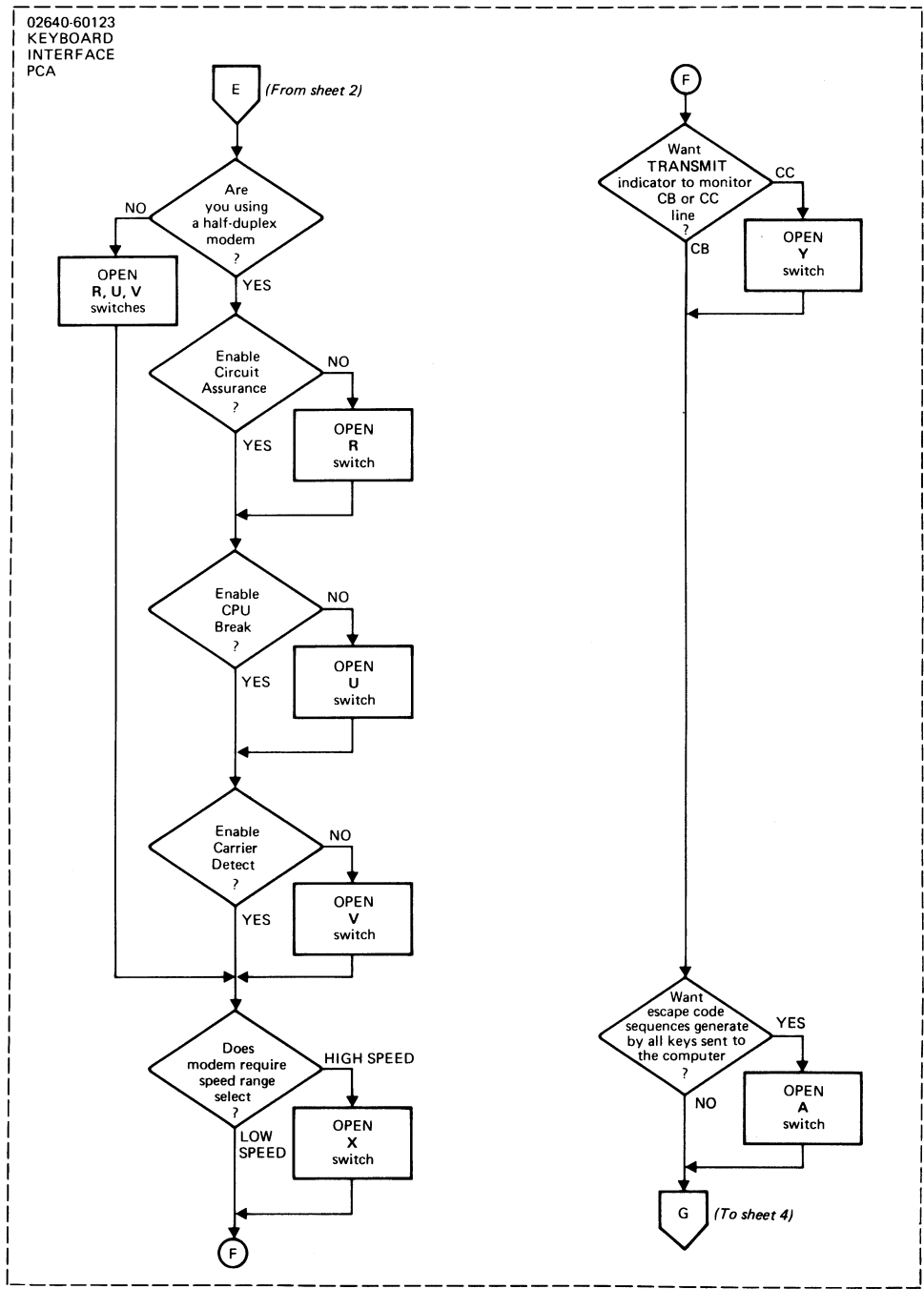

Figure 5-10. Data Communications Configuration Flowchart (Sheet 3 of 4)

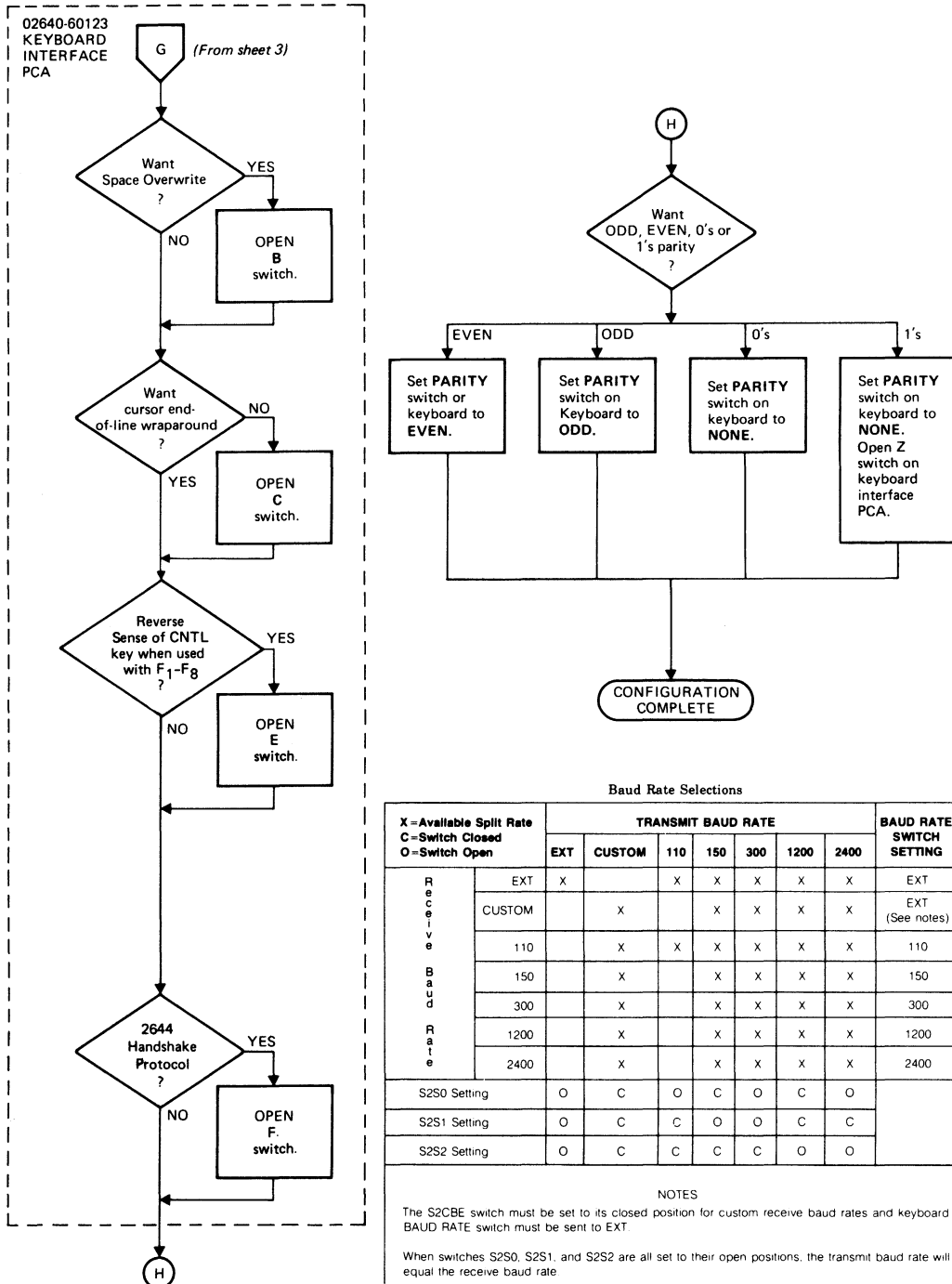

Figure 5-10. Data Communications Configuration Flowchart (Sheet 4 of 4)

INTRODUCTION

This section contains information on how to obtain and interpret terminal status information. Status requests are made by sending an escape code sequence to the terminal to select the desired status information. All status requests are treated as block transfers. (Refer to Multicharacter Transfers in Section V). The examples that follow use the DC1 character to trigger the status transfer (Basic Communication Protocol).

INTERPRETING STATUS

In response to status requests the terminal returns an escape code sequence followed by one or more bytes. The status bytes are followed by a terminator. The terminator received may be a CR(LF) or RS. The examples that follow use the CR character as a terminator.

Terminal status is made up of 6 status bytes (bytes 0-5) containing information such as display memory size, switch settings, keyboard interface configuration, and terminal errors.

The status information is contained in the lower four bits of each status byte. The upper four bits of the bytes are set so that the byte will have the value of an ASCII character. Each byte can be interpreted as one of 16 characters as follows:

ASCII CHARACTER	BINARY
0	0011 0000
1	0011 0001
2	0011 0010
3	0011 0011
4	0011 0100
5	0011 0101
6	0011 0110
7	0011 0111
8	0011 1000
9	0011 1001
:	0011 1010
;	0011 1011
<	0011 1100
=	0011 1101
>	0011 1110
?	0011 1111

TERMINAL STATUS

The terminal status (bytes 0-5) is requested by sending the following escape sequence.

Terminal Status Request

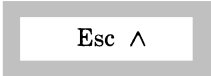

The terminal will respond with an ESC \ and 6 status bytes followed by a terminator. A typical primary terminal status request and response is shown in figure 6-1. The example is for a configuration requiring the DC1 character to trigger block transfers.

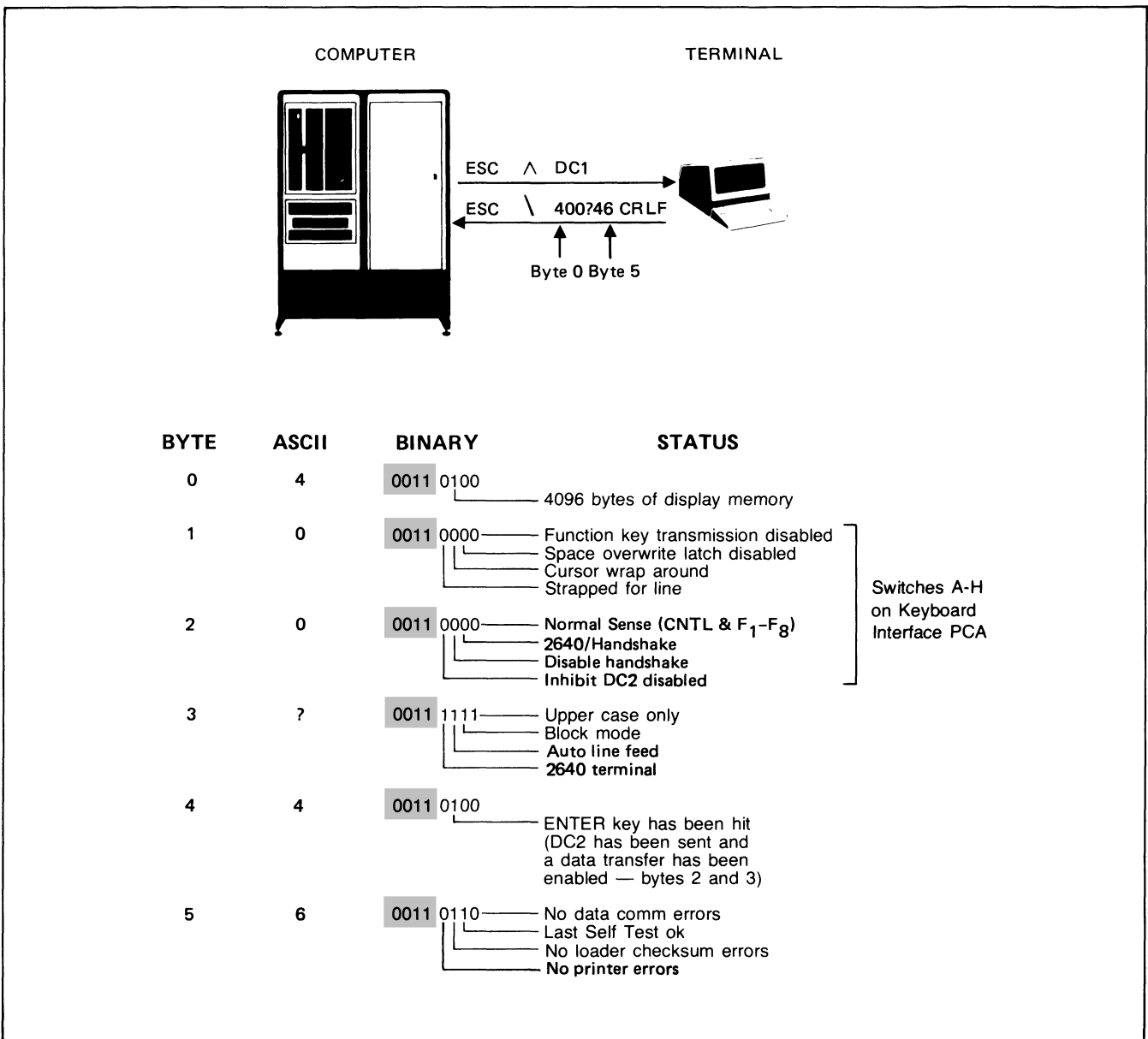
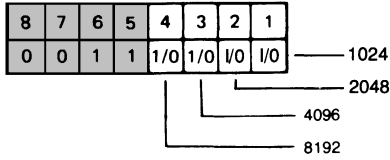

Figure 6-1. Terminal Status Example

BYTE 0 DISPLAY MEMORY SIZE



The amount of display memory available in the terminal is returned. The amount can range from 4096 to 8192 bytes.

BYTE 3 LATCHING KEYS

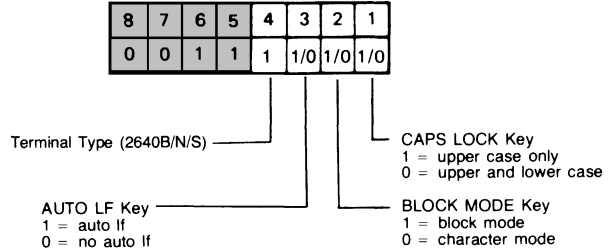

BYTE 1 KEYBOARD INTERFACE SWITCHES (A-D)

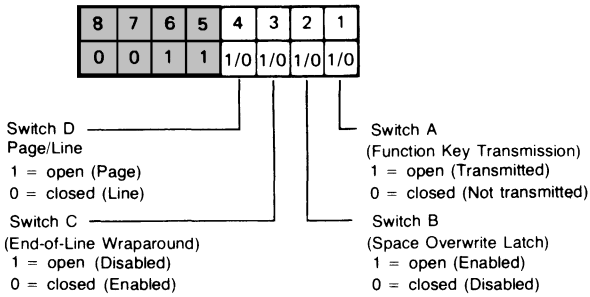

Refer to Section V for a detailed description of Keyboard Interface switches.

BYTE 4 TRANSFER PENDING FLAGS

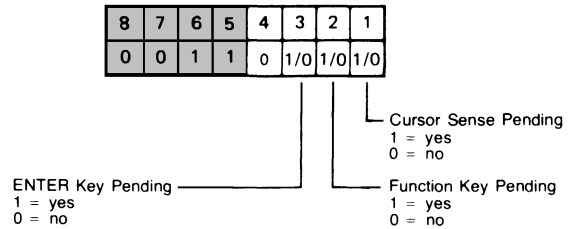

BYTE 2 KEYBOARD INTERFACE SWITCHES (E-H)

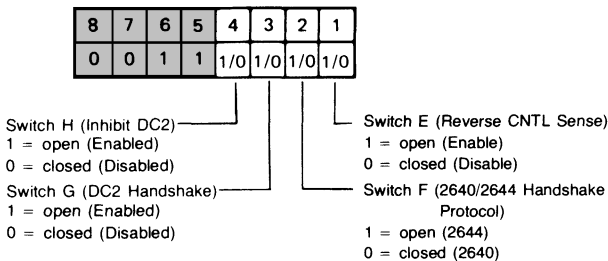

Refer to Section V for a detailed description of Keyboard Interface switches.

BYTE 5 ERROR FLAGS

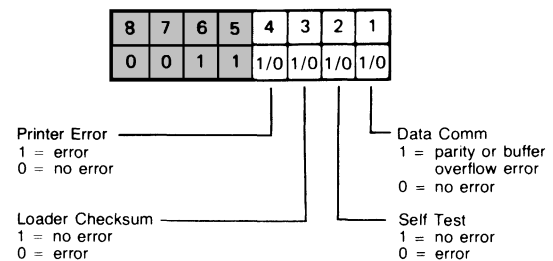

Figure 6-2. Terminal Status Bytes

INTRODUCTION

This section contains instructions for selecting optional ac operating voltages (115 or 230V), selecting optional

operating functions, and installing terminal add-on accessories.

**WARNING**

Hazardous voltages are present inside equipment. The procedures contained in this section shall be performed only by qualified service personnel.

**VORSICHT**

Innerhalb des Geräts bestehen gefährliche Spannungen. Die in diesem Abschnitt enthaltenen Arbeiten dürfen nur durch Betriebsfachpersonal durchgeführt werden.

**ATTENTION**

Des tensions dangereuses sont présentes à l'intérieur du matériel. Les opérations décrites dans cette section ne devront être effectuées que par un personnel qualifié.

**AVVISO**

Pericolo: Alta tensione presente in questa apparecchiatura. Le procedure contenute in questa sezione debbono essere effettuate soltanto da qualificato personale di servizio.

**ADVERTENCIA**

Hay voltaje peligroso en el interior de este equipo. Los procedimientos expuestos en esta sección sólo deberá llevarlos a cabo el personal de servicio calificado.

**高圧危険**

内部装置に危険な高電圧がきています。この章にある処置や手続に関しては、専門のサービスマンによってのみ行なって下さい。

OPENING THE TERMINAL

To gain access to the terminal internal components, open the terminal as follows (also see figure 7-1):

- a. Set mainframe rear panel ~ LINE switch to OFF and disconnect power cord from ~ LINE connector.

NOTE

Mainframe top cover is unlocked by inserting access key supplied with terminal in each of the keyways located on right and left sides of top cover. Inserting keys into keyways unlock top cover. No key rotation is required.

- b. From front of terminal, insert access key into right keyway and unlock right side of terminal by slightly raising right side of top cover. (figure 7-1, A and B).
- c. While maintaining upward pressure to keep right side of terminal unlocked, insert access key into left keyway and raise top cover until both right and left sides of terminal are unlocked. (figure 7-1, C).

- d. Using both hands, carefully swing top cover up until it latches into the half open position. (figure 7-1, D).

NOTE

The half open position provides adequate room for performing most service routines. However, if extensive repairs are to be made or if components contained in the top cover are to be serviced, fully open mainframe in accordance with step e.

CAUTION

Mainframe top hinges are open hinge type. When fully opening terminals do not allow top hinges to slip off hinge pins.

- e. Firmly grasp top cover in one hand and release safety latch (see figure 7-2) by pressing it inboard with other hand. Then, using both hands, swing top cover up and over to a full open position (resting on its top).

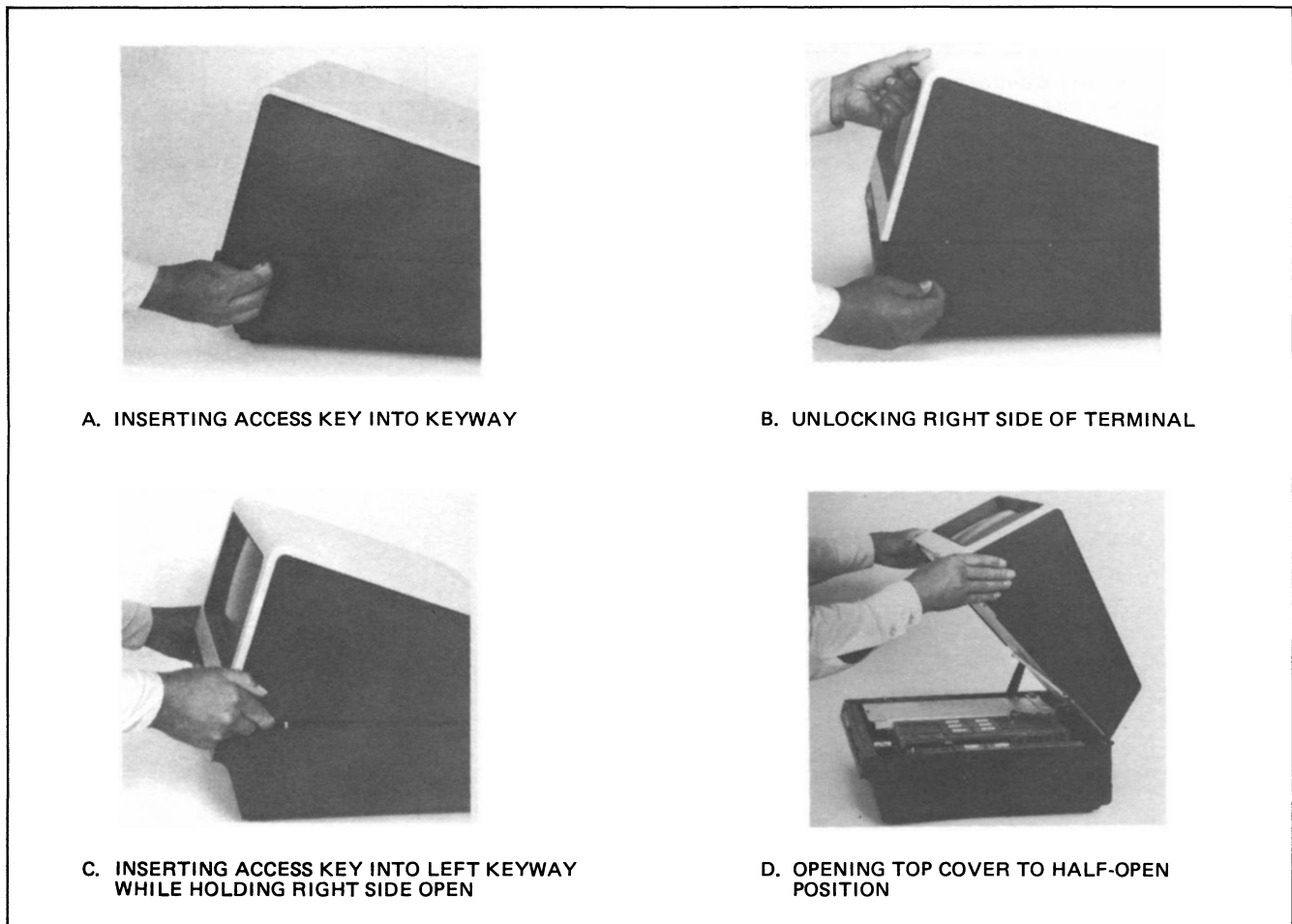
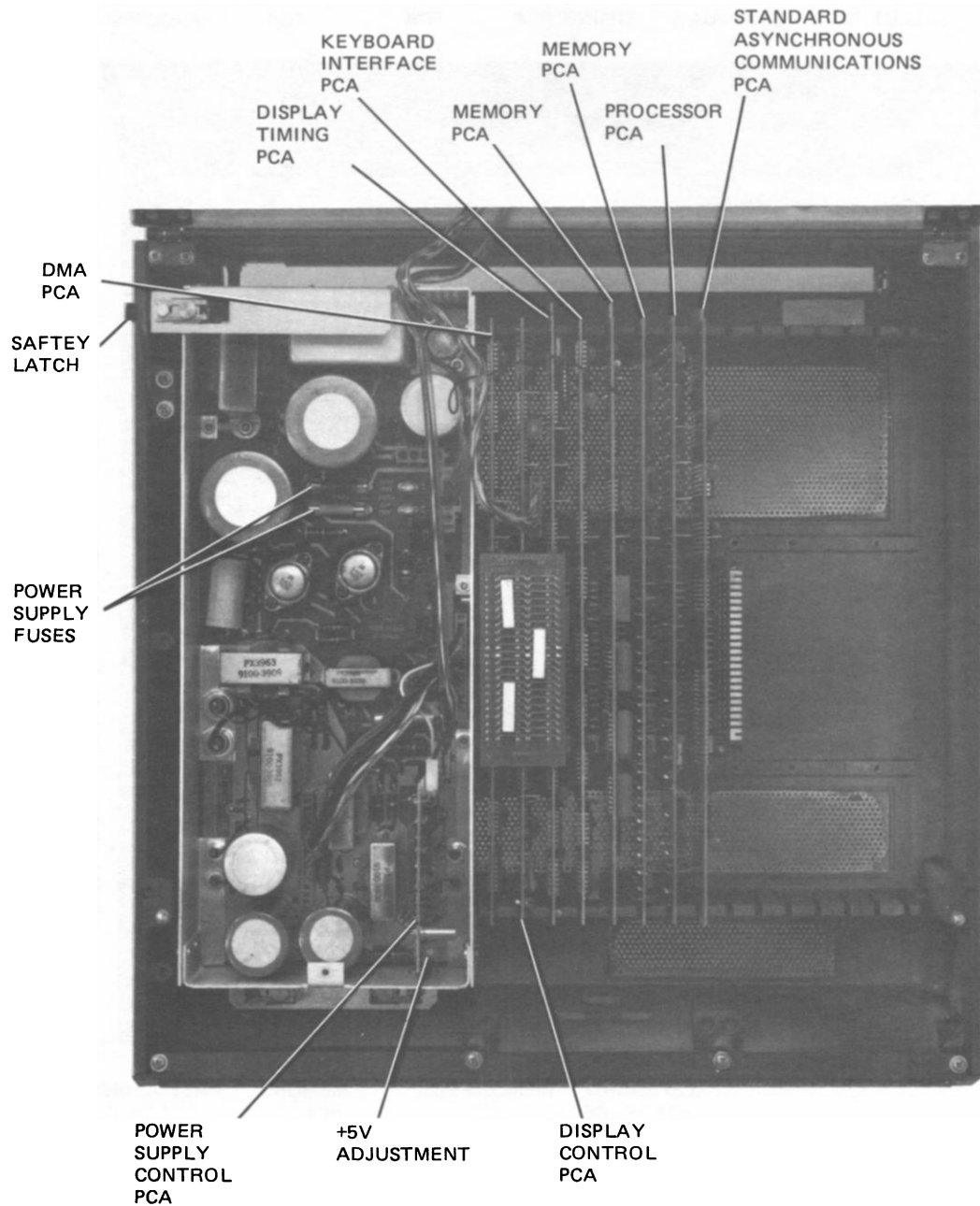

Figure 7-1. Opening the Terminal



NOTES: 1. POWER SUPPLY IS SHOWN WITH TOP COVER REMOVED.
 2. PCA ARRANGEMENT IS A TYPICAL CONFIGURATIONS.
 ARRANGEMENT MAY VARY AMONG TERMINALS.

Figure 7-2. Mainframe Bottom Parts Locations (Sheet 1 of 2)

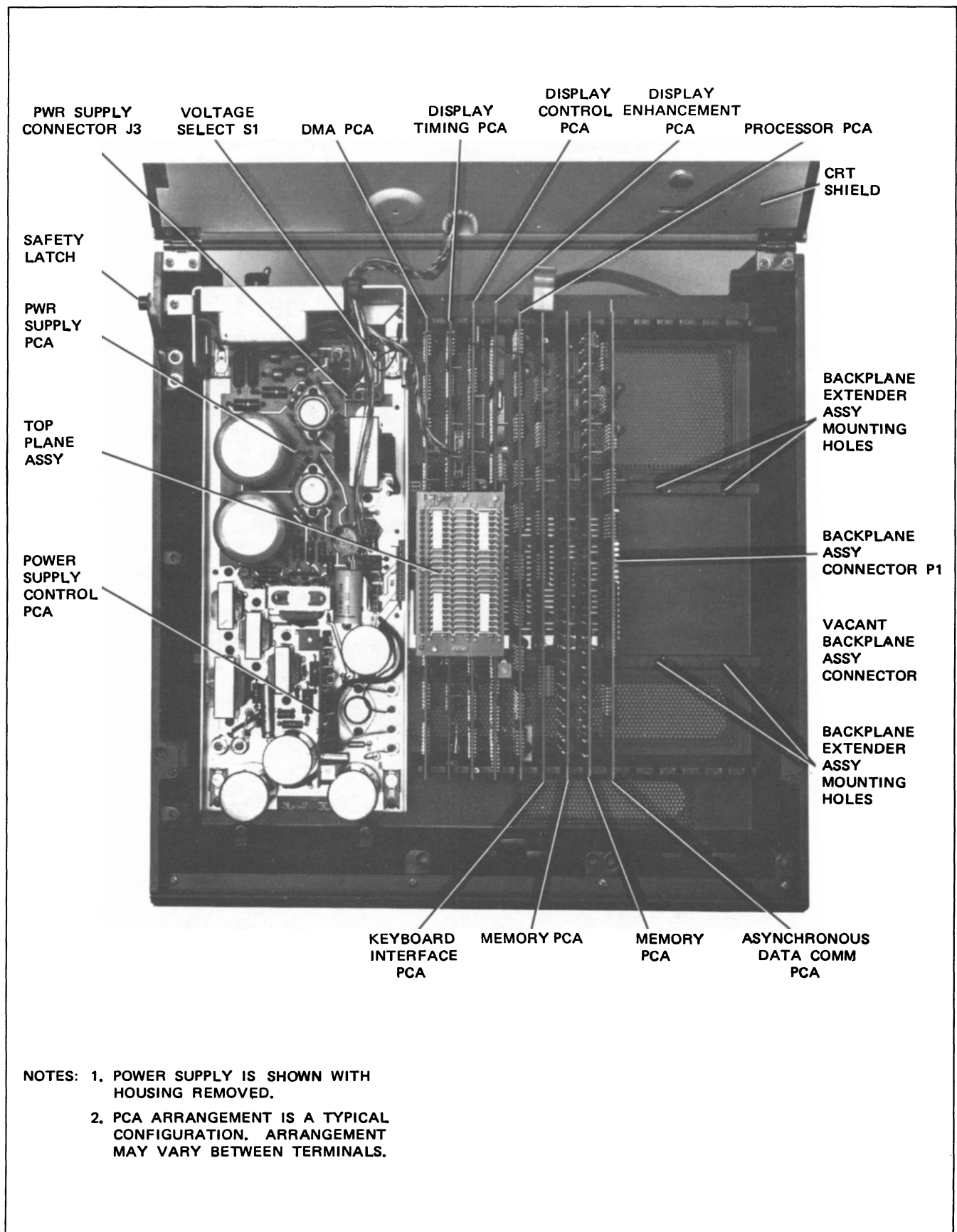

Figure 7-2. Mainframe Bottom Parts Locations (Sheet 2 of 2)

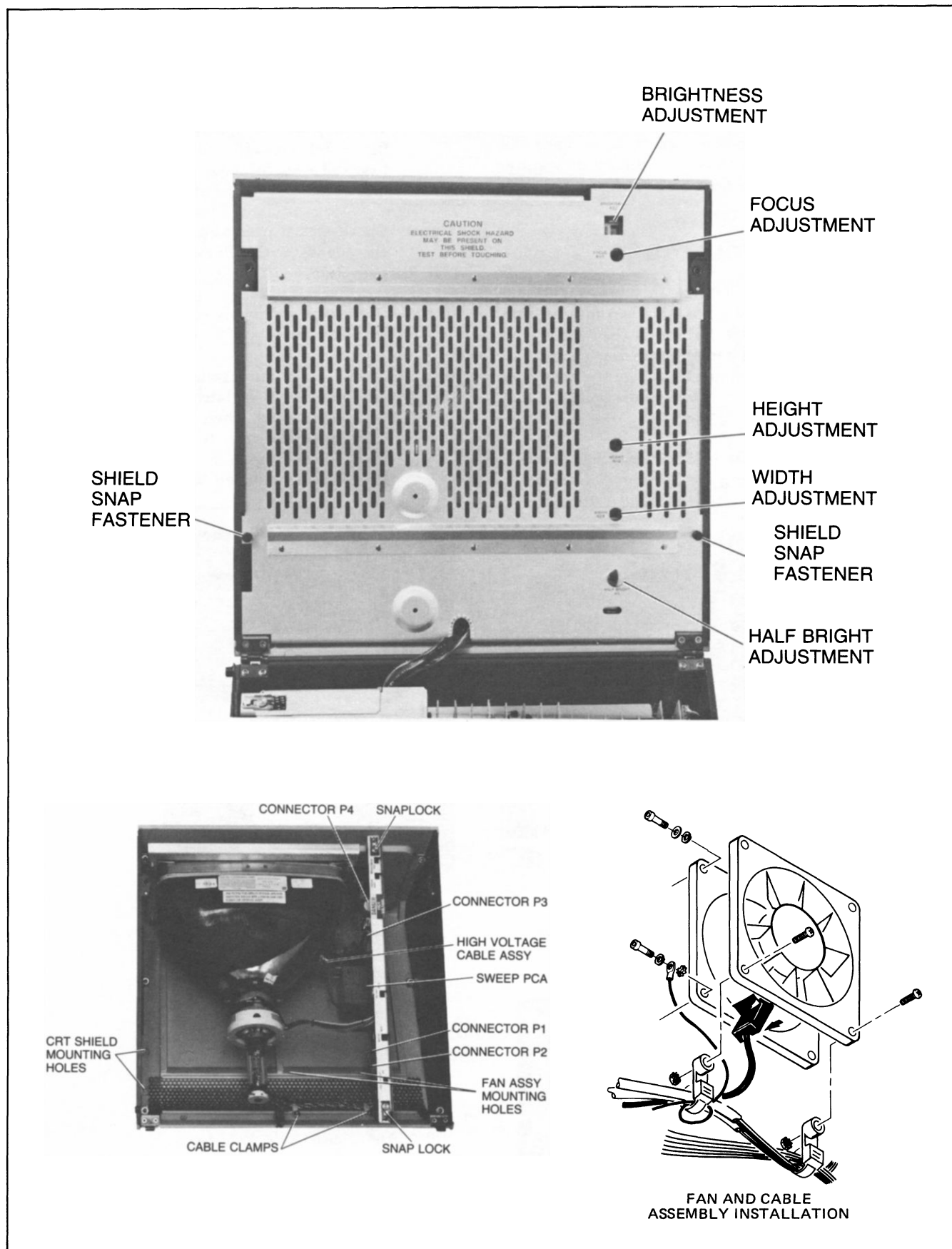

Figure 7-3. Mainframe Top Part Locations

GROUNDING REQUIREMENTS

To protect operating personnel, the National Electrical Manufacturers' Association (NEMA) recommends that the terminal's frame be grounded. The terminal is equipped with a three-conductor power cable which, when connected to an appropriate power receptacle, grounds the frame of the terminal. To preserve this protection feature, do not operate the terminal from an ac power outlet with no ground connection.

SELECTING LINE VOLTAGE

The terminal can be operated from either 115 or 230V, 60 Hz line voltage (230V, 50 Hz optional). When shipped from the factory, the line voltage for which the terminal is configured is stamped on the mainframe rear panel identification label. If it is necessary to change the operating line voltage, ensure that power cord is disconnected and proceed as follows:

1. () Open terminal to its half open position in accordance with "Opening the Terminal" paragraph.

2. () Remove power supply cover by removing the screw at the front of the cover and pulling the cover up and out of the mainframe.
3. () Select the operating voltage by inserting the proper fuses into the appropriate locations shown in figure 7-4. For 115 volts, use a 0.5A, SB, 250V fuse and a 4A, SB, 250V fuse. For 230 volts, use a 0.25A, SB, 250V fuse and a 2A, SB, 250V fuse.
4. () Check and, if necessary, adjust power supply in accordance with "Power Supply Adjustment", page 7-16.
5. () Replace power supply cover, and secure in place with the screw.
6. () Firmly grasp mainframe top cover in one hand and release safety latch by pressing it inboard with other hand. Then, using both hands, carefully lower top cover to its closed position.
7. () Perform terminal self-test (refer to Self-Test).

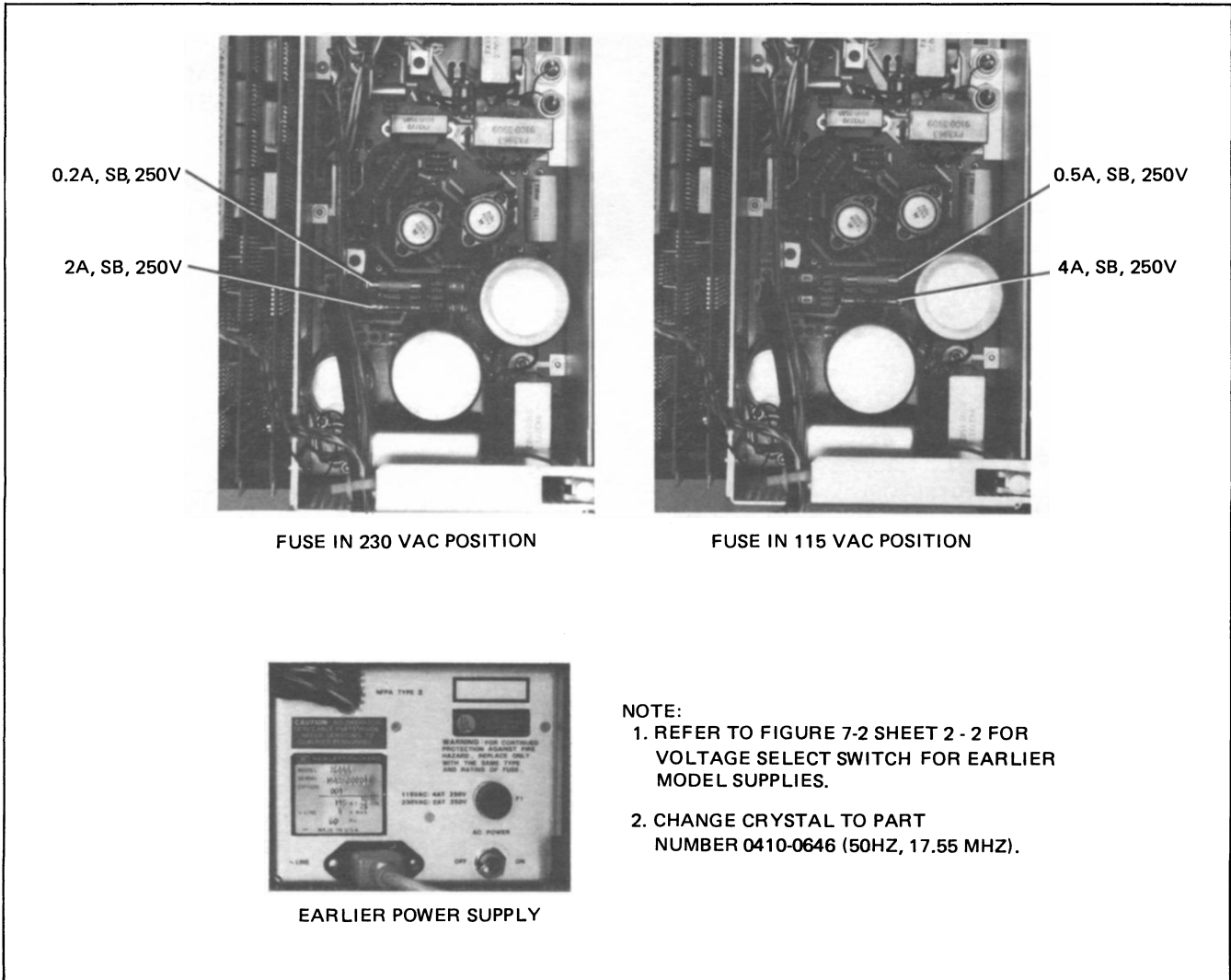

Figure 7-4. Fuse Positions for 115 VAC and 230 VAC Line Voltage

ACCESSORY INSTALLATION PROCEDURES

Instructions for installing add-on accessories to the standard model terminal are contained in the following paragraphs.

NOTE

After installing any accessory, always use the terminal self-test feature (page 7-43) to ensure proper operation.

64 CHARACTER LOWER CASE ROM

The 64 Character Lower Case ROM, part no. 1816-0613 (1816-0865 for the 2640S or 1816-0867 for the 2640N), is used to upgrade standard 64 character set terminals to 128 Roman characters. Do not confuse this with the alternate character sets described in "HP 13231A Display Enhancements" paragraph. Install the ROM as follows:

CAUTION

MOS integrated circuits can be damaged by electrostatic discharge. Use the following precautions:

DO NOT wear clothing subject to static charge buildup, such as wool or synthetic materials.

DO NOT handle MOS circuits in carpeted areas.

DO NOT remove the circuit from its conductive foam pad until you are ready to install it.

AVOID touching the circuit leads. Handle by the plastic package only.

INSURE that the circuit work surface (table, desk, etc.) and PCA are all at the same ground potential. This can be done by touching the foam pad to the PCA and then touch the foam pad, circuit, and PCA to the work surface.

1. () Open terminal to its half open position (refer to page 7-2).
2. () Insert connector removal tool under Top Plane Assembly as shown in figure 7-7 and remove Top Plane Assembly by pressing down on connector removal tool handle.
3. () Locate and remove Display Control PCA from Backplane Assembly.
4. () Using figure 7-5 as a guide, locate the 128 CH jumper W1 position and solder in a jumper. (If the board uses a jumper socket or switch, insert a jumper or make the proper setting.)
5. () Locate the vacant lower case ROM socket XU28.
6. () Carefully insert 64 Characters Lower Case ROM in socket XU28 so that ROM pin 1 is at upper right corner of XU28.
7. () Reinstall Display Control PCA in Backplane Assembly connector from which it was removed.
8. () Reinstall Top Plane Assembly on DMA, Display Timing, and Display Control PCA's top connectors.
9. () Firmly grasp top cover in one hand and release safety latch by pressing it inboard with other hand. Then, using both hands, carefully lower top cover to its closed position.

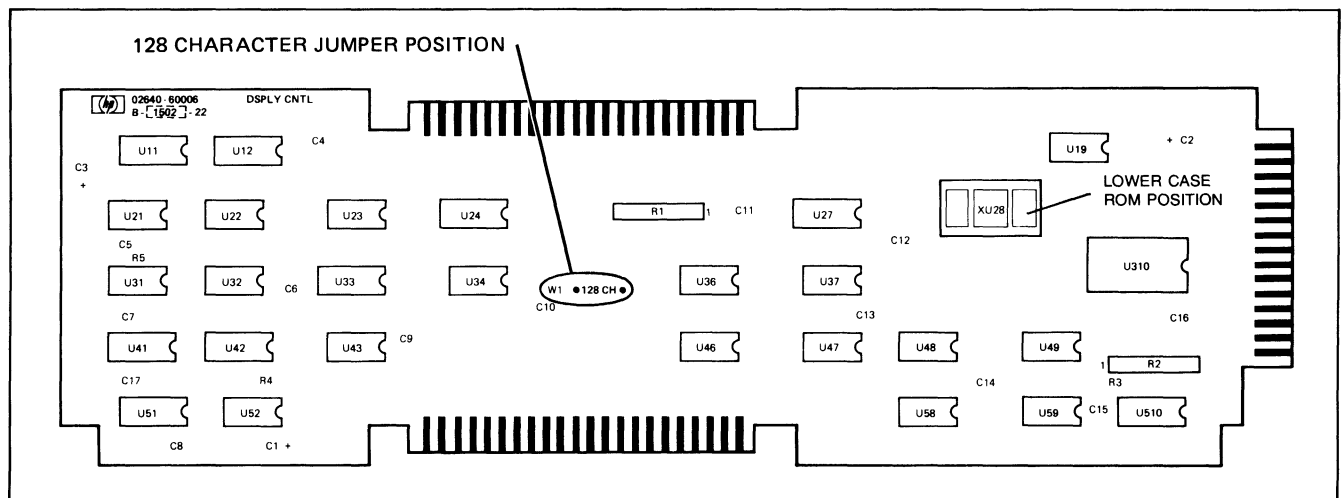

Figure 7-5. Display Control PCA Component Locations

HP 13231A DISPLAY ENHANCEMENTS

These instructions apply to the HP 13231A-201, HP 13231A-202 and HP 13231A-203 accessories as well as the HP 13231A accessory. The HP 13231A accessory consists of a Display Expansion PCA, part no. 02640-60024; a Top Plane Connector Assembly, part no. 02640-60022; and a Connector Removal Tool, part no. 02640-00029. The HP 13231A-201, -202 and -203 accessories consist of the same three items with the applicable ROM IC's mounted on the Display Expansion PCA. Install any of these accessories as follows:

The alternate character sets are configured with jumpers located on the upper right corner of the Display Enhancement PCA. There are six jumpers, two for each of the three possible alternate character sets. Jumpers 1 and 2 are for alternate character set 1 (referred to as set A in the User's Manual), jumpers 3 and 4 are for alternate character set 2 (set B in the User's Manual), jumpers 5 and 6 are for alternate character set 3 (set C in the User's Manual).

The first jumper for each set (jumpers 1, 3, and 5) indicates whether the set is composed of 128 (jumper in) or 64 (jumper out) characters. The second jumper for each set (jumpers 2, 4, and 6) indicates whether the character set data is in alphanumeric (jumper in) or microvector (jumper out) format. A detailed description of data formats for alternate character sets is given in the application note: *2640 Series Character Set Generation* (part number 13245-90001).

When using the three standard alternate character sets (Math Set, Line Set and Large Character Set) the jumpers would normally be configured as follows:

Math Set (placed in the first socket of set 1)

Jumper 1 = Out, since only 64 characters are used.

Jumper 2 = In, since character data is in alphanumeric format.

Line Set (placed in the first socket of set 2)

Jumper 3 = Out, since only 64 characters are used.

Jumper 4 = Out, since character data is in microvector form.

Large Character Set (placed in the first select of set 3)

Jumper 5 = Out, since only 64 characters are used.

Jumper 6 = Out, since character data is in microvector form.

Note that the Math Set has been shown as alternate character set 1 (A in the User's Manual), the Line Set as alternate 2 (B in the User's Manual), and the Large Character Set as alternate 3 (C in the User's Manual). They could have been configured as any combination of the three possible alternate sets. There is no requirement that the sets be configured in any order.

NOTE

Do not confuse the 128/64 character jumpers for *alternate character sets* with the 128 character jumper for the *standard character set*.

EFFECT OF IMPROPER JUMPER PLACEMENT.

128 Characters Strapped for 64. When a 128 character set is used and is jumpered for 64 characters, only the first 64 characters in the set will be accessed. This will cause the "q" character for example to access the same display character as the "Q" character.

64 Characters Strapped for 128. Any attempt to access one of the lower case 64 characters ("a", "q", etc.) will result in a blank being displayed.

Alphanumeric Data Strapped as Microvector. Alphanumeric data strapped as microvector will normally result in characters that are skewed or fuzzy.

Microvector Data Strapped as Alphanumeric. Microvector data strapped as alphanumeric will display blanks for the microvector characters.

INSTALLATION PROCEDURE

- () Using figure 7-6 and table 7-1 as a guide, check that Display Expansion PCA jumpers are arranged correctly for the ROM character set configuration. If there are no alternate character set ROM's installed (HP 13231A), all jumpers should be in the jumper socket.
- () Open terminal to its half open position (refer to page 7-2).
- () Insert connector removal tool under Top Plane Assembly as shown in figure 7-7.
- () Remove Top Plane Assembly by pressing down on connector removal tool handle. Retain Top Plane Assembly for possible future use.
- () If necessary, rearrange PCA's in Backplane Assembly so that an unused connector is available for the Display Expansion PCA adjacent to the Display Memory Access (DMA), Display Control, and Display Timing PCA's.

NOTE

PCA arrangement can be in any configuration with the following exceptions. The Keyboard Interface PCA should be installed in one of the first three Backplane Assembly connectors closest to the power supply.

The Display Expansion, DMA, Display Control, and Display Timing PCA's must always be installed as a group in adjacent connectors. No Backplane Assembly connectors can be left vacant between any PCA's. In addition, the Processor PCA must be installed adjacent to the display PCA's described previously.

- 6. () Install Display Expansion PCA in Backplane Assembly connector.
- 7. () Install Top Plane Connector Assembly, part no. 02640-60022 on Display Expansion, DMA, Display Control, and Display Timing PCA connectors.

- 8. () Check and, if necessary, adjust power supply (refer to "Power Supply Adjustment").
- 9. () Depress TEST key and observe last line of test pattern for correct display enhancements. If enhancements are correct skip to step 11. If adjustment is necessary, perform step 10.
- 10. () Perform brightness, half bright, focus, and field adjustments in accordance with the *Service Manual*.
- 11. () Firmly grasp mainframe top cover in one hand and release safety latch by pressing it inboard with other hand. Then, using both hands, carefully lower top cover to its closed position.

HP 13232 CABLE ASSEMBLIES

The HP 13232 cable assemblies provide interface connections between the terminal and modems, printers, and computers. Table 7-2 lists the particulars of each cable.

Table 7-1. Display Expansion PCA Jumper Protocol

ALTERNATE SET	128/64 (JUMPER IN/JUMPER OUT) CHARACTERS	ALPHANUMERIC/MICROVECTOR (JUMPER IN/JUMPER OUT) CHARACTER DATA
A	JUMPER 1	JUMPER 2
B	JUMPER 3	JUMPER 4
C	JUMPER 5	JUMPER 6

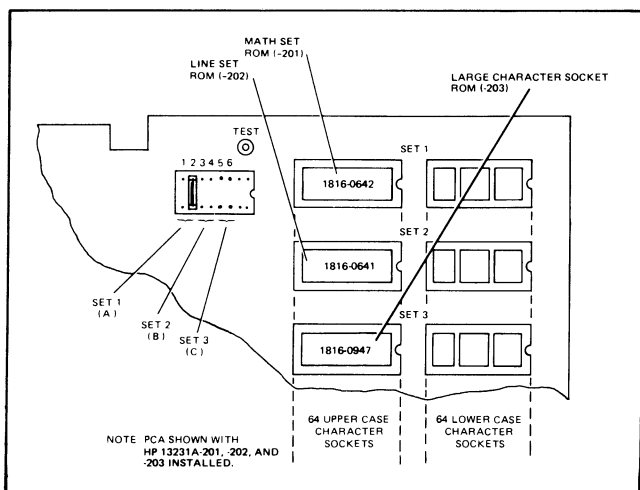

Figure 7-6. Display Expansion PCA Jumper and ROM Socket Locations

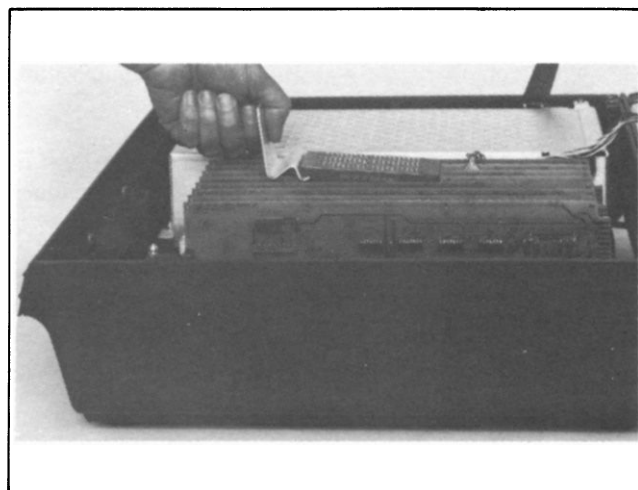

Figure 7-7. Top Plane Assembly Removal

Table 7-2. 13232 Cable Assemblies

CABLE	FUNCTION	CONNECTORS			LENGTH	HOOKUP
		A	B	C		
13232C	Connects data communications interface PCA to modem RS232C connector.	RS232C (female)	Hood	—	1.52 Metres 5 feet	
13232F	Provides current loop connections for 13250B data communications interface.	4 terminal lugs	Hood	—	1.52 Metres 5 feet	
13232G	Connects 13250B Serial Printer Interface PCA to RS232C compatible printers.	RS232C (male)	Hood	—	4.57 Metres 15 feet	
13232H	(same)	RS232C (female)	Hood	—	4.57 Metres 15 feet	
13232N	Connects data communications interface PCA to modem.	RS232C (male)	Hood	—	4.57 Metre 15 feet	
13232S	Connects 13238A Duplex Register PCA to 9866A/B Printer.	9866 printer (female)	Hood	—	1.83 Metres 6 feet	
13232U	Provides direct connection to a computer by replacing the modem connections.	RS232C (female)	RS232C (female)	—	1.52 Metres 5 feet	

HP 13234A (4K) TERMINAL MEMORY MODULE

Install the HP 13234A (4K) memory accessory as follows:

1. () Open terminal to its half open position (refer to page 7-2).
2. () Locate and insure that the Control Memory (1K) PCA, part no. 02640-60144, has all properly installed jumpers. (See figure 7-10.)
3. () Using figure 7-9 as a guide, locate memory jumpers on the 4K Memory PCA(s).
4. () Using figure 7-10 as a guide, arrange PCA starting address jumpers to select appropriate memory starting address for the size memory being configured.
5. () Install memory PCA's in any vacant Backplane Assembly connectors ensuring that no connectors are left vacant between any PCA's.
6. () Check and, if necessary, adjust power supply.
7. () Firmly grasp mainframe top cover in one hand and release safety latch by pressing it inboard with other hand. Then, using both hands, carefully lower top cover to its closed position.

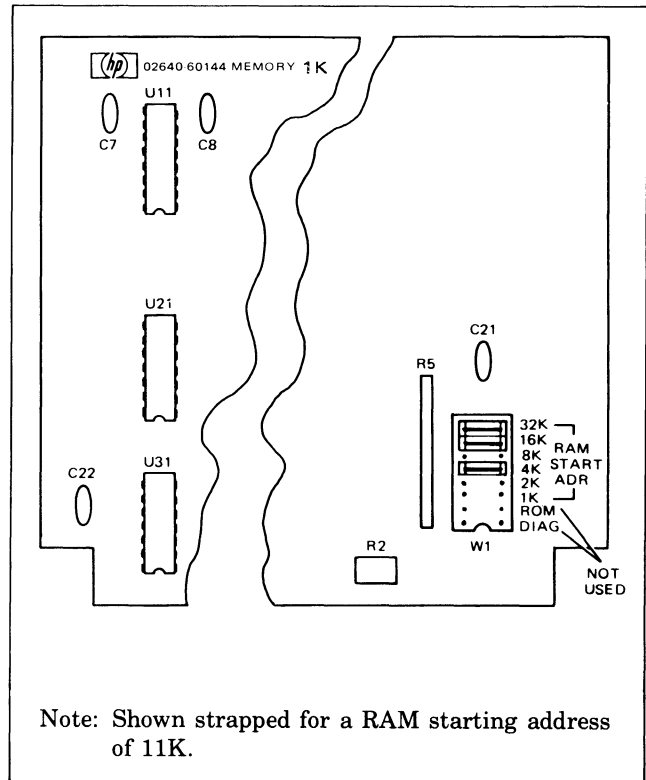

Figure 7-8. Control Memory PCA Jumper Socket Location

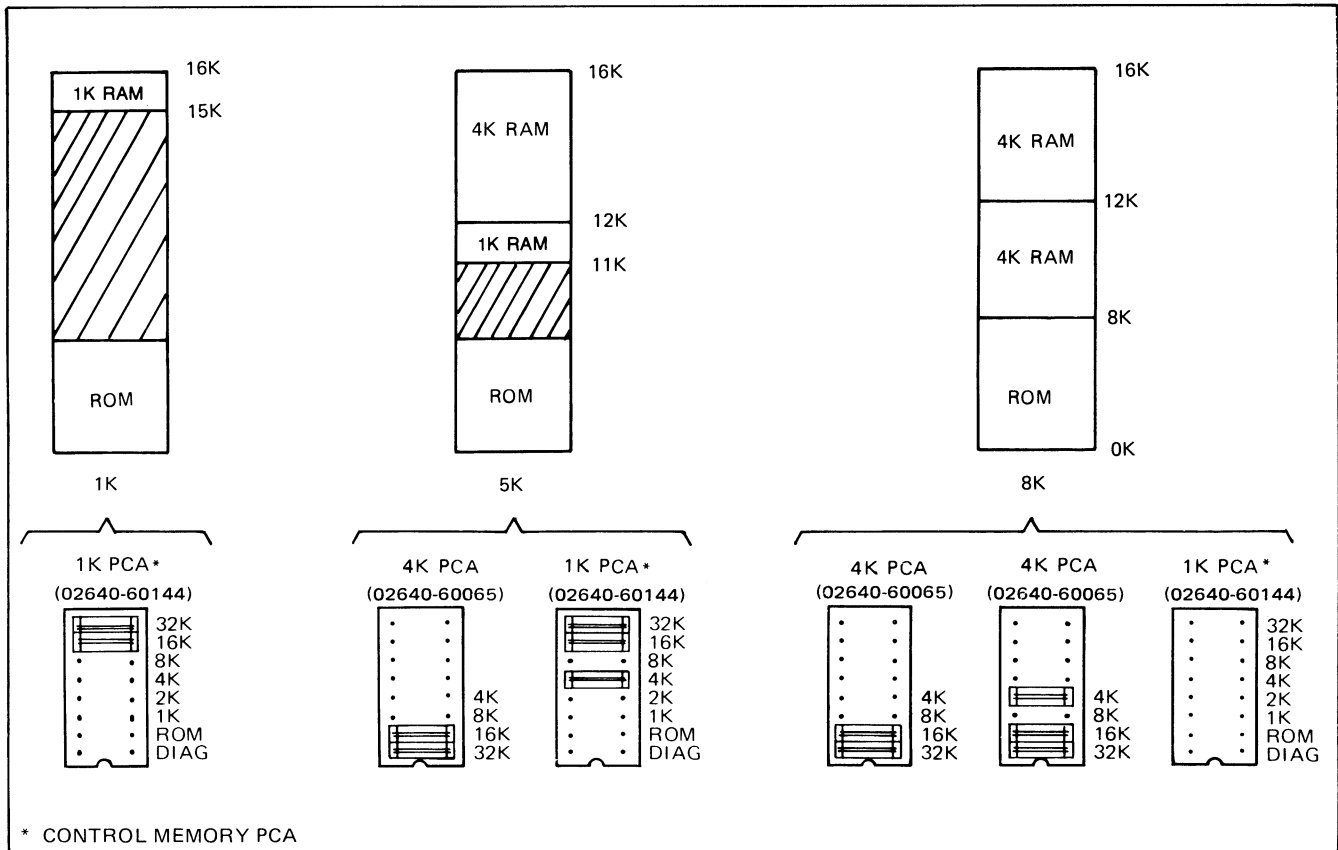

Figure 7-10. Memory Maps and Corresponding Memory Addressing Jumper Positions for 1K, 5K, and 8K

HP 13238A TERMINAL DUPLEX REGISTER

To install the HP 13238A accessory, perform all the following steps except steps 4 and 5. To install the HP 13238A accessory for an HP 13246A or 13349A Printer Subsystem, perform all the following steps.

1. () Open terminal to its half open position (refer to page 7-2).
2. () Configure jumpers in Terminal Duplex Register PCA jumper sockets as shown in figure 7-12.
3. () Install Terminal Duplex Register PCA in first vacant Backplane Assembly connector adjacent to existing PCA's.

NOTE

To ensure proper terminal operation, all PCA's must be installed in adjacent Backplane Assembly connectors.

4. () Open mainframe rear door by twisting two lock extrusions.
5. () Holding Terminal Duplex Register PCA firmly in place, carefully connect hood connector of the cable assembly, supplied with the printer subsystem, to PCA connector P2.

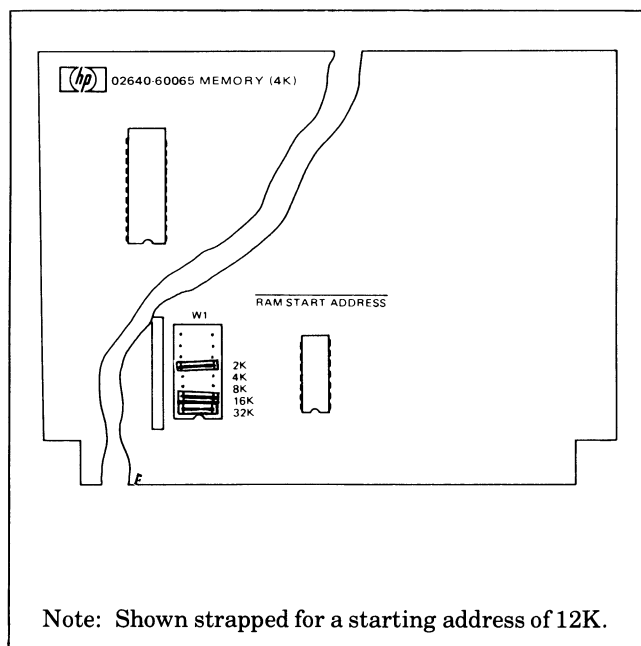

Figure 7-9. 4K Memory PCA Jumper Socket Location

NOTE

The hood connector and PCA connector P2 are identically keyed to prevent inadvertent erroneous connections. Connecting the two together requires minimal hand pressure. If excessive resistance is encountered, an incorrect connection is being attempted.

For printer interfacing information refer to the *HP 9866A/B Printer Operator's Manual*, part no. 09866-90901, or the *HP 13349A Printer Subsystem Operating Manual*, part no. 13349-90901.

- 6. () Check and, if necessary, adjust power supply.
- 7. () Firmly grasp mainframe top cover in one hand and release safety latch by pressing it inboard with other hand. Then, using both hands, carefully lower top cover to its closed position.

HP 13240A I/O EXTENDER INSTALLATION

The I/O extender accessory consists of a Backplane Extender Assembly, a Fan and Cable Assembly, and required attaching hardware. Installation of this accessory requires a set of Allen wrenches and a Phillips-head screwdriver. Install the accessory as follows:

- a. Open terminal to its full open position in accordance with "Opening The Terminal" on page 7-2.
- b. The CRT shield (see figure 7-3) is secured in place with snap fasteners. Remove CRT shield by pulling fasteners out of top cover mounting holes (see figure 7-3) and sliding toward the front of the CRT.
- c. Disconnect High Voltage Cable Assembly (see figure 7-3) from CRT.

- d. Disconnect Yoke Cable Assembly from Sweep Printed Circuit Assembly (PCA) connector P3 (see figure 7-3).
- e. Disconnect Sweep Cable Assembly from Sweep PCA connector P1 (see figure 7-3).
- f. Unlatch two snap locks (see figure 7-3), raise Sweep PCA from mainframe, disconnect CRT Cable Assembly from Sweep PCA connectors P2 and P4, and remove Sweep PCA.
- g. Remove two Phillips-head screws and lockwashers securing two cable clamps (see figure 7-3) and wire harness to mainframe top cover. Retain mounting hardware for installing the Fan Assembly. Do not remove cable clamps from wire harness. (Vacated cable clamp holes will be used to mount Fan Assembly.)
- h. Carefully connect connector J16 of Backplane Extender Assembly, part no. 02640-60002, to Backplane Assembly connector P1 (see figure 7-2, sheet 2).
- i. Visually align Backplane Extender Assembly mounting holes with the four mounting holes (see figure 7-2, sheet 2) in bottom of mainframe and secure in place with four lockwashers and four Phillips-head screws.

NOTE:

Fan and Cable Assembly must be mounted so that cables from fan are closest to back of top cover and CRT. Fan AIRFLOW arrow must point toward the back of the top cover.

- j. Visually align Fan Assembly mounting holes with the four mounting holes (see figure 7-3) in mainframe top cover.

NOTE:

Fan cable ground lug must be attached to one of the fan Allen-head mounting screws.

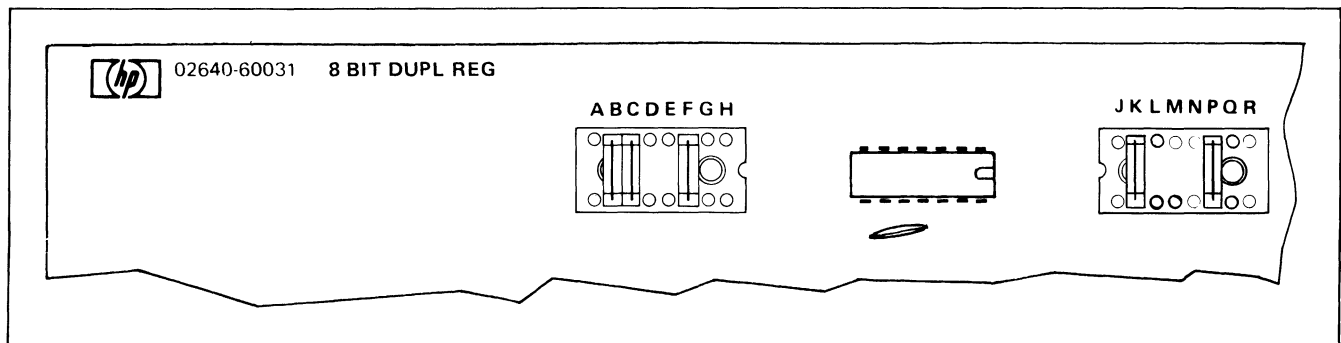

Figure 7-12. Terminal Duplex Register PCA Jumper Configuration

- k. Secure Fan in place with four lockwashers and four Allen-head screws.
- l. Remove power supply housing (bottom left side of mainframe) by unlatching the two snap locks on front of housing and pulling housing up and out toward front of mainframe.
- m. Connect Fan Cable connector to Power Supply PCA connector J3 (see figure 7-2, sheet 2) and route cables back to fan with existing wire harness. The cable should be placed inside the first (left) cable clamp along with the existing harness. See figure 7-3.
- n. Replace power supply housing and secure in place with the two snap locks.
- o. Using two Phillips-head screws, two lockwashers, and two nuts, secure two cable clamps and the wire harness to mounting holes in top of fan frame closest to back of mainframe.
- p. Connect CRT Cable Assembly to Sweep PCA connectors P2 and P4.
- q. Connect Yoke Cable Assembly to Sweep PCA connector P3.
- r. Connect Sweep Cable Assembly to Sweep PCA connector P1.
- s. Install Sweep PCA in mainframe top cover and secure in place with the two snap locks.
- t. Connect High Voltage Cable Assembly to CRT.
- u. Secure CRT shield in place by sliding the front of the shield over the CRT mounting bracket and pressing the snap fasteners into the mounting holes.
- v. Check and, if necessary, adjust power supply in accordance with "Power Supply Adjustment" on page 7-14.
- w. Firmly grasp mainframe top cover in both hands and carefully swing it up and over to its half open position assuring correct union of cover hinges.
- x. Firmly grasp top cover in one hand and release safety latch by pressing it inboard with other hand. Then using both hands, carefully lower top cover to its closed position.

HP 13245A CHARACTER SET GENERATION KIT

The Character Set Generation Kit Accessory consists of a PROM Character PCA, part no. 02640-60053 and a Connector Assembly, part no. 02640-60070. Install the HP

13245A accessory as follows:

- 1. () Open terminal to its half open position (refer to page 7-2).
- 2. () Rearrange PCA's in the Backplane Assembly so that an unused connector is available for the PROM Character PCA adjacent to either the Display Control PCA or Display Expansion PCA depending on the character set(s) to be replaced. If the base character set is to be replaced, vacate a connector adjacent to the Display Control PCA. If an alternate character set(s) is to be replaced, vacate a connector adjacent to the Display Expansion PCA.

NOTE

PCA arrangement can be in any configuration with the following exceptions. The Keyboard Interface PCA should always be installed in one of the first five Backplane Assembly connectors closest to the power supply. The Display Expansion, DMA, Display Control, and Display Timing PCAs must always be installed as a group in adjacent connectors to accommodate the Top Plane Connector Assembly.

- 3. () Install PROM Character PCA in vacated Backplane Assembly connector.

NOTE

The base or alternate character set ROM(s) to be replaced by the user generated PROM set(s) must be removed from the applicable PCA in accordance with the instructions contained in the *Character Set Generation Kit Application Note*, part no. 13245-90001.

- 4. () When connected to the Display Expansion PCA, the PROM Character PCA character sets 1 and 2 replace the Display Expansion PCA character sets 1 and 2 respectively. If an alternate set(s) is to be replaced, first determine if the user generated PROM set(s) is alphanumeric or microvector. Then, using table 7-1 and figure 7-6 as a guide, correctly arrange Display Expansion PCA jumpers 2 and 4 for the PROM character set type(s). (Jumpers 1 and 3 can either be removed or left installed.)
- 5. () Attach Connector Assembly, part no. 02640-60070 between the two interface connectors (P2) on the PROM Character PCA and Display Control PCA or Display Expansion PCA.
- 6. () Check and, if necessary, adjust power supply.

7. () Firmly grasp mainframe top cover in one hand and release safety latch by pressing it inboard with other hand. Then, using both hands, carefully lower top cover to its closed position.

HP 13246A/B PRINTER SUBSYSTEM (9866)

This accessory consists of a Terminal Duplex Register PCA, part no. 02640-60031; a 13232S Cable Assembly, part no. 02640-60135; and an HP 9866A or B Printer. To install this accessory, first perform the HP 13238A Terminal Duplex Register installation instructions steps 1 through 7. After the PCA and cable assembly have been installed, install the printer in accordance with the instructions contained in the *HP 9866A/B Printer Operator's Manual*, part no. 09866-90901.

HP 13250B SERIAL PRINTER INTERFACE

The HP 13250B provides an RS232 interface to serial printers. You can configure the 13250B to be compatible with any RS232 serial printer requiring handshake or fill-character protocol. For details on configuring and installing the interface, refer to the HP 13250B accessory manual, part no. 02640-90042.

DATA COMMUNICATIONS ACCESSORIES

The Data Communications Accessories provide various types of data communications. (Refer to section 5 for details of these accessories.) Only one data communications interface may be installed in the terminal at any time.

CAUTION

MOS integrated circuits can be damaged by electrostatic discharge. Use the following precautions:

DO NOT wear clothing subject to static charge buildup, such as wool or synthetic materials.

DO NOT handle MOS circuits in carpeted areas.

DO NOT remove the circuit from its conductive foam pad until you are ready to install it.

AVOID touching the circuit leads. Handle by the plastic package only.

INSURE that the circuit, work surface (table, desk, etc.) and PCA are all at the same ground potential. This can be done by touching the foam pad to the PCA and then touch the foam pad, circuit, and PCA to the work surface.

1. () Perform complete terminal SELF TEST to verify proper terminal operation before installing the accessory.
2. () Turn off ~ LINE switch at rear of terminal and disconnect power cord.
3. () Open terminal as described on page 7-2.
4. () Configure the interface PCAs for your particular application by setting the switches on the PCA. (Refer to Selecting Optional Operating Functions.)
5. () Install the Interface PCA in the first vacant backplane assembly connector adjacent to existing PCA's.

NOTE

To ensure proper terminal operation, all PCA's must be installed in adjacent Backplane Assembly connectors.

6. () Open mainframe rear door by twisting the two lock extrusions.
7. () Holding the communications interface PCA firmly in place, carefully connect hood connector of a 13232C, F, or N Cable Assembly to PCA. (Refer to Data Communications Cabling.)

NOTE

The hood connector and PCA connector P2 are identically keyed to prevent inadvertent erroneous connections. Connecting the two together requires minimal hand pressure. If excessive resistance is encountered, an incorrect connection is being attempted.

HP 13349A PRINTER SUBSYSTEM (9871)

This accessory consists of a Terminal Duplex Register PCA, part no. 02640-60031; an Interface Cable Assembly, part no. 02640-60116; and an HP 9871A Printer. To install this accessory, first perform the HP 13238A Terminal Duplex Register installation instructions steps 1 through 7. After the PCA and cable assembly have been installed, install the printer in accordance with the instructions contained in the *HP 13349A Printer Subsystem Operating Manual*, part no. 13349-90901.

POWER SUPPLY ADJUSTMENT

After installing or removing accessories, you should adjust the +5 volt output of the terminal's power supply. Only this voltage need be adjusted because the +5 volts provides reference for the other supply voltages. The adjustment requires a 20,000 ohms/volt voltmeter.

To adjust the +5V, proceed as follows:

1. () Open the terminal (refer to page 7-2).
2. () Connect multimeter between red test jack near the front of Display Timing PCA, part no. 02640-60088, and chassis ground.
3. () Set rear panel ~ LINE switch to ON.
4. () Adjust +5 volt potentiometer through access hole in power supply cover until voltmeter reads +4.95 volts.
5. () Set rear panel ~ LINE switch to OFF, disconnect multimeter, and close terminal.

SELECTING OPTIONAL OPERATING FUNCTIONS

The terminal is equipped with jumper and switch selectable options that can be used to alter some of its operating functions (see figure 7-13). These options and their effects on terminal operation are discussed in tables 7-3 and 7-4. To select an operating function, proceed as follows:

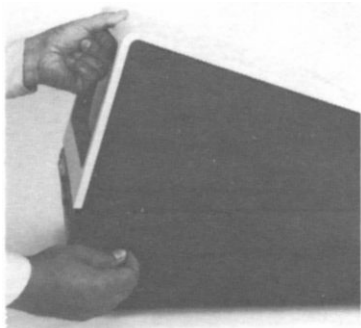

1. () Open the terminal to its half open position (refer to page 7-2).



2. () Locate the particular PCA, and remove the cable hood connector from the PCA. Then, remove the PCA from the Backplane Assembly connector.

3. () Using figure 7-14 or 7-15 (as applicable) and table 7-3 or 7-4 (as applicable), select the desired operating functions, and set the switches to the appropriate positions. (More information on configuration is given in section V.)

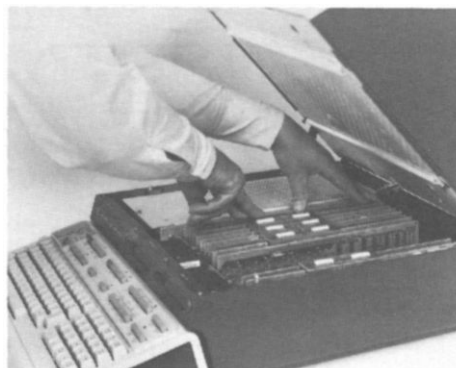

4. () Reinstall the PCA into the vacated Backplane Assembly connector.



5. () Firmly grasp mainframe top cover in one hand and release safety latch by pressing it inboard with your other hand. Then, using both hands, carefully lower top cover to its closed position.



6. () Perform SELF TEST.

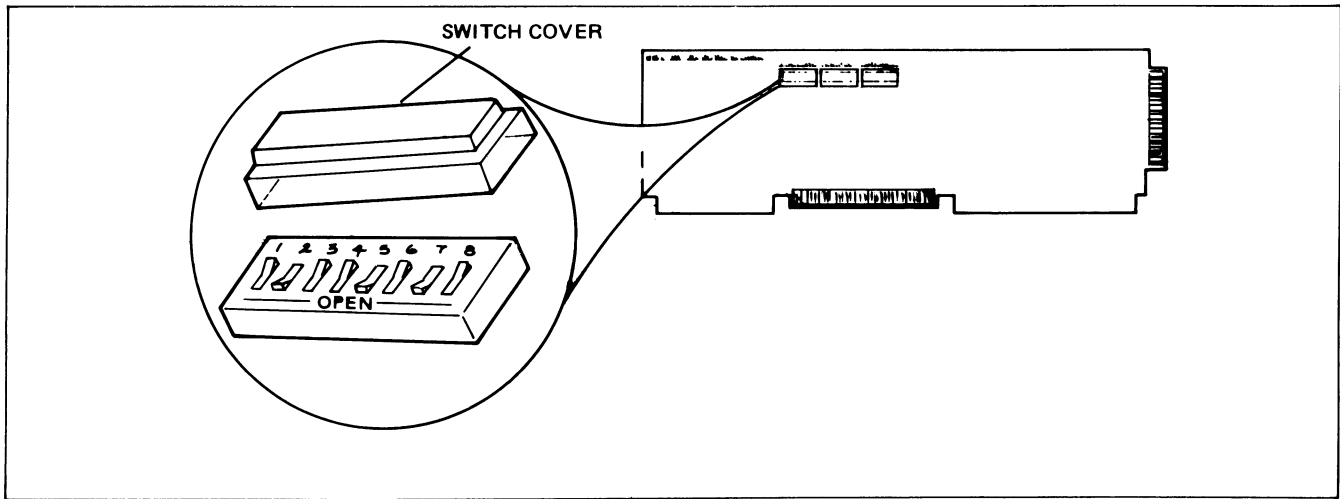

Figure 7-13. Typical Strapping Option Switch Assembly

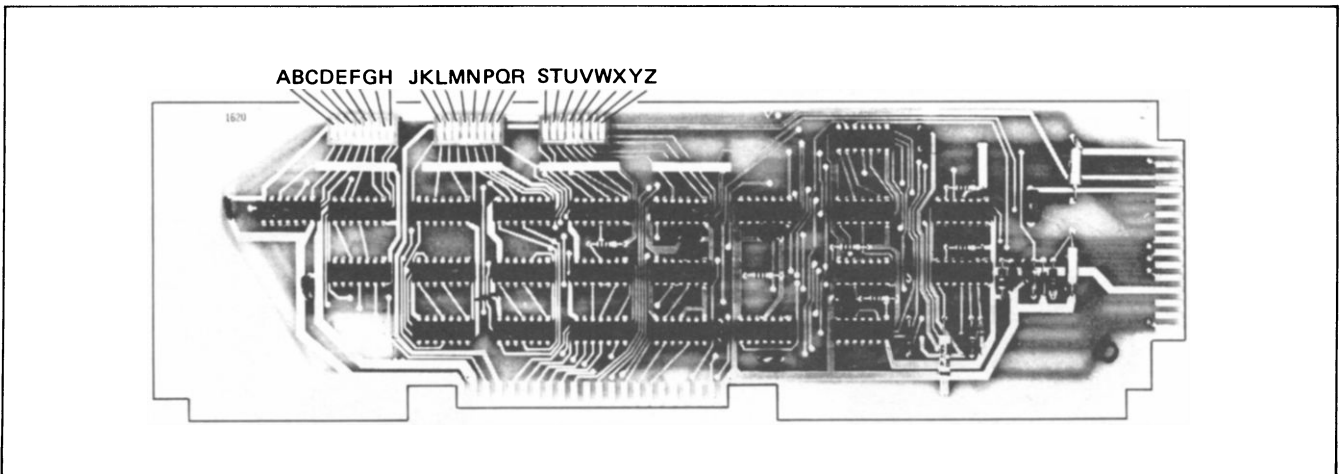

Figure 7-14. Keyboard Interface PCA Strapping Options

Table 7-3. Keyboard Interface PCA Strapping

SWITCH	OPTION	NORMAL OPERATION (SWITCH CLOSED)	OPERATION WITH SWITCH OPEN
A	Function Key Transmission	The escape code sequence generated by the major function keys (such as, ROLL UP, ROLL DOWN, etc.) are executed locally, but not transmitted to the computer.	The escape code sequences generated by all keys are transmitted to the computer. If operating in half duplex, the function is also executed locally.
B	Space Overwrite (SPOW) Latch Enable	Spaces typed will overwrite existing characters.	When the SPOW latch is off, overwriting occurs as normal. When the SPOW latch is on, spaces cause the cursor to forward but not overwrite any existing characters. The SPOW latch is turned on by a Carriage Return, and off by a Line Feed, Home or Tab.

Table 7-3. Keyboard Interface PCA Strapping (Continued)

SWITCH	OPTION	NORMAL OPERATION (SWITCH CLOSED)	OPERATION WITH SWITCH OPEN
C	Cursor End-of-Line Wrap Around	At the end of each line, a local Carriage Return and Line Feed are generated; the cursor moves to the beginning of the next line.	A Carriage Return and Line Feed are not generated at the end of each line. The cursor remains in and overwrites column 80.
D	Block Mode, Page	The terminal is set to transfer a line at a time in Block Mode.	Entire pages of information are transferred in Block Mode.
E	Reverse Sense of CNTL key.	The terminal sends escape code sequences for the F ₁ -F ₈ keys when they are pressed while holding the CNTL key down. If the CNTL key is not pressed, the functions printed below the keys are performed.	Operation is reversed. The functions printed below the keys are performed when the function keys are pressed while holding the CNTL key down. If the CNTL key is not pressed, the terminal sends the escape code sequences associated with the F ₁ -F ₈ keys.
F	2640/2644 Protocol Handshake	A DC2 character is sent when the ENTER key is pressed. If strapped for page (switch D) the terminal will also send a DC2 when the F ₁ -F ₈ keys are pressed. ESC E will not clear terminal memory.	The DC2 character is sent only in response to a DC1 character from the computer. ESC E will have the same effect as RESET TERMINAL.
G	Block Transfer Handshake	In Block Mode, all data transfers to the computer are sent upon receipt of a DC1 from the computer.	All Block Mode transfers (i.e., cursor sense, terminal and device status, display memory, and function keys) are preceded by a DC2. The terminal sends the DC2 upon receipt of a DC1 from the computer. After the CPU receives the DC2 from the terminal, another DC1 is required to trigger transmission of data from the terminal.
H	Inhibit DC2	During Block Mode Handshake transfers, the terminal sends a DC2 in response to a DC1 prior to sending data. (See Block Transfer Handshake strapping above.)	A DC1 from the computer is not required to trigger data transfers to the computer. Also, the DC2 from the terminal is not sent during Block Mode Transfer handshakes. (See Block Transfer Handshake strapping above.) Additionally, when the <input type="checkbox"/> key is pressed in Block Mode the cursor will be placed in the first column before transmission occurs if operating in Line/Field Mode (switch D closed) or Home'd if operating in Page Mode (switch D open.) Opening both switches G and H eliminate the terminal's use of the Handshake protocol entirely.
R	Circuit Assurance	The transition from receive state to transmit state occurs after both CB (106) (Clear to Send) and SB (122) (Secondary Receive Data) go on within 2.6 seconds. Otherwise, the terminal returns to the receive state.	The transition from receive state to transmit state occurs after CB (106) (Clear to Send) goes on.

Table 7-3. Keyboard Interface PCA Strapping (Continued)

SWITCH	OPTION	NORMAL OPERATION (SWITCH CLOSED)	OPERATION WITH SWITCH OPEN
S, T	Main Channel Protocol	Non-main channel protocol (both switches closed).	<p>S-closed, T-open: Main channel with STX/ETX as Start of Data and End of Data.</p> <p>S-open, T-closed: Main channel with EOT as End of Data.</p> <p>S-open, T-open: Main channel with ETX as End of Data.</p>
U	CPU Break	The CPU can interrupt the terminal while it is in the transmit state. The CPU initiates an ON to OFF transition of the SB (122) (Secondary Receive Data) line. The terminal responds by turning off CA (105) (Request to Send) and going to the receive state.	The terminal ignores all transitions on the SB (122) (Secondary Receive Data) line from the modem in the transmit state.
V	Carrier Detect	When the terminal is in the receive state, an ON to OFF transition of CF (109) (Carrier Detect) line from the modem causes the terminal to go into the transmit state. Transitions of CF have no effect while the terminal is in the transmit state.	Transitions of CF (109) (Carrier Detect) line have no effect on the terminal.
X	Data Speed Select	Holds data speed signal low (CH (111) = 0).	Sets data speed signal high (CH (111) = 1).
Y	Transmit LED	The TRANSMIT light on the keyboard is turned on when CB (106) (Clear to Send) line from the modem is high. It is turned off when the CB (106) line goes low.	The TRANSMIT light on the keyboard is turned on when the CC (107) (Data Set Ready) line from the modem is high and the 13250B Extended Asynchronous Communications Interface PCA is used. It is turned off when the CC line goes low.
Z	Parity	The PARITY switch on the terminal keyboard is affected as follows:	
		<p>No Parity: Send 8 bits and receive 8 bits. Force bit 8 to zero. Check for parity error.</p> <p>Odd Parity: Send 7 data bits + odd parity. Receive 7 data bits + odd parity. Check for parity error.</p> <p>Even Parity: Send 7 data bits + even parity. Receive 7 data bits + even parity. Check for parity error.</p>	<p>No Parity: Send 8 bits and receive 8 bits. Force bit 8 to one on send. No check for parity error.</p> <p>Odd Parity: Send 7 bits + odd parity. Receive 7 bits. No check for parity error.</p> <p>Even Parity: Send 7 data bits + even parity. Receive 7 data bits. No check for parity error.</p>

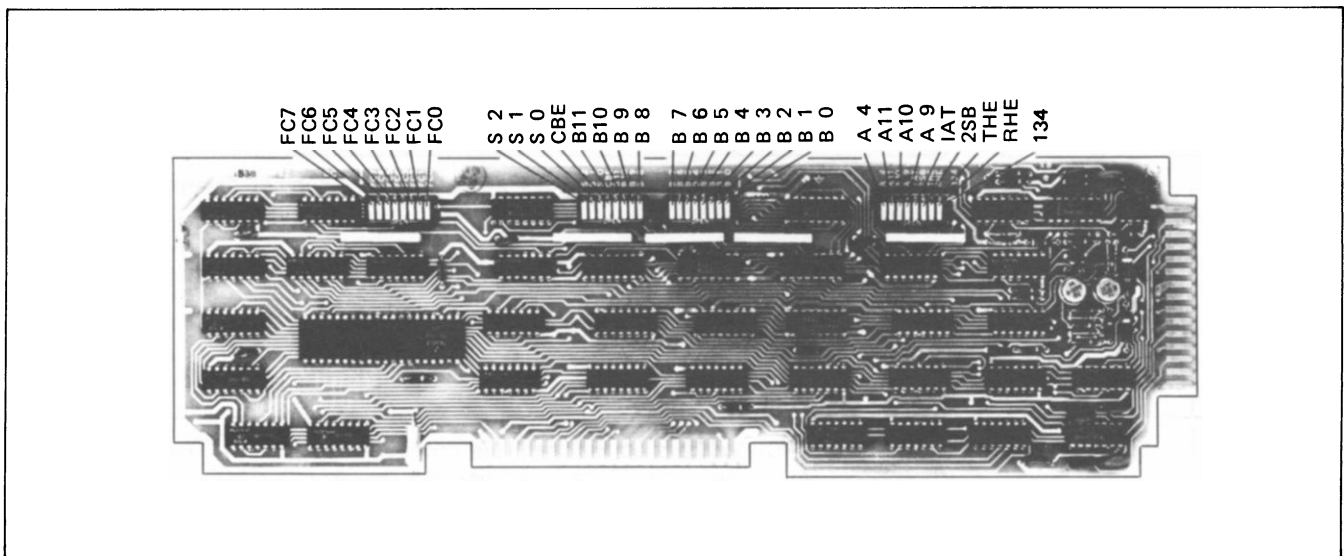

Figure 7-15. Extended Asynchronous Communications PCA Strapping Options

Table 7-4. 13250B Extended Asynchronous Communications Interface Strapping Options

STRAP	STRAPPING OPTION	DESCRIPTION		
FC0 thru FC7	(Not used)	(This switch should always be open.)		
S0 thru S2	Transmit Baud Rate	SWITCH SETTING		TRANSMIT BAUD RATE
		S0	S1	
		O	O	O
O	C	C	110	
C	O	C	150	
O	O	C	300	
C	C	O	1200	
O	C	O	2400	
C	C	C	Custom	
O = open, C = closed				
CBE	Custom Baud Rate Enable	<p>Closed: Enables custom receive baud rates. (The keyboard BAUD RATE switch must be set to EXT.)</p> <p>Open: Receive baud rate is set by keyboard BAUD RATE switch.</p>		

Table 7-4. 13250B Extended Asynchronous Communications Interface Strapping Options (Continued)

STRAP	STRAPPING OPTION	DESCRIPTION
B0 thru B11	Custom Baud Rate Select	The switches are set to the binary equivalent of a number determined by the formula $\text{INT}\left(\frac{153600}{\text{baud rate}}\right) - 1$ (See example in figure 5-10.)
A4, A9 thru A11	Module Address	Provides PCA address so that firmware can address the PCA. These switches should always be set to 10, (A4 — Open, A9 thru A11 — Closed.)
IAT	Inhibit Attention	(This switch must be closed when receive handshake is used.)
2SB	Stop Bit Select	Selects the number of stop bits to be appended to the data bits during transmission. Closed: Selects 2 stop bits Open: Selects 1 stop bit Note: Selecting 110 baud automatically appends 2 stop bits.
THE	Transmit Handshake Enable	Closed: Permits the associated external device (a or computer) to signal a “busy” condition on CB (Clear to Send) or SCF (Secondary Carrier) control lines and temporarily stop data transmission from the terminal. Open: Transmit Handshake disabled.
RHE	Receive Handshake Enable	Closed: Permits the terminal to signal a “busy” condition on the CD (Data Terminal Ready) control line and temporarily stop data transmission from the associated external device (a computer). Open: Receive Handshake Disabled.
134	134.5 Baud	(This switch should always be open.)
ATN 2	Enable Attention Two	(This switch should always be open.)
NOSB	SCF Inhibit	Closed: Inhibits RS232 SCF (Secondary Carrier) control line. Open: Enables RS232 SCF (Secondary Carrier) control lines.

Table 7-5. EIA RS232C and CCITT V24 Interface Data and Control Signals

CONNECTOR		CIRCUIT		DESCRIPTION	MODEM TO FROM	GND	DATA	CONTROL	TIMING
RS 232	P2 BASIC 13250B	RS 232	CCITT V24						
--	A	A	AA	Protective ground		X			
7	H	H	AB	Signal Ground/Common Return		X			
2	B	B	BA	Transmitted Data	X		X		
3	C	C	BB	Received Data			X		
4	D	D	CA	Request to Send	X			X	
5	E	E	CB	Clear to Send		X		X	
6	F	F	CC	Data Set Ready		X		X	
20	P	P	CD	Data Terminal Ready	X			X	
22	--	--	CE	Ring Indicator		X		X	
8	J	J	CF	Received Line Signal Detector		X		X	
--	--	--	CG	Signal Quality Detector		X		X	
23	--	R	CH	Data Rate Selector (DTE Source)	X			X	
--	--	--	CI	Data Rate Selector (DCE Source)		X		X	
24	--	--	DA	Transmitter Timing (DTE Source)	X				X
15	--	--	DB	Transmitter Timing (DCE Source)		X			X
17	--	--	DD	Receiver Timing		X			X
--	--	--	SBA	Secondary Transmitted Data	X		X		
--	--	--	SBB	Secondary Received Data		X	X		
19	M	M	SCA	Secondary Request to Send	X			X	
--	--	--	SCB	Secondary Clear to Send		X		X	
12	N	N	SCF	Secondary Received Line Detector		X		X	

DATA COMMUNICATIONS CABLING

Table 7-6. Data Communications Signal Levels

INTERFACE SIGNALS

The RS232 signals available on each of the communication interfaces are listed in table 7-5. This information can be used to verify interface capability or to fabricate special interface cables.

DATA:		
Name	Space	Mark
Logic	0	1
Voltage	>+3V but <+25V	<-3V but >-25V
CONTROL:	ON (true)	OFF (false)
CLOCK SIGNALS:	0 = ground	1 = +5V

LOGIC LEVELS

Table 7-6 gives the logic levels of signals used by the data communications accessories.

CABLE TYPES

There are five cable types that are available for use in multipoint networks. These cables are described in table 7-7.

Table 7-7. Parts for Fabricating Your Custom Data Communications Cable

ITEM	HP PART NUMBER	DESCRIPTION
RS232 Connector	5061-2405	(See figure 7-20.)
PCA Hood Connector	5061-1340	(See figure 7-19.)
PCA Hood to RS232 Connector Cable	8120-1903 or 8120-1930	26 AWG (or greater) Low Voltage Computer Cable.

Note: All connectors include contacts.

Table 7-8. Data Communications PCA Signal Names

P2 PIN	BASIC	SIGNAL NAMES 13250B
1	(no connection)	ENCL (see note)
2	(no connection)	INI
3	(no connection)	CL+ 12
4	(no connection)	CL+ (see note)
5	(no connection)	CL- (see note)
6	(no connection)	CLA (see note)
7	(no connection)	CLP
8	(no connection)	INO
9	(no connection)	PON
10	(no connection)	ISB
11	(no connection)	XECL
12	(no connection)	TTY IN
13	(no connection)	(no connection)
14	(no connection)	(no connection)
15	TEST	TEST
A	GND	GND
B	BA	BA
C	BB	BB
D	CA	CA
E	CB	CB
F	(no connection)	(CC)
H	GND	GND (see note)
J	CF	CF
K	X8OUT	X8OUT
L	X16OUT	X16OUT
M	SA	SA
N	SB	SB
P	CD	CD
R	(no connection)	(CH)
S	X16IN	X16IN

NOTE: Used in current loop mode.

COMMUNICATIONS CABLING

Figures 7-16, 7-17, and 7-18 show the cable connections and signals used by the data/communications accessories.

FABRICATING YOUR OWN DATA COMMUNICATIONS CABLE

PCA hood connectors, RS232C connectors, multipoint connectors, and cables are available should you need to fabricate your own data communications cable. Part numbers of the items are given below.

Figures 7-19 and 7-20 show the details of assembling each type of connector. Table 7-8 lists the interface signals on each of the data communications PCA's. Also, the illustrations of the HP cables (figures 7-16, 7-17, and 7-18) may be used as a guide.

There are maximum length limitations on each type of cable. The following may be used as a guide for length considerations.

Maximum Distances:

Modem/Computer to first terminal: 50 feet (RS232-C standard)

Modem/Computer to terminal: 1000 feet (current loop on 13250B)

SELF-TEST

The terminal tests itself. Should you suspect a malfunction while operating the terminal, you can perform the SELF-TEST function to checkout the terminal. Also, after installing any accessory, the terminal's self-test function should be performed to insure that the terminal is functioning properly.

Pressing checks out the terminal. The following is performed when the key is pressed (also see the flowchart in figure 7-22):

- The light-emitting diodes (indicators) on the keyboard are turned on briefly as an indication that the power supply and microprocessor board are functioning.
- A checksum test is done on the read-only memory (ROM). This verifies that the firmware is working properly. An error here causes a ROM TEST FAIL message to be displayed. (See flowchart, figure 7-22.)
- A checkerboard test is performed on the random access memory. An error here causes a RAM TEST FAIL message to be displayed. (See flowchart, figure 7-22.)

- The bell is beeped indicating success up to this point.
- The entire character set contained in the terminal is displayed.
- A line of characters, @ABCDEFGHIJKLMNO, is displayed. If the Display Enhancement option is installed, then Underline, Half-Bright, and Blinking will be displayed with Inverse Video in all of the

possible Display Enhancement combinations by this line of characters.

- The 6 bytes of status information are displayed. (See section VI "Status" for an explanation of the status bytes.)

Generally, if the terminal beeps and the display shows a pattern similar to those shown in figure 7-21 then the

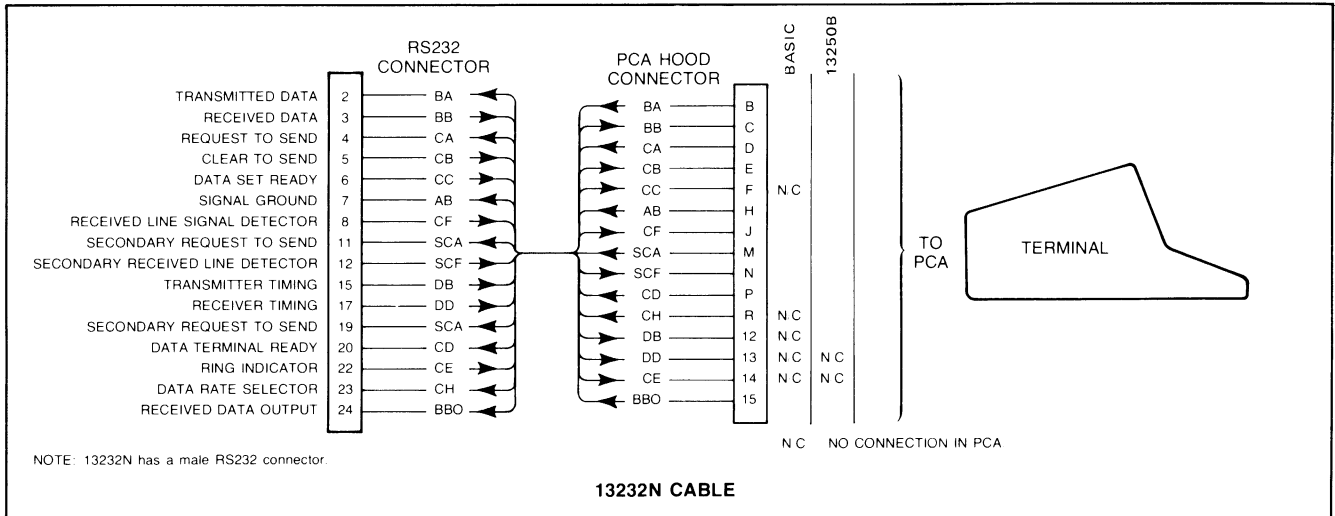

Figure 7-16. Standard Communications Cabling

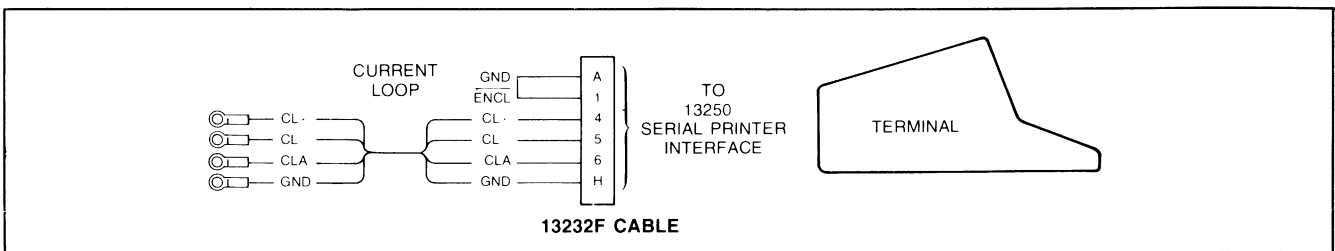

Figure 7-17. Current Loop Cabling

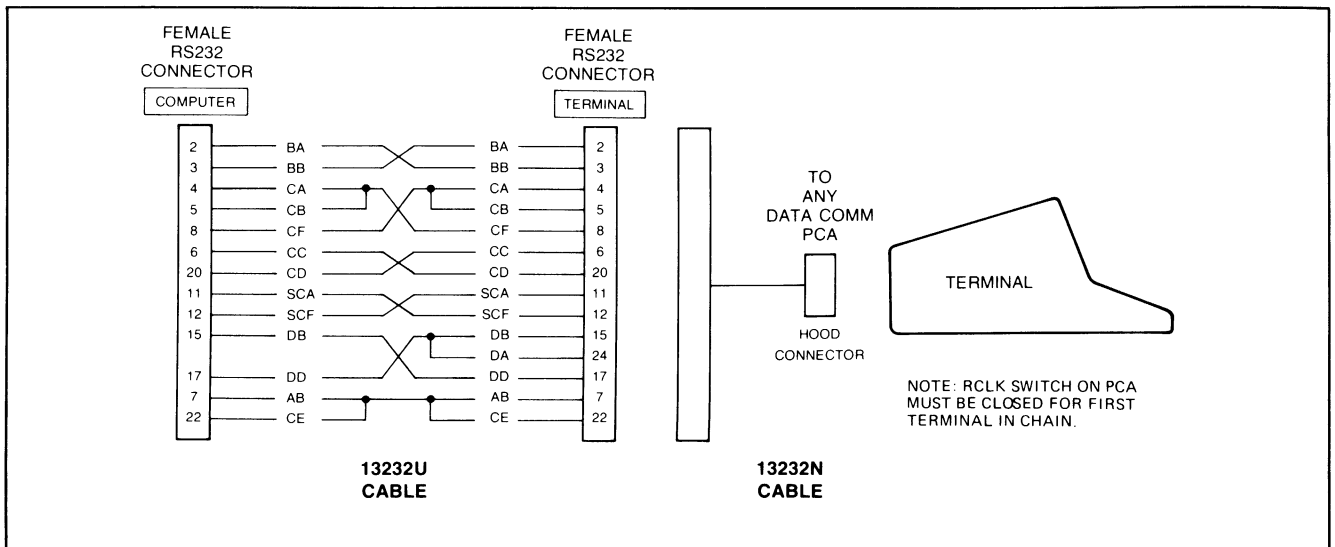
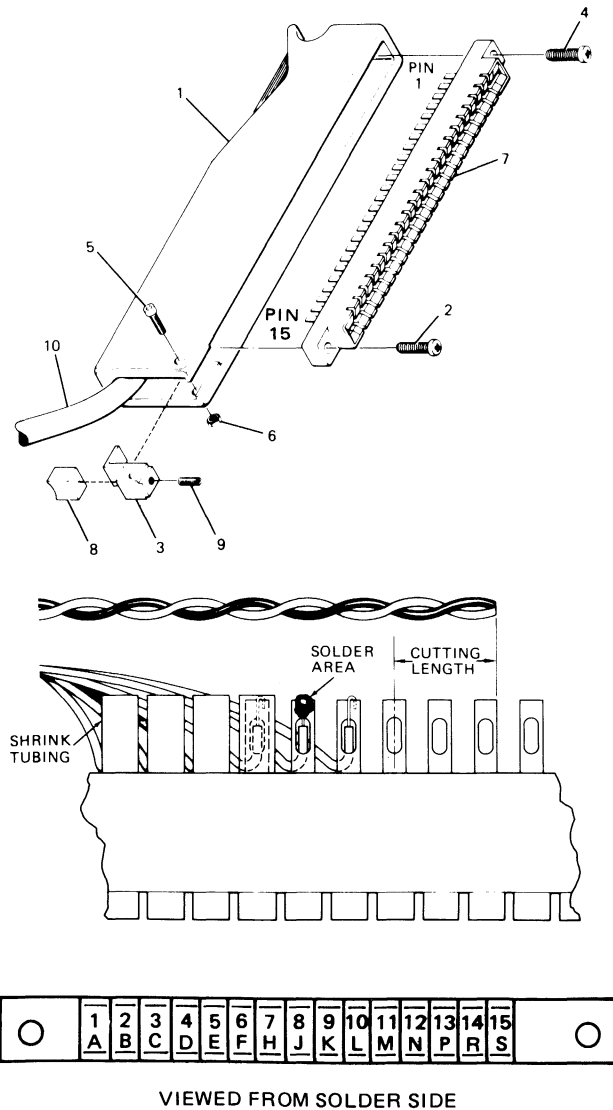

Figure 18. Modem By-Pass Cabling



Assembly Procedure:

1. () Insert approximately 10 inches of cable (item 10) into the connector hood (item 1).
2. () Strip the outer jacket of the cable back 5 inches.
3. () Remove approximately 1/4-inch of insulation from each signal wire.
4. () Starting at the end of the 30-pin connector (item 7) nearest pins S and 15, solder the signal wires to the appropriate pins on the connector, and insulate each pin with tubing as shown at left.
5. () Install the 30-pin connector in the connector hood using the two self-tapping screws (items 2 and 4).
6. () Install the cable clamp (items 3 and 8), and tighten it in place with the screw and nut (items 5 and 6).
7. () Tighten the cable clamp on the cable with the setscrew (item 9).

Figure 7-19. Assembling the PCA Hood Connector

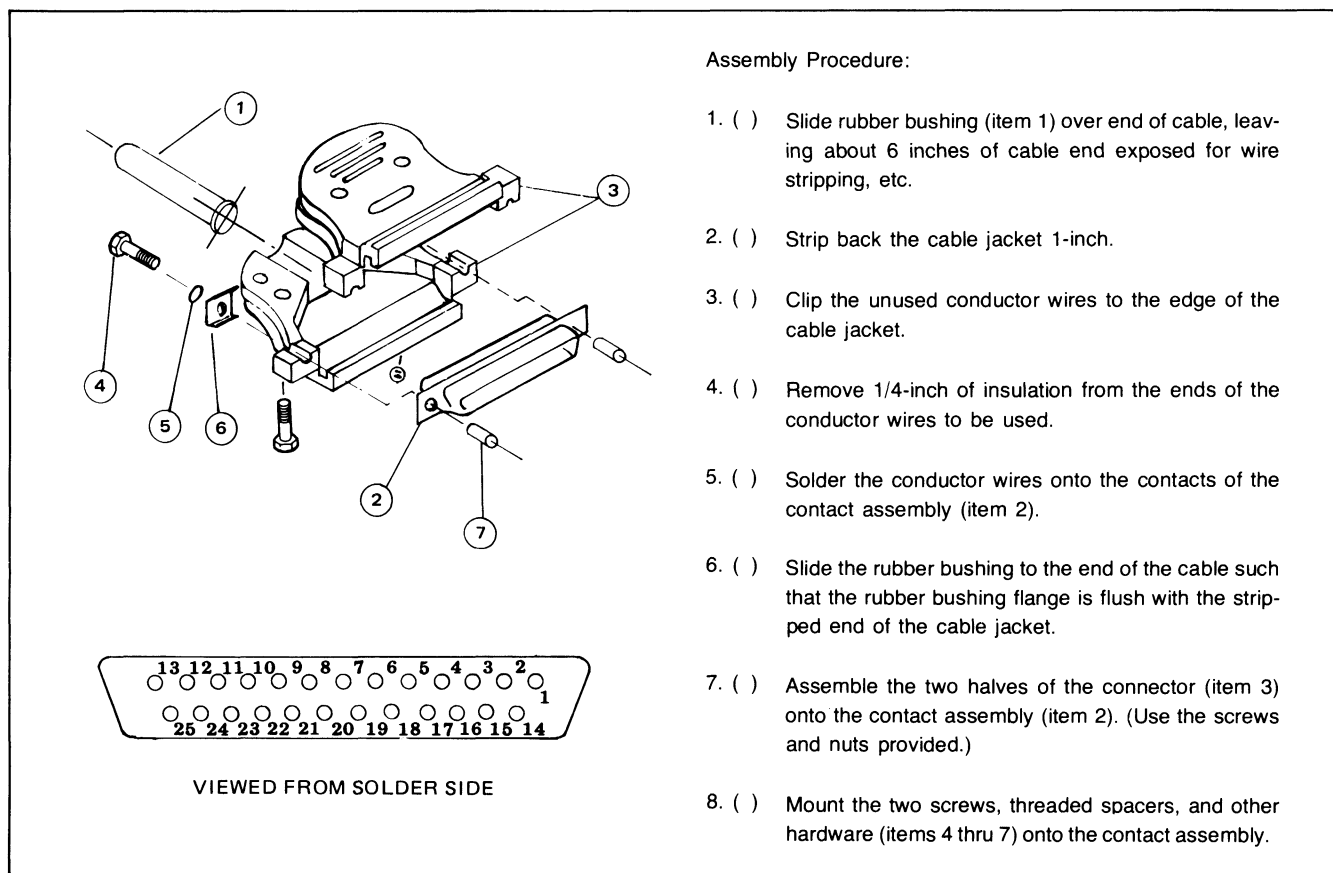

Figure 7-20. Assembling the RS232C Connector

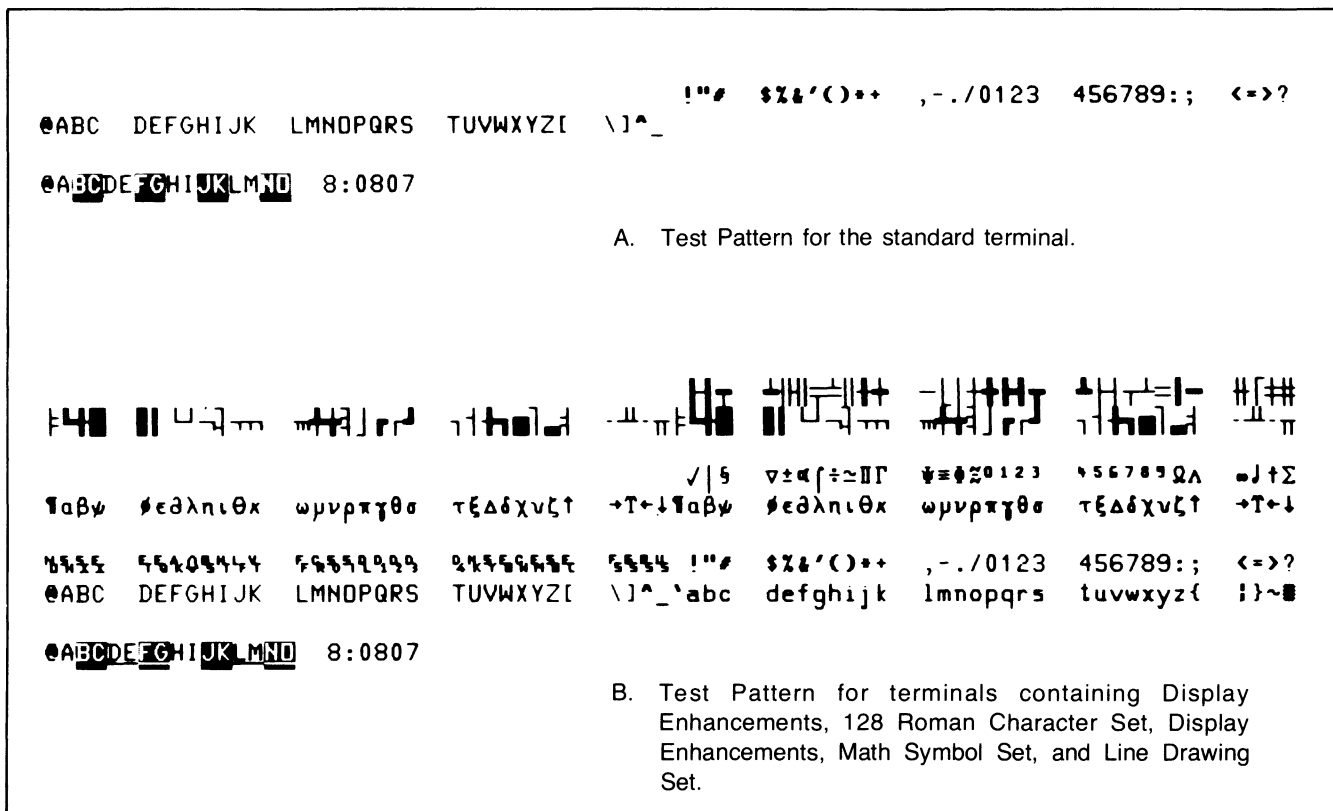

Figure 7-21. Self-Test Patterns

Installation

terminal is functioning properly (only those character sets actually present will be displayed in the test pattern and consequently the actual test pattern displayed will be dependent on which features are present in each terminal).



must be pressed to resume operation if any error occurred. However, the station's operation will not be reliable if the Self-Test failed.

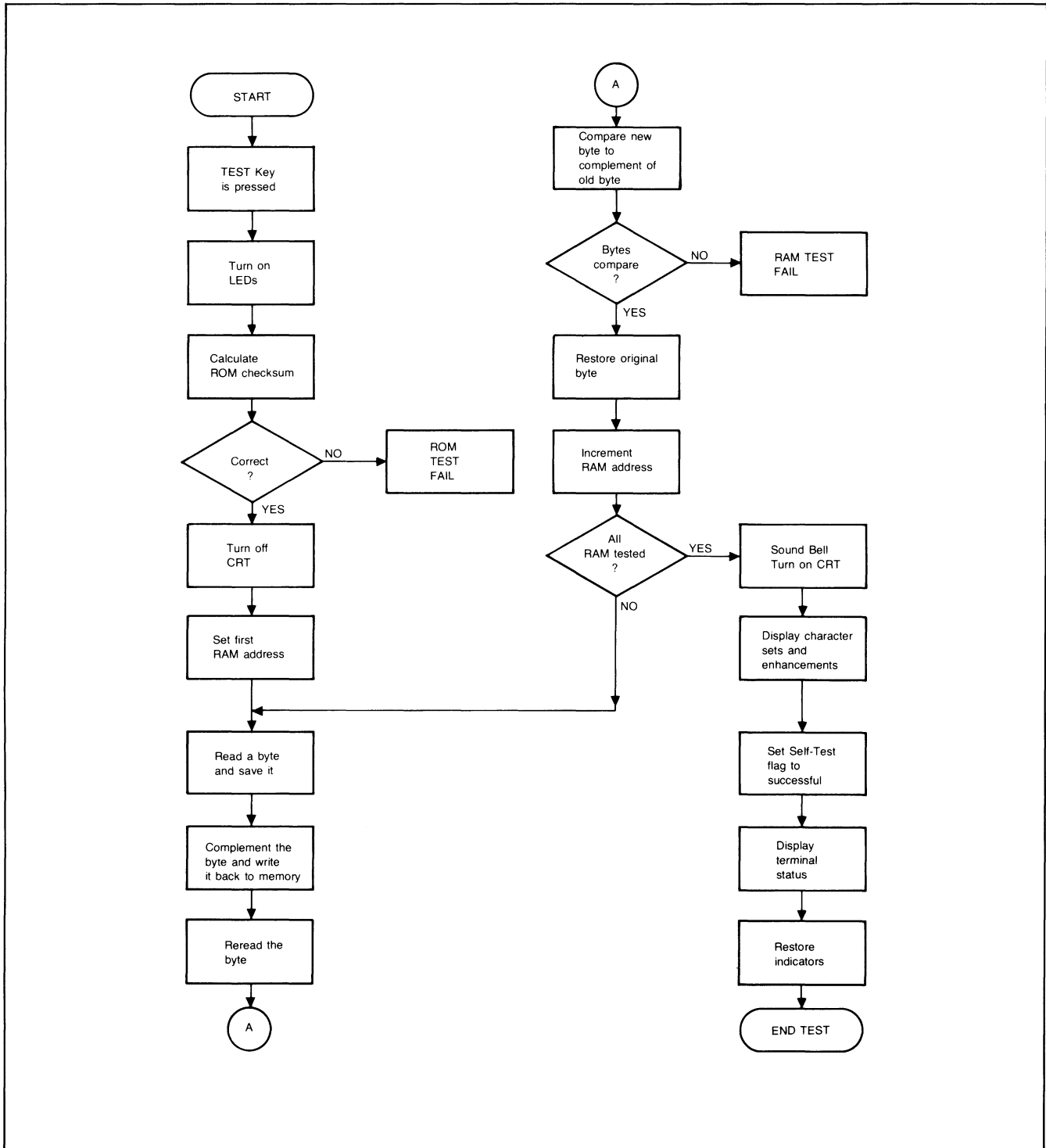

Figure 7-22. Self-Test Flowchart

Large Character Set Utility

Since using the Large Character Set requires using up to nine character codes for each large character, it is desirable to use a utility program. A sample utility program is given in figure A-1. The program is written in BASIC/3000 but can be adopted for use in other languages. The utility accepts an entire line or string of characters and generates the necessary codes to generate the entire line in Large Characters.

```

9000 REM SUBROUTINE TO PRINT STRING IN L1$ IN LARGE CHAR. SET
9010 REM USES VARIABLES L1$ THRU L4$, L1 THRU L3
9020 DIM L1$[26],L2$[11],L3$[128,9],L4$[1]
9030 IF UND(L1)=1 THEN DO
9040   PRINT CTL(208);'27"")C";
9050   L3$[33]=" 0 E E "
9060   L3$[34]=" ##   "
9070   L3$[35]="C&C0 0C&C"
9080   L3$[36]="!C+GC+GCL"
9090   L3$[37]="^ #3<DE ^"
9110   L3$[38]=" * & 4 "
9100   L3$[39]=" E   "
9120   L3$[40]="!& 0 G& "
9130   L3$[41]=" &+ 0 &L"
9140   L3$[42]=" ( K "
9150   L3$[43]=" C   "
9160   L3$[44]=" L   "
9170   L3$[45]=" &   "
9180   L3$[46]=" E   "
9190   L3$[47]=" #3<DE "
9200   L3$[48]="!&+0 0G&L"
9210   L3$[49]=" - 0 E "
9220   L3$[50]="!&+!&LF&,"
9230   L3$[51]="!&+ &OG&L"
9240   L3$[52]="# #F&C E"
9250   L3$[53]='34"&,F&+G&L"
9260   L3$[54]="!&+ /&+G&L"
9270   L3$[55]="%&. >D E "
9280   L3$[56]="!&+5&OG&L"
9290   L3$[57]="!&+G&?G&L"
9300   L3$[58]=" E E "
9310   L3$[59]=" E L "
9320   L3$[60]=" 3 2   "
9330   L3$[61]=" & & "
9340   L3$[62]=" ) D   "
9350   L3$[63]="!&+ >D V "
9360   L3$[65]="!&+ /&?E E"
9370   L3$[66]='34"&+ /&OF&L"
9380   L3$[67]="!&+0 G&L"
9390   L3$[68]='34"&+0 OF&L"

```

Figure A-1. Large Character Set Utility Routine (sheet 1 of 2)

```

9400 L3$[69]='34"&,&/& F&,"
9410 L3$[70]='34"&,&/& E  "
9420 L3$[71]="!&+0 .G&L"
9430 L3$[72]="# #/&?E E"
9440 L3$[73]=" ' 0 I  "
9450 L3$[74]=" # 0G&L"
9460 L3$[75]="# #/6AE E"
9470 L3$[76]="# 0 F&,"
9480 L3$[77]="$(-070E E"
9490 L3$[78]=")$#08BE E"
9500 L3$[79]='34"&.0 0F&M"
9510 L3$[80]='34"&+&/&LE  "
9520 L3$[81]="!&+0 0G&N"
9530 L3$[82]='34"&+&/&@E E"
9540 L3$[83]="!&+G&+G&L"
9550 L3$[84]="%' , 0 E  "
9560 L3$[85]="# #0 0G&L"
9570 L3$[86]="# #0 02JD"
9580 L3$[87]="# #090HKD"
9590 L3$[88]="# #1:AE E"
9600 L3$[89]="# #2;D E  "
9610 L3$[90]='34"&.3<DF&M"
9620 L3$[91]='34"& 0 F&  "
9630 L3$[93]=" &. 0 &M"
9640 L3$[95]="      &&&"
9650 DOEND
9660 FOR L1=1 TO LEN(L1$)
9670   L2=NUM(UPS$(L1$[L1,L1]))
9680   IF L3$[L2]="   " THEN PRINT CTL(208);'27"&a+3C";
9690   ELSE DO
9700     PRINT CTL(208);'14+L3$[L2,1,3]+'27"&a-3c+1R"+'14
       +L3$[L2,4,6]+'27"&a-3c+1R"+'14+L3$[L2,7,9]+'27"&a-2R";
9710   DOEND
9720 NEXT L1
9730 PRINT CTL(208);'27"&a+3R"'13'10;
9740 RETURN

```

Figure A-1. Large Character Set Utility Routine (sheet 2 of 2)

REFERENCE TABLES

APPENDIX

B

Table B-1. Programmers Reference Table

KEY or SWITCH	ESCAPE or CONTROL CODE	FUNCTION	KEY or SWITCH	ESCAPE or CONTROL CODE	FUNCTION
COMMUNICATIONS GROUP					
DUPLEX switch	—	HALF: typed characters are processed and transmitted to the computer. FULL: typed characters are transmitted to the computer and not processed by the terminal.	f1 key f2 key f3 key f4 key f5 key f6 key f7 key f8 key	ESC p ESC q ESC r ESC s ESC t ESC u ESC v ESC w	Special Function Keys. These are alternate control action keys. If these keys are pressed in conjunction with the CNTL key, the terminal transmits the corresponding escape code sequence. In Block Mode the terminal informs the computer that the key has been pressed by transmitting a DC2. The corresponding escape sequence is transmitted in response to a DC1. These escape code sequences can be used to perform any user-defined special functions by the computer. If these keys are pressed without using the CNTL key, the functions printed below the keys are performed.
PARITY switch	—	When set to EVEN/ODD/NONE, even/odd/no parity is transmitted for each character. Incorrect parity: a "0" or "1" is displayed.			
BAUD RATE switch	—	Selects data transmission rate of 110, 150, 300, 1200, 2400 baud. EXT: any rate between 110 and 2400 can be selected from an external source. The 110 baud rate uses 2 stop bits; all others use one stop bit.			
EDIT AND CONTROL GROUP					
RESET TERMINAL key	ESC E	The terminal is initialized to the power-on state.			
TEST key	ESC z	A diagnostic test of memory, ROM, and the display is performed. If a failure is detected an appropriate error message is displayed. If no error is detected a standard test pattern is displayed.	START UNPROTECTED FIELD key	ESC [Characters from the cursor position to the end of the current line or the next End Unprotected Field are unprotected in Format mode. Set while out of Format mode.
DISPLAY FUNCTIONS key and indicator	ESC Y [on] ESC Z [off]	All escape codes and control functions (typed or received) except ENQ, DEL, NULLS and carriage return (CR) are disabled and displayed. Carriage return is displayed but not disabled and performs both a carriage return and a line feed. ENQ, DEL and NULLS are only displayed when the terminal is set for local operation.	END UNPROTECTED FIELD key	ESC]	Characters from the cursor position to the end of the current line or the next Start Unprotected Field are protected. All lines are automatically protected unless otherwise specified by the use of Start Unprotected Field. Set while out of Format mode.
BLOCK MODE latching key	—	When the terminal is in Block Mode, typed data is displayed but not transmitted to the computer until requested by the computer or until the ENTER key is pressed. Otherwise, the terminal is in Character Mode and data is transmitted as typed.	FORMAT MODE key and indicator	ESC W [on] ESC X [off]	Only unprotected fields are operated on. Attempting to type into a protected field will move the cursor to the next unprotected field for data entry. The cursor home position is the first unprotected field location.
REMOTE latching key	—	The terminal is in Remote (on-line) operation. Otherwise, the terminal is in Local (off-line).	LINE FEED key	LF (J ^c)	Moves the cursor down one line. Disables Space Overwrite Latch. If the cursor is in the last line displayed on the monitor, a roll up is performed.
CAPS LOCK latching key	—	Locks all alphabetical keys to upper-case characters; @, [,] , \ , ^ , locked in lower-case; other numerical/symbol keys operate normally.	PRINT key	ESC O	The contents of the terminal's memory are printed if the printer is present.
MEMORY LOCK key and indicator	ESC l [on] ESC m [off]	If Memory Lock is enabled when the cursor is in the top line of the display the indicator is lighted and data is prevented from rolling off the top of memory. The MEMORY LOCK indicator blinks and an audible "beep" is generated when memory is full. Additional data, typed or received is ignored. If the cursor is not in the top line of the display when Memory Lock is enabled, displayed data above the cursor is frozen on the screen. Once the display is full the bottom lines on the display roll around the frozen data as additional data lines are typed or received.	INSERT LINE key	ESC L	The line containing the cursor and the remaining lines below the cursor line are rolled down and a blank line is inserted. The cursor is moved to the first column of the new blank line. Disabled in Format Mode.
AUTO LF latching key	—	Causes a line feed from time a carriage return is generated by the terminal.	DELETE LINE key	ESC M	The line containing the cursor is deleted and the remaining lines below the cursor line are rolled up. The cursor is moved to the first column of the first line rolled up from below and deleted line. Disabled in Format Mode.
ENTER key	—	Enables block transmission	INSERT CHAR key and indicator	ESC Q [on] ESC R [off]	Successing typed or received characters are inserted at the cursor position. As each character is inserted at the cursor position, the cursor and the characters to the right of the cursor are moved right one column. Control codes at the cursor position are not moved. Characters moved out of column 80 are lost. Operates on a field-by-field basis in Format Mode.
TRANSMIT indicator	—	The indicator will be lighted when clear to send is high.	DELETE CHAR key	ESC P	The character (including control codes) at the cursor position is deleted and all characters to the right of the deleted character are moved left one column. Operates on a field-by-field basis in Format Mode.
BREAK key	—	Transmits a 200 ms space on the asynchronous data communication line and sets secondary channel transmit low for 200 ms.			

Features On (x):

	@	A	B	C	D	E	F	G	H	I	J	K	L	M	N	O
Half Bright										x	x	x	x	x	x	x
Underline				x	x	x	x					x	x	x	x	
Inverse Video		x	x			x	x				x	x			x	x
Blinking	x		x	x	x		x		x	x	x	x	x		x	
End	x															

Table B-1. Programmers Reference Table (Continued)

KEY or SWITCH	ESCAPE or CONTROL CODE	FUNCTION	KEY or SWITCH	ESCAPE or CONTROL CODE	FUNCTION
NUMERIC PAD AND DISPLAY CONTROL GROUP					
Ten-Key Numeric Pad	—	Functions as an adding machine format keyboard.	—	DC1 (Q ^c)	Triggers a block transfer. Note that no block transfer requested by the computer begins until triggered with a DC1.
CLEAR TAB key	ESC Z	Clears a tab at the current cursor column.	—	DC2 (R ^c)	Block transfer enable from terminal.
SET TAB key	ESC I	Sets a tab at the current cursor column.	—	CAN (X ^c)	A code is sent to the computer to cancel the current line.
CLEAR DSPLY key	ESC J	Clears memory (and display) from the current cursor position to the end of memory; or to the end of line if CNTL is simultaneously pressed.	—	RS (Y ^c)	Record Separator. Terminates a block transfer.
ROLL UP key	ESC S	Moves the entire display up one line by displaying the next line from memory. Cursor is stationary.	—	US (Z ^c)	Unit Separator. Separates fields in Block Mode, Format On.
ROLL DOWN key	ESC T	Roll Down. Analogous in operation to Roll Up.	—	ESC a	Cursor sensing (absolute).
NEXT PAGE key	ESC U	Displays the next 24 lines of memory. The cursor is moved to the first unprotected location on the new page.	—	ESC `	Cursor sensing (relative).
PREV PAGE key	ESC V	Previous Page. Analogous to Next Page.	—	ESC b	Enables the terminal keyboard.
↑ key	ESC A	Cursor Up. Moves the cursor up one line on the display. If the cursor is in the top line, it is wrapped around to the bottom line of the display.	—	ESC c	Disables all keyboard keys except for the RESET TERMINAL key.
↓ key	ESC B	Cursor Down. Analogous to cursor up.	—	ESC d	The computer informs the terminal to begin information transmission to the computer.
→ key	ESC C	Cursor Right. Moves the cursor right one column on the display. Cursor wrap around to next line, or to the top line from the bottom.	—	ESC G	Moves the cursor to the first column of the current line.
← key	ESC D	Cursor Left. Analogous to cursor right.	—	ESC I	Performs same function as a horizontal TAB.
↖ key	ESC H	Cursor Home. Moves the cursor to the first position of the data in the display memory.	—	ESC K	Clears the line from the cursor position to the end of the current line or current unprotected field.
			CLEAR DISPLAY ^c key	ESC &a	Precedes a parameter sequence used to set cursor location.
				ESC &b	Precedes parameters making up a program which is loaded into the terminal and executed. This function is to be used by HP diagnostics only.
				ESC ^	Transmits six bytes of terminal status as a block transfer representing memory size, lower straps, upper straps, latching keys, transfer pending flags, error condition flags, and ended by a terminator.
CHARACTER SET GROUP					
Alphabetical numerical, and symbol keys	—	This group of key functions similarly to a standard typewriter keyboard. ASCII character codes are generated for upper and lower case letters, numbers and symbols.	—	ESC)	Precedes a parameter (@, A, B, C) which indicates which of four character sets will be the alternate set.
ESC (escape) key	ESC (I ^c)	Generates the ASCII escape code.	—	ESC f	Modem disconnect when used with 13250A card.
TAB key	HT (I ^c)	The TAB key moves the cursor to the next tab position to the right; or if none, the first column of the next line. In Format Mode, the cursor is moved to the start of the next Unprotected Field, disregarding normal horizontal Tab stops.	↖ ^c key	ESC F	Cursor home-down.
CNTL (control) key	(^c refers to CNTL key)	When pressed in conjunction with any alphabetical key or @, [, \,], ^, _ , {, , }, ~, DEL, the CNTL key converts the character code for that particular key into an ASCII control code. Control codes and functions, except RS, are not displayed unless in Display Functions mode.		MAINFRAME REAR PANEL SWITCHES	
BACKSPACE key	BS (H ^c)	The cursor is moved left one character position. If the cursor is in the first column, it remains there.	PWR ON/OFF switch	—	Primary power to the terminal is turned ON/OFF. Initial state: display and memory clear, cursor home, programmable functions off, Transmit Mode on.
RETURN key	CR (M ^c)	Returns cursor to beginning of its current line. Enables Space Overwrite Latch.	STRAPPING OPTIONS: <ul style="list-style-type: none"> ● Enable major function keys to transmit their respective escape sequences. ● Enable Space Overwrite Latch.* ● Disable end-of-line wrap around. ● Enable an entire block (from the cursor position to the end of memory) to be transmitted in Block Mode; otherwise, a line at a time is transmitted in Block Mode. ● Reverse the effect of the CNTL key associated with the 8 special function keys. ● Enable wait for DC1 before sending a DC2 in response to pressing the enter key. ● Enable sending of a DC2 before transmission of data for all block transfers. ● Disable transmission of DC2 by terminal for character or block transfers. <p>* When SPOW latch is set, the space code performs a cursor right function. When SPOW latch is reset, space codes overwrite existing characters. If the option is disabled, the latch is always reset.</p> <p>NOTE: The number of control characters allowed in a single line is dependent upon memory configuration</p>		
—	ENQ (E ^c)	Enquiry signal from the computer to the terminal.			
—	ACK (F ^c)	Acknowledge signal from the terminal to the computer in answer to an Enquiry.			
—	BEL (G ^c)	Bell. Causes terminal to emit an audible "beep"			
—	SO (N ^c)	Changes characters from the cursor position to the end of the line or the next Q ^c to alternate character set. (Refer to ESC).			
—	SI (O ^c)	Changes characters from the cursor position to the end of the line or the next N ^c to the base character set.			

Table B-2. ASCII Code Chart

BIT 7 6 5 4321	CONTROL (CNTL) CHARACTERS		DISPLAYABLE CHARACTERS				ESCAPE KEY PRESSED FIRST						
	0 0 0	0 0 1	0 1 0	0 1 1	1 0 0	1 0 1	1 1 0	1 1 1	0 1 0	0 1 1	1 0 0	1 0 1	1 1 0
0000	NUL NUL	DLE DLE	SP SP	0 @	P P	\ p		SP PRINT	0 0	@ @	P DELETE CHAR	\ CURSOR RELATIVE SENSE	p f ₁
0001	SOH SOH	DC1 DC1	! !	1 A	Q Q	a q		! SET TAB	1 ↑ CURSOR UP	A INSERT CHAR ON	Q CURSOR ABSOLUTE SENSE	a f ₂	q q
0010	STX STX	DC2 DC2	" "	2 B	R R	b r		" CLEAR TAB	2 ↓ CURSOR DOWN	B INSERT CHAR OFF	R KEYBOARD ENABLE	b f ₃	r r
0011	ETX ETX	DC3 DC3	# #	3 C	S S	c s		# %	3 → CURSOR RIGHT	C ROLL UP	S KEYBOARD DISABLE	c f ₄	s s
0100	EOT EOT	DC4 DC4	\$ \$	4 D	T T	d t		\$ %	4 ← CURSOR LEFT	D ROLL DOWN	T ENTER	d f ₅	t t
0101	ENQ ENQ	NAK NAK	% %	5 E	U U	e u		% &	5 RESET TERMINAL	E NEXT PAGE	U f ₆	e e	u u
0110	ACK ACK	SYN SYN	& &	6 F	V V	f v		& PARA-METER SEQUENCE	6 CURSOR HOME DOWN	F PREV PAGE	V MODEM DIS-CONNECT	f f ₇	v v
0111	BEL BELL	ETB ETB	' '	7 G	W W	g w		' ,	7 CURSOR RETURN	G FORMAT MODE ON	W f ₈	g g	w w
1000	BS BS	CAN CAN	((8 H	X X	h x		(,	8 CURSOR HOME	H FORMAT MODE OFF	X X	h h	x x
1001	HT HT	EM EM))	9 I	Y Y	i y) DEFINE CHAR SET	9 HORI-ZONTAL TAB	I DISPLAY FUNCTIONS ON	Y Y	i i	y y
1010	LF LF	SUB SUB	* *	: J	Z Z	j z		* :	: CLEAR DSPLY	J DISPLAY FUNCTIONS OFF	Z Z	j j	z TERMINAL SELF TEST
1011	VT VT	ESC ESC	+ +	; K	[[k {		+ ;	; ERASE TO END OF LINE	K START UNPROTECT FIELD	[[k k	{ {
1100	FF FF	FS FS	, ,	< L	\ \	 		, <	< INSERT LINE	L MEMORY LOCK ON	 	 	
1101	CR CR	GS GS	- -	= M]]	m }		- =	= DELETE LINE	M END UNPROTECT FIELD]]	m m	} MEMORY LOCK OFF
1110	SO SO	RS RS	. .	> N	^ ^	n ~		. >	> N	^ TERMINAL STATUS	n n	~ ~	~ ~
1111	SI SI	US US	/ /	? O	- o	DEL DEL		/ ?	? O	- -	o o	DEL DEL	DEL DEL

Example: J is bits 1001010; Control J is LF line feed; Escape (ESC) followed by J is CLEAR DISPLAY

LEGEND

- | | | |
|-------------------------|----------------------------------|-----------------------------|
| AK --- ACKNOWLEDGE | EM --- END OF MEDIUM | NK --- NEGATIVE ACKNOWLEDGE |
| BELL --- BELL | EQ --- ENQUIRY | RS --- RECORD SEPARATOR |
| BS --- BACKSPACE | ET --- END OF TRANSMISSION | SI --- SHIFT IN |
| CN --- CANCEL LINE | EC --- ESCAPE | SO --- SHIFT OUT |
| CR --- CARRIAGE RETURN | EB --- END OF TRANSMISSION BLOCK | SP --- SPACE |
| D1 --- DEVICE CONTROL 1 | EX --- END OF TEXT | SH --- START OF HEADING |
| D2 --- DEVICE CONTROL 2 | FF --- FORM FEED | SX --- START OF TEXT |
| D3 --- DEVICE CONTROL 3 | FS --- FILE SEPARATOR | SB --- SUBSTITUTE |
| D4 --- DEVICE CONTROL 4 | GS --- GROUP SEPARATOR | SY --- SYNCHRONOUS IDLE |
| DEL --- DELETE | HT --- HORIZONTAL TABULATION | US --- UNIT SEPARATOR |
| DL --- DATA LINK ESCAPE | LF --- LINE FEED | VT --- VERTICAL TABULATION |

- NOTES: 1. LOWER CASE LETTER, LOWER CASE SYMBOL, AND CONTROL CHARACTER CODES ARE GENERATED BY STANDARD TERMINAL, BUT ASSOCIATED CHARACTERS ARE NOT DISPLAYED ON THE SCREEN.
2. SINGLE CHARACTER ESCAPE SEQUENCES AND CONTROL CODES NOT LISTED WITH A FUNCTION ARE NEITHER ACTED UPON NOR DISPLAYED.
3. SHADED CHARACTERS PRODUCE SPECIAL GRAPHIC CHARACTERS ON THE HP 2640N AND HP 2640S TERMINALS. REFER TO THE PREFACE FOR ADDITIONAL INFORMATION.

Table B-3. Coding the Large Character Set

The elements of the Large Character Set are associated with the keyboard as pictured below:

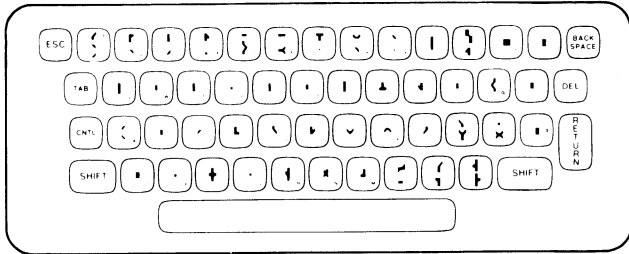

Each large character is actually made up of nine character segments. An example of constructing the letter "B" using the Large Character Set follows:

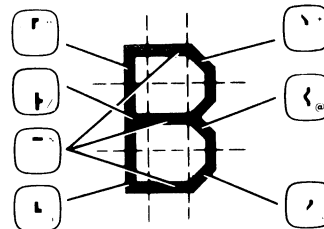

Large Character Set:

!	0 S	- %&, Z	9 !&+ G&? G&L	E "&, /&, F&, E	Q !&+ 0 0 G&N	J % . 0 %M	i * # E	U " FM
" "	.	z	: Z	F "&, /&, E	R "&+ /& E E	^ 9 K	j * # GL	U " GL
# CC CC	÷ %&, 4	; Y L	G !&+ 0 . G&L	S !&+ G&+ G&L	- ...	k /& EE	w " HD	
\$!C+ GC+ GCL	0 !&+ 0 0 G&L	< 3 2	H /&? E E	T %', 0 E	\ *	l 0 E	x 5 EE	
% P P 3<D Y Y	1 - 0 E	= %&, %&,	I / 0 I	U # # 0 0 G&L	a !. GM	n \$- EE	4 " G?	
& !+ SIC G&L	2 !&+ !&L F&,	>) D	J 0 L	V # # 0 0 2JD	b /+ FL	n "+ EE	z . F,	
' '	3 !&+ &# G&L	? !&+ >D S	K /&A E E	W # # 0 90 HKD	c !, G,	o !+ GL	{ !, #, G,	
(!, 0 G,	4 # # F&C E	@ !&+ !.0 GIL	L / F&,	X # # 1:A E E	d !? GM	p "+ /L	0 U	
) %+ 0 %L	5 "&, F&+ G&L	A !&+ /&? E E	M \$(- 0 70 E E	Y " 2;D E	e !+ G,	q !. G?	} %+ 5 %L	
x 1:A	6 !&+ /&+ G&L	B "&+ /&# F&L	N \$) # 0 8B E E	Z "&. 3<D F&M	f !+ C E	r !, E	~ !&L	
+ * %C, 4	7 %&. >D E	C !&+ 0 G&L	O "&. 0 0 F&M	[", 0 F,	q !. G?	s !, %L	***	
, L	8 !&+ 5&# G&L	D "&+ 0 0 F&L	P "&+ /&L E	x / 2;) E	h /+ EE	t * C GL	***	

Table B-4. Specifications

GENERAL	ENVIRONMENTAL CONDITIONS
Screen Size: 127 mm (5 inches) X 254 mm (10 inches)	Temperature, Free Space Ambient: Non-Operating: -40 to +75°C (-40 to +167°F) Operating: 0 to 55°C (+32 to +131°F)
Screen Capacity: 24 lines X 80 columns (1,920 characters)	Humidity: 5 to 95% (non-condensing)
Character Generation: 7 X 9 enhanced dot matrix; 9 X 15 dot character cell; non-interlaced raster scan	Altitude:
Character Size: 2.46 mm (.097 inches) X 3.175 mm (.125 inches)	Non-Operating: Sea level to 7620 metres (25,000 feet) Operating: Sea level to 4572 metres (15,000 feet)
Character Set: 64 upper-case	Vibration and Shock (Type tested to qualify for normal shipping and handling):
Cursor: Blinking-Underline	Vibration: .30 mm (0.012") pp, 10 to 55 Hz, 3 axis
Display Modes: White on Black; Black on White (Inverse Video)	Shock: 30g, 11 ms, 1/2 sine
Refresh Rate: 60 Hz (50 Hz optional)	PHYSICAL SPECIFICATIONS
Tube Phosphor: P4	Display Monitor Weight: 16.8 kg (37 pounds)
Implosion Protection: Bonded implosion panel	Keyboard Weight: 3.2 kg (7 pounds)
Memory: MOS, ROM: 8K bytes (program); RAM; std. 1024 bytes; 8 kilobytes max.	Display Monitor Dimensions: 444 mmW X 457 mmD X 342 mmH (17.5"W X 18"D X 13.5"H) (648 mmD (25.5"D) including keyboard)
Keyboard: Detachable, full ASCII code keyboard, 8 special function keys, and 12 additional control and editing keys; ten-key numeric pad; cursor pad; multi-speed auto-repeat, N-key roll-over; 1.22m. (4 foot cable).	Keyboard Dimensions: 444 mmW X 216 mmD X 90 mmH (17.5"W X 8.5"D X 3.5"H)
DATA COMMUNICATIONS	POWER REQUIREMENTS
Data Rate: 110, 150, 300, 1200, 2400 baud, and external-switch selectable (110 selects two stop bits)	Input Voltage: 115 (+10% -23%) at 60 Hz (±.2%) 230 (+10% -23%) at 50 Hz (±.2%)
Standard Asynchronous Communications Interface: EIA standard RS232C; fully compatible with Bell 103A modems; compatible with Bell 202C/D/S/T modems. Choice of main channel or reverse channel line turnaround for half duplex operation. Optional current loop, split speed, custom baud rates.	Power Consumption: 75 W to 120 W max.
Transmission Modes: Full or half duplex, asynchronous	PRODUCT SAFETY
Operating Modes: On-Line; Off-line; Character, Block	Product meets: UL Requirements for: EDP equipment, office appliances, teaching equipment CSA Requirements for: EDP equipment
Parity: Switch selectable; Even, Odd, None	U.L. and CSA labels are applied to equipment shipped to the U.S. and Canada.

COMMUNICATIONS FLOWCHARTS

APPENDIX

C

This appendix contains reference information on terminal communication functions. This material consists of the following flowcharts and tables:

- ASCII code table
- Overall communications flowchart
- Keyboard communication switches

Table C-1 is a list of the ASCII characters and their decimal equivalents.

The flowchart in figure C-1 illustrates the overall communication function. The various configuration parameters (switches) are included in the diagram. Detailed descriptions of the switches are given in sections V and VII. Figure C-2 illustrates the way the terminal responds to various keyboard switches.

Table C-1. ASCII Character Set

DECIMAL VALUE	GRAPHIC	COMMENTS	ALTERNATE CHARACTER	DECIMAL VALUE	GRAPHIC	COMMENTS
0		Null	@ ^c	64	@	Commercial at
1		Start of heading	A ^c	65	A	Uppercase A
2		Start of text	B ^c	66	B	Uppercase B
3		End of text	C ^c	67	C	Uppercase C
4		End of transmission	D ^c	68	D	Uppercase D
5		Enquiry	E ^c	69	E	Uppercase E
6		Acknowledge	F ^c	70	F	Uppercase F
7		Bell	G ^c	71	G	Uppercase G
8		Backspace	H ^c	72	H	Uppercase H
9		Horizontal tabulation	I ^c	73	I	Uppercase I
10		Line feed	J ^c	74	J	Uppercase J
11		Vertical tabulation	K ^c	75	K	Uppercase K
12		Form feed	L ^c	76	L	Uppercase L
13		Carriage return	M ^c	77	M	Uppercase M
14		Shift out	N ^c	78	N	Uppercase N
15		Shift in	O ^c	79	O	Uppercase O
16		Data link escape	P ^c	80	P	Uppercase P
17		Device control 1 (X-ON)	Q ^c	81	Q	Uppercase Q
18		Device control 2	R ^c	82	R	Uppercase R
19		Device control 3 (X-OFF)	S ^c	83	S	Uppercase S
20		Device control 4	T ^c	84	T	Uppercase T
21		Negative acknowledge	U ^c	85	U	Uppercase U
22		Synchronous idle	V ^c	86	V	Uppercase V
23		End of transmission block	W ^c	87	W	Uppercase W
24		Cancel	X ^c	88	X	Uppercase X
25		End of medium	Y ^c	89	Y	Uppercase Y
26		Substitute	Z ^c	90	Z	Uppercase Z
27		Escape	[^c	91	[1	Opening bracket
28		File separator	\ ^c	92	\ 1	Reverse slant
29		Group separator] ^c	93] 1	Closing bracket
30		Record separator	^ ^c	94	^ 1	Circumflex
31		Unit separator		95	—	Underscore
32		Space (Blank)		96	`	Grave accent
33	!	Exclamation point		97	a	Lowercase a
34	"	Quotation mark		98	b	Lowercase b
35	#	Number sign		99	c	Lowercase c
36	\$	Dollar sign		100	d	Lowercase d
37	%	Percent sign		101	e	Lowercase e
38	&	Ampersand		102	f	Lowercase f
39	'	Apostrophe		103	g	Lowercase g
40	(Opening parenthesis		104	h	Lowercase h
41)	Closing parenthesis		105	i	Lowercase i
42	*	Asterisk		106	j	Lowercase j
43	+	Plus		107	k	Lowercase k
44	,	Comma		108	l	Lowercase l
45	-	Hyphen (Minus)		109	m	Lowercase m
46	.	Period (Decimal)		110	n	Lowercase n
47	/	Slant		111	o	Lowercase o
48	0	Zero		112	p	Lowercase p
49	1	One		113	q	Lowercase q
50	2	Two		114	r	Lowercase r
51	3	Three		115	s	Lowercase s
52	4	Four		116	t	Lowercase t
53	5	Five		117	u	Lowercase u
54	6	Six		118	v	Lowercase v
55	7	Seven		119	w	Lowercase w
56	8	Eight		120	x	Lowercase x
57	9	Nine		121	y	Lowercase y
58	:	Colon		122	z	Lowercase z
59	;	Semicolon		123	{ 1	Opening (left) brace
60	<	Less than		124	1	Vertical line
61	=	Equals		125	} 1	Closing (right) brace
62	>	Greater than		126	~ 1	Tilde
63	?	Question mark		127		Delete

Notes: 1. 2640B [\] ^ { | } ~
2640N Æ ø Å Ü æ ø å ü
2640S Ä Ö Å ^ ä ö å _

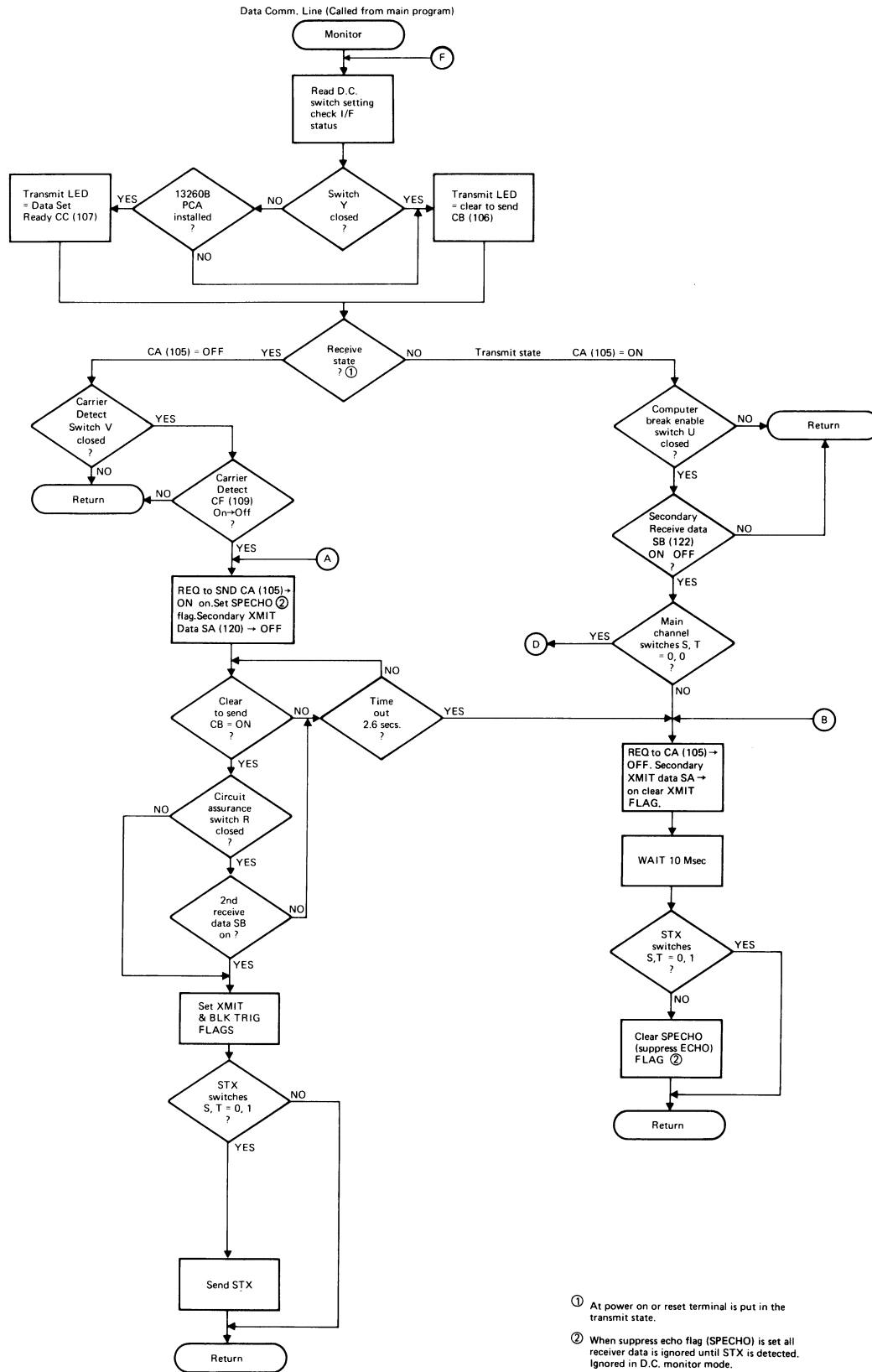

Figure C-1. Communication Flowcharts (Sheet 1 of 3)

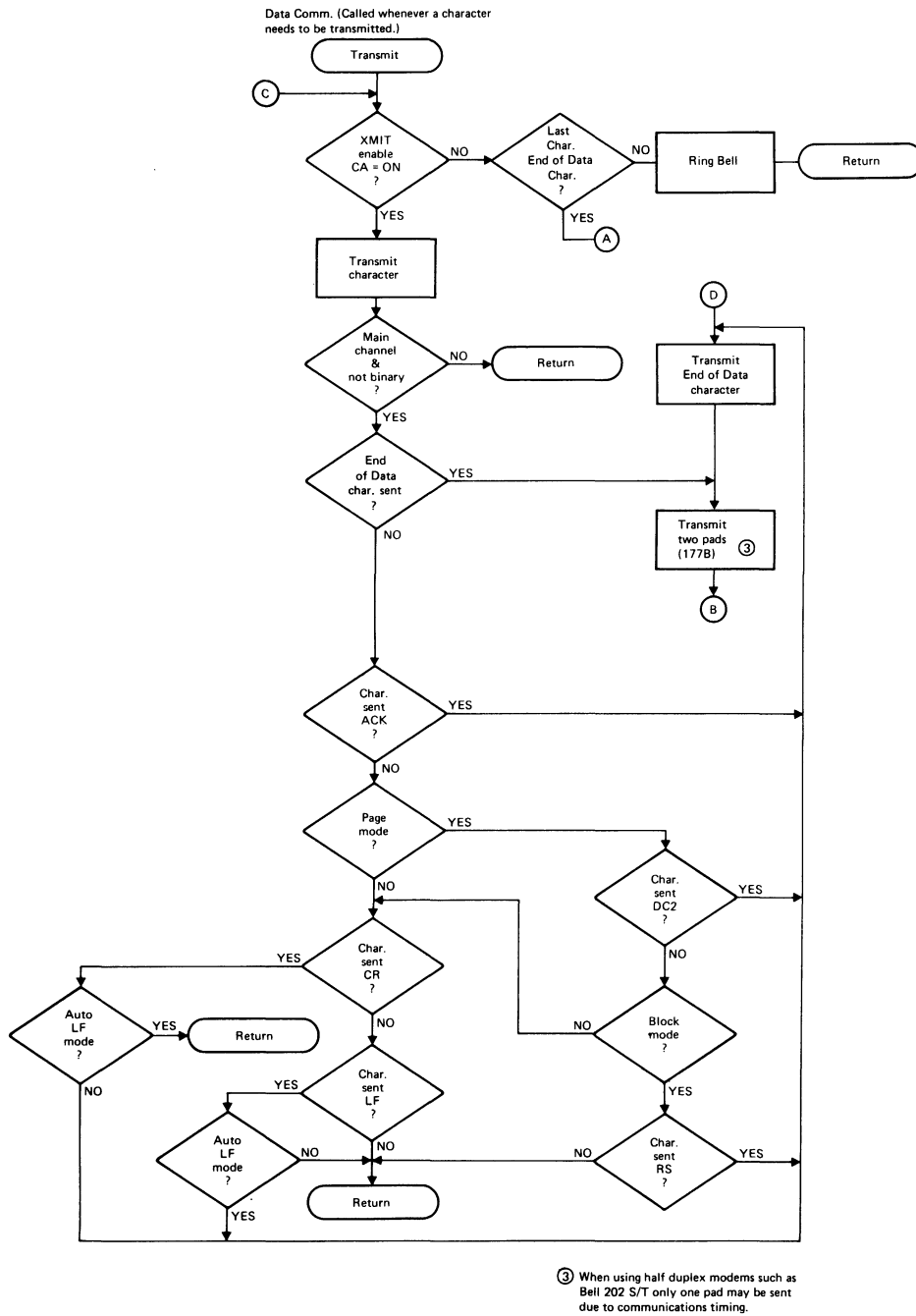

Figure C-1. Communication Flowcharts (Sheet 2 of 3)

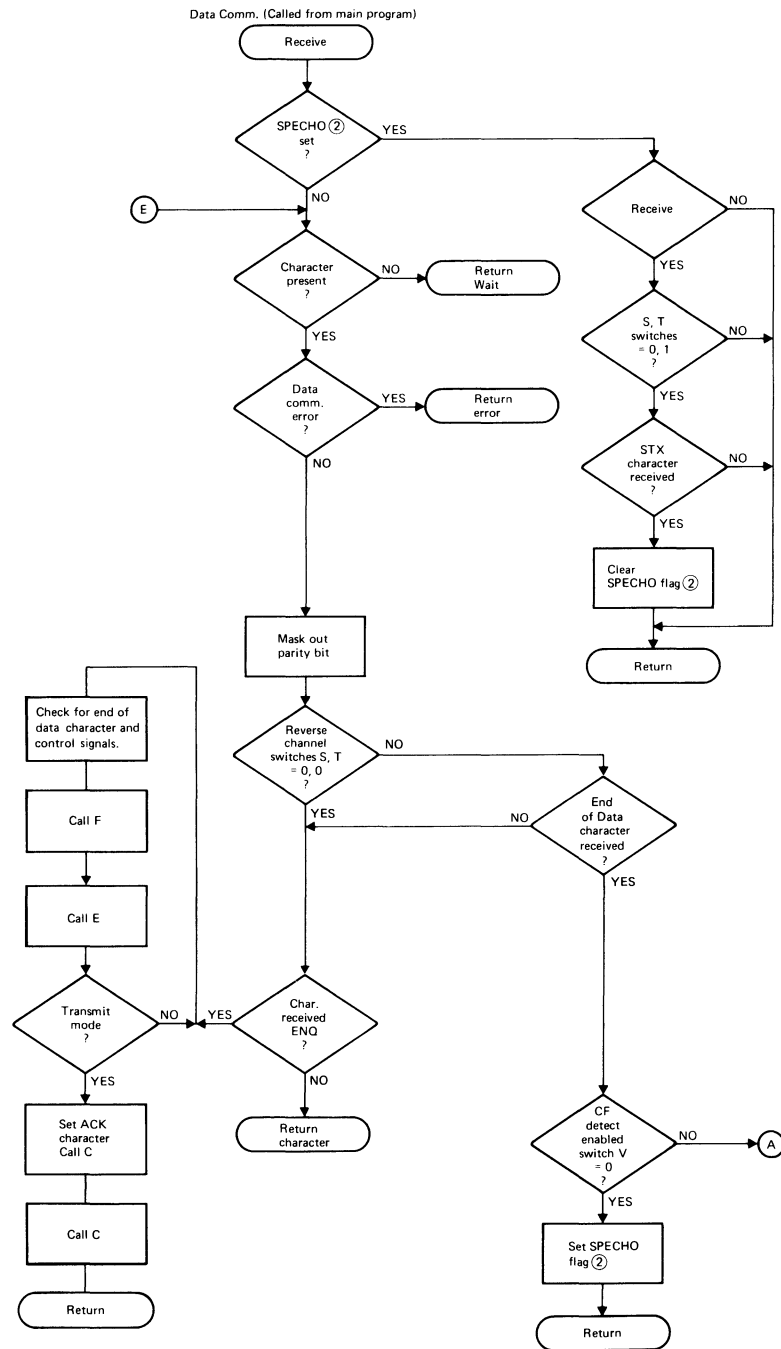

Figure C-1. Communication Flowcharts (Sheet 3 of 3)

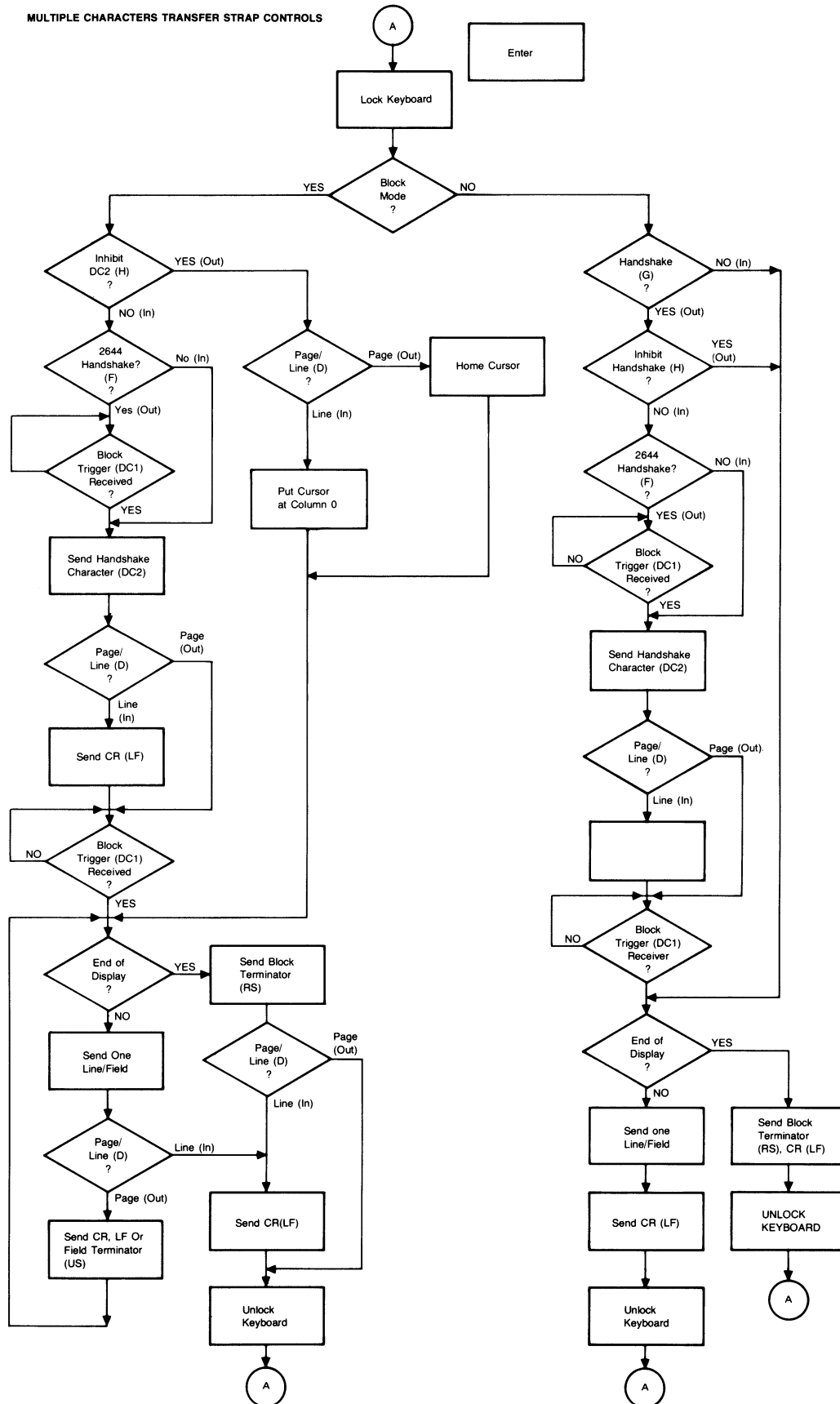

Figure C-2. Keyboard Communication Switches Flowcharts (Sheet 1 of 3)

MULTIPLE CHARACTERS TRANSFER STRAP CONTROLS

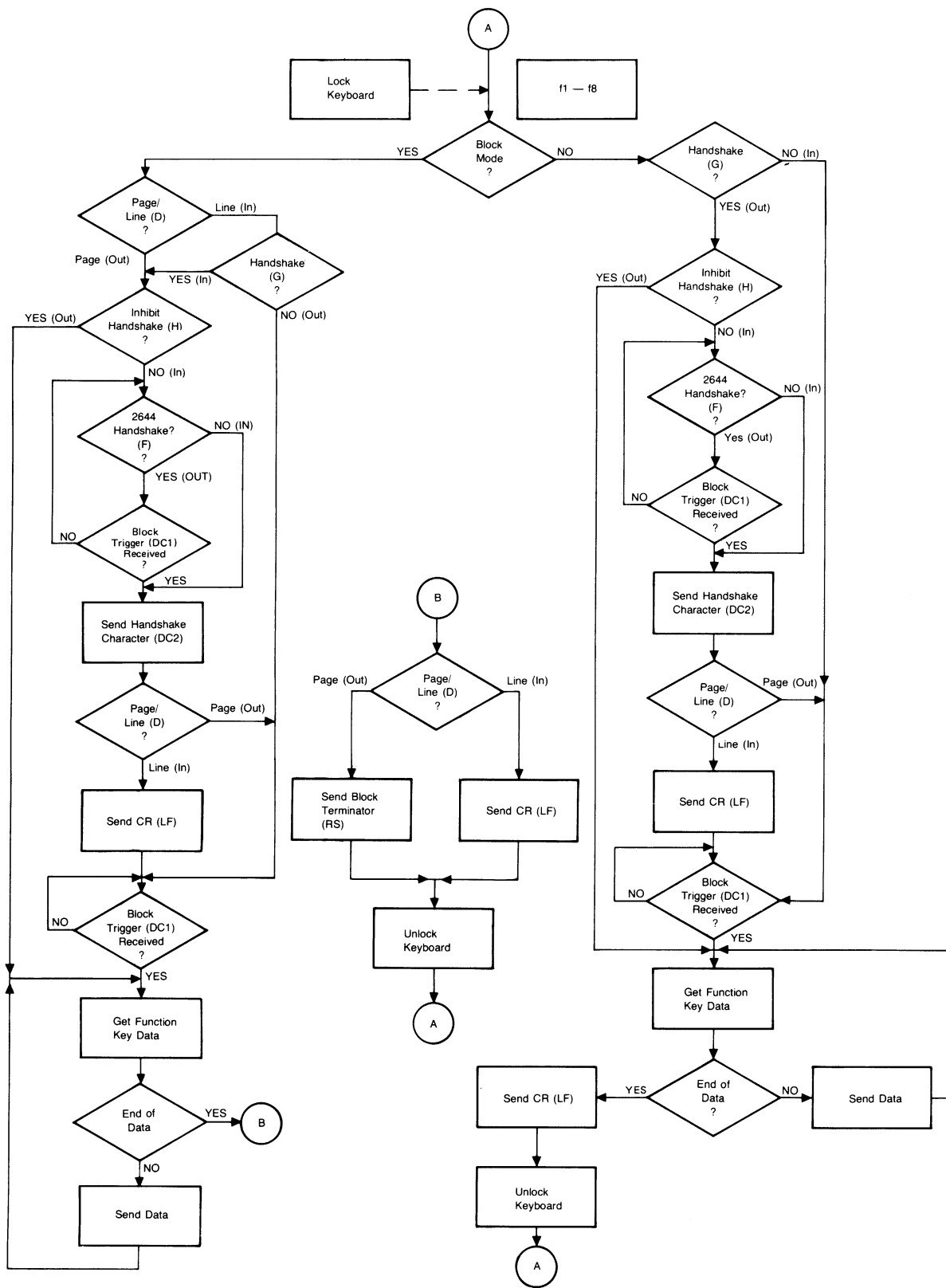

Figure C-2. Keyboard Communication Switches Flowcharts (Sheet 2 of 3)

MULTIPLE CHARACTER TRANSFER STRAP CONTROLS

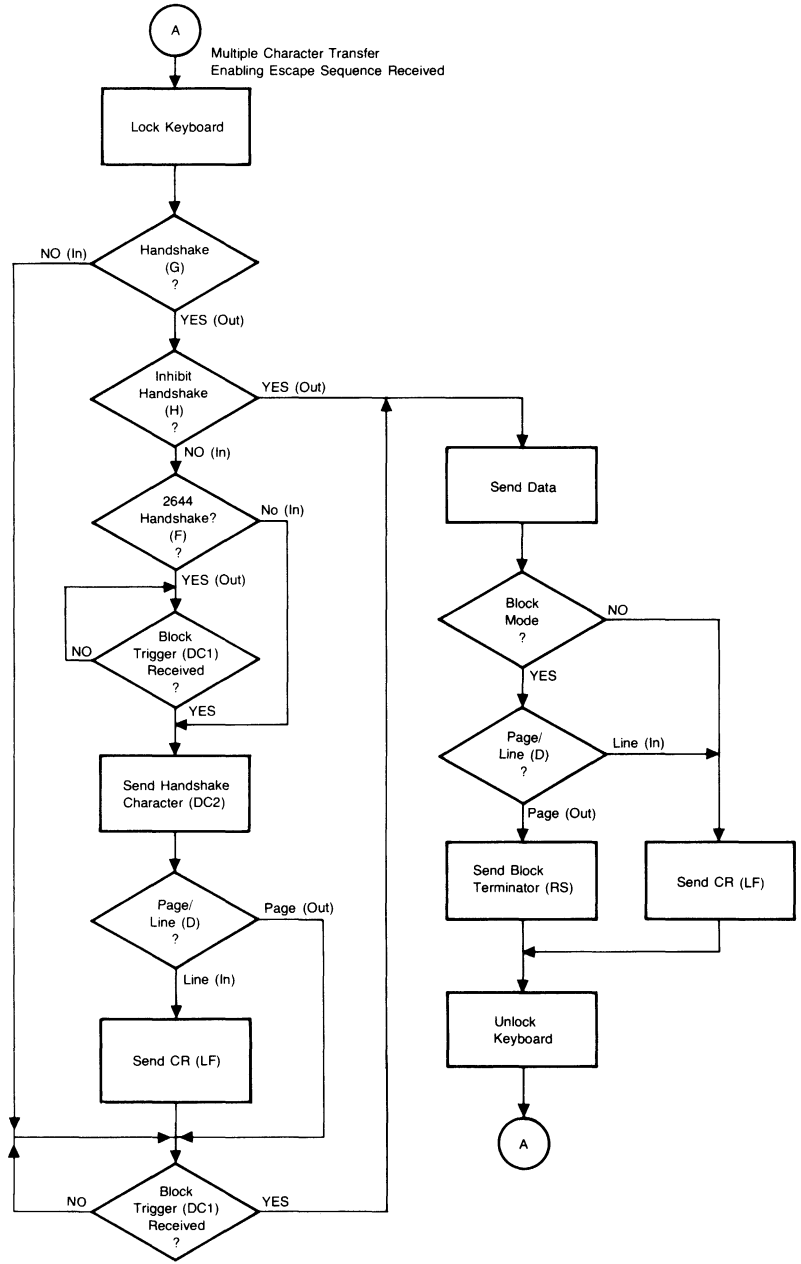

Figure C-2. Keyboard Communication Switches Flowcharts (Sheet 3 of 3)

13231 Display Enhancements	7-8
13232 Cable Assemblies	7-9
13234 4K Memory installation	7-10
13238 Terminal Duplex Register installation	7-11
13240A I/O Extender	7-12
13245 Character Set Generation Kit installation	7-13
13246 Printer installation	7-14
13250B Interface straps	7-19
13349 Printer installation	7-14
202 Modem compatibility	5-11
64 Character ROM installation	7-7
9866 Printer installation	7-14
9871 Printer installation	7-14

A

accessory installation	7-7
ACK	5-5
addressing, cursor	3-2
alternate character sets	3-6
ASCII character set	C-2
applications	A-1

B

backplane extender	7-12
backspace	3-3
basic communications	5-5
baud rate selection	5-3
Baud Rate switch	5-3
bell	2-2
blinking	3-5
block mode	5-8
Block Mode key	5-3
block moves (text)	3-4
Break key	5-3

C

cable fabrication	7-22
cable lengths	7-10, 7-22
cable types	7-21
cables	7-9
CCITT signals	7-21
character delete	3-4
Character Mode	5-8
character sets	3-6
Character Set Generator installation	7-13
character set selection	3-6
clear display	3-3
clear line	3-3

clear tab	3-3
communication protocols	5-5
communications	5-1
communications, basic	5-7
communication interface installation	7-13
communication flowcharts	C-3, C-6
computers, connecting to	5-1
configuration	5-16
connecting terminals	5-1
control character protocol	5-11
control functions, terminal	2-2
controlling the display	3-1
cursor positioning	3-2
cursor sensing	3-2

D

data communications	5-1
delete character	3-5
delete line	3-5
display clear	3-3
display control	3-1
display enhancements	3-7
Display Enhancements, installation	7-8
display memory functions	3-1
distance, cabling limits	7-22
Duplex Register installation	7-10
Duplex switch	5-3

E

edit functions	3-5
ENQ	5-5
Enter key	5-8
EOT	5-11
escape sequence	2-2, 3-2, 3-3, 3-4, 3-6, B-1
ETX	5-11
Extended Asynchronous Interface straps	7-19
Extender backplane	7-12

F

fan, installation	7-5
fields	3-6
flowcharts, communication	C-3, C-6
Format Mode	3-6
forms mode	3-6
full duplex operation	5-11

Index

G

grounding 7-6

H

half bright 3-8
half duplex operation 5-11
high-speed operation 5-5
home down 3-3
home up 3-3

I

insert character 3-4
insert line 3-4
installation 7-1
installation, accessory 7-7
i/o extender 7-12
interfaces 5-1
interface cable signals 7-21
interface signals 5-4
inverse video 3-5

K

keyboard disable 2-2
keyboard enable 2-2
Keyboard Interface switches 5-6

L

Large Character Set 3-7, B-3
Large Character Set installation 7-8
Large Character Set Utility A-1
line delete 3-4
line feed 3-3
Line character set 3-7
Line Set installation 7-8
logic levels 7-21
Lower Case ROM installation 7-7

M

Main Channel protocol 5-11
Math Character Set 3-7
Math Set installation 7-8
memory configuration 7-10
memory lock 3-3
modem disconnect command 2-2
modems 5-4
moving text blocks 3-4
multicharacter transfers 5-8

N

networks 5-1
next page 3-3
NULL 5-5

O

opening the terminal 7-2

P

PAD 5-5
page 3-3
Parity Switch 5-3
point-to-point configuration 5-15
positioning the cursor 3-2
power supply adjustment 7-14
terminal status 6-2
printer installation (9866) 7-14
printer installation (9871) 7-14
printer, using a 4-1
program load command 2-2
protected fields 3-5
protocols 5-11
protocol, Main Channel 5-11
protocol, Reverse Channel 5-11

R

Remote key 5-3
reset terminal 2-2
return 3-3
Reverse Channel protocol 5-11
roll down 3-3
roll up 3-3
RS232C signals 7-21

S

selection of character sets 3-6
Self-Test command 2-2
Self-Test procedure 7-22
send display 2-2
sensing the cursor position 3-2
set tab 3-3
signal levels 7-21
signal line control 5-11
signals, interface 5-1, 7-21
specifications B-1
speed switches 5-3
status 6-1
status interpretation 6-1
strapping option selection 7-16
STX 5-1

T

tab.....	3-3
teletype compatible operation.....	5-11
terminal control functions.....	2-2
terminal self-test command.....	2-2
terminal status.....	6-1
terminals, connecting.....	5-1
test patterns.....	7-25
text moving.....	3-4

U

underline.....	3-5
unprotected fields.....	3-5

V

video output.....	4-1
voltage selection.....	7-6

NOTES

