

NO. 2161822  
 SHEET 0  
 OF 52

# DIAGNOSTIC TEST

DIPAL NAME IS DT22

TITLE FAULT ISOLATION - DT0022  
 MACH. TYPE 1311 BY GIF APPR. CSF DATE 4/8/63

## ENGINEERING CHANGE HISTORY

E/C NO.	DATE	SHEETS AFFECTED
404860-A	5-3-63	1 - 64
404908	7-30-63	1, 2, 24-60
404980	5-7-64	29 - 52

E/C NO.	404860-A	404908	404980				
DATE	5-3-63	7-30-63	5-7-64				

## 1311 DIAGNOSTIC TEST 0022

## FAULT ISOLATION

**A. SCOPE:**

This test was designed primarily to detect and isolate malfunctions in the operation and control of the 1311 Disk Storage Drive and requires that the CE Disk Pack, with test data written of cylinder 97 by DT 0021, be on the Disk Storage Drive.

The detection and isolation portion of the test checks the write operations; therefore, precautions should be taken to protect customer packs installed on multiple module systems.

The C.E. Pack may be on any module of a multiple module system, but the addresses must be 00000-19999. These must be written with DT 0020.

It checks the seek operation, read, write, and read back check (with and without wrong length record check) operations. It also checks that the error indicators, address check, overflow, wrong length record check, and any file, are functioning properly.

The test also contains a routine to verify that the addresses on a cylinder are correct. Since the only file instructions used by this routine are seek and read full track, this routine may be used with a customer's disk pack; however, **CAUTION SHOULD BE EXERCISED** not to enter the detection and isolation portion of the test while the customer's disk pack is on the Disk Storage Drive.

**B. SET UP:**

1. While running the test, the program switches have the following functions:

Switch 1 ON	Bypasses error typeouts
OFF	Allows error typeouts
Switch 2 ON	Loops routine
OFF	Proceeds to the next routine
Switch 3 ON	Halts on error
OFF	Bypasses halt on error
Switch 4 ON	Loops test
OFF	Test Completion, Halt

2. Switch 3 has two additional functions during the set up phases. One function is to insure that the CE Disk Pack has been installed, and the other is to allow corrections if an error is made while keying

in data from the console typewriter.

After the name of the test is typed out, the instructions to remove all customer packs and turn switch 3 on are typed out. The program remains in a loop, branching to an instruction that checks switch 3, until switch 3 is turned on. Additional instructions (switch functions, etc.) are typed out after switch 3 is turned on. Switch 3 must be turned off to permit the entry of keyed in data; since switch 3 is the correction switch.

To make corrections when keying in data from the typewriter, turn console switch 3 on, press release and start. Then turn switch 3 off and key in data again.

### 3. File Switches

WRITE ADDRESS SWITCH -- OFF  
COMPARE DISABLE SWITCH -- OFF (IN)

### 4. Normal setting of 1620 Console Switches

Program Switches -- AS DESIRED  
Data Switches -- Program

5. The user should insure that the PACK ON and READY lights on the Disk Storage Drive are ON.

### 6. LOADING PROGRAM

A. Clear core by inserting and executing 31 00003 00002

B. Paper Tape input

1. Load tape in reader

2. Insert and execute 36 00000 00300

3. After paper tape has loaded core, depress computer start.

4. Follow typed out instructions.

C. Card Input

1. Place cards in read hopper

- (2) Place 1620 in manual mode
- (3) Depress load key
- (4) Depress computer start after cards have loaded  
core
- (5) Follow typed out instructions

C. DETAILED EXPLANATION:

This test was designed to detect and isolate malfunctions in the 1311 Disk Storage Drive Units. The messages typed out whenever a malfunction is detected will indicate the symptoms of and the function being performed when the malfunction occurred. Some malfunctions may cause "hang-ups." This is still a detection and proper utilization of the console indicators and the instruction being performed should provide information for a diagnosis of the malfunction.

To aid in the diagnosis of the malfunction, this test has been designed in routine form, each routine performing some logical function. These routines are:

Control Routine

Address Check Routine

Locate a Properly Functioning Head Routine

Check Seek Routine

Read and Head Test Routine

Check Disk Operations Routine

Overflow and Wrong Length Record Check Routine

Any File and Any Data Check Routine

Read Only Address Routine

Test Complete Routine

Error Routine

Reset VRC Routine

The Control Routine is comprised of a group of routines to type the name of the test, switch settings, pertinent instructions regarding the operation of the test; to allow the keying in of essential information for proper operation of the test; to compute the drive code digit and store it in the Disk Control Field (sub-instruction).

The input entered during the execution of the Control Routine is:

1. Yes or No, entered from the console typewriter in answer to the question "Check Flag Address, Type Yes or No." Enter YES, if the Read-Only operation is to be checked. This routine will also check that addresses which are not sequential and incremented by one, will turn on the Address Check Indicator
2. One digit Module number, entered from console typewriter indicating the Disk Drive Unit on which the CE Pack is installed.

After the module number has been entered, the drive code digit is computed and stored in the  $F_0$  digit of the

disk Control Field sub instructions. The calculation of the drive code gives the following results:

<u>Module No.</u>	<u>Drive Code</u>
0	1
1	3
2	5
3	7

Once the Control Routine has been executed, all the necessary initialization and "housekeeping" has been accomplished, the actual checking can be performed.

The Address Check Routine checks for proper operation of the Address Check Indicator. This indicator must be functioning properly to be used to help diagnose malfunctions. A seek of cylinder 97 is executed; then an attempt to force on the Address Check Indicator is made by reading sector 00000. If the address check is forced on, then a program check is made to verify that the access mechanism was positioned at cylinder 97. This can be done by reading a full track and checking the address read. If the address check is not forced on by reading sector 00000, a program check is made that addresses can be read from the Disk Storage unit into the 1620 core storage, whether the correct Disk Storage

Drive unit was selected, and whether or not the arm was positioned at cylinder 97. The results of this program analysis is typed out and the routine repeated until an address check is forced with the arm at cylinder 97 and sector 00000 being read.

The "Locate a Properly Functioning Head Routine" is executed after the proper verification of the address Check Indicator. This routine determines which head will be used to verify that the seek commands are functioning properly. A read numeric sector without wrong length record check instruction is executed. The parity indicators Read check, MBRE, MBRO, and Address Check are interrogated. These must be off for proper operation. If any of these indicators are on, a malfunction is indicated. The first digit of the sector read is checked to see if it compares with the digit that selects that head. These two digits must be the same for proper operation. If these checks indicate correct operation, this head is used to check the seek commands. This check starts with head zero and continues through the heads until the first properly functioning head is located. If

a good head is not located out of the ten possible, the routine is repeated until a good head is found.

The Check Seek Routine accesses to cylinders 11, 22, 33, 44, 55, 66, 77, and 88. After the seek command has been executed a read numeric sector without wrong length record check is executed. The Address Check Indicator is then interrogated. If the indicator is on, a malfunction has been detected and an error message is typed out. The message will include the cylinder number at which the access mechanism is positioned. This cylinder number is calculated by first executing a read disk track numerically and then operating on the first five digits read into the 1620 core storage.

The Read and Head Test routine checks for correct operation of the read amplifier and all heads. To do this the test data that was written on cylinder 97 of the CE Disk Pack by DT 0021 is generated and stored in the 1620 core storage area labeled A1. Then a seek command is executed to position the access mechanism at cylinder 97. A check is made



that cylinder 97 was reached by interrogating Any Data check to see that it is off (indicating no parity checks) and by reading a sector with an address on cylinder 97 and verifying that no address check results. Then a read in area, labeled A2, is set to zero. The first record of the track is read into the read in area A2 and a check made that no parity check indicators were turned on. Then a program compare is made that the data read in compares with the generated data in area A1. If not, an analysis is made to see if the data or the head number is correct, and the appropriate error message is typed out. This procedure is repeated until the first record of all ten tracks on cylinder 97 have been read.

The Check Disk Operations Routine is comprised of several smaller routines. The first of these smaller routines test the read track with and without wrong length record check operations. Then the write disk numerically with and without wrong length record check and the read back check operations are tested in the next four smaller routines.

The read track without wrong length record check is performed on cylinder 97 by executing a read

disk numerically using the good head found in the Locate a Properly Functioning Head Routine verifying that no parity checks were turned on, and performing a program compare of the last address. If any of these checks give a negative result, the appropriate error message is typed out. If the results indicate proper operation, the routine is repeated for all heads using the read disk numerically with wrong length record check instruction. The same tests are made on the parity circuits and comparing the last address. Appropriate error messages are typed out if a malfunction is indicated.

The write amplifier and the write and read back compare instructions are tested on cylinder 03. First the access mechanism is given a seek command to position it at cylinder 03. Verification that it reached cylinder 03 is made by interrogating the Any Data check after the seek operation and performing a read disk numerically without wrong length record check to see that no address check occurs. Once the access mechanism is positioned all heads starting with 0 and ending with 9, are used to write the test data on their respective tracks using the write Disk Numerically without Wrong Length Record check instruction. The Check Disk Numerically and a program compare of the data read into core storage

with a Read Disk Numerically instruction are used to verify that the data was actually written. The parity check circuits are interrogated after each Disk Storage Operation. Appropriate error messages are typed out if any malfunctions are detected.

After head 9 has checked in the Without Wrong Length Record Check mode, zeros are written on all tracks of cylinder 03. A Check Disk Numerically command is used to verify that the zeros were written on each track.

After the tracks on cylinder 03 have been set to zero, the test data is written on cylinder 03 using the Write Disk Numerically with Wrong Length Record Check mode. The Check Disk Numerically with Wrong Length Record Check and the program compare of the data written are performed for each track to verify correct operation. Appropriate error messages are typed out whenever malfunctions are detected.

The Overflow and Wrong Length Record Check Routine is entered upon completion of the Check Disk Operation Routine. This routine checks that

Overflow and Wrong Length Record (WLR) Check indicators can be turned on and they in turn turn on the any File Check. An attempt is made to turn on the Overflow Indicator by reading 21 sectors from the bottom track of cylinder 03. The Any File and the Overflow Indicators are interrogated, and appropriate error messages are typed out if one or the other or both are off. If both indicators are on, the routine to test the WLR Check indicator is entered.

Three attempts are made to turn on the WLR Check Indicator. The first attempt is by writing a sector, changing a digit in the write data and then executing a Check Disk Numerically with Wrong Length Check against this altered data. The Any File and WLR Check Indicators are interrogated for being on. If they are off, appropriate error messages are typed out. The next two attempts to turn on the WLR Check indicator are made by the placement of the group mark. The first of these attempts is made with the group mark located such that it is detected before the 100 character sector is read. The second is if the group mark is detected after more than 100 characters are read. After each of these attempts, the Any Check and WLR

indicators are interrogated, and the appropriate error message typed out if they are not on. The last check of the WLR Check indicator is a test to determine that it is not turned on when the group mark is located properly.

The Address Check Indicator is turned on by reading a sector not on the cylinder at which the access mechanism is position. A check is made that the Any File and The Any Data Check Indicators are on. If they are not, the appropriate error messages are typed out.

The Read-Only Address Routine is entered only if yes was keyed in during the execution of the Control Routine when the question is asked "Check Flag Address". This test required the turning on and off of the Write address and Compare Disable Switches. During the execution of this routine, the Compare Disable and Write Address Switches must be turned on so that flagged addresses can be written on the track. A read disk numerically command is executed and a flag is set over the the first sector address and one address is set out of sequence. After the proper switches have been

turned on, the track is written. Then Instructions are typed out requesting the Write Address and Compare Disable switches to be turned off. When the switches have been turned off, an attempt is made to write on the sector with the flagged address. This should force an address check. If it doesn't, an error message is typed out. Then a read of the track is attempted and the Address Check should be turned on again because the addresses are out of sequence. If the Address Check is not turned on, an error message is typed out. Then the Compare Disable and Write Address Switches must be turned on so that the addresses can be written to their proper configuration. After this is accomplished, the Compare Disable and Write Address Switches must be turned off.

The test complete routine checks program switch 4 to determine if the test is to be looped or not. . If switch 4 is on, the test is looped until switch 4 is turned off. Then program switch 1 is interrogated to see if any error messages were bypassed.

The error map is checked to see if any errors occurred while running the test. If any errors occurred and had been bypassed, this message types out before the test complete message is typed out.

The Error Routine contains the instructions to type out the appropriate error message, sets a digit in the error map, and returns to proper location in the program.

The Reset VRC Routine is entered whenever it is desired to turn off the VRC indicators. It is entered by a Branch and Transmit Immediate instruction and completed by a branch back instruction.

D. ERROR ANALYSIS

RD TK, NO ADRS, ADRS CK IND OFF ER51 01002

This type out occurs in the Address Check Indicator routine if the Address Check Indicator is off, and a read track instruction is used to read a track into memory and no address was read in. Prior to doing the read track instruction, a record mark is set in the address area. This record mark is still in the address area to cause this type out.

ADRS CK IND (36) WONT TURN ON ER52 01146

This type out occurs in the Address Check Indicator routine. The routine attempts to read sector address 00000 from cylinder 97 and should turn on the Address Check Indicator. The failure to turn on indicator 36 results in this type out.

HDS AT CYL XX, SHD BE CYL 97 ER54 01146

This error type out occurs if cylinder 97 is not accessed to when positioning the access mechanism for the Address Check Routine. XX is the cylinder at which the access arm is positioned.

SELECTING WRNG STORAGE DR, DISK PACK SCTR ADRS RANGE X

ER 70 01062

This type out occurs in the Address Check Routine if the wrong module was selected when accessing to cylinder 97 of the module on which the CE Pack is installed, and the module has sector addresses in the range indicated by X, where X can be:



<u>X</u>	<u>Range</u>
1	20000 - 39999
2	40000 - 59999
3	60000 - 79999
4	80000 - 99999

ADRS CK IND 36 OFF ER80 01062, 01146

Address Check Indicator 36 is off.

RD, MBR-E/O, ADS CK, OR WRNG HD RD TK, ON ALL HDS

ER55 01722

This type out occurs in the Locate a "Properly Functioning Head Routine" if a Read, MBRE, MBRO, Address Check occurred while attempting to read all ten heads or the track read did not correspond to the expected track.

This indicates that no head is functioning properly.

HDS AT CYL XX SHD BE CYL YY ER56 01998

This type out occurs while checking the seek operation. The access mechanism is at cylinder XX and should be at cylinder YY. YY will be 11, 22, 33, 44, 55, 66, 77, or 88.

HDS AT CYL XX SHD BE CYL 03 ER61 03558

This type out occurs if the access mechanism is not positioned at cylinder 03 to check write and read back check operations. XX is the cylinder at which the access arm was positioned.

ADRS CK IND WONT TURN ON VIA A WR ON FLG ADRS

ER65 05550

This type out occurs when testing the Read-Only operation. An attempt is made to write on a flagged address, which should turn on the Address Check Indicator, but the Address Indicator was not turned on.

ADRS CK IND WONT TURN ON VIA ADRS NOT INCR BY ONE

ER66 05634

This type out occurs if the File Address Check Indicator was not turned on when reading three sectors whose addresses are not increment by one.

OVFLO CK (38) WONT TURN ON

ER62 04494

This type out occurs if the Overflow Check Indicator (38) is not turned on and Any File (39) is on.

ANY FILE 39 OFF, OVFLO 38 OFF

ER71 04530

This type out occurs if both the Overflow Check Indicator (38) and Any File (39) are not forced on.

ANY FILE 39 OFF, OVFLO 38 ON

ER72 04530

This type out occurs if the Overflow Check Indicator 38 was turned ON, but Overflow failed to turn on Any File.

WLR CK (37) WONT TURN ON VIA RD BK ER

ER63 04686

This type out occurs if a Read Back compare error does not turn on the Wrong Length Record Check Indicator (37), but Any File is on.

ANY FILE 39 OFF, WLR 37 OFF

ER73

04722

This type out occurs if both the Wrong Length Record and Any File Indicators are off when forcing a read back compare error.

ANY FILE 39 OFF, WLR 37 ON

ER74

04722

This type out occurs if the Wrong Length Record Indicator is turned on, but it failed to turn on Any File.

WLR CK (37) WONT TURN ON VIA GM LATE TERM

ER64

04842

This type out occurs if the Wrong Length Record Check Indicator is not turned on by reading a sector with WLR Check with late termination of the Group Mark.

WLR CK (37) WONT TURN ON VIA GM EARLY TERM

ER68

04914

This type out occurs if the Wrong Length Record Check Indicator is not turned on by reading a sector with WLR Check with early termination of the Group Mark.

WLR CK ON, GM CORRECT PLACE, RD SCT WLR

ER67

04962

This type out occurs if the WLR Check is turned on during a read sector operation and the group mark is located correctly.

ANY FILE 39 OFF, ADRS 36 OFF

ER75

05082

This type out occurs if the Address Check Indicator cannot be turned on by reading a sector not on the accessed cylinder.

ANY FILE 39 OFF, ADRS 36 ON

ER76 05082

This type out occurs if the Address Check Indicator does not turn on the Any File Indicator.

ANY DATA ON, ANY FILE OFF

ER77 05190

This type out occurs if the Address Check Indicator is on, Any File Indicator is off, and the Any Data Check is on. Ignore error type out if Address Check is not on.

ANY DATA OFF, ANY FILE ON

ER78 05250

This type out occurs if the Any File Indicator does not turn on the Any Data Check Indicator.

ANY DATA OFF, ANY FILE OFF

ER79 05250

This type out occurs if the Address Check Indicator and the Any File Indicator are both off. Ignore error type out if address check does not turn on Any File.

ERROR OCCURRED BY SWITCH 1 WAS ON THUS NO ETO

ER30 05850

This error typeout will occur in the test complete routine if the user has Switch 1 on and an error occurred during the running of the test.

ETO = Error Type Out.

All other error type out use the following standard format:

AAAAAAA BBBB (XX) CYL ZZ HD Y

## Explanation of code letters:

AAAAAAA, indicates the 1311 operation on which the error occurred, and can be one of the following:

WRITE 20 SCT WLR ER3 03728

The program is writing 20 sectors from memory onto a track on the Disk Pack with Wrong Length Record Check.

READ BK COMP WLR ER4 03834

The program is executing a read back compare of the data previously written on the Disk Pack with Wrong Length Record Check.

READ TK W/O WLR ER5 03066

The program is reading a track of data and addresses from a track on the Disk into memory without Wrong Length Record Check.

RD TK WITH WLR ER5G 03066

The program is reading a track of data and addresses from a track on the Disk into memory with Wrong Length Record Check.

PROG COMPARE ER6 02778, 04050

The program is doing a program compare of the data written with the data read.

WR 20 SCT W/O WLR

ER3G 03728

The program is writing 20 sectors from memory onto a track on the Disk Pack without Wrong Length Record Check.

RD BK CK W/O WLR

ER4G 03834

The program is executing a read back compare of the data previously written on the Disk Pack without Wrong Length Record Check.

RD 20 SCT, WLR

ER6G 03930

The program is reading 20 sectors from the Disk Pack into memory with Wrong Length Record Check.

RD 20 SCT, W/O WLR

ER6GM 03930

The program is reading 20 sectors from the Disk Pack into memory without Wrong Length Record Check.

READ SECTOR W/O WLR

ER5S 02670

The program is reading a sector from the Disk Pack into memory without Wrong Length Record Check.

SEEK

ER8

00870, 01926, 02358, 03486

The program has performed a seek operation.

CYL 3 ZERO RESET

ER9

04182

The program has executed a write and read back check of 20 sectors of data (all zeros) in an attempt to insure a change of data on cylinder 03.

RD TK WLR, ADRS NOT EQ

ER59

03198

The program is checking the read track operation under Wrong Length Record control. The address that was read in was not correct.

RD TK W/O WLR, ADRS NOT EQ

ER60

03198

The program is checking the read track operation without Wrong Length Record Check. The addresses that were read in were not correct.

BBBBBB (XX) can be one of the following:

ADS CK (36)

ER10

05994

WLR CK (37)

ER11

06114

OVFO CK (38)

ER12

06138

RD CK (06)

ER14

06174

WR CK (07)

ER15

06198

MBR-E (16)

ER16

06222

MBR-O (17)

ER17

06246

FILE NO IND (39)

ER13

06138

The program found Any File Indicator on, but all the indicators which turn it on are off.

DATA NOT EQUAL

ER7

04062, 02790

The program compare of the data written and the data read. The data failed to compare.

RD TK X

ER57

02838

The program has read the wrong track, where X is the track that was read.

SELECT LOCK

ER19

05994

CORRECT TK, DATA NOT COMP

ER58

02838

The program is checking the read amplifier. The correct track was read, but the data read into memory fails to compare.

CYL ZZ HD Y

ER20

06354

Indicates which Cylinder (CYL) the error occurred on, where ZZ will be from 00 to 99, and also which head (HD) or track was used, where Y will be from 0 to 9.



**E. SERVICE HINTS:**

A routine has been included in DT 0022 to assist the CE if the customer reports address checks. This routine is designed to verify that the addresses on a cylinder are correct. Since this routine may be used with a customer's pack on the Disk Storage Drive Unit and the other phase of DT 0022 must be used with a CE Pack, CAUTION must be used to not enter any other portion of DT 0022 until the CE Pack has been installed.

To enter the routine to check sector address, DT 0022 must be loaded. Then the user must insert and execute a 49 06042. The routine will request the module number and a two (2) digit cylinder number and a one (1) digit address range.

1 digit address range	Sector address
0	00000 - 19999
1	20000 - 39999
2	40000 - 59999
3	60000 - 79999

The program reads the tracks and checks the sector addresses read with what should have been read.

Error typeout:

XXXXX S/B YYYY

XXXXX is the sector address read from disk.  
YYYYY is what should have been read in.

Switch 2 on, will loop the checking of the cylinder.

1311 DISK DIAGNOSTIC TEST 0022

FLOWCHART

Read Flowchart from left side of Page 26 to right side of Page 27. Note that A on Page 26 connects to A on Page 27 and B on Page 26 connects to B on Page 27, Etc.

00402

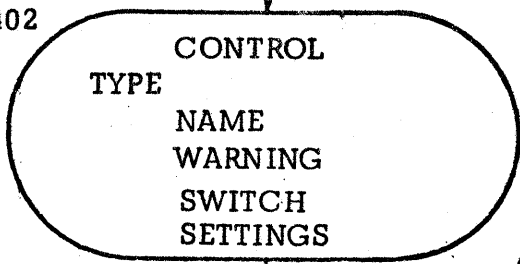

00618

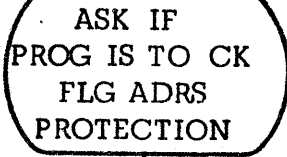

00750

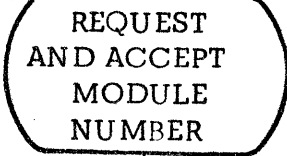

00930

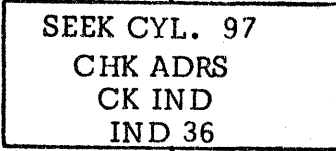

ON

2

OFF

01530



ON

2

OFF

01986

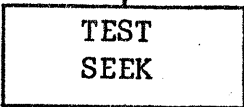

02418

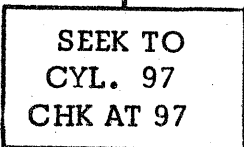

A

B

02670



ON

2

OFF

03042

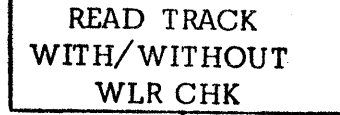

ON

2

OFF

03426

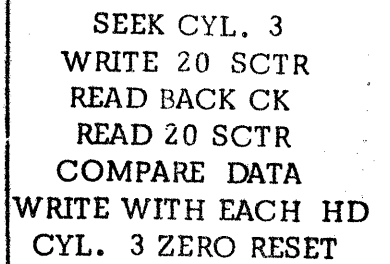

ON

2

OFF

04506

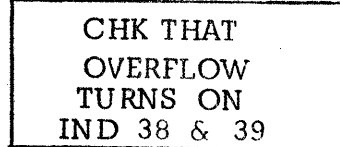

04662

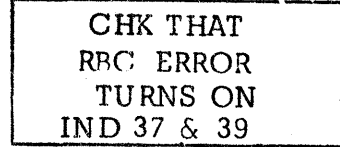

04854

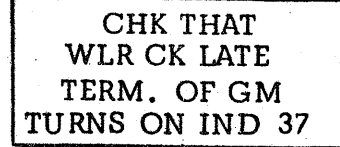

D

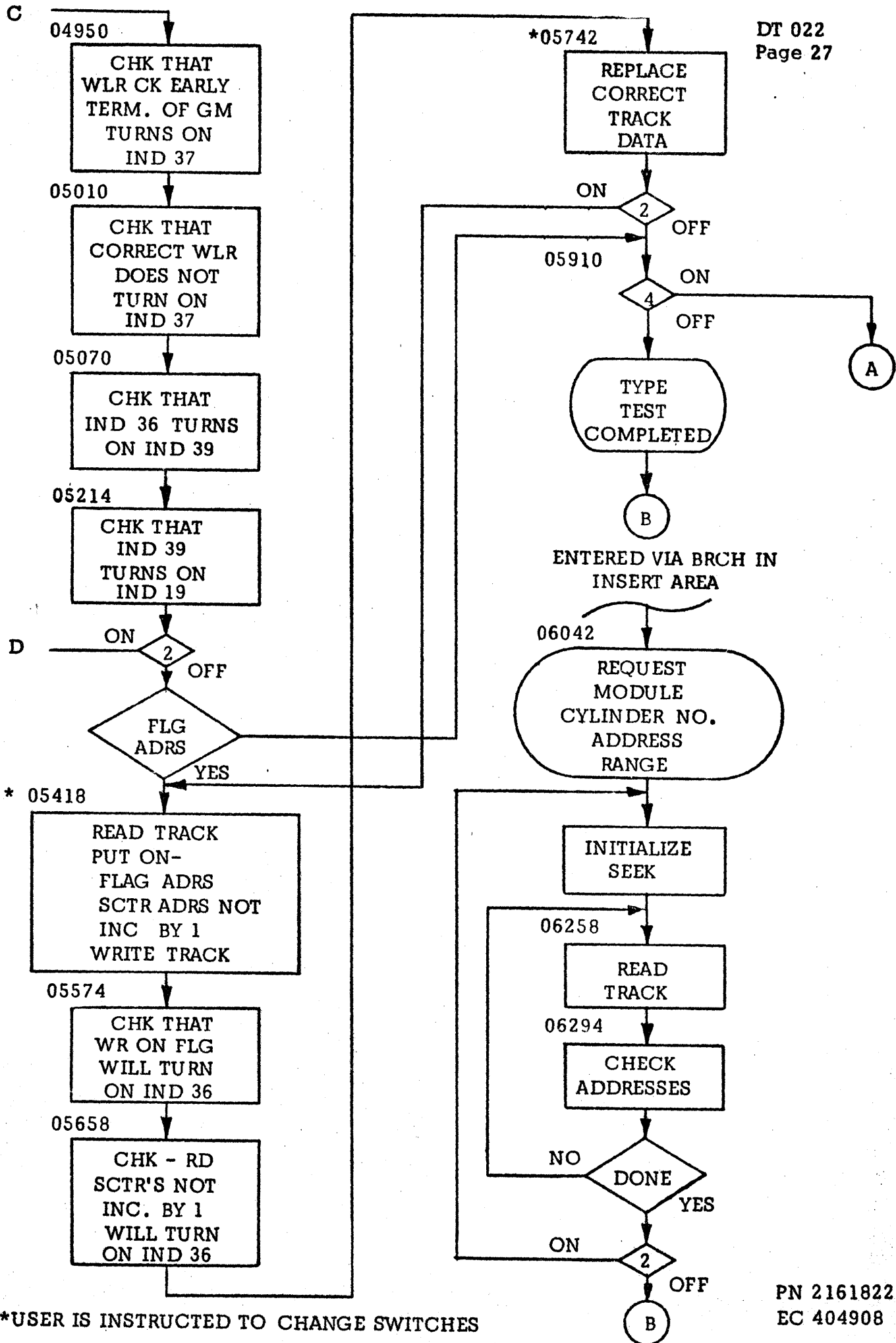

\*USER IS INSTRUCTED TO CHANGE SWITCHES

DT 0022  
Page 28

SAMPLE OUTPUT FOR DT 0022

DT 0022 - 1311 FAULT ISOLATION  
WARNING-REMOVE CUSTOMER DISK PACKS  
FROM ALL MODULES, TURN SW 3 ON.  
SW 3 ON FOR CORRECTING KEY IN  
SWITCH SETTINGS  
PROGRAM - AS DESIRED  
DATA -- PROGRAM  
CK FLG ADRS, TYPE YES OR NONCR-S  
KEY IN 1 DIGIT MODULE NO. DISK PACK IS ON CR-S  
TEST COMPLETED

P/N 2161822  
EC 404908

00010\*  
00020\* 1311 FILE DIAGNOSTIC  
00030\*  
00040\* DT 0022 - FAULT ISOLATION  
00050\*  
00060\*  
00070\*  
00080\*

CONTROL ROUTINES

00100 S	DORG 00402		00402		
00110	B **12,,,	RESTART BRANCH	00402	49	00414 00000
00120	RCTY ,,,	RET CARR	00414	34	00000 00102
12345	WATY T1,,,	TYPE TEST NAME	00426	39	07987 00100
12345	RCTY		00438	34	00000 00102
12345	WATY WRCD1,,,	REMOVE DISK	00450	39	08049 00100
12345	RCTY		00462	34	00000 00102
12345	WATY WRCD2,,,	PACKS	00474	39	08119 00100
12345	BNC3 *,,,	WAIT TILL SW 3 IS ON	00486	47	00486 00300

TYPE OUT SWITCH SETTINGS

00130*					
00140*					
00150*					
00160	RCTY ,,,	RET CARR	00498	34	00000 00102
00170	WATY T30,,,	TYPE SW3 ON	00510	39	08635 00100
00180	RCTY ,,,	RET CARR	00522	34	00000 00102
00190	WATY T2,,,	T/O SW SETTINGS	00534	39	08181 00100
00200	RCTY ,,,	RET CARR	00546	34	00000 00102
00210	WATY T3,,,	T/O SENSE - OFF	00558	39	08213 00100
00220	RCTY ,,,	RET CARR	00570	34	00000 00102
00230	WATY T4,,,	T/O DATA - PROG	00582	39	08255 00100
00240	TDM NOPAD+1,1,,	INSURE NOP	00594	15	00883 00001
00250*	H ,,,	HALT	00606	48	00000 00000

ASK IF PROGRAM IS TO CHECK  
FLAGGED ADDRESS PROTECTION

00260*					
00270*					
00280*					
00290	RCTY ,,,	RET CARR	00618	34	00000 00102
00300	WATY T6,,,	CK FLG ADRS	00630	39	08373 00100
00310	RATY ANS,,,	ACCEPT ANSWER	00642	37	11675 00100
00320	BC3 *-12,,,	SW 3 ON TYP AGN	00654	46	00642 00300
00330	SF ANS-1,,,	SET FLAG	00666	32	11674 00000
00340	CM ANS,68,10,	CK FOR YES	00678	14	11675 00008
00350	BNE **36,,,	BRCH NOT EQUAL	00690	47	00726 01200
00360	TD TSM,RM,,	PUT RM IN MAP	00702	25	11673 11654
00370	B **24,,,	SKIP NEXT INST	00714	49	00738 00000
00380	TDM TSM,00,,	CLEAR MAP	00726	15	11673 00000
00390	TFM S+6,*,,	LOAD RESTART	00738	16	00408 -0738

REQUEST AND ACCEPT THE  
MODULE NUMBER THAT  
DISK PACK IS ON

00400*					
00410*					
00420*					
00430*					
00440*					
06240 SAD1	RCTY		00750	34	00000 00102
00460	WATY T5,,,	RQT MOD NO.	00762	39	08287 00100

00470	RNTY N,,,	ACCEPT NO.	00774 36 11643 00100
00480	BC3 *-12,,,	SW3 ON,KEY AGAIN	00786 46 00774 00300
00490*			
00500*	COMPUTE DRIVE CODE DIG FROM		
00510*	MOD NO.AND LOAD SUB-INST		
00520*	AND STORE MATH TABLES		
00530*			
00540	MM N,2,10,	DOUBLE MOD NO.	00798 13 11643 000-2
00550	AM 99,01,8,	ADD ONE	00810 11 00099 0-001
00560	TD M,99,,	STORE DRIVE CODE	00822 25 11647 00099
00570	TD S1,M,,	LOAD SUB-INST	00834 25 12090 11647
00580	TD S2,M,,	LOAD SUB-INST	00846 25 12104 11647
00590	TD S3,M,,	LOAD SUB-INST	00858 25 12118 11647
00600	TR TAB,00100,,	STORE MATH TABLES	00870 31 11786 00100
06210 NOPAD	NOP SAD		00882 41 06342 00000
00610	TFM S+6,*,,	LOAD RESTART	00894 16 00408 -0894
00620*			
00630*	RESET THE INDICATORS THAT		
00640*	TURN ON ANY DATA CHECK		
00650*			
00660 J0	BNI **24,01900,,	ANY DATA CK	00906 47 00930 01900
00670	BTM RS,*,,	BRCH TO SUB-ROUT	00918 17 07744 -0918
00680*			
00690*	THIS ROUTINE SEEKS CYLINDER 97		
00700*	AND CHECKS ADRS CK INDICATOR		
00710*			
00720 J1	TFM S2+5,19400,,	INIT SUB-INST	00930 16 12109 J9400
00730	TFM S2+8,001,9,	INIT SCTR CNT	00942 16 12112 00-01
00740	K S2,00701,,	SEEK CYLINDER 97	00954 34 12104 00701
00750	BNI **48,01900,,	ANY DATA CHECK	00966 47 01014 01900
00760	TFM ERR+18,*-24,,	LOAD RETURN	00978 16 07198 -0954
00770	TFM E1+6,ER8,,	LOAD OPERATION	00990 16 07642 -8891
00780	B ERR,,,	BRCH TO ER ROUT	01002 49 07180 00000
00790	TFM S2+5,00000,,	INIT SUB-INST	01014 16 12109 -0000
00800 J4	RN S2,00702,,	READ SECTOR	01026 36 12104 00702
00810 J3	BI J5,03600,,	ADDRESS CK	01038 46 01326 03600
00820	TFM S2+8,020,9,	INIT SUB-INST	01050 16 12112 00-20
00830	TF A2+5,RM,,	PUT RM IN A2 ADS	01062 26 14416 11654
00840	RN S2,00706,,	READ TRACK	01074 36 12104 00706
00850	BNR **36,A2+5,,	CK FOR RM IN A2	01086 45 01122 14416
00860	BTM ET,ER51,,	BRCH,LOAD ER T/O	01098 17 07888 -9495
00870	B J1,,,	TRY AGAIN	01110 49 00930 00000
00880	SF A2+1,,,	SET FLAG	01122 32 14412 00000
00890	MM A2+3,05,10,	MULTIPLY BY 5	01134 13 14414 000-5
00900	BD **24,096,,	BRCH DIGIT	01146 43 01170 00096
00910	B **60,,,	BYPASS	01158 49 01218 00000
00920	TD ER70+104,96,,	LOAD SCTR RANGE	01170 25 10711 00096
00930	BTM ET,ER70,,	BRCH,LOAD ER T/O	01182 17 07888 J0607
00940	BTM ET,ER80,,	BRCH,LOAD ER T/O	01194 17 07888 J1197
00950	B J1,,,	TRY AGAIN	01206 49 00930 00000
00960	CM 99,970,,	IS IT CYL 97	01218 14 00099 -0970
00970	BNE **36,,,	BRCH IF NOT EQ	01230 47 01266 01200
00980	BTM ET,ER52,,	BRCH,LOAD ER T/O	01242 17 07888 -9555

00990	B	J1,,,	TRY AGAIN	01254	49	00930	00000	
01000	TD	ER54+22,97,,	LOAD CYL NO.	01266	25	09637	00097	
01010	TD	ER54+24,98,,	LOAD CYL NO.	01278	25	09639	00098	
01020	BTM	ET,ER54,,	BRCH,LOAD ER T/O	01290	17	07888	-9615	
01030	BTM	ET,ER80,,	BRCH,LOAD ER T/O	01302	17	07888	J1197	
01040	B	J1,,,	TRY AGAIN	01314	49	00930	00000	
01050	J5	TFM	S2+8,020,9,	INIT SUB-INST	01326	16	12112	00-20
01060	RN	S2,00706,,	READ TRACK	01338	36	12104	00706	
01070	SF	A2+1,,,	SET FLAG	01350	32	14412	00000	
01080	MM	A2+3,05,10,	MULTIPLY BY 5	01362	13	14414	000-5	
01090	BD	*+24,096,,	BRCH DIGIT	01374	43	01398	00096	
01100	B	*+48,,,	BYPASS	01386	49	01434	00000	
01110	TD	ER70+104,96,,	LOAD SCTR RANGE	01398	25	10711	00096	
01120	BTM	ET,ER70,,	BRCH,LOAD ER T/O	01410	17	07888	J0607	
01130	B	J1,,,	TRY AGAIN	01422	49	00930	00000	
01140	CM	99,970,,	IS IT CYL 97	01434	14	00099	-0970	
01150	BE	*+60,,,	BRCH IF EQUAL	01446	46	01506	01200	
01160	TD	ER54+22,97,,	LOAD CYL NO.	01458	25	09637	00097	
01170	TD	ER54+24,98,,	LOAD CYL NO.	01470	25	09639	00098	
01180	BTM	ET,ER54,,	BRCH,LOAD ER T/O	01482	17	07888	-9615	
01190	B	J1,,,	TRY AGAIN	01494	49	00930	00000	
01200	TFM	S+6,*,,	LOAD RESTART	01506	16	00408	-1506	
01210	BC2	J1,,,	SW2 ON REPEAT	01518	46	00930	00200	
01220*								
01230*		THIS ROUTINE ATTEMPTS TO FIND						
01240*		A GOOD HD TO TEST OUT SEEKS						
01250*								
01260	BNI	*+24,01900,,	ANY DATA CK	01530	47	01554	01900	
01270	BTM	RS,*,,	RESET INDICATORS	01542	17	07744	-1542	
01280	J6	TFM	S2+5,19400,,	INIT SUB-INST	01554	16	12109	J9400
01290	TFM	S2+8,001,9,	INIT SUB-INST	01566	16	12112	00-01	
01300	TDM	A2,00,11,	SET FLG ZERO	01578	15	14411	0000-	
01310	TFM	J7+11,TD+1,,	INITIALIZE	01590	16	01733	J1687	
01320	J9	TFM	M1,00000,,	RESET ERROR MAP	01502	16	11652	-0000
01330	RN	S2,00702,,	READ SECTOR	01614	36	12104	00702	
01340	BNI	*+24,00600,,	READ CHECK	01626	47	01650	00600	
01350	TDM	M1-2,01,,	PUT DIG IN MAP	01638	15	11650	00001	
01360	BNI	*+24,01600,,	MBR-E CK	01650	47	01674	01600	
01370	TDM	M1-1,01,,	PUT DIG IN MAP	01662	15	11651	00001	
01380	BNI	*+24,01700,,	MBR-O CK	01674	47	01698	01700	
01390	TDM	M1-1,01,,	PUT DIG IN MAP	01686	15	11651	00001	
01400	BNI	*+24,03600,,	ADRS CK IND	01698	47	01722	03600	
01410	TDM	M1,01,,	PUT DIG IN MAP	01710	15	11652	00001	
01420	J7	TD	*+23,99999,,	LOAD COMPARE	01722	25	01745	99999
01430	CM	A2+1,00000,10,	COMPARE HD NO.	01734	14	14412	000-0	
01440	BE	*+24,,,	BRCH IF EQUAL	01746	46	01770	01200	
01450	TDM	M1-3,01,,	PUT DIG IN MAP	01758	15	11649	00001	
01460	CM	M1,00000,,	IS MAP ALL ZEROS	01770	14	11652	-0000	
01470	BE	J8,,,	BRCH IF EQUAL	01782	46	01878	01200	
01480	CM	S2+5,19580,,	SEE IF DONE	01794	14	12109	J9580	
01490	BE	*+48,,,	BRCH IF EQUAL	01806	46	01854	01200	
01500	AM	S2+5,00020,,	UPDATE	01818	11	12109	-0020	
01510	AM	J7+11,010,,	UPDATE	01830	11	01733	-0010	



01520	B	J9,,,	TRY NEXT HEAD	01842	49	01602	00000
01530	BTM	ET,ER55,,	BRCH,LOAD ER T/O	01854	17	07888	-9671
01540	B	J6,,,	TRY AGAIN	01866	49	01554	00000
01550	J8	TFM	S+6,*,,	LOAD RESTART	01878	16	00408 -1878
01560	BC2	J6-24,,,	LOOP ROUTINE	01890	46	01530	00200
01570*							
01580*							
01590*							
01600*							
01610	MM	S2+4,05,10,	MULTIPLY	01902	13	12108	000-5
01620	TD	*+23,98,,	LOAD MULT.	01914	25	01937	00098
01630	J14	MM	C2,00000,10,	MULTIPLY	01926	13	11661 000-0
01640	TF	C3,C1,,	LOAD CYL 11	01938	26	11671	11666
01650	A	C3-1,99,,	ADD CORRECT HD	01950	21	11670	00099
01660	BNI	*+24,01900,,	ANY DATA CHECK	01962	47	01986	01900
01670	BTM	RS,*,,	RESET INDICATORS	01974	17	07744	-1974
01680*							
01690*							
01700*							
01710*							
			THIS ROUTINE TESTS THE				
			SEEK OPERATIONS				
01720	TF	S2+5,C3,,	LOAD SUB-INST	01986	26	12109	11671
01730	TFM	S2+8,001,9,	LOAD SUB-INST	01998	16	12112	00-01
01740	J11	K	S2,00701,,	SEEK CYLINDER	02010	34	12104 00701
01750	BNI	*+48,01900,,	ANY DATA CHECK	02022	47	02070	01900
01760	TFM	ERR+18,*-24,,	LOAD RETURN	02034	16	07198	-2010
01770	TFM	E1+6,ER8,,	LOAD OPERATION	02046	16	07642	-8891
01780	B	ERR,,,	BRCH TO ER ROUT	02058	49	07180	00000
01790	RN	S2,00702,,	READ SECTOR	02070	36	12104	00702
01792	BI	*+12,00600		02082	46	02094	00600
01794	BI	*+12,01600		02094	46	02106	01600
01796	BI	*+12,01700		02106	46	02118	01700
01800	BNI	J10,03600,,	ADRS CHECK	02118	47	02250	03600
01810	TFM	S2+8,020,9,	LOAD SUB-INST	02130	16	12112	00-20
01820	RN	S2,00706,,	READ TRACK	02142	36	12104	00706
01830	MM	S2+4,05,,	MULTIPLY BY 5	02154	13	12108	-0005
01840	TD	ER56+50,96,,	LOAD CYL NO.	02166	25	09817	00096
01850	TD	ER56+52,97,,	LOAD CYL NO.	02178	25	09819	00097
01860	MM	A2+4,05,,	MULTIPLY BY 5	02190	13	14415	-0005
01870	TD	ER56+22,96,,	LOAD CYL NO.	02202	25	09789	00096
01880	TD	ER56+24,97,,	LOAD CYL NO.	02214	25	09791	00097
01890	BTM	ET,ER56,,	BRCH,LOAD ER T/O	02226	17	07888	-9767
01900	B	J11-12,,,	TRY AGAIN	02238	49	01998	00000
01910	J10	CM	S2+2,017,10,	SEE IF DONE	02250	14	12106 000J7
01920	BNL	*+36,,,	BRCH IF EQUAL	02262	46	02298	01300
01930	AM	S2+5,02200,,	UPDATE-NEXT CYL	02274	11	12109	-2200
01940	B	J11,,,	TRY NEXT CYL	02286	49	02010	00000
01950	TFM	S+6,*,,	LOAD RESTART	02298	16	00408	-2298
01960	BC2	J11-24,,,	SW2 ON LOOP BK	02310	46	01986	00200
01970*							
01980*							
01990*							
02000*							
02010*							
			THIS ROUTINE TESTS THAT				
			HEADS ARE WORKING PROPERLY				
			FIRST GENERATE TEST DATA				

02020*	SF	TD,,,	SET FLAG	02322	32	11686	00000
02030	TFM	*+30,A1+100,,	INITIALIZE	02334	16	02364	J2409
02040	TFM	*+30,A1+1,,	INITIALIZE	02346	16	02376	J2310
02050	TF	99999,TD+99,,	PUT DATA IN A1	02358	26	99999	11785
02060	CF	99999,,,	CLEAR FLAG	02370	33	99999	00000
02070	CM	*-18,A1+2000,,	SEE IF DONE	02382	14	02364	J4309
02080	BE	*+48,,,	BRCH IF EQUAL	02394	46	02442	01200
02090	AM	*-42,100,,	UPDATE	02406	11	02364	-0100
02100	AM	*-42,100,,	UPDATE	02418	11	02376	-0100
02110	B	*-72,,,	LOAD NEXT SECTOR	02430	49	02358	00000
02120	TFM	S+6,*,,	LOAD RESTART	02442	16	00408	-2442
02130							
02140*							
02150*		SEEK CYLINDER 97 FOR ATTEMPTED					
02160*		READ WITH EACH HEAD					
02170*							
02180 J15	TFM	S2+5,19400,,	INITIALIZE	02454	16	12109	J9400
02190	TFM	S2+8,001,9,	SET UP SCTR CNT	02466	16	12112	00-01
02200	K	S2,00701,,	SEEK CYLINDER 97	02478	34	12104	00701
02210	BNI	*+48,01900,,	ANY DATA CHECK	02490	47	02538	01900
02220	TFM	ERR+18,*-24,,	LOAD RETURN	02502	16	07198	-2478
02230	TFM	E1+6,ER8,,	LOAD OPERATION	02514	16	07642	-8891
02240	B	ERR,,,	BRCH TO ER ROUT	02526	49	07180	00000
02250	RN	S2,00702,,	READ SECTOR	02538	36	12104	00702
02260	BNI	J17-24,03600,,	ADRS CHECK	02550	47	02706	03600
02270	TFM	S2+8,020,9,	SET UP SCTR CNT	02562	16	12112	00-20
02280	TFM	S2+5,19400,,	RESET ADDRESS	02574	15	12109	J9400
02290	TD	*+23,J14+11,,	PUT DIG IN MULT	02586	25	02609	01937
02300	MM	C2,00000,10,	MULTIPLY	02598	13	11661	000-0
02310	A	S2+4,99,,	ADD CORRECT HD	02610	21	12108	00099
02320	RN	S2,00706,,	READ TRACK	02622	36	12104	00706
02330	SF	A2+1,,,	SET FLAG	02634	32	14412	00000
02340	MM	A2+3,05,10,	MULTIPLY BY 5	02646	13	14414	000-5
02350	TD	ER54+22,97,,	LOAD	02658	25	09637	00097
02360	TD	ER54+24,98,,	CYLINDER	02670	25	09639	00098
02370	BTM	ET,ER54,,	BRCH,LOAD ER T/O	02682	17	07888	-9615
02380	B	J15,,,	TRY AGAIN	02694	49	02454	00000
02390*							
02400*		CLEAR READ IN AREA					
02410*							
02420	BNI	*+24,01900,,	ANY DATA CHECK	02706	47	02730	01900
02430	BTM	RS,*,,	RESET INDICATORS	02718	17	07744	-2718
02440 J17	TFM	*+18,A2+100,,	INITIALIZE	02730	16	02748	J4511
02450	TFM	99999,,,	LOAD ZEROS	02742	16	99999	-0000
02460	SM	*-6,4,,	SUBTRACT	02754	12	02748	-0004
02470	CM	*-18,A2,,	SEE IF DONE	02766	14	02748	J4411
02480	BNE	*-36,,,	BRCH NOT EQUAL	02778	47	02742	01200
02490*							
02500*		READ SECTOR INTO AREA A2					
02510*							
02520 J13	RN	S2,00702,,	READ SECTOR	02790	36	12104	00702
02530	BNI	*+48,01900,,	ANY DATA CHECK	02802	47	02850	01900
02540	TFM	ERR+18,J16,,	LOAD RETURN	02814	16	07198	-3006

02550	TFM	E1+6,ER5S,,	LOAD ER T/O	02826	16	07642	-9453
02560	B	ERR,,,	BRCH TO ER ROUT	02838	49	07180	00000
02570*							
02580*		PROGRAM COMPARE OF DATA READ					
02590*							
02600	MM	S2+4,05,,	MULTIPLY BY 5	02850	13	12108	-0005
02610	TD	A1+1,98,,	LOAD HD DIGIT	02862	25	12310	00098
02620	TDM	A1,00,11,	SET FLAG	02874	15	12309	0000-
02630	TDM	A2,00,11,	SET FLAG	02886	15	14411	0000-
02640	C	A1+100,A2+100,,	COMPARE	02898	24	12409	14511
02650	BE	J16,,,	BRCH IF EQUAL	02910	46	03006	01200
02660	C	A1+1,A2+1,,	COMPARE HD	02922	24	12310	14412
02670	TFM	ERR+18,J16,,	LOAD RETURN	02934	16	07198	-3006
02680	TFM	E1+6,ER6,,	LOAD ER T/O	02946	16	07642	-8633
02690	BE	*+36,,,	BRCH IF EQUAL	02958	46	02994	01200
02700	TDM	ER57+12,A2+1,,	INSERT HD NO.	02970	15	09835	14412
02710	BTM	ETO,ER57,,	BRCH,LOAD ER T/O	02982	17	07552	-9823
02720	BTM	ETO,ER58,,	BRCH,LOAD ER T/O	02994	17	07552	-9841
02730	J16	CM	S2+5,19580,,	03006	14	12109	J9580
02740	BE	*+36,,,	BRCH IF EQUAL	03018	46	03054	01200
02750	AM	S2+5,00020,,	UPDATE	03030	11	12109	-0020
02760	B	J17,,,	NEXT HEAD	03042	49	02730	00000
02770	TFM	S+6,*,,	LOAD RESTART	03054	16	00408	-3054
02780	BC2	J15,,,	SW2 ON LOOP	03066	46	02454	00200
02790*							
02800*		THIS ROUTINE CHECKS THAT THE					
02810*		DISK OPERATIONS WORK CORRECTLY					
02820*							
02830*		READ TK WITH AND W/O WLR CK					
02840*							
02850	J20	BNI	*+24,01900,,	03078	47	03102	01900
02860		BTM	RS,*,,	03090	17	07744	-3090
02870		TDM	A2+2101,0,,	03102	15	16512	00000
02880		TDM	J19+11,06,,	03114	15	03197	00006
02890		TFM	S2+8,020,9,,	03126	16	12112	00-20
02900		TFM	S2+5,19400,,	03138	16	12109	J9400
02910		TD	*+23,J14+11,,	03150	25	03173	01937
02920		MM	C2,00,10,	03162	13	11661	000-0
02930		A	S2+4,99,,	03174	21	12108	00099
02940	J19	RN	S2,00706,,	03186	36	12104	00706
02950		BNI	*+84,01900,,	03198	47	03282	01900
02960		TFM	ERR+18,J18,,	03210	16	07198	-3378
02970		55	*+36,A2+2101,,	03222	55	03258	16512
02980		TFM	E1+6,ER5G,,	03234	16	07642	-8801
02990		B	ERR,,,	03246	49	07180	00000
03000		TFM	E1+6,ER5,,	03258	16	07642	-8767
03010		B	ERR,,,	03270	49	07180	00000
03020		AM	S2+5,00019,,	03282	11	12109	-0019
03030		SF	A2+1996,,,	03294	32	16407	00000
03040		C	A2+2000,S2+5,,	03306	24	16411	12109
03050		BE	J18,,,	03318	46	03378	01200
03060		55	*+36,A2+2101,,	03330	55	03366	16512
03070		BTM	ET,ER59,,	03342	17	07888	-9893

03080	B	J18,,,	NEXT OPERATION	03354	49	03378	00000
03090	BTM	ET,ER60,,	BRCH,LOAD ER T/O	03366	17	07888	-9937
03100 J18	55	*+24,A2+2101,,	CK FOR GM	03378	55	03402	16512
03110	B	*+48,,,	DONE	03390	49	03438	00000
03120	TD	A2+2101,GM,,	PUT IN GM	03402	25	16512	11655
03130	TDM	J19+11,04,,	CHANGE INST	03414	15	03197	00004
03140	B	J19-48,,,	TRY NEXT OP	03426	49	03138	00000
03150	TFM	S+6,*,,	RELOAD RESTART	03438	16	00408	-3438
03160	BC2	J20,,,	SW2 ON LOOP	03450	46	03078	00200
03170*							
03180*							
03190*							
03200*							
03210*							
03220*							
03230	BNI	*+24,01900,,	ANY DATA CK	03462	47	03486	01900
03240	BTM	RS,*,,	RESET INDICATORS	03474	17	07744	-3474
03250 K2	TFM	S1+8,020,9,	SECTOR CNT	03486	16	12098	00-20
03260	TDM	K4+11,02,,	INIT	03498	15	03869	00002
03270	TDM	K6+11,03,,	INIT	03510	15	03965	00003
03280	TDM	K7+11,02,,	INIT	03522	15	04061	00002
03290	TDM	A1+2001,0,,	CLEAR GM	03534	15	14310	00000
03300	TDM	A2+2001,0,,	CLEAR GM	03546	15	16412	00000
03310 K8	TFM	S1+5,00600,,	LOAD SUB INST	03558	16	12095	-0600
03320	TFM	S2+5,00600,,	LOAD SUB INST	03570	16	12109	-0600
03330	TFM	K3+23,TD+1,,	INIT	03582	16	03845	J1687
03340	TFM	S2+8,001,9,	SECTOR CNT	03594	16	12112	00-01
03350	K	S2,00701,,	SEEK CYL 3	03606	34	12104	00701
03360	BNI	*+48,01900,,	ANY DATA CHECK	03618	47	03666	01900
03370	TFM	ERR+18,*-24,,	LOAD RETURN	03630	16	07198	-3606
03380	TFM	E1+6,ER8,,	LOAD OPERATION	03642	16	07642	-8891
03390	B	ERR,,,	BRCH TO ER ROUT	03654	49	07180	00000
03400	RN	S2,00702,,	READ A SECTOR	03666	36	12104	00702
03410	BNI	K3,03600,,	ADRS CK	03678	47	03822	03600
03420	TFM	S2+8,020,9,	CHNG SECT CNT	03690	16	12112	00-20
03430	TD	*+23,J14+11,,	LOAD MULT	03702	25	03725	01937
03440	MM	C2,00,10,,	MULTIPLY	03714	13	11661	000-0
03450	A	S2+4,99,,	ADD CORRECT HD	03726	21	12108	00099
03460	RN	S2,00706,,	RD TK	03738	36	12104	00706
03470	SF	A2+1,,,	SET FLG	03750	32	14412	00000
03480	MM	A2+3,05,10,	MULT BY 5	03762	13	14414	000-5
03490	TD	ER61+22,97,,	LOAD	03774	25	10011	00097
03500	TD	ER61+24,98,,	CYL NO.	03786	25	10013	00098
03510	BTM	ET,ER61,,	BRCH,LOAD ER T/O	03798	17	07888	-9989
03520	B	K2,,,	TRY AGAIN	03810	49	03486	00000
03530*							
03540*							
03550*							
03560 K3	TFM	S2+8,020,9,	INIT SCT CNT	03822	16	12112	00-20
03570	TD	A1+1,99999,,	LOAD HD DIG	03834	25	12310	99999
03580	AM	*-1,10,,	UPDATE	03846	11	03845	-0010
03590 K4	WN	S1,00702,,	WRITE 20 SECT	03858	38	12090	00702
03600	BNI	*+84,01900,,	ANY DATA CHECK	03870	47	03954	01900

03610	TFM	ERR+18,K5,,	LOAD RETURN	03882	16	07198	-4230
03620	55	*+36,A1+2001,,	CK FOR GM	03894	55	03930	14310
03630	TFM	E1+6,ER3,,	LOAD ER T/O	03906	16	07642	-8695
03640	B	ERR,,,	GO TO ER ROUT	03918	49	07180	00000
03650	TFM	E1+6,ER3G,,	LOAD ER T/O	03930	16	07642	-9311
03660	B	ERR,,,	GO TO ER ROUT	03942	49	07180	00000
03670*							
03680*		READ BACK CHECK					
03690*							
03700 K6	RN	S1,00703,,	RD BK CK	03954	36	12090	00703
03710	BNI	*+84,01900,,	ANY DATA CK	03966	47	04050	01900
03720	TFM	ERR+18,K5,,	LOAD RETURN	03978	16	07198	-4230
03730	55	*+36,A1+2001,,	CK FOR GM	03990	55	04026	14310
03740	TFM	E1+6,ER4,,	LOAD ER T/O	04002	16	07642	-8731
03750	B	ERR,,,	GO TO ER ROUT	04014	49	07180	00000
03760	TFM	E1+6,ER4G,,	LOAD ER T/O	04026	16	07642	-9349
03770	B	ERR,,,	GO TO ER ROUT	04038	49	07180	00000
03780*							
03790*		READ DATA INTO AREA A2					
03800*							
03810 K7	RN	S2,00702,,	RD 20 SECT	04050	36	12104	00702
03820	BNI	*+84,01900,,	ANY DATA CK	04062	47	04146	01900
03830	TFM	ERR+18,K5,,	LOAD RETURN	04074	16	07198	-4230
03840	55	*+36,A2+2001,,	CK FOR GM	04086	55	04122	16412
03850	TFM	E1+6,ER6G,,	LOAD ER T/O	04098	16	07642	-9385
03860	B	ERR,,,	BRCH TO ER ROUT	04110	49	07180	00000
03870	TFM	E1+6,ER6GM,,	LOAD ER T/O	04122	16	07642	-9415
03880	B	ERR,,,	GO TO ER ROUT	04134	49	07180	00000
03890*							
03900*		PROGRAM COMPARE OF DATA READ					
03910*		WITH DATA THAT WAS WRITTEN					
03920*							
03930	SF	A1+1,,,	SET FLAG	04146	32	12310	00000
03940	SF	A2+1,,,	SET FLAG	04158	32	14412	00000
03950	C	A1+2000,A2+2000,,	COMPARE DATA	04170	24	14309	16411
03960	BE	K5,,,	BRCH IF EQUAL	04182	46	04230	01200
03970	TFM	ERR+18,K5,,	LOAD RETURN	04194	16	07198	-4230
03980	TFM	E1+6,ER6,,	LOAD ER T/O	04206	16	07642	-8833
03990	BTM	ETO,ER7,,	BRCH,LOAD ER T/O	04218	17	07552	-8861
04000 K5	CM	S1+5,00780,,	CK DONE	04230	14	12095	-0780
04010	BE	*+48,,,	BRCH IF DONE	04242	46	04290	01200
04020	AM	S1+5,20,,	UPDATE	04254	11	12095	-0020
04030	AM	S2+5,20,,	UPDATE	04266	11	12109	-0020
04040	B	K3+12,,,	NEXT HEAD	04278	49	03834	00000
04050	TFM	S3+5,00600,,	INIT SECTOR ADRS	04290	16	12123	-0600
04060	WN	S3,00702,,	RESET CYL. 3	04302	38	12118	00702
04070	RN	S3,00703,,	READ BACK COMPARE	04314	36	12118	00703
04080	BNI	*+60,1900,,	ANY DATA CHECK	04326	47	04386	01900
04090	TFM	ERR+18,*+48,,	LOAD RETURN	04338	16	07198	-4386
04100	TFM	E1+6,ER9,,	LOAD ER T/O	04350	16	07642	-8903
04110	TF	S2+5,S3+5,,	STORE SCTR ADRS	04362	26	12109	12123
04120	B	ERR,,,	GO TO ER SUBROUT	04374	49	07180	00000
04130	AM	S3+5,20,,	UPDATE SCTR ADRS	04386	11	12123	-0020

04140	CM	S3+5,00800,,	CHK DONE	04398	14	12123	-0800
04150	BNE	*-108,,,	BRCH IF NOT	04410	47	04302	01200
04160	55	*+24,A1+2001,,	CK FOR GM	04422	55	04446	14310
04170	B	K9,,,	BRCH DONE	04434	49	04518	00000
04180	TD	A1+2001,GM,,	INSERT GM	04446	25	14310	11655
04190	TD	A2+2001,GM,,	INSERT GM	04458	25	16412	11655
04200	TDM	K4+11,00,,	CHANGE INST	04470	15	03869	00000
04210	TDM	K6+11,01,,	FOR	04482	15	03965	00001
04220	TDM	K7+11,00,,	WLR CK	04494	15	04061	00000
04230	B	K8,,,	TRY WITH WLR CK	04506	49	03558	00000
04240 K9	TFM	S+6,*,,	LOAD RESTART	04518	16	00408	-4518
04250	BC2	K2,,,	SW 2 ON LOOP	04530	46	03486	00200
04260*							
04270*							
04280*							
04290*							
04300*							
04310*							
04320 F2	BNI	*+24,01900,,	ANY DATA CHECK	04542	47	04566	01900
04330	BTM	RS,*,,	RESET IND	04554	17	07744	-4554
04340	TFM	S2+8,021,9,	INIT SECT CNT	04566	16	12112	00-21
04350	TFM	S2+5,00780,,	INIT SUB-INST	04578	16	12109	-0780
04360	RN	S2,00702,,	RD 21 SECTORS	04590	36	12104	00702
04370	BNI	*+48,03900,,	CK ANY FILE IND	04602	47	04650	03900
04380	BI	F1,03800,,	CK OVFL0 IND	04614	46	04698	03800
04390	BTM	ET,ER62,,	BRCH,LOAD ER T/O	04626	17	07888	J0045
04400	B	F1,,,	BRCH-NEXT ROUT	04638	49	04698	00000
04410	BI	*+36,03800,,	CK OVFLOW	04650	46	04686	03800
04420	BTM	ET,ER71,,	BRCH,LOAD ER T/O	04662	17	07888	J0715
04430	B	F1,,,	BRCH-NEXT ROUT	04674	49	04698	00000
04440	BTM	ET,ER72,,	BRCH,LOAD ER T/O	04686	17	07888	J0773
04450*							
04460*							
04470*							
04480 F1	BNI	*+24,01900,,	ANY DATA CHECK	04698	47	04722	01900
04490	BTM	RS,*,,	RESET IND	04710	17	07744	-4710
04500 F12	TFM	S1+8,001,9,	INITIALIZE	04722	16	12098	00-01
04510	TFM	S1+5,00600,,	INITIALIZE	04734	16	12095	-0600
04520	TDM	A1+1,00,,	CLEAR DIGIT	04746	15	12310	00000
04530	WN	S1,00702,,	WRITE SECTOR	04758	38	12090	00702
04540	TDM	A1+1,01,,	CHANGE DIGIT	04770	15	12310	00001
04550	RN	S1,00703,,	RD BK CK	04782	36	12090	00703
04560	BNI	*+48,03900,,	CK ANY FILE IND	04794	47	04842	03900
04570	BI	F3,03700,,	WLR CK IND	04806	46	04890	03700
04580	BTM	ET,ER63,,	BRCH,LOAD ER T/O	04818	17	07888	J0099
04590	B	F3,,,	BRCH-NEXT ROUT	04830	49	04890	00000
04600	BI	*+36,03700,,	CK WLR IND	04842	46	04878	03700
04610	BTM	ET,ER73,,	BRCH,LOAD ER T/O	04854	17	07888	J0829
04620	B	F3,,,	BRCH-NEXT ROUT	04866	49	04890	00000
04630	BTM	ET,ER74,,	BRCH,LOAD ER T/O	04878	17	07888	J0883
04640*							
04650*							
04660*							

THIS ROUTINE CHECKS THAT  
OVFL0 AND WLR CK WILL TURN ON  
OVERFLOW

WLR CK VIA RD BK COMP ER

WLR CK VIA LATE TERM OF GM

04670 F3	BNI	**24,01900,,	ANY DATA CK	04890	47	04914	01900
04680	BTM	RS,*,,	RESET IND	04902	17	07744	-4902
04690	TFM	S2+8,001,9,	INIT SECT	04914	16	12112	00-01
04700	TFM	S2+5,00600,,	INIT SUB-INST	04926	16	12109	-0600
04710	TD	A2+102,GM,,	INSERT GM	04938	25	14513	11655
04720	RN	S2,00700,,	RD A SECTOR	04950	36	12104	00700
04730	BI	F4,03700,,	WLR CK IND	04962	46	04986	03700
04740	BTM	ET,ER64,,	BRCH,LOAD ER T/O	04974	17	07888	J0175
04750*							
04760*			WLR CK VIA EARLY TERM OF GM				
04770*							
04780 F4	TDM	A2+102,00,,	CL GM	04986	15	14513	00000
04790	TD	A2+100,GM,,	LOAD GM	04998	25	14511	11655
04800	RN	S2,00700,,	RD A SCTR	05010	36	12104	00700
04810	BI	F14,03700,,	CK WLR IND	05022	46	05046	03700
04820	BTM	ET,ER68,,	BRCH,LOAD ER T/O	05034	17	07888	J0523
04830*							
04840*			WLR CK VIA CORRECT TERM OF GM				
04850*							
04860 F14	TDM	A2+100,00,,	CL GM	05046	15	14511	00000
04870	TD	A2+101,GM,,	INSERT GM	05058	25	14512	11655
04880	RN	S2,00700,,	READ A SECTOR	05070	36	12104	00700
04890	BNI	**24,03700,,	CK WLR IND	05082	47	05106	03700
04900	BTM	ET,ER67,,	BRCH,LOAD ER T/O	05094	17	07888	J0443
04901*							
04902*			CHECK THAT A GROUP MARK (GM)				
04903*			IN THE DATA (1 SECTOR) ON THE				
04904*			DISK WILL TERMINATE DATA TRANSFER				
04905*			FROM DISK TO CORE STORAGE				
04906*							
04907	TD	A1+85,GM		05106	25	12394	11655
04908	TFM	S1+5,600,,	INITIALIZE	05118	16	12095	-0600
04909	TFM	S1+8,001,9		05130	16	12098	00-01
04910	WN	S1,00702,,	WRITE DATA AND GM	05142	38	12090	00702
04910	TDM	A1+85,8		05154	15	12394	00008
04911	SF	**19		05166	32	05185	00000
04911	TFM	A2+88,0,,	SET RD AREA TO RM	05178	16	14499	-0000
04912	DC	01,*,*		05189		00001	
04914	DC	01,*,*-1		05188		00001	
04915	DC	01,*,*-2		05187		00001	
04916	DC	01,*,*-3		05186		00001	
04917	DC	01,*,*-4		05185		00001	
04917	RN	S2,700,,	READ DATA	05190	36	12104	00700
04917	BNR	GME1,A2+88		05202	45	05262	14499
04918	BNR	GME1,A2+87,,	CHK FOR RM	05214	45	05262	14498
04920	BNR	GME1,A2+86		05226	45	05262	14497
04921	55	GME2,A2+85,,	CHK FOR GM	05238	55	05286	14496
04922	B	**48		05250	49	05298	00000
04923 GME1	BTM	ET,ER90		05262	17	07888	J1237
04924	B	*-36		05274	49	05238	00000
04925 GME2	BTM	ET,ER91		05286	17	07888	J1379
04930	BI	**24,3700		05298	46	05322	03700
04932	BTM	ET,ER92		05310	17	07888	J1511

04934	BNI	++24,1900		05322	47	05346	01900
04936	BTM	RS,*		05334	17	07744	-5334
04910*							
04920*		CHECK THAT ADDRESS CK IND					
04930*		36 WILL TURN ON ANY FILE					
04940*							
04950	BNI	++24,01900,,	ANY DATA CK	05346	47	05370	01900
04960	BTM	RS,*,,	RESET IND	05358	17	07744	-5358
04970	TFM	S2+5,00000,,	INITIALIZE	05370	16	12109	-0000
04980	RN	S2,00702,,	READ SCTR	05382	36	12104	00702
04990	BNI	++48,03900,,	ANY FILE CK	05394	47	05442	03900
05000	BI	++84,03600,,	ADRS CK	05406	46	05490	03600
05010	BTM	ET,ER52,,	BRCH,LOAD ER T/O	05418	17	07888	-9555
05020	B	++60,,,	NEXT ROUTINE	05430	49	05490	00000
05030	BI	++36,03600,,	ADRS CK	05442	46	05478	03600
05040	BTM	ET,ER75,,	BRCH,LOAD ER T/O	05454	17	07888	J0935
05050	B	++24,,,	NEXT ROUTINE	05466	49	05490	00000
05060	BTM	ET,ER76,,	BRCH,LOAD ER T/O	05478	17	07888	J0991
05070*							
05080*		CK THAT ANY FILE TURNS					
05090*		ON ANY DATA CHECK 19					
05100*		ADRS CK IND MUST TURN ON					
05110*		ANY FILE CHECK 39					
05120*							
05130	BNI	++24,01900,,	ANY DATA CK	05490	47	05514	01900
05140	BTM	RS,*,,	RESET IND	05502	17	07744	-5502
05150	TFM	S2+5,00000,,	INITIALIZE	05514	16	12109	-0000
05160	RN	S2,00702,,	READ SCTR	05526	36	12104	00702
05170	BNI	++72,01900,,	ANY DATA CK	05538	47	05610	01900
05180	BNI	++36,03900,,	ANY FILE	05550	47	05586	03900
05190	BI	++12,03600,,	RESET ADRS CK	05562	46	05574	03600
05200	B	F15,,,	BRCH-NEXT ROUT	05574	49	05670	00000
05210	BTM	ET,ER77,,	BRCH,LOAD ER T/O	05586	17	07888	J1045
05220	B	F15,,,	BRCH-NEXT ROUT	05598	49	05670	00000
05230	BNI	++36,03900,,	ANY FILE CK	05610	47	05646	03900
05240	BTM	ET,ER78,,	BRCH,LOAD ER T/O	05622	17	07888	J1095
05250	B	++24,,,	BYPASS	05634	49	05658	00000
05260	BTM	ET,ER79,,	BRCH,LOAD ER T/O	05646	17	07888	J1145
05270	BI	++12,03600,,	RESET ADRS CK	05658	46	05670	03600
05280 F15	TFM	S+6,*,,	LOAD RESTART	05670	16	00408	-5670
05290	BC2	F2,,,	SW2 ON LOOP	05682	46	04542	00200
05300*							
05310*		PUT FLG ADRS AND AN ADRS NOT					
05320*		INCREMENTED BY ONE ON A TK					
05330*							
05340 F16	BNR	F5,TSM,,	CK FOR RM	05694	45	06186	11673
05350	TFM	S2+5,00600,,	INIT SUB-INST	05706	16	12109	-0600
05360	TFM	S2+8,020,9,	INIT SECT CNT	05718	16	12112	00-20
05370	RN	S2,00706,,	READ TRACK	05730	36	12104	00706
05380	SF	A2+1,,,	SET FLAG	05742	32	14412	00000
05390	TDM	A2+215,03,,	ADD ONE TO ADRS	05754	15	14626	00003
05400	RCTY	,,,	RET CARR	05766	34	00000	00102
05410	WATY	T7,,,	TYPE ADRS SW ON	05778	39	08427	00100



05420	H	,,,	HALT	05790	48	00000	00000
05430	WN	S2,00706,,	WRITE TRACK	05802	38	12104	00706
05440	RCTY	,,,	RET CARR	05814	34	00000	00102
05450	WATY	T8,,,	TYPE OFF	05826	39	08519	00100
05460	H	,,,	HALT	05838	48	00000	00000
05470*							
05480*	WRITE ON FLAGGED SECTOR ADDRESS						
05490*							
05500	BNI	**24,01900,,	ANY DATA CK	05850	47	05874	01900
05510	BTM	RS,*,,	RESET IND	05862	17	07744	->862
05520	TFM	S1+5,00600,,	INITIALIZE	05874	16	12095	-0600
05530	TFM	S1+8,001,9,	INITIALIZE	05886	16	12098	00-01
05540	WN	S1,00702,,	WRITE SECTOR	05898	38	12090	00702
05550	BI	F6,03600,,	ADRS CK IND	05910	46	05934	03600
05560	BTM	ET,ER65,,	BRCH,LOAD ER T/O	05922	17	07888	J0259
05570*							
05580*	READ SECT ADRS NOT INCR BY ONE						
05590*							
05600 F6	BNI	**24,01900,,	ANY DATA CK	05934	47	05958	01900
05610	BTM	RS,*,,	RESET IND	05946	17	07744	->946
05620	TFM	S2+5,00600,,	INITIALIZE	05958	16	12109	-0600
05630	TFM	S2+8,003,,	INITIALIZE	05970	16	12112	-0003
05640	RN	S2,00702,,	READ SECTORS	05982	36	12104	00702
05650	BI	F7,03600,,	ADRS CK IND	05994	46	06018	03600
05660	BTM	ET,ER66,,	BRCH,LOAD EK T/O	06006	17	07888	J0343
05670 F7	TFM	S2+5,00600,,	INIT	06018	16	12109	-0600
05680	TFM	S2+8,020,9,	INIT	06030	16	12112	00-20
05690	RN	S2,00706,,	READ TRACK	06042	36	12104	00706
05700	CF	A2+1,,,	CLEAR FLAG	06054	33	14412	00000
05710	TDM	A2+215,02,,	SUB ONE FROM AD	06066	15	14626	00002
05720	RCTY	,,,	RET CARR	06078	34	00000	00102
05730	WATY	T17,,,	TYPE SW ON	06090	39	08597	00100
05740	H	,,,	HALT	06102	48	00000	00000
05750	WN	S2,00706,,	WRITE TRACK	06114	38	12104	00706
05760	RCTY	,,,	RET CARR	06126	34	00000	00102
05770	WATY	T18,,,	TYPE OFF	06138	39	08615	00100
05780	H	,,,	HALT	06150	48	00000	00000
05790	TFM	S+6,*,,	LOAD RESTART	06162	16	00408	-6162
05800	BC2	F16,,,	SW 2 ON LOOP	06174	46	05694	00200
05810*							
05820*	TEST COMPLETE ROUTINES						
05830*							
05840 F5	BC4	J0,,,	SW 4 ON LOOP BK	06186	46	00906	00400
05850	BNC1	**48,,,	SW 1 OFF BYPASS	06198	47	06246	00100
05860	BNR	**36,ERM,,	CK FOR RM IN MAP	06210	45	06246	11657
05870	RCTY	,,,	RETURN CARRIAGE	06222	34	00000	00102
05880	WATY	ER30,,,	TYPE ER OCCURRED	06234	39	09223	00100
05890	RCTY	,,,	RETURN CARRIAGE	06246	34	00000	00102
05900	WATY	T10,,,	TEST COMPLETED	06258	39	08565	00100
05910	RCTY	,,,	RETURN CARRIAGE	06270	34	00000	00102
05920	TFM	S+6,S+12,,	LOAD RESTART	06282	16	00408	-0414
05930	H	,,,	HALT	06294	48	00000	00000
05940	B	S,,,	RESTART TEST	06306	49	00402	00000

06010*					
06020*		THIS ROUTINE READS AND			
06030*		CHECKS THE SECTOR ADDRESSES			
06040*		ON A CYLINDER OF THE DISK PACS			
06050*					
06060*		BRANCH TO MAINLINE PROGRAM			
06070*		TO REQUEST MOD.NO. AND INSERT			
06080*		DRIVE CODE IN SUBINST.			
06090*					
06100	TDM	NOPAD+1,9,,	NOP TO B	06318	15 00883 00009
06110	B	SAD1,,,		06330	49 00750 00000
06120*					
06130*		REQUEST CYLINDER NUMBER			
06140*		AND ADDRESS RANGE			
06150*					
06160 SAD	RCTY			06342	34 00000 00102
06230	TDM	NOPAD+1,1,,	INSURE NOP	06354	15 00883 00001
06170	WATY	SAD2,,,	REQUEST DATA	06366	39 07071 00100
06180	RNTY	CNAR,,,	ACCEPT	06378	36 07153 00100
06190	BC3	*-12,,,	OOPS SW	06390	46 06378 00300
06200*		COMPUTE SECTOR ADDRESS			
07010 SAD6	TFM	S2+5,0,		06402	16 12109 -0000
07020	A	S2+3,CNAR+1,,	DOUBLE	06414	21 12107 07154
07030	A	S2+3,CNAR+1,,	CYL.NO.	06426	21 12107 07154
07040	TD	SAD3-2,CNAR+2,,		06438	25 06472 07155
07050	SF	SAD3-2,		06450	32 06472 00000
07060	AM	S2+2,00,10,	ADD (20000) X SCTR RNG	06462	11 12106 000-0
07070 SAD3	A	S2+2,SAD3-1,,		06474	21 12106 06473
07075	TF	S3+5,S2+5,,	STORE BEGIN ADRS	06486	26 12123 12109
07076	AM	S3+5,200,9,	ADD FOR LAST ADRS	06498	11 12123 00K00
07077	TDM	19994,0,11,		06510	15 19994 0000-
07080*					
07090*		SEEK CYLINDER			
07100*					
07110	K	S2,00701,,	SEEK CYL.	06522	34 12104 00701
07120*					
07130*		READ TRACK			
07135*					
07140 SAD5	RN	S2,00706,,	READ FULL TRACK	06534	36 12104 00706
07150	BNI	*+24,1900,,	ANY DATA CHK	06546	47 06570 01900
07160	BTM	RS,,,	GO TURN OFF IND	06558	17 07744 -6558
07170*					
07180*		INITIALIZE			
07190*					
08010	TFM	IS1+11,A2+1,,	IN	06570	16 06641 J4412
08020	TFM	IS2+11,A2+2,,	IT	06582	16 06653 J4413
08030	TFM	IS3+11,A2+3,,	IA	06594	16 06665 J4414
08040	TFM	IS4+11,A2+4,,	LI	06606	16 06677 J4415
08050	TFM	IS5+11,A2+5,,	ZE	06618	16 06689 J4416
08080*		INSERT SECTOR ADDRESS			
08090 IS1	TD	19995,99999,,	INSERT	06630	25 19995 99999
08100 IS2	TD	19996,99999,,	SECTOR	06642	25 19996 99999
08110 IS3	TD	19997,99999,,	ADDRESS	06654	25 19997 99999

08120	IS4	TD	19998,99999,,		06666	25	19998	99999
08130	IS5	TD	19999,99999,,		06678	25	19999	99999
08145*			COMPARE SECTOR ADDRESSES					
12345		BI	SAER,01600,,	EVEN CHK	06690	46	06810	01600
12345		BI	SAER,01700,,	ODD CHK	06702	46	06810	01700
00123		TFM	*+23,19995,,	INIT	06714	16	06737	J9995
00123		BNR	*+24,99999,,	CHK FOR RM,GM	06726	45	06750	99999
00123		B	SAER,,,	ER T/O	06738	49	06810	00000
00123		AM	*-13,01,10,		06750	11	06737	000-1
00123		CM	*-25,20000,,	CHK DONE	06762	14	06737	K0000
00123		BNE	*-48,,,		06774	47	06726	01200
08150		C	19999,S2+5		06786	24	19999	12109
08160		BE	SAD4		06798	46	06918	01200
08170	SAER	TR	00100,TAB,,	REPLACE MATH TAB	06810	31	00100	11786
08180		BNI	*+24,1900,,	ANY DATA CHK	06822	47	06846	01900
08190		BTM	RS*,,	TURN OFF IND	06834	17	07744	-6834
08200		RCTY			06846	34	00000	00102
08210		DNTY	19995,,,	DUMP ADDRESS	06858	35	19995	00100
08220		WATY	S/B,,,	TYPE S/B	06870	39	07159	00100
08230		TF	SBTOB,S2+5,,		06882	26	07178	12109
08240		CF	SBTOB-4		06894	33	07174	00000
08250		WNTY	SBTOB-4,,,	TYPE S/B ADRS	06906	38	07174	00100
09010*			UPDATE SECTOR ADDRESS TRANSFER					
09020	SAD4	AM	IS1+11,105,,		06918	11	06641	-0105
09030		AM	IS2+11,105,,		06930	11	06653	-0105
09040		AM	IS3+11,105,,		06942	11	06665	-0105
09050		AM	IS4+11,105,,		06954	11	06677	-0105
09060		AM	IS5+11,105,,		06966	11	06689	-0105
09070		AM	S2+5,01,10,		06978	11	12109	000-1
09090		CM	IS1+11,A2+2101,,	CHK TK DONE	06990	14	06641	J6512
09100		BNE	IS1,,		07002	47	06630	01200
09110		C	S2+5,S3+5,,	CHK CYL.DONE	07014	24	12109	12123
09120		BNE	SAD5,,		07026	47	06534	01200
09130		BC2	SAD6,,,	SW 2 ON LOOP	07038	46	06402	00200
09150		H	,,,	HALT	07050	48	00000	00000
09160		B	S+12,,,	RUN TEST	07062	49	00414	00000
		DORG	*-4		07069			
10010*								
10020*			DATA,CONSTANTS,AND TYPEOUTS					
10030*								
10040	SAD2	DAC	25,KEY IN 2 DIG.CYL.NO.AND 1		07071		00050	
10050		DAC	16, DIG.ADRS RNG		07121		00032	
10060		DC	01,0		07152		00001	
10070	CNAR	DSC	05,0		07153		00005	
10080	S/B	DAC	08, S/B		07159		00016	
10090	SBTOB	DC	05,0		07178		00005	
10100		DC	01,0		07179		00001	
05950*								
05960*			ERROR SUBROUTINE					
05970*								
05980	ERR	BI	*+24,01900,,	ANY DATA CHECK	07180	46	07204	01900
05990		B	99999,,,	RETURN TO PROG	07192	49	99999	00000
06000		BNI	J30,03900,,	ANY FILE CHECK	07204	47	07396	03900

06010	BNI	BYSL,03600,,	ADDRESS CHECK	07216	47	07336	03600
06020	CM	E1+6,ER8,,	WAS OP A SEEK	07228	14	07642	-8891
06030	BE	*+60,,,	BRCH - YES	07240	46	07300	01200
06040	CM	E1+6,ER5,,	WAS OP A RD TK	07252	14	07642	-8757
06050	BE	*+36,,,	BRCH - YES	07264	46	07300	01200
06060	CM	E1+6,ER5G,,	WAS OP A RD TK	07276	14	07642	-8801
06070	BNE	*+36,,,	BRCH - NO	07288	47	07324	01200
06080	TFM	E1+1,41,10,	CHANG WATY TO NOP	07300	16	07637	000M1
06090	BTM	ETO,ER19,,	BRCH LOAD ER T/O	07312	17	07552	-9167
06100	BTM	ETO,ER10,,	BRCH LOAD ER T/O	07324	17	07552	-8939
06110	BNSL	BNI *+24,03700,,	RECORD LENGTH CK	07336	47	07360	03700
06120	BTM	ETO,ER11,,	BRCH,LOAD ER T/O	07348	17	07552	-8967
06130	BNI	*+24,03800,,	OVERFLOW CHECK	07360	47	07384	03800
06140	BTM	ETO,ER12,,	BRCH,LOAD ER T/O	07372	17	07552	-8995
06150	BTM	ETO,ER13,,	BRCH,LOAD ER T/O	07384	17	07552	-9025
06160	J30	BNI *+24,00600,,	READ CHECK	07396	47	07420	00600
06170	BTM	ETO,ER14,,	BRCH,LOAD ER T/O	07408	17	07552	-9063
06180	BNI	*+24,00700,,	WRITE CHECK	07420	47	07444	00700
06190	BTM	ETO,ER15,,	BRCH,LOAD ER T/O	07432	17	07552	-9089
06200	BNI	*+24,01600,,	MBR-E CHECK	07444	47	07468	01600
06210	BTM	ETO,ER16,,	BRCH,LOAD ER T/O	07456	17	07552	-9115
06220	BNI	*+24,01700,,	MBR-O CHECK	07468	47	07492	01700
06230	BTM	ETO,ER17,,	BRCH,LOAD ER T/O	07480	17	07552	-9141
06240	BI	*+12,0800,,	MAR CHECK	07492	46	07504	00800
06250	BI	*+12,02100,,	TAS CHECK	07504	46	07516	02100
06260	BI	*+12,02200,,	F R CHECK	07516	46	07528	02200
06270	BI	*+12,02300,,	A O CHECK	07528	46	07540	02300
06280	B	ERR,,,	LOOP BACK	07540	49	07180	00000

06290\*  
06300\*           ERROR TYPE OUT ROUTINE  
06310\*           FOR THE ABOVE ERROR SUBROUTINE  
06320\*

06340	ETO	BC1 E11,,,	SW 1 ON BYPASS	07552	46	07672	00100
06350	MM	S2+5,05,10,	MULTIPLY	07564	13	12109	000-5
06360	TD	ER20+10,95,,	CYL. NUMBER	07576	25	09205	00095
06370	TD	ER20+12,96,,	CYL. NUMBER	07588	25	09207	00096
06380	TD	ER20+24,97,,	HD NUMBER	07600	25	09219	00097
06390	TF	E1+18,ETO-1,,	LOAD ER T/O	07612	26	07654	07551
06400	RCTY	,,,	RETURN CARRIAGE	07624	34	00000	00102
06410	E1	WATY 99999,,,	TYPE ERROR	07636	39	99999	00100
06420	WATY	99999,,,	TYPE ERROR	07648	39	99999	00100
06430	WATY	ER20,,,	TYPE ERROR	07660	39	09195	00100
06440	E11	TD ERM,RM,,	PUT RM IN MAP	07672	25	11657	11654
06450	TR	00100,TAB,,	REPLACE MATH TAB	07684	31	00100	11786
06460	TFM	E1+1,39,10,	CHNG NOP TO WATY	07696	16	07637	000L9
06470	BNC3	*+24,,,	SW 3 ON HALT	07708	47	07732	00300
06480	H	,,,	HALT	07720	48	00000	00000
06490	B	ERR,,,	SEE IF MORE ERS	07732	49	07180	00000

06500\*  
06510\*           THIS ROUTINE RESETS THE  
06520\*           INDICATORS THAT TURN  
06530\*           ON ANY DATA CHECK  
06540\*

06560 RS	BI	*+12,03600,,	ADRS CK	07744	46	07756	03600
06570	BI	*+12,03700,,	WLR CK	07756	46	07768	03700
06580	BI	*+12,03800,,	OVFLO CK	07768	46	07780	03800
06590	BI	*+12,00600,,	READ CK	07780	46	07792	00600
06600	BI	*+12,00700,,	WRITE CK	07792	46	07804	00700
06610	BI	*+12,01600,,	MBR-E CK	07804	46	07816	01600
06620	BI	*+12,01700,,	MBR-O CK	07816	46	07828	01700
06630	BI	*+12,00800,,	MAR CK	07828	46	07840	00800
06640	BI	*+12,02100,,	TAS CK	07840	46	07852	02100
06650	BI	*+12,02200,,	F R CK	07852	46	07864	02200
06660	BI	*+12,02300,,	A O CK	07864	46	07876	02300
06670	BB	,,,	BRCH-BACK	07876	42	00000	00000

06680\*

06690\*

06700\*

06710\*

ERROR TYPE OUT ROUTINE FOR  
ERRORS DURING MAIN PROGRAM

06730 ET	BC1	*+48,,,	SW1 ON BYPASS	07888	46	07936	00100
06740	TF	*+30,*-13,,	LOAD WATY	07900	26	07930	07887
06750	RCTY	,,,	RET CARR	07912	34	00000	00102
06760	WATY	99999,,,	TYPE ERROR	07924	39	99999	00100
06770	TD	ERM,RM,,	PUT RM IN MAP	07936	25	11657	11654
06780	TR	00100,TAB,,	REPLACE MATH TAB	07948	31	00100	11786
06790	BNC3	*+24,,,	SW3 ON HALT	07960	47	07984	00300
06800	H	,,,	HALT	07972	48	00000	00000
06810	BB	,,,	BRCH-BACK	07984	42	00000	00000
	DORG	*-9		07986			

06820\*

06830\*

06840\*

06850\*

DATA,CONSTANTS,WORKING AREAS,  
TYPEOUTS,AND ERROR MESSAGES

06860 T1	DAC	14,DT 0022 - 1311	07987	00028
06870	DAC	17, FAULT ISOLATION'	08015	00034
12345 WRCD1	DAC	35,WARNING-REMOVE CUSTOMER DISK PACKS'	08049	00070
12345 WRCD2	DAC	31,FROM ALL MODULES,TURN SW 3 ON.'	08119	00062
06880 T2	DAC	16,SWITCH SETTINGS'	08181	00032
06890 T3	DAC	21,PROGRAM - AS DESIRED'	08213	00042
06900 T4	DAC	16,DATA -- PROGRAM'	08255	00032
06910 T5	DAC	25,KEY IN 1 DIGIT MODULE NO.	08287	00050
06920	DAC	18, DISK PACK IS ON '	08337	00036
06930 T6	DAC	27,CK FLG ADRS,TYPE YES OR NO'	08373	00054
06940 T7	DAC	27,TURN WR ADRS SW ON AND COMP	08427	00054
06950	DAC	19, DSBLE SW ON (OUT)'	08481	00038
06960 T8	DAC	23,NOW TURN THEM OFF (IN)'	08519	00046
06970 T10	DAC	16,TEST COMPLETED '	08565	00032
06980 T17	DAC	09,ON AGAIN'	08597	00018
06990 T18	DAC	10,OFF AGAIN'	08615	00020
07000 T30	DAC	22,SW 3 ON FOR CORRECTING	08635	00044
07010	DAC	08, KEY IN'	08679	00016

07020\*

07030\*

07040\*

ERROR MESSAGES

07050 ER3	DAC	18,WRITE 20 SCT WLR '	08695	00036
07060 ER4	DAC	18,READ BK COMP WLR '	08731	00036

07070	ER5	DAC	17,READ TK W/O WLR '	08767	00034
07080	ER5G	DAC	16,RD TK WITH WLR '	08801	00032
07090	ER6	DAC	14,PROG COMPARE '	08833	00028
07100	ER7	DAC	15,DATA NOT EQUAL'	08861	00030
07110	ER8	DAC	06,SEEK '	08891	00012
07120	ER9	DAC	18,CYL.3 ZERO RESET '	08903	00036
07130	ER10	DAC	14, ADS CK (36) '	08939	00028
07140	ER11	DAC	14, WLR CK (37) '	08967	00028
07150	ER12	DAC	15, OVFO CK (38) '	08995	00030
07160	ER13	DAC	19, FILE NO IND (39) '	09025	00038
07170	ER14	DAC	13, RD CK (06) '	09063	00026
07180	ER15	DAC	13, WR CK (07) '	09089	00026
07190	ER16	DAC	13, MBR-E (16) '	09115	00026
07200	ER17	DAC	13, MBR-O (17) '	09141	00026
07210	ER19	DAC	14,SELECT LOCK '	09167	00028
07220	ER20	DAC	14, CYL 99 HD 9'	09195	00028
07230	ER30	DAC	23,ERROR OCCURRED BUT SW 1	09223	00046
07240		DAC	21, WAS ON THUS NO ETO.'	09269	00042
07250	ER3G	DAC	19,WR 20 SCT W/O WLR '	09311	00038
07260	ER4G	DAC	18,RD BK CK W/O WLR '	09347	00036
07270	ER6G	DAC	15,RD 20 SCT,WLR '	09385	00030
07280	ER6GM	DAC	19,RD 20 SCT,W/O WLR '	09415	00038
07290	ER5S	DAC	21,READ SECTOR W/O WLR '	09453	00042
07300	ER51	DAC	21,RD TK,NO ADRS,ADRS CK	09495	00042
07310		DAC	09, IND OFF'	09537	00018
07320	ER52	DAC	21,ADRS CK IND (36) WONT	09555	00042
07330		DAC	09, TURN ON'	09597	00018
07340	ER54	DAC	28,HDS AT CYL 99,SHD BE CYL 97'	09615	00056
07350	ER55	DAC	25,RD,MBR-E/O,ADS CK,OR WRNG	09671	00050
07360		DAC	23, HD RD TK,ON ALL HEADS'	09721	00046
07370	ER56	DAC	28,HDS AT CYL 99 SHD BE CYL 99'	09767	00056
07380	ER57	DAC	09,RD TK 9 '	09823	00018
07390	ER58	DAC	26,CORRECT TK,DATA NOT COMP '	09841	00052
07400	ER59	DAC	22,RD TK WLR,ADRS NOT EQ'	09893	00044
07410	ER60	DAC	26,RD TK W/O WLR,ADRS NOT EQ'	09937	00052
07420	ER61	DAC	28,HDS AT CYL 99 SHD BE CYL 03'	09989	00056
07430	ER62	DAC	27,OVFLO CK (38) WONT TURN ON'	10045	00054
07440	ER63	DAC	24,WLR CK (37) WONT TURN ON	10099	00048
07450		DAC	14, VIA RD BK ER'	10147	00028
07460	ER64	DAC	24,WLR CK (37) WONT TURN ON	10175	00048
07470		DAC	18, VIA GM LATE TERM'	10223	00036
07480	ER65	DAC	26,ADRS CK WONT TURN ON VIA A	10259	00052
07490		DAC	16, WR ON FLG ADRS'	10311	00032
07500	ER66	DAC	24,ADRS CK IND WONT TURN ON	10343	00048
07510		DAC	26, VIA ADRS NOT INCR BY ONE'	10391	00052
07520	ER67	DAC	27,WLR CK ON,GM CORRECT PLACE,	10443	00054
07530		DAC	13, RD SCT WLR '	10497	00026
07540	ER68	DAC	27,WLR CK IND WONT TURN ON VIA	10523	00054
07550		DAC	15, GM EARLY TERM'	10577	00030
07560	ER70	DAC	26,SELECTING WRNG STORAGE DR,	10607	00052
07570		DAC	28,DISK PACK SCTR ADRS RANGE 9'	10659	00056
07580	ER71	DAC	29,ANY FILE 39 OFF,OVFLO 38 OFF'	10715	00058
07590	ER72	DAC	28,ANY FILE 39 OFF,OVFLO 38 ON'	10773	00056

07600	ER73	DAC	27,ANY FILE 39 OFF,WLR 37 OFF'	10829	00054
07610	ER74	DAC	26,ANY FILE 39 OFF,WLR 37 ON'	10883	00052
07620	ER75	DAC	28,ANY FILE 39 OFF,ADRS 36 OFF'	10935	00056
07630	ER76	DAC	27,ANY FILE 39 OFF,ADRS 36 ON'	10991	00054
07640	ER77	DAC	25,ANY DATA ON,ANY FILE OFF'	11045	00050
07650	ER78	DAC	25,ANY DATA OFF,ANY FILE ON'	11095	00050
07660	ER79	DAC	26,ANY DATA OFF,ANY FILE OFF'	11145	00052
07670	ER80	DAC	20,,ADRS CK IND 36 OFF'	11197	00040
06123	ER90	DAC	35,GM IN DISK DATA FAILED TO TERMINATE	11237	00070
06123		DAC	36, XFER FROM DISK TO CORE,RN WITH WLR'	11307	00072
06234	ER91	DAC	35,GM IN DISK DATA FAILED TO DE XFERED	11379	00070
06234		DAC	31, TO CORE FROM DISK,RN WITH WLR'	11449	00062
06345	ER92	DAC	33,GM IN DISK DATA,EARLY TERMINATION	11511	00066
06345		DAC	33, FAILED TO TURN ON WLR CK,IND 37'	11577	00066
07680*					
07690*			DATA AND CONSTANTS		
07700*					
07710	N	DC	2,00,, MODULE NUMBER	11643	00002
07720		DC	2,00,, BUFFER	11645	00002
07730	M	DC	2,00,, DRIVE CODE	11647	00002
07740	M1	DC	5,00000,, ERROR MAP	11652	00005
07750	RM	DC	2,0',,, RECORD MARK	11654	00002
07760	GM	DGM		11655	00001
07770	ERM	DC	2,00,, ERROR MAP	11657	00002
07780	C5	DC	2,05,, CONSTANT	11659	00002
07790	C2	DC	2,02,, CONSTANT	11661	00002
07800	C1	DC	5,02200,, CONSTANT	11666	00005
07810	C3	DC	5,00000,, CONSTANT	11671	00005
07820	TSM	DC	2,00,, MAP	11673	00002
07830	ANS	DAC	6,000000,, ANSWER	11675	00012
07840	TD	DSC	20,0000000000111111111,,T	11686	00020
07850		DSC	20,2222222222333333333,, E	11706	00020
07860		DSC	20,4444444444555555555,, S	11726	00020
07870		DSC	20,6666666666777777777,, T	11746	00020
07880		DSC	20,8888888888999999999,,DATA	11766	00020
07890	TAB	DSC	2,0	11786	00002
07900		DSB	100,3,, MATH TABLES	11887	00300
07910*					
07920*			SUB-INSTRUCTIONS AND		
07930*			READ-IN AREAS		
07940*					
07950		DAC	1,0	12089	00002
07960	S1	DSC	9,000000000,, SUB-INST 1	12090	00009
07970		DSA	A1+1	12103	00005 J2310
07980	S2	DSC	9,000000000,, SUB-INST 2	12104	00009
07990		DSA	A2+1	12117	00005 J4412
08000	S3	DSC	09,000000020,, SUB-INST 3	12118	00009
08010		DSA	A3	12131	00005 -7986
08070	A3	DS	,T1-1	07986	00000
	MON	DS	,18117	18117	00000
	MONIT	DS	,18000	18000	00000
12345		DAC	04,DT22	12133	00008
12345		DSA	LAST	12144	00005 J6512

DIPAL	BNR	DIPAL6	,MON	12146	45	12230	18117
	B	**48		12158	49	12206	00000
	NOP	JO		12170	41	00906	00000
	TDM	*-11,9		12182	15	12171	00009
	B	S		12194	49	00402	00000
	TF	F5+18	,DIPAL1+6	12206	26	06204	12256
	B	MONIT		12218	49	18000	00000
DIPAL6	H			12230	48	00000	00000
	B	S		12242	49	00402	00000
	DORG	*-4		12249			
DIPAL1	B	DIPAL2,,0		12250	M9	12258	00000
	DORG	*-4		12257			
DIPAL2	BNR	**24	,MON	12258	45	12282	18117
	B	MONIT		12270	49	18000	00000
	BNC1	F5+60		12282	47	06246	00100
	B	F5+24		12294	49	06210	00000
08020	DAC	1,0		12307		00002	
08030	A1	DC 2,00,,	AREA A1	12309		00002	
08040	DSB	105,20,,	2000 CHARACTERS	12414		02100	
08050	A2	DC 2,00,,	AREA A2	14411		00002	
08060	DSB	105,20,,	2100 CHARACTERS	14516		02100	
12345	LAST	DC 01,0,,		16512		00001	
07970	DEND	DIPAL		12146			



80/80 LISTING OF DT 0022 OBJECT DECK

360032000500260003500393250001199999260005400387319999900320Z	00000	00060	00000
2600078003932599999000114900000Z	Z	00060	00092 00001
0000000000001020304000204060800030609021004080216100500Z	Z	00100	00155 00002
1510200602181420070411282008061422300908172630000000000Z	Z	00155	00210 00003
5060708090012141618151811242720242822363520353045403632Z	Z	00210	00265 00004
4844553249465360484654627544536271801234567891234567890Z	Z	00265	00320 00005
490041400000340000000102390798700100340000000102390804900100Z		00402	00462 00006
340000000102390811900100470048600300340000000102390863500100Z		00462	00522 00007
340000000102390818100100340000000102390821300100340000000102Z		00522	00582 00008
39082550010015008830000148000000000340000000102390837300100Z		00582	00642 00009
371167500100460064200300321167400000141167500008470072601200Z		00642	00702 00010
251167311654490073800000151167300000160040800738340000000102Z		00702	00762 00011
390828700100361164300100460077400300131164300002110009900001Z		00762	00822 00012
251164700099251209011647251210411647251211811647311178600100Z		00822	00882 00013
4106342000001600408008944700930019001707744009181612109J9400Z		00882	00942 00014
161211200001341210400701470101401900160719800954160764208891Z		00942	01002 00015
490718000000161210900000361210400702460132603600161211200020Z		01002	01062 00016
261441611654361210400706450112214416170788809495490093000000Z		01062	01122 00017
321441200000131441400005430117000096490121800000251071100096Z		01122	01182 00018
1707888J06071707888J1197490093000000140009900970470126601200Z		01182	01242 00019
17078880955490093000000250963700097250963900098170788809615Z		01242	01302 00020
1707888J1197490093000000161211200020361210400706321441200000Z		01302	01362 00021
1314414000054301393000964901434000002510711000961707888J0607Z		01362	01422 00022
490093000000140009900970460150601200250963700097250963900098Z		01422	01482 00023
170788809615490093000000160040801506460093000200470155401900Z		01482	01542 00024
1707744015421612109J94001612112000011514411000001601733J1687Z		01542	01602 00025
161165200000361210400702470165000600151165000001470167401600Z		01602	01662 00026
151165100001470169801700151165100001470172203600151165200001Z		01662	01722 00027
250174599999141441200000460177001200151164900001141165200000Z		01722	01782 00028
4601878012001412109J9580460185401200111210900020110173300010Z		01782	01842 00029
490160200000170788809671490155400000160040801878460153000200Z		01842	01902 00030
131210800005250193700098131166100000261167111666211167000099Z		01902	01962 00031
470198601900170774401974261210911671161211200001341210400701Z		01962	02022 00032
470207001900160719802010160764208891490718000000361210400702Z		02022	02082 00033
460209400600460210601600460211801700470225003600161211200020Z		02082	02142 00034
361210400706131210800005250981700096250981900097131441500005Z		02142	02202 00035
2509789000962509791000971707888097674901998000001412106000J7Z		02202	02262 00036
460229801300111210902200490201000000160040802298460198600200Z		02262	02322 00037
3211686000001602364J24091602376J2310269999911785339999900000Z		02322	02382 00038
1402364J4309460244201200110236400100110237600100490235800000Z		02382	02442 00039
1600408024421612109J9400161211200001341210400701470253801900Z		02442	02502 00040
160719802478160764208891490718000000361210400702470270603600Z		02502	02562 00041
1612112000201612109J9400250260901937131166100000211210800099Z		02562	02622 00042
361210400706321441200000131441400005250963700097250963900098Z		02622	02682 00043
1707888096154902454000004702730019001707744027181602748J4511Z		02682	02742 00044
16999990J00001202748000041402748J4411470274201200361210400702Z		02742	02802 00045
470285001900160719803006160764209453490718000000131210800005Z		02802	02862 00046
251231000098151230900000151441100000241240914511460300601200Z		02862	02922 00047
241231014412160719803006160764208833460299401200150983514412Z		02922	02982 00048
1707552098231707552098411412109J9580460305401200111210900020Z		02982	03042 00049

490273000000160040803054460245400200470310201900170774403090Z	03042	03102	00050
1516512000001503197000061612112000201612109J9400250317301937Z	03102	03162	00051
131166100000211210800099361210400706470328201900160719803378Z	03162	03222	00052
550325816512160764203801490718000000160764208767490718000000Z	03222	03282	00053
111210900019321640700000241641112109460337801200550336616512Z	03282	03342	00054
170788809893490337800000170788809937550340216512490343800000Z	03342	03402	00055
251651211655150319700004490313800000160040803438460307800200Z	03402	03462	00056
470348601900170774403474161209800020150386900002150396500003Z	03462	03522	00057
150406100002151431000000151641200000161209500600161210900600Z	03522	03582	00058
1603845J1687161211200001341210400701470366601900160719803606Z	03582	03642	00059
16076420889149071800000361210400702470382203600161211200020Z	03642	03702	00060
250372501937131166100000211210800099361210400706321441200000Z	03702	03762	00061
131441400005251001100097251001300098170788809989490348600000Z	03762	03822	00062
161211200020251231099999110384500010381209000702470395401900Z	03822	03882	00063
160719804230550393014310160764208695490718000000160764209311Z	03882	03942	00064
490718000000361209000703470405001900160719804230550402614310Z	03942	04002	00065
160764208731490718000000160764209349490718000000361210400702Z	04002	04062	00066
470414601900160719804230550412216412160704209385490718000000Z	04062	04122	00067
160764209415490718000000321231000000321441200000241+30916411Z	04122	04182	00068
460423001200160719804230160764208833170755208861141209500780Z	04182	04242	00069
460429001200111209500020111210900020490383400000161212300600Z	04242	04302	00070
381211800702361211800703470438601900160719804386160764208903Z	04302	04362	00071
261210912123490718000000111212300020141212300800470430201200Z	04362	04422	00072
550444614310490451800000251431011655251641211655150386900000Z	04422	04482	00073
150396500001150406100000490355800000160040804518460348600200Z	04482	04542	00074
47045660190017077+404554161211200021161210900780361210400702Z	04542	04602	00075
4704650039004604698038001707888J0045490469800000460468603800Z	04602	04662	00076
1707888J07154904698000001707888J0773470472201900170774404710Z	04662	04722	00077
161209800001161209500600151231000000381209000702151231000001Z	04722	04782	00078
3612090007034704842039004604890037001707888J0099490489000000Z	04782	04842	00079
4604878037001707888J08294904890000001707888J0883470491401900Z	04842	04902	00080
170774404902161211200001161210900600251451311655361210400700Z	04902	04962	00081
4604986037001707888J0175151451300000251451111655361210400700Z	04962	05022	00082
4605046037001707888J0523151451100000251451211655361210400700Z	05022	05082	00083
4705106037001707888J0443251239411655161209500600161209800001Z	05082	05142	00084
381209000702151239400008320518500000161449900000Z	Z	05142	05190 00085
Z	Z	05189	05190 00086
Z	Z	05188	05189 00087
Z	Z	05187	05188 00088
Z	Z	05186	05187 00089
Z	Z	05185	05186 00090
36121040070045052621449945052621449845052621449Z	Z	05190	05237 00091
75505286144964905298000001707888J12374905230000001707888J137Z	05237	05297	00092
94605322037001707888J151147053460190017077440533447053700190Z	05297	05357	00093
017077440535816121090000036121040070247054420390046054900360Z	05357	05417	00094
01707888095554905490000004605478036001707888J093549054900000Z	05417	05477	00095
01707888J099147055140190017077440550216121090000036121040070Z	05477	05537	00096
24705610019004705586039004605574036004905670000001707888J104Z	05537	05597	00097
54905670000004705646039001707888J10954905658000001707888J114Z	05597	05657	00098
546056700360016004080567046045420020045061861167316121090060Z	05657	05717	00099
016121120002036121040070632144120000015146260000334000000010Z	05717	05777	00100
239084270010048000000000038121040070634000000010239085190010Z	05777	05837	00101
048000000000047058740190017077440586216120950060016120980000Z	05837	05897	00102

13812090007024605934036001707888J025947059580190017077440594Z	05897	05957	00103
61612109006001612112000033612104007024606018036001707888J034Z	05957	06017	00104
316121090060016121120002036121040070633144120000015146260000Z	06017	06077	00105
234000000010239085970010048000000000038121040070634000000010Z	06077	06137	00106
239086150010048000000000016004080616246056940020046009060040Z	06137	06197	00107
047062460010045062461165734000000010239092230010034000000010Z	06197	06257	00108
239085650010034000000010216004080041448000000000049004020000Z	06257	06317	00109
015008830000949007500000034000000010215008830000139070710010Z	06317	06377	00110
036071530010046063780030016121090000021121070715421121070715Z	06377	06437	00111
425064720715532064720000011121060000021121060647326121231210Z	06437	06497	00112
9111212300K0015199940000034121040070136121040070647065700190Z	06497	06557	00113
01707744065581606641J44121606653J44131606665J44141606677J441Z	06557	06617	00114
51606689J441625199959999251999699992519997999925199989999Z	06617	06677	00115
92519999999994606810016004606810017001606737J999545067509999Z	06677	06737	00116
94906810000001106737000011406737K000047067260120024199991210Z	06737	06797	00117
946069180120031001001178647068460190017077440683434000000010Z	06797	06857	00118
23519950010039071590010026071781210933071740000038071740010Z	06857	06917	00119
011066410010511066530010511066650010511066770010511066890010Z	06917	06977	00120
51112109000011406641J651247066300120024121091212347065340120Z	06977	07037	00121
046064020020048000000000490041400000Z	Z	07037	07074 00122
N24568004955007200444947034366Z	Z	07070	07100 00123
530355560341554400710044494703414459620059554700000Z	Z	07100	07152 00124
000000000062214200000Z	Z	07152	07174 00125
00000Z	Z	07174	07180 00126
46072040190049999900000470739603900470733603600140764208891Z	07180	07240	00127
460730001200140764208767460730001200140764208801470732401200Z	07240	07300	00128
1607637000M1170755209167170755208939470736003700170755208967Z	07300	07360	00129
470738403800170755208995170755209025470742000600170755209063Z	07360	07420	00130
470744400700170755209089470746801600170755209115470749201700Z	07420	07480	00131
170755209141460750400800460751602100460752802200460754002300Z	07480	07540	00132
490718000000460767200100131210900005250920500095250920700096Z	07540	07600	00133
250921900097260765407551340000000102399999900100399999900100Z	07600	07660	00134
3909195001002511657116543100100117861607637000L9470773200300Z	07660	07720	00135
48000000000490718000000460775603600460776803700460778003800Z	07720	07780	00136
460779200600460780400700460781601600460782801700460784000800Z	07780	07840	00137
46078520210046078640220046078760230042000000000460793600100Z	07840	07900	00138
26079300788734000000102399999900100251165711654310010011786Z	07900	07960	00139
4707984003004800000000042000000000Z	Z	07960	07996 00140
M46300707072720020007173Z	Z	07986	08010 00141
7171004641645363004962565341634956550Z	Z	08010	08048 00142
064159554955472059455456654500436462635654455900444962520057Z	Z	08048	08108 00143
414352620Z	Z	08108	08118 00144
M65956540041535300545644645345622363645955006266007300565503Z	08118	08178	00145
0Z	Z	08178	08180 00146
0266496343480062456363495547620Z	Z	08180	08212 00147
N7595647594154002000416200444562495945440Z	Z	08212	08254 00148
M441634100202000575956475941540Z	Z	08254	08286 00149
N24568004955007100444947496300545644645345005556030044496252Z	08286	08346	00150
0057414352004962005655000Z	Z	08346	08372 00151
M3520046534700414459622363685745006845620056590055560Z	Z	08372	08426 00152
036459550066590041445962006266005655004155440043565457004462Z	08426	08486	00153
4253450062660056550024566463040Z	Z	08486	08518 00154
N55666006364595500634845540056464600244955040Z	Z	08518	08564 00155

034562630043565457534563454400Z	Z	08564	08596	00156
N6550041474149550Z	Z	08596	08614	00157
N646460041474149550Z	Z	08614	08634	00158
02660073005655004656590043565959454363495547005245680049550ZZ	Z	08634	08694	00159
06594963450072700062436300665359000Z	Z	08694	08730	00160
N9454144004252004356545700665359000Z	Z	08730	08766	00161
N94541440063520066215600665359000Z	Z	08766	08800	00162
N944006352006649634800665359000Z	Z	08800	08832	00163
N75956470043565457415945000Z	Z	08832	08860	00164
M4416341005556630045586441530Z	Z	08860	08890	00165
02454552000Z	Z	08890	08902	00166
M3685303730069455956005945624563000Z	Z	08902	08938	00167
004144620043520024737604000Z	Z	08938	08966	00168
006653590043520024737704000Z	Z	08966	08994	00169
00566546560043520024737804000Z	Z	08994	09024	00170
0046495345005556004955440024737904000Z	Z	09024	09062	00171
0059440043520024707604000Z	Z	09062	09088	00172
0066590043520024707704000Z	Z	09088	09114	00173
0054425920450024717604000Z	Z	09114	09140	00174
0054425920560024717704000Z	Z	09140	09166	00175
024553454363005356435200000Z	Z	09166	09194	00176
004368530079790000484400790Z	Z	09194	09222	00177
M55959565900564343645959454400426463006266007100664162005655Z	Z	09222	09282	00178
006348646200555600456356030Z	Z	09282	09310	00179
0659007270006243630066215600665359000Z	Z	09310	09348	00180
N9440042520043520066215600665359000Z	Z	09348	09384	00181
N9440072700062436323665359000Z	Z	09384	09414	00182
N944007270006243632366215600665359000Z	Z	09414	09452	00183
N9454144006245436356590066215600665359000Z	Z	09452	09494	00184
N9440063522355560041445962234144596200435200495544005646460ZZ	Z	09494	09554	00185
M1445962004352004955440024737604006656556300636459550056550ZZ	Z	09554	09614	00186
M844620041630043685300797923624844004245004368530079770Z	Z	09614	09670	00187
N94423544259204521562341446200435223565900665955470048440059Z	Z	09670	09730	00188
44006352235655004153530048454144620Z	Z	09730	09766	00189
M844620041630043685300797900624844004245004368530079790Z	Z	09766	09822	00190
N9440063520079000Z	Z	09822	09840	00191
M35659594543630063522344416341005556630043565457000Z	Z	09840	09892	00192
N944006352006653592341445962005556630045580Z	Z	09892	09936	00193
N94400635200662156006653592341445962005556630045580Z	Z	09936	09988	00194
M844620041630043685300797900624844004245004368530070730Z	Z	09988	J0044	00195
N6654653560043520024737804006656556300636459550056550Z	Z	J0044	J0098	00196
065359004352002473770400665655630063645955005655006549410059Z	Z	J0098	J0158	00197
440042520045590Z	Z	J0158	J0174	00198
065359004352002473770400665655630063645955005655006549410047Z	Z	J0174	J0234	00199
54005341634500634559540Z	Z	J0234	J0258	00200
M14459620043520066565563006364595500565500654941004100665900Z	Z	J0258	J0318	00201
56550046534700414459620Z	Z	J0318	J0342	00202
M14459620043520049554400665655630063645955005655006549410041Z	Z	J0342	J0402	00203
445962005556630049554359004268005655450Z	Z	J0402	J0442	00204
065359004352005655234754004356595945436300575341434523005944Z	Z	J0442	J0502	00205
0062436300665359000Z	Z	J0502	J0522	00206
065359004352004955440066565563006364595500565500654941004754Z	Z	J0522	J0582	00207
00454159536800634559540Z	Z	J0582	J0606	00208

0245534543634955470066595547006263565941474500445923M4496252Z	J0606	J0666	00209
00574143520062436359004144596200594155474500790Z	Z	J0666	J0714 00210
M15568004649534500737900564646235665465356007378005646460Z	Z	J0714	J0772 00211
M155680046495345007379005646462356654653560073780056550Z	Z	J0772	J0828 00212
M1556800464953450073790056464623665359007377005646460Z	Z	J0828	J0882 00213
M15568004649534500737900564646236653590073770056550Z	Z	J0882	J0934 00214
M155680046495345007379005646462341445962007376005646460Z	Z	J0934	J0990 00215
M1556800464953450073790056464623414459620073760056550Z	Z	J0990	J1044 00216
M155680044416341005655234155680046495345005646460Z	Z	J1044	J1094 00217
M155680044416341005646462341556800464953450056550Z	Z	J1094	J1144 00218
M15568004441634100564646234155680046495345005646460Z	Z	J1144	J1196 00219
K34144596200435200495544007376005646460Z	Z	J1196	J1236 00220
M75400495500444962520044416341004641495345440063560063455954Z	J1236	J1296	00221
495541634500674645590046595554004449625200635600435659452359Z	J1296	J1356	00222
550066496348006653590Z	Z	J1356	J1378 00223
M75400495500444962520044416341004641495345440063560044450067Z	J1378	J1438	00224
464559454400635600435659450046595654004449625223595500664963Z	J1438	J1498	00225
48006653590Z	Z	J1498	J1510 00226
M75400495500444962520044416341234541595368006345595449554163Z	J1510	J1570	00227
495655004641495345440063560063645955005655006653590043522349Z	J1570	J1630	00228
55440073770Z	Z	J1630	J1642 00229
00000000000Z	Z	J1642	J1655 00230
(	Z	J1655	J1656 00231
000502022000000000P0707070707000000000011111111222222222Z	J1656	J1716	00232
333333333444444444445555555555666666666677777777778888888888Z	J1716	J1776	00233
99999999900Z	Z	J1776	J1788 00234
P000000000J231000000000J441Z	Z	J2088	J2117 00235
200000002007986M4637272J6512Z	Z	J2117	J2145 00236
45122301811749122060000410090Z	Z	J2146	J2176 00237
600000151217100009490040200000260620412256491800000000480000Z	J2176	J2236	00238
000000490040200000Z	Z	J2236	J2254 00239
M91225800000Z	Z	J2250	J2262 00240
45122821811749180000000047Z	Z	J2258	J2284 00241
0624600100490621000000P000Z	Z	J2284	J2310 00242
00Z	Z	J4410	J4412 00243
0Z	Z	J6512	J6513 00244
3100320003523600000005004900000Z234567890J34567890JK4567890JZ	00060	00348	00245
310034800024360000000500KL567890JKLM67890JKLMN7890JKLMNO890JZ	00348	00384	00246
41000000000049J2146000003100384000444900000ZKLMNOP90JKLMNUPQZ	00384	00401	00247