



Virtual Machine/ System Product

General Information

Release 4

GC20-1838-4

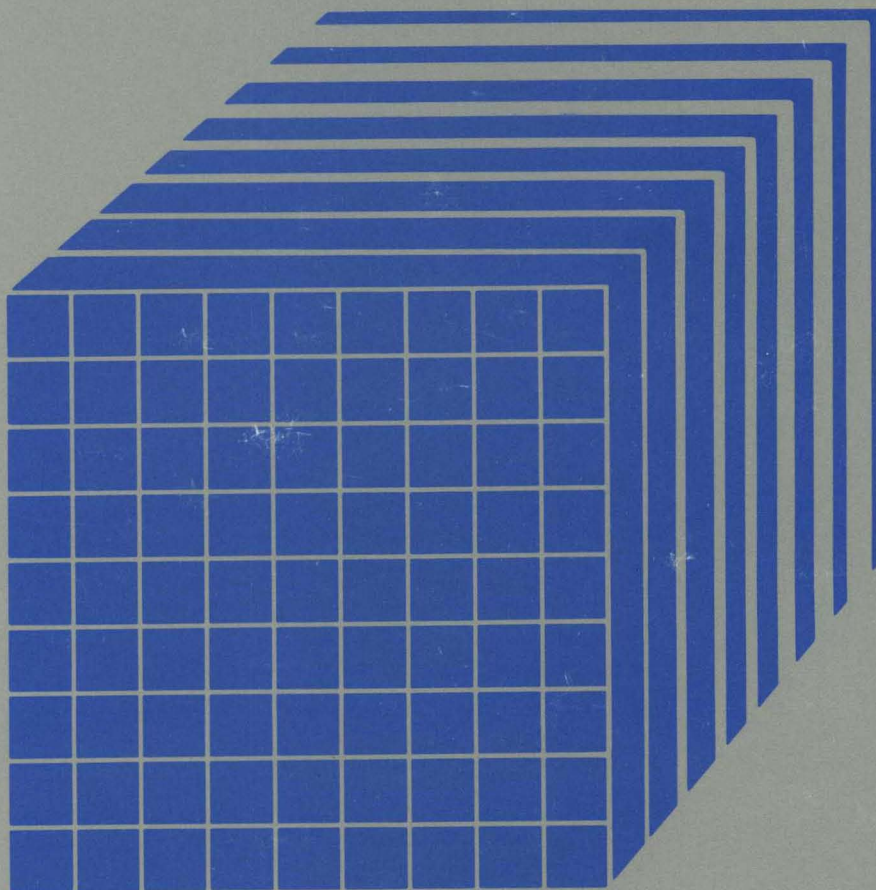



Virtual Machine/ System Product

General Information

Release 4

GC20-1838-4

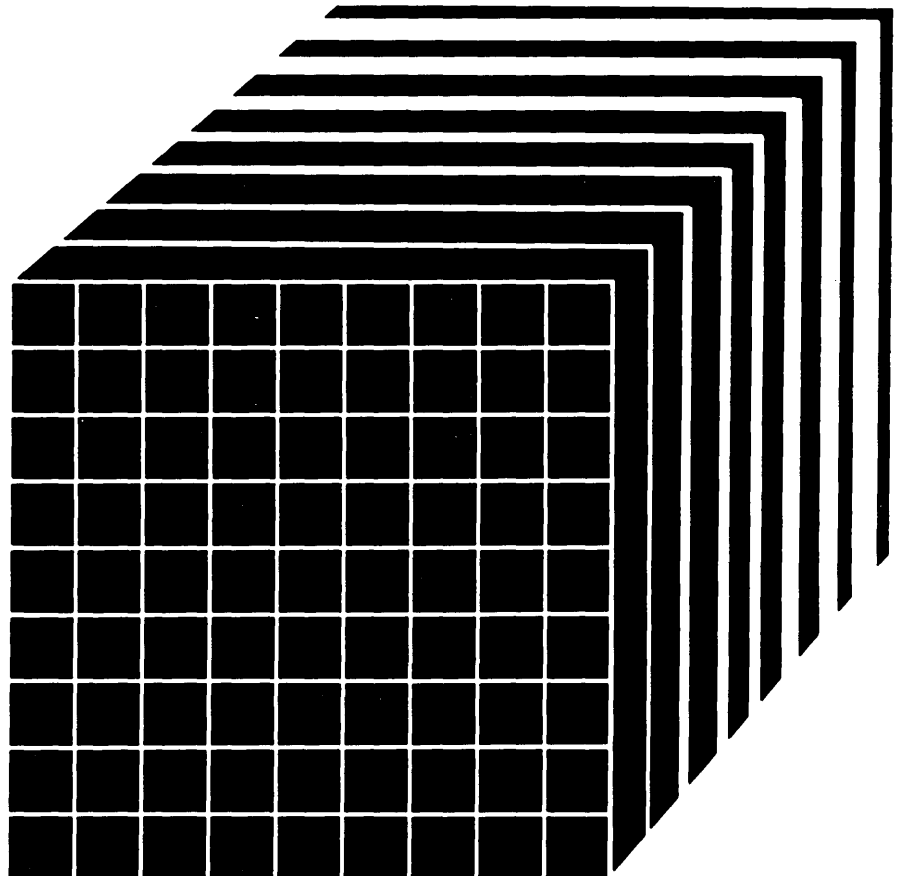

Fifth Edition (June 1984)

This edition, GC20-1838-4, is a revision of GC20-1838-3 and applies to Release 4 of Virtual Machine/System Product (VM/SP), program number 5664-167, and to all subsequent versions and modifications until otherwise indicated in new editions or Technical Newsletters. Changes are made periodically to the information herein; before using this publication in connection with the operation of IBM systems, consult the latest *IBM System/370 and 4300 Processors Bibliography*, GC20-0001, for the editions that are applicable and current.

References in this publication to IBM products, programs, or services do not imply that IBM intends to make these available in all countries in which IBM operates. Any reference to an IBM program product in this publication is not intended to state or imply that only IBM's program product may be used. Any functionally equivalent program may be used instead.

Ordering Publications

Requests for IBM publications should be made to your IBM representative or to the IBM branch office serving your locality. Publications are *not* stocked at the address given below.

A form for readers' comments is provided at the back of this publication. If the form has been removed, comments may be addressed to IBM Corporation, Programming Publications, Dept. G60, P.O. Box 6, Endicott, NY, U.S.A. 13760. IBM may use or distribute whatever information you supply in any way it believes appropriate without incurring any obligation to you.

Preface

Who Should Read This?

The installation manager, system analyst, and anyone who will evaluate the features of VM/SP and its applicability to their installation.

What You Should be Able to Do after Reading This Book

- Have a basic understanding of what the IBM Virtual Machine/System Product (VM/SP) is and what it can do.
- Decide if your installation can use VM/SP.

How to Use This Book

Each chapter begins with a boxed section that summarizes the material that will be in the chapter. The highlighted terms that appear in the text are defined in the glossary. These terms are highlighted only the first time they are used.

VM/SP Publications

You can find more information about VM/SP publications in the *VM/SP Library Guide and Master Index*, GC19-6207.

Contents

VM/SP Features and Facilities	1
Overview—How VM/SP Can Enhance Your Installation	2
VM/SP Provides Time-sharing and Multiprogramming to Your System	2
VM/SP Adds Flexibility to Your System	2
VM/SP Is Easy to Use	2
Different Kinds of People Can Use VM/SP	3
Applications Can Extend VM/SP	4
VM/SP Features—How VM/SP Works	6
What a Virtual Machine Is	6
VM/SP CP and CMS Components	8
How VM/SP Uses Disk Space	10
Operating in an Interactive, Time-Sharing Environment	11
VM/SP Facilities—Some of What You Can Do with VM/SP	13
Editing Files under VM/SP	13
Customizing with the System Product Interpreter	14
Handling Messages with the Programmable Operator Facility	15
Making VM/SP Do More for You	17
Communicating with Other Systems	18
Advanced Communications Functions for VTAM (ACF/VTAM) Version 3	18
Remote Spooling Communications Subsystem (RSCS) Networking Version 2	19
VM/Pass-Through Facility (PVM)	19
Increasing Your Ability to Access Data	20
Structured Query Language/Data System (SQL/DS)	20
Extending the Application Capability of VM/SP	21
Managing Your VM/SP System	23
VM/Interactive Problem Control System (VM/IPCS)	23
VM/Interactive Productivity Facility (VM/IPF)	23
Directory Maintenance	24
Running Multiple Operating Systems under VM/SP	25
Running Multiple Operating Systems at the Same Time	26
Operating Systems that VM/SP Supports	28
System Configuration for VM/SP	29
Processors and Devices that Work with VM/SP	30
Determining Your System Configuration	31
System Administration	33
System Administration Tasks	34
Assigning Tasks to Individuals	35

Contents (continued)

Security with VM/SP	37
System Integrity	38
Methods of Security Control	39
VM/SP Performance	43
What You Should Know about Performance	44
Ways to Optimize Virtual Machine Performance	45
Measuring and Analyzing Performance	47
Migration	49
Migrating from VM/SP to VM/SP	50
Migrating from One Operating System to Another Operating System	51
Installation and Service of VM/SP	53
Installing VM/SP with a Starter System	54
Servicing Your VM/SP System	55
Analyzing and Recording Errors	56
Glossary	57
Index	59

Figures

1. VM/SP Means Many Things to Many People	5
2. Virtual Machine Relationships to Real Devices	7
3. A VM/SP Environment	8
4. Virtual Machines with Their Own Operating Systems	27
5. Real and Virtual Machine Configurations	32
6. A Sample VM/SP Directory Entry (Showing Userid and Logon Password)	39
7. A Sample VM/SP Directory Entry (Showing Access Passwords)	40

VM/SP Features and Facilities

This chapter contains the following:

1. **“Overview—How VM/SP Can Enhance Your Installation”** — VM/SP provides time-sharing, multi-programming, and adds flexibility to your system. Different people can use VM/SP in a variety of applications.
2. **“VM/SP Features—What Makes up VM/SP”** — The Control Program and the Conversational Monitor System make up VM/SP. VM/SP operates interactively, supporting virtual machines and storing data in virtual disks.
3. **“VM/SP Facilities—Some of What You Can Do with VM/SP”** — Users can edit files, and customize and create commands and application programs. System operators can handle messages easily.

Overview—How VM/SP Can Enhance Your Installation

Virtual Machine/System Product (VM/SP) is an operating system that shares resources so your computing system can be more productive.

With VM/SP, users each have the functional equivalent of a computing system (a virtual machine) at their fingertips. Virtual machines are not real, but can do work like a real system. VM/SP is an interactive system that provides file management, an English-like command language, and a full screen editor. A wide range of application programs can complement VM/SP's basic functions.

VM/SP Provides Time-sharing and Multiprogramming to Your System

When you use virtual machines in your system, you can extend time-sharing and multiprogramming to your whole system. VM/SP schedules and controls the work that each virtual machine does, and VM/SP manages the time and system resources that do the work for all virtual machines.

Each virtual machine provides functions similar to the real machine and, thus, can share in the real machine's powerful performance.

VM/SP Adds Flexibility to Your System

VM/SP virtual machines can:

- Be of different configurations
- Operate with different operating systems
- Do either batch or interactive processing
- Operate concurrently with other virtual machines.

Because virtual machines are flexible, each user can use configurations that share the resources of the real machine. Data processing personnel don't need to spend time reallocating system resources; VM/SP does it for them.

Virtual machines can do:

- Work that your installation is already doing
- New or advanced applications that just aren't practical without virtual machines.

VM/SP Is Easy to Use

VM/SP provides a stable environment for new users who have never worked on a computing system and whose jobs don't allow them to spend a lot of time learning the system. Inexperienced professionals and non-professionals can quickly learn how to use VM/SP for their personal job needs.

To use VM/SP and, in turn, create a virtual machine involves three basic steps.

1. **Action:** The user does a logon procedure, using a terminal that is attached to the computer by direct connection or by a telephone connection.

Result: The system gives a message with the current time and date. This message means that the user has successfully communicated with VM/SP, and the session has started.

2. **Action:** The user loads the desired operating system into his or her virtual machine with an IPL (Initial Program Load). Your installation can also set up VM/SP to do the IPL automatically.

Result: The system is now ready for the user to do productive work.

3. **Action:** The user ends the terminal session by doing a logoff procedure.

Result: The system gives a message that tells the time, date and other information, and the session ends.

Different Kinds of People Can Use VM/SP

Because you can use VM/SP for a wide variety of purposes, VM/SP makes computing systems available to many people in the organization. There is no typical user of VM/SP, which is one of VM/SP's most valuable qualities—many types of computing environments can use VM/SP.

VM/SP lets each virtual machine be different from all other virtual machines; so, people with different needs and abilities can do many different kinds of work. VM/SP users can choose the operating systems that help them do their jobs. Programmers can design application programs that run in the virtual machines to meet each user's needs and abilities.

Your installation can do any of the following applications in a virtual machine:

- Problem solving
- Editing and text creation
- Program development
- Application testing
- System program testing
- On-line training for users, system operators, and system programmers
- Configuration simulation
- Converting to operating systems other than VM/SP
- Release-to-release transition
- System maintenance verification.

Applications Can Extend VM/SP

The following list is some of the productive work your personnel can do with applications on a VM/SP system.

- Accounting personnel can keep accurate, timely, and readily available financial reports.
- Financial analysts can create models to project investment opportunities.
- Writers can create and edit information.
- Scientific and engineering personnel can design and test their theories before actual work is begun.
- Secretaries can produce office memos.
- System operators and system programmers can receive hands-on training by using a virtual machine rather than using real system time.
- Application programmers can write, test, and support programs in a virtual machine.
- System programmers can try out new versions of operating systems in a virtual machine before they are released for production work.

A user can share data files with other users. The user and the person receiving the files can be on the same real machine or on different real machines. The real machines can be at the same location or at remote locations—even in different parts of the country. Information about transferring data between systems is in “Communicating with Other Systems” on page 18.

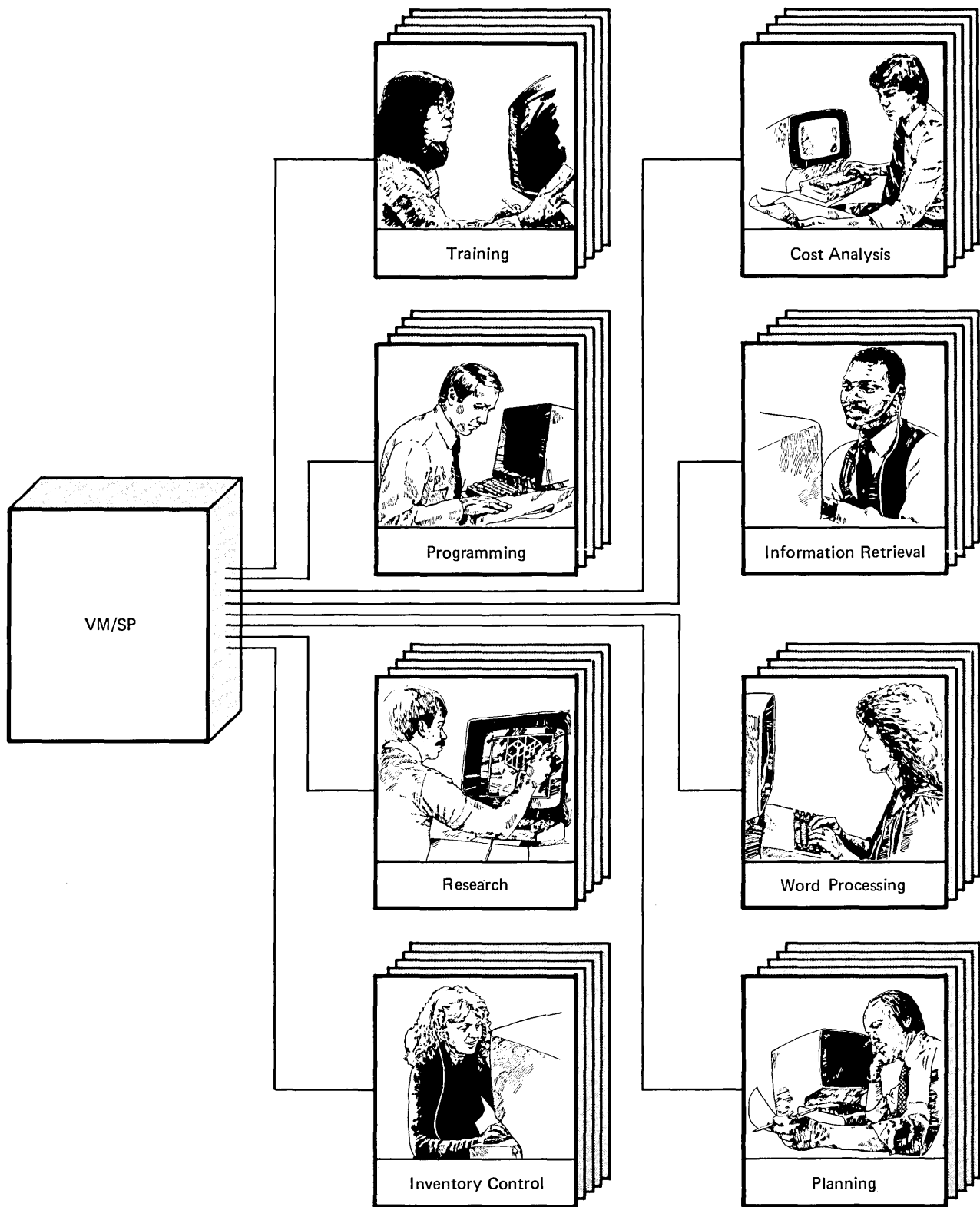

Figure 1. VM/SP Means Many Things to Many People

VM/SP Features—How VM/SP Works

What a Virtual Machine Is

A virtual machine has software and simulated hardware resources that run in a real computer under VM/SP. A virtual machine can do just about anything that a real machine can. While running under VM/SP, a virtual machine produces results like a real machine produces. The virtual machine, or an operating system or application program running in a virtual machine, only affects the real machine in the amount of work the real machine must do.

VM/SP keeps a **directory** that defines each virtual machine. The directory is a Control Program (CP) disk file that describes the virtual system's simulated storage, I/O devices, console, and other information about the user.

When a user enters data into a virtual machine, VM/SP stores it in a **virtual disk** area assigned to the user. VM/SP's **spooling** facilities can then do the following with the data:

- Display it at the user's terminal
- Print it at the real printer
- Punch it into cards
- Store it on magnetic tape
- Transfer it to another user on the same or different physical system.

Virtual devices are not real devices but are simulated in the real machine under control of VM/SP. Figure 2 on page 7 shows the relationship of the virtual devices to the real system. Solid lines show the real devices. The broken lines show the virtual devices simulated on the real devices.

In this figure, a terminal simulates the console of the virtual machine. **Virtual storage** is simulated in the storage of the real machine. The two Direct Access Storage Device (DASD) areas, virtual disks (often called **minidisks**), are simulated on disk devices of the real machine. Other virtual I/O devices (card reader, card punch, and printer) are simulated on a disk device of the real machine.

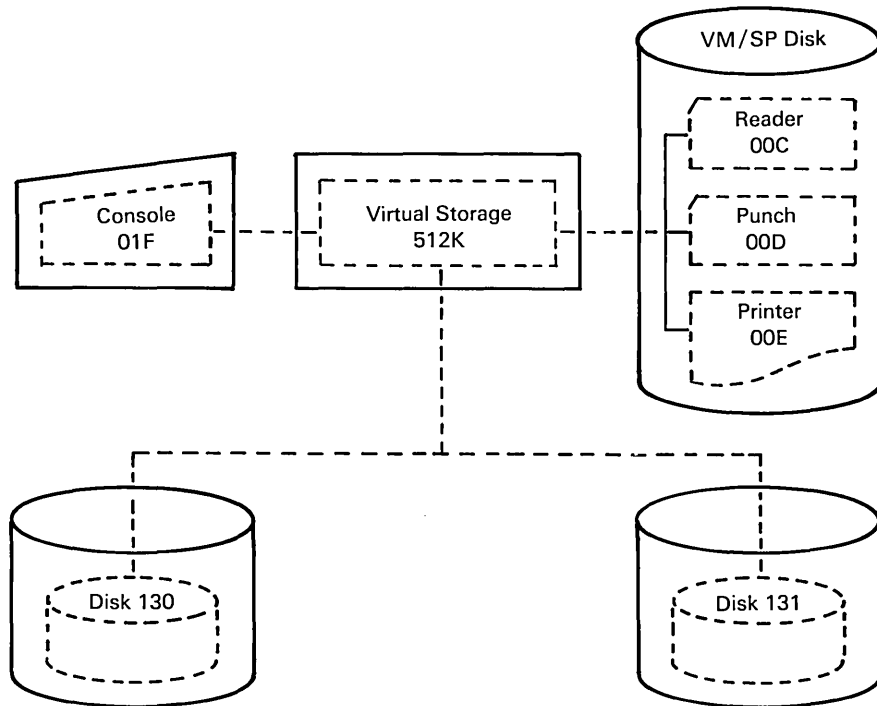

Figure 2. Virtual Machine Relationships to Real Devices

VM/SP Features and Facilities (continued)

VM/SP CP and CMS Components

- The Control Program (CP) component of VM/SP manages your system resources.
- The Conversational Monitor System (CMS) component of VM/SP controls the functions that users run.

What the Control Program (CP) Does

The Control Program (CP) manages the resources of the system and creates virtual machines where operating systems can run. CP supports, as virtual machines, the operating systems that normally control the real processors that VM/SP supports. The operating systems that you can use with VM/SP are listed in “Operating Systems that VM/SP Supports” on page 28. Figure 3 shows CP in relation to several systems, including CMS (VM/SP’s own operating system), Remote Spooling Communications Subsystem (RSCS), and VM/SP Group Control System (GCS).

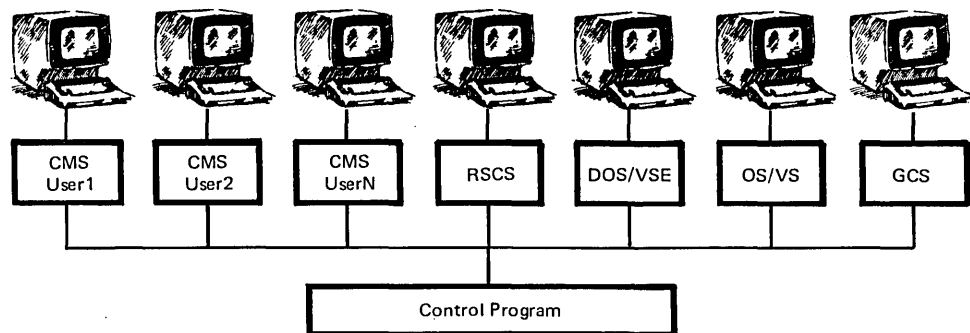

Figure 3. A VM/SP Environment

CP commands let users control the VM/SP system and the virtual machines. The CP commands are divided into **privilege class** groups. Your installation can also reassign commands to privilege class groups for more flexibility. Your installation will assign each user one or more privilege classes. These classes limit a user’s access to certain functions. During program execution, all instructions, both supervisor and problem state, run in the virtual machine as they would run on a real machine.

CP provides services to:

- Convert the virtual machine and real machine addresses
- Dispatch virtual machines
- Control the real machine
- Assign disk space for the virtual machines
- Manage the user’s input and output to the disk.

A virtual machine depends on its own operating system for the access methods and services.

What the Conversational Monitor System (CMS) Does

The Conversational Monitor System (CMS) is the operating system designed for VM/SP, and CMS requires CP. CMS lets users interactively run application programs from a terminal. CMS commands let the terminal user process CMS data stored on DASD. This is covered in more detail in “Operating in an Interactive, Time-Sharing Environment” on page 11.

CMS manages its own files, so users deal with files only on a named basis. Users do not need to preallocate individual file space; instead, CMS deletes and gets space dynamically from the user’s block of allocated space. Because of the file support that CMS provides, users only need to be familiar with the functions they want to run.

CMS users can use the System Product Editor, a full-screen editor that gives users a variety of functions to prepare text and develop programs. In addition, CMS users can use the System Product Interpreter, a command and macro processor that helps users create, change, and run command procedures and application programs. These facilities are described in “VM/SP Facilities—Some of What You Can Do with VM/SP” on page 13.

Because CMS is flexible, a rich variety of application programs can enhance CMS. These application programs can address specific types of end user environments, such as engineering/scientific, application development, office, and the business professional environment.

How VM/SP Uses Disk Space

Under VM/SP, your installation can divide a real direct access storage disk into many small areas called virtual disks (minidisks). These virtual disks are defined in the directory. When you format virtual disks with CMS, the virtual disks are like real disks in function. Your installation can also use virtual disks with Operating System (OS) and Disk Operating System (DOS) data sets or Virtual Storage Access Method (VSAM) files. The GCS component of VM/SP can access CMS files and VSAM data sets but cannot access OS and DOS data sets.

A user can have two types of virtual disks. A user can attach either kind of disk to his virtual machine during a terminal session.

- *Permanent virtual disks*—VM/SP keeps the information on these disks when the user ends the terminal session. A user can access the permanent virtual disk later and retrieve the stored information.

The permanent virtual disks for a user are defined in the directory entry for that user. These permanent virtual disks are assigned to a virtual machine each time a user starts a terminal session with a virtual machine.

- *Temporary virtual disks*—VM/SP keeps the information on these disks only during a terminal session. A user who wants to save the information must transfer it to a permanent virtual disk before ending the terminal session.

A user requests temporary disks after starting the terminal session. These temporary disks are effective until the user releases them or ends the terminal session. CMS lets each user access up to 26 virtual disks.

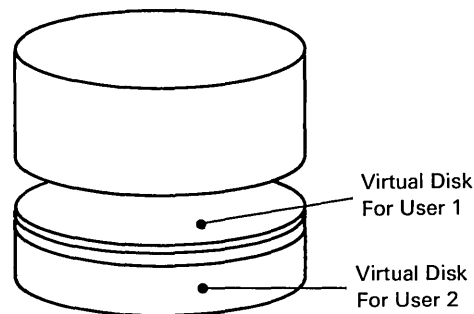

Operating in an Interactive, Time-Sharing Environment

The Conversational Monitor System (CMS) component of VM/SP lets users solve problems and develop programs in an **interactive, time-sharing** environment. CMS carries on a dialog with each terminal user, alternately accepting input and responding to the input. The response is usually so quick that the user does not lose his or her train of thought. Time-sharing systems let a number of users run programs at the same time and interact with the program while it is executing.

Users can issue the commands that are available in VM/SP to control a virtual machine, to do productive work on a virtual machine, and to receive information about a virtual machine. When users issue these commands, VM/SP sends messages to let the users know the status of the requests.

Users can issue commands in an interactive, time-sharing system environment to do the following:

1. Control the virtual machine at a terminal by:
 - Starting and stopping communication with VM/SP
 - Controlling terminal output
 - Controlling how VM/SP processes input lines
 - Controlling keyboard-dependent communications.
2. Monitor and control virtual machine devices and characteristics during a terminal session.
3. Process CMS files (a collection of data on a CMS virtual disk), using CMS commands to do functions, such as:
 - Assemble files
 - Compare one file to another
 - Compile files
 - Copy from one file to another
 - Create files
 - Edit files
 - Erase files
 - List names of files
 - Print files or parts of files
 - Punch files to card
 - Read files instead of editing them
 - Transfer information between files.

VM/SP Features and Facilities (continued)

4. Develop, test, and debug programs. Users can:
 - Create programs and store them directly on the CMS disks
 - Assemble or compile the programs directly from cards, tapes, or OS data sets.

CMS simulates many functions of DOS/Virtual Storage Extended (VSE) in the CMS/DOS environment (CMS/DOS is part of CMS). When a user enters the CMS/DOS environment, he or she can use available commands to develop and test DOS programs. Users can also use the VM/SP commands to display, trace, and change the program instructions that are running in the virtual machine.

VM/SP Facilities—Some of What You Can Do with VM/SP

Editing Files under VM/SP

The System Product Editor gives users a wide range of functions to process text and develop programs. Users can run the System Product Editor with display terminals or typewriter terminals.

With the System Product Editor users can create files, make changes to files, and transfer data between files. The system stores these files in the user's virtual disk.

When a user edits a file, it is displayed at his or her terminal either as a full screen or as a single line, depending on the terminal. After a user makes all the changes, the editor returns the file to the user's disk storage area.

With the System Product Editor, users can:

- Customize the full-screen layout to their own needs
- Divide the screen horizontally and/or vertically to look at different views of the same file or different files
- Call the HELP facility, which provides on-line information about any editor subcommand, macro, or any command in the CMS HELP facility
- Associate various colors and extended highlighting features with fields on the XEDIT screen
- Use commands to improve text processing, such as joining and splitting lines. A user can edit a collection of lines that he specifies, while excluding other lines from the display.
- Enter prefix subcommands directly on a displayed line and write prefix macros to create new prefix subcommands.

```
VACATION CAMPING A1 F 80 Trunc=80 Size=8 Line=0 Col=1 Alt=0
```

```
==== * * * Top of File * * *
|...+...1...+...2...+...3...+...4...+...5...+...6...+...7.
==== A CLEAN, CLEAR STREAM TO FISH IN
==== WOOD NEARBY FOR COOKING
==== NO WILD BEARS
==== NOTHING ELSE TO FEAR
==== SOOTHING SURROUNDINGS FOR THE EYE
==== NOTHING TO OFFEND THE EAR
==== NO EARLY RISERS CAMPED NEARBY
==== EASY ON MY HARD-EARNED MONEY
==== * * * End of File * * *
====>
```

```
X E D I T 1 File
```

Customizing with the System Product Interpreter

The System Product Interpreter is a command and macro processor that helps users create, change, and run a wide range of commands and application programs. Users can even run the System Product Interpreter as a desk calculator or mathematical problem solver.

The programming language that the System Product Interpreter uses is an English-like form that is easy to read. The language supports both uppercase and lowercase so the instructions are more readable. Control statements like IF-THEN-ELSE and SELECT-WHEN-OTHERWISE-END and many forms of loops are available. In addition, the interpreter provides interactive symbolic debugging and extensive tracing facilities that a user can start or stop at any time.

The System Product Interpreter can help improve productivity. Users can write customized applications or tailor CMS commands. They may also use the System Product Interpreter to solve one-time or short-term problems by taking advantage of the rich mathematical functions and other built-in functions. For example, users can write expressions that:

- Have no data length restrictions
- Use fixed or floating point decimal or scientific notation with precision that the user specifies
- Use any of a full set of arithmetic, character, comparative, and logical operators with both operator precedence and parentheses supported.

Data processing professionals can use the System Product Interpreter to define application prototypes, create interactive department applications, or write System Product Editor macros. Users can use the powerful string parsing and text manipulation capabilities or the comprehensive function call and subroutine support that the System Product Interpreter provides. The System Product Interpreter runs in both the CMS and the GCS environments.

Handling Messages with the Programmable Operator Facility

The Programmable Operator Facility increases the system operator's productivity and lets remote users operate systems in a distributed data processing environment; it previews all messages directed to its virtual machine and handles them according to programmed actions. The Programmable Operator Facility determines if a message should be recorded for future reference, handled by a programmable operator action routine, or sent to the operator.

By running the Programmable Operator Facility on VM/SP systems distributed at several different locations (network nodes), an operator at a host site can control a network of systems.

The Programmable Operator Facility also lets your installation run in a **Systems Network Architecture (SNA)** environment with mixed VM, OS/VS, and VSE distributed systems and host systems. The PROP/NCCF Message Exchange (PMX) lets your system link with the Network Communications Control Facility (NCCF). This lets the NCCF operator run distributed VM systems and distributed OS/VS and VSE systems at the same time.

Making VM/SP Do More for You

This chapter contains the following:

1. **“Communicating with Other Systems”** — VM/SP can function in both SNA and non-SNA networks.
2. **“Increasing Your Ability to Access Data”** — SQL/DS helps users who have little data processing experience access information in structured data bases.
3. **“Extending the Application Capability of VM/SP”** — Many applications are available that enhance your VM/SP system, whether oriented toward application development, engineering/scientific, office and text preparation, or the business professional.
4. **“Managing Your VM/SP System”** — The IPCS component of VM/SP helps system programmers solve software problems. VM/IPF and Directory Maintenance help users do tasks easily.

Note: The products listed in this chapter are only a few of those available. Information about programs and systems that you can use with VM/SP is summarized in the following books:

- *Software Directory*, GB21-9949
- *The Software Catalog*, G320-6531
- *Engineering and Scientific Application Programs Available from Non-IBM Sources*, G320-6739

Communicating with Other Systems

A new component of VM/SP called Group Control System (GCS) supports a native Virtual Machine/Systems Network Architecture (VM/SNA) network. It provides a direct interface to support ACF/VTAM, VTAM-related products, and the RSCS Networking Version 2 program product. Both ACF/VTAM and RSCS Networking Version 2 are described in this section.

The GCS multi-tasking environment lets VM/SP group multiple virtual machines. The virtual machines in a group are related because:

- They can communicate with each other.
- They share common read/write storage.
- They can be controlled by a common supervisor.

Advanced Communications Functions for VTAM (ACF/VTAM) Version 3

ACF/VTAM is the access method, running under GCS, that lets VM/SP function in a SNA network. Following are some benefits that ACF/VTAM support has for VM/SP:

- Other application programs like RSCS can share the SNA network to transmit and receive data.
- ACF/VTAM supports program products that help manage communications networks.
- VM/SP users can use SNA networks to reach other VM/SP systems and ACF/VTAM application programs running in other processors.
- Terminals that a different ACF/VTAM controls may reach VM/SP and be used as virtual machine consoles.
- ACF/VTAM offers alternate routes from terminals to the processor. These alternate routes can make access to virtual machines or other programs more reliable.
- Error recovery support is improved.

ACF/VTAM provides the following services:

- Manages network resources (such as lines, controllers, and terminals)
- Lets application programs share resources
- Permits use of resources without specific knowledge of their addresses
- Establishes, controls, and ends data flow between network elements, like programs and terminals
- Helps data move smoothly through the network

-
- Lets the ACF/VTAM operator monitor and alter the network
 - Lets your installation change an active network's configuration
 - Helps find and fix network problems.

ACF/VTAM can also be part of a network that is made up of more than one ACF/VTAM network and more than one processor.

Remote Spooling Communications Subsystem (RSCS) Networking Version 2

Remote Spooling Communication Subsystem (RSCS) Networking Version 2 is a complete subsystem that operates under GCS. RSCS lets VM/SP run in a network of computer systems. RSCS does the following:

- Sends files to and receives files from systems other than your originating system
- Sends files to local or remote printers
- Receives jobs from remote workstations, submits these jobs into a VM/SP system, and sends the output back to the remote location.

With RSCS, transmission can be over a SNA network, Binary Synchronous Communication (BSC) lines, or channel-to-channel adapters.

For more information about RSCS, refer to *Virtual Machine/System Product Remote Spooling Communications Subsystem Networking Version 2 General Information*, GH24-5055.

Note: You do not need RSCS to spool files to virtual devices (printers, card readers) within a virtual machine or between virtual machines (batch virtual machine, other users) that are on the same real machine.

VM/Pass-Through Facility (PVM)

VM/Pass-Through Facility (VM/PVM) is a program product that lets your VM/SP users, connected by local or remote 3276, 3277, 3278, 3279, and 3290 display terminals, logon to other systems and interactively access applications in them, using 3270 BSC lines.

VM/PVM runs in its own virtual machine and interfaces with the VM/SP control program.

Increasing Your Ability to Access Data

Structured Query Language/Data System (SQL/DS)

Structured Query Language/Data System (SQL/DS) helps users access information stored in structured data bases, even users with little data processing experience. SQL/DS helps users handle data better by providing data base support with:

- Security
- Data integrity
- Recovery
- Ease of use
- Increased storage capacity
- Data sharing.

Highlights of SQL/DS VM support include:

- CMS users can interactively access data stored in a data base by:
 - Using the Interactive SQL (ISQL) component of SQL/DS
 - Using the SQL/DS DBS utility.
- Users can write PL/I, COBOL, VS FORTRAN, and Assembler programs that contain SQL statements to access data stored in a data base.
- More than one CMS user can have access to the same data base at the same time; SQL/DS security facilities prevent users from interfering with each other.
- Several SQL/DS data bases can be operational in multiple user mode at the same time. System programmers can set up different data bases on VM/SP for different application areas or user groups.

Extending the Application Capability of VM/SP

Many applications are available to enhance your VM/SP system. Some are designed for programmers, while others are designed for people with little or no data processing experience.

The program products described in this section are listed under the environments where you can use them. Of course, you can use many programs in more than one environment. For example, FORTRAN may be used not only in an engineering/scientific environment, but also in an application development environment. Any environment may use other program products, such as the Professional Office System (PROFS).

If your end user environment is *application development*, the following program products may be useful to you:

- *OS/VS COBOL*

The OS/VS COBOL program product provides advanced programming facilities to reduce program development time, thus increasing programmer productivity.

- *PL/1*

Programming Language/1 is a powerful, general-purpose programming language that helps solve both business and scientific problems.

- *Assembler*

Assembler is a symbolic language that gives your system programmers more program control than using high-level languages.

- *Display Management System (DMS/CMS)*

DMS/CMS can help your installation design, program for, and use displayed panels in an interactive environment.

If your end user environment is *engineering/scientific*, the following program products may be useful to you:

- *VS FORTRAN*

VS FORTRAN is a mathematically oriented high-level programming language, useful for applications ranging from simple problem solving to large-scale numerical systems using optimization techniques.

- *FORTRAN Interactive Debug*

FORTRAN Interactive Debug runs under CMS and enables users to debug FORTRAN programs conversationally.

- *IBM BASIC*

IBM BASIC is an easy-to-use, problem-solving language that lets users write programs in English-like statements.

If your end user environment is oriented toward *office, text preparation, and graphics* tasks, the following program products may be useful to you:

- *Professional Office Systems (PROFS)*

PROFS supplies office functions, such as document preparation, distribution, and retrieval. PROFS also helps an installation do administrative tasks.

- *Document Composition Facility (DCF)*

DCF helps people who have little text formatting experience produce many kinds of formatted text documents, such as specifications, manuals, or proposals.

- *Graphical Data Display Manager (GDDM)*

GDDM is used for graphic applications by several graphic and non-graphic IBM licensed programs.

If your end user environment is oriented toward the *business professional*, the following program products may be useful. You may want to use these products with those already described for the *office* environment.

- *A Departmental Reporting System (ADRS II)*

The business professional with little or no data processing experience can use ADRS II to produce customized reports.

- *VS APL*

APL is an easy-to-use programming language used for a variety of problem-solving applications.

- *APL Data Interface (APL/DI)*

APL/DI provides interactive query facilities to professionals who manipulate large amounts of data.

Managing Your VM/SP System

VM/Interactive Problem Control System (VM/IPCS)

System programmers can use the Interactive Problem Control System (IPCS) component of VM/SP to reduce the time, effort, and expense of solving software problems. VM/IPCS will improve communications between users and the IBM Support Center.

VM/IPCS provides facilities for the following:

1. DIAGNOSING PROBLEMS

System programmers or the Problem Service Representative (PSR) can diagnose a problem from any VM/SP supported terminal without waiting for hard-copy problem data. This is because they can look at disk-resident problem data as it occurs (CP and CMS ABEND dumps and all virtual machine dumps that the VMDUMP command takes).

2. REPORTING PROBLEMS

System programmers can reduce the amount of hard-copy problem data. They can find available fixes for the system faster because IPCS finds duplicate problems on the system and similar problems that IPCS previously met. IPCS gives system programmers a standard way to report problems.

3. MANAGING PROBLEMS

System programmers or the PSR can track and manage problems until they are resolved. With problem and data management facilities, system programmers can:

- Update individual Dump reports and summary status
- Display and print problem reports and status reports
- Print a hard-copy Authorized Program Analysis Report (APAR) and move the problem data to tape so users can submit it to IBM.

Refer to the *VM/SP Interactive Problem Control System Guide*, SC24-5260 for more information about this VM/SP component.

VM/Interactive Productivity Facility (VM/IPF)

Interactive Productivity Facility (IPF) is a program product that uses dialogs to help VM/SP users do a task without issuing commands. The dialogs are sets of related questions and answers between the user and the system. Each dialog gets the data it needs to do the task by communicating with the user through display screens (called "panels"). VM/IPF issues the proper command(s) to do the task when it has gathered all the data that it needs.

Directory Maintenance

Directory Maintenance is a program product that replaces the manual methods of maintaining the directory. It provides easy-to-use, efficient, and secure interactive facilities. The two command classes within Directory Maintenance allow:

- The general user to make simple changes to his or her own directory, such as a password change
- The system administrator to make changes that need centralized control and authorization.

Running Multiple Operating Systems under VM/SP

This chapter contains the following:

1. **“Running Multiple Operating Systems at the Same Time”** — A virtual machine user can run the same operating system as other virtual machines, a different release of the same operating system, or a different operating system.
 2. **“Operating Systems that VM/SP Supports”** — VM/SP lets your installation run guest operating systems or operating systems that require the CP component of VM/SP.
-

Running Multiple Operating Systems at the Same Time

Each virtual machine on a real system runs under control of its own operating system. Because each virtual machine running under VM/SP is independent of other virtual machines, a virtual machine can use:

- The same release of an operating system that another virtual machine is using
- Different releases of the same operating system that another virtual machine is using
- A different operating system than another virtual machine is using.

Users can use copies of the same operating system in different virtual machines to:

- Provide for more than one CMS user
- Improve performance by reducing contention for the operating system by application programs
- Let more than one copy of an application program run at the same time
- Isolate production level operating systems from test level operating systems.

In Figure 4 on page 27, each virtual machine is running with its own operating system in its own virtual storage. Every virtual machine is running under the control of the CP component of VM/SP. The number of virtual machines that can be active depends on your real machine resources (discussed in “Determining Your System Configuration” on page 31).

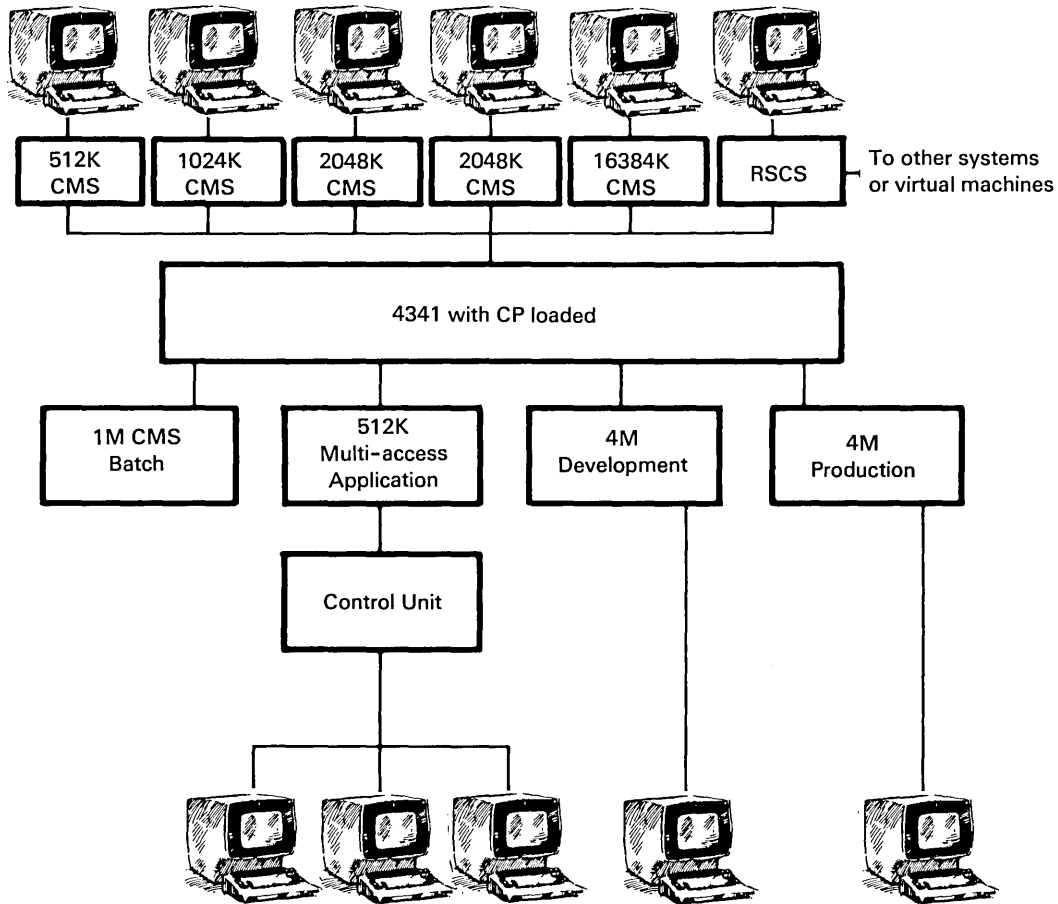

Figure 4. Virtual Machines with Their Own Operating Systems

Operating Systems that VM/SP Supports

In your virtual machines, you can run either guest operating systems or operating systems that depend on the CP component of VM/SP. Guest virtual machine operating systems are operating systems that can run on real hardware. Some guest systems that run under VM/SP are:

- Various releases and versions of DOS such as DOS/Virtual Storage Extended (DOS/VSE)
- Various releases and versions of OS/VS ranging from OS/Primary Control Program (OS/PCP) to OS/VS2 (Multiple Virtual Storage (MVS))
- VM/SP itself.

The functions that these systems provide are usually available when they are running as a "guest" in a VM/SP virtual machine. Your IBM marketing representative can give you a complete list of available guest operating systems.

Operating systems that depend on the CP component of VM/SP are:

- CMS, a single-user system described in "What the Conversational Monitor System (CMS) Does" on page 9
- Group Control System (GCS), a multi-tasking system described in "Communicating with Other Systems" on page 18.

System Configuration for VM/SP

This chapter contains the following:

1. **“Processors and Devices that Work with VM/SP”** — VM/SP can run on most of the currently available System/370 architecture processors and can work with many available devices.
2. **“Determining your System Configuration”** — The configuration that your installation needs depends on your system’s virtual machine characteristics and the devices and processors that your installation will use.

Processors and Devices that Work with VM/SP

Processors that Run VM/SP

VM/SP can run on most of the currently available System/370 architecture processors, including 30XX and 43XX, that have:

- The dynamic address translation facility
- At least 512K bytes of user-accessible storage.

Your IBM marketing representative can give you a complete list of processors on which VM/SP can run.

Devices that VM/SP Can Work With

VM/SP can work with most of the currently available terminals, transmission control units, direct access storage devices, magnetic tapes, printers and printer subsystems, card readers, and card punches. Your IBM marketing representative can give you a complete list of the devices that can currently work with VM/SP.

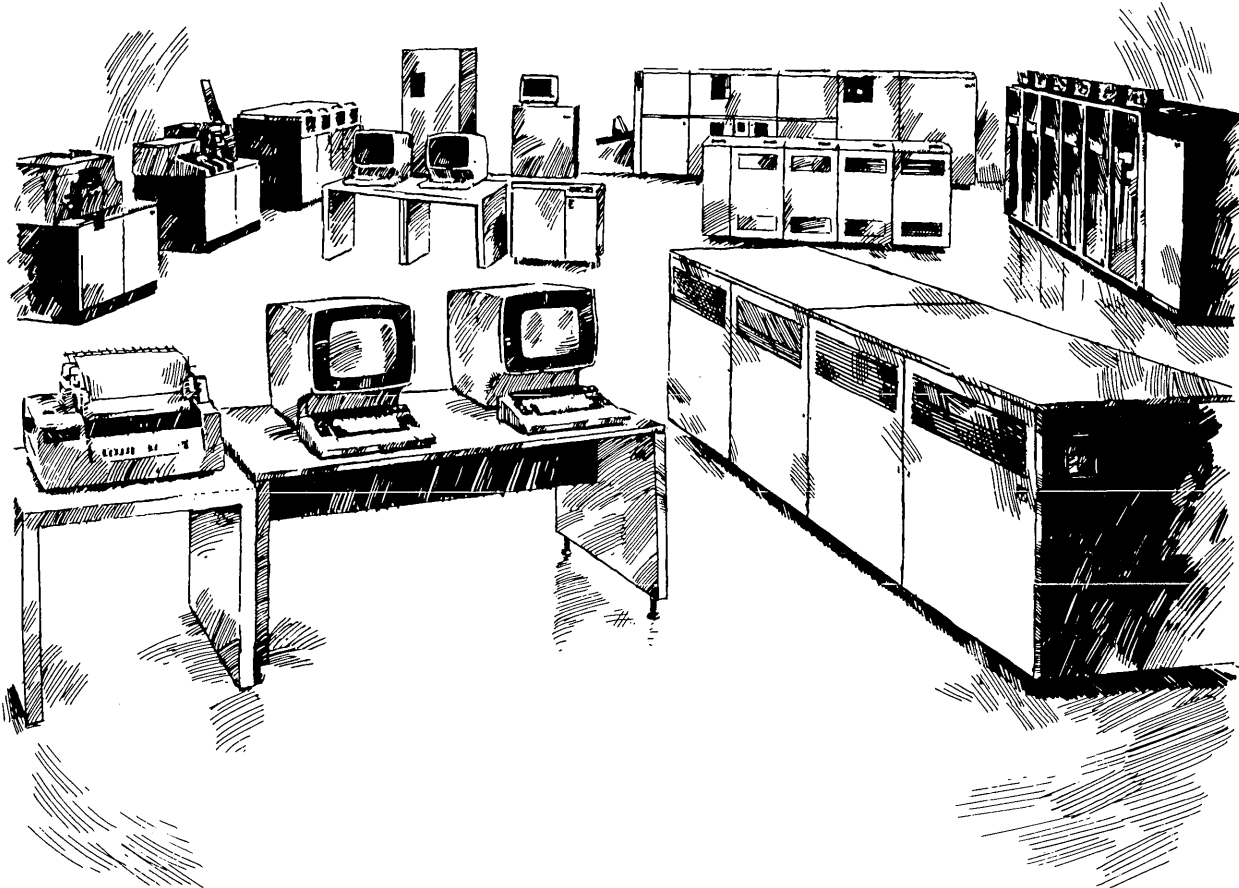

Determining Your System Configuration

Virtual Machine and Hardware Considerations

When determining the system configuration needs for your installation, consider the following virtual machine characteristics:

- Size of the virtual machines
- Configuration of the virtual machines
- Operating systems that users will run in the virtual machines
- Types of jobs that users will run in the virtual machines.

Also consider the system configuration that you have installed or will be installing. This includes:

- Processor type and model
- Amount of real storage
- Number of channels
- Number and type of DASD devices
- Number and type of input/output devices.

The information that you need to accurately assess the system configuration for your installation is not listed here. Your IBM marketing representative can help you plan the best configuration for your installation.

Sample Configuration

Figure 5 on page 32 shows a sample configuration for a real machine and several virtual machines. The real machine configuration has the necessary input/output (I/O) devices, channels, and processor storage that your installation needs to run VM/SP. The real machine is running under control of VM/SP. The virtual devices are not real, but are simulated in the real machine under control of VM/SP.

A terminal becomes the operator console for the virtual machine. The user interacts with the virtual machine through the terminal.

System Configuration for VM/SP (continued)

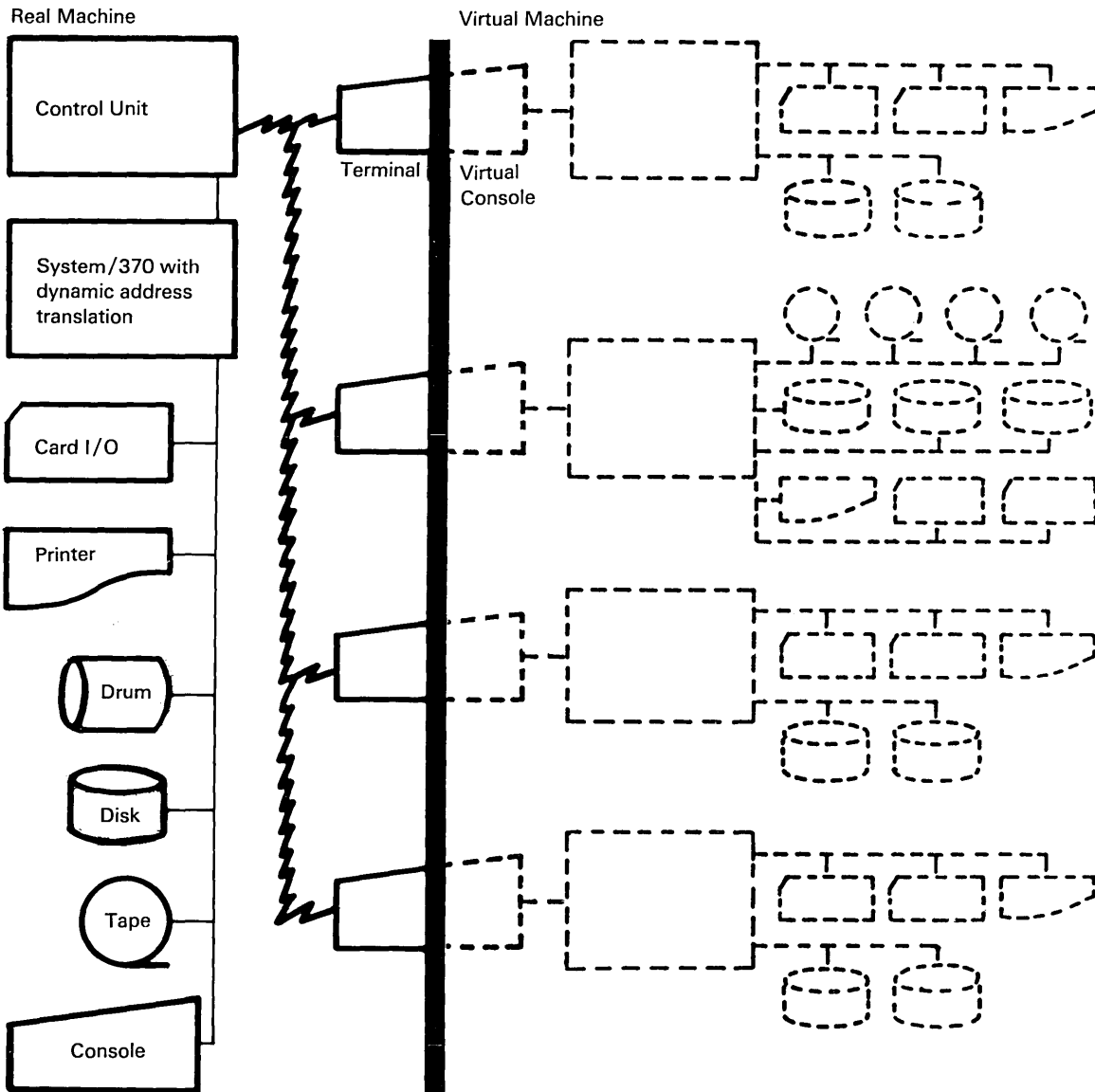

Figure 5. Real and Virtual Machine Configurations

System Administration

This chapter contains the following:

1. **“System Administration Tasks”** — The major tasks are: maintaining the directory, operating the real system, system generation, and examining data about system performance.
2. **“Assigning Tasks to Individuals”** — Your installation will assign a privilege class (or classes) to each user, which determines what tasks the user can do.

System Administration Tasks

The number of people you need to do the system administration tasks for VM/SP depends on your system's size and configuration. System administration tasks are:

- Maintaining the directory, which includes:
 - Letting new VM/SP users access the system
 - Changing the definition of user virtual machines
 - Changing passwords as required
 - Removing directory entries for users who do not need access to the system anymore.
- Operating the real system, which includes:
 - Controlling the real resources of the system
 - Issuing messages to VM/SP users
 - Loading and unloading disk packs as required
 - Loading forms and buffers for printers
 - Mounting and demounting tapes as required
 - Removing printed forms from printers
 - Responding to system messages that need operator intervention.
- System generation, which includes:
 - Doing the initial installation
 - Accommodating changed requirements
 - Installing new releases or service
 - Reflecting the new class structure if your installation changes the IBM-defined privilege classes.
- Examining and saving data about system performance and use.

Assigning Tasks to Individuals

The system administration functions that a specific user can do are determined by the privilege class(es) that the system administrator assigns to that individual. The directory entry for each user identifies the privilege class(es) assigned to the user. The user can only execute commands that are valid for his or her privilege class(es). Your installation can:

- Use the IBM-defined privilege classes, or
- Change the IBM-defined privilege classes to meet your system's individual needs, defining up to 32 privilege classes.

“Security Control by Privilege Class” on page 41 further describes the benefits of privilege classes.

Security with VM/SP

This chapter contains the following:

1. “**System Integrity**” — VM/SP has built-in security features.
2. “**Methods of Security Control**” — VM/SP provides security control at logon, by disk access, and by privilege class.

System Integrity

Programs that run in a virtual machine are authorized by one or both of the following:

- The VM/SP Control Program under your installation's control
- The guest operating system under your installation's control.

With VM/SP system integrity, a program that is not authorized by one of the operating systems:

- Cannot jeopardize or disable the Control Program main or secondary storage protection
- Cannot access any Control Program (CP) password protected resource
- Cannot get control in real supervisor state, with privilege class authority, or with directory capabilities that are greater than what the program was assigned
- Cannot jeopardize the integrity of any guest operating system that has system integrity because of an operation by any VM/SP Control Program facility.

Methods of Security Control

The virtual machine architecture provides data security at several levels without placing undue operating restrictions on users.

Security Control at Logon

A user cannot log on to the VM/SP system without a userid and a password.

- The userid identifies the user to the system.
- The password lets the system recognize the user. Display of the password is suppressed or masked when the user logs on, so others cannot see it.

The userid and password are defined in the directory for the user. Because the password can be made available only to the assigned user, and because the user can change it as required, the password limits access to a virtual machine and its data.

Figure 6 is a sample directory that shows the userid as the characters “userid” and the password as the characters “password” in the USER entry.

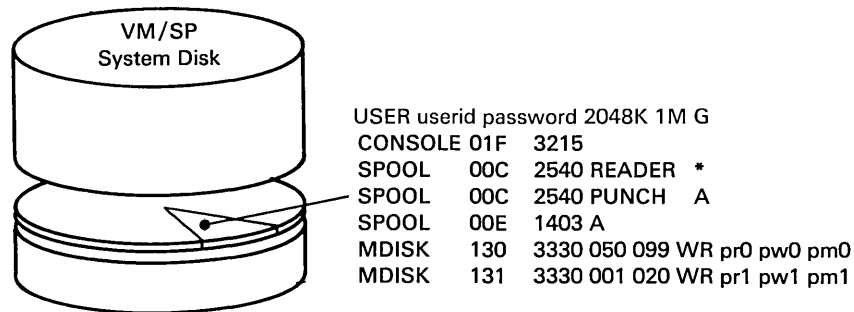

Figure 6. A Sample VM/SP Directory Entry (Showing Userid and Logon Password)

Security Control by Disk Access

Each permanent virtual disk has an access mode that specifies if a user can do one of the following:

- Read from the virtual disk
- Read from and write to the virtual disk.

Users often need to share data or programs, but only one user can own the virtual disk where the data is. Therefore, VM/SP lets users share virtual disks either permanently or temporarily. If a user can only read the shared virtual disks, the user can access the data but cannot change the accessed disk. Your installation can limit data only to users who need the data by grouping information on specific disks and only letting certain users access it.

A user can include permanent access (links) to virtual disks in his or her directory entry. These disks are then part of the user's virtual machine configuration every time he or she logs on to the system.

A user can temporarily access (link) another user's virtual disk by entering, as part of the link procedure, the access password of the virtual disk the user wants to access. The password is defined in the directory of the user who owns the virtual disk. The user who owns the disk can change the access password to control access to his or her virtual disk. Note that the access password is not the same as the logon password.

Figure 7 is a sample directory that shows the access passwords for virtual disk 130 in the MDISK 130 entry to be as follows:

Password:	Allows:
pr0	sharing in read mode
pw0	sharing in read and write mode
pm0	sharing in multiple read and write mode

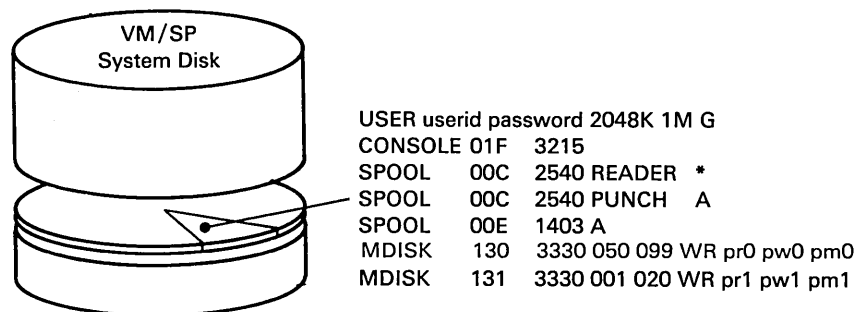

Figure 7. A Sample VM/SP Directory Entry (Showing Access Passwords)

Security Control by Privilege Class

Your installation gains security control by privilege class by:

- Assigning each user one or more privilege class(es)
- Assigning each CP command one or more privilege class(es).

The privilege class for each user is stored in the VM/SP directory. If the user tries to issue a CP command that has a privilege class that does not match his assigned privilege class, the system will not process the command. This prevents users from using system functions that they are not authorized to use.

The privilege class(es) that your installation assigns to the system administrative personnel depends on your system's size and configuration. If your installation is small, one person may be assigned all privilege classes and be expected to do all administrative tasks. If your installation is large, several people may be assigned the same privilege class, for example, several system programmers or primary system operators for different shifts.

Your installation can change the eight IBM-defined privilege classes, which are assigned to the CP commands, to meet your individual needs. Your installation can define a maximum of 32. With the ability to restructure the privilege classes, your installation has considerable security control over resources and information.

VM/SP Performance

This chapter contains the following:

1. **“What You Should Know about Performance”** — How a virtual machine performs depends on virtual machine characteristics and the devices and processors your installation uses. Guest operating systems can run at near native operation levels under VM/SP.
 2. **“Ways to Optimize Virtual Machine Performance”** — Your installation can improve virtual machine performance in respect to time management, storage management, system performance, and guest operating system performance.
 3. **“Measuring and Analyzing Performance”** — VM/SP itself and the VM/370 Performance/Monitor Analysis program help measure and analyze performance.
-

What You Should Know about Performance

Performance of any virtual machine operation is based on:

- How a virtual machine contends with other virtual machines and VM/SP itself for system resources
- The power of the installation's processor, its main storage size, the speed of its I/O devices, the number of defined channel paths to those devices, and the VM hardware assist features of the processor.

When an operating system runs in **native mode**, the one-to-one correspondence between the system resources and the operating system may cause real system resources to be idle part of the time. Your installation can reduce idle system time by taking advantage of the interactive, time-sharing system environment that CMS makes possible.

Because VM/SP and operating systems running under VM/SP contend for some of the same system resources, an operating system running in native mode generally performs better than when running as a guest under VM/SP. However, VM/SP has a **handshaking** facility that runs with some operating systems to make VM/SP and the operating system aware of the capabilities and requirements of each other. The facility eliminates duplication of function in the two operating systems. So, the facility can increase throughput performance to near native operation levels on processors with full VM/SP hardware assist features.

Ways to Optimize Virtual Machine Performance

The specific performance options that may apply to your operation depend on:

- Your system configuration
- The type and amount of work that users do on virtual machines.

Your IBM marketing representative can help you determine the performance options that apply to your installation.

Improving Time Management

To help with time management, your installation can use performance options to:

- Assure a certain percentage of processor time for a particular virtual machine. For example, to favor a batch machine that must compete with other users of the same type.
- Assure that several high-priority virtual machines gain access to the real processor more frequently than other virtual machines.
- Give a designated virtual machine a larger slice of processor time.
- Increase the amount of real time made available to a particular virtual machine.

Improving Storage Management

To help with storage management, your installation can use performance options to:

- Assign pages of a virtual machine's storage to real main storage.
- Reserve a number of areas of real storage that can store a page for a particular virtual machine to use. (This can be done for only one virtual machine at a time.)
- Reserve an area of contiguous storage for a guest operating system to use.

Improving System Performance

The hardware in your installation that affects system performance is:

- The processor model
- The VM hardware assist features
- The size of real storage
- The number of active virtual machines and what they do
- The speed, capacity, and number of paging devices
- The channel, control unit, and DASD contention.

To improve system performance, your installation can:

- Use the virtual machine assist feature to do many of the privileged instruction simulation functions without requiring the virtual machine to leave the problem state. Your installation may want to do this before running production jobs under an operating system in a virtual machine.
- Use extended control program support with the virtual machine assist feature to further reduce the amount of VM/SP real time needed to support virtual machines.
- Use the VM/SP High Performance Option (HPO), a program product that is an extension to VM/SP, to add unique function to VM/SP. This provides a wide range of performance, operational, and RAS (Reliability, Availability, Serviceability) enhancements for large system environments.

Improving Operating System Performance

To improve guest operating system performance, your installation can:

- Use the VM/Virtual Storage (VM/VS) Handshaking (or Linkage Enhancement) feature to cause the processor to directly process instructions that an operating system issues in a virtual machine. The Handshaking feature also lets VM/SP simulate privileged instructions. VM/VS Handshaking is available for the following operating systems running in virtual machines under VM/SP:
 - DOS/VS Release 34 with the Advanced Functions, DOS/VS Program Product
 - DOS/VSE with the VSE/Advanced Functions Program Product
 - VS1 Release 4 and later releases.
- IPL an operating system once and save the contents of virtual storage at some point. Then users can bypass the normal IPL procedure, and VM/SP can get the operating system in page format.
- Use the time and storage management tuning options for the guest operating system virtual machines.

Measuring and Analyzing Performance

VM/SP has commands that:

- Track and measure both VM/SP and virtual machine performance
- Let your installation set options to improve performance.

The VM/370 Performance/Monitor Analysis Program helps reduce and analyze performance data, so your installation can analyze the performance of your existing system.

Migration

This chapter contains the following:

1. **“Migrating from VM/SP to VM/SP”** — A user’s production work is not interrupted when migrating from VM/SP to a newer release of VM/SP.
2. **“Migrating from One Operating System to Another Operating System”** — Your installation can use VM/SP when converting from one operating system to another.

Migrating from VM/SP to VM/SP

Each release of VM/SP is compatible with previous releases of VM/SP. Therefore, if your installation is operating with a currently supported release of VM/SP, you can migrate to a new release of VM/SP to take advantage of the improvements included in the new release.

When VM/SP needs maintenance changes, users can operate under the current version of VM/SP while the person in charge of maintenance verifies the changes in another virtual machine. In effect, maintenance is like migration. Because VM/SP runs on virtual machines, your production work need not be interrupted during maintenance.

Migrating from One Operating System to Another Operating System

Because VM/SP can run multiple operating systems at the same time, your installation can use VM/SP when converting from one production operating system to another. The previous system can continue to run in one virtual machine while the new system runs with converted programs in a separate virtual machine. Your installation can use CMS as an interactive tool to make the necessary program changes and test the changed code.

In some cases when migrating from one operating system to another, the two operating systems cannot share or use each other's data files. If each operating system can run with CMS, the data can be stored in CMS data files. Either operating system can use this data until the application programs are all converted to the new operating system.

Occasionally, your installation may have to write a special application program to run in some operating system other than the production system. With virtual machines, your installation can run the application without dedicating the real system to the other operating system. Use this approach when you want to phase out certain applications without converting them to the new operating system.

Installation and Service of VM/SP

This chapter contains the following:

1. **“Installing VM/SP with a Starter System”** — Your VM/SP system can be installed with a starter system or with the VM/SP System Offering.
2. **“Servicing Your VM/SP System”** — A number of different kinds of services are available to VM/SP installations.
3. **“Recording and Analyzing Errors”** — VM/SP collects errors in its error recording area and generates reports.

Installing VM/SP with a Starter System

Before VM/SP can do work, the person who is responsible for installing VM/SP must do a system generation to create a VM/SP system that meets your installation's needs. He or she will restore the starter system, a small working copy of a basic VM/SP system that helps simplify the system generation procedure. If your installation does not have an earlier version of VM/SP installed, the person installing VM/SP can use a starter system package.

The starter system that your installation needs depends on the DASD devices that your installation uses. Using the starter system, your installation can tailor a VM/SP system to your own hardware configuration. Starter systems are available as separate VM/SP features.

To help install program products to your system, IBM offers VM/SP System Offering, which is a packaging option that simplifies the installation of VM/SP and many often-used program products. Your IBM marketing representative can give you more information about the starter systems and the VM/SP System Offering.

Servicing Your VM/SP System

Your installation may need to apply service to correct any problems that may show up after the system was generated. Services available to VM/SP installations are:

- IBM Field Engineering toll free telephone service, which is available 24 hours a day, 7 days a week
- Program Update Tapes (PUT tapes) that are periodically distributed by IBM

The PUT tape has cumulative service for the system control program and/or service for associated program products for which your installation is licensed. The cover letter that comes with the PUT tape tells how to print the machine readable PUT tape document, what the PUT tape contains, and how to apply service to your system. The PUT tape is customized to your order profile and may occupy more than one tape volume.

- VM/SP supplied service routines

Your installation may need to apply an update to an individual module or apply a fix that is not included in the PUT tape. Also, you may want to change your system to suit your own specifications. *Virtual Machine/System Product: Installation Guide, SC24-5237*, tells you how to update your system using VM/SP service routines.

- Authorized Program Analysis Reports (APARs) so your installation can report problems caused by suspected defects in VM/SP
- Local IBM Field Engineering support at additional cost.

Analyzing and Recording Errors

Operating systems normally write error records to their own error recording data sets. However, when the operating system is running in a virtual machine, CP intercepts most error records that the operating system issues. CP then records the error on the VM/SP error recording cylinders and passes control back to the virtual machine. Therefore, most error records from the operating systems running under VM/SP reside in one error recording area. Errors that VM/SP does not record are recorded in the operating system's error recording area.

Errors that the VM/SP system resident pack records in its error recording area include:

- VM/SP spooling errors
- VM/SP paging errors
- I/O errors caused by a user's CMS or RSCS operation
- I/O errors caused by a diagnostic interface that a user starts
- I/O errors or error-related data that an operating system running in a virtual machine compiles.

A CMS command reads error records from the VM/SP error recording area and can do any of the following:

- Produce printed reports
- Copy the error records to tape
- Clear the error recording area.

The report content depends on the operands that the user specifies with the command and on the input system error records themselves. The input system error records may be from the VM/SP error recording area or from a past tape.

Glossary

Access Mode. A method used by VM/SP to control whether a user can obtain a specific data file. Access modes let users read and write data to a file or only read data from a file.

Auxiliary Storage. Data storage other than main storage; in VM/SP, auxiliary storage is usually a direct access device, which is a device where the access time is effectively independent of the location.

Binary Synchronous Communication. A method of data transmission where synchronization of characters is controlled by timing signals generated at the sending and receiving stations.

Channel-to-Channel Adapter. A hardware device that can connect two channels on the same computing system or on different systems.

Directory. In VM/SP, a CP disk file that defines each virtual machine's normal configuration: the userid, password, normal and maximum allowable virtual storage, CP command privilege class(es) allowed, dispatching priority, logical editing symbols to be used, account number, and CP options desired.

Edit. To interactively make changes, additions, or deletions to a file that is on a disk. The edit function is also used to generate a new file.

Handshaking. A communication interface between VM/SP and another operating system so each system control program is aware of certain capabilities and requirements of the other.

Interactive. An application where each user entry produces a response from a system or program.

Minidisk. (See virtual disk.)

Native Mode. The mode in which an operating system is run stand-alone on the real machine instead of under VM/SP.

Password. A predefined set of 1 to 8 characters that lets the system recognize the user. There are two types of passwords: logon and access. The logon password is

required when a user logs onto VM/SP. The access password is required for a user to gain access (link) to another user's virtual disk.

Privilege Class. The eight IBM-defined classes that let your installation assign specific classes to specific users. They are:

- Class A - operations
- Class B - resource
- Class C - programmer
- Class D - spooling
- Class E - analyst
- Class F - service
- Class G - general
- Class H - reserved for IBM use.

The privilege classes can be changed to meet your own installation's needs.

Real Machine. The actual processor, channels, storage, and input/output (I/O) devices required to operate VM/SP.

Spool, Spooled, Spooling. When the system writes the output data streams on auxiliary storage devices.

System Integrity. When a system protects itself from unauthorized access.

Systems Network Architecture (SNA). A description of the logical structure, formats, protocols, and operational sequences to transmit through and control the configuration and operation of networks.

Terminal. A device, usually equipped with a keyboard and a display, which can send and receive information over a communication channel. With VM/SP the terminal is used to communicate with the system.

Time-Sharing. A number of users can execute computer programs concurrently and interact with the programs during execution.

Userid. A predefined set of 1 to 8 characters that uniquely identifies a user to the system.

Glossary (continued)

Virtual Disk. A physical disk storage device (or part of one) that has its own address, consecutive storage space for data, and an index or description of the stored data so the data can be accessed. (Also called a minidisk.)

Virtual Machine. A functional simulation of a computer and its associated devices, which a user controls from his or her terminal.

Virtual Storage. Storage space that may be regarded as addressable main storage by the user of a computer system where virtual addresses are mapped into real addresses. Virtual addresses refer to this storage or virtual I/O device addresses.

Virtual storage size is limited by the addressing scheme of the computing system and by the amount of auxiliary storage available, not by the actual number of main storage locations.

Index

A

access mode 40, 57
ACF/VTAM 18
administration, system 33
ADRS II 22
APARs 55
APL 22
APL data interface 22
application development 21
application environment 21, 22
 application development 21
 engineering/scientific 21
 office 22
application environments 9
application in a virtual machine 3
assembler 21
auxiliary storage 57

B

basic 22
binary synchronous communication 19, 57

C

channel-to-channel adapter 57
characteristics 2
class, privilege 41
CMS 9, 28
 commands 9, 11
 disk space use 10
 file management 9
 file, defined 11
 files 11
 functions provided 9
 virtual machine operating system 28
COBOL 21

command and macro processor 9, 14
 functions 14
 system product interpreter 14
commands
 cms 9, 11
 cp 8
communicating with other systems
 ACF/VTAM 18
 group control system 18
 RSCS 19
 VM/pass-through facility 19
communications and network management 18
components of VM/SP 8
configurations 30
considerations, performance 44
control program
 See CP
conversational monitor system
 See CMS
CP 8
 as resource manager of system 8
 commands 8

D

DASD 6
data base 20
data files 11
DCF 22
debugging programs 12
departmental reporting system 22
developing programs 12
devices supported by VM/SP 30
diagnosing problems 23
directory 6, 10, 39, 40, 57
directory maintenance 24
disk access 40
disk space, use of 10
display management system 21
DMS/CMS 21
document composition facility 22

Index (continued)

E

edit 13, 57
editor 9, 13
 functions 13
 system product editor 13
error recording and analysis 56
extended control program support 46
extending application capability 21
extending the application capability of VM/SP
 application development 21
 business professional 22
 engineering/scientific 21
 general office tasks 22

F

field engineering support 55
file definition, CMS 11
fortran 21
FORTRAN Interactive Debug 21

G

GDDM 22
 graphical data display manager 22
group control system 18
guest virtual machine operating systems 28

H

handshaking 57
how to use VM/SP 2

I

IBM Basic 22
IBM Field Engineering support 55
increasing your ability to access data
 SQL/DS 20
initial program load (IPL) 3
installation and service of VM/SP 53
interactive 11, 57
interactive debug 21
interactive problem control system 23
interactive productivity facility 23
interactive time-sharing environment 11
introduction to VM/SP 1
IPF 23

J

job control statements, not required with VM/SP 9

L

language processors used with VM/SP 17
licensed programs used with VM/SP 17
logoff 3
logon 3

M

macro processor 14
managing problems 23
managing terminal communications 11
managing virtual machine resources 11
managing your VM/SP system
 directory maintenance 24
 VM/IPCS 23
 VM/IPF 23
migration 49
minidisk 6, 10, 57
multiprogramming 2

N

network management 18

O

operating in an interactive time-sharing environment 11
operating system performance 46
operating systems
 CMS virtual machine 28
 GCS virtual machine 28
 guest virtual machine 28
 in a virtual machine 2, 8, 26
 supported by VM/SP 28
 used with VM/SP 17
operator
 programmable 15
optimizing virtual machine performance 45
options
 extended control program support 46
 performance 45
 virtual machine assist 46

OS/VS COBOL 21

P

pass-through facility 19
password
 access 40, 57
 logon 39, 57
performance 43
 analysis 47
 considerations 44
 measurement 47
 system 46
permanent disks 10
PL/1 21
privilege class 41, 57
problems, reporting 55
processing CMS files 11
processors supported by VM/SP 30
productive work with VM/SP 4
professional office systems 22
PROFS 22
program update tape 55
programmable operator facility 15
programs
 debugging 12
 developing 12
 testing 12
PUT tape 55

R

real machine 2, 57
reporting problems 23, 55
resource manager 8
RSCS 19
 in a virtual machine 19
running multiple operating systems concurrently 26

S

security
 attributes of VM/SP 37
 control at logon 39
 control by disk access 40
 control by privilege class 41
service 55
service of VM/SP 53
servicing VM/SP 55
sharing system functions 2
SNA 57
spool 57
SQL/DS 20

starter system 54
storage management 45
storage, auxiliary 57
structured query language/data system 20
support center services 55
supported operating systems 28
system administration 33
system configurations 30
system functions, shared by virtual machines 2
system integrity 57
system management 23
system performance 45
system product editor 9, 13
system product interpreter 9, 14
system resources managed by VM/SP 2
Systems Network Architecture (SNA) 57

T

temporary disks 10
terminal 31, 57
terminal communications, managing 11
testing programs 12
time management 45
time sharing 2, 11, 57
time-sharing environment 11

U

use of CMS disk space 10
userid 39, 57

V

virtual disk 6, 10, 58
virtual machine 2, 6
 assist 46
 controlling of 2
 definition 2, 58
 directory 6
 equivalent to a real computing system 6
 flexibility 2
 illustrated 32
 optimizing performance 45
 performance optimizing 45
 programmable operator facility 15
 resources, managing 11
 scheduling of 2
 sharing system functions 2
virtual storage 2, 6, 58
VM/IPCS 23
VM/pass-through facility 19
VM/PVM 19

VM/SP

- command and macro processor 14
- components 8
- control functions 2
- devices supported by VM/SP 30
- disk space use 10
- editor 13
- environment 8
- how to use 2
- in your installation 3
- installation 53
- introduction 1
- macro processor 14
- managing of system resources 2
- performance 43
- processors supported by VM/SP 30
- security 37
- service 53, 55
- system administration 33

VS APL 22
VS FORTRAN 21

W

what can VM/SP mean to your installation 3

Y

your installation's system configuration. 31





VM/SP
General Information
Order No. GC20-1838-4

READER'S
COMMENT
FORM

This manual is part of a library that serves as a reference source for systems analysts, programmers, and operators of IBM systems. You may use this form to communicate your comments about this publication, its organization, or subject matter, with the understanding that IBM may use or distribute whatever information you supply in any way it believes appropriate without incurring any obligation to you.

Your comments will be sent to the author's department for whatever review and action, if any, are deemed appropriate. Comments may be written in your own language; English is not required.

Note: *Copies of IBM publications are not stocked at the location to which this form is addressed. Please direct any requests for copies of publications, or for assistance in using your IBM system, to your IBM representative or to the IBM branch office serving your locality.*

Your comments:

Note: Staples can cause problems with automated mail sorting equipment.
Please use pressure sensitive or other gummed tape to seal this form.

If you would like a reply, please supply your name and address on the reverse side of this form.

Thank you for your cooperation. No postage stamp necessary if mailed in the U.S.A.
(Elsewhere, an IBM office or representative will be happy to forward your comments or you may mail directly to the address in the Edition Notice on the back of the title page.)

Reader's Comment Form

Cut or Fold Along Line

Fold and Tape

Please Do Not Staple

Fold and Tape



NO POSTAGE
NECESSARY
IF MAILED
IN THE
UNITED STATES

BUSINESS REPLY MAIL
FIRST CLASS PERMIT NO. 40 ARMONK, N.Y.

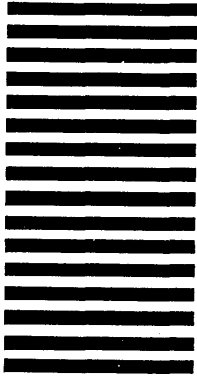

POSTAGE WILL BE PAID BY ADDRESSEE:

International Business Machines Corporation
Department G60
P. O. Box 6
Endicott, New York 13760

Fold

Fold

If you would like a reply, *please print*:

Your Name _____

Company Name _____ Department _____

Street Address _____

City _____

State _____ Zip Code _____

IBM Branch Office serving you _____



VM/SP General Information (File No. S370/4300-00) Printed in U.S.A. GC20-1838-4

GC20-1838-4

VM/SP General Information (File No. S370/4300-00) Printed in U.S.A. GC20-1838-4

IBM[®]