



# AIR TRAINING COMMAND

COMPUTER SYSTEMS DEPARTMENT

## CIRCUITS AND DIAGRAMS

AN/FSQ-7 DISPLAY SYSTEM SCHEMATICS

VOLUME I

5 JANUARY 1965

Course Nr. ABR30533-1

**KEESLER AFB, MISS**



This Schematics and Logic Diagrams Book provides student study material in support of Type II and Type III computer maintenance courses relating to WSL16L.

**SCHEMATICS**  
**FOR**  
**DISPLAY SYSTEM**  
**OF**  
**AN/FSQ-7**  
**COMBAT DIRECTION CENTRAL**

**VOLUME I**

The work reported in this document was performed under a government contract; information contained herein is of a proprietary nature. ALL INFORMATION CONTAINED HEREIN SHALL BE KEPT IN CONFIDENCE. No information shall be divulged to persons other than IBM employees authorized by the nature of their duties to receive such information or individuals or organizations who are authorized in writing by the Department of Engineering or its appointee to receive such information. GOVERNMENT RELEASE MUST BE OBTAINED THROUGH THE IBM PATENT DEPARTMENT BEFORE THIS INFORMATION MAY BE USED FOR COMMERCIAL APPLICATIONS.

This student study material has been reproduced intact from materials printed by IBM Corporation, Kingston, New York.

MILITARY PRODUCTS DIVISION  
INTERNATIONAL BUSINESS MACHINES CORPORATION  
KINGSTON, NEW YORK

LOGIC	DESCRIPTION
2. 2. 1	MDI DRUM ENTRY SECTION
2. 2. 2	MDI DIRECT ENTRY SECTION CORE MATRIX
2. 2. 2- 2	MDI DIRECT ENTRY SECTION CORE MATRIX
2. 2. 2- 3	MDI DIRECT INTERCONNECTION PANELS D&H
2. 2. 2- 4	MDI DIRECT INTERCONNECTION PANELS C&G
2. 2. 2- 5	MDI DIRECT INTERCONNECTION PANELS B&F
2. 2. 2- 6	MDI DIRECT INTERCONNECTION PANELS A&E
4. 0. 5- 6	UNIT SUPPLEMENT CHART UNIT 24 MODULE J & K
4. 1. 1	SD INPUT SWITCHES, GATES AND TRANSFERS INP. SW. GTS AND XFER
4. 1. 1- 2	SD INPUT SWITCHES, GATES AND TRANSFERS XFER CKTS
4. 1. 2	SD WORD 0 STORAGE
4. 1. 3	SD WORD 5 STORAGE
4. 1. 4	SD WORD 6 STORAGE
4. 1. 5	SD WORD 7 STORAGE
4. 1. 6	SD WORD 1 STORAGE X, Y REG.
4. 1. 7	SD WORD 2-DAB STORAGE
4. 1. 8	SD WORD 3-DAB STORAGE
4. 1. 9	SD WORD 4-DAB STORAGE
4. 1.10	SD CHARACTER SELECTION X SEL REG
4. 1.10- 2	SD CHARACTER SELECTION Y SEL REG
4. 1.10- 3	SD CHARACTER SELECTION X & Y SEL. DEC. & ALD
4. 1.11	SD CHARACTER POSITIONING
4. 1.12	VECTOR GENERATION VECT. REG.
4. 1.12- 2	VECTOR GENERATION VECT. GEN. & VECT. INT. GEN.
4. 1.13	CATEGORY DRIVERS
4. 1.14	DAB DRIVERS
4. 1.15	SUPPLEMENTARY DRIVERS
4. 1.16	X & Y DRIVERS
4. 1.17	TEST MIXING DRIVERS
4. 1.18	RADAR & MIXED RADAR CATEGORY DRIVERS
4. 1.19	FEATURES A, B, C, D, PT., & SYMBOL SEQUENCER
4. 1.20	SD DISTRIBUTOR AND TIMER
4. 1.21	MISC. CONTROLS
4. 1.22	DAB DUMMY LOADS
4. 1.23	DD & MISC. DUMMY LOADS MISC. DUMMY LOADS

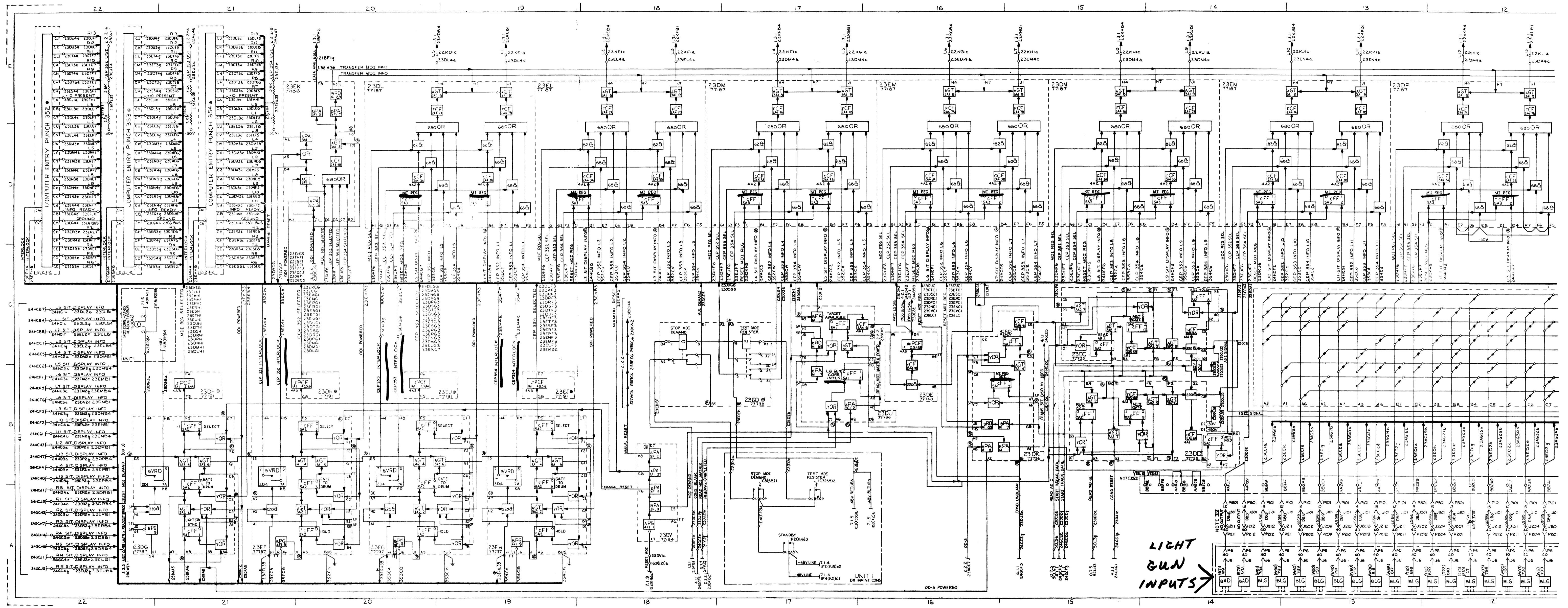

LIGHT GUN INPUTS

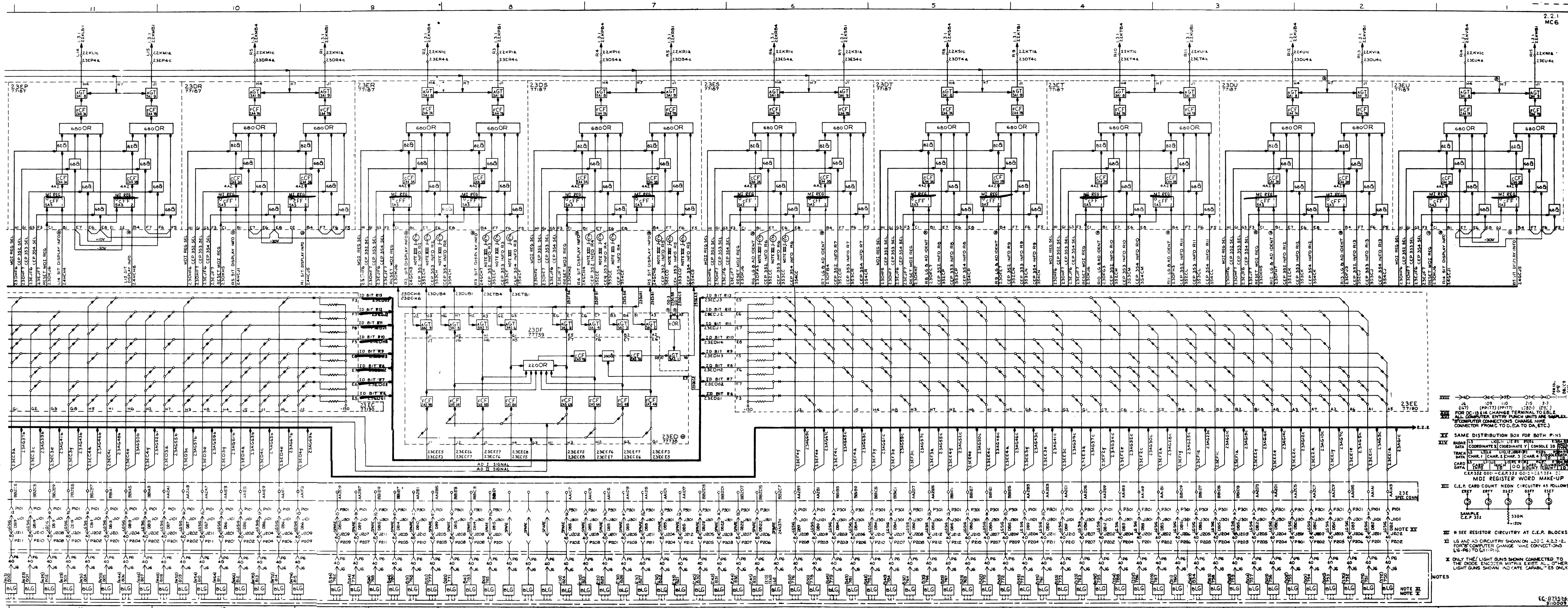

MDI DRUM ENTRY SECTION

- III C.P. CARD COUNT NEON CIRCUITRY AS FOLLOWS:
- IV SAME DISTRIBUTION BOX FOR BOTH PINS
- V LG AND AD CIRCUITRY SHOWN ON 23E63-23E66 FOR COMPUTER CONNECTIONS CHANGE WIRE CONNECTOR (L6-P6) TO (U1-P1).
- VI ONLY THE LIGHT GUNS SHOWN CONNECTED TO THE DOOR ENCODER MATRIX EXIST ALL OTHER LIGHT GUNS SHOWN AND ARE CAPABLE TO ONLY.

WP 177C2

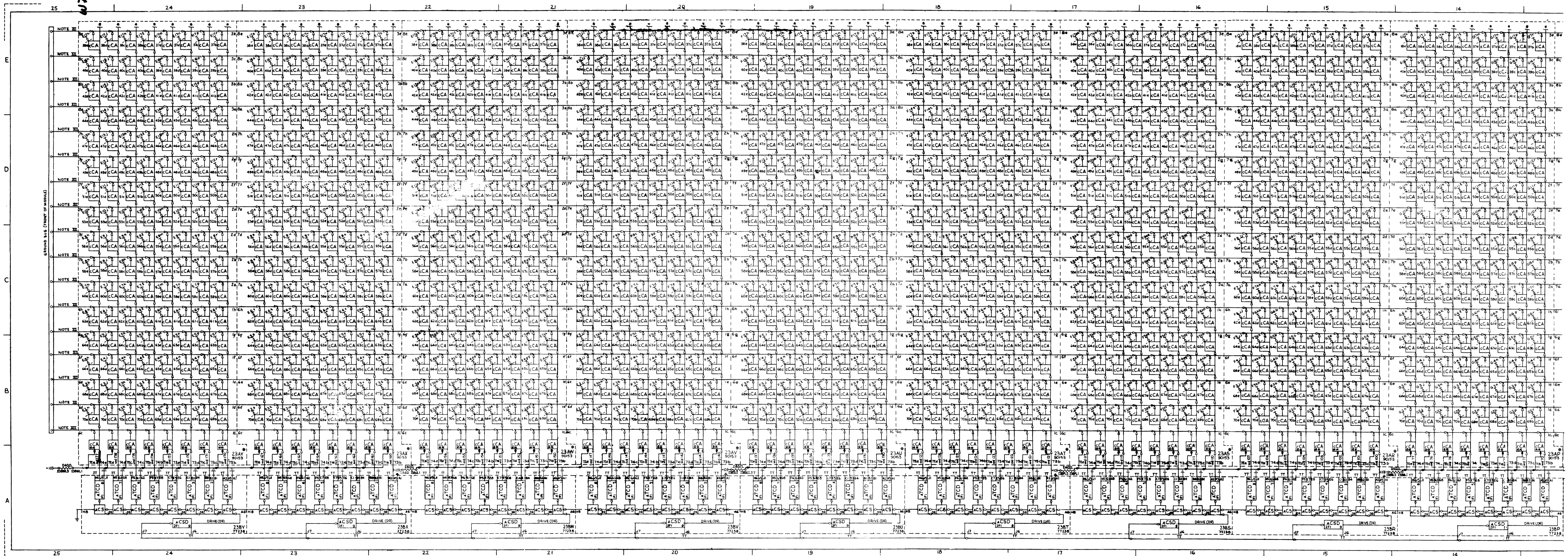

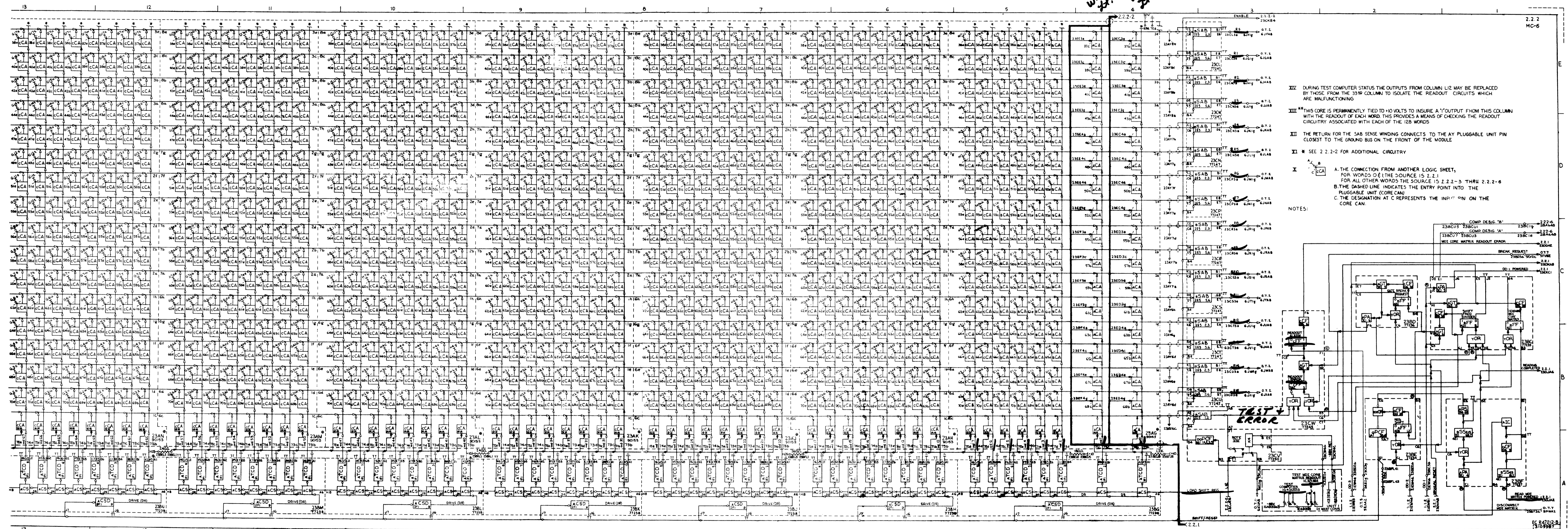

- XIV DURING TEST COMPUTER STATUS THE OUTPUTS FROM COLUMN L12 MAY BE REPLACED BY THOSE FROM THE 33RD COLUMN TO ISOLATE THE READOUT CIRCUITS WHICH ARE MALFUNCTIONING
- XIII THIS CORE IS PERMANENTLY TIED TO +10 VOLTS TO INSURE A "1" OUTPUT FROM THIS COLUMN WITH THE READOUT OF EACH WORD. THIS PROVIDES A MEANS OF CHECKING THE READOUT CIRCUITRY ASSOCIATED WITH EACH OF THE 128 WORDS
- XII THE RETURN FOR THE 5AB SENSE WINDING CONNECTS TO THE AY PLUGGABLE UNIT PIN CLOSEST TO THE GROUND BUS ON THE FRONT OF THE MODULE
- XI SEE 2.2-2-2 FOR ADDITIONAL CIRCUITRY
- X
  - A. THE CONNECTION FROM ANOTHER LOGIC SHEET, FOR WORDS OF THE SOURCE IS 2.2-1.
  - FOR ALL OTHER WORDS THE SOURCE IS 2.2-2-3 THRU 2.2-2-6
  - B. THE DASHED LINE INDICATES THE ENTRY POINT INTO THE PLUGGABLE UNIT (CORE CAN)
  - C. THE DESIGNATION AT C REPRESENTS THE INPUT ON THE CORE CAN.

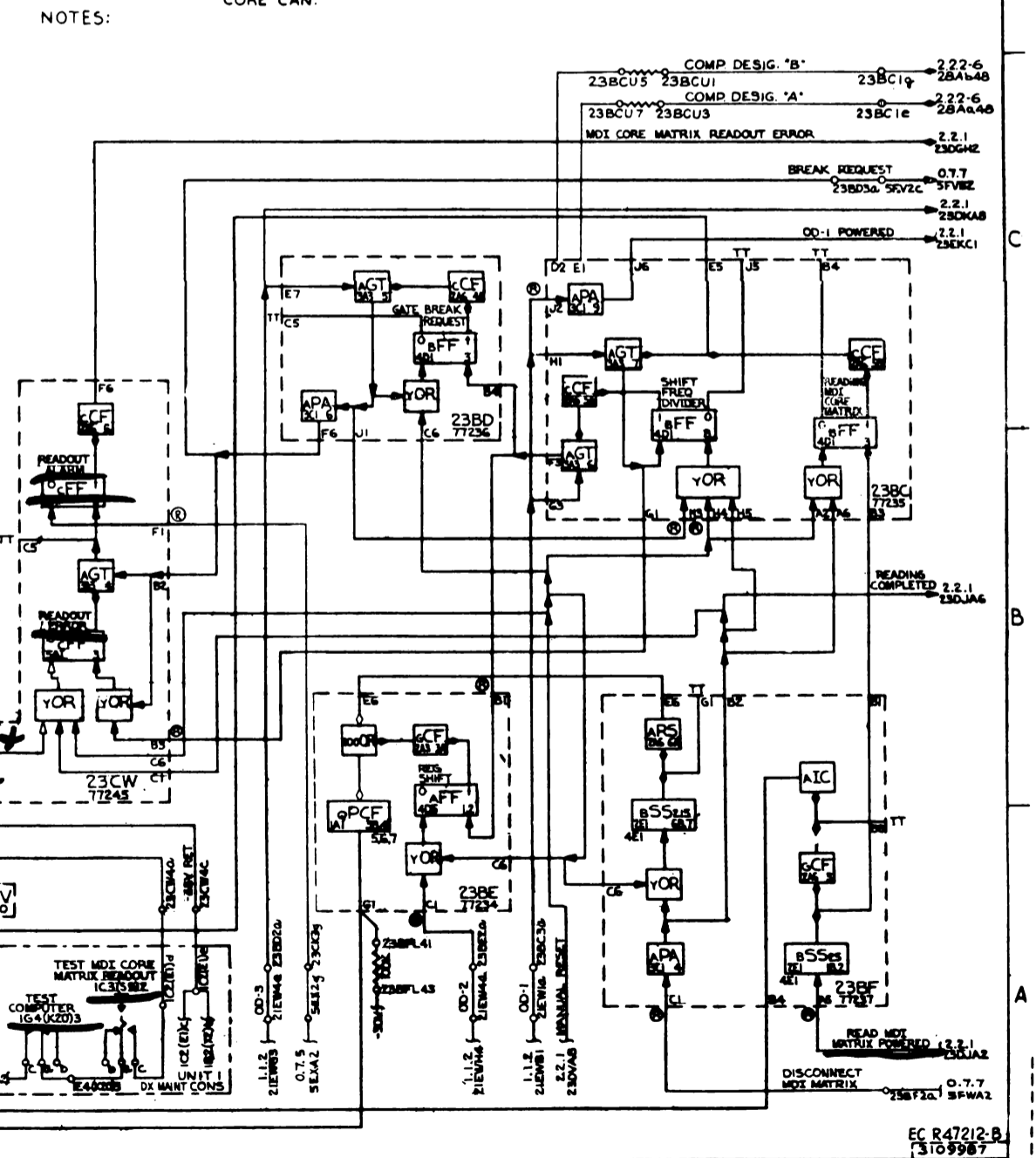

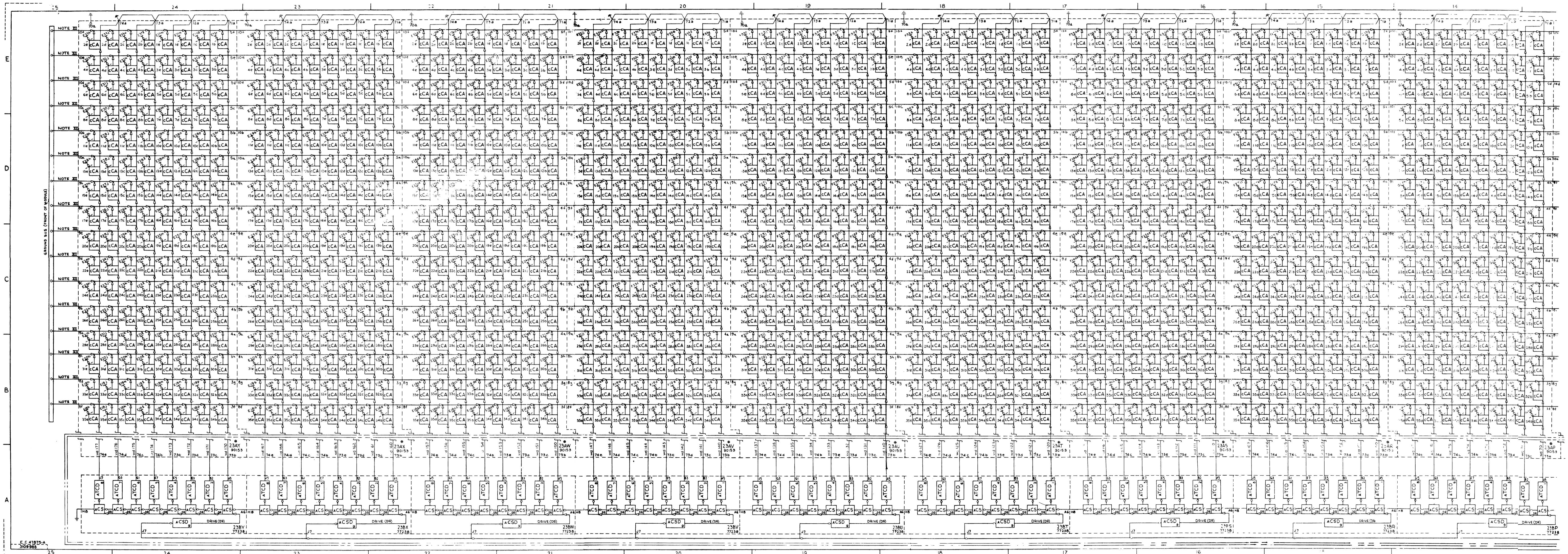



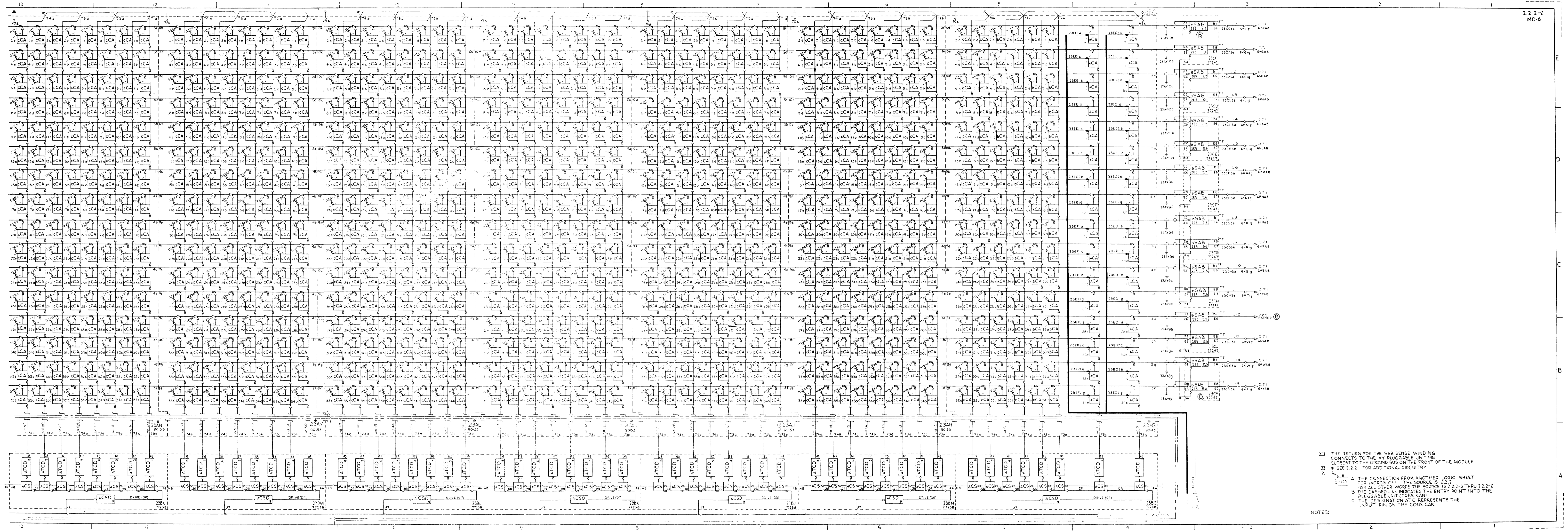

XII THE RETURN FOR THE SAB SENSE WINDING CONNECTS TO THE AV PLUGGABLE UNIT PIN CLOSEST TO THE GROUND BUS ON THE FRONT OF THE MODULE  
 XI  
 X  
 A THE CONNECTION FROM ANOTHER LOGIC SHEET FOR WORDS 0-1. THE SOURCE IS 2.2.2 FOR ALL OTHER WORDS THE SOURCE IS 2.2.2-3 THRU 2.2.2-6  
 B THE DASHED LINE INDICATES THE ENTRY POINT INTO THE PLUGGABLE UNIT (CORE CAN)  
 C THE DESIGNATION ATC REPRESENTS THE INPUT PIN ON THE CORE CAN

NOTES:

Table with columns labeled 22 through 12 and rows labeled A through E. Each cell contains alphanumeric codes such as FOJ-PP1, FOJ-PP2, etc., often followed by a letter and a number (e.g., 1A, 2B, 3C).

Table with columns labeled 22 through 12 and rows labeled A through E. Each cell contains alphanumeric codes such as 65BB, 63BB, 62BB, etc., often followed by a letter and a number (e.g., 1A, 2B, 3C).

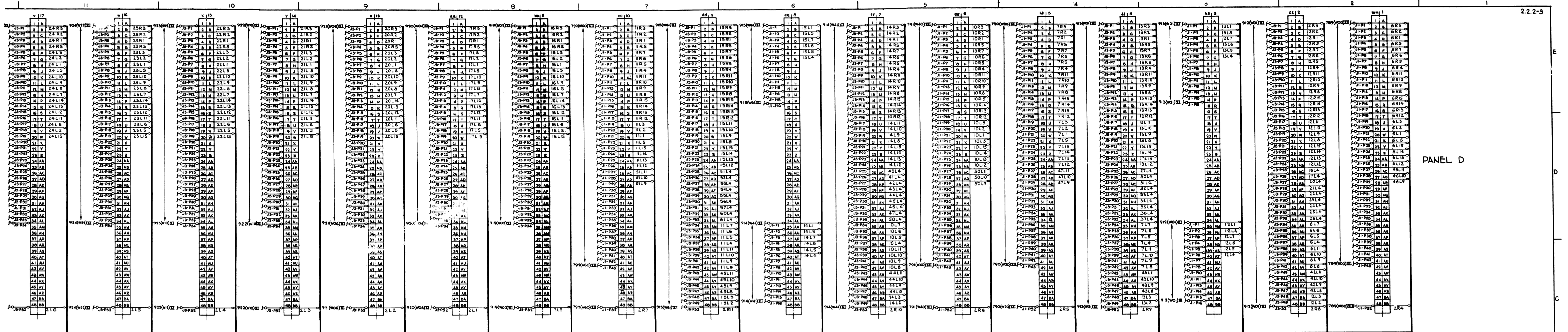

PANEL D

PANEL H

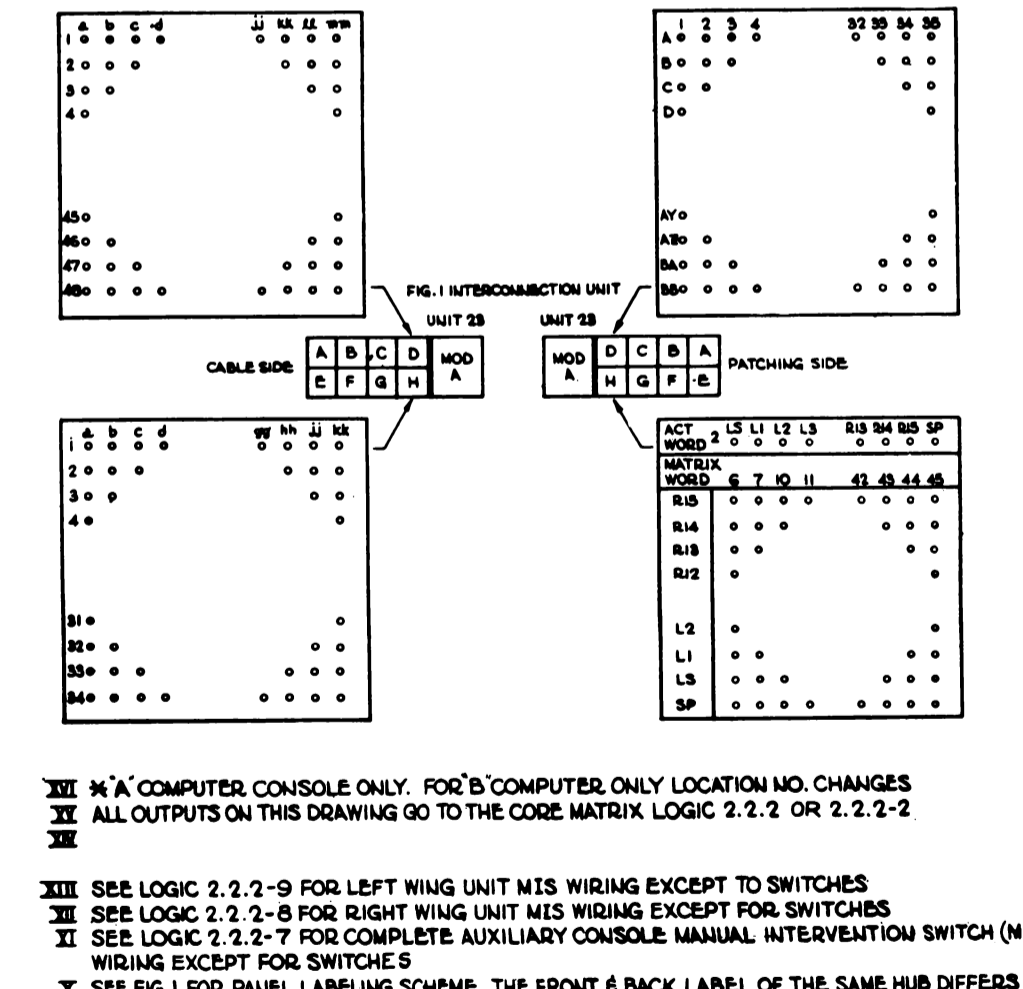

NOTES  
 I SEE FIG. 1 FOR PANEL LABELING SCHEME. THE FRONT & BACK LABEL OF THE SAME HUB DIFFERS  
 II SEE LOGIC 2.2.2-7 FOR COMPLETE AUXILIARY CONSOLE MANUAL INTERVENTION SWITCH (NIS) WIRING EXCEPT FOR SWITCHES  
 III SEE LOGIC 2.2.2-9 FOR LEFT WING UNIT NIS WIRING EXCEPT TO SWITCHES  
 IV SEE LOGIC 2.2.2-8 FOR RIGHT WING UNIT NIS WIRING EXCEPT FOR SWITCHES  
 V SEE LOGIC 2.2.2-7 FOR COMPLETE AUXILIARY CONSOLE MANUAL INTERVENTION SWITCH (NIS) WIRING EXCEPT FOR SWITCHES  
 VI SEE FIG. 1 FOR PANEL LABELING SCHEME. THE FRONT & BACK LABEL OF THE SAME HUB DIFFERS

22				21				20				19				18				17				16				15				14				13				12																																																																																																																																																															
[Grid Data: Columns 1-20, Rows 1-20]																				[Grid Data: Columns 21-40, Rows 1-20]																				[Grid Data: Columns 41-60, Rows 1-20]																				[Grid Data: Columns 61-80, Rows 1-20]																				[Grid Data: Columns 81-100, Rows 1-20]																				[Grid Data: Columns 101-120, Rows 1-20]																				[Grid Data: Columns 121-140, Rows 1-20]																				[Grid Data: Columns 141-160, Rows 1-20]																				[Grid Data: Columns 161-180, Rows 1-20]																				[Grid Data: Columns 181-200, Rows 1-20]																			

22				21				20				19				18				17				16				15				14				13				12																																																																																																																																																															
[Grid Data: Columns 1-20, Rows 21-40]																				[Grid Data: Columns 21-40, Rows 21-40]																				[Grid Data: Columns 41-60, Rows 21-40]																				[Grid Data: Columns 61-80, Rows 21-40]																				[Grid Data: Columns 81-100, Rows 21-40]																				[Grid Data: Columns 101-120, Rows 21-40]																				[Grid Data: Columns 121-140, Rows 21-40]																				[Grid Data: Columns 141-160, Rows 21-40]																				[Grid Data: Columns 161-180, Rows 21-40]																				[Grid Data: Columns 181-200, Rows 21-40]																			

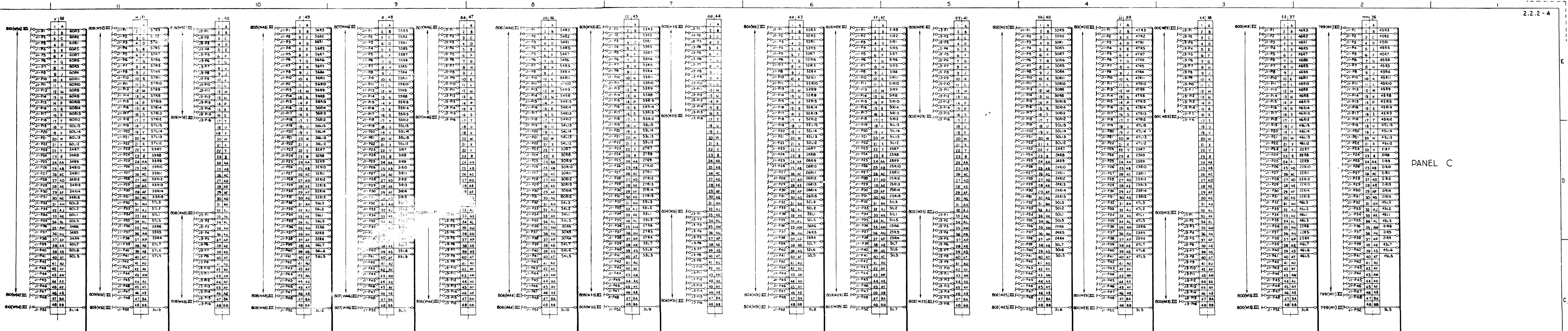

PANEL C

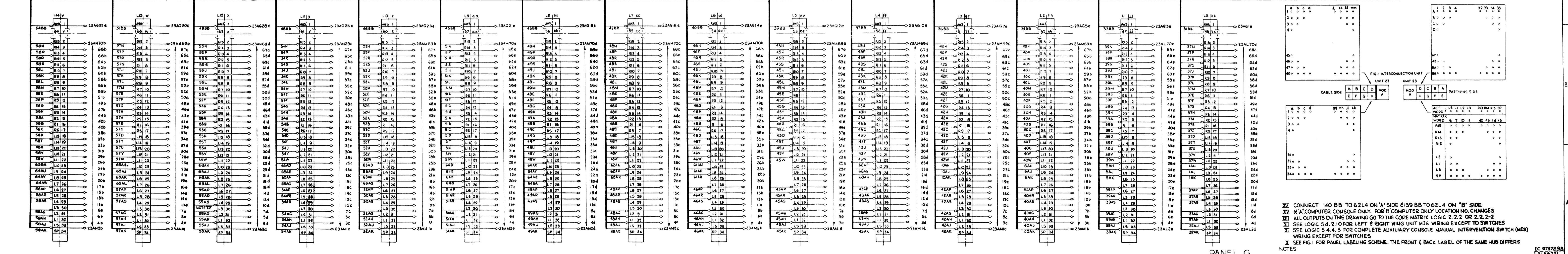

I CONNECT 140 BB TO 62L4 ON 'A' SIDE & 139 BB TO 62L4 ON 'B' SIDE  
 II \*A\* COMPUTER CONSOLE ONLY. FOR 'B' COMPUTER ONLY LOCATION NO. CHANGES  
 III ALL OUTPUTS ON THIS DRAWING GO TO THE CORE MATRIX LOGIC 2.2.2 OR 2.2.2-2  
 IV SEE LOGIC 5.4.2.10 FOR LEFT & RIGHT WIUG UNIT MTS WIRING EXCEPT TO SWITCHES  
 V SEE LOGIC 5.4.3 FOR COMPLETE AUXILIARY CONSOLE MANUAL INTERVENTION SWITCH (MIS) WIRING EXCEPT FOR SWITCHES  
 VI SEE FIG. 1 FOR PANEL LABELING SCHEME. THE FRONT & BACK LABEL OF THE SAME HUB DIFFERS

PANEL G

Table with columns labeled 22 through 12 and rows labeled A through E. Each cell contains alphanumeric codes such as 'J-1A', 'J-1B', 'J-1C', etc., organized in a grid structure.

Table with columns labeled 22 through 12 and rows labeled A through E. Each cell contains alphanumeric codes such as 'R1A', 'R1B', 'R1C', etc., organized in a grid structure.

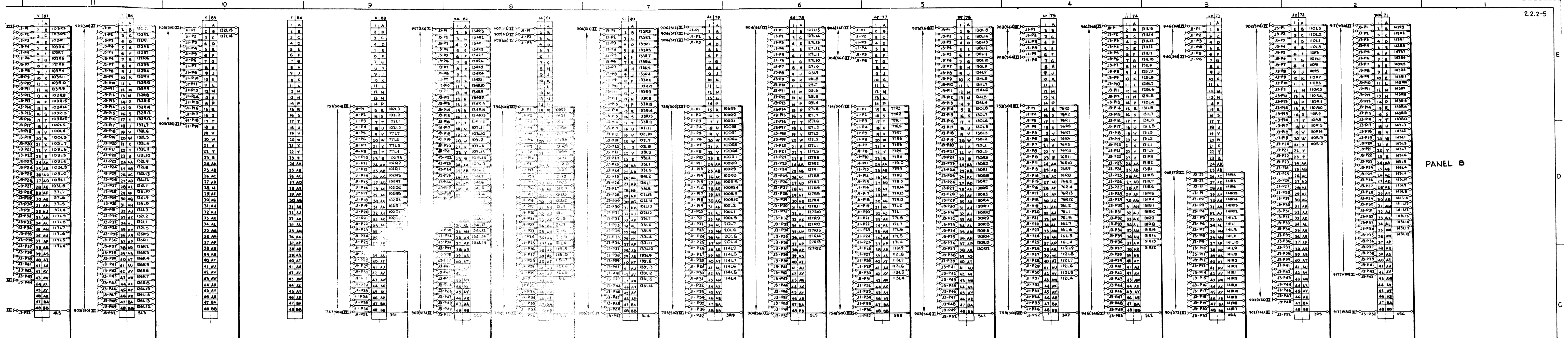

PANEL B

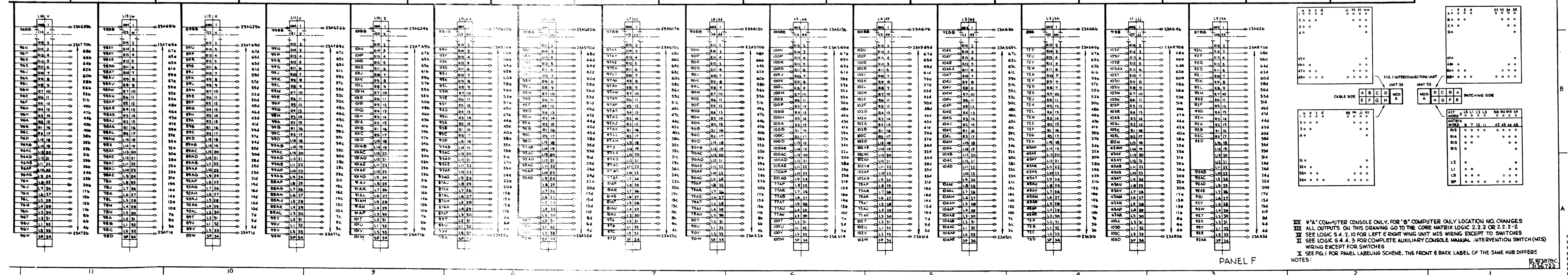

PANEL F

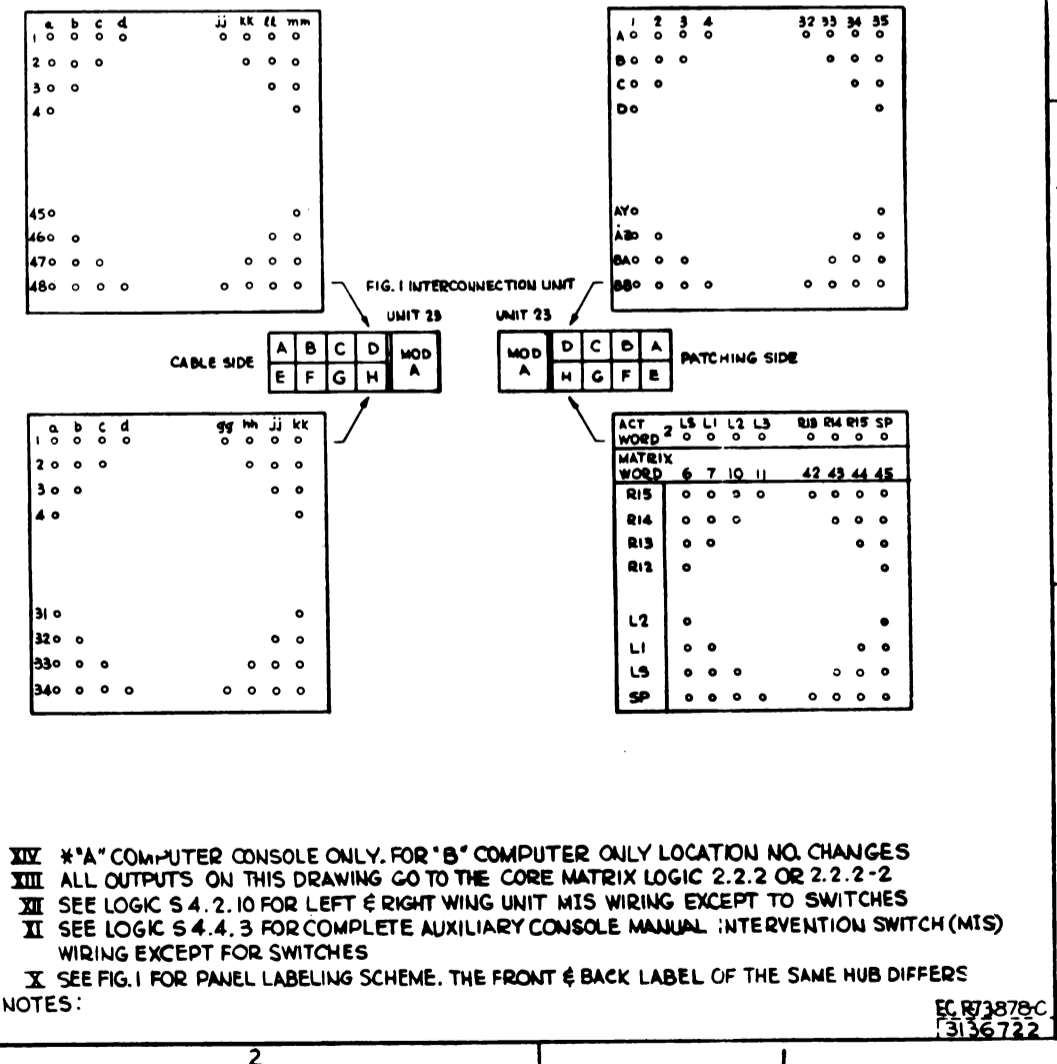

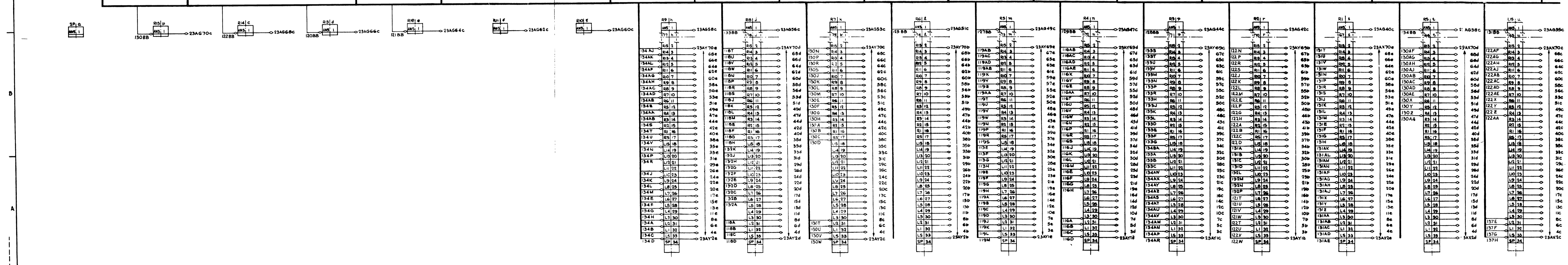
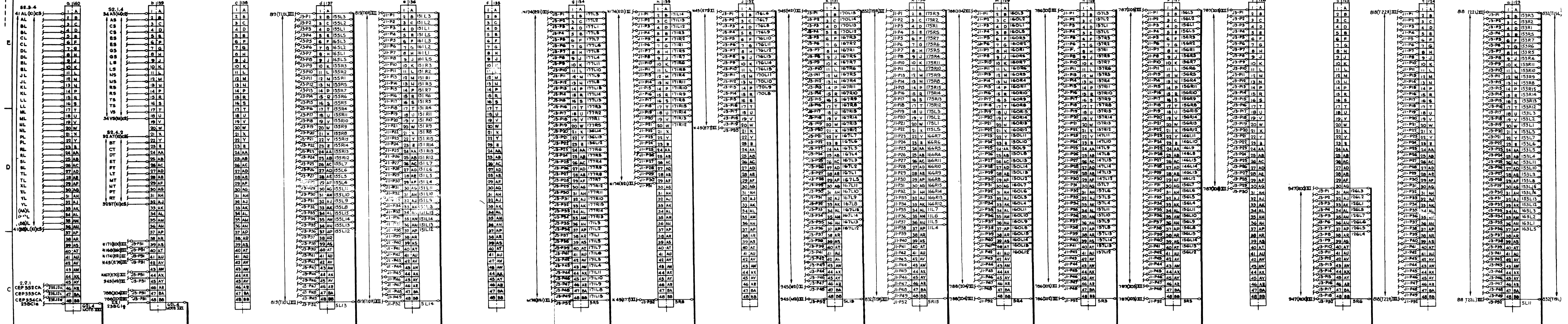



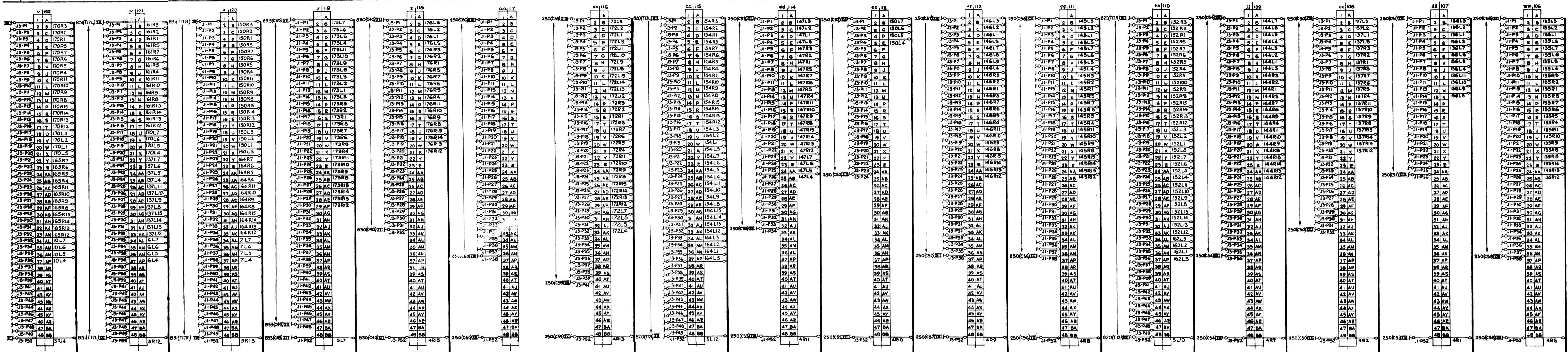

PANEL A

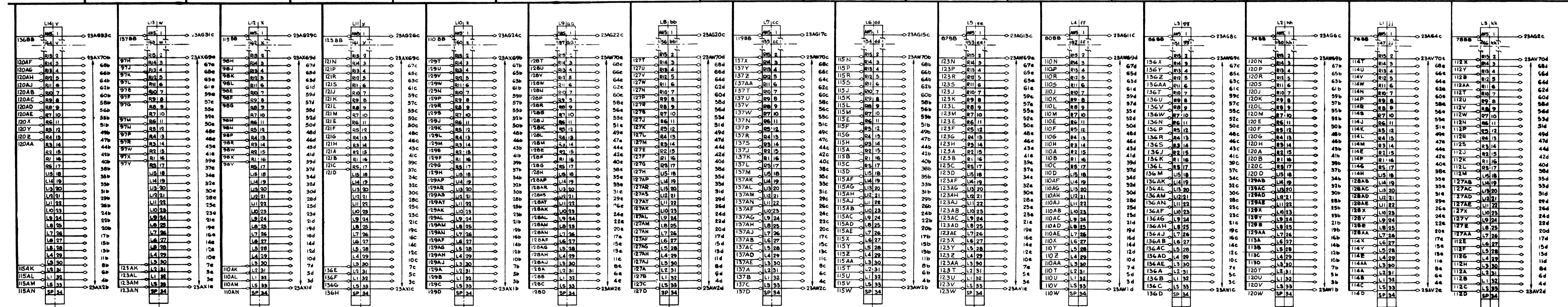

PANEL E

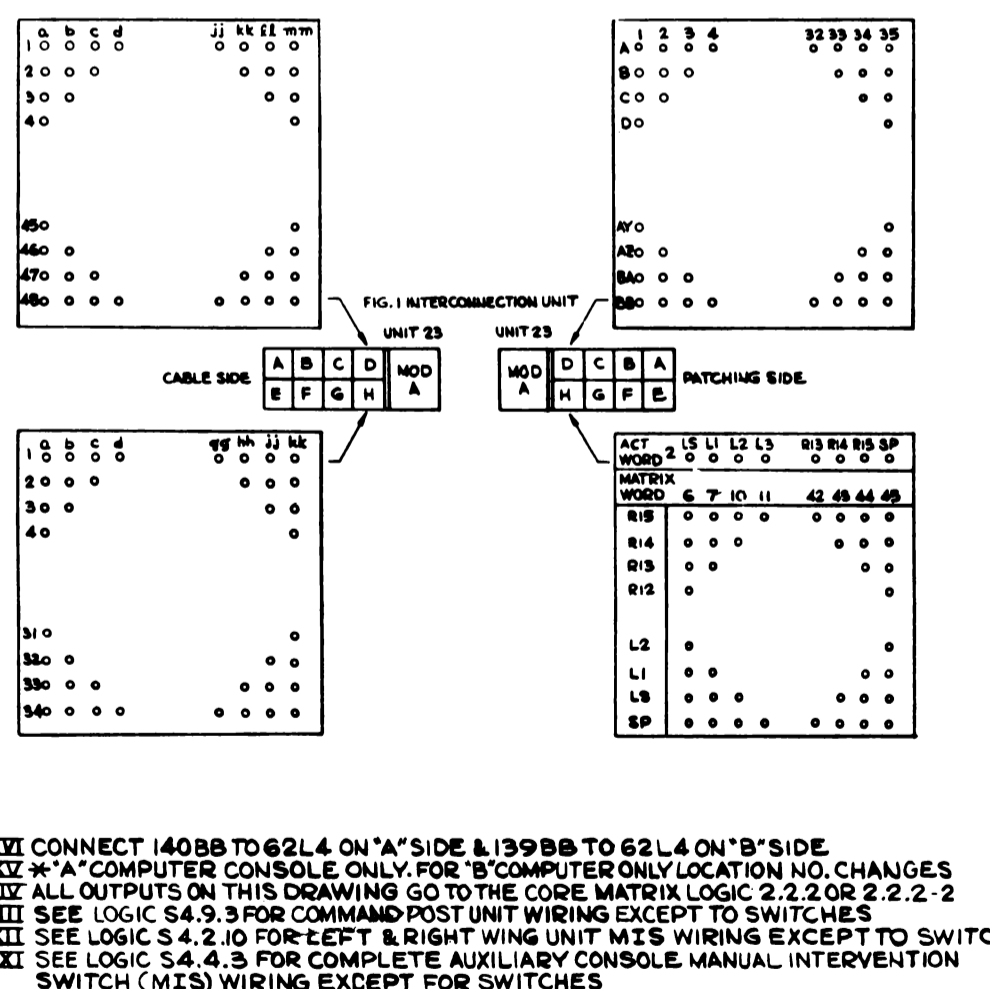

XXI CONNECT I40BB TO 62L4 ON 'A' SIDE & I39BB TO 62L4 ON 'B' SIDE  
 XXII \*A\* COMPUTER CONSOLE ONLY FOR 'B' COMPUTER ONLY LOCATION NO. CHANGES  
 XXIII ALL OUTPUTS ON THIS DRAWING GO TO THE CORE MATRIX LOGIC 2.2-2 OR 2.2-2-2  
 XXIV SEE LOGIC 5.4.2.9 FOR COMMAND POST UNIT WIRING EXCEPT TO SWITCHES  
 XXV SEE LOGIC 5.4.2.10 FOR LEFT & RIGHT WIRING EXCEPT TO SWITCHES  
 XXVI SEE LOGIC 5.4.3 FOR COMPLETE AUXILIARY CONSOLE MANUAL INTERVENTION SWITCH (MIS) WIRING EXCEPT FOR SWITCHES  
 XXVII SEE LOGIC LABELING SCHEME. THE FRONT & BACK LABEL OF THE SAME HUB DIFFERS

NOTES:  
 1. SEE FIG. 1 FOR INTERCONNECTION UNIT  
 2. CABLE SIDE  
 3. PATCHING SIDE  
 4. UNIT 23  
 5. UNIT 24  
 6. UNIT 25

MDI DIRECT INTERCONNECTION PANELS A & E



UNIT # 24 MODULE J	(BB)	(AA)	77277 Y	77950 X	77268 W	77268 V	77292 U	77295 T	77295 S	77295 R	77295 P	77295 N	77961 M	77295 L	77961 K	77255 J	77273 H	77273 G	77251 F	77260 E	77260 D	77260 C	B	A
ROW																								
Z																								
5a+250 PCF NI	GBI																							
5a+150 CF S5	GBS																							
5a+150 CF H5	GBH																							
5a+90 PA SIO	SEI																							
2a-150 CFB N4	EA4																							
3f+150 CF R5	GR4																							
2a-150 BFF S4	GD4																							
2f-300 CFF N8	GA4																							
6a+250 BI R2	GA2																							
2i-150 CF																								
2w,3w,4w GND	GND																							
-300																								
-150																								
-30																								
-15																								
+10																								
+90																								
+150																								
+250																								
+15																								
3i																								
4a																								
1a																								
5.3.4.3																								

UNIT # 24 MODULE K	(BB)	(AA)	77253 Y	77253 X	77293 W	77294 V	77257 U	77295 T	77295 S	77295 R	77295 P	77295 N	77961 M	77295 L	77273 K	77256 J	77273 H	77273 G	77251 F	77261 E	77260 D	77261 C	B	A
ROW																								
Z																								
5h+90 GT N10	GA4																							
2a-150 CFB N4	EA4																							
5a+150 CF S5	GBS																							
5a+150 CF H5	GBH																							
5a+90 PA SIO	SEI																							
2a-150 CFB N4	EA4																							
3f+150 CF R5	GR4																							
2a-150 BFF S4	GD4																							
2f-300 CFF N8	GA4																							
6a+250 BI R2	GA2																							
5a+250 PCF NI	GBI																							
2i-150 CF																								
2w,3w,4w GND	GND																							
-300																								
-150																								
-30																								
-15																								
+10																								
+90																								
+150																								
+250																								
+15																								
3i																								
4a																								
1a																								
5.3.4.3																								

NOTE: -48V AND -48V RETURN CONNECTIONS ARE AS FOLLOWS: 24J16-24HC2, 24J16-24HC4

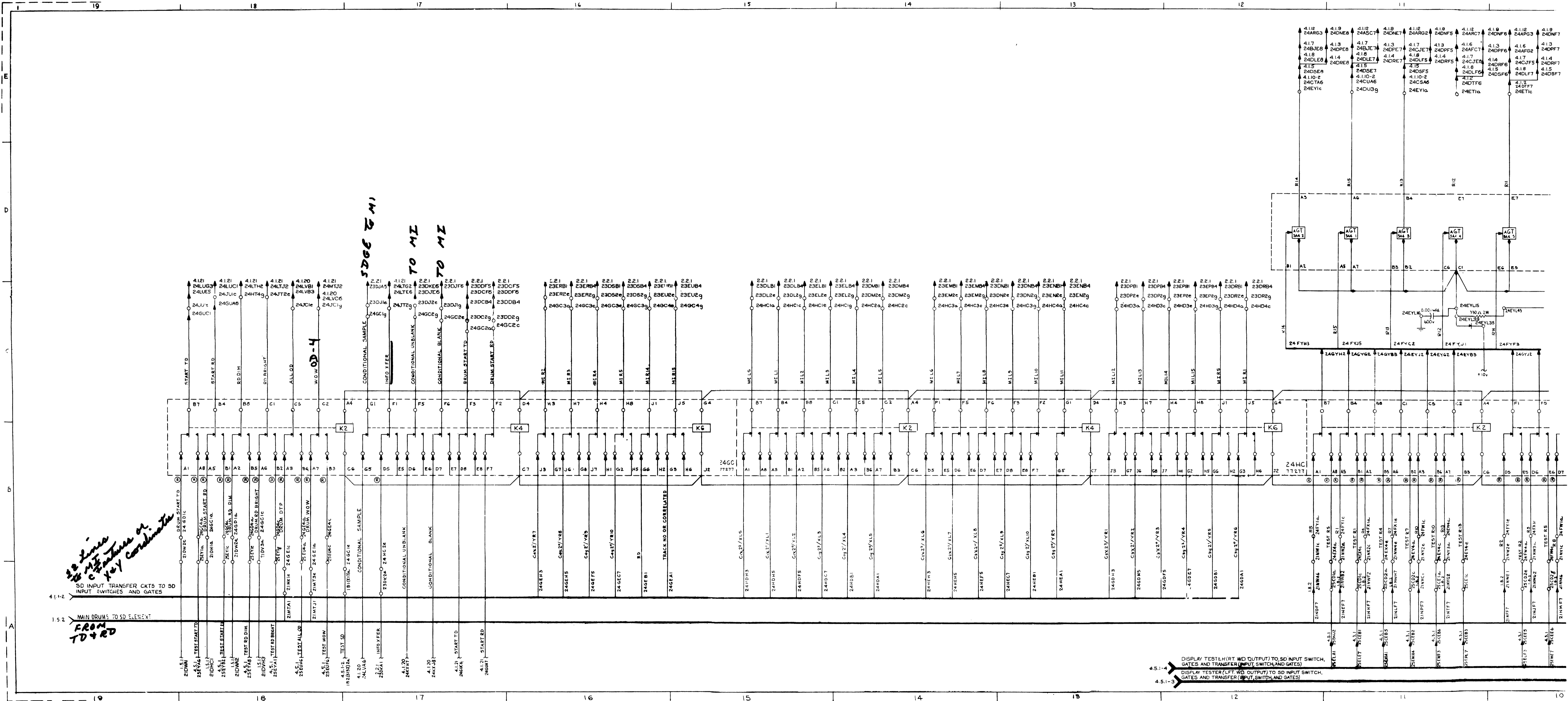

*32 Lines to MI of C Key Coordinate*

SD INPUT TRANSFER CKTS TO SD INPUT SWITCHES AND GATES

MAIN DRUMS TO SD ELEMENT FROM TD & RD

4.5.1-4 DISPLAY TEST L (RT WD OUTPUT) TO SD INPUT SWITCH, GATES AND TRANSFER (INPUT SWITCH AND GATES)

4.5.1-3 DISPLAY TEST R (LFT WD OUTPUT) TO SD INPUT SWITCH, GATES AND TRANSFER (INPUT SWITCH AND GATES)

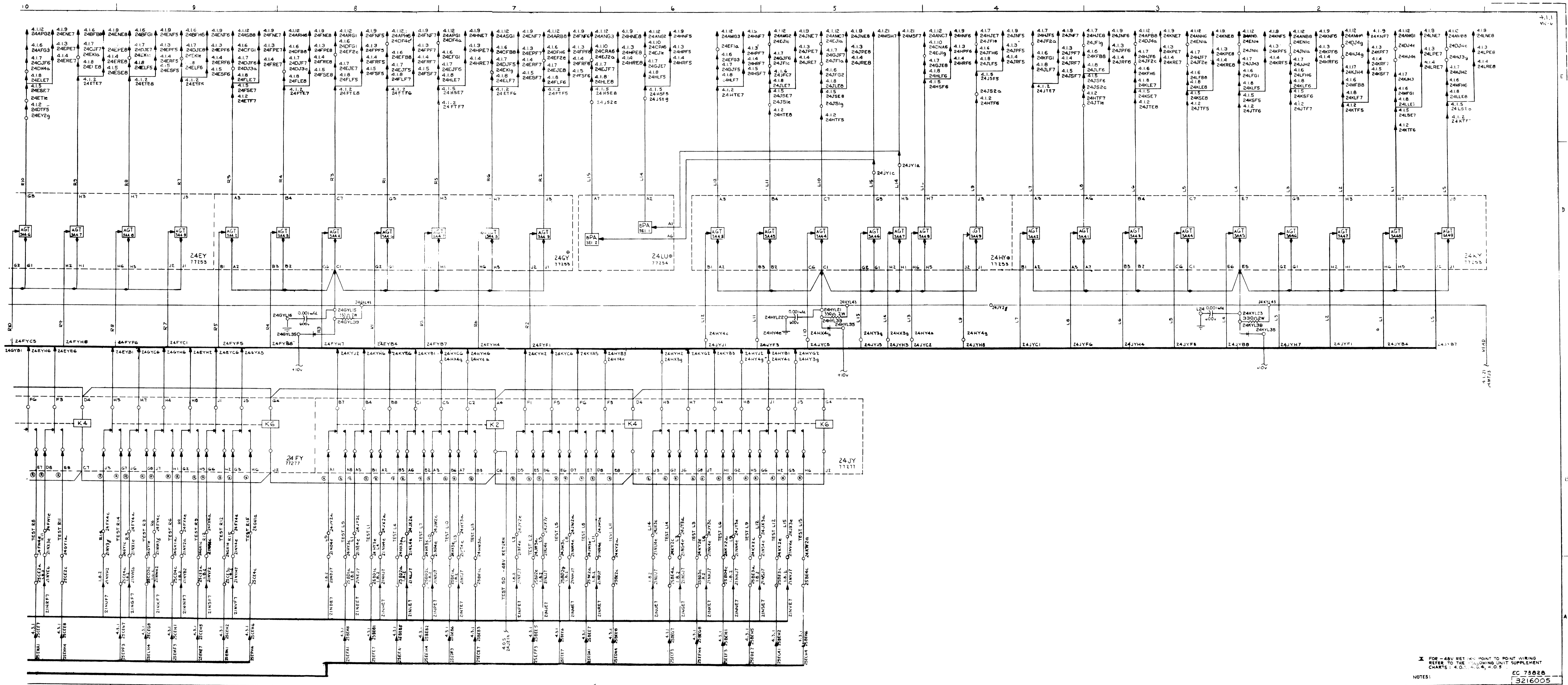

NOTES:  
X FOR -48V RETURN POINT TO POINT WIRING REFER TO THE FOLLOWING UNIT SUPPLEMENT CHARTS: 4.0.1, 4.0.2, 4.0.3, 4.0.4  
EC 73028  
3216005

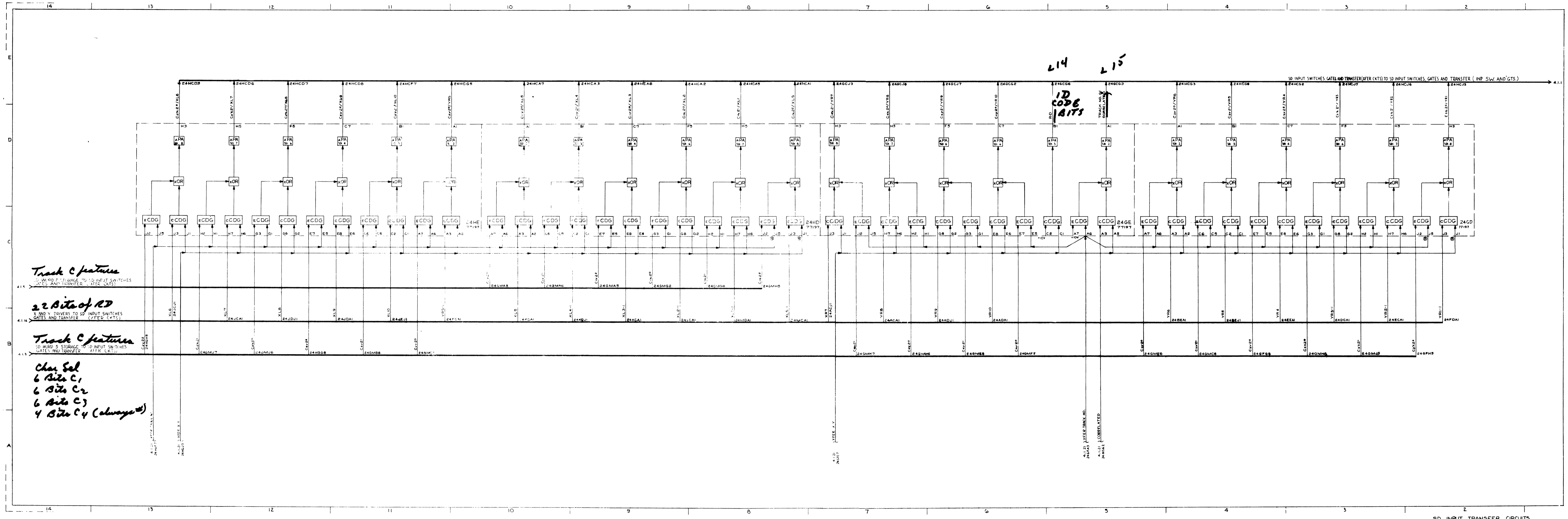

*Track C features*  
SD WORD 7 STORAGE TO SD INPUT SWITCHES GATES AND TRANSFER (XFER CKTS)

*22 Bits of RD*  
X AND Y DRIVERS TO SD INPUT SWITCHES GATES AND TRANSFER (XFER CKTS)

*Track C features*  
SD WORD 5 STORAGE TO SD INPUT SWITCHES GATES AND TRANSFER (XFER CKTS)

*Char Sel*  
6 Bits C<sub>1</sub>  
6 Bits C<sub>2</sub>  
6 Bits C<sub>3</sub>  
4 Bits C<sub>4</sub> (always 0)

L14 L15  
ID CODE BITS

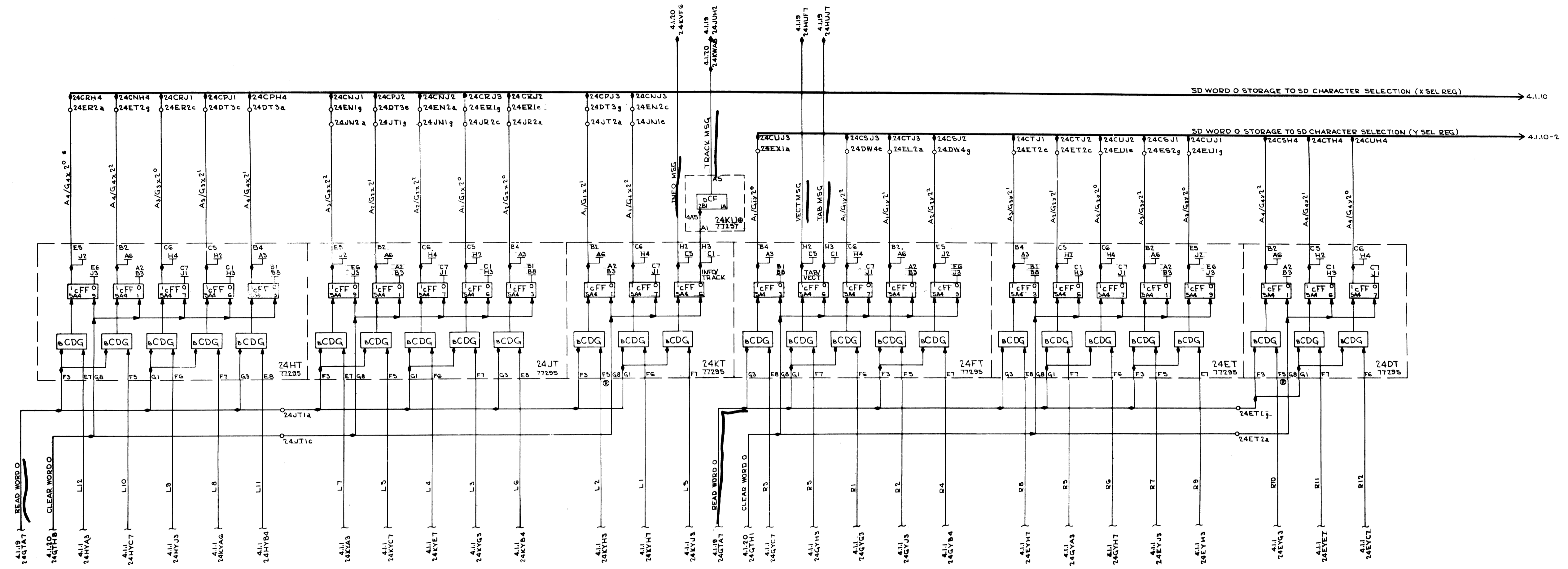

EC 48802  
3216006

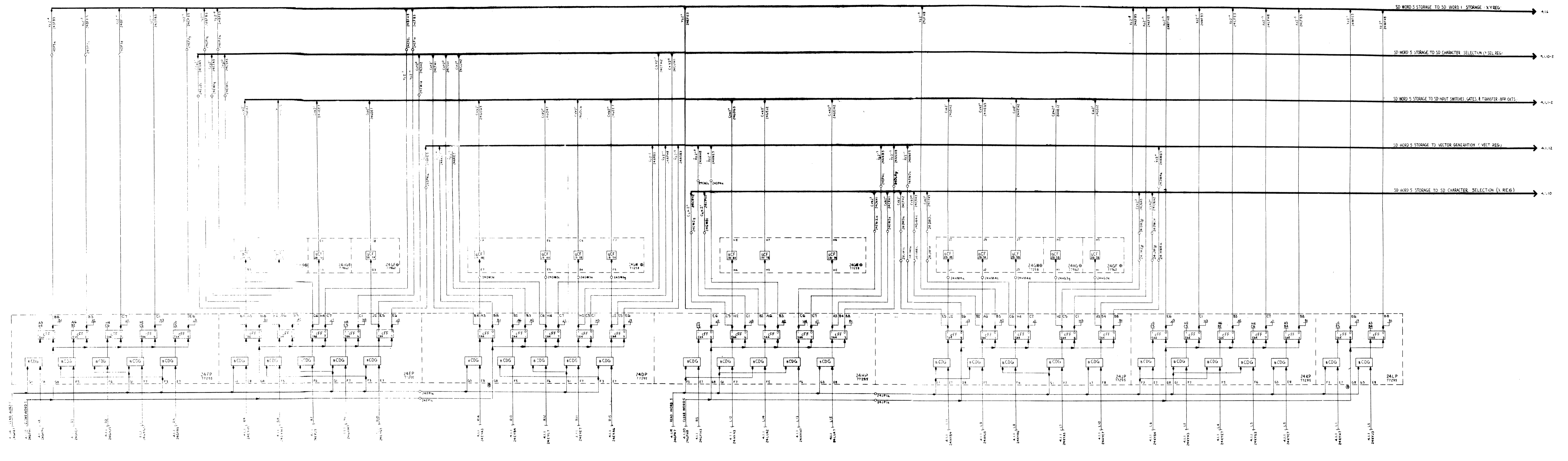



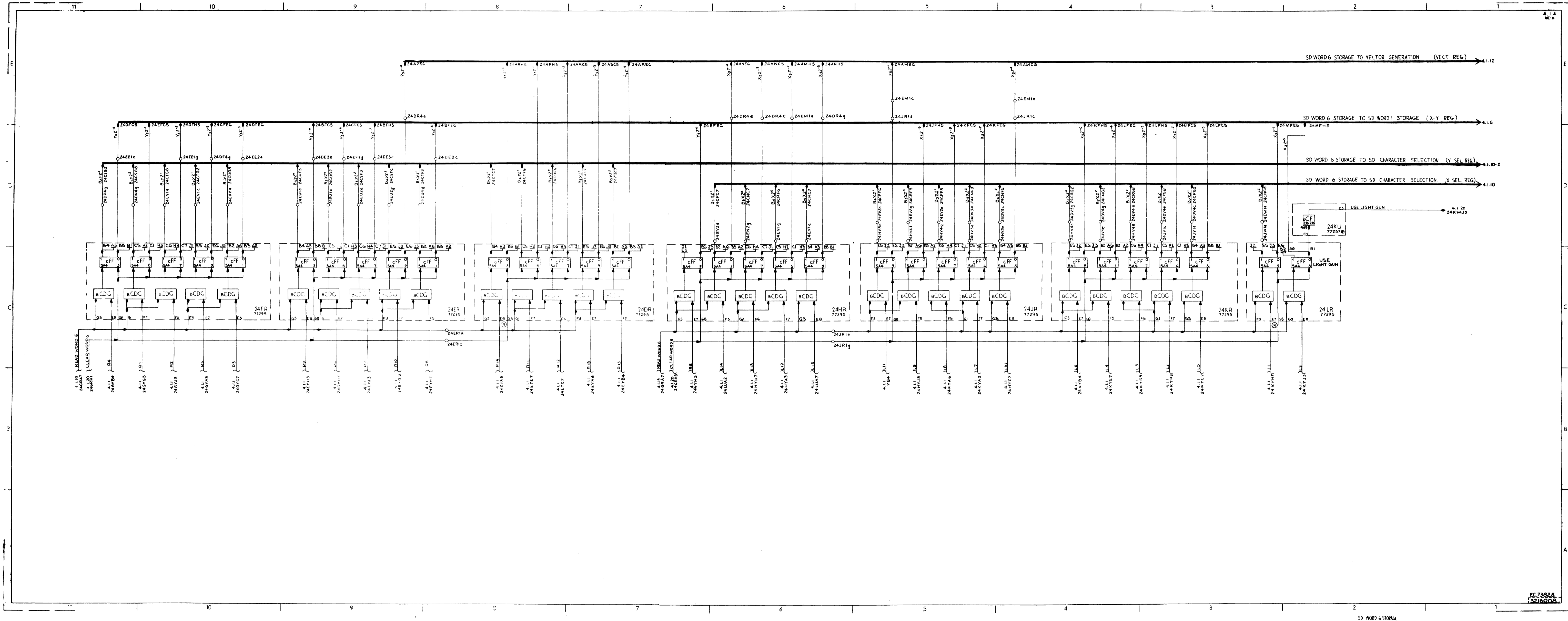

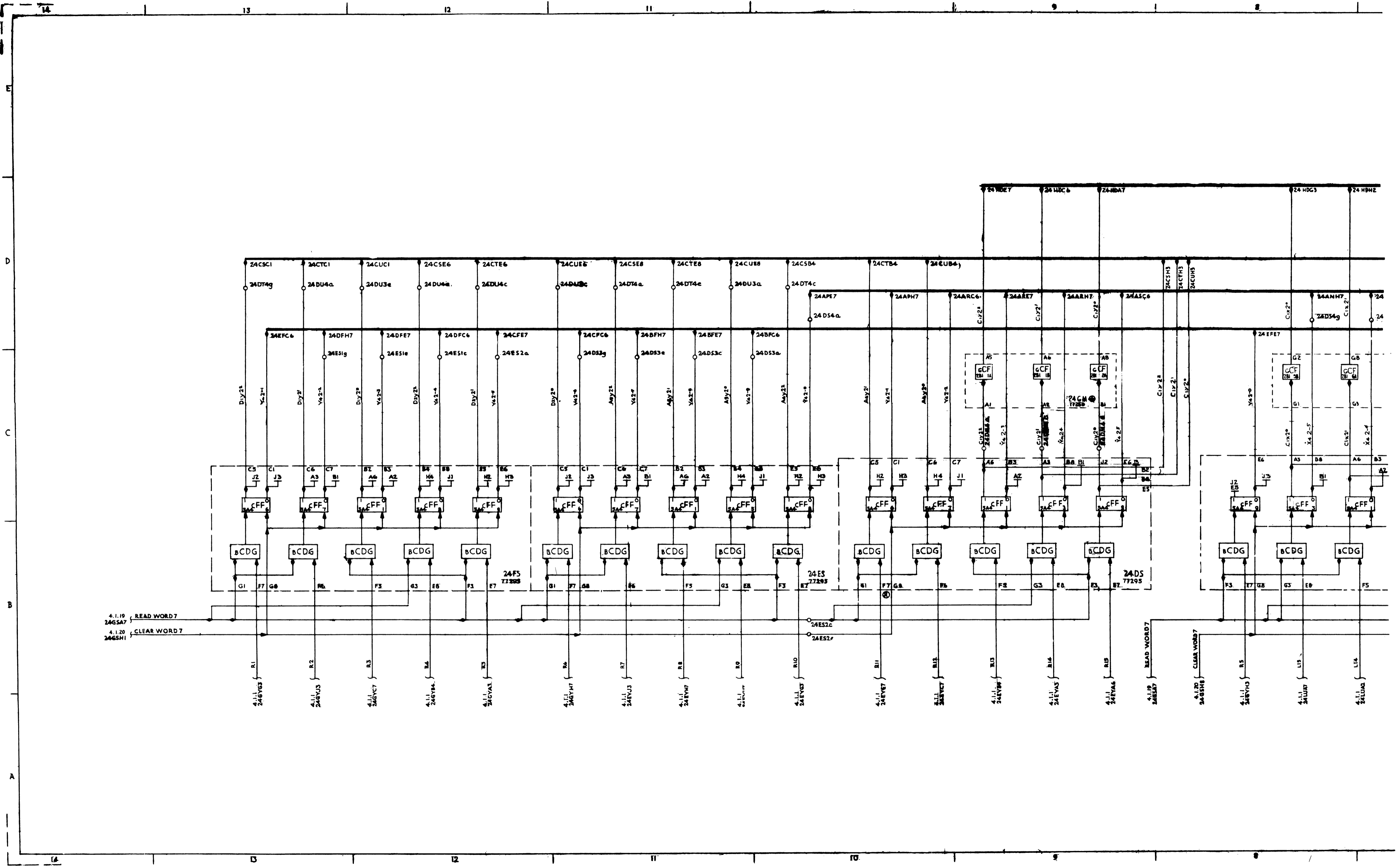

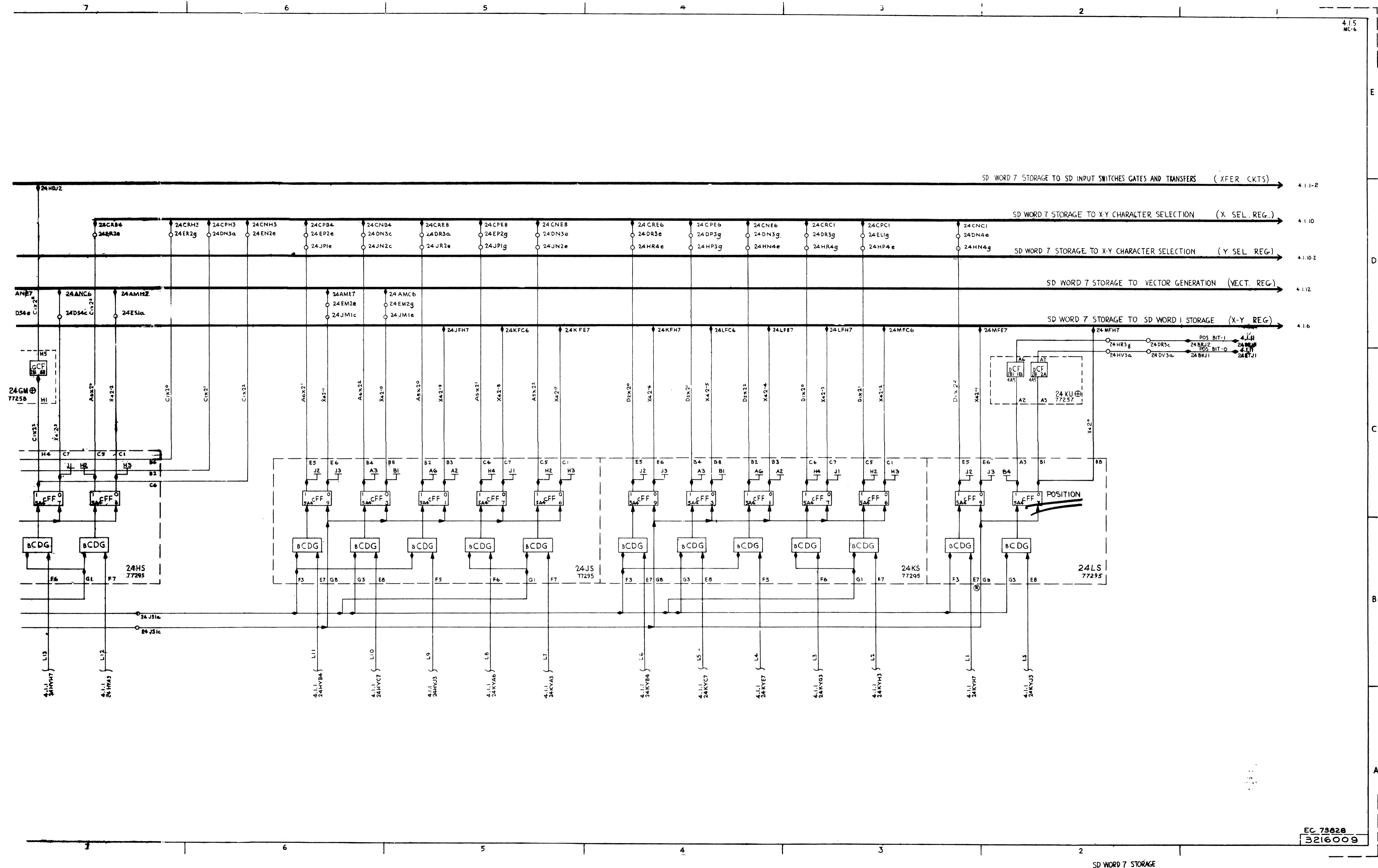

4.15  
MC-6

SD WORD 7 STORAGE TO SD INPUT SWITCHES GATES AND TRANSFERS (XFER CKTS) 4.1.1-2

SD WORD 7 STORAGE TO X-Y CHARACTER SELECTION (X SEL. REG.) 4.1.10

SD WORD 7 STORAGE TO X-Y CHARACTER SELECTION (Y SEL. REG.) 4.1.10.2

SD WORD 7 STORAGE TO VECTOR GENERATION (VECT. REG.) 4.1.12

SD WORD 7 STORAGE TO SD WORD 1 STORAGE (X-Y REG.) 4.1.6

EC 73828  
3216009

SD WORD 7 STORAGE

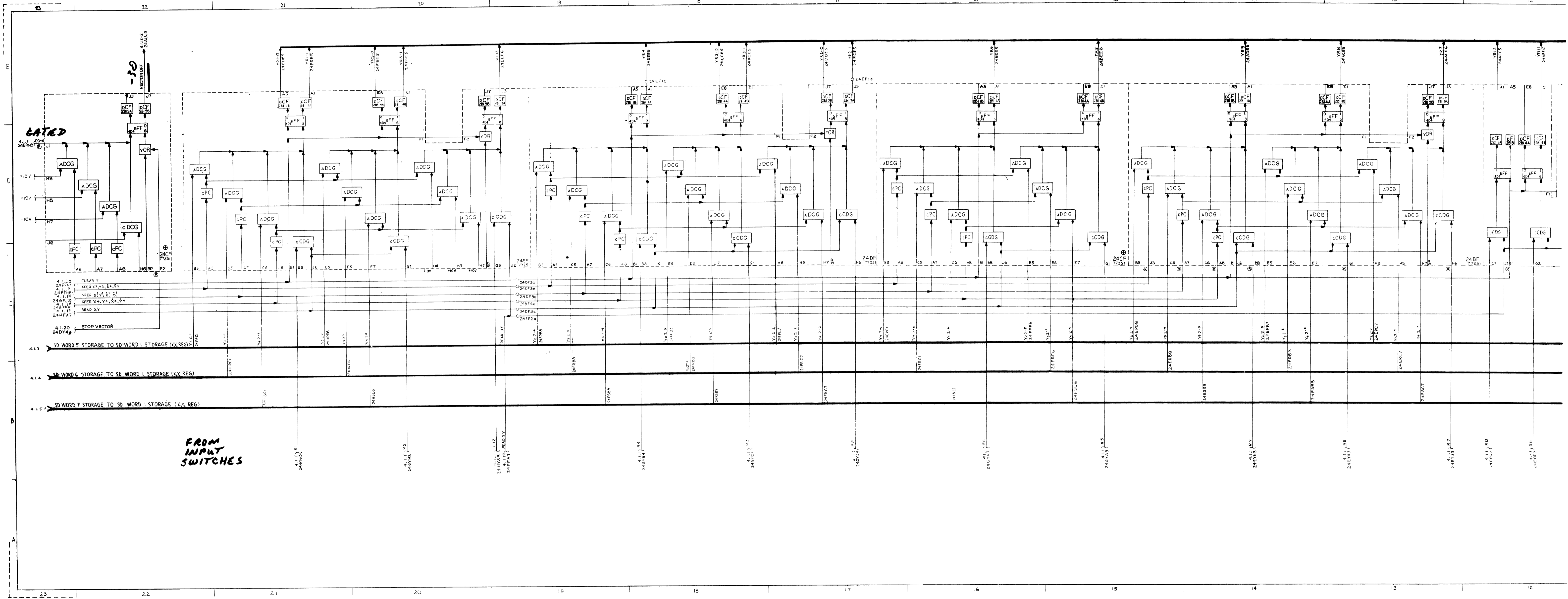

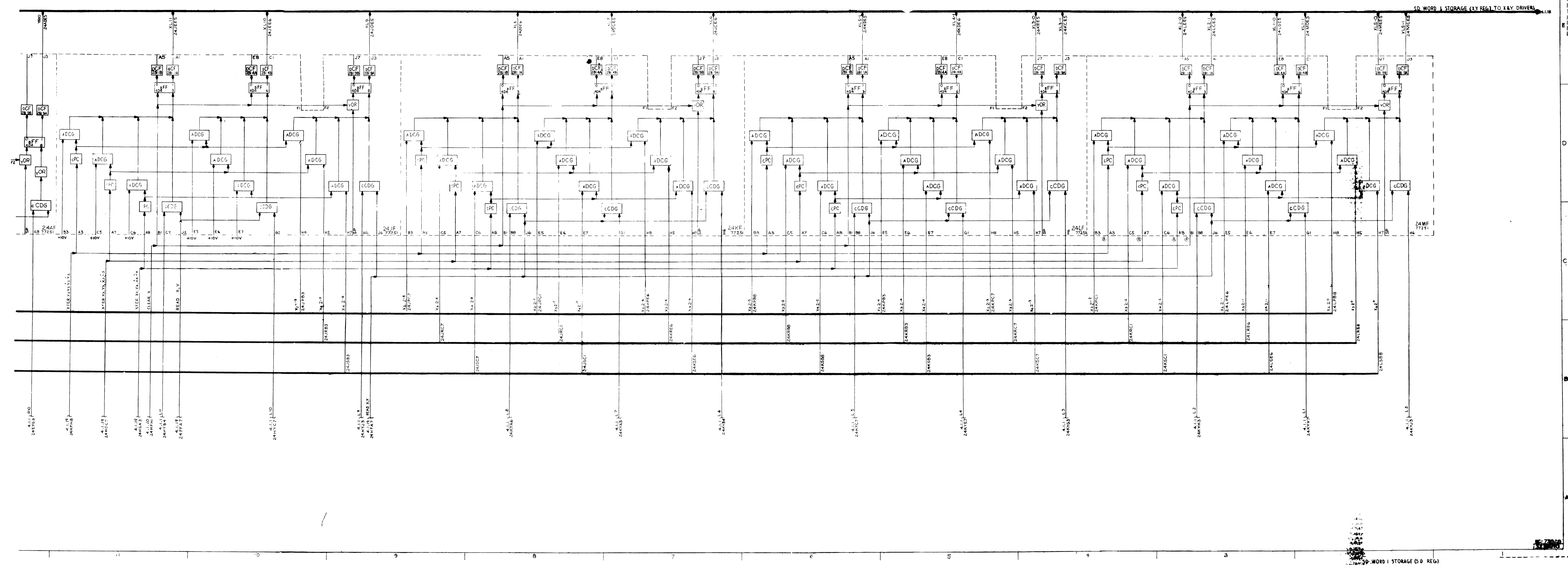

SD WORD | STORAGE (SD REG)

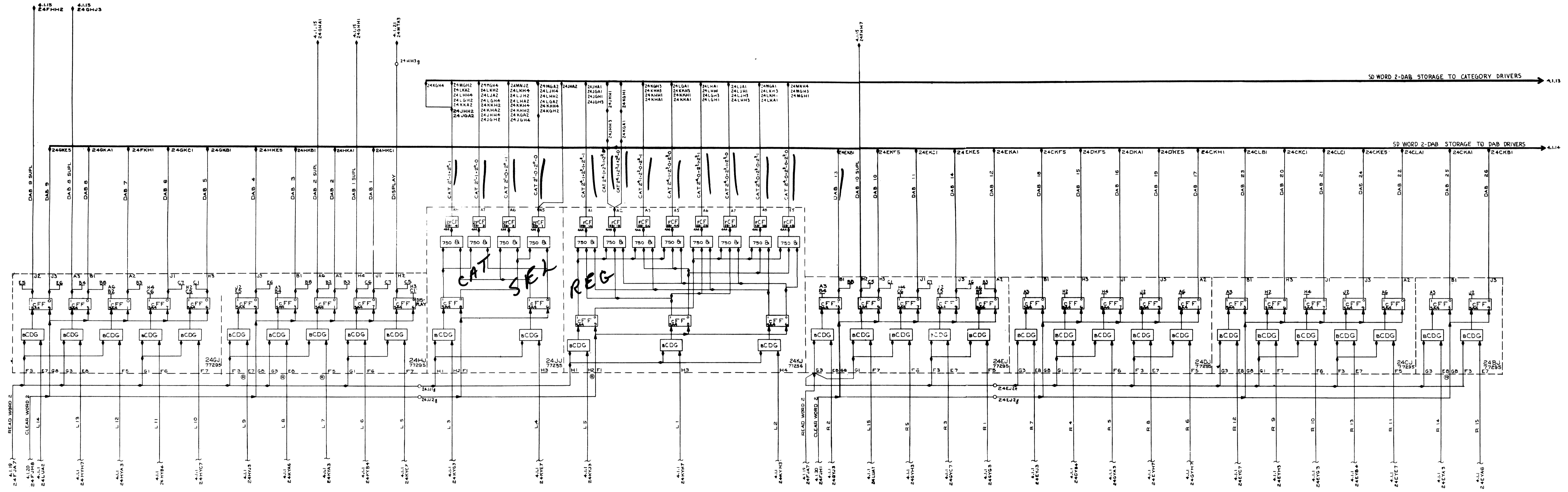

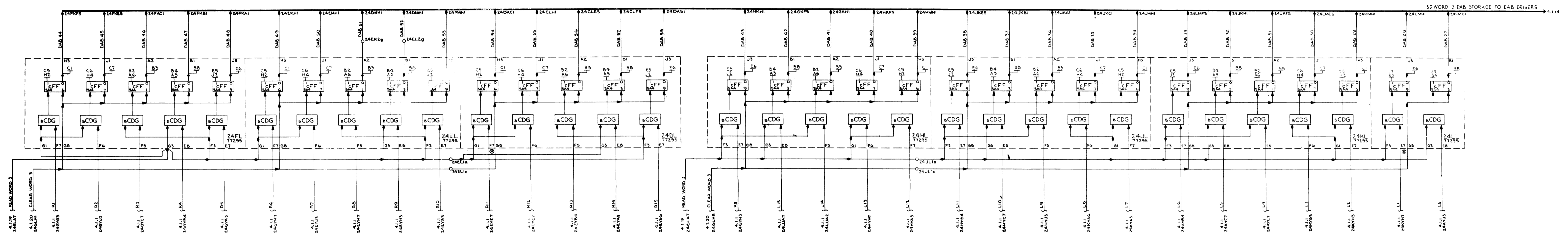

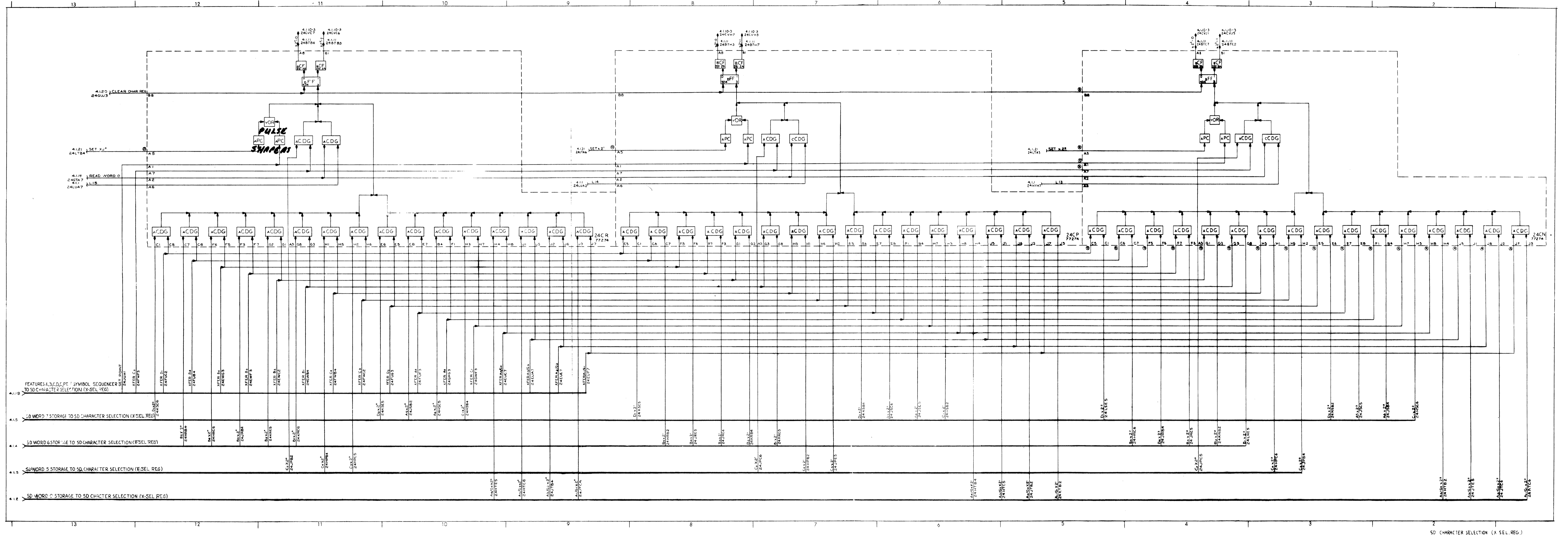



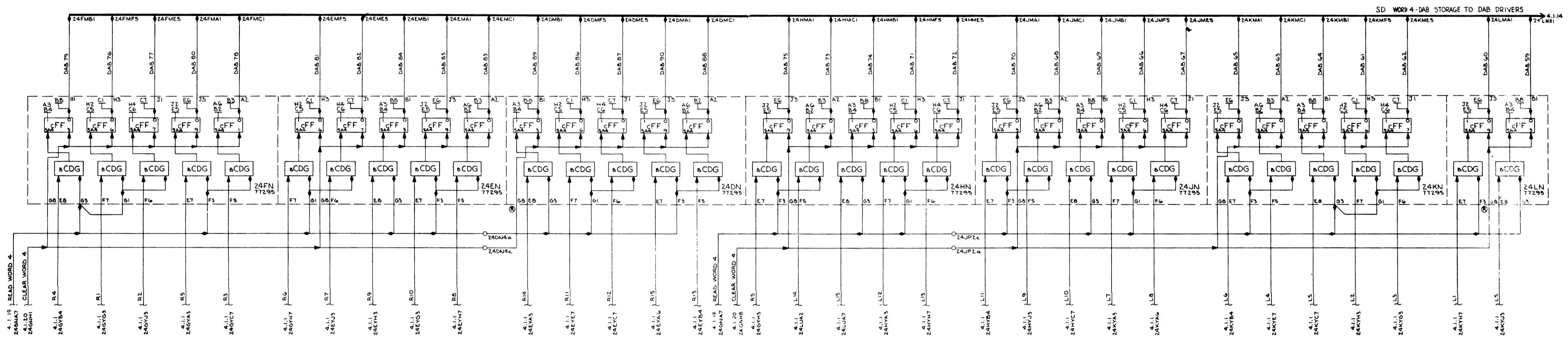

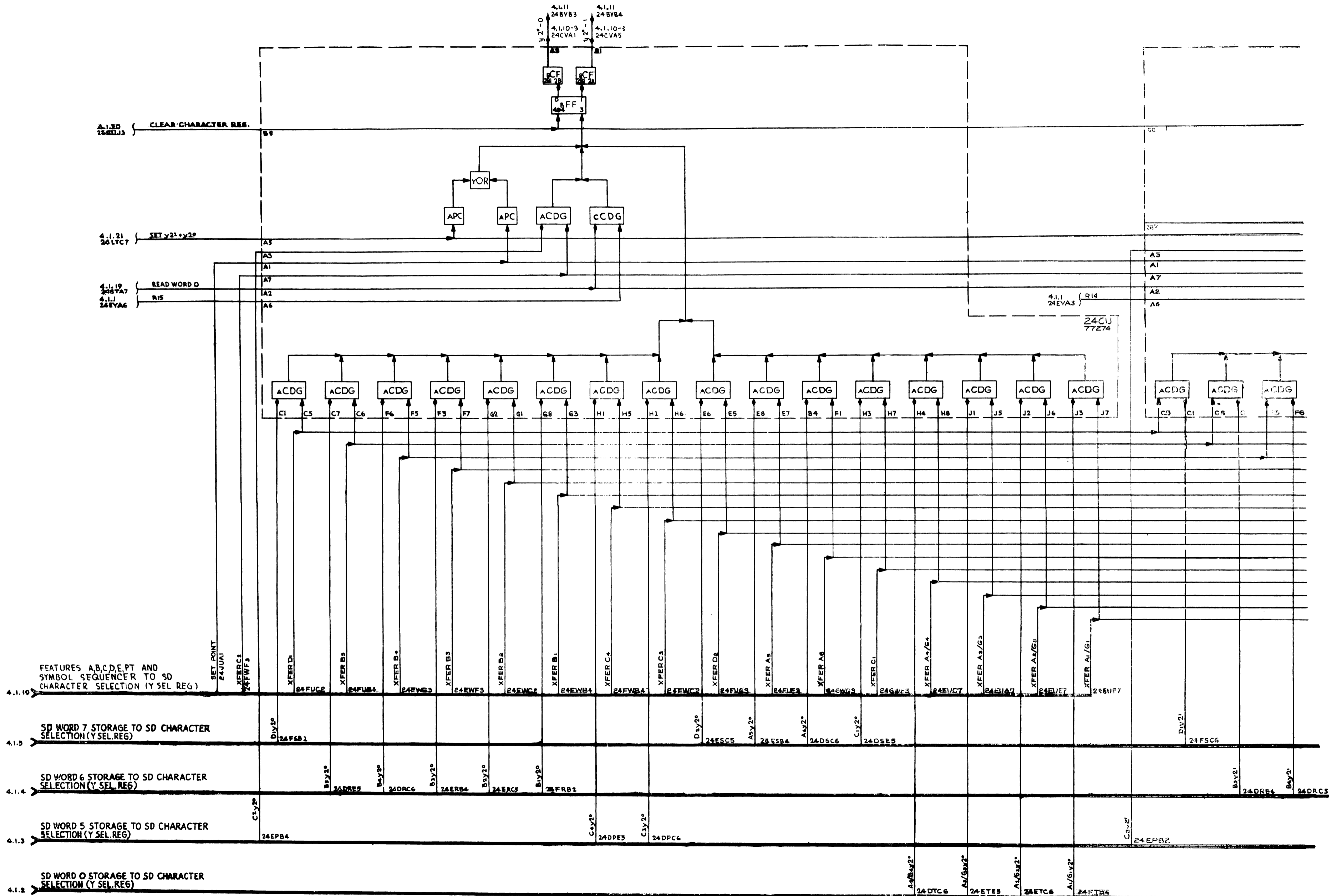

4.1.10-2

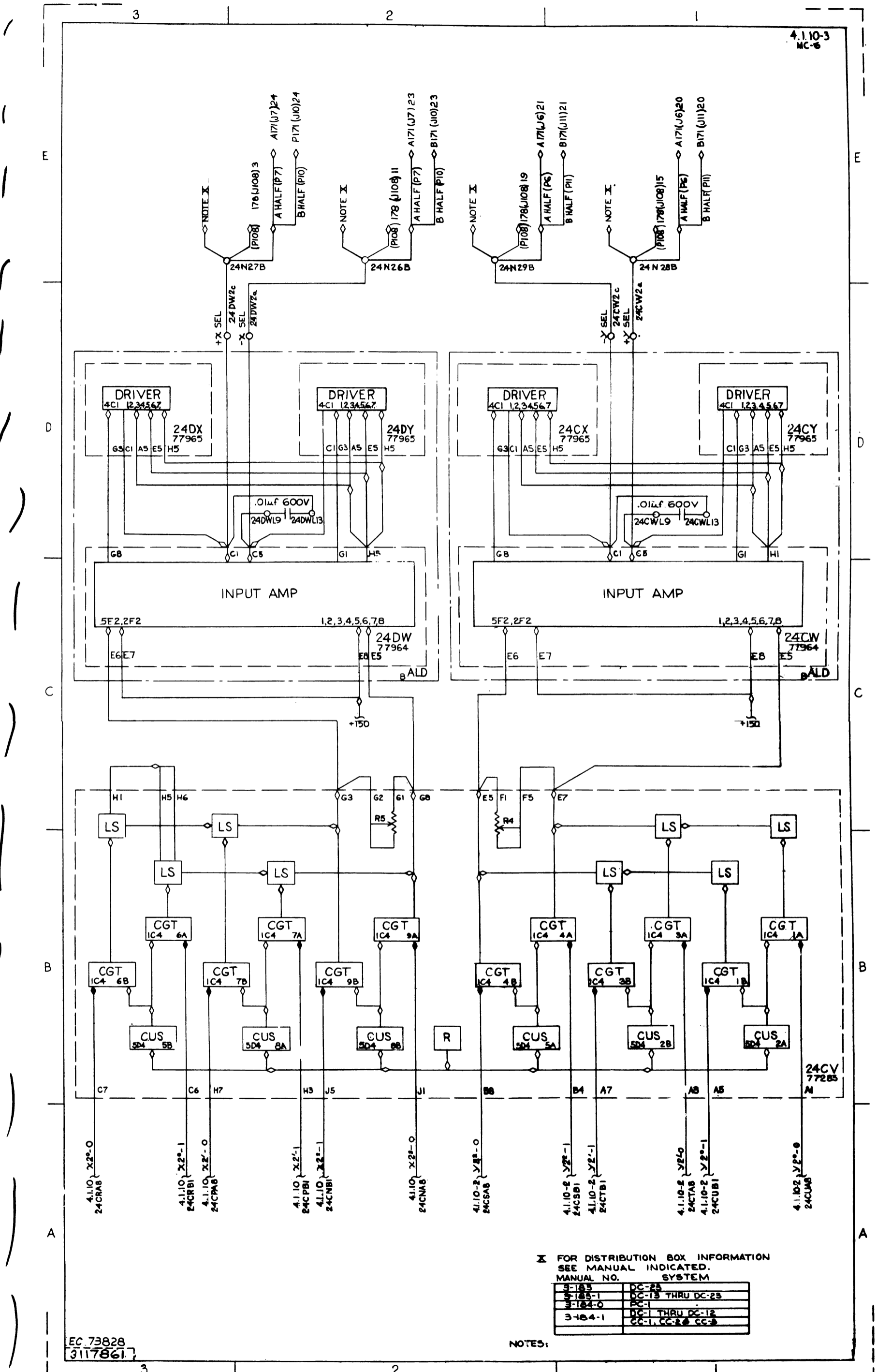
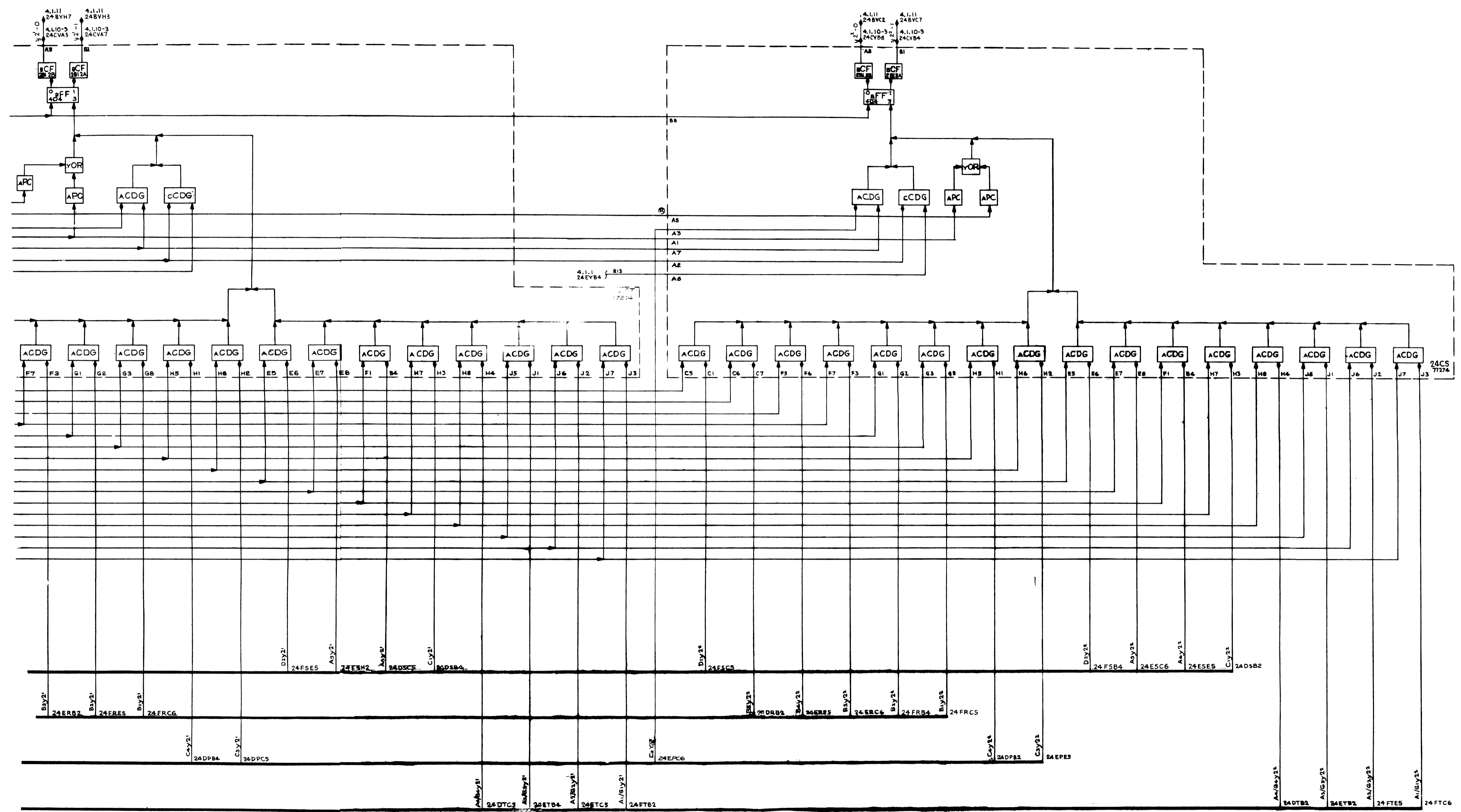

SD CHARACTER SELECTION (Y SEL, REG)

SD CHARACTER SELECTION X,Y SEL, DECO AND ALD

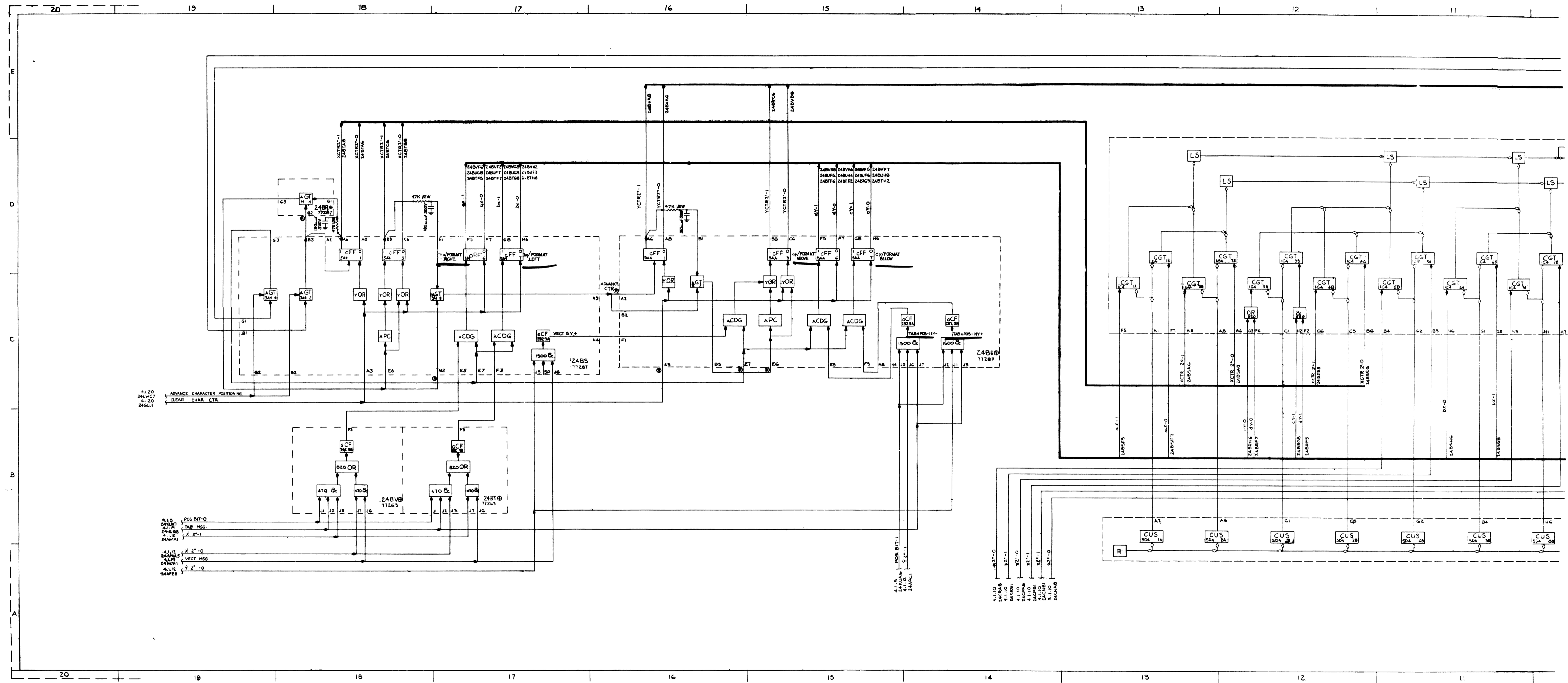

4.1.20  
24LWC7  
4.1.20  
24GUV1

ADVANCE CHARACTER POSITIONING  
CLEAR CHAR. CTR.

4.1.15  
24NUS1  
24NUS2  
24NUS3  
4.1.16  
24AVM1

POS BIT-0  
TAB MSG  
X 2<sup>n</sup>-1

4.1.12  
24VMS5  
24VMS1  
24VMS2  
4.1.12  
24VMS3

X 2<sup>n</sup>-0  
VECT MSG  
Y 2<sup>n</sup>-0

4.1.15  
24NUS1  
4.1.12  
24VMS1  
24VMS2

POS BIT-1  
Y 2<sup>n</sup>-1  
24VMS1

4.1.10  
24KVA8  
4.1.10  
24LSE1  
4.1.10  
24LSE2  
4.1.10  
24LSE3  
4.1.10  
24LSE4  
4.1.10  
24LSE5

Z4KVA8  
Z4LSE1  
Z4LSE2  
Z4LSE3  
Z4LSE4  
Z4LSE5

A2  
A6  
C1  
C6  
G2  
B4  
HG

CUS  
SD4 1A  
CUS  
SD4 2A  
CUS  
SD4 3A  
CUS  
SD4 2B  
CUS  
SD4 3B  
CUS  
SD4 7  
CUS  
SD4 8B

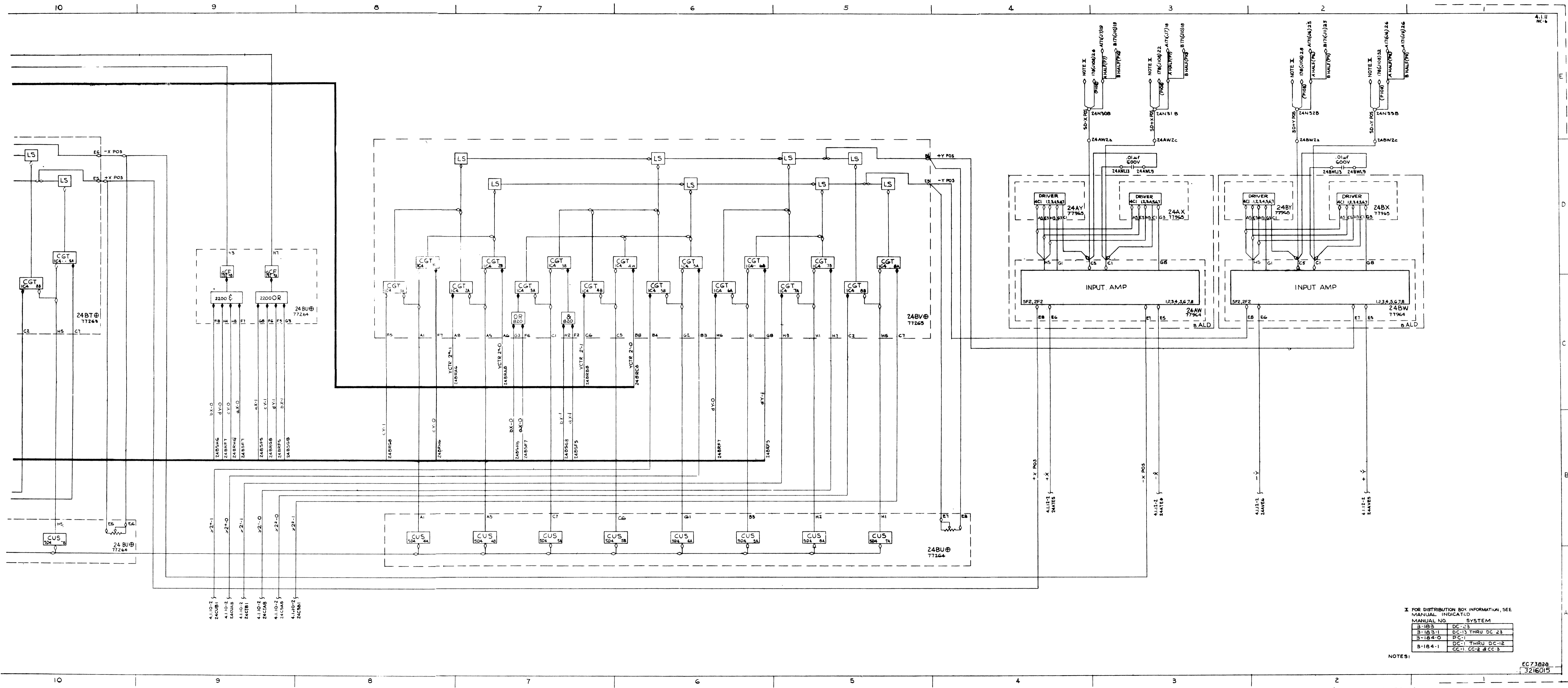

NOTES:

X FOR DISTRIBUTION BOX INFORMATION, SEE MANUAL INDICATED SYSTEM

3-183	DC-23
3-183-1	DC-13 THRU DC 23
3-184-0	PC-1
3-184-1	DC-1 THRU DC-12
	CC-1, CC-2, & CC-3

EC73828  
3216015

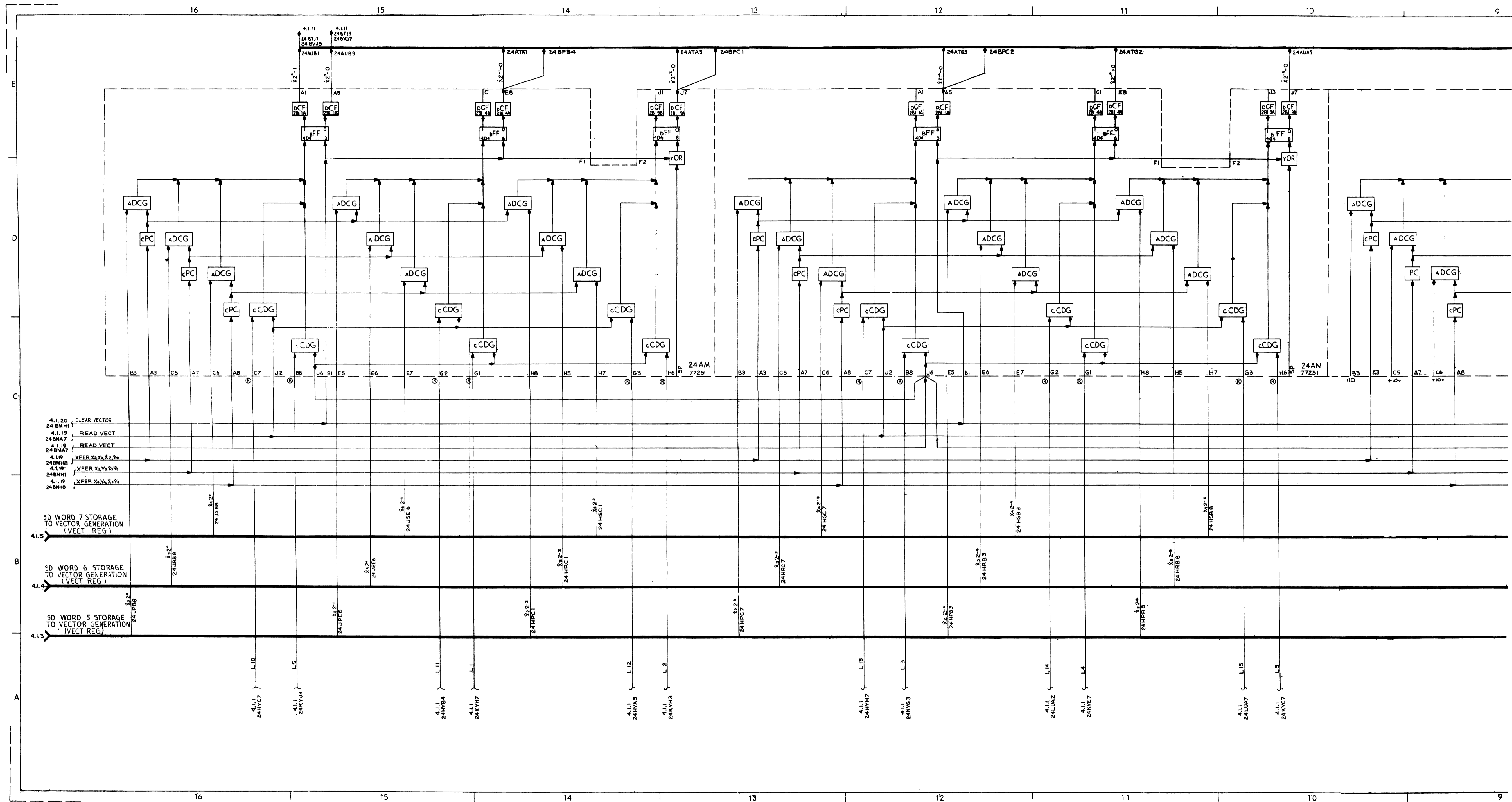

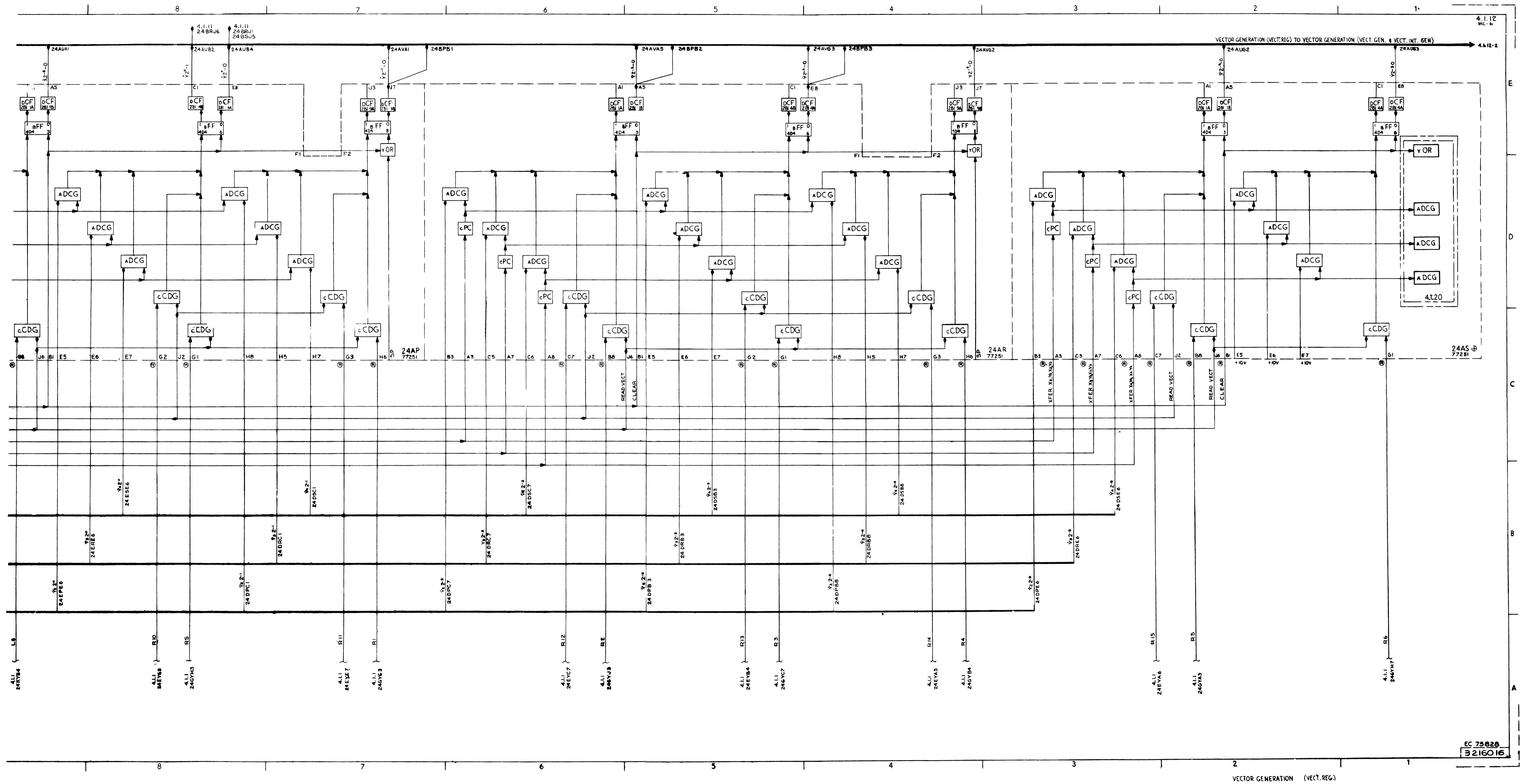





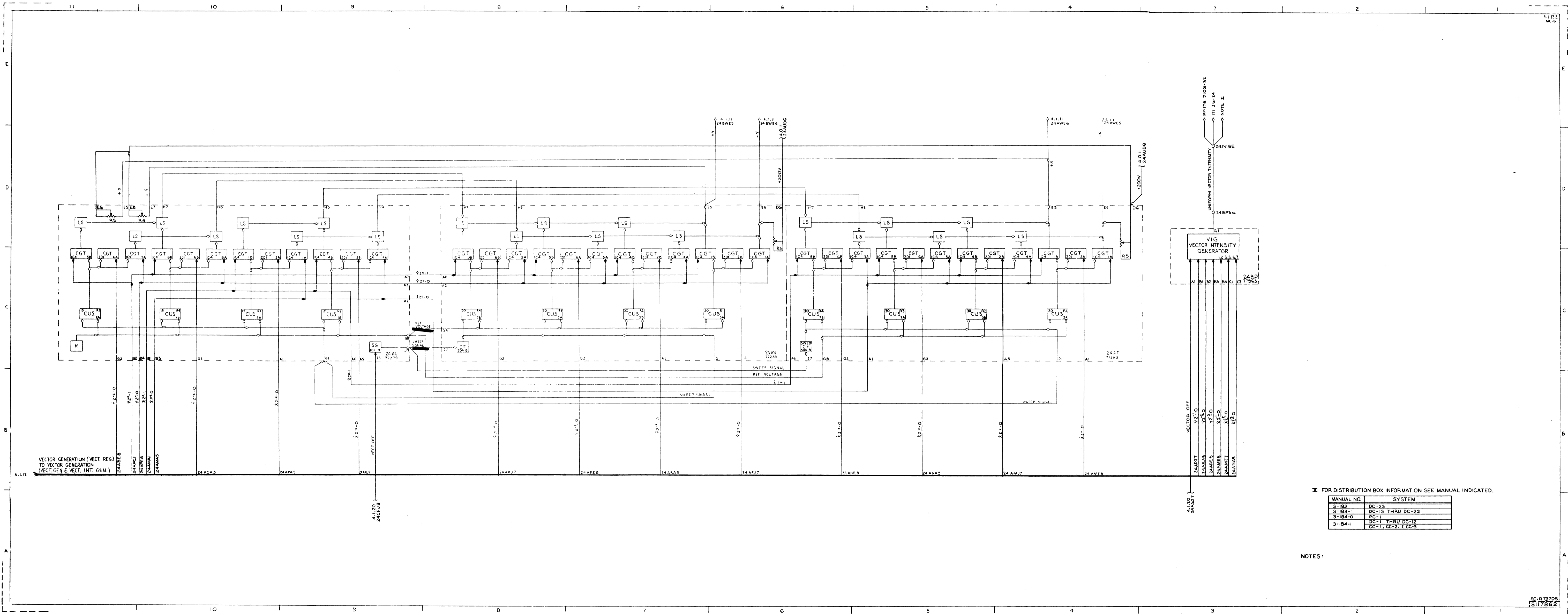

FOR DISTRIBUTION BOX INFORMATION SEE MANUAL INDICATED.

MANUAL NO.	SYSTEM
3-IB3	DC-23
3-IB3-1	DC-13 THRU DC-22
3-IB4-0	DC-1
3-IB4-1	DC-1 THRU DC-12
	CC-1, CC-2, & CC-3

NOTES:

EC-R72705  
13117862

VECTOR GENERATION

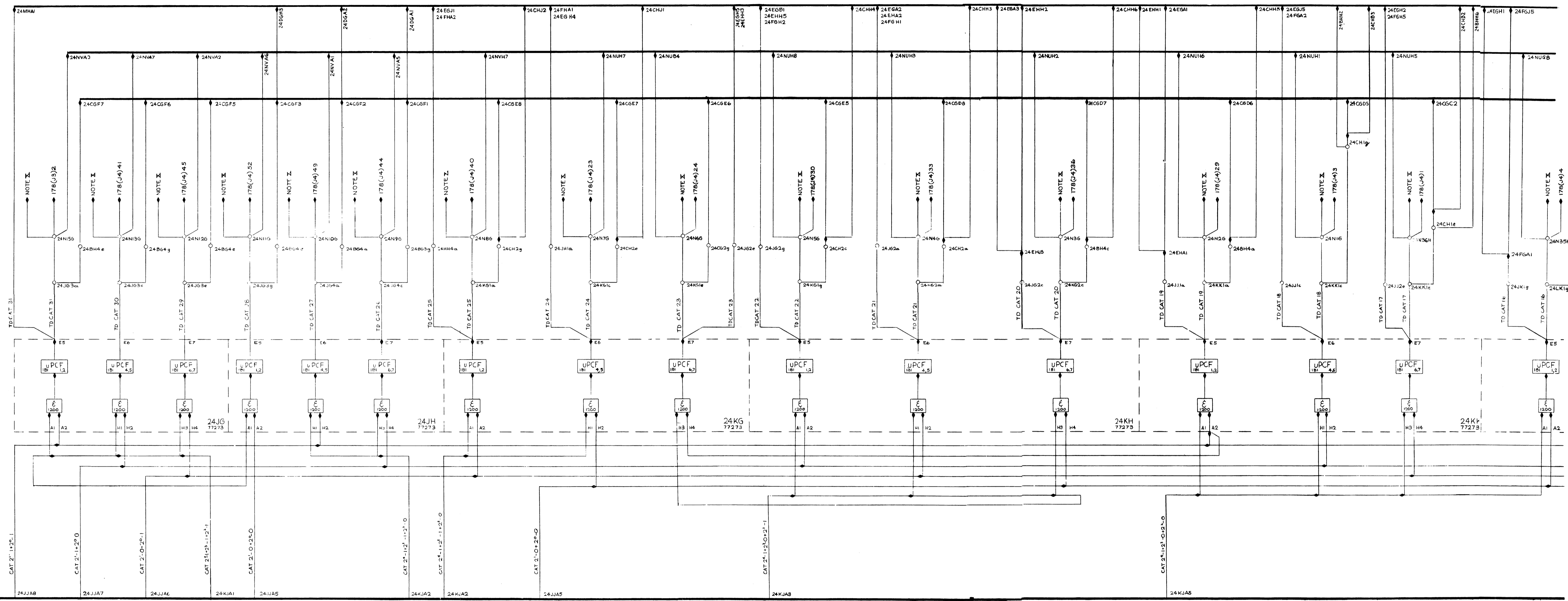

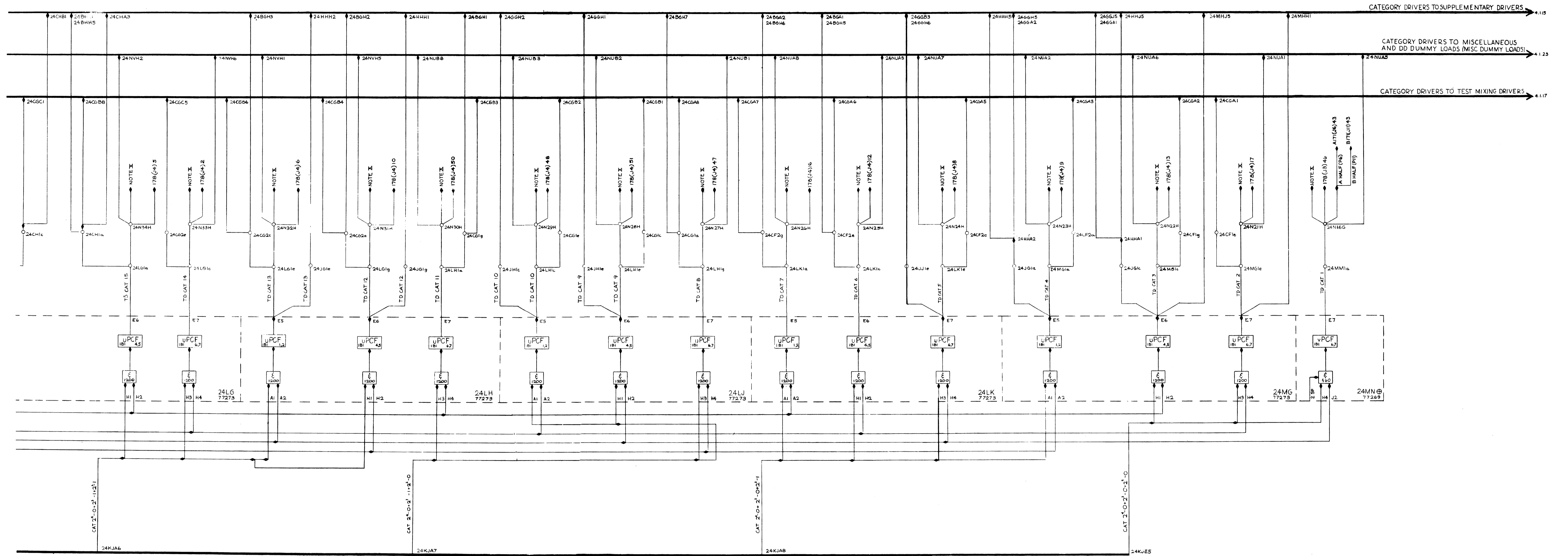

X FOR DISTRIBUTION BOX INFORMATION, SEE LOGIC  
NO. 4.124, DRAWING NO. 3117875  
NOTES

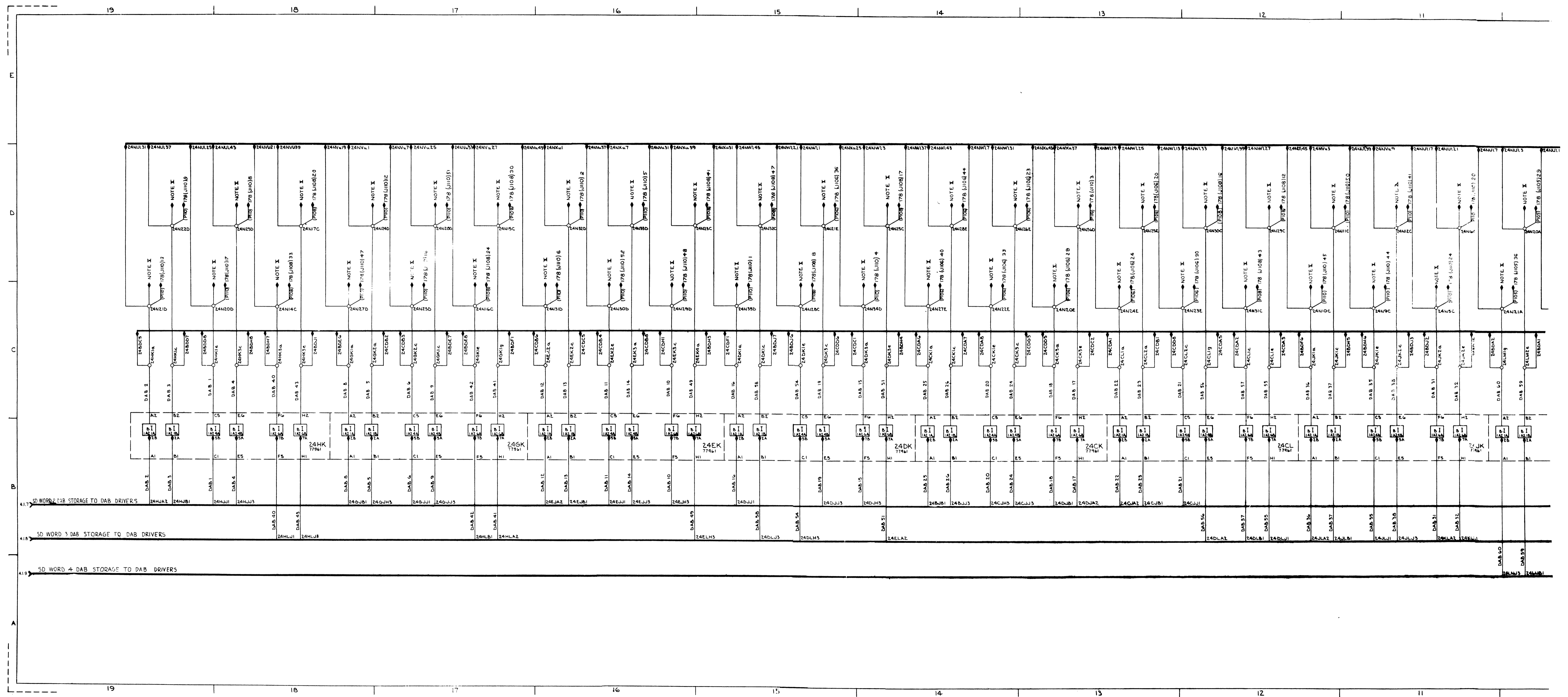

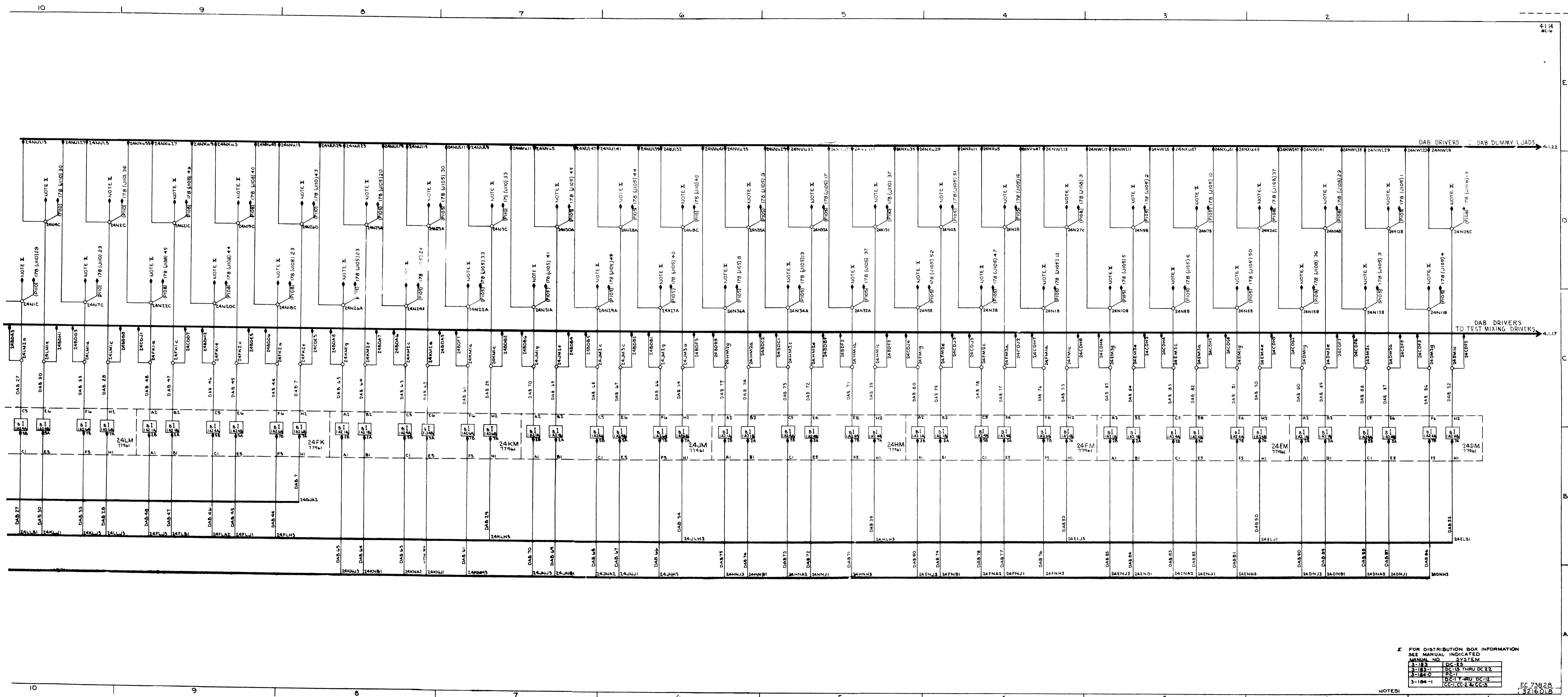

NOTES:

FOR DISTRIBUTION BOX INFORMATION  
SEE MANUAL INDICATED

MANUFACTURER NO.	SYSTEM
3-183-1	DC-23
3-183-2	DC-15 THRU DC-22
3-184-2	DC-1
3-184-1	DC-1 Y-MU DC-12
	CC-1, CC-2 & CC-3

EC 73828  
3216.018

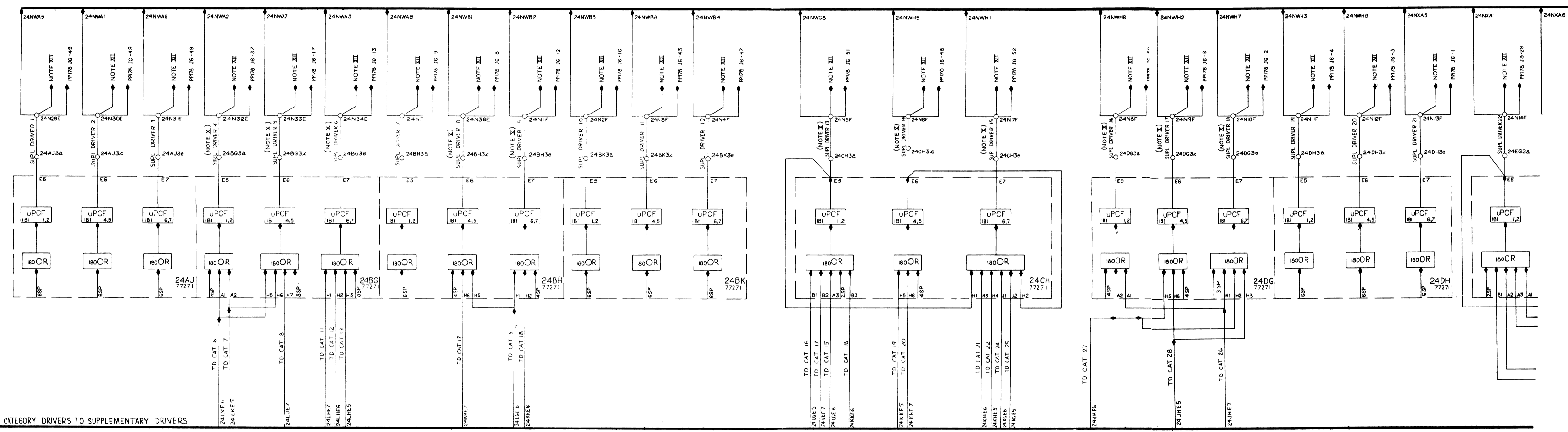

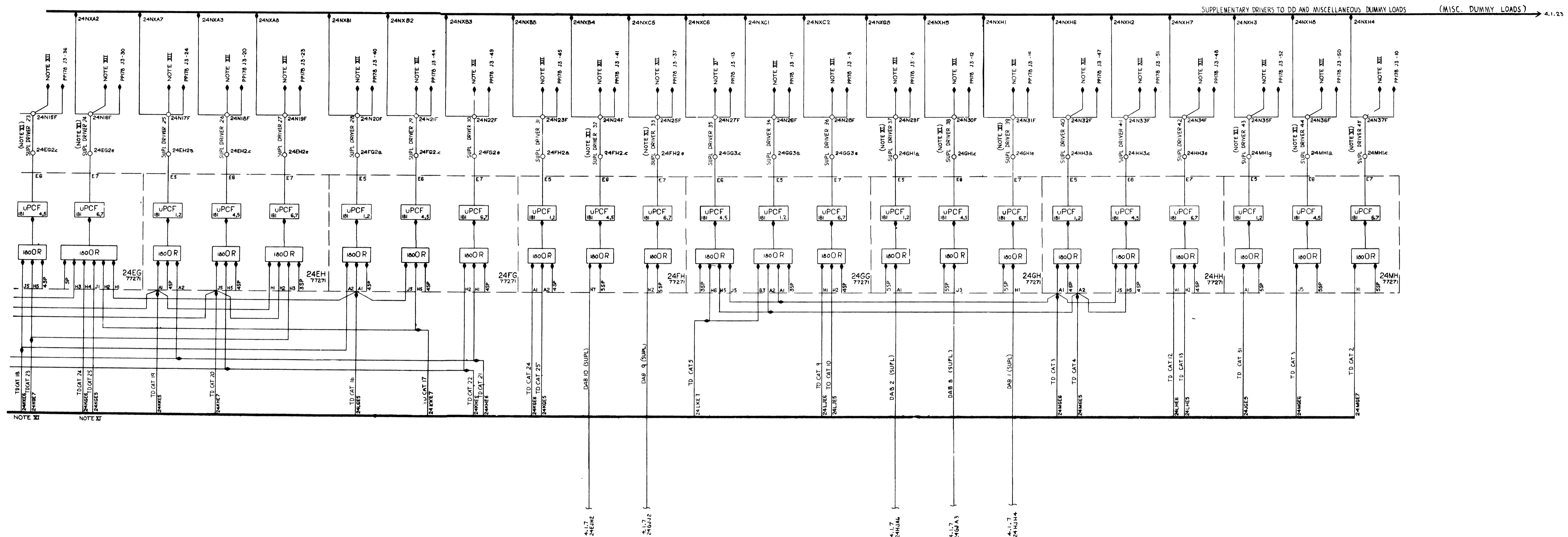

III FOR DISTRIBUTION BOX INFORMATION, SEE LOGIC NO 4-1,24, DRAWING NO 317B7B.  
 II SUPL. DVR. IS WIRED SOLELY FOR D.C. OPERATION  
 I SUPL. DVR. IS WIRED SOLELY FOR C.C. OPERATION  
 NOTES:

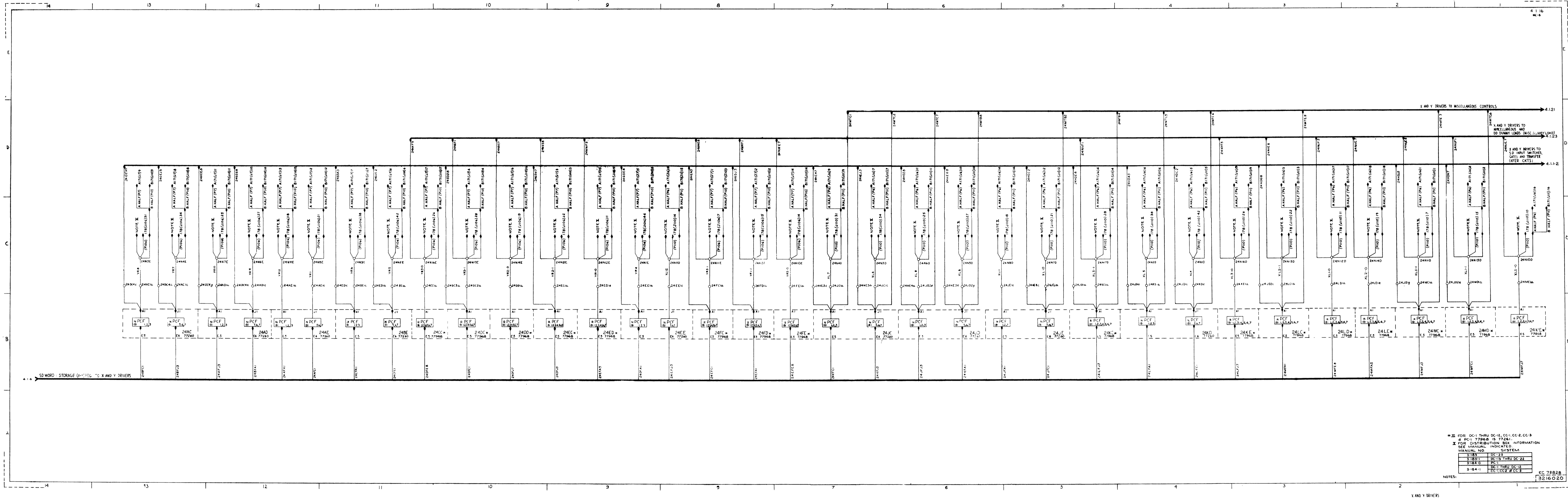



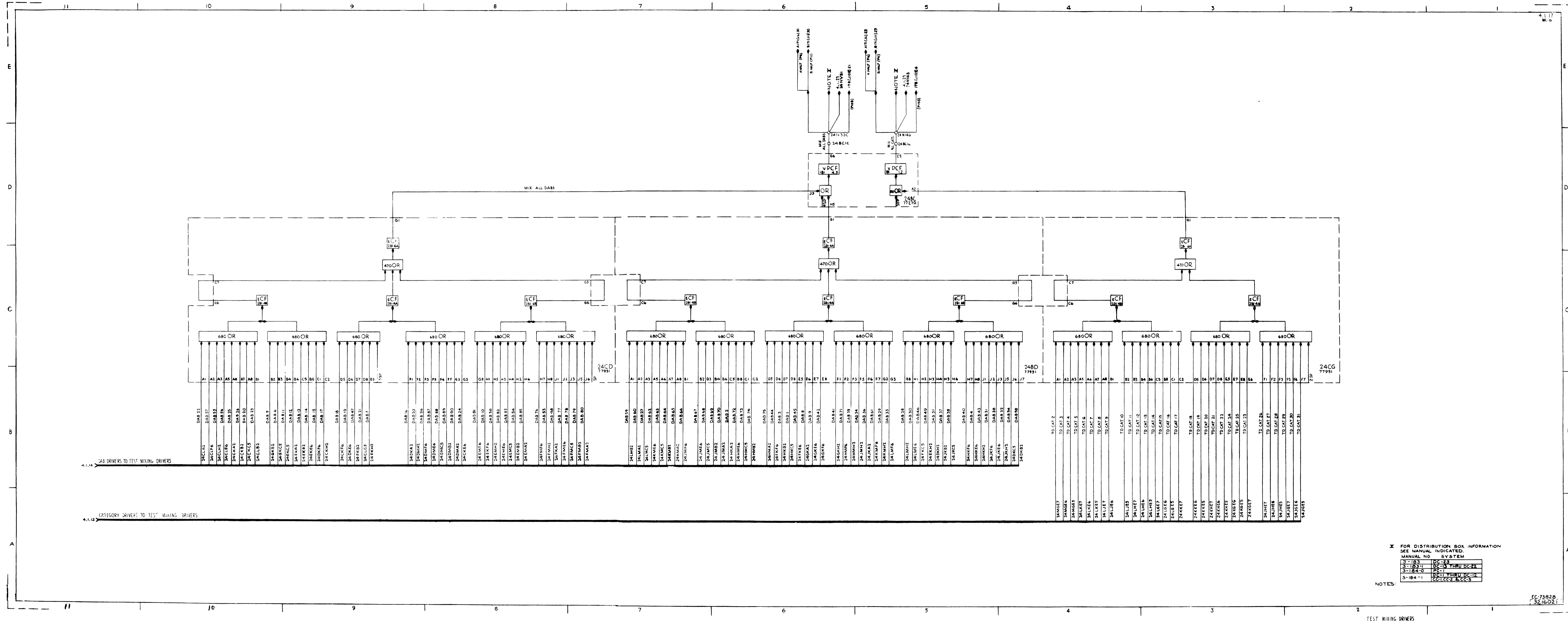

X FOR DISTRIBUTION BOX INFORMATION  
 SEE MANUAL INDICATED.  
 MANUAL NO. SYSTEM  
 3-183 DC-13  
 3-183-1 DC-13 YMMU DC-22  
 3-184-0 DC-13 YMMU DC-12  
 3-184-1 DC-13 YMMU DC-12  
 3-184-2 DC-13 YMMU DC-12

NOTES:



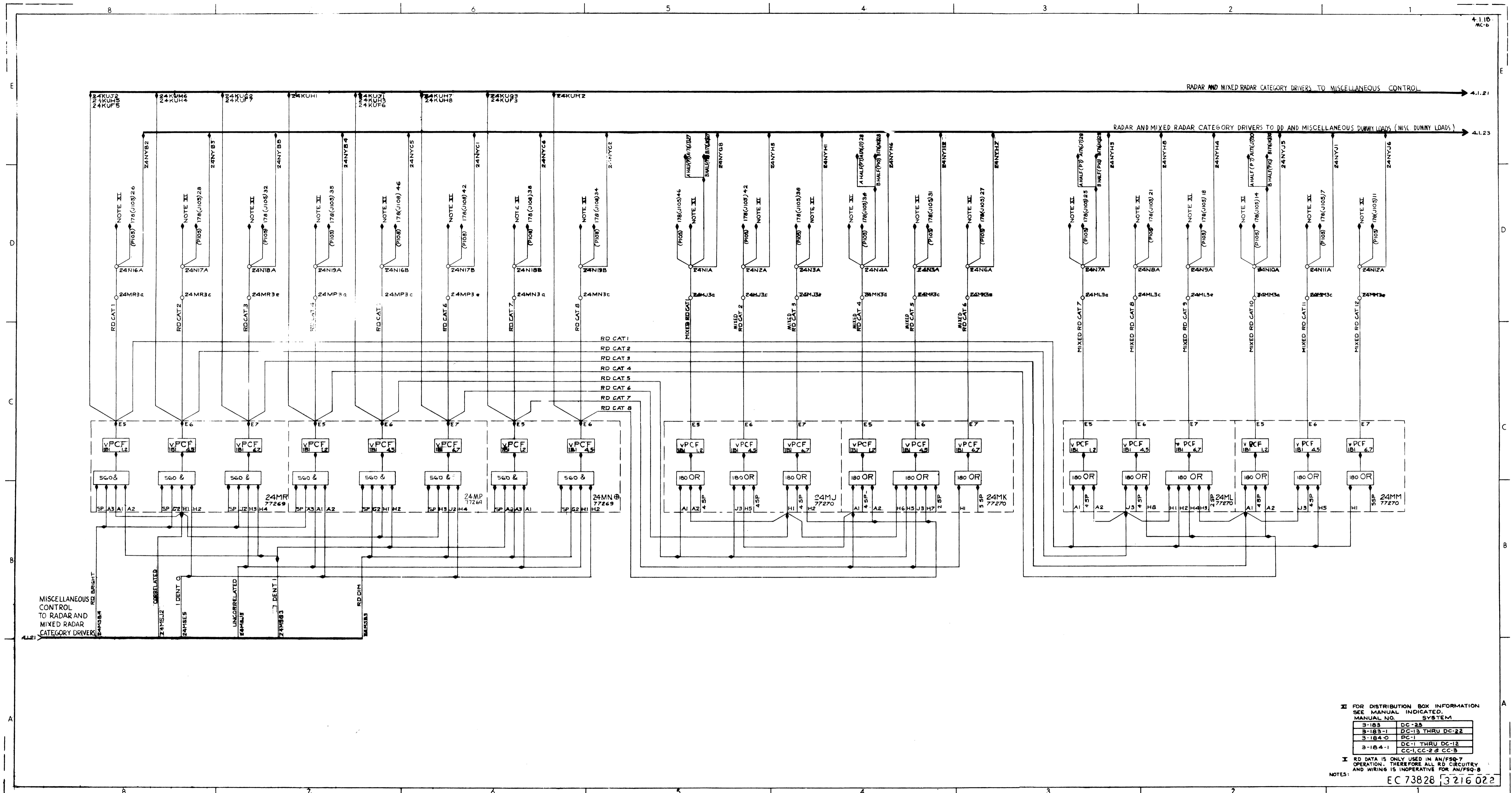

II FOR DISTRIBUTION BOX INFORMATION  
SEE MANUAL INDICATED.  
MANUAL NO. SYSTEM

3-183	DC-25
3-183-1	DC-13 THRU DC-22
3-184-0	PC-1
3-184-1	DC-1 THRU DC-12 CC-1, CC-2 & CC-3

III RD DATA IS ONLY USED IN AN/FSQ-7  
OPERATION. THEREFORE ALL RD CIRCUITRY  
AND WIRING IS INOPERATIVE FOR AN/FSQ-8

NOTES: EC 73828 3216 022

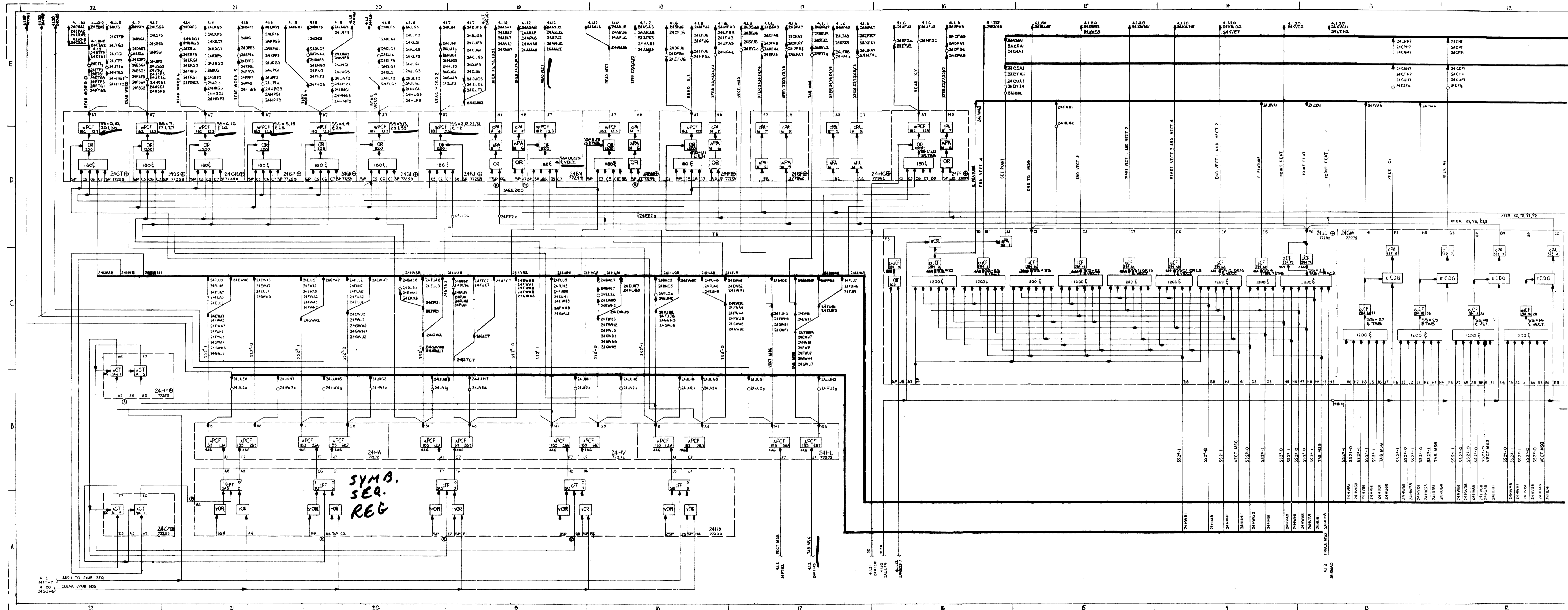

4.1.1 ADD TO SYMB SEQ  
 24LH7  
 4.1.2 CLEAR SYMB SEQ  
 24GMH

SYMB.  
 SER.  
 REG

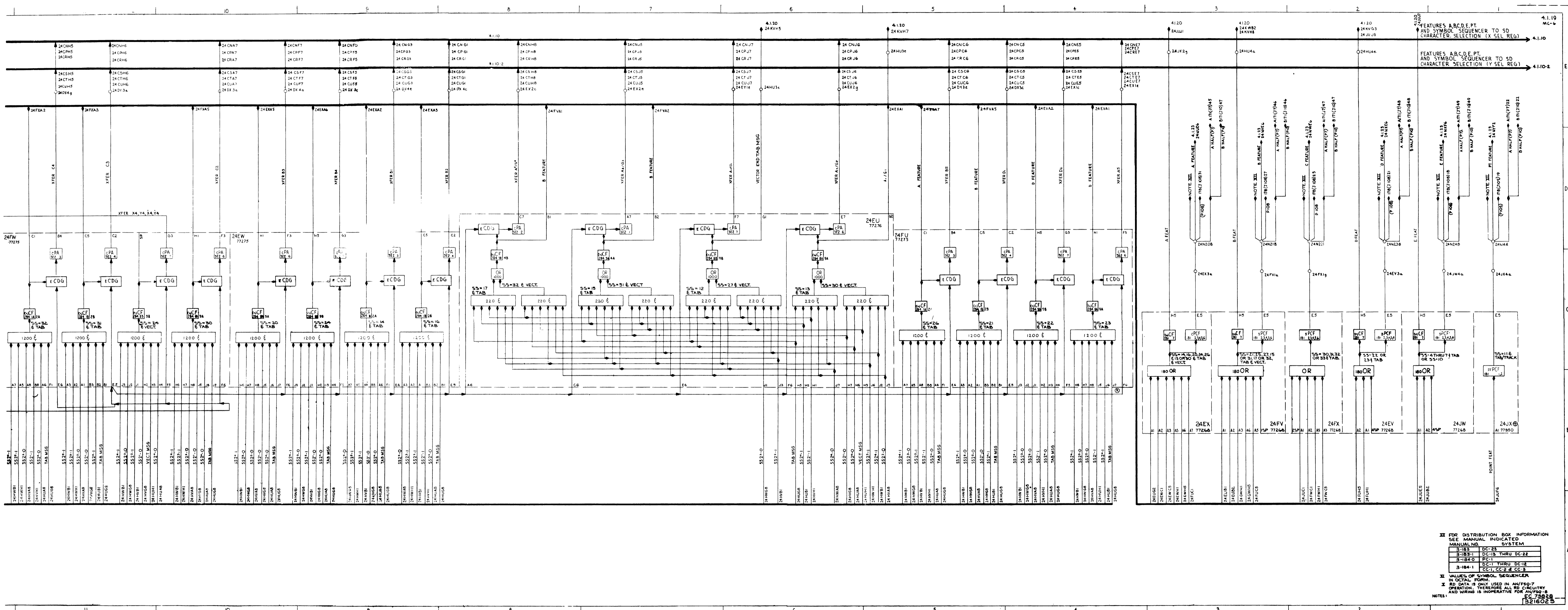

III FOR DISTRIBUTION BOX INFORMATION SEE MANUAL INDICATED SYSTEM

3-183	DC-25
3-184-1	DC-1
3-184-2	DC-2
3-184-3	DC-3
3-184-4	DC-4
3-184-5	DC-5
3-184-6	DC-6
3-184-7	DC-7
3-184-8	DC-8
3-184-9	DC-9
3-184-10	DC-10
3-184-11	DC-11
3-184-12	DC-12
3-184-13	DC-13
3-184-14	DC-14
3-184-15	DC-15
3-184-16	DC-16
3-184-17	DC-17
3-184-18	DC-18
3-184-19	DC-19
3-184-20	DC-20
3-184-21	DC-21
3-184-22	DC-22
3-184-23	DC-23
3-184-24	DC-24
3-184-25	DC-25
3-184-26	DC-26
3-184-27	DC-27
3-184-28	DC-28
3-184-29	DC-29
3-184-30	DC-30
3-184-31	DC-31
3-184-32	DC-32
3-184-33	DC-33
3-184-34	DC-34
3-184-35	DC-35
3-184-36	DC-36
3-184-37	DC-37
3-184-38	DC-38
3-184-39	DC-39
3-184-40	DC-40
3-184-41	DC-41
3-184-42	DC-42
3-184-43	DC-43
3-184-44	DC-44
3-184-45	DC-45
3-184-46	DC-46
3-184-47	DC-47
3-184-48	DC-48
3-184-49	DC-49
3-184-50	DC-50
3-184-51	DC-51
3-184-52	DC-52
3-184-53	DC-53
3-184-54	DC-54
3-184-55	DC-55
3-184-56	DC-56
3-184-57	DC-57
3-184-58	DC-58
3-184-59	DC-59
3-184-60	DC-60
3-184-61	DC-61
3-184-62	DC-62
3-184-63	DC-63
3-184-64	DC-64
3-184-65	DC-65
3-184-66	DC-66
3-184-67	DC-67
3-184-68	DC-68
3-184-69	DC-69
3-184-70	DC-70
3-184-71	DC-71
3-184-72	DC-72
3-184-73	DC-73
3-184-74	DC-74
3-184-75	DC-75
3-184-76	DC-76
3-184-77	DC-77
3-184-78	DC-78
3-184-79	DC-79
3-184-80	DC-80
3-184-81	DC-81
3-184-82	DC-82
3-184-83	DC-83
3-184-84	DC-84
3-184-85	DC-85
3-184-86	DC-86
3-184-87	DC-87
3-184-88	DC-88
3-184-89	DC-89
3-184-90	DC-90
3-184-91	DC-91
3-184-92	DC-92
3-184-93	DC-93
3-184-94	DC-94
3-184-95	DC-95
3-184-96	DC-96
3-184-97	DC-97
3-184-98	DC-98
3-184-99	DC-99
3-184-100	DC-100

IV VALUES OF SYMBOL SEQUENCER IN OCTAL FORM  
 X RD DATA IS ONLY USED IN ANFSQ-7 OPERATION. THEREFORE ALL RD CIRCUITRY AND WIRING IS INOPERATIVE FOR ANFSQ-8  
 NOTE 1: 152102B

FEATURES A, C, D, E, PT, AND SYMBOL SEQUENCER

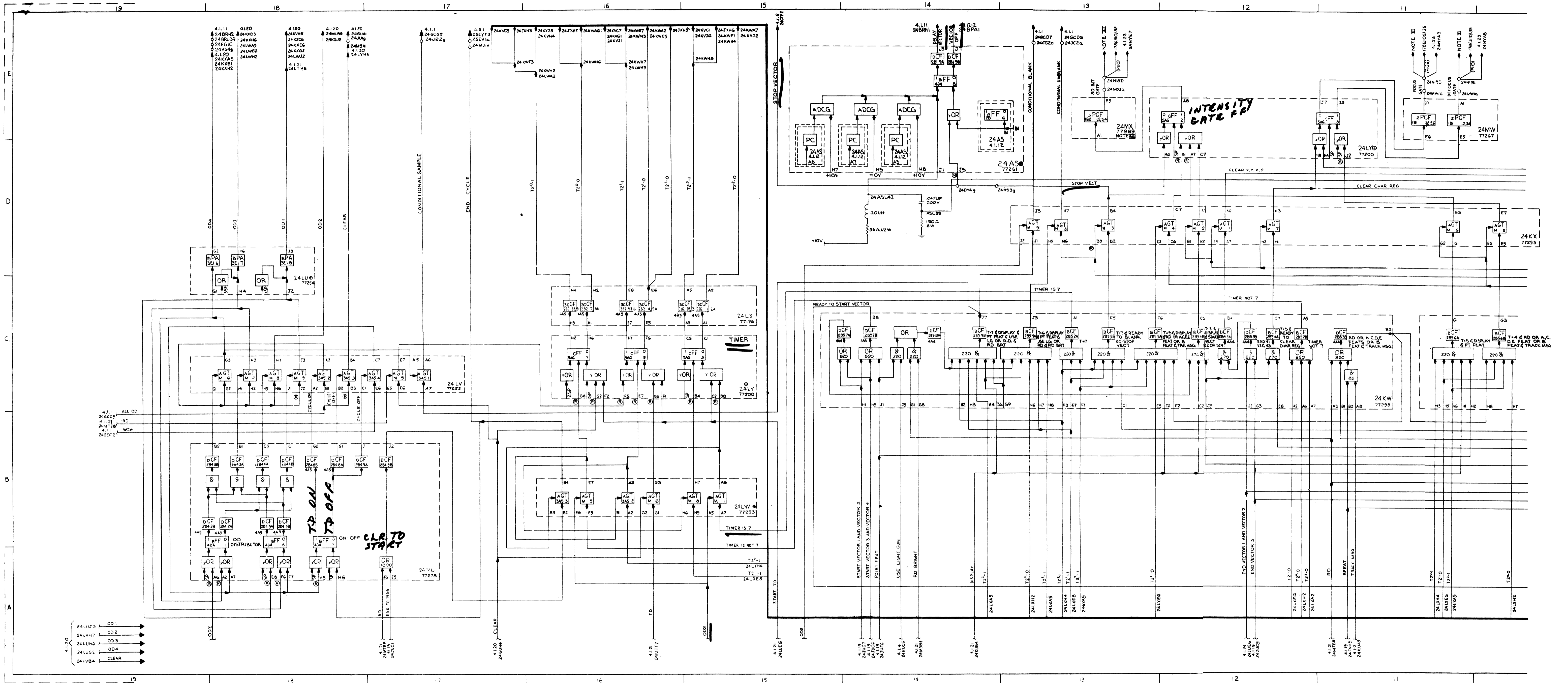

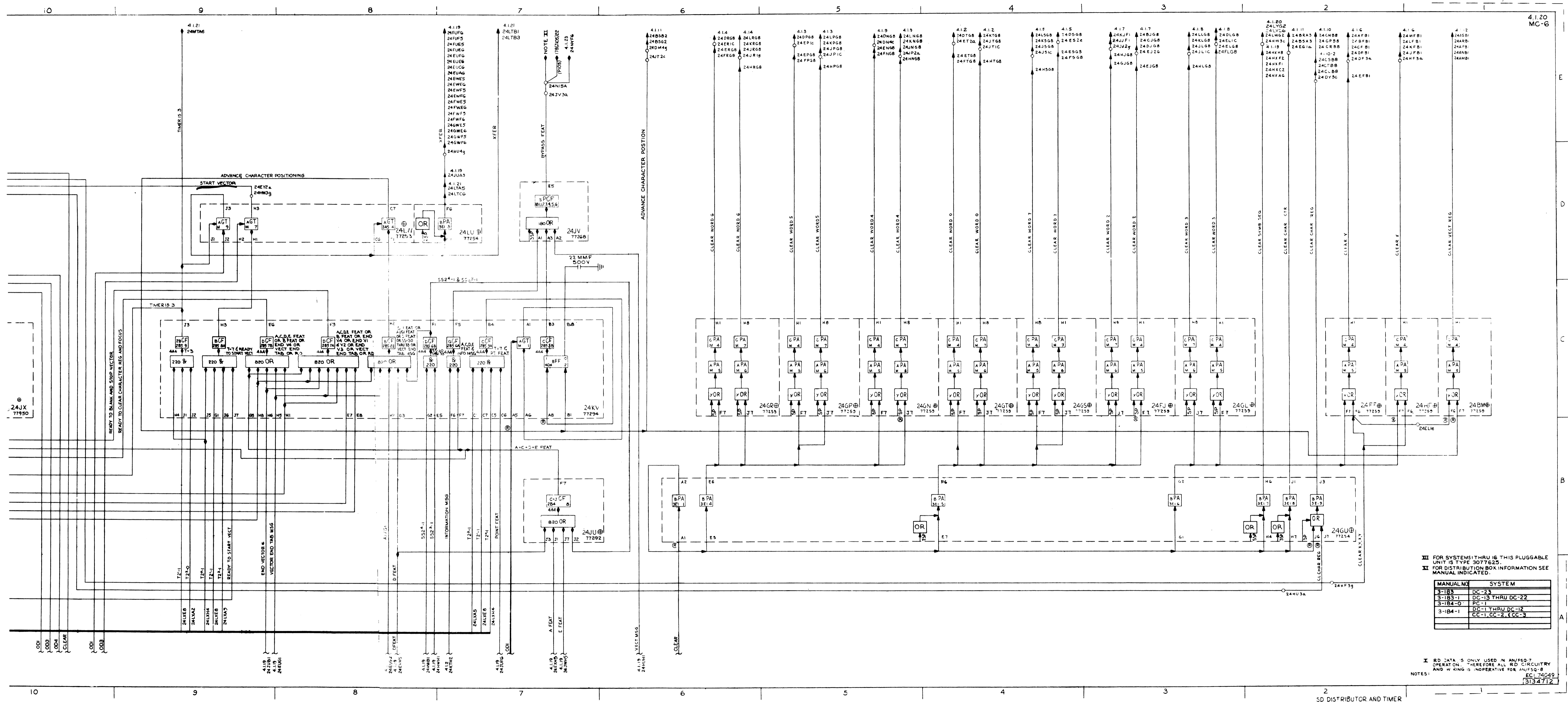

III FOR SYSTEMS THRU 16 THIS PLUGGABLE UNIT IS TYPE 3077625.  
 XI FOR DISTRIBUTION BOX INFORMATION SEE MANUAL INDICATED.

MANUAL NO.	SYSTEM
3-1B3	DC-23
3-1B3-1	DC-13 THRU DC-22
3-1B4-0	DC-1
3-1B4-1	DC-1 THRU DC-12
	CC-1, CC-2, & CC-3

IX RD DATA IS ONLY USED IN AN/FSQ-7 OPERATION. THEREFORE ALL RD CIRCUITRY AND WIRING IS INOPERATIVE FOR AN/FSQ-8.  
 EC-74049  
 3134712

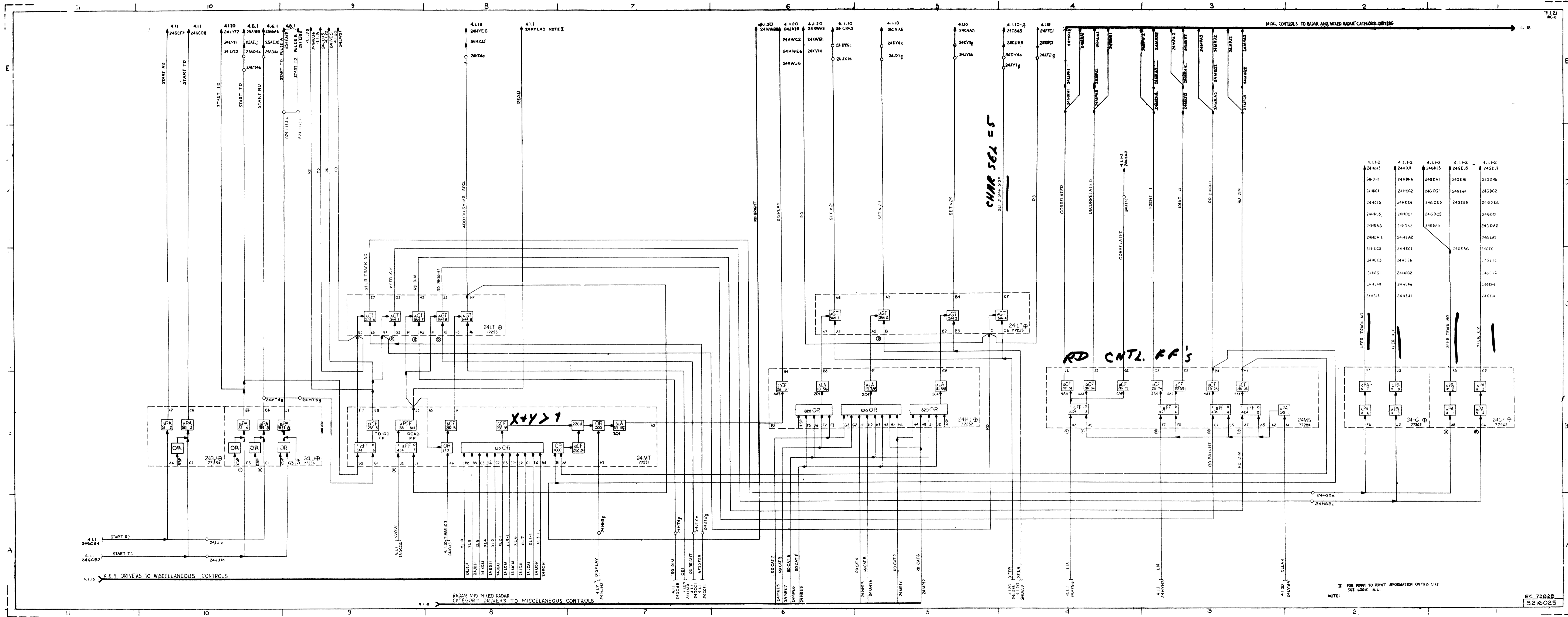

NOTE: X FOR POINT TO POINT INFORMATION ON THIS LINE SEE LOGIC 4.1.1

EC 73828  
3216025



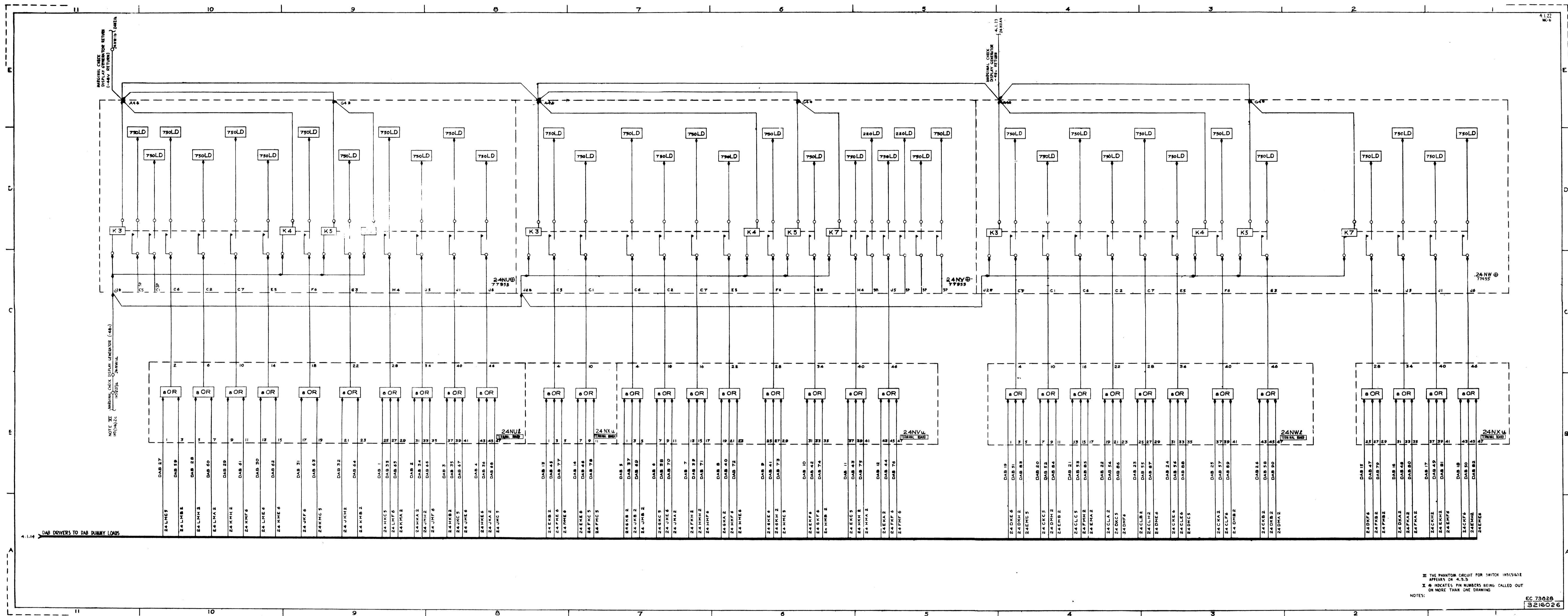

MACHINE CHECK DISPLAY GENERATOR RETURN (-48V RETURN)

NOTE 2: MACHINE CHECK DISPLAY GENERATOR (-48V RETURN) 24NW2

MACHINE CHECK DISPLAY GENERATOR (-48V RETURN)

NOTE: 1. THE PHANTOM CIRCUIT FOR SWITCH 1N51612 APPEARS ON 4-3-3. X \* INDICATES PIN NUMBERS BEING CALLED OUT ON MORE THAN ONE DRAWING.

EC 79628  
3216026

DAB DUMMY LOADS

22 21 20 19 18 17 16 15 14 13 12

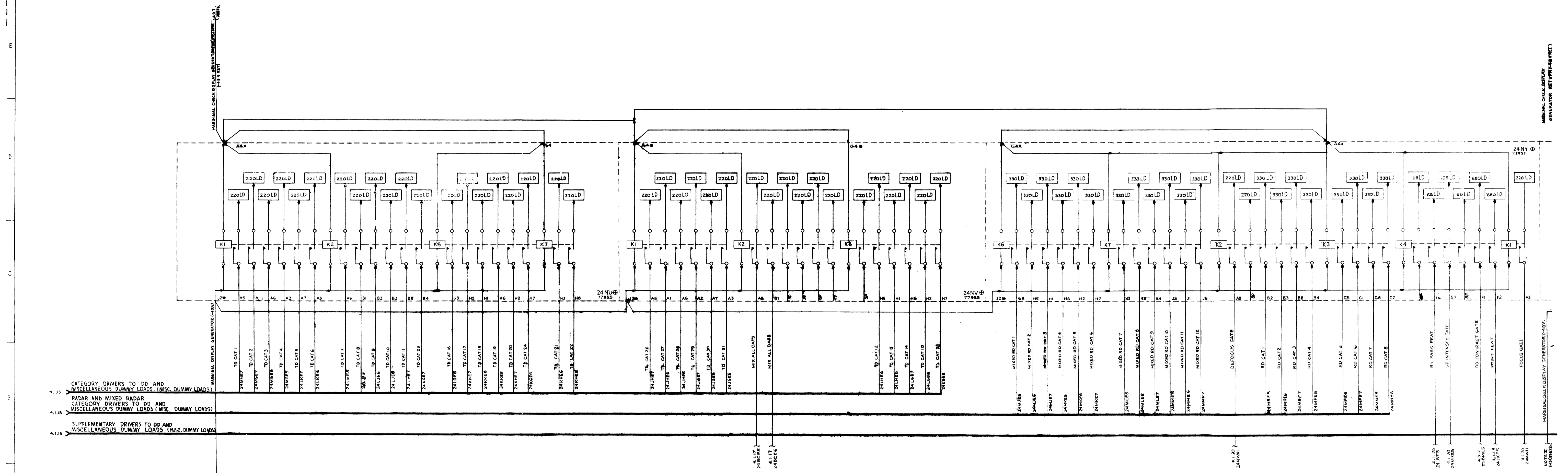

4.1.13 CATEGORY DRIVERS TO DD AND MISCELLANEOUS DUMMY LOADS (MISC. DUMMY LOADS)  
 4.1.18 RADAR AND MIXED RADAR CATEGORY DRIVERS TO DD AND MISCELLANEOUS DUMMY LOADS (MISC. DUMMY LOADS)  
 4.1.15 SUPPLEMENTARY DRIVERS TO DD AND MISCELLANEOUS DUMMY LOADS (MISC. DUMMY LOADS)

MARGINAL CHECK DISPLAY GENERATOR (REV. 1)

MARGINAL CHECK DISPLAY GENERATOR (REV. 1)

4.1.16 X AND Y DRIVERS TO DD AND MISCELLANEOUS DUMMY LOADS (MISC.)

11 10 9 8 7 6 5 4 3 2

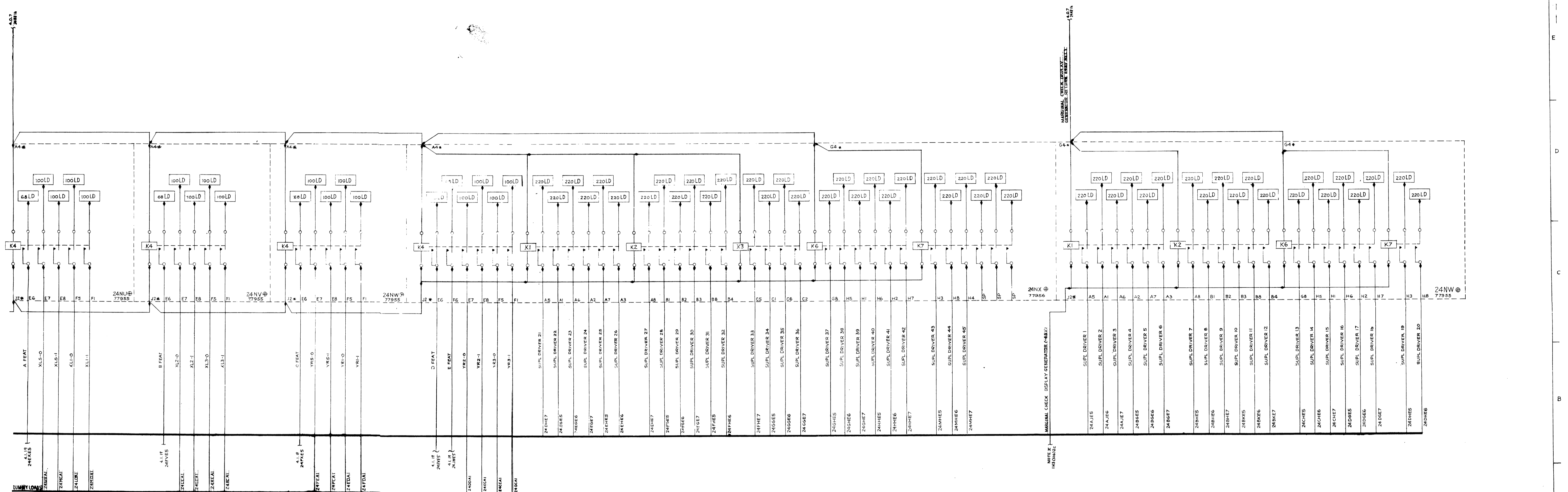

DUMMY LOADS  
 24NU 77955  
 24NW 77955  
 24NX 77956  
 24AJE5  
 24AJE6  
 24AJE7  
 24BGE5  
 24BGE6  
 24BGE7  
 24CHES  
 24CHE6  
 24CHE7  
 24DGE5  
 24DGE6  
 24DGE7  
 24DHES  
 24DHE6

NOTE 3  
 103010/52  
 MARGINAL CHECK DISPLAY GENERATOR (4-8V)

III RD DATA IS ONLY USED IN AN F5Q-7 OPERATION, THEREFORE ALL RD CIRCUITRY AND WIRING IS NONREPRESENTATIVE FOR AN F5Q-8  
 II \* INDICATES THAT THE P.W. IS USED ON MORE THAN ONE DRAWING.  
 I THE PHANTOMED CIRCUIT FOR SWITCH 1HS (14) 2 APPEARS ON LOGIC 4.3.3  
 NOTES:  
 EC 73020  
 3216027

DD AND MISCELLANEOUS DUMMY LOADS (MISC DUMMY LOADS)