

**IBM System/3  
Model 10  
Disk System  
Operator's Guide**

## Preface

This manual provides the information needed to operate the IBM System/3 Model 10 Disk System, Program Number 5702-SC1. Operation of Program Products 5702-AS1, 5702-RG1, 5702-SM1, 5702-SM2, and 5702-UT1 is also in this manual. Chapter 1 provides an introduction. Chapters 2 through 9 describe the operating equipment and the function and use of the equipment. Chapters 10 through 12 describe system operation, program operation on the system and system generation. Familiarity with Chapters 1 through 9 is necessary before proceeding to the remaining chapters.

*Note:* In this publication, there are references to a System/3 Model 10 with a 64K processing unit and to MLTA (Multiple Line Terminal Adapter); these optional features are available only on a RPQ (Request for Price Quotation) basis. Contact your IBM Marketing Representative for a complete explanation of RPQ.

The following manuals contain additional information about the IBM System/3 Model 10 Disk System:

*IBM System/3 Disk System Introduction*, GC21-7510

*IBM System/3 Model 10 Disk System Control Programming Reference Manual*, GC21-7512

*IBM System/3 Sort/Collate and Card Utilities Reference Manual*, SC21-7529

*IBM System/3 Card and Disk System Components Reference Manual*, GA21-9103

*IBM System/3 Model 10 Disk System Halt Guide*, GC21-7540

*IBM System/3 Disk System RPG II Reference Manual*, SC21-7504

*IBM System/3 Disk Sort Reference Manual*, SC21-7522

*IBM System/3 Disk System Basic Assembler Program Reference Manual*, SC21-7509

*IBM 1403 Printer Component Description*, GA24-3073

*IBM System/3 Subset American National Standard COBOL Compiler and Library Programmer's Guide*, SC28-6459

*IBM System/3 Subset American National Standard COBOL*, GC28-6452

*IBM System/3 Disk FORTRAN IV Reference Manual*, SC28-6874

*IBM System/3 Model 10 Tape Sort Reference Manual*, SC21-7572

### Fourth Edition (September 1972)

This is a major revision of, and obsoletes, GC21-7508-2. It is revised to include a chapter on the IBM 3410/3411 Magnetic Tape Subsystem. Appendix E has also been revised and now contains information on storage estimates. Changes to text and small changes to illustrations are indicated by a vertical line at the left of the change; new or extensively revised illustrations are denoted by the symbol ● at the left of the figure caption.

This edition applies to version 07, modification 00 of IBM System/3 Model 10 Disk System (Program Number 5702-SC1), and to all subsequent versions, and modification levels until otherwise indicated in new editions or Technical Newsletters. Changes are continually made to the specifications herein; before using this publication in connection with the operation of IBM Systems, consult the latest IBM System/3 Newsletter, GN20-2228, for the editions that are applicable and current.

Requests for copies of IBM publications should be made to your IBM representative or to the IBM branch office serving your locality.

A Reader's Comment Form is at the back of this publication. If the form is gone, address your comments to IBM Corporation, Publications, Department 245, Rochester, Minnesota 55901.

CHAPTER 1. YOU AND SYSTEM/3 . . . . .	1	CHAPTER 8. IBM 5471 PRINTER-KEYBOARD . . . . .	87
Introduction . . . . .	2	Use of the Printer-Keyboard . . . . .	88
Program Run Sheet . . . . .	4	Removing the Typeball . . . . .	90
CHAPTER 2. IBM 5410 PROCESSING UNIT		Replacing the Typeball . . . . .	90
CONTROLS AND INDICATORS . . . . .	7	Adjusting the Impression Selector . . . . .	91
System Controls and Indicators . . . . .	8	Removing the Fabric Ribbon Cartridge . . . . .	92
System Control Panel . . . . .	9	Installing a Fabric Ribbon Cartridge . . . . .	93
Emergency Power Off and Meter Panel . . . . .	10	Placing Forms in the Printer-Keyboard . . . . .	95
Processing Unit Display Panel . . . . .	11	CHAPTER 9. IBM 1442 CARD READ PUNCH . . . . .	97
Customer Engineer Control Panel . . . . .	12	1442 Controls and Indicators . . . . .	98
Disk Panel . . . . .	13	Clearing a Card Jam . . . . .	100
Dual Program Control Panel . . . . .	14	Indications . . . . .	100
Binary Synchronous Communications		Removing Cards from the Card Feed Path . . . . .	100
Adapter Panel . . . . .	15	1442 Power On and Ready Procedures . . . . .	104
CHAPTER 3. IBM 5424 MULTI-FUNCTION		1442 Last Card Procedures . . . . .	104
CARD UNIT . . . . .	17	CHAPTER 10. SYSTEM OPERATION . . . . .	105
MFCU Controls and Indicators . . . . .	18	Using the 1442 as the Only Card Input Device . . . . .	106
Clearing a Card Jam . . . . .	19	Preparing System for Program Operation . . . . .	106
Changing the MFCU Print Ribbon . . . . .	24	Clear Cards from the MFCU . . . . .	106
Removal . . . . .	24	Place Forms in the Printer . . . . .	106
Installation . . . . .	27	Perform IPL (Initial Program Load) . . . . .	106
Emptying the MFCU Chip Box . . . . .	30	Clearing I/O Attention . . . . .	110
CHAPTER 4. IBM 5203 PRINTER . . . . .	31	Using the Console Error Log Sheet . . . . .	110
Printer Controls and Indicators . . . . .	32	Stopping a Job Before it is Completed . . . . .	110
Loading Forms in the Printer . . . . .	34	Using the Machine Covers for Safety . . . . .	113
Changing the Printer Ribbon . . . . .	44	Turning System Power Off . . . . .	113
Removal . . . . .	44	Restoring System Power . . . . .	115
Installation . . . . .	48	PWR CHK Light Only . . . . .	115
Changing the Print Chain Cartridge . . . . .	50	PWR CHK and TH CHK Lights . . . . .	115
Removal . . . . .	50	No Lights . . . . .	115
Installation of 48-Character LC Print Arrangement		Core Storage Dump . . . . .	115
Chain . . . . .	54	Consideration Before Taking a Core Storage Dump . . . . .	115
Installation of UCS Cartridge . . . . .	56	Dual Programming Operation . . . . .	116
CHAPTER 5. IBM 3410/3411 MAGNETIC TAPE		Procedures . . . . .	116
SUBSYSTEM . . . . .	61	Procedures for Canceling Jobs . . . . .	117
Magnetic Tape Unit Controls and Indicators . . . . .	62	CHAPTER 11. PROGRAM OPERATION . . . . .	119
Keys . . . . .	62	Operation Control Language (OCL) Consideration . . . . .	120
Lights . . . . .	62	// DATE Statement . . . . .	120
Mounting a Reel . . . . .	62	// READER Statement . . . . .	120
Removing a Reel . . . . .	65	// LOG Statement . . . . .	120
Replacing Tape Markers . . . . .	65	// LOAD Statement . . . . .	120
Cleaning the Tape Head . . . . .	67	// RUN Statement . . . . .	121
Magnetic Tape Handling . . . . .	68	// SWITCH Statement . . . . .	121
CHAPTER 6. IBM 5440 DISK CARTRIDGE AND IBM		// NOHALT Statement . . . . .	121
5444 DISK STORAGE DRIVE . . . . .	69	// HALT Statement . . . . .	121
Mounting a 5440 Disk Cartridge . . . . .	70	// PAUSE Statement . . . . .	121
Removing a 5440 Disk Cartridge . . . . .	74	// CALL Statement . . . . .	121
CHAPTER 7. IBM 2316 DISK CARTRIDGE AND IBM		// FILE Statement . . . . .	121
5445 DISK STORAGE DRIVE . . . . .	79	// PARTITION Statement . . . . .	121
Disk Controls and Indicators . . . . .	80	// COMPILE Statement . . . . .	121
Mounting a 2316 Disk Cartridge . . . . .	81	// FORMS Statement . . . . .	121
Removing a 2316 Disk Cartridge . . . . .	83	// IMAGE Statement . . . . .	121
		// PUNCH Statement . . . . .	121
		// BSCA Statement . . . . .	121
		// LOCKOUT Statement . . . . .	121

RPG II Program . . . . .	122	Performing System Generation Using the 5471	
Compilation . . . . .	122	Printer/Keyboard . . . . .	204
Object Program Execution . . . . .	124	Backing Up Your Resident System . . . . .	204
Executing an RPG II I-Type Program . . . . .	126	System Control Program (SCP) Generation . . . . .	204
Interrupting an RPG II Object Program . . . . .	126	Program Product Generation . . . . .	205
RPG II Telecommunications Program . . . . .	129	Completing System Generation and Installation	
Compilation . . . . .	129	Verification . . . . .	206
Execution . . . . .	129	Options and Consideration After System	
Device Counter Logout Program . . . . .	131	Generation . . . . .	207
Card Utilities . . . . .	133	APPENDIX A. IMAGE STATEMENT . . . . .	209
96-List Program . . . . .	134	Description of the IMAGE Statement . . . . .	209
96-96 Reproduce and Interpret Program . . . . .	135	// IMAGE Parameters . . . . .	209
Restart Procedure . . . . .	135	Using the IMAGE Statement to Change the Chain	
Reformat Data Card . . . . .	137	Image when Performing System Generation . . . . .	210
MFCU Sort/Collate Program . . . . .	139	Procedures for Selecting IMAGE Statement	
Sort Operating Procedure . . . . .	141	and Data Cards at System Generation Time . . . . .	213
Data Recording Program . . . . .	145	APPENDIX B. SORT/COLLATE MESSAGES . . . . .	215
Program Load Procedure . . . . .	145	APPENDIX C. RPG II SAMPLE PROGRAM . . . . .	223
Data Verifying Program . . . . .	146	Preparing the Sample Programs for	
Program Load Procedure . . . . .	146	Compilation . . . . .	223
Disk Sort Program . . . . .	146	Compiling the SAMPL1 Program . . . . .	224
Tape Sort Program . . . . .	149	Compiling the SAMPL2 Program . . . . .	224
Basic Assembler Program . . . . .	149	Executing the SAMPL1 Program . . . . .	224
Execution of a Basic Assembler Object Program . . . . .	150	Executing the SAMPL2 Program . . . . .	224
Disk Utility Programs . . . . .	151	APPENDIX D. PROBLEM DETERMINATION . . . . .	233
Operating Procedures . . . . .	151	Performing Problem Determination . . . . .	233
Operating Procedures for Library Maintenance		Halts . . . . .	233
Utility Program . . . . .	153	Processor Checks . . . . .	233
Disk Resident Tape Utility Programs . . . . .	155	System Loops . . . . .	233
Operating Procedures . . . . .	155	Incorrect Output . . . . .	234
Use of Checkpoint/Restart and Execution of a		APPENDIX E. STORAGE ESTIMATES . . . . .	245
Checkpoint Program . . . . .	156	Main Storage Estimates . . . . .	245
Checkpoint Accepted . . . . .	156	Supervisor Size Estimates . . . . .	245
Removing Cards Prior to Restarting a		Data Management Estimates . . . . .	246
Checkpoint Program . . . . .	156	Secondary (Disk) Storage Estimating . . . . .	253
Restarting a Checkpointed Program . . . . .	156	Storage Requirements on the Distribution	
CHAPTER 12. SYSTEM GENERATION . . . . .	159	Disk Cartridge . . . . .	253
Performing System Generation Using the MFCU		Determining Library Requirements on Generated	
or 1442 . . . . .	160	System Packs and Program Packs . . . . .	256
Preparing for System Generation . . . . .	160	APPENDIX F. PROCEDURES FOR APPLYING	
Backing Up Your Resident System . . . . .	161	PROGRAM TEMPORARY FIXES . . . . .	267
System Control Program (SCP) Generation . . . . .	162	Considerations Before Applying PTFs . . . . .	267
Program Product Generation . . . . .	190	Applying the PTF . . . . .	267
Completing System Generation and Installation		INDEX . . . . .	269
Verification . . . . .	196		
Options and Considerations After System			
Generation . . . . .	199		
Building a Program Pack . . . . .	201		



- Introduction
- Program Run Sheet

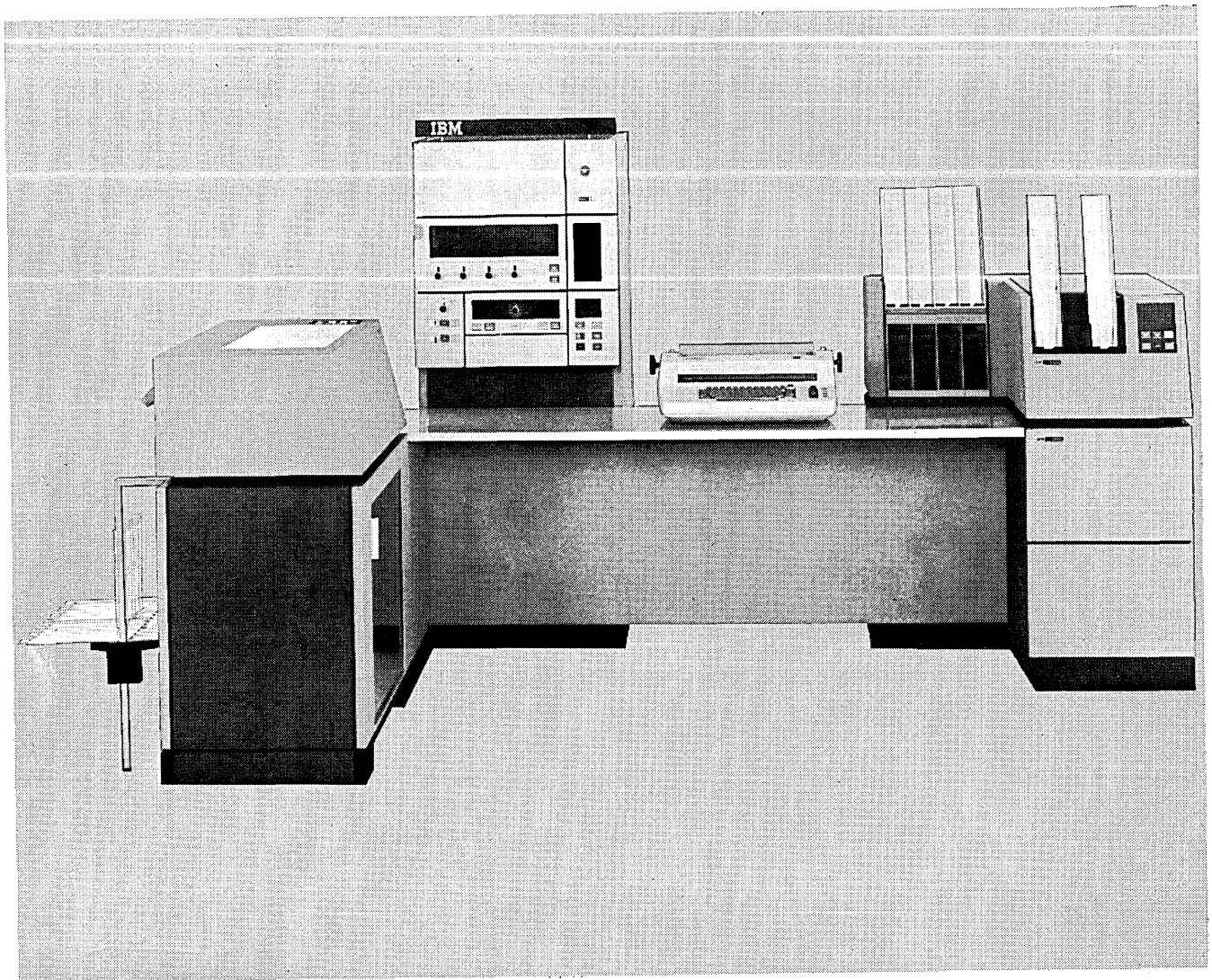

55239A

## INTRODUCTION

This manual tells you how to operate the IBM System/3 Model 10 Disk System and provides instructions for running the system programs. Some of the things you must be able to do are:

- Load paper forms in the printer.
- Clear cards from the multi-function card unit (MFCU).
- Clear cards from the 1442 Card Read Punch.
- Mount and remove disk cartridges and tape reels.
- Operate the system.
- Perform error recovery procedures for halts.

Figure 1 summarizes typical responsibilities of a system operator. This figure also shows the source of the items you need to do the job.

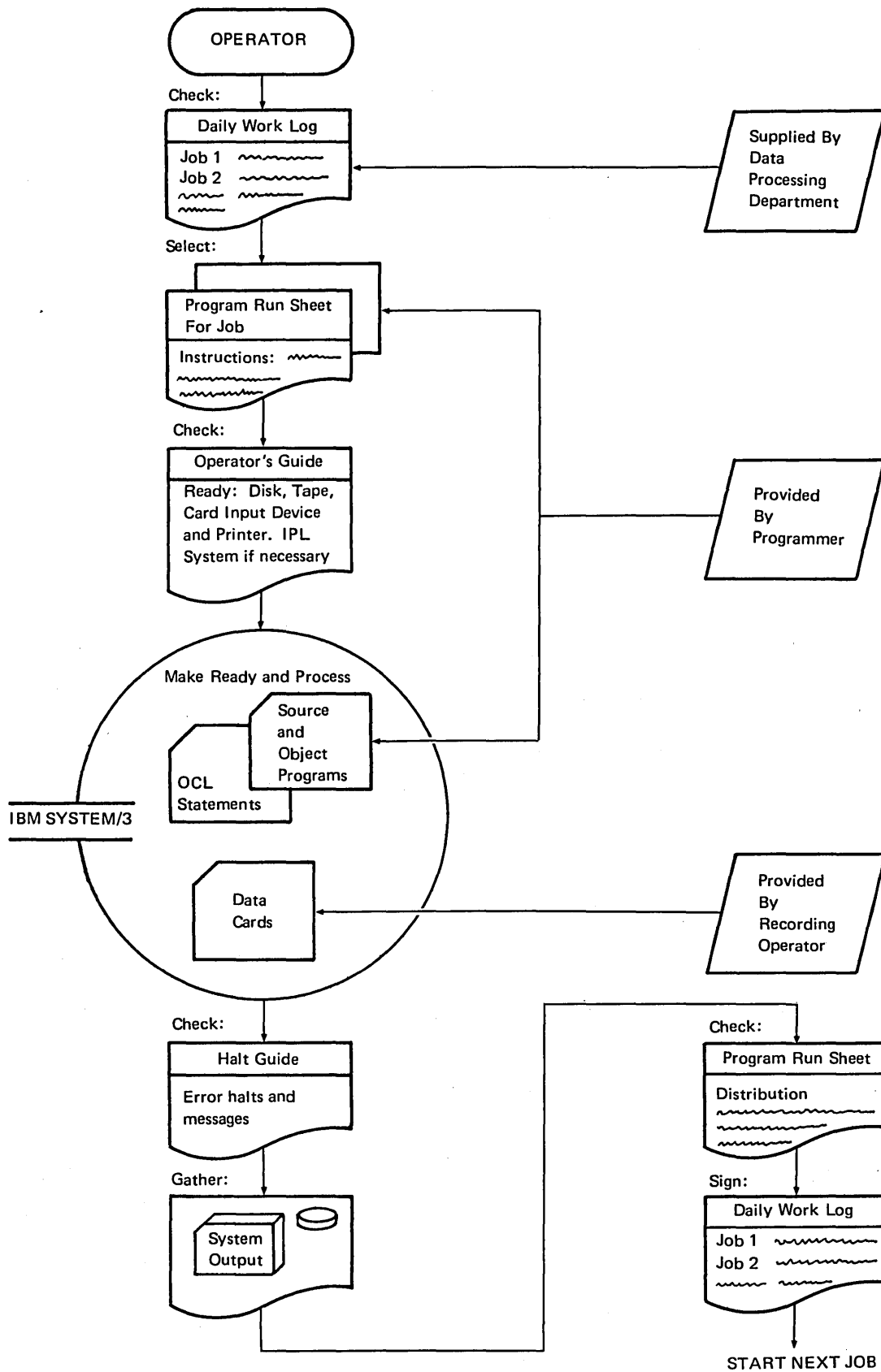

Figure 1. System/3 Operator Responsibilities

## PROGRAM RUN SHEET

Information concerning the nature of each program and what is required of you as the operator to run that program can be supplied on the program run sheet. Figure 2 shows a program run sheet. This sheet is provided to you by the programmer.

The program run sheet indicates:

- The disk cartridge or tape reel to mount.
- The forms to use in the printer.
- The input device to use.
- The Operation Control Language (OCL) statements used (found on back of sheet).
- Any special procedures that are not normally performed but necessary with this program.
- RPG II programmed halts to be used.

**IBM SYSTEM/3 DISK SYSTEM  
PROGRAM RUN SHEET**

Program Name \_\_\_\_\_ Program Number \_\_\_\_\_

Programmer \_\_\_\_\_ Date \_\_\_\_\_ Application \_\_\_\_\_

**JOB PREPARATION**

CARD:	Hopper 1	Description and Source of Card Files
	Hopper 2	

DISK or TAPE:	Unit 1 (R1)	Description of Disk Cartridges or Tape Reels and/or Files
	Unit 2 (R2)	
	Unit 3 (D1)	
	Unit 4 (D2)	
	Unit 5 (T1)	
	Unit 6 (T2)	
	Unit 7 (T3)	
	Unit 8 (T4)	

PRINTER:	Form Number	Description of Form
	Form Name	

**JOB COMPLETION**

CARD:	Stacker 1	Destination of Card Files
	Stacker 2	
	Stacker 3	
	Stacker 4	

DISK or TAPE:	Unit 1 (R1)	Disposition of Disk Cartridges or Tape Reels
	Unit 2 (R2)	
	Unit 3 (D1)	
	Unit 4 (D2)	
	Unit 5 (T1)	
	Unit 6 (T2)	
	Unit 7 (T3)	
	Unit 8 (T4)	

PRINTER:	Burst? _____	Distribution of Forms
	Decollate? _____	

**PROGRAMMED HALTS**

Halt Code	Halt Meaning	Action Required

**SPECIAL INSTRUCTIONS**

\_\_\_\_\_

\_\_\_\_\_

\_\_\_\_\_

\*No. of forms per pad may vary slightly

● Figure 2 (Part 1 of 2). Program Run Sheet (Front)

Program Name	Program Number
Programmer	Application
Date	

**ACL STATEMENTS**

1	7/5
2	
3	
4	
5	
6	
7	
8	
9	
10	
11	
12	
13	
14	
15	
16	
17	
18	
19	
20	
21	
22	
23	
24	
25	
26	
27	
28	
29	
30	
31	
32	
33	
34	
35	
36	
37	
38	
39	
40	
41	
42	
43	
44	
45	
46	
47	
48	
49	
50	
51	
52	
53	
54	
55	
56	
57	
58	
59	
60	
61	
62	
63	
64	
65	
66	
67	
68	
69	
70	
71	
72	
73	
74	
75	
76	
77	
78	
79	
80	
81	
82	
83	
84	
85	
86	
87	
88	
89	
90	
91	
92	
93	
94	
95	
96	

● Figure 2 (Part 2 of 2). Program Run Sheet (Back)

## Chapter 2. IBM 5410 Processing Unit Controls and Indicators

- System Controls and Indicators
- System Control Panel
- Emergency Power Off and Meter Panel
- Processing Unit Display Panel
- Customer Engineer Control Panel
- Disk Panel
- Dual Program Control Panel
- Binary Synchronous Communications Adapter Panel

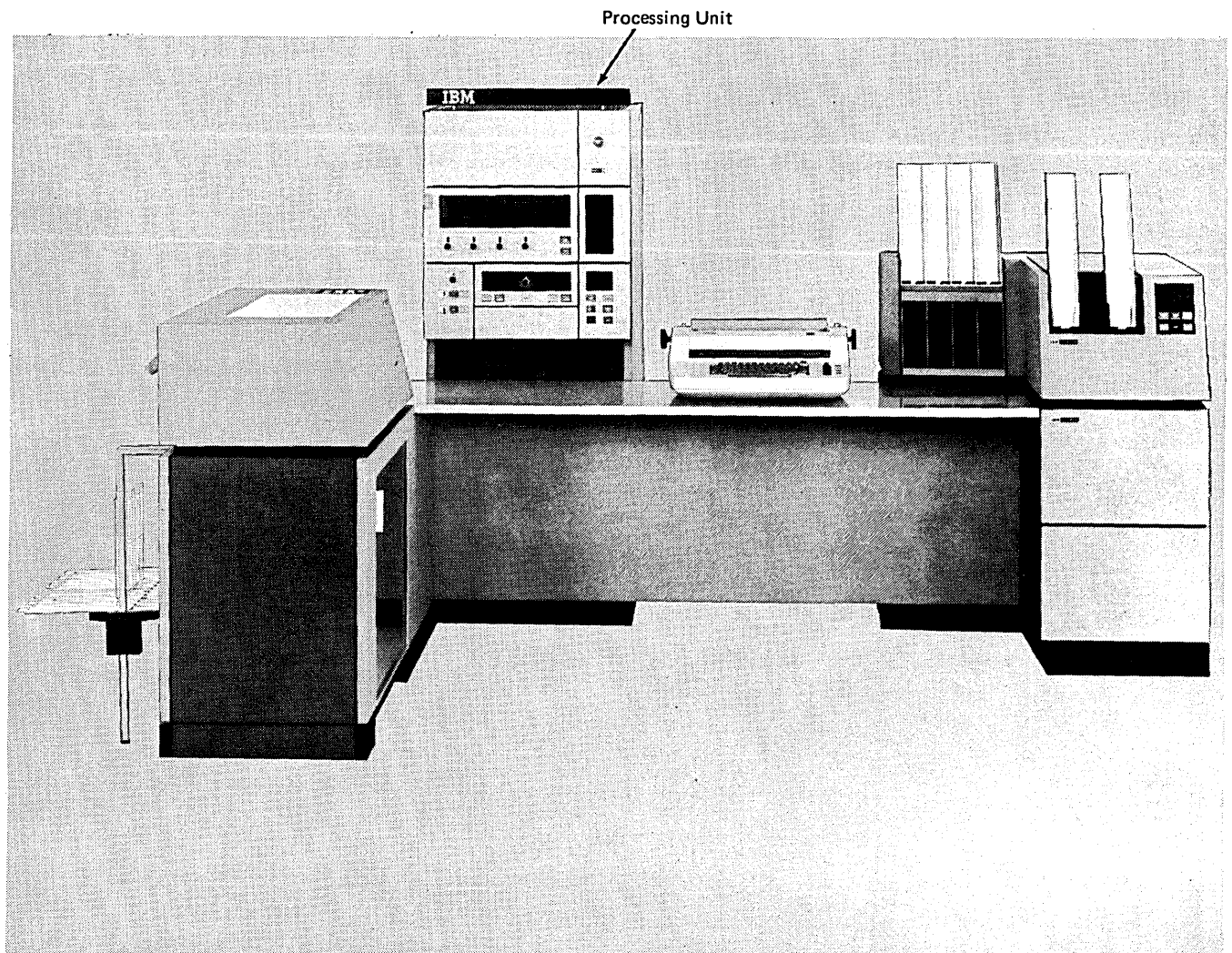

55239A

## SYSTEM CONTROLS AND INDICATORS

Each System/3 processing unit has lights, keys, and switches that are used for communication between you and the system. Lights indicate conditions existing in a device or in the system. Keys and switches are used to control operation of the system. Functions of the lights, keys, and switches on the processing unit are discussed in this chapter.

Controls and indicators for the processing unit are located on a large panel called the console (Figure 3). Although this panel is divided into several smaller panels, you will be concerned primarily with the system control panel, disk panel, and the dual program control panel if you have this feature. The processing unit displays and Customer Engineer controls are used primarily by the Customer Engineer when he services the system.

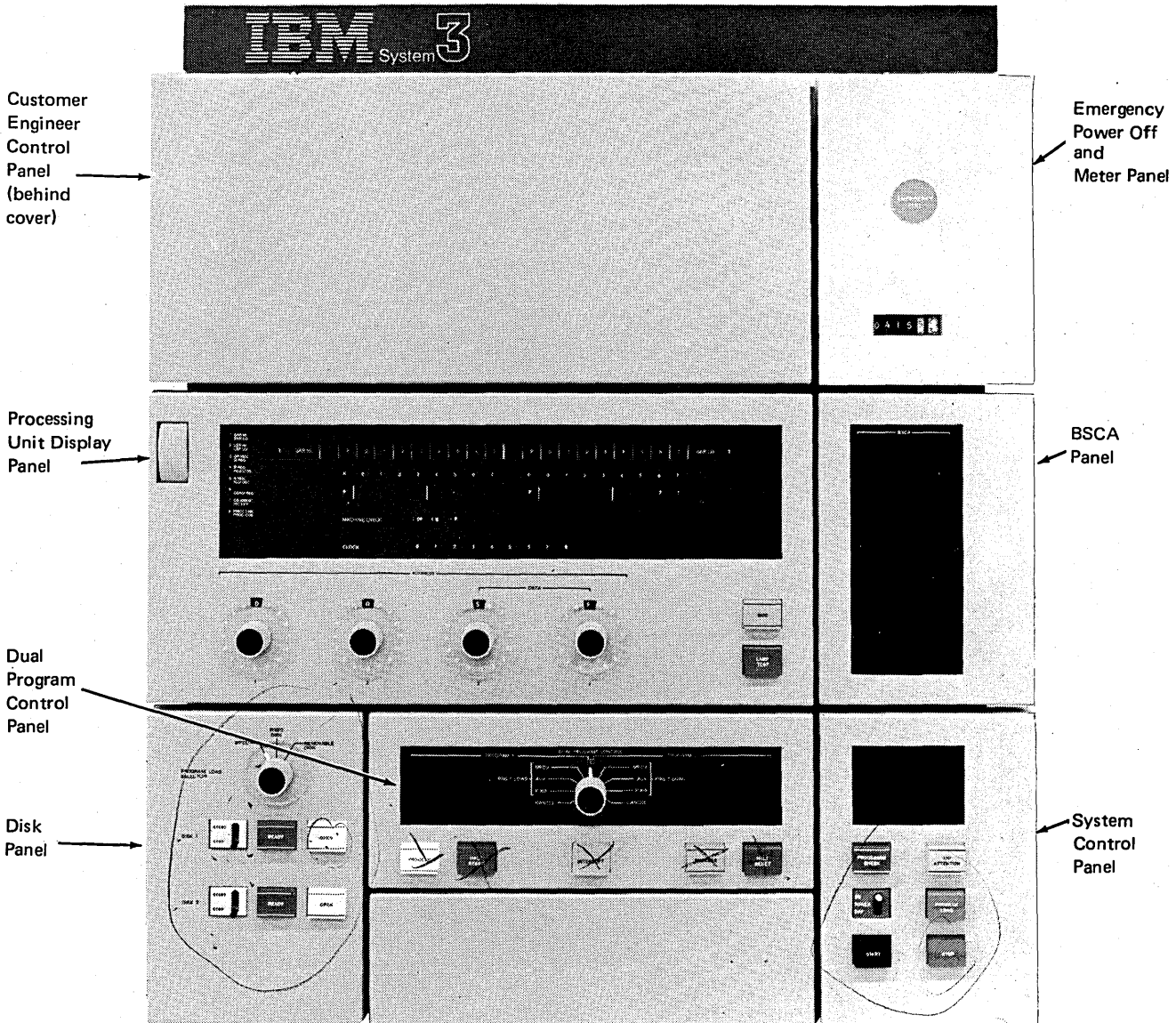

Figure 3. System Console Controls

53298A



## System Control Panel

The controls and indicators on the system control panel (Figure 4), along with those on the MFCU and the printer panels, are the means by which you operate the system.

**Message Display Unit:** This two-position display unit, at the top of the system control panel, displays characters whenever a programmed halt occurs. Characters that can be displayed are: A, C, E, F, H, J, L, P, U, Y, quote ('), dash (-), blank, and 0 through 9.

The display unit is not used if you have the Dual Programming Feature (DPF). The message display units on the DPF panel have the same function.

The *IBM System/3 Model 10 Disk System Halt Guide*, GC21-7540, lists all System/3 Disk System program halts.

**PROCESSOR CHECK Light:** This light comes on when an error occurs in the processing unit. The error is displayed on the processing unit display panel. All processor checks are reset and PROCESSOR CHECK turns off when you perform the initial program load (IPL) process.

**I/O ATTENTION Light:** This light comes on when the program requests any input/output device to do something and that device is not ready to do it. Some causes are:

1. Printer is out of forms.
2. MFCU or 1442 hopper is empty; stacker or chip box is full.
3. Disk is not up to speed.
4. Tape is not ready.

Additional indicators on the device guide you to the exact cause of a not-ready condition. I/O ATTENTION goes off when the condition is corrected. Instructions for clearing I/O ATTENTION are included in *Chapter 10. System Operation*.

**POWER ON/OFF Switch:** This switch controls power to all units on the system. It is effective when (1) the emergency pull switch is in its normal position, (2) the TH CHK (thermal check) indicator is not lit, and (3) the PWR CHK (power check) indicator is not lit. The thermal and power check indicators are located on the processing unit display panel.

When this switch is turned on, a system reset is performed in such a manner that no I/O operations are performed until explicitly directed. The integrity of data in storage is not guaranteed after this switch is operated.

**PROGRAM LOAD Key:** This key is used when you perform the initial program load process. This key is pressed after you have selected the device from which you will perform IPL (either the fixed or removable disk on drive 1, or the MFCU). When you press this key, the IPL program begins and the programs necessary to run your jobs are loaded into storage.

**START Key:** When you press START, it allows the system to continue normal operation. Use START only after (1) a programmed halt (non-DPF system) or (2) after you have pressed console STOP. Do not press START at any other time. If your system has DPF, use the appropriate HALT/RESET key rather than START to restart a program following a programmed halt.

**STOP Key/Light:** When you press STOP, it causes the system to stop after completing the current operation. The STOP light is lit as soon as processing stops. You restart the system by pressing START.

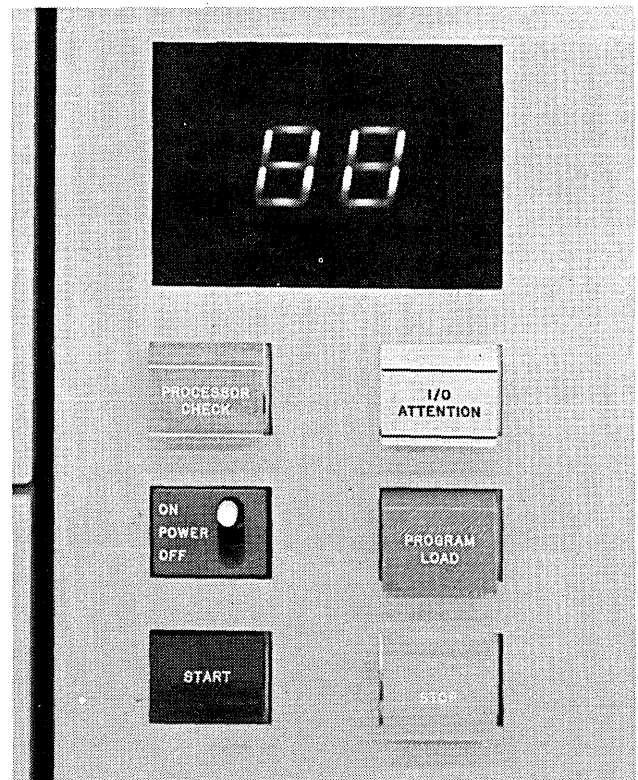

Figure 4. System Control Panel

55023

## Emergency Power Off and Meter Panel

**EMERGENCY PULL Switch:** This switch, as its name implies, should be used only under unusual circumstances. Once the emergency pull switch is pulled, system power cannot be turned on until the Customer Engineer has reset the switch. Information in storage may be destroyed when the emergency pull is used. Data on disks can also be destroyed by this operation.

**Usage Meter:** This meter records the time used to process programs and data. The meter records all the time that the processing unit is in operation from the time the console START (HALT/RESET if you have DPF), or PROGRAM LOAD is pressed, until the job is complete.

The emergency power off and meter panel is illustrated in Figure 5.

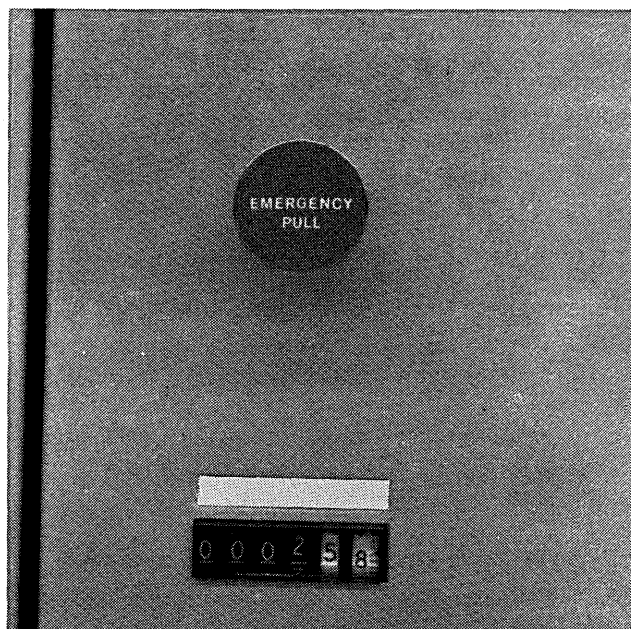

Figure 5. Emergency Power Off and Meter Panel

55024

## Processing Unit Display Panel

The lights on this panel (Figure 6) indicate system status and are mainly for Customer Engineer (CE) use.

**ADDRESS/DATA Switches:** These switches are used to indicate an address or data. Switch settings can be tested by the program in operation, can be entered into storage, or can cause a storage location to be displayed by the register display unit.

**LAMP TEST Key:** When you press this key, all indicator lights on all units on the system are lit.

**Register Display Unit:** This display unit consists of a row of 20 lights and an eight-position rotary switch. The lights display processing unit status and contents of main registers (intermediate storage areas). Any of eight different areas can be selected for display.

**Cycle Control Display:** The 12 indicator lights labeled MACHINE CYCLE and the 10 indicator lights labeled CLOCK identify the processing cycle just completed.

**INT LEV Light:** This lamp is lit when an interrupt level is being serviced. Some system devices, such as the printer-keyboard, operate on interrupt levels.

**TH CHK Light:** The thermal check light is lit whenever the temperature of the processing unit or printer electronics exceed the limit set for normal operation. The thermal check light is also lit by a loss of external power to the system. In both cases, power in the system shuts off and the TH CHK and PWR CHK (power check) lights are lit. For recovery procedures, see *Restoring System Power* in chapter 10.

**PWR CHK Light:** The power check light is lit by:

1. Loss of voltage or overvoltage condition in the processing unit. (The TH CHK light is not lit.)
2. Thermal condition in the processing unit or printer electronics. (The TH CHK light is lit.)
3. Loss of external power to the system. (The TH CHK light is lit.)

In all three cases power in the system shuts off. For recovery procedures, see *Restoring System Power* in chapter 10.

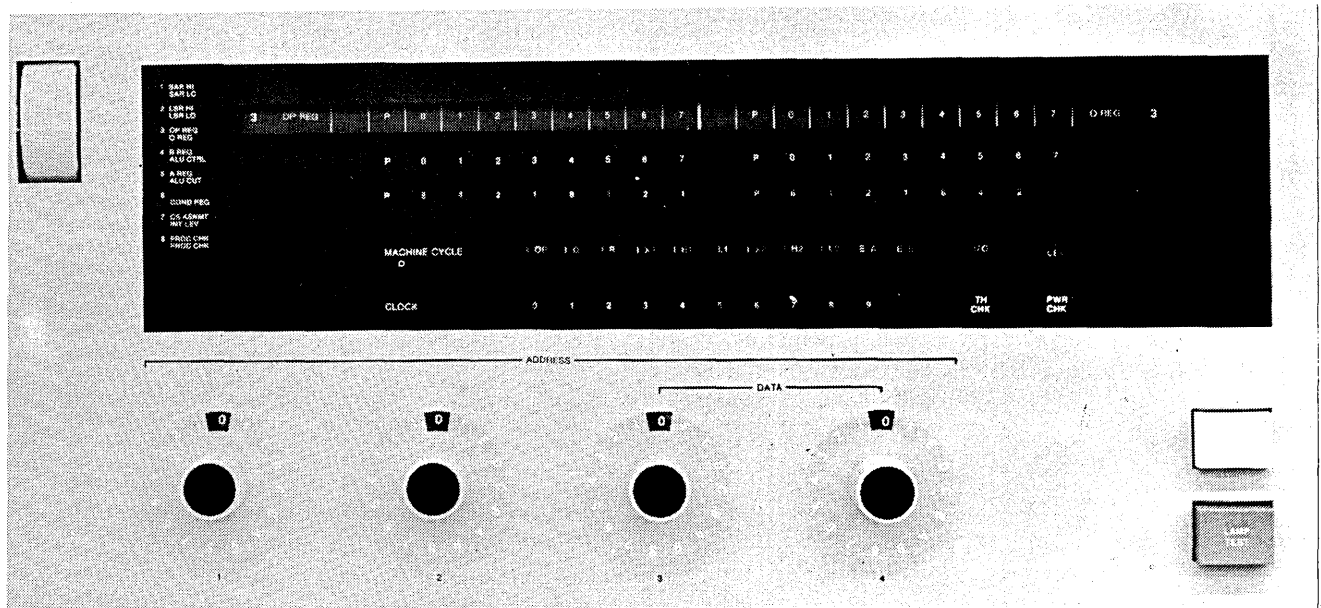

Figure 6. Processing Unit Display Panel

55025

## Customer Engineer Control Panel

The switches, lights, and dials on this panel (Figure 7) are used primarily by the Customer Engineer to service the system.

**I/O CHECK Switch:** When this switch is set at STOP, the processing unit comes to an immediate stop if an input or output error occurs. The system displays show the status of the system at the time the error occurred. The I/O check, however, is normally set at RUN. This means the system will not stop if an input or output error occurs unless instructed to do so by the program in operation. In this case, the system displays do not reflect conditions at the time the error occurred.

**PARITY CHECK Switch:** This switch is normally set at STOP. It causes the processing unit to stop when a parity error is detected and the error is displayed. When the switch is set at RUN, parity errors are detected and displayed in the register display unit (8 PROC CHK), but the system is not stopped.

**STORAGE TEST Switch:** This switch allows the CE to alter or display storage.

**ADDR INCREM Switch:** This switch is used by the CE to control a counter that increments the storage address register. This switch is effective only when the system is in the CE test modes of alter or display storage.

**ADDR COMPARE Switch:** This switch enables the CE to stop the program when the contents of the storage address register (SAR) matches the setting of the address/data switches. The ADDRESS COMPARE light also turns on when these addresses match. The CE mode selector switch must be set at PROCESS and the register display unit must be set at 1 SAR HI for the ADDR COMPARE switch to be effective.

**P1 and P2 Switches:** These two switches enable the CE to control selection of program 1 or program 2 for use in the dedicated mode (only one program can run in the system). These two switches are on for normal operation of the DPF system. These switches should never be changed unless the system is stopped. A processor check will occur if these switches are changed while the system is running.

**I/O OVERLAP Switch:** This switch enables the CE to control system input/output operations. When in the normal ON position, input and output operations are executed at the same time the processing unit is doing other operations. When this switch is at OFF, each input/output operation must be completed before any other processing occurs.

**ADDRESS COMPARE Light:** This light turns on when an address compare occurs (see ADDR COMPARE Switch)

**I/O CHECK Light:** This light turns on when certain errors occur in an input or output device. It is turned off when the SYSTEM RESET key or CHECK RESET key is pressed, or the input/output device error condition is corrected.

**CE KEY Switch:** This switch is operated by the customer engineer to prevent recording time on the customer usage meter. It allows the CE meter to run when the system is being serviced.

**SYSTEM RESET Key:** When the SYSTEM RESET key is pressed, the system enters an idle state. All input/output and machine registers, controls, and indicators are reset. A program must be reloaded after a system reset. The CE mode selector switch must be set at PROCESS for the SYSTEM RESET key to be effective.

**CHECK RESET Key:** When this key is pressed, all current error conditions in the processing unit and input/output devices are cleared. The system resumes normal operation when console START (HALT/RESET if you have DPF) is pressed. The CHECK RESET key is also used to reset a power check.

**BSCA STEP Key:** This key is used for BSCA testing. The key is effective only when BSCA is in the test mode and step mode.

**FILE WRITE Switch:** When this switch is at OFF, write operations cannot be performed on the disk.

**BSCA LOCAL TEST Switch:** This switch is used for testing BSCA on systems that have high speed data sets. For normal operation, the switch is in the OFF position. The switch is present only if you have high speed data sets.

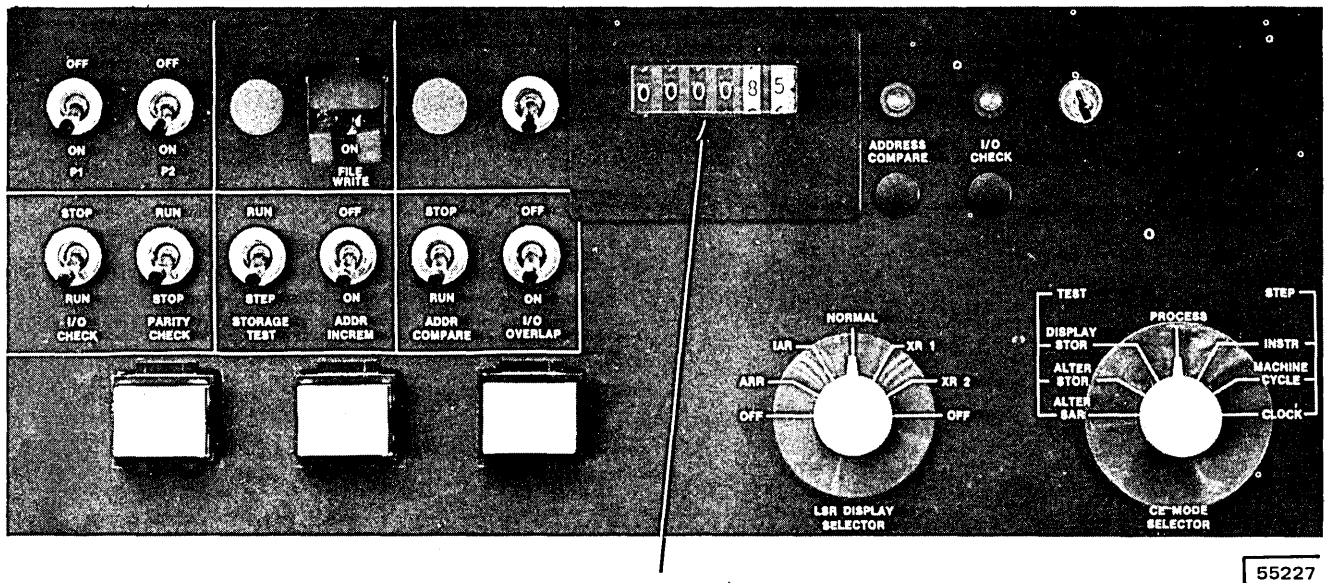

(CE Use Meter)

55227

Figure 7. Customer Engineer Control Panel

**LSR DISPLAY SELECTOR:** This rotary switch selects the area of internal storage to be displayed by the register display unit.

**CE MODE SELECTOR:** This rotary switch selects one of the three processing modes: process, step, or test. Process is the mode for normal system operation. In step mode, one of three settings can be used to control the way in which the program is executed. The test mode settings are used by the CE to display or alter storage.

**Disk Panel**

The disk panel (Figure 8) consists of a rotary switch (to indicate the initial program load device) and controls and indicators that control the disk and indicate the status of the disk.

**PROGRAM LOAD SELECTOR Switch:** This rotary switch is used to select the unit from which you initiate IPL. The **FIXED DISK** and **REMOVABLE DISK** positions refer to drive 1 only (top drawer). You cannot IPL from the 1442 Card Read Punch.

**START/STOP Switches:** These switches (one for each drive) turn the disk drive power on or off when system power is on. With the switch at **OFF** and the **OPEN** light on, the drawer can be opened and the removable disk can be replaced.

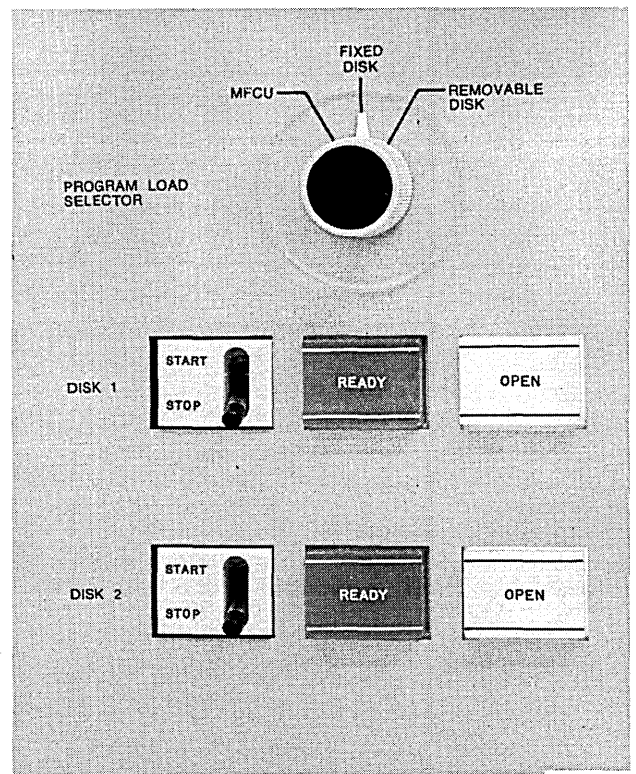

Figure 8. Disk Panel

55226

**READY Lights:** These lights (one for each drive) are on when the disk drive is ready for use. If you try to use the drive before this light is on, I/O ATTENTION on the console turns on.

**OPEN Lights:** These lights (one for each disk drive) indicate that the associated disk drive drawer can be opened for changing the removable disk. This light is on when the START/STOP switch is placed at STOP and the disk has come to a stop.

### Dual Program Control Panel

Your system can have the Dual Programming Feature (DPF). This feature enables the system to have two programs in storage at the same time. The dual program control panel (Figure 9) contains switches, lights, and keys used to initiate and control the running of two completely different programs.

**Message Display Unit (Program 1 and 2):** Whenever a programmed halt occurs, a combination of the letters in the appropriate DPF message display unit is displayed: A, C, E, F, H, J, L, P, U, or Y, quote ('), dash (-), blank, and 0 through 9. The displayed characters are used to identify the halt. In the dual programming mode, both display units can be lit at the same time. The PROCESS light determines which program is in control. The HALT/RESET key is used to take a program out of its programmed halt.

**PROCESS Lights (Program 1 and 2):** These lights indicate which program level (program 1 or 2) is currently being used. When the PROCESS light for program 1 is on, program level 1 is being used. When the PROCESS light for program 2 is on, program level 2 is being used.

**HALT/RESET Keys (Program 1 and 2):** HALT/RESET is used to take a program (1 or 2) out of its programmed halt. When the correct HALT/RESET key is pressed, (PROCESS light is lit) the message display unit for that program is cleared and the program continues normal operation.

**DUAL PROGRAM CONTROL Switch:** This switch is only used in conjunction with the INTERRUPT key. When you press the INTERRUPT key, the system expects the input for the job to be supplied from one of three possible devices selected by you: MFCU, auxiliary device (AUX), or printer-keyboard (P-KB). The MFCU position on the panel refers to the primary hopper of the MFCU as the input device. The input device related to the AUX and P-KB positions on the panel are selected when system generation is performed. If you are using the 1442 as the only input device, you must assign the 1442 as an auxiliary device (AUX). For information on which devices can be selected for the AUX and P-KB positions, see *Chapter 12. System Generation*. The CANCEL position allows you to cancel the job for the program (1 or 2) selected. See *Chapter 10. System Operation* for information on cancelling jobs.

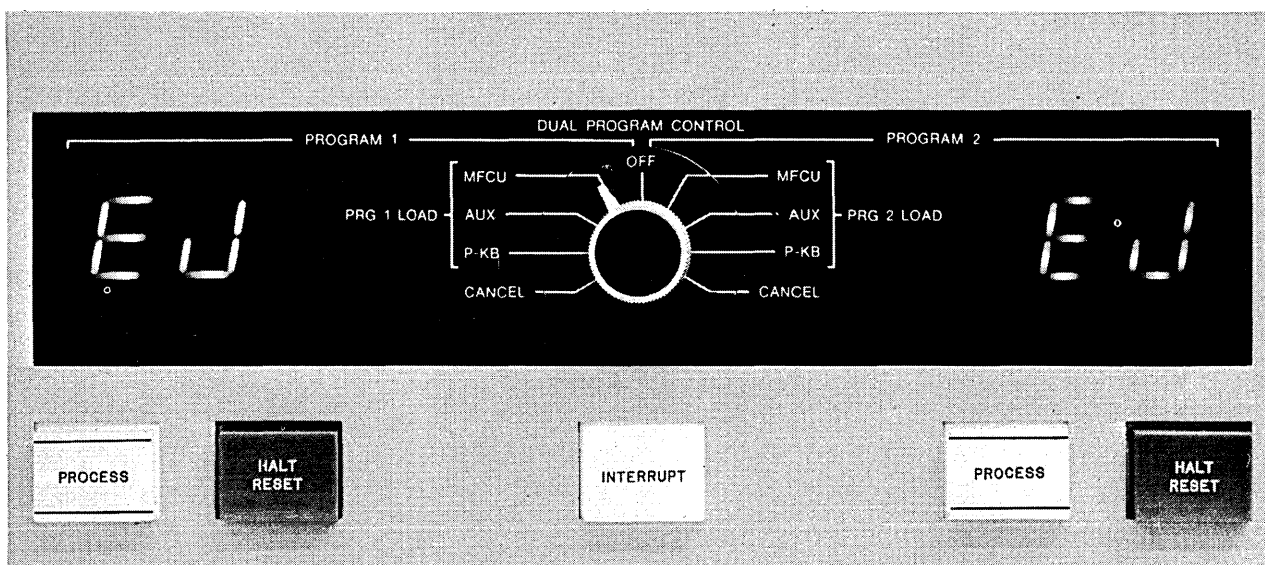

Figure 9. Dual Program Control Panel

55228



**INTERRUPT Key/Light:** INTERRUPT is pressed when you want to initiate or cancel a job. The key is effective only when the INTERRUPT light is lit. This key is used in conjunction with the DUAL PROGRAM CONTROL switch. INTERRUPT is lit when you are operating in the DPF mode.

### Binary Synchronous Communications Adapter Panel

The binary synchronous communications adapter (BSCA) panel (Figure 10) contains the lights and a switch to indicate and control the status of telecommunication processing.

#### Lights

The following text describes the lights you are concerned with when running BSCA programs:

**BSCA ATTN:** This light turns on when BSCA is addressed and one of the following conditions is present:

- A data set is not ready.
- Auto call unit power is off.
- Data line is being used.
- BSCA is disabled.
- External test switch is in the TEST position and BSCA is not in the test mode.

The I/O ATTENTION light on the console is also on whenever the BSCA ATTN light is on.

**DT TERM READY:** This light turns on when BSCA is enabled and the data terminal is ready for use.

**DT SET READY:** This light turns on when the data set ready line from the data set is on and the data set is ready for use.

**TEST MODE:** This light turns on when a program places BSCA in the test mode of operation. The light is used only when diagnostic programs are run.

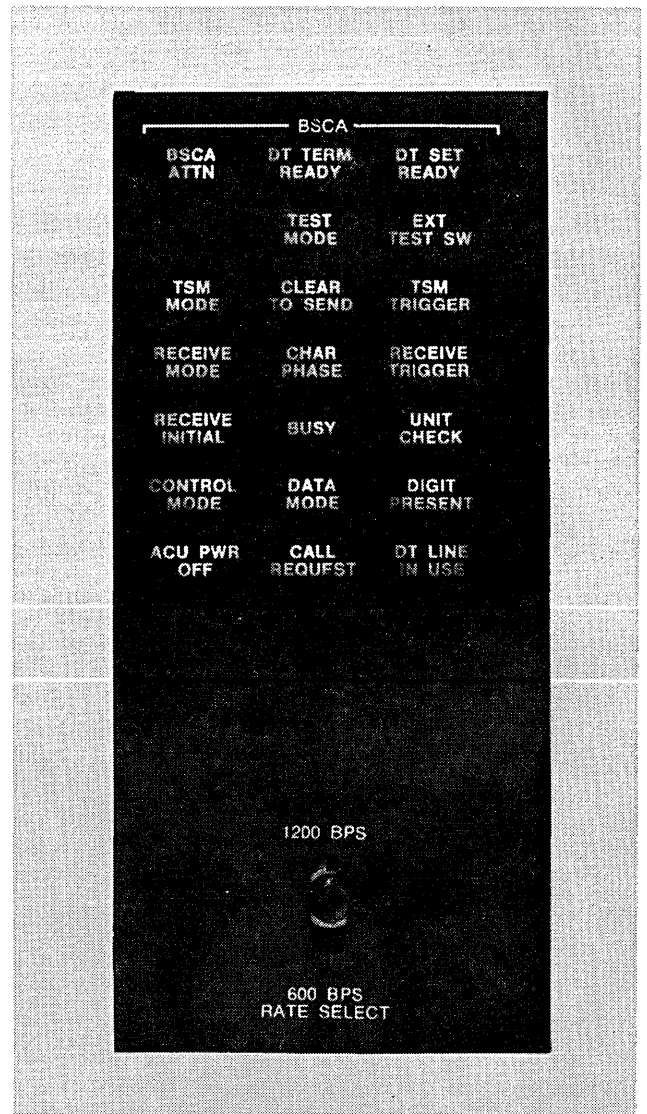

Figure 10. BSCA Panel

55027A

**EXT TEST SW:** For medium speed data sets, this light turns on when the switch on the cable is in the TEST position. For high-speed data sets, this light is on when the local test switch on the CE panel is in the on position. This light is used only when diagnostic programs are run.

**TSM MODE:** This light turns on whenever data is being transmitted.

**CLEAR TO SEND:** This light turns on to indicate that the BSCA hardware may now transmit.

**TSM TRIGGER:** This light indicates the instantaneous value of the data being transmitted.

**RECEIVE MODE:** This light turns on when a receive operation is taking place.

**CHAR PHASE:** This light turns on when BSCA has established character synchronism with the transmitting station and is receiving data. The light is turned off when character synchronism is lost or when receive operations have ended.

**RECEIVE TRIGGER:** This light indicates the instantaneous value of the data being received.

**RECEIVE INITIAL:** This light turns on at the initiation of a receive operation and turns off at the end of the initiation operation.

**BUSY:** This light turns on when BSCA is executing a receive initial, transmit and receive, autocall, or receive only operation.

**UNIT CHECK:** This light turns on when the BSCA program should enter an error recovery procedure.

**CONTROL MODE:** This light is used only on systems that have multipoint nonswitched network feature installed. The light is turned on when the control station finishes data transfer with a remote terminal. It is turned off when the control station initiates data transfer with a different remote terminal.

**DATA MODE:** This light turns on during a transmit or receive operation when data is being checked for errors. It is turned off at the end of the transmit or receive operation.

**DIGIT PRESENT:** This light is used only on systems that have the autocall feature installed. This light is turned on when a digit is being dialed by the autocall unit.

**ACUPWR OFF:** This light turns on when the power for the autocall unit is off.

**CALL REQUEST:** This light turns on when an autocall operation is being performed.

**DT LINE IN USE:** This light turns on when autocall is being performed, or TALK has been pressed on the data phone while the phone is off the receiver.

#### *Switches*

**RATE SELECT:** This switch is present only on systems that have the rate select feature installed. The switch controls the rate at which data is transmitted and received. The switch must be set so the transmission rate of both terminals is identical.



## Chapter 3. IBM 5424 Multi-Function Card Unit

- MFCU Controls and Indicators
- Clearing a Card Jam
- Changing the MFCU Print Ribbon
- Emptying the MFCU Chip Box

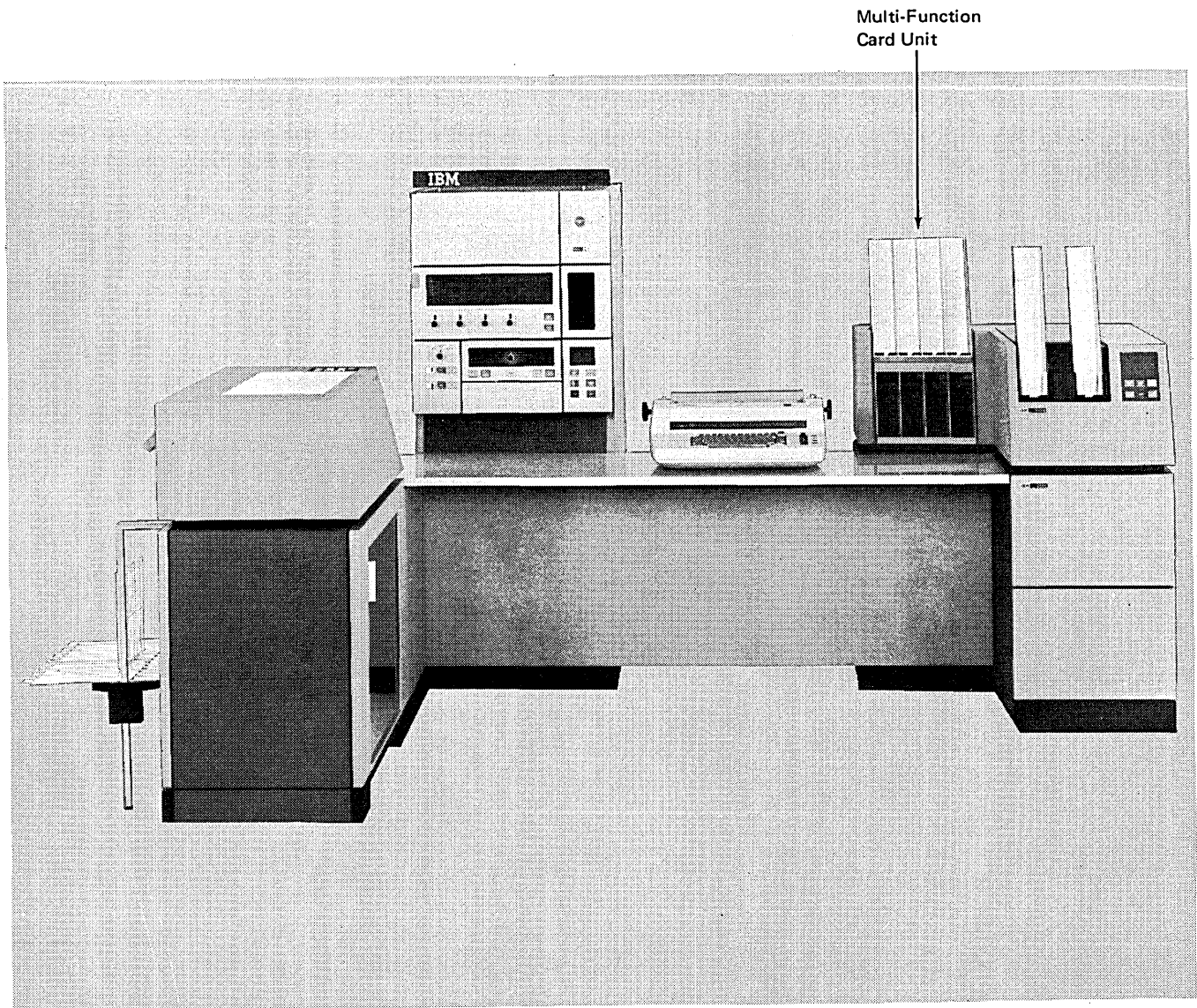

55239A

## MFCU CONTROLS AND INDICATORS

The lights and keys that you use to communicate with the MFCU are on the front of the MFCU.

### Lights

There are thirty lights on the top part of the MFCU operator's panel. Twenty of these are numbered and identify the position of cards within the MFCU when a feed check occurs (see *Clearing a Card Jam*). A description of the other lights on the MFCU panel are as follows:

**SEC:** The last card was fed from the secondary hopper.

**PRI:** The last card was fed from the primary hopper.

**RD:** There was a read check on the last card read. The SEC or PRI light indicates which hopper the card came from.

**HPR:** A card did not feed from the selected hopper. The SEC or PRI light indicates which hopper failed to feed a card.

**NPRO:** The card paths are not clear. This light also comes on when the system is turned on. To turn the light off, press the NPRO key twice after turning on the system. The hoppers must be empty for the NPRO key to be effective.

**STKR:** One of the four stackers is full. You can turn this light off by removing the cards from the stacker and pressing START or NPRO.

**CHIP:** The chip box is either full or out of the machine. To turn the light off, correct the condition and press START or NPRO.

**CVR:** The top covers are open or not securely latched. To turn the light off, close the covers and press START or NPRO.

**SECONDARY READY:** The secondary feed path is ready for operation.

**PRIMARY READY:** The primary feed path is ready for operation.

### Keys

**NPRO (Nonprocess Runout):** Press this key to clear cards from the MFCU. Make sure the card hoppers are empty. Press the key twice to clear both the primary and secondary card paths. The primary feed path is cleared first. Both feed paths empty into stacker 1.

**START:** Press this key to place the MFCU in a ready condition. One or both card feeds are readied, depending on whether cards are in the hoppers and the card paths are clear. Use of the START key does not cause cards to feed from the hoppers.

**STOP:** Press this key to indicate to the system that the MFCU should stop after it completes the current operation. The ready lights turn off.

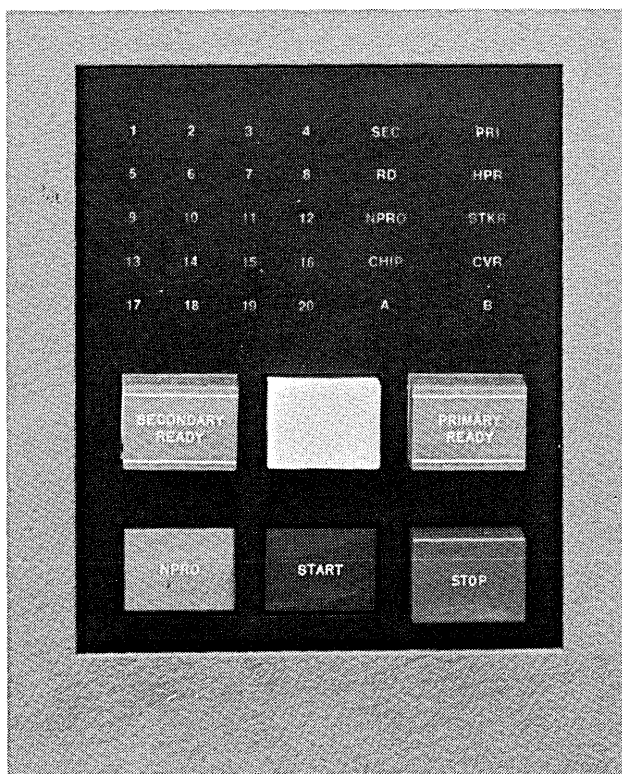

55027

### Customer Engineering Aids

If you press the LAMP TEST key on the processing unit console, you will see two additional indicators on the MFCU panel. They are labeled A and B. These lamps are CE diagnostic aids and are not lit during normal system operations.

## CLEARING A CARD JAM

The following procedure tells you how to remove cards from the MFCU card paths.

The program recovery procedure—what to do with the cards to continue program operations—are listed under the F0 and F1 halts in the *IBM System/3 Model 10 Disk System Halt Guide*, GC21-7540.

### Indications

A misfeed or card jam in the MFCU is indicated by any or all of the following:

- F0 or F1 halt in the console message display unit.
- MFCU ready lights are off.

- A number (1 to 20) is lit on the MFCU operator's panel.
- NPRO light is on.

The numbers on the MFCU operator's panel indicate where in the card paths the trouble occurred. When a misfeed or jam occurs, write the number down in your console log book. If the same number occurs repeatedly, the MFCU needs service.

When the card paths are cleared, press NPRO twice to turn off the error indicator on the MFCU operator's panel.

### Removing Cards From the Card Feed Paths

The MFCU card paths are shown in Figure 11. The numbers refer to the photographs that show how to remove a card from a particular place in the card path.

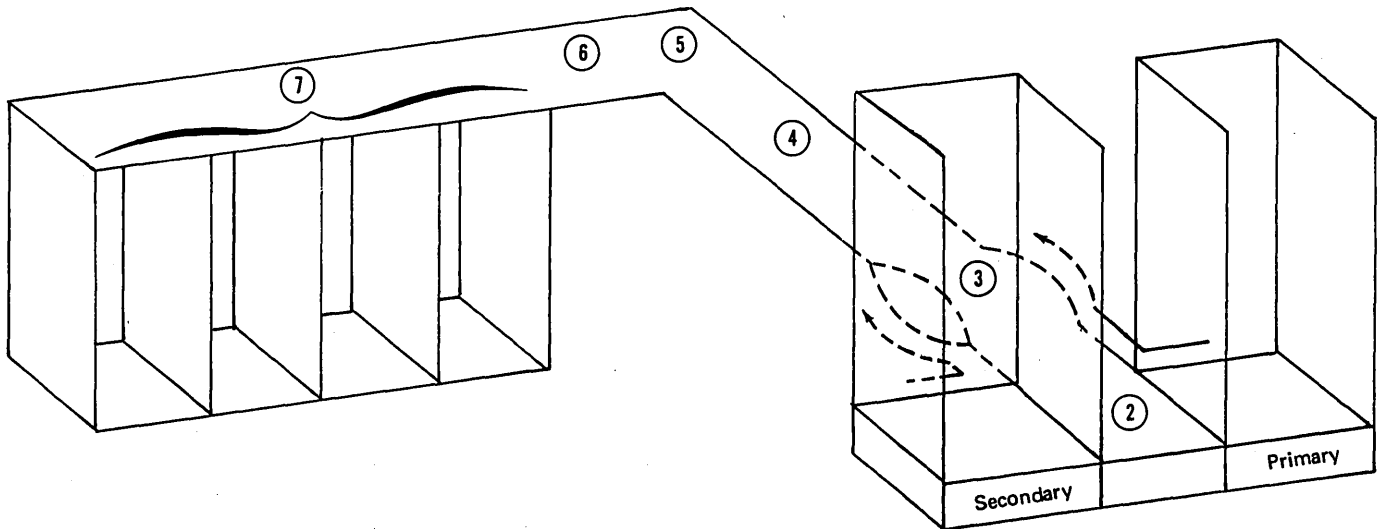
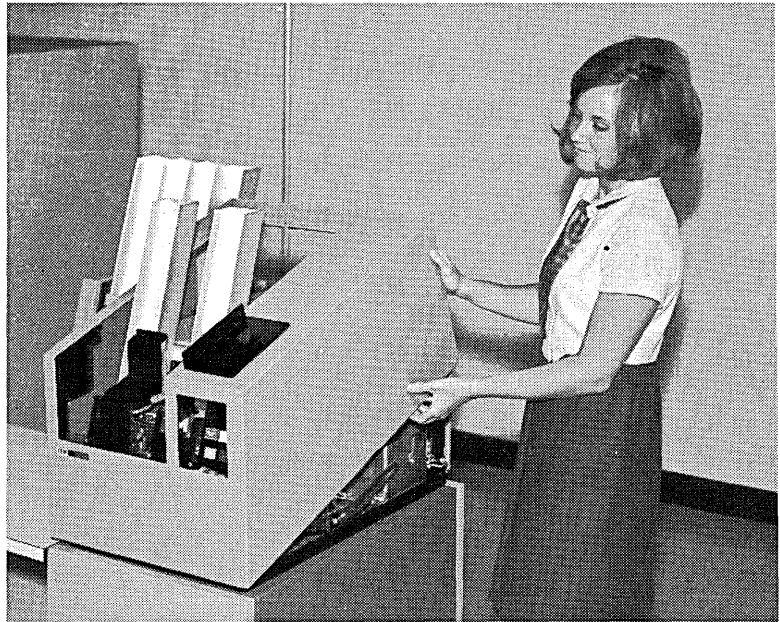

Figure 11. MFCU Card Paths

- ① To open the MFCU top covers, lift latch to release cover. Pivot outer and inner top covers towards front of machine.



ART: 55028

- ② To remove a card from the hopper station, press down on latch and raise cover. Close cover when station is cleared.

If a card will not come out, free it by turning the feed drive wheel (see item ④).

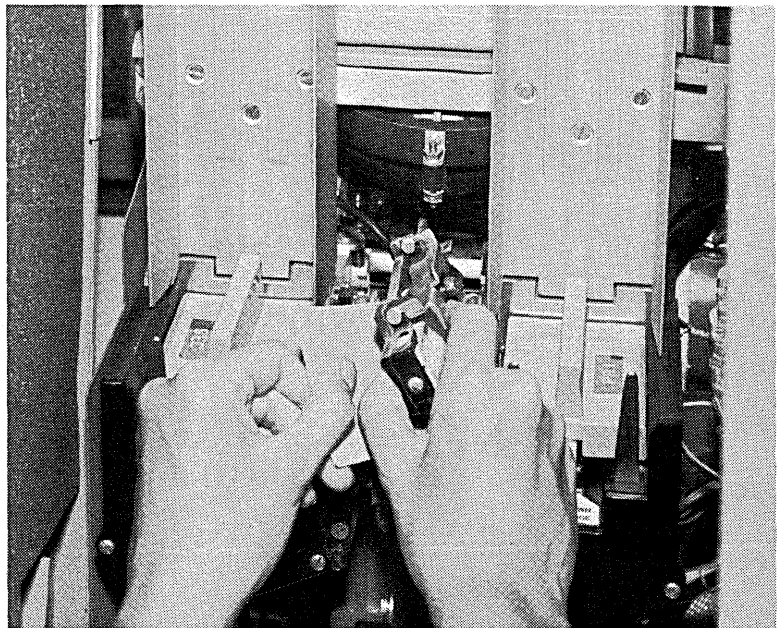

ART: 55029

3

To remove a card from a wait station, open spring-loaded cover and remove card.

Primary Wait

Secondary Wait

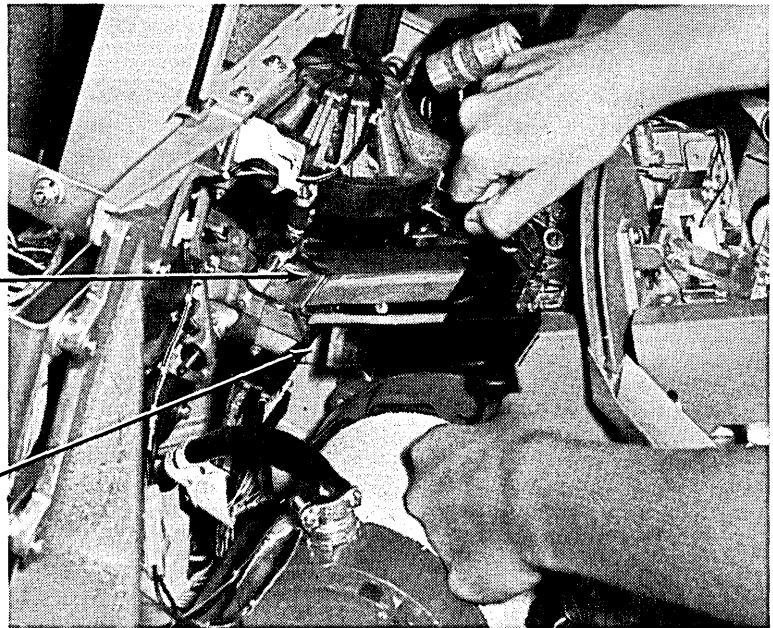

ART: 55030

4

To remove a card from the punch unit, turn feed drive wheel clockwise to advance card.

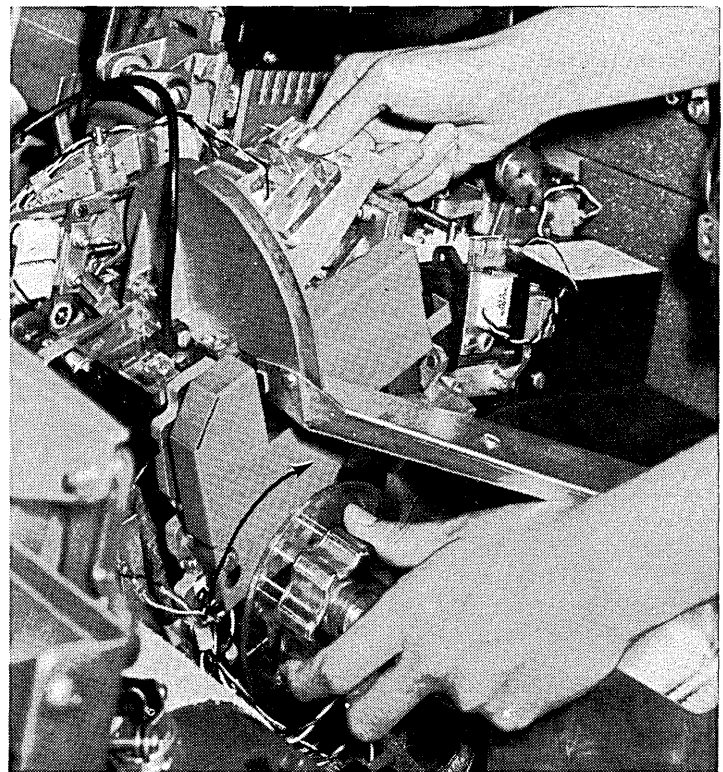

ART: 55031



- 5** To remove a card from the corner station, pull back on latch to open cover. Close cover when station is cleared.

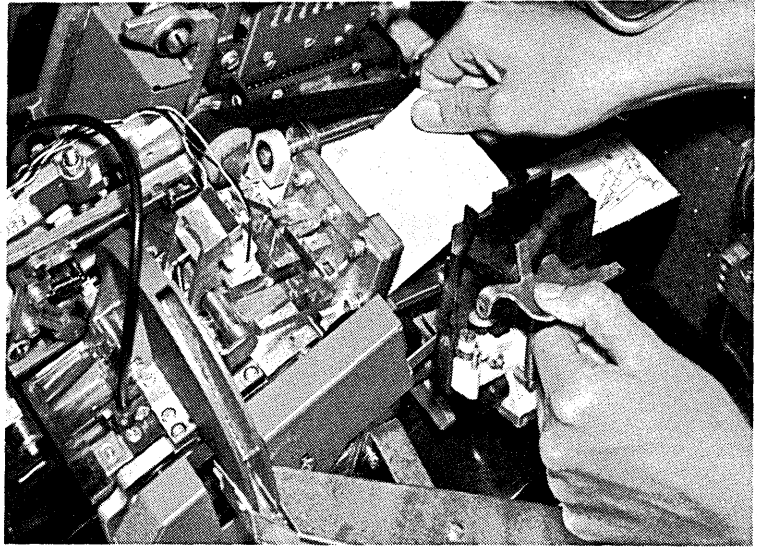

ART: 55032

- 6** To remove a card from the print unit, turn shaft counter-clockwise to unlock print unit. Tip unit towards front of MFCU. Lock print unit when station is cleared.

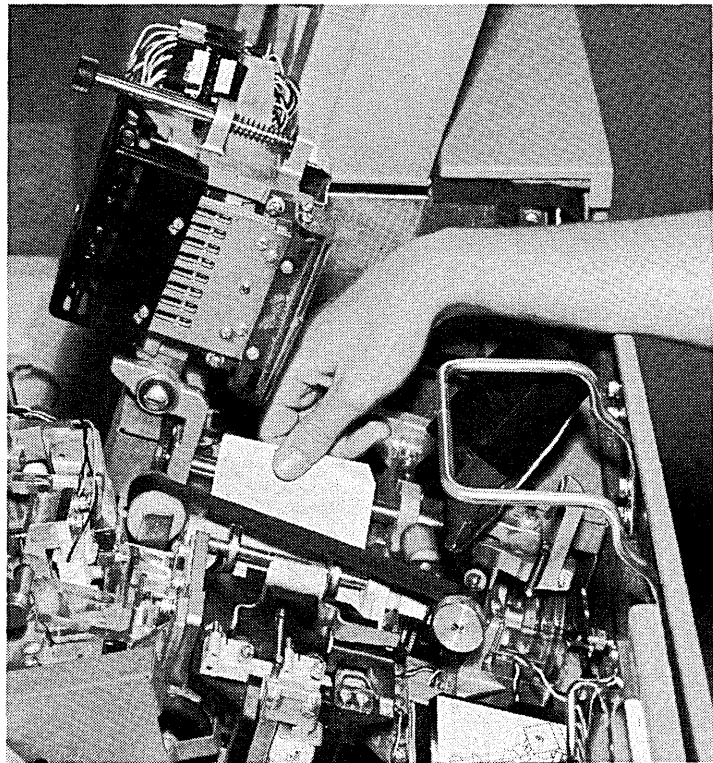

ART: 55033

7

To clear a stacker jam, raise spring-loaded cover over stackers and remove jammed cards.

If card will not come out, open top covers and free it by turning the feed wheel drive (see preceding item 4).

Never remove cards from the stackers while the MFCU is running.

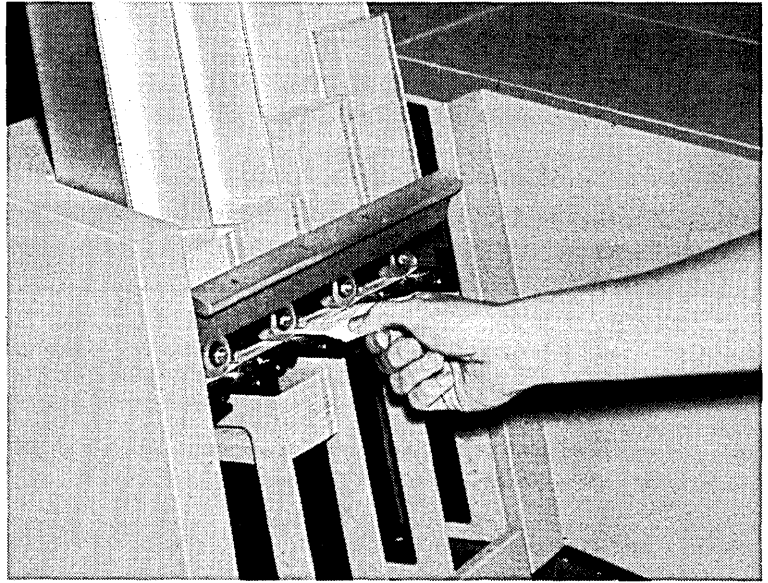

ART: 55034

## CHANGING THE MFCU PRINT RIBBON

### Removal

- 1 Open MFCU top covers. Lift latch to release cover. Pivot outer and inner top covers towards front of machine.

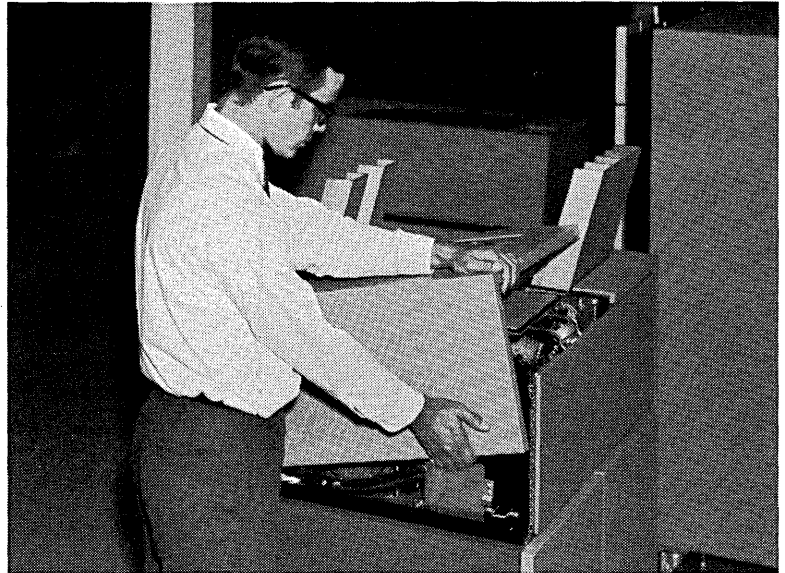

ART: 55042

- 2 Raise print unit. Turn shaft counterclockwise to unlock. Tip unit towards front of MFCU.

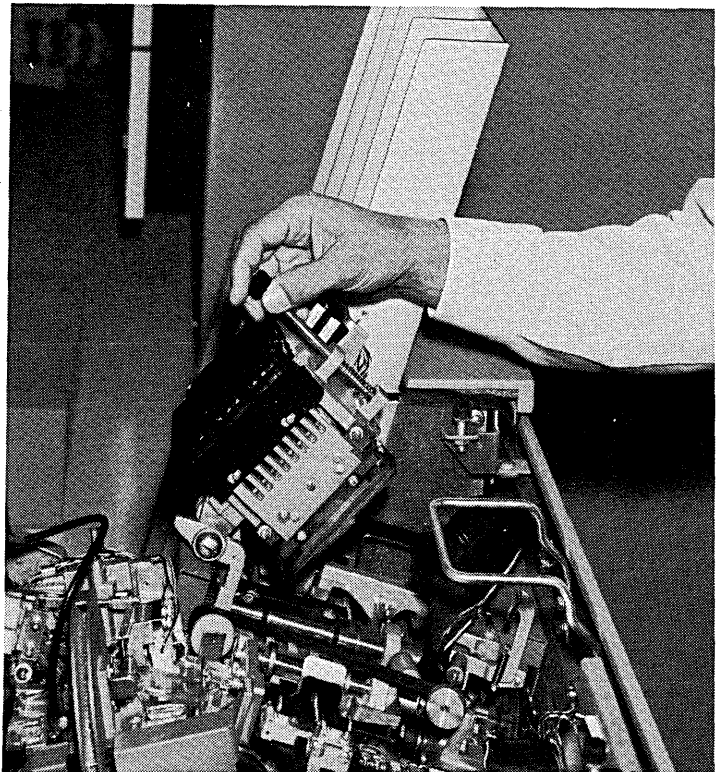

ART: 55035



- 3 Slide ribbon out of ribbon drive. Pull ribbon back towards ribbon drive to get slack.

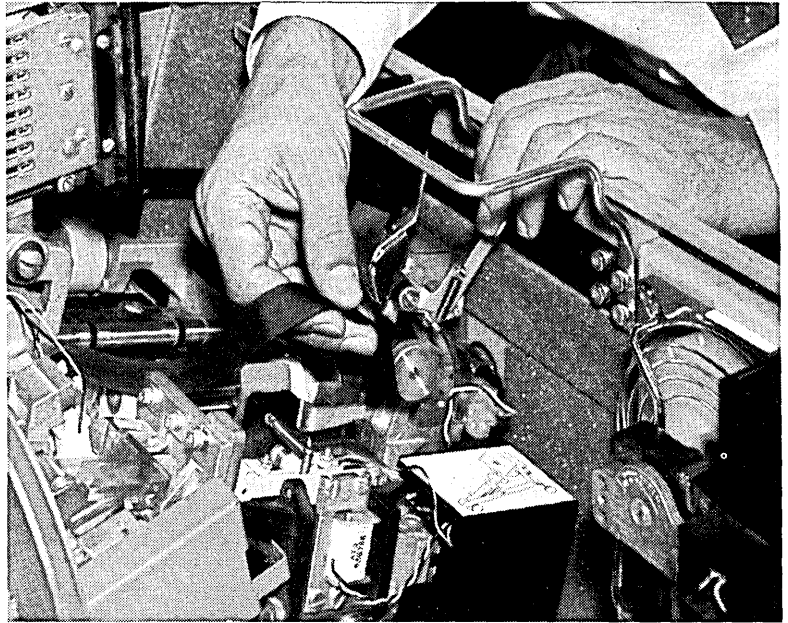

ART: 55036

- 4 Squeeze split shaft holding ribbon cartridge and pull cartridge off shaft.

Split Shaft

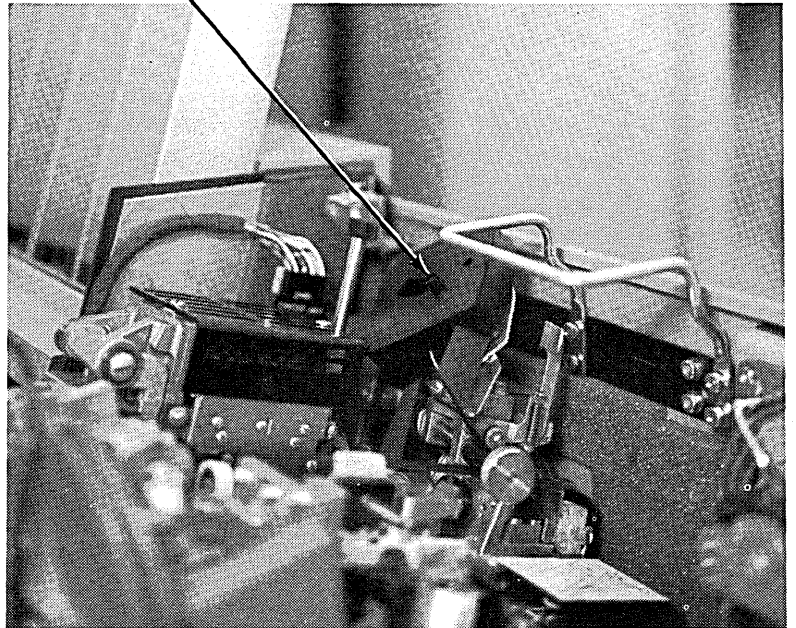

ART: 55037

**5**

Slip ribbon out from under guide plate and front and rear rollers and remove ribbon cartridge from machine.

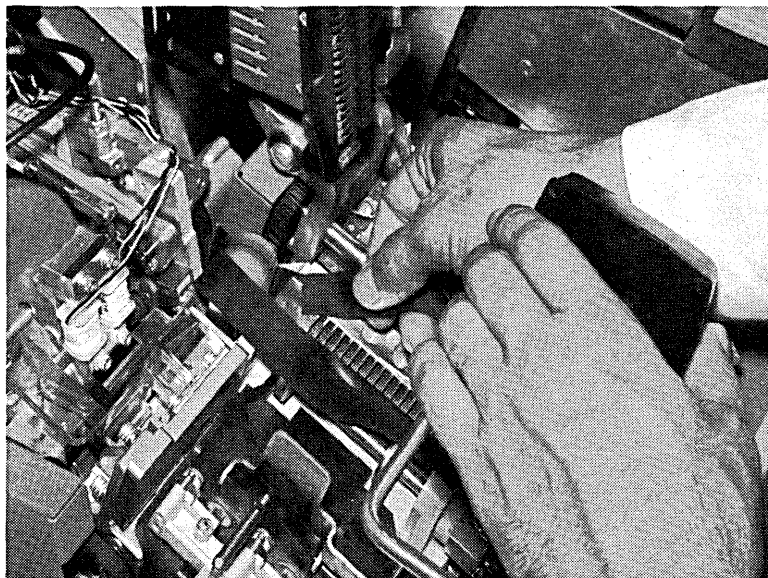

ART: 55038

## Installation

- 1 Snap new ribbon cartridge in place. The ribbon feeds down from the back of the cartridge.

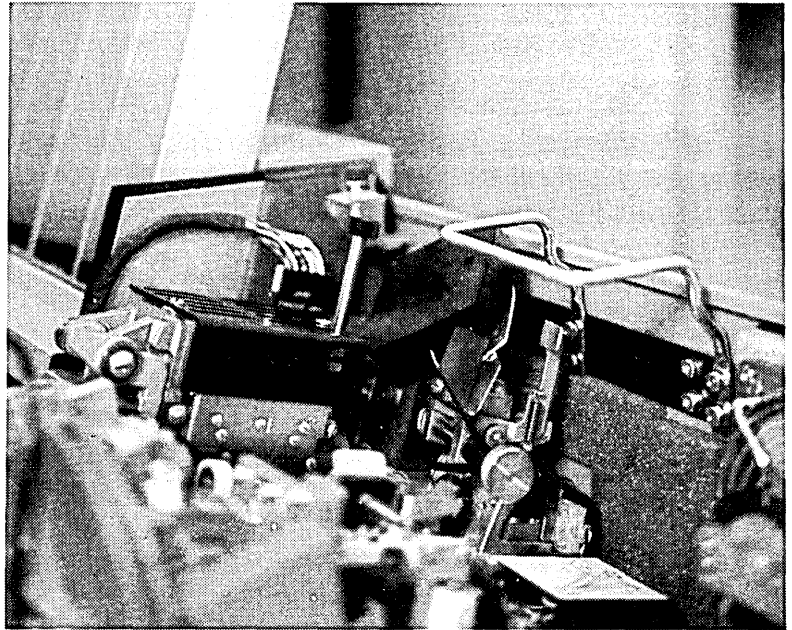

ART: 55037

- 2 Slip ribbon into ribbon drive.

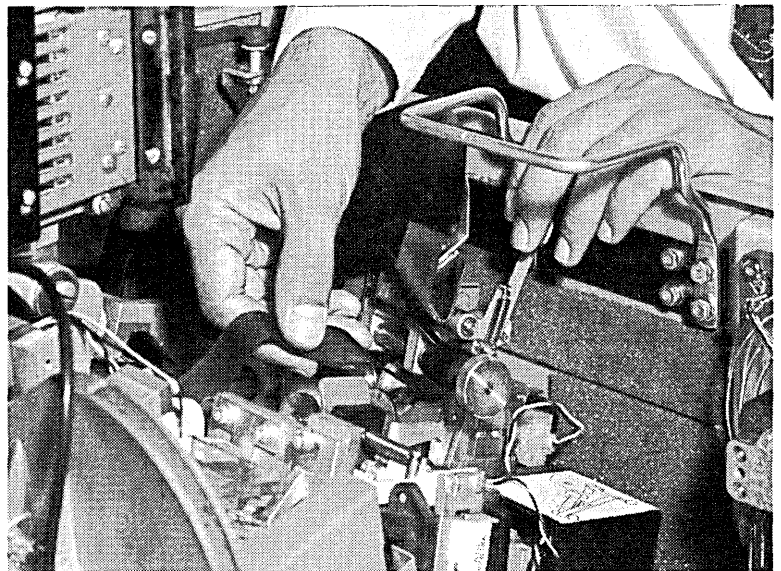

ART: 55036

- 3** Position ribbon under guide plate and under front and back guide.

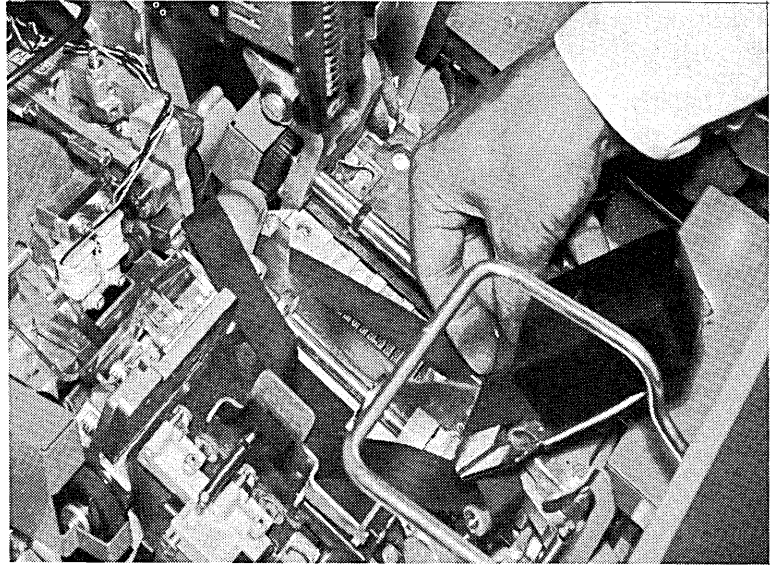

ART: 55039

- 4** Turn knob on ribbon drive counterclockwise to take up slack in ribbon.

**Note:** Apply light pressure with one finger under the ribbon during the take-up operation. No folds should be allowed to feed into the ribbon cartridge. When the take-up operation is complete, check the ribbon path to ensure there are no folds in the ribbon and the ribbon is not wrapped around any of the guides or rolls.

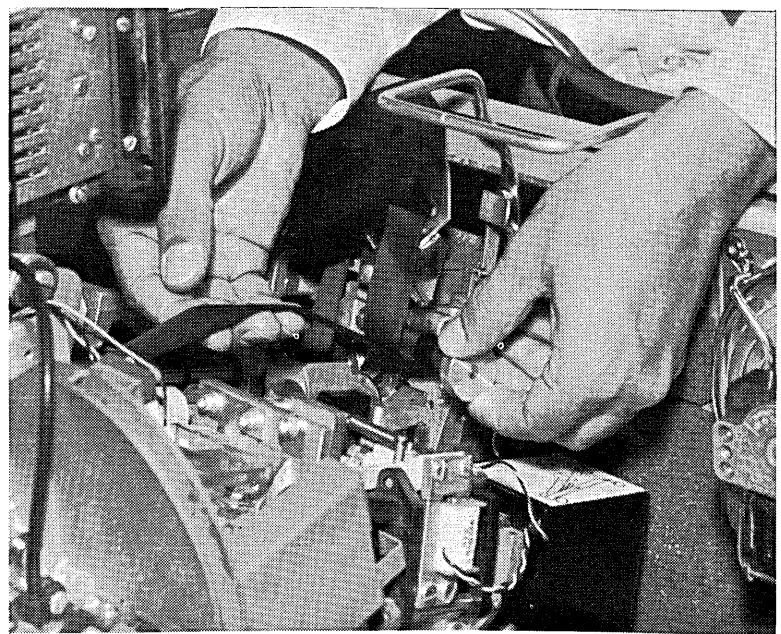

ART: 55040

- 5 Close and lock print unit.
- 6 Close MFCU top covers.
- 7 Press and hold NPRO key to feed ribbon. Release NPRO key.

Raise top cover to see if ribbon is feeding properly. If ribbon is feeding properly, close top cover and resume program operations.

## EMPTYING THE MFCU CHIP BOX

- 1 Open MFCU top cover. Lift latch to release cover. Pivot outer top cover towards front of machine.

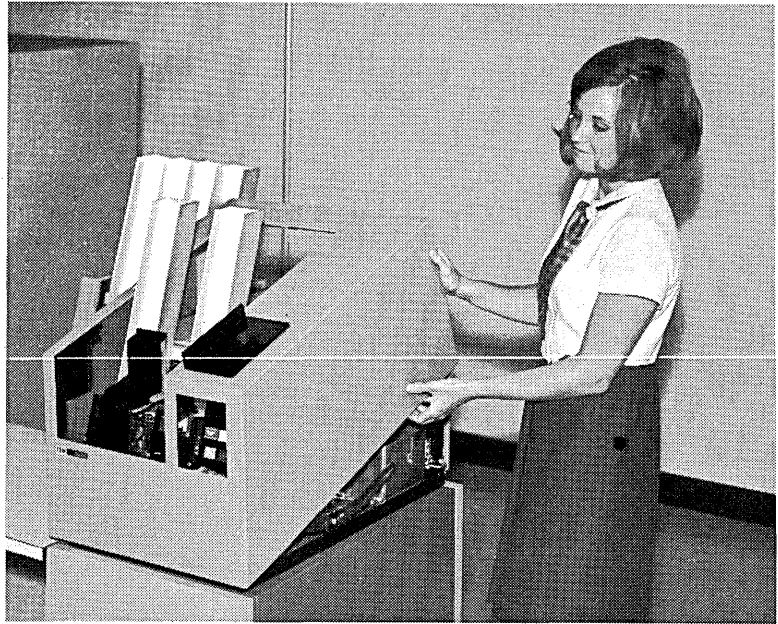

ART: 55028

- 2 Lift chip box up and out towards front of machine.

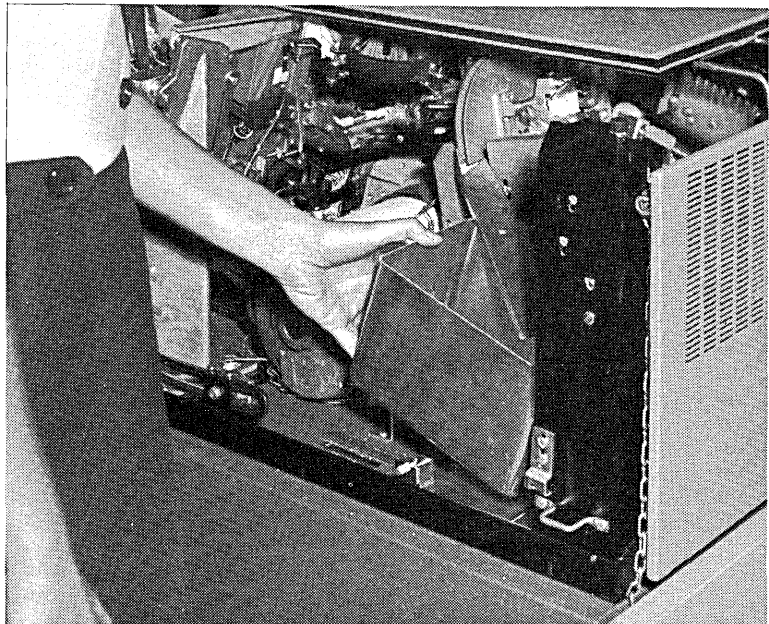

ART: 55041

- 3 Empty chip box.
- 4 Replace chip box.
- 5 Close MFCU top cover.
- 6 Press MFCU START to turn off CVR and CHIP lights on MFCU operator's panel.



- Printer Controls and Indicators
- Loading Forms in the Printer
- Changing the Printer Ribbon
- Changing the Print Chain Cartridge

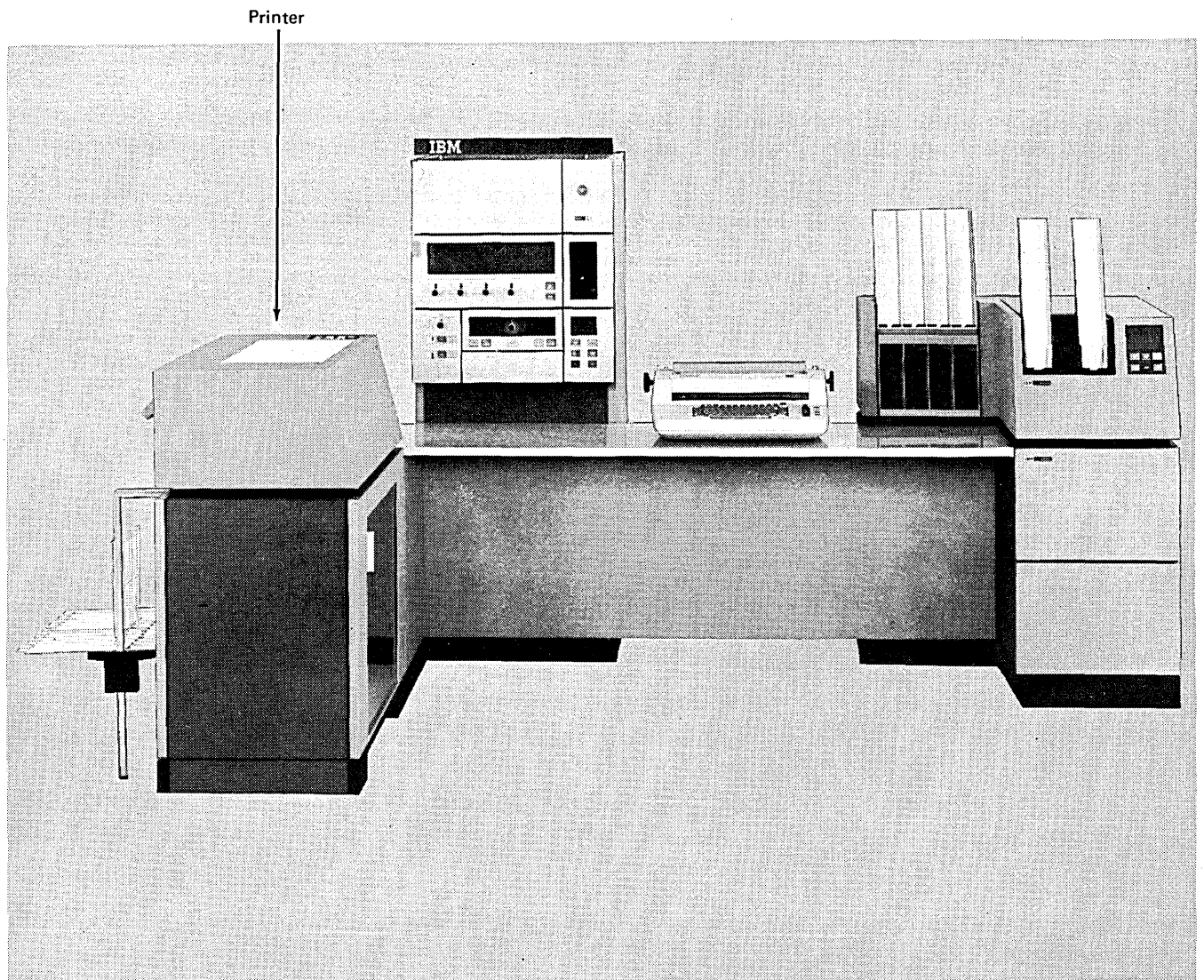

55239A

Note: You can use the 1403 Printer in place of the 5203 Printer. For a description and operating procedures of the 1403 Printer see *IBM 1403 Printer Component Description*, GA24-3073.

The standard carriage tape provided with the 1403 printer must be installed during operation of the printer with System/3.

### PRINTER CONTROLS AND INDICATORS

The lights and keys you use for communication with the printer are located on a panel on the printer. This panel contains four keys and four lights (six keys when the dual-feed carriage is installed).

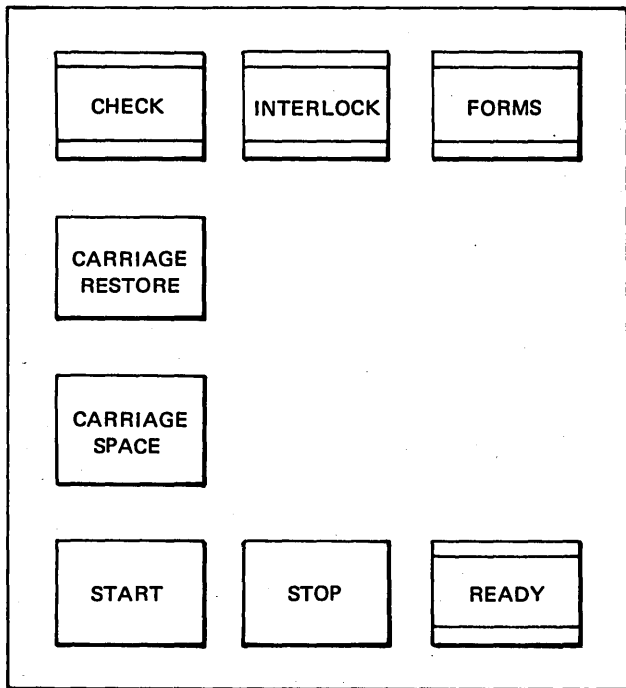

Printer Operator's Panel (Single-Feed Carriage)

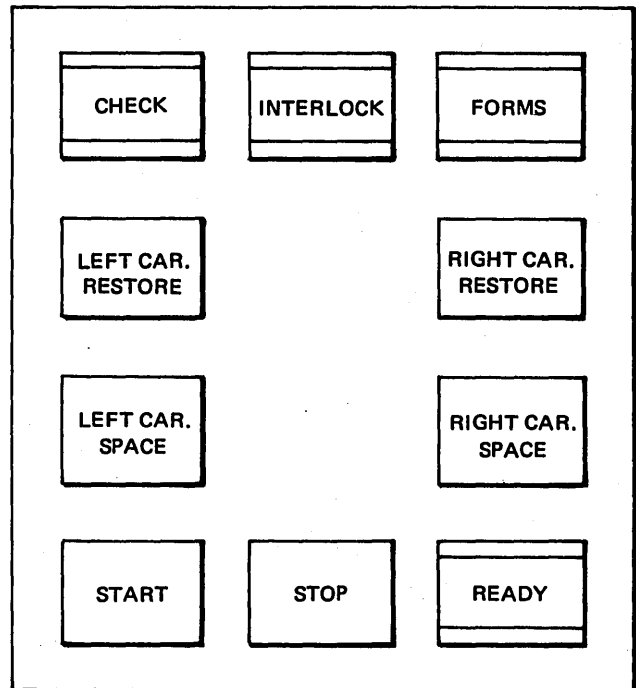

Printer Operator's Panel (Dual-Feed Carriage)



## Lights

**READY Light:** The READY light indicates that the printer is ready to print. When the light is on, the system has control of the printer. At this time, you cannot use CARRIAGE SPACE and CARRIAGE RESTORE keys.

The READY light turns on when you press START if no interlock and check conditions exist and there are forms in the printer. The READY light turns off if you press the STOP key, or if an interlock, check, or end-of-forms condition occurs.

**CHECK Light:** The CHECK light turns on when the system detects a condition that prevents or impairs print operations. The CHECK light turns off if you correct the error condition and press the START key.

**INTERLOCK Light:** The INTERLOCK light turns on when either of the following conditions exist:

1. Chain interlock. This condition occurs when the rear unit is open. The chain motor starts only when the rear unit is properly closed.
2. Chute interlock. This condition occurs when the forms chute is not pivoted back to the feed position.

The INTERLOCK light turns off when you correct the condition causing the interlock and press the START key.

**FORMS Light:** The FORMS light is turned on when about 14 inches (356 mm) of paper remains below the print line. When this light comes on, the printer finishes printing the current form and skips to the next form. As line 1 of the new form is detected, the READY light turns off. The paper stops at the first print line of the new form. No more printing can be done until new forms are loaded in the printer.

**Note:** For printers with dual-feed carriage, the READY light turns off when line 1 of the new form of either carriage is detected. The paper stops at the first print line of the new form for one of the carriages. No more printing can be done until new forms are loaded in the printer.

To restart, load new forms, using the forms loading procedure. It is not necessary to use the CARRIAGE RESTORE or CARRIAGE SPACE. Position the new form at the same line where the old form stopped. Press START to continue.

**Note:** For printers with dual-feed carriage, check to see that the form that caused the FORMS light to turn on is at line 1. If it is at line 1, load new forms using the preceding procedure. Press START to continue.

## Keys

**START Key:** When you press this key, it indicates to the system that the printer has been prepared for operation. If the printer is ready, READY turns on.

**STOP Key:** When you press the STOP key, it indicates to the system that the printer should stop after it completes the current print operation. The READY light turns off. If you press the STOP key during a manual restore operation, the forms stop immediately.

**CARRIAGE RESTORE Keys:** When you press the CARRIAGE RESTORE key, the forms advance to the first print line of a new form. If your printer has the dual-feed carriage, LEFT CAR. RESTORE restores the left carriage and RIGHT CAR. RESTORE restores the right carriage.

The restore keys are operational only when the printer is not ready. If READY is on, you must press the STOP key before the forms can be restored. The carriage restore keys can be used when the rear unit is open.

**CARRIAGE SPACE Keys:** When you press the CARRIAGE SPACE key, the forms advance one space. If your printer has a dual-feed carriage, LEFT CAR. SPACE moves the left carriage and RIGHT CAR. SPACE moves the right carriage.

The space keys are operational only when the printer is not ready. If READY is on, you must press the printer STOP key before the forms can be spaced. The carriage space keys can be used when the rear unit is open.

## LOADING FORMS IN THE PRINTER

- 1 Open printer top cover.



ART: 55047

- 2 Tip rear unit back.

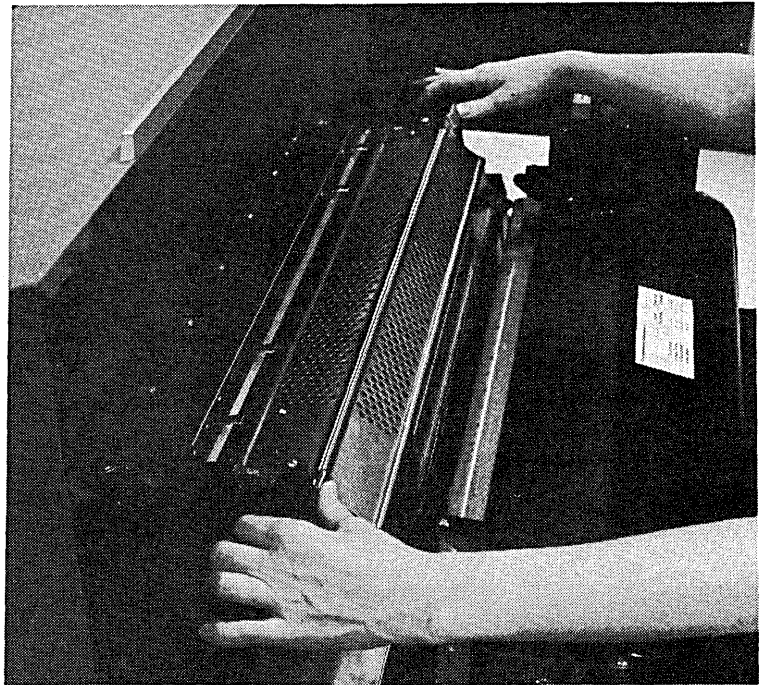

ART: 55048

- 3 Open forms tractors and position them for forms you are using. The tractors move easily when they are open.

Note: When full width forms, card stock, or envelopes are used, dummy tractors (clip-ons) must be installed between the tractors used to move the form. Dummy tractors ensure proper forms feeding. Up to three dummy tractors may be used.

Dummy Tractors (Clip-Ons)

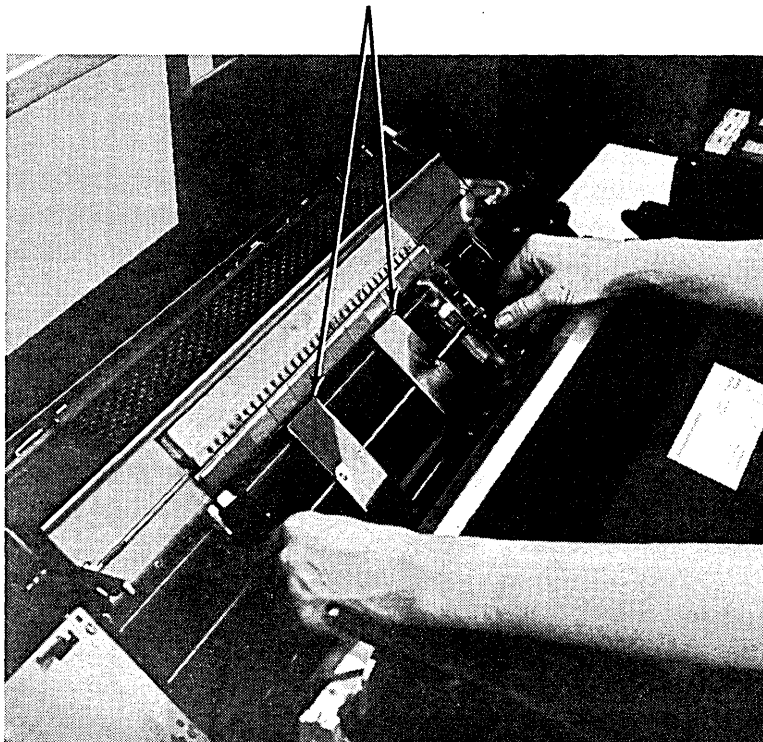

ART: 55049

- 4 Open sliding door and pull forms chute forward to forms loading position.



ART: 55050

- 5** Position forms and feed first form up forms chute. On multiple-copy forms, the dull side of the carbon should be towards you.



ART: 55051

- 6** Pull forms up and lay them back across tractor assembly. Place forms in form tractors, making certain that tractors keep tension across forms.



ART: 55052

(System power must be on to perform the following steps.)

- 7 Feed forms back under pressure rollers using carriage restore key.

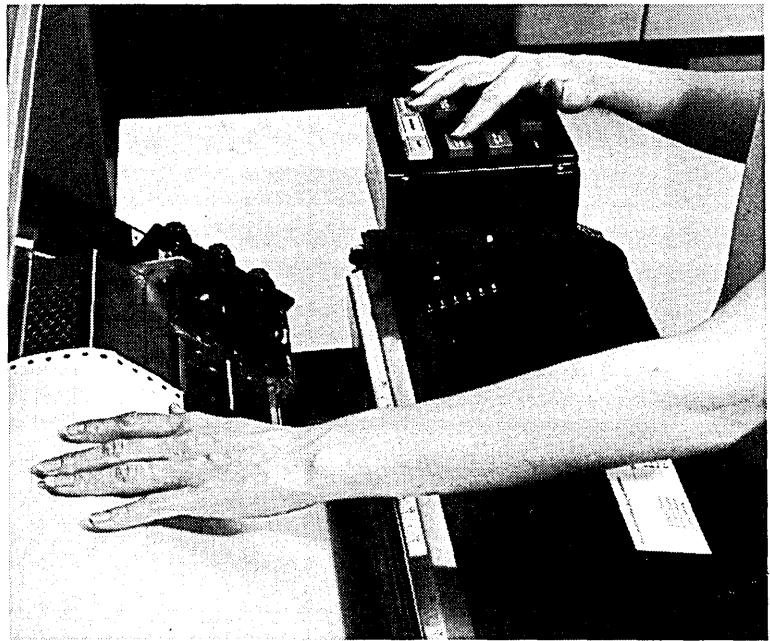

ART: 55053

- 8 Position the pressure rollers on the forms so the outside edges of the rollers are aligned approximately with the center of the pin feed holes. Use only two rollers on a form (one on each side). To prevent ink smudging, the rollers must be outside the print area. To prevent the rollers from possibly pulling the tear strip off the forms, the rollers should overlap the perforation of the tear strip.

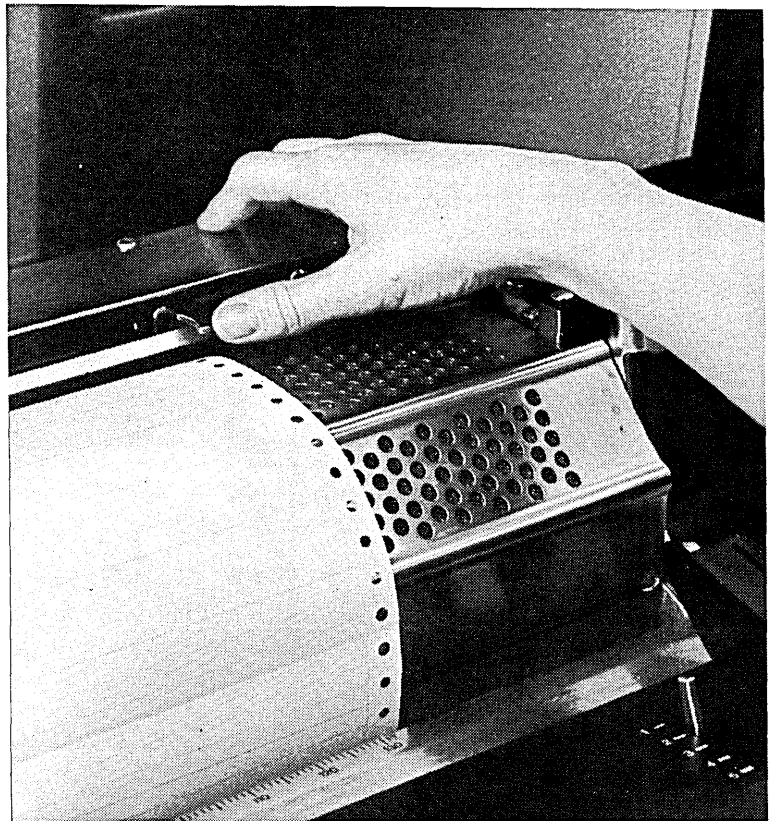

ART: 55054

- 9** Set pressure roller tension for forms you are using. See recommendation label on ribbon cover.

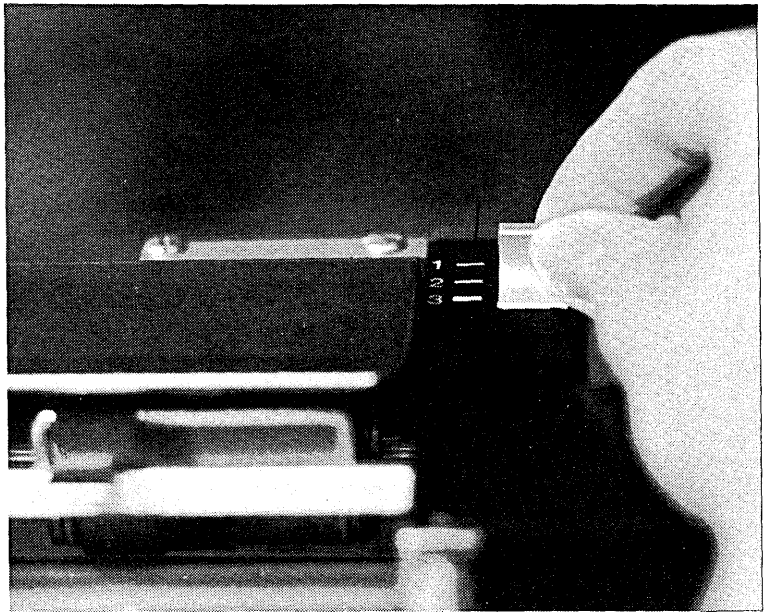

ART: 55055

- 10** Activate pressure rollers to check if forms are pulled back evenly. The rollers should not turn when they are set against paper. If a roller continues to turn, move it right or left until it drops against paper.

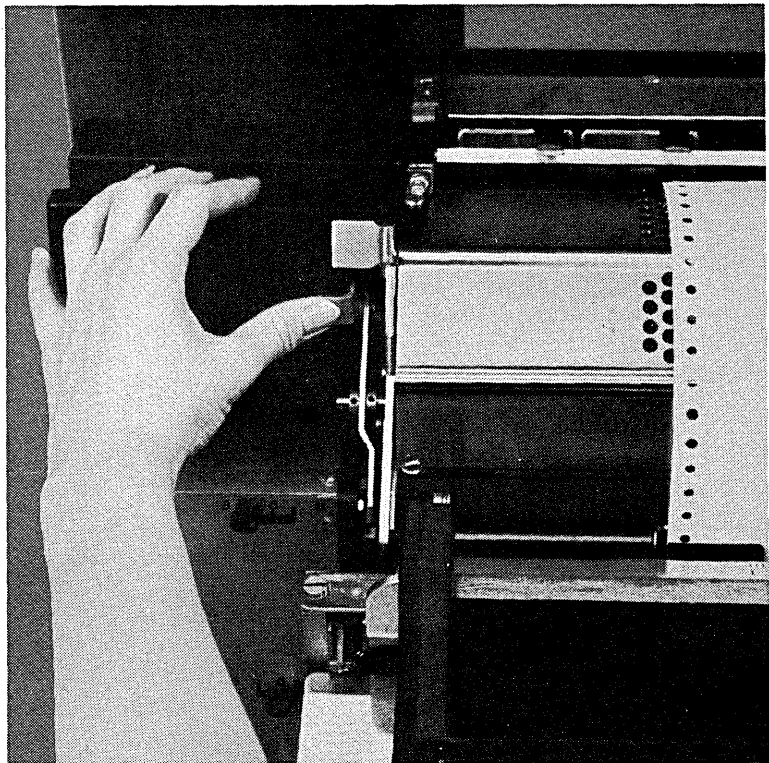

ART: 55056



- 11 Disengage carriage clutch of carriage you are using. (Set the space select lever to the center position.)

Left Carriage Clutch

Right Carriage Clutch  
(Dual Feed Carriage Only)

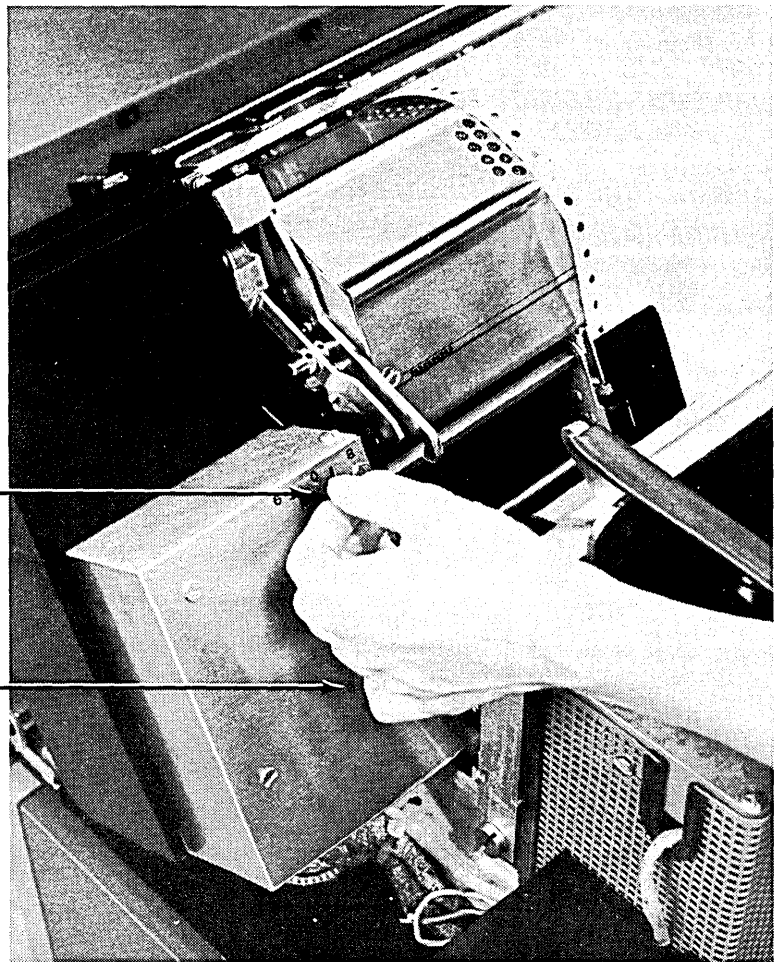

ART: 55057

- 12 Advance forms using vertical adjustment knob (ϕ) until crease between forms is aligned with upper scribe line on forms guide.

This procedure aligns forms for printing first line.

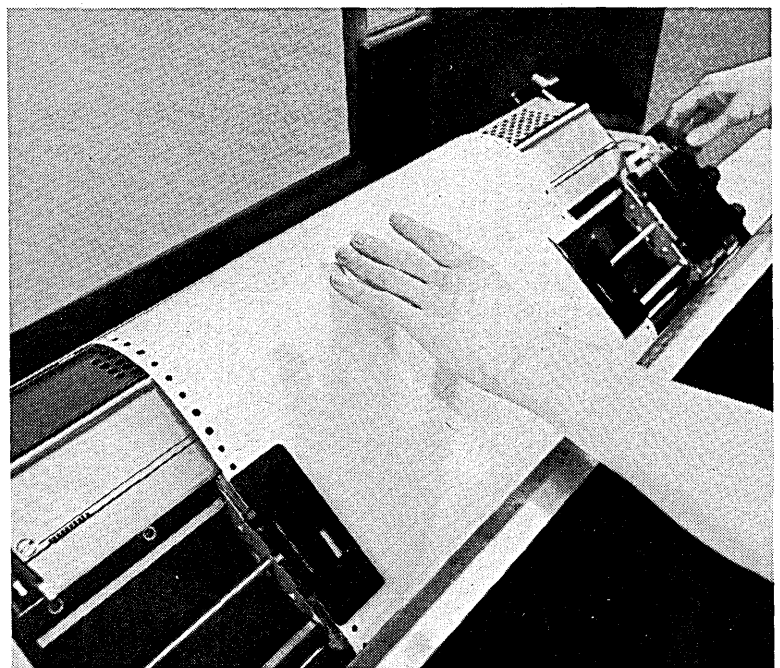

ART: 55058

- 13 Press appropriate carriage restore key.
- 14 Engage carriage clutch. (Set space select lever to six or eight lines per inch.)
- 15 Tip ribbon shield back against forms. Use tractor lateral adjustment knob (←→) to align forms with print positions. Close ribbon shield.

Note: Printers with dual feed carriage. The tractor lateral adjustment knob moves both sets of tractors at the same time. One form can be adjusted as described above. However, the other form must be laterally adjusted by physically moving the tractors to align the form with the print position.

Do not leave unused tractors against edge of carriage. A tractor can be damaged if it is forced against the edge of the carriage by the lateral adjustment knob.

- 16 Close rear unit.
- 17 If you have the 300-line-per-minute printer, set impression control dial on the printer to proper setting for forms you are using. See recommendation label on ribbon cover. Change setting as required to obtain best print quality.

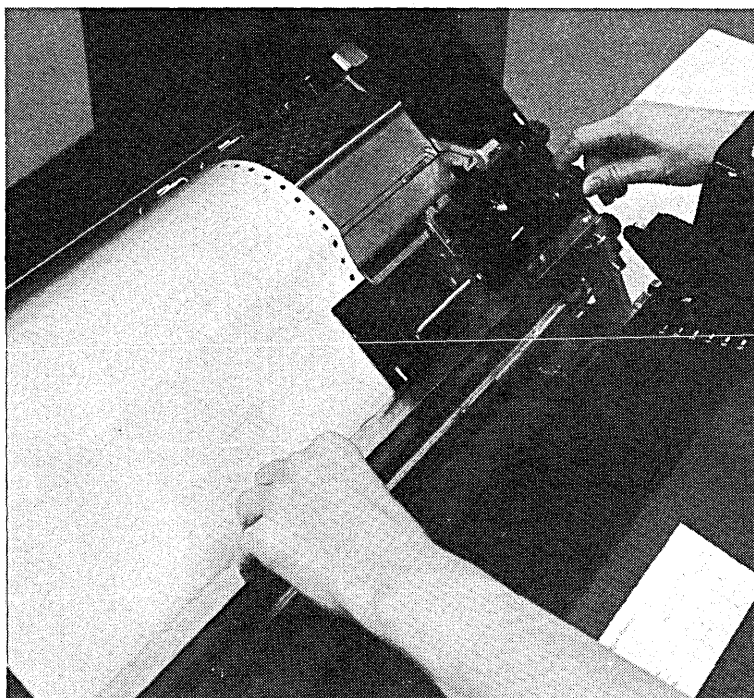

ART: 55059

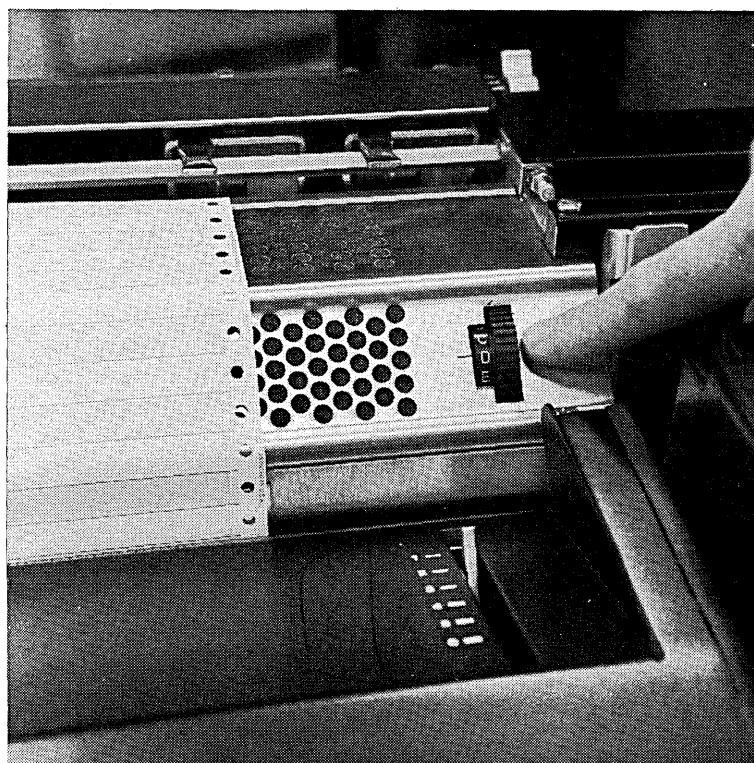

ART: 55095



- 18 Set forms adjusting lever to proper setting for forms you are using. See recommendation label on ribbon cover. Change setting as required to obtain best print quality.

Note: Printers with dual feed carriage. To obtain best quality printing when using two forms, the forms should be the same thickness.



ART: 55060

- 19 Push forms loading chute back to operating position.



ART: 55061

- 20 Position end-of-forms switch so end-of-forms switch feeler drops into cutout over forms.

Note: Printers with dual feed carriage have two end-of-forms switches. Only one end-of-forms switch should be used on a form.

When only one carriage is used, position the unused end-of-forms switch as follows:

- Raise the end-of-forms switch feeler out of the cutout in the forms chute.
- Move the switch left or right to the next position (indentation) on the bar.

In this position, the end-of-forms switch feeler rides on the forms chute, simulating forms in the printer.

When two forms are used, move an end-of-forms switch into a cutout over each form.

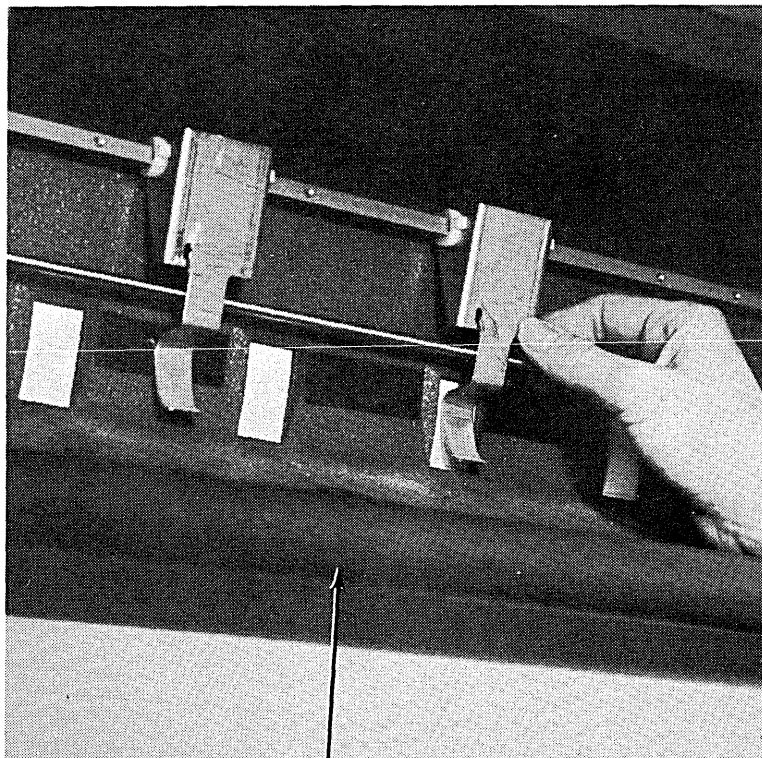

Forms Loading Chute

ART: 55062

- 21 Close sliding door on forms compartment.

- 22 Close printer top cover.

23

Adjust forms stacker. Press carriage restore a number of times to feed paper into stacker. Raise the stacker tray until the distance from the tray to the bottom of the printer top cover is one form length. This is a good setting for a medium stack of standard forms. Set the inner and outer upright guides so they just clear the forms. The outer guides can be layed out horizontally to handle large forms.

When forms are loaded with a length different from the length of the forms used previously, a FORMS statement must be supplied to the system by the next job run on the system. The programmer should provide you with the FORMS statement.

24

Press printer START.



Outer Guides

Tray Release  
Levers

ART: 55063

## CHANGING THE PRINTER RIBBON

### Removal

Wear disposable gloves when handling the ribbon.

- 1 Open printer top cover.

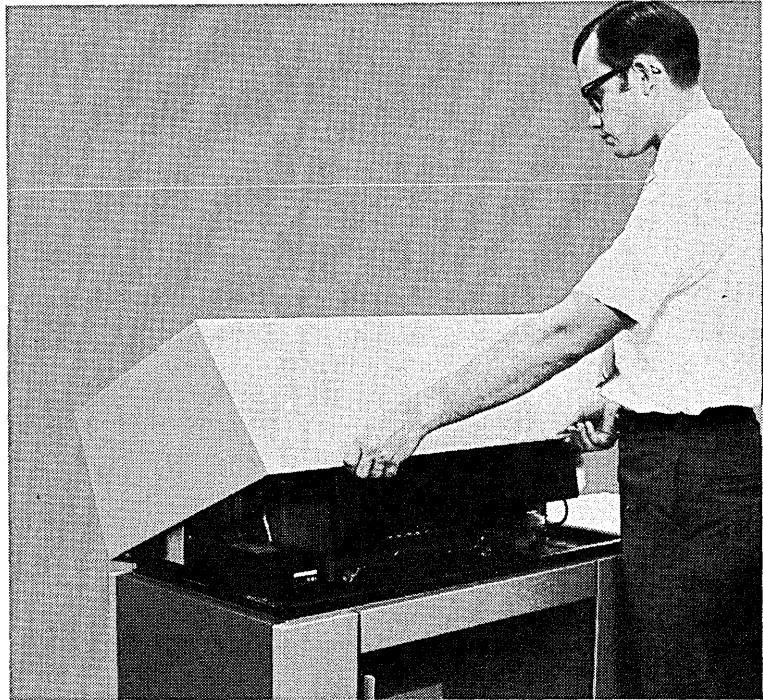

ART: 55064

- 2 Tip rear unit back.

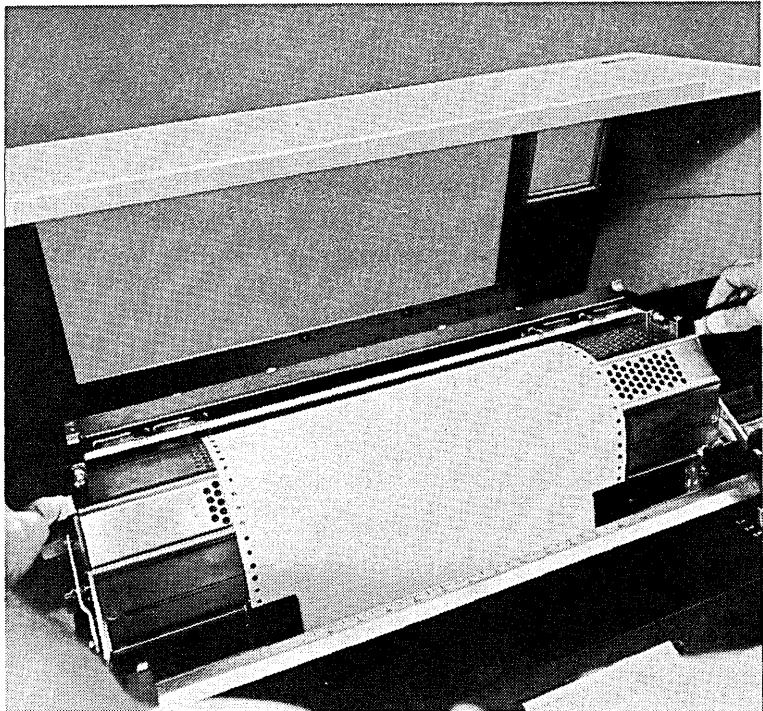

ART: 55065

3 Tip ribbon shield back.

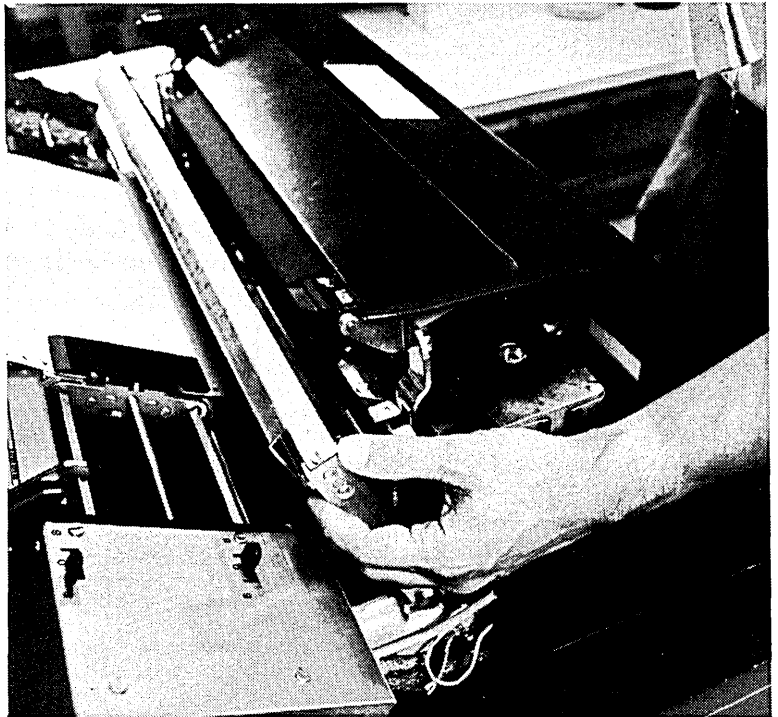

ART: 55066

4 Lift ribbon cover and swing it back onto rear unit.

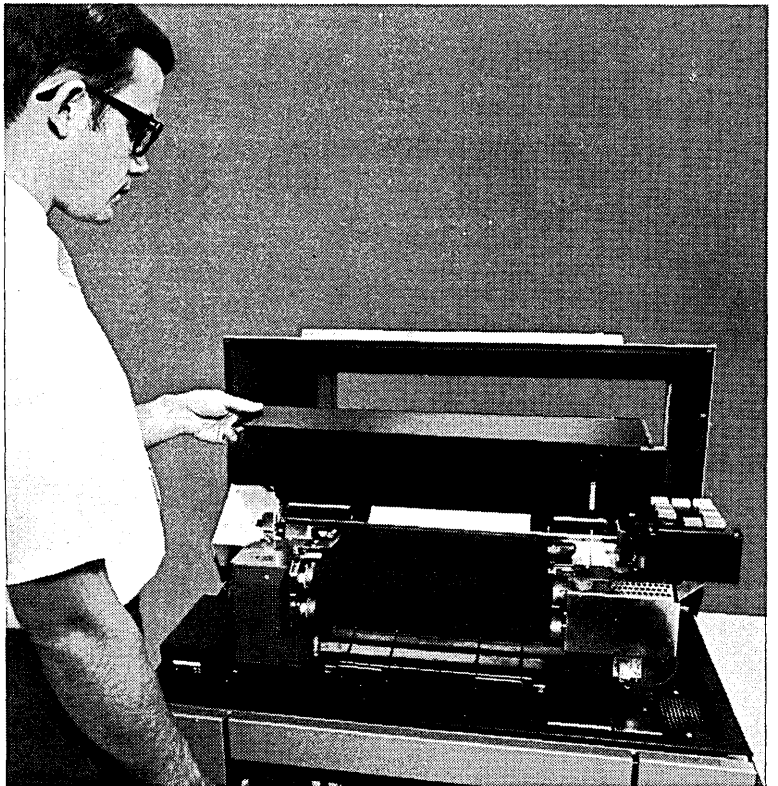

ART: 55067

5

Disengage ribbon spool containing the least ribbon from the ribbon drive.

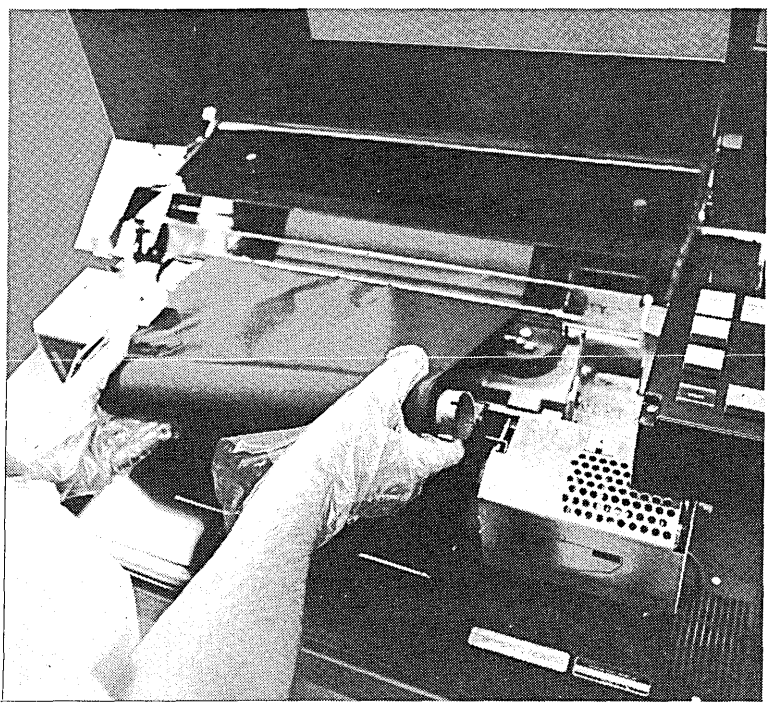

ART: 55068

6

Drop ribbon behind print chain cartridge or feed ribbon spool up behind chain cartridge.

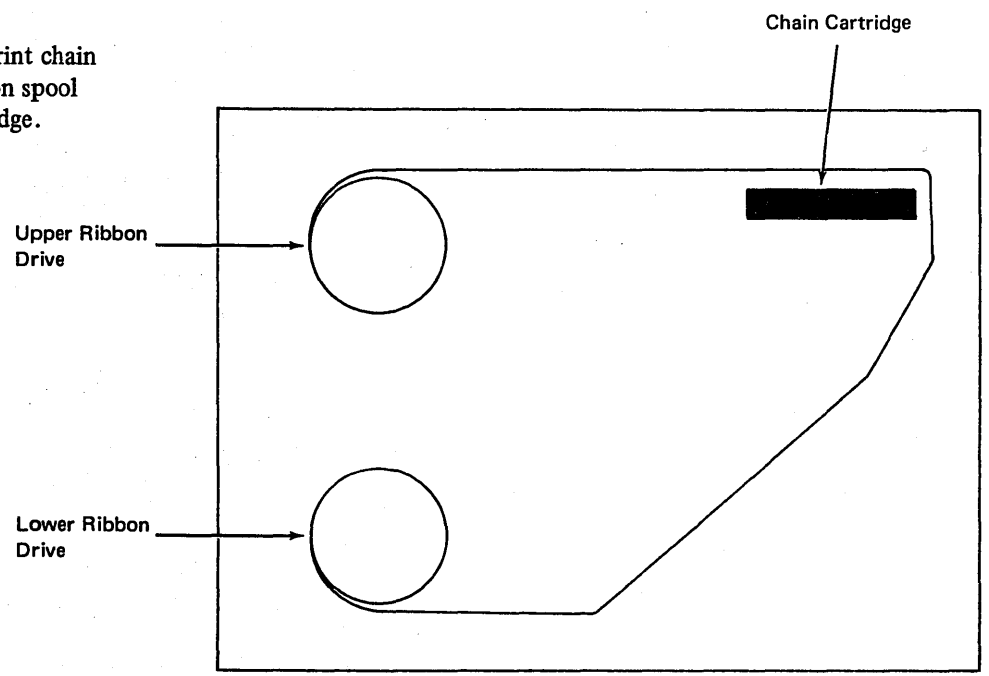

- 7 Disengage ribbon spool from other ribbon drive. Discard ribbon.

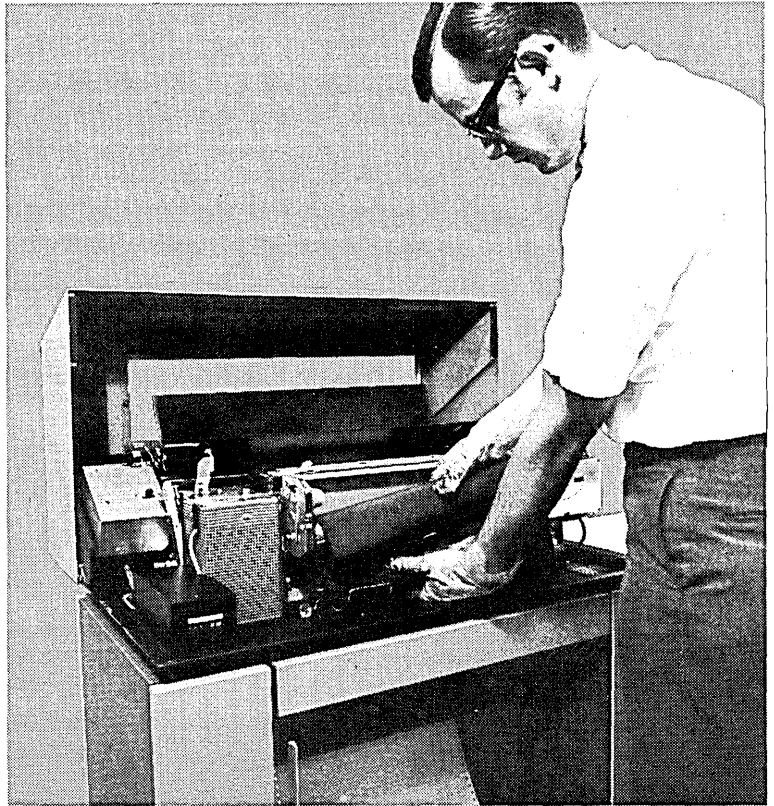

ART: 55069



**Installation**

- 1 Attach new ribbon spool to upper ribbon drive. The bulk of ribbon is now on this spool.

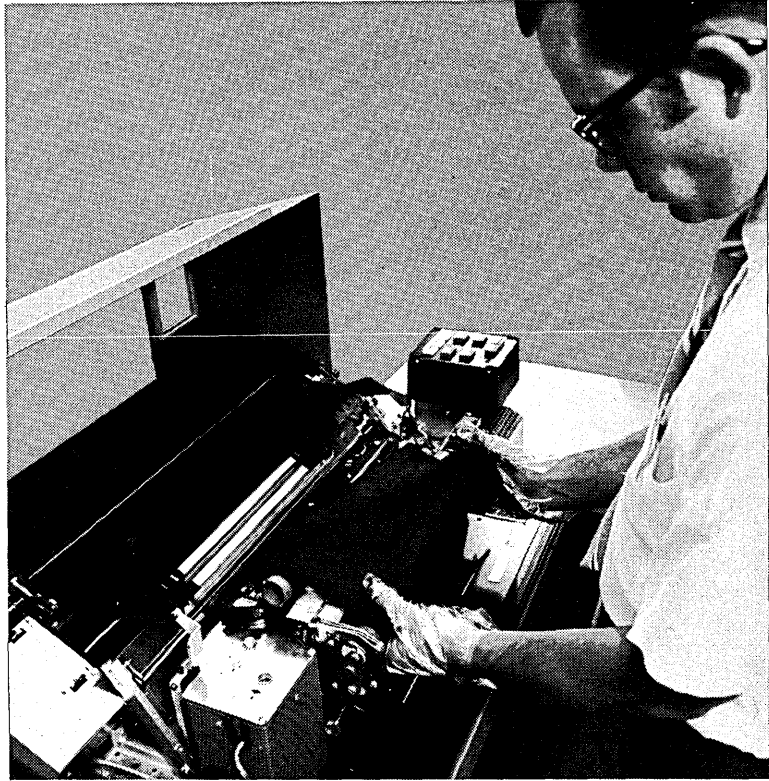

ART: 55070

- 2 Feed ribbon behind and under chain cartridge assembly.

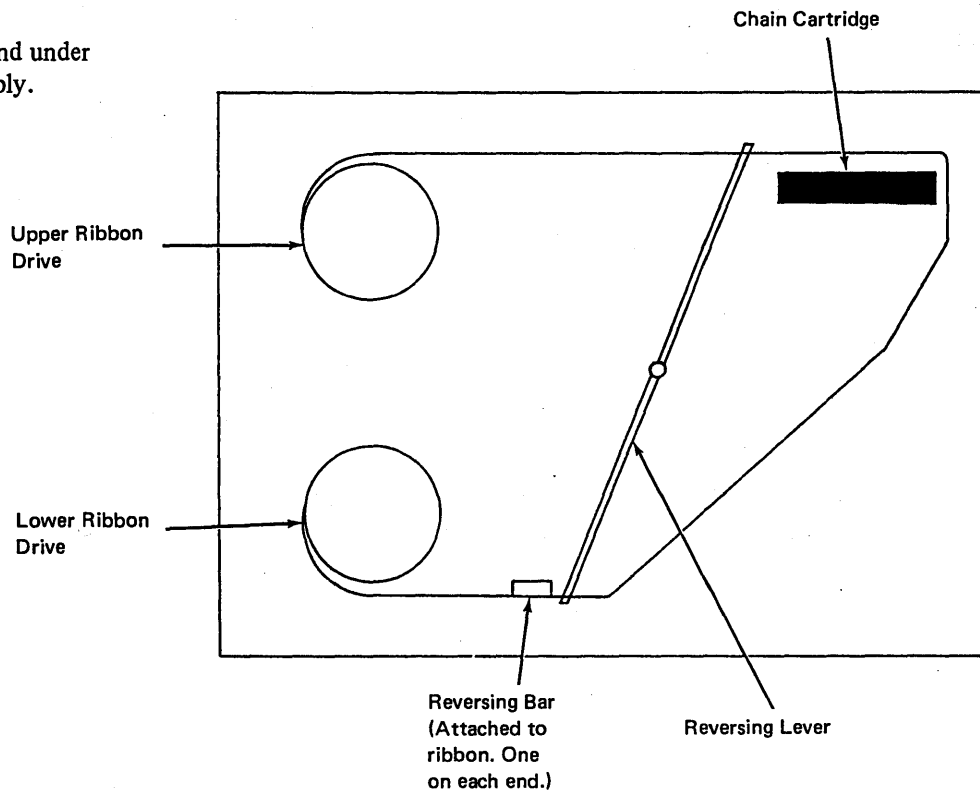



- 3 Attach ribbon spool to lower ribbon drive. Make sure ribbon is under ribbon guide.

Note: Check that reversing bar is still on ribbon spool circumference, or is at least between ribbon spool body and reversing lever (see illustration in step 2).

Ribbon Guide



ART: 55071

- 4 Ensure that notches in ribbon spools are properly seated on drive keys.

- 5 Close ribbon cover.

- 6 Close ribbon shield.

- 7 Close rear unit.

- 8 Close printer top cover.

Note: It is recommended that excessive ribbon lint be removed from the ribbon shield and from around the cartridge area on a regular basis. Excessive accumulation of ribbon lint may cause smudging or light printing on the forms. Contact your Customer Engineer for cleaning instructions.

*"For 5203 Model 3, with 132 print positions only"* – If a ribbon is being removed for re-use at a later time, spools should be attached in the same positions (i.e., top spools must remain on top). If the spools are reversed, characters printed in the first print position may be illegible.

Spool properly seated

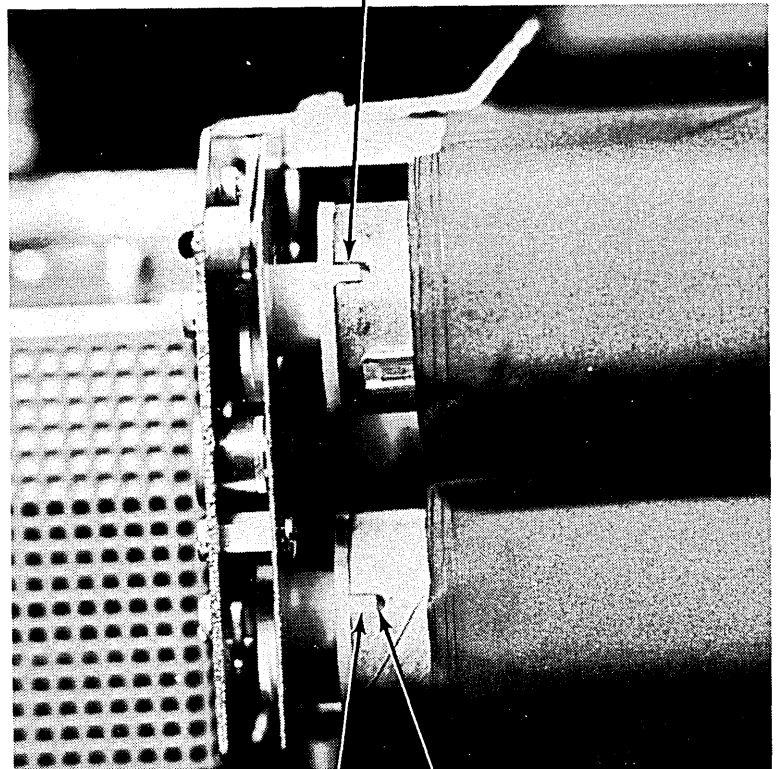

Key

Notch

ART: 55072

## CHANGING THE PRINT CHAIN CARTRIDGE

### Removal

Wear disposable gloves when handling the ribbon or chain cartridge.

- 1 Open printer top cover.

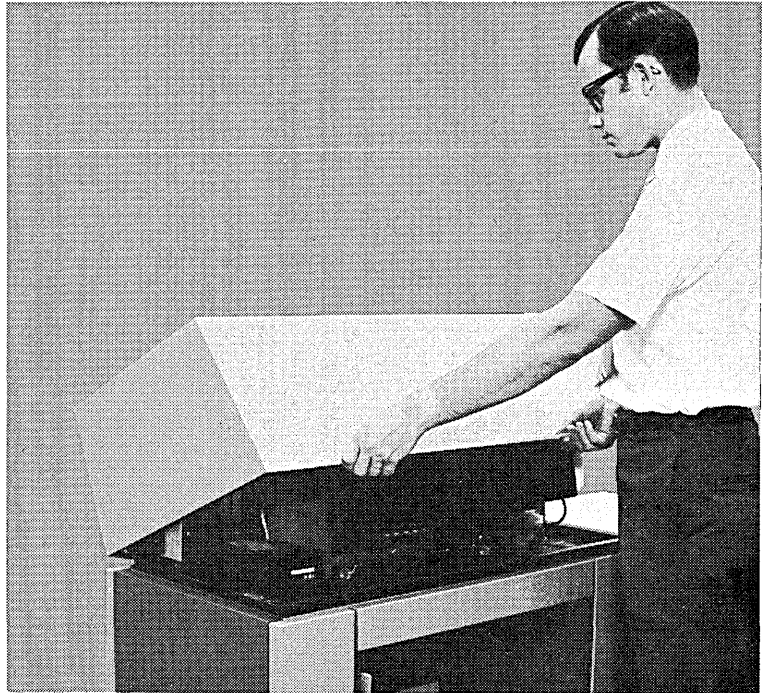

ART: 55064

- 2 Tip rear unit back.

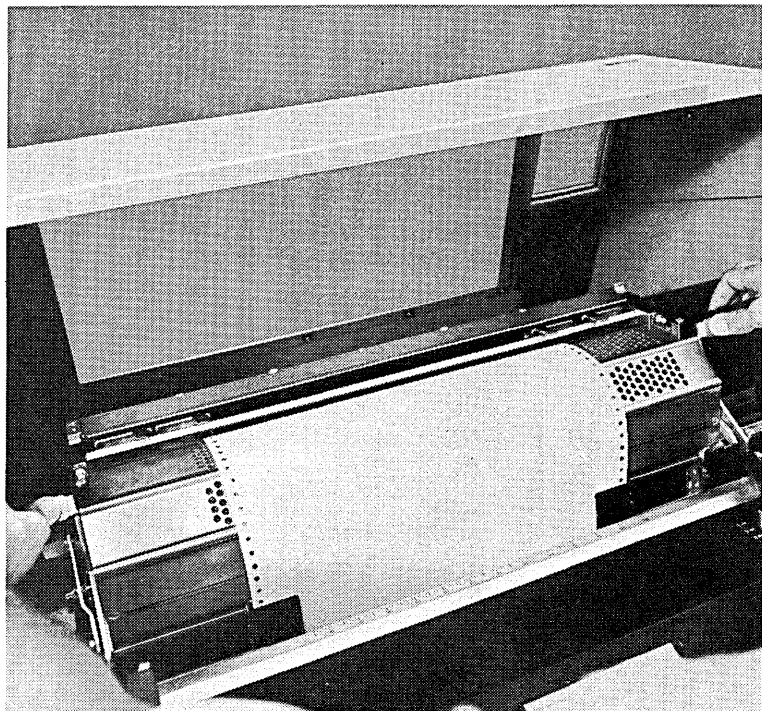

ART: 55065

- 3 Tip ribbon shield back.

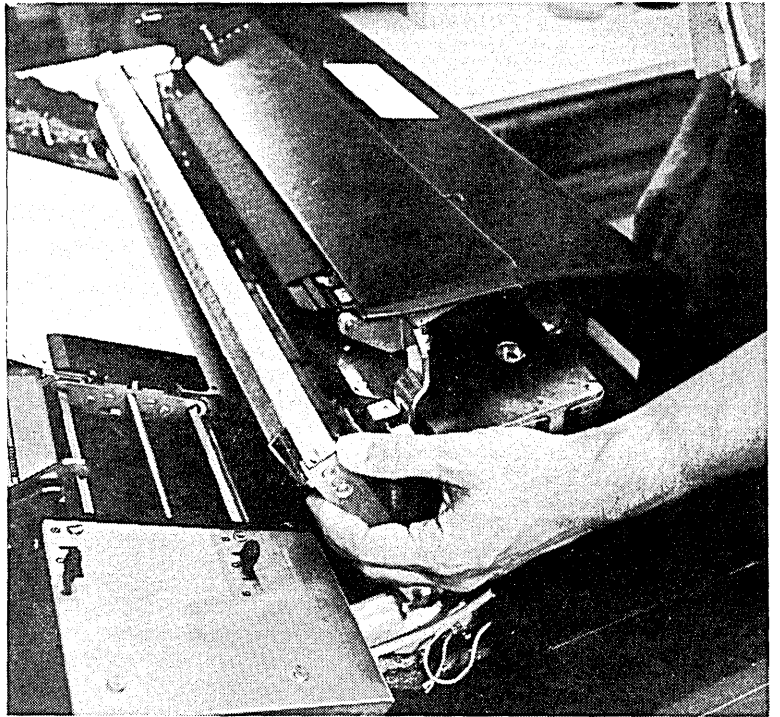

ART: 55066

- 4 Lift ribbon cover and swing it back onto rear unit.

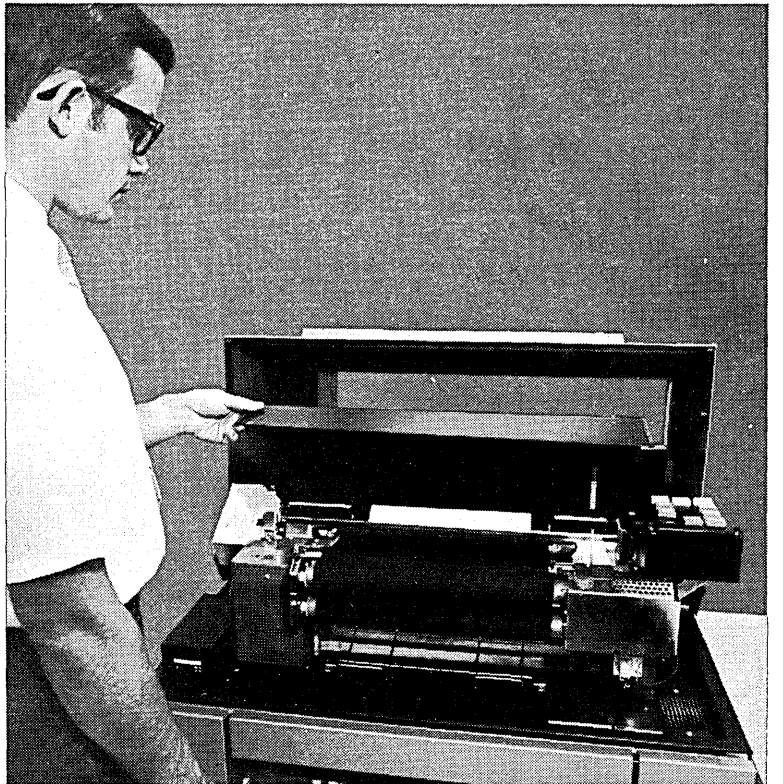

ART: 55067

- 5 Disengage ribbon spool from upper ribbon drive.

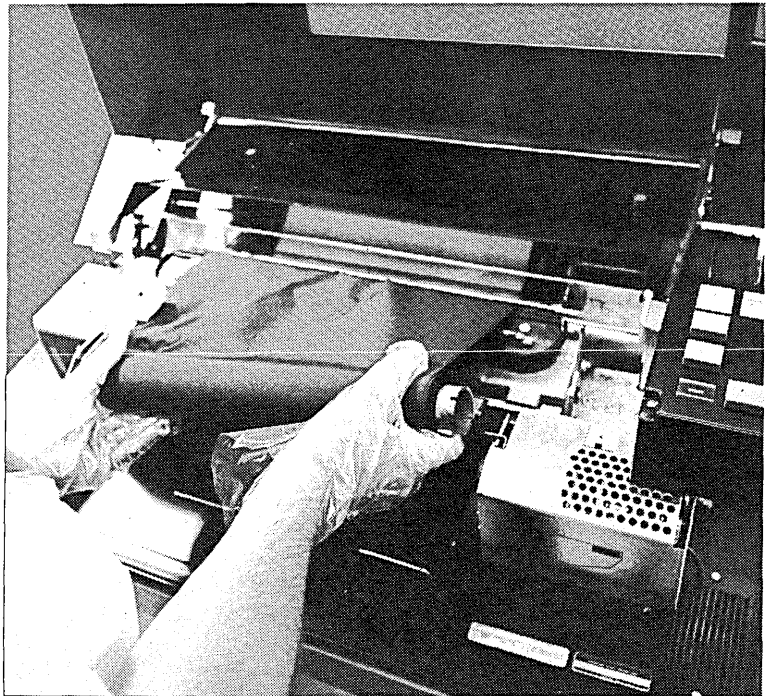

ART: 55068

- 6 Lay ribbon on ribbon cover.

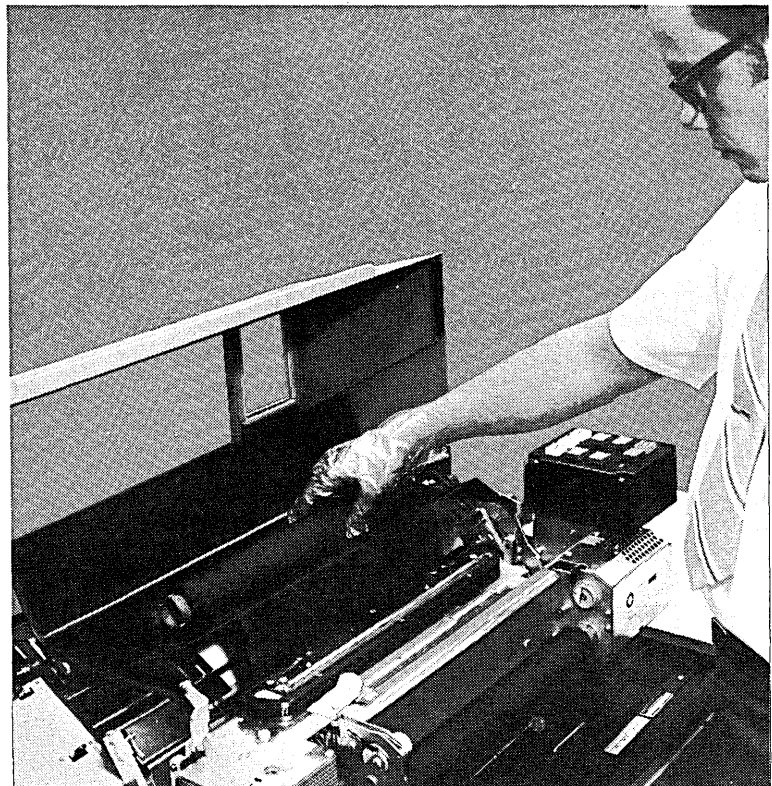

ART: 55073

7

Raise chain cartridge handles and lift cartridge up and out of machine.

*Note:* Some cartridges \* are secured by thumb screws rather than locking handles. Loosen the thumb screws until they are disengaged from the guide pins and lift the cartridge using the rings on the thumb screws.

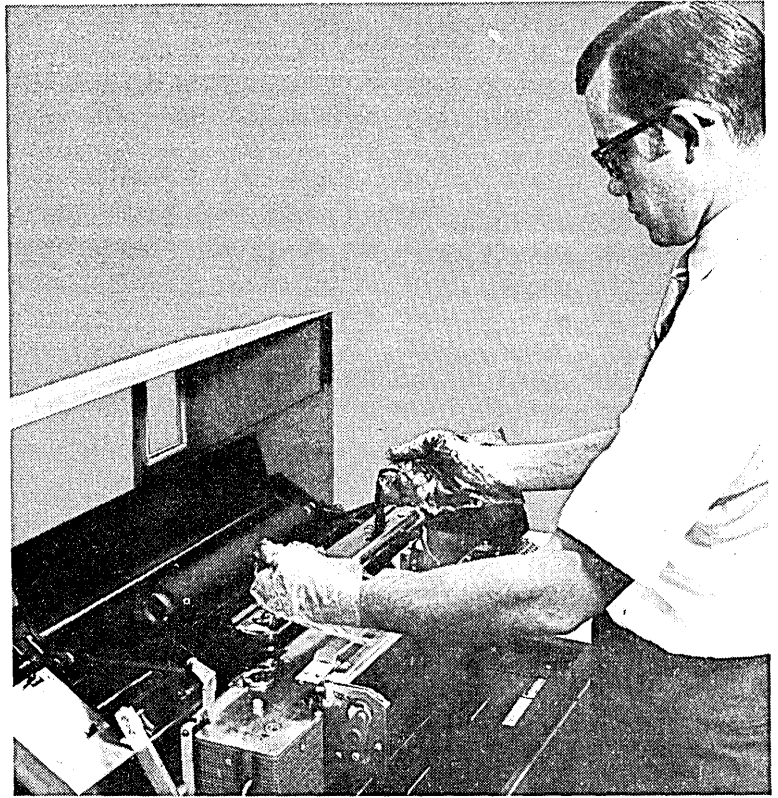

ART: 55089

---

\* These cartridges will be used only on printers delivered in the United States that do not have the Universal Character Set feature.



### Installation of 48-Character LC Print Arrangement Chain

- 1 Lower new cartridge onto guide pins.  
*Caution:* Do not close cartridge handles. If the cartridge has thumb screws rather than locking handles, do not tighten the thumb screws.

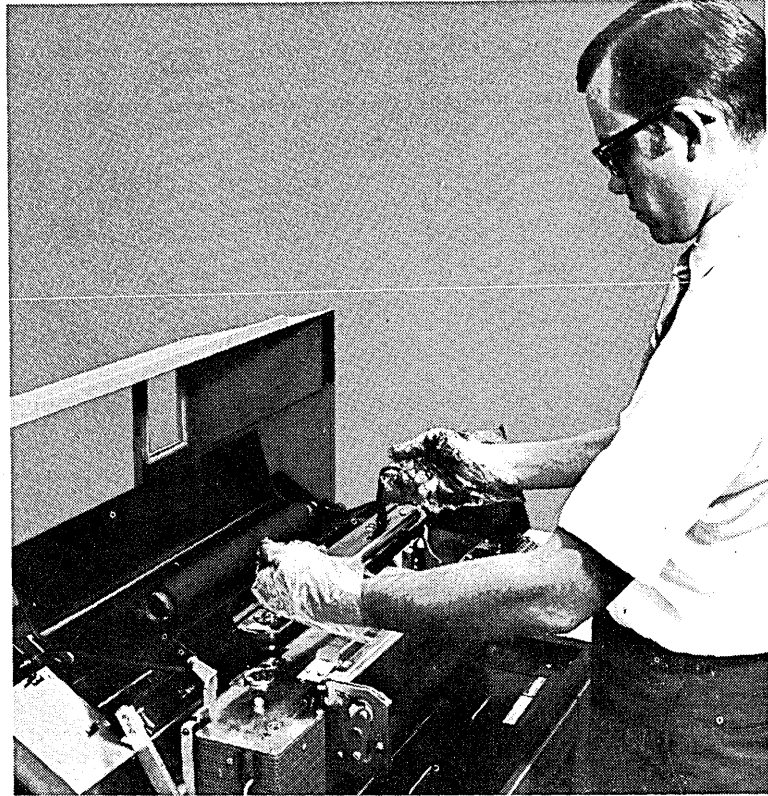

ART: 55089

- 2 To position the left end of the cartridge on the casting: hold print chain and turn chain drive motor, or hold print chain, press brake lever, and turn chain. There is an audible click when the cartridge drops into place.

Access to turn the motor is through the cut-a-way portion of the casting between the ribbon shield and the chain drive motor.

- 3 Close cartridge handles. They lay down flat against cartridge.

If the cartridge has thumb screws, thread the thumb screws into the guide pins until the screws are thumb tight.

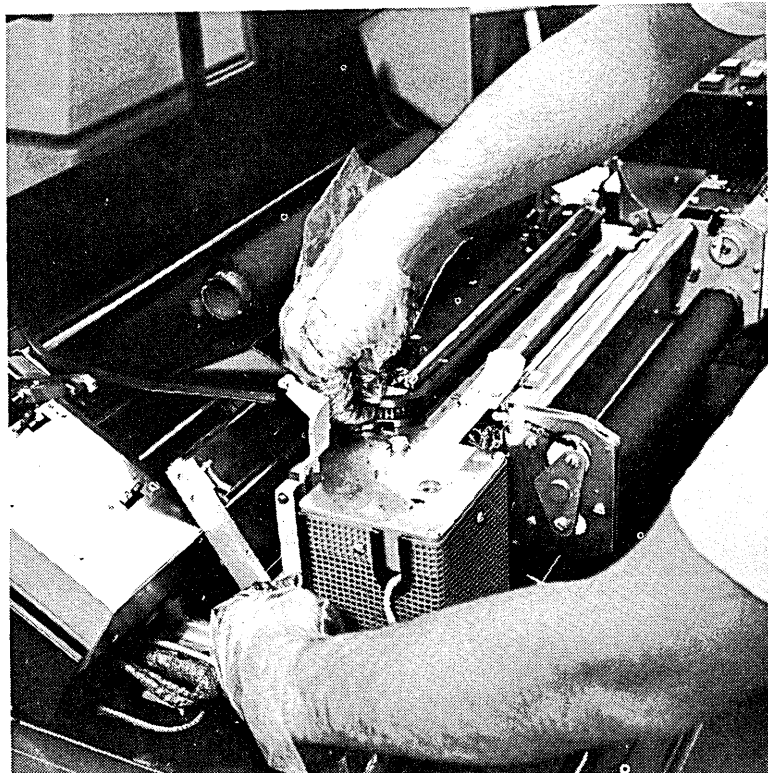

ART: 55090

- 4 Attach ribbon spool to upper ribbon drive. Make sure ribbon is under ribbon guide.

Ribbon Guide

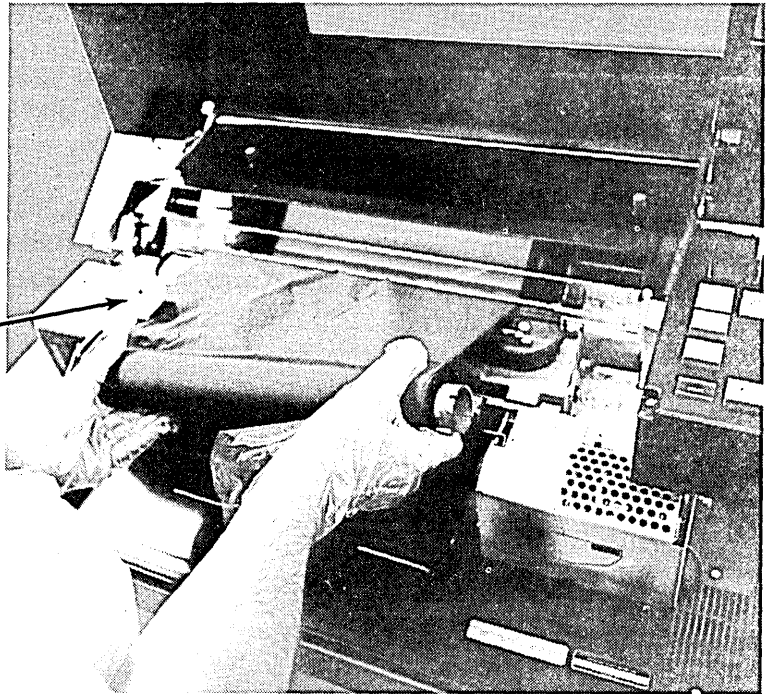

ART: 55068

- 5 Close ribbon cover.
- 6 Close ribbon shield.
- 7 Close rear unit.
- 8 Close printer top cover.
- 9 After you have changed the printer chain, a // IMAGE statement must be supplied to the system before any more jobs are run. Be sure the // IMAGE statement is in front of the OCL for the first job to be run after changing the chain. For more information on the IMAGE statement, see *Appendix A*.



### Installation of UCS Cartridge

- 1 Turn drive motor counterclockwise until mark in view window (A) and slot in drive shaft (B) line up as shown. The mark in the view window can appear up to five times before the proper relationship between A and B is achieved.

Access to turn the motor is through the cutaway portion of the casting between the ribbon shield and the drive motor (or a special tool may be attached to the printer to turn the cartridge drive).

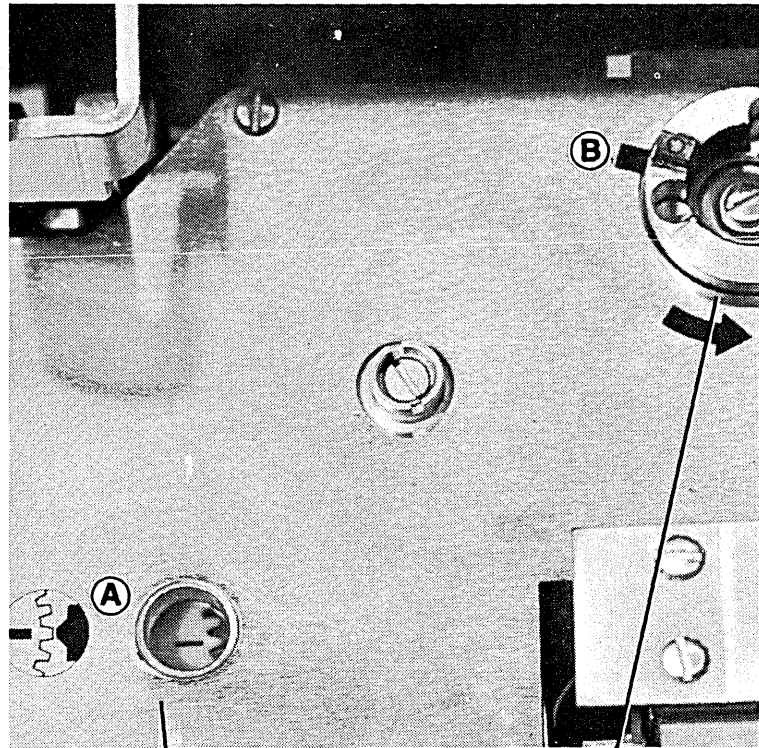

ART: 55091

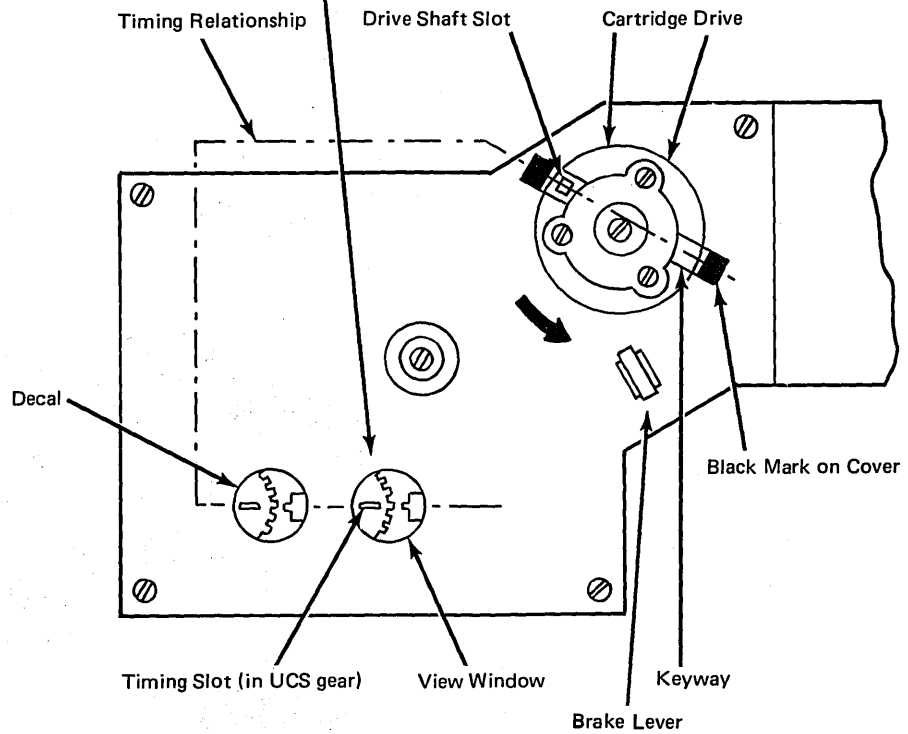

2

Swing the cartridge up and out (away from you) and turn it upside down.

*Chain Cartridges for 100 and 200 Line-Per-Minute Printers:* Turn the chain until the key character, the key slot, and the arrow on the decal are aligned as shown in the diagram. (A special tool may be attached to the printer to turn the chain.) Check the characters on the chain to either side of the arrow on the decal. If the chain is properly aligned, the characters on the decal will match the characters on the chain. If the characters do not match, turn the chain until the key character, the key slot, and the arrow on the decal are aligned as shown. Check the chain and decal characters again. You may have to turn the chain up to four times before the proper match is found.

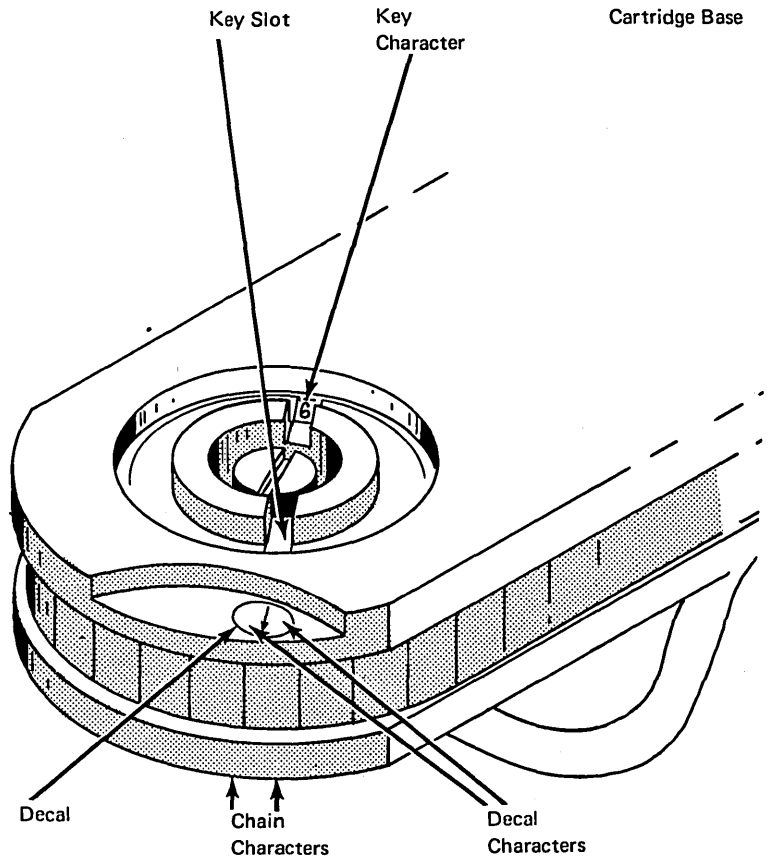

*Train Cartridges for 300 Line-Per-Minute Printers:* Turn the train until the copper colored slug with the characters + . ) is opposite the arrow on the cartridge base. (A special tool may be attached to the printer to turn the train.) Other slugs might have the characters + . ) but only one slug is copper colored. Align the character ) on this slug with the arrow.

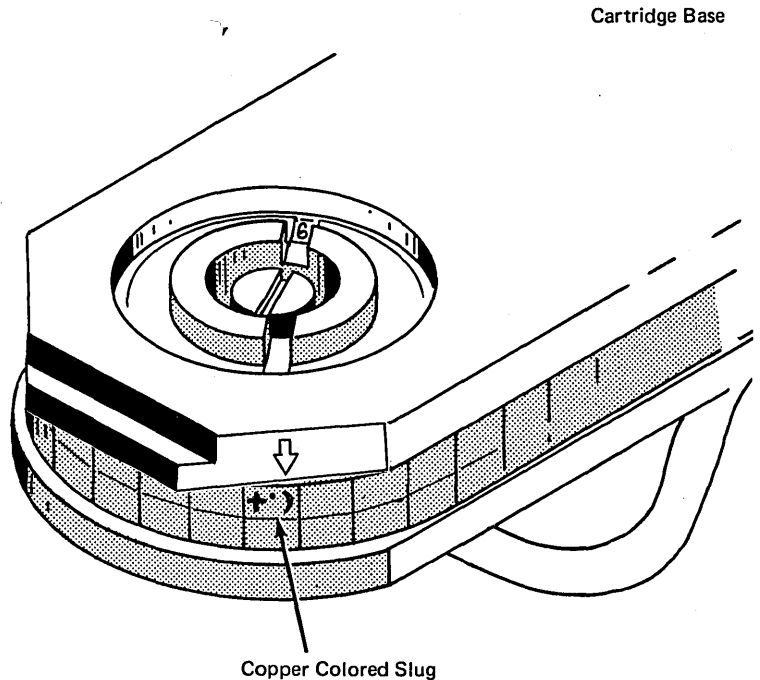

3

Lower cartridge onto guide pins, hold print chain, and rock motor until cartridge seats on casting.

*Caution:* Do not close cartridge handles before cartridge is seated.

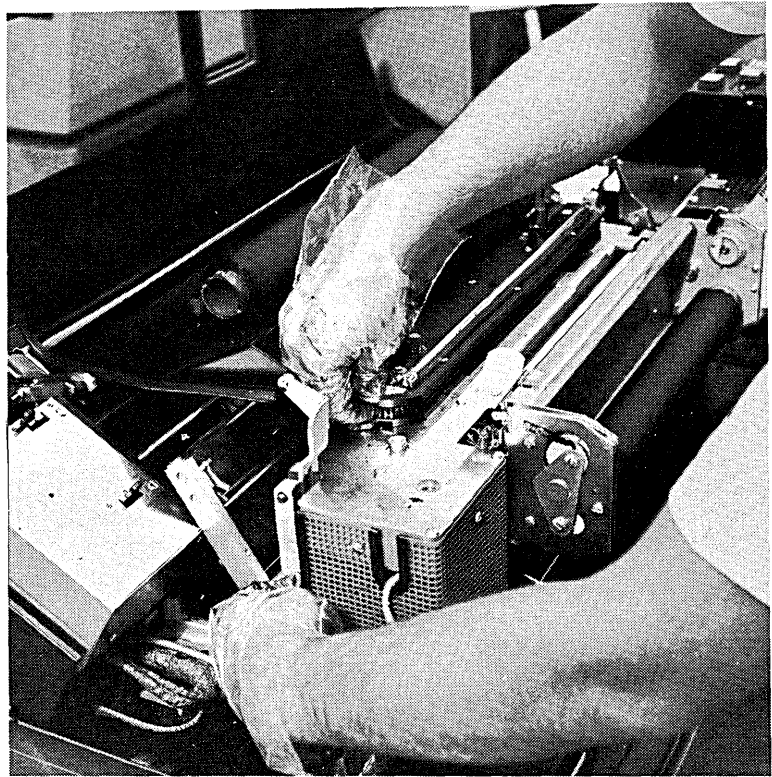

ART: 55090

4

Attach ribbon spool to upper ribbon drive. Make sure ribbon is under ribbon guide.

Ribbon Guide

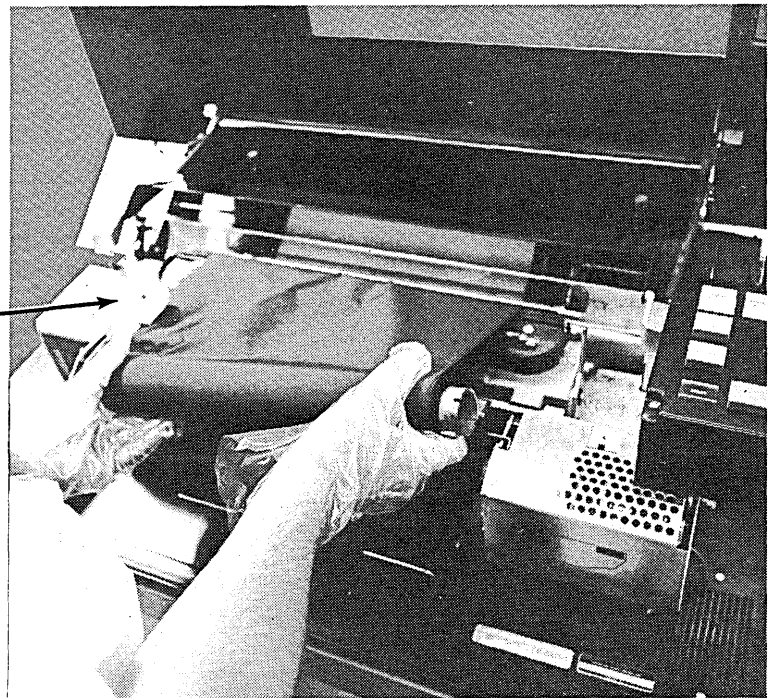

ART: 55068

- 5 Close ribbon cover.
- 6 Close ribbon shield.
- 7 Close rear unit.
- 8 Close printer top cover.
- 9 After you have changed the printer chain, a // IMAGE statement must be supplied to the system before any more jobs are run. Be sure the // IMAGE statement is in front of the OCL for the first job to be run after changing the chain. For more information on the IMAGE statement, see Appendix A.



- Magnetic Tape Unit Controls and Indicators
- Mounting a Reel
- Removing a Reel
- Replacing Tape Markers
- Cleaning the Tape Head
- Magnetic Tape Handling

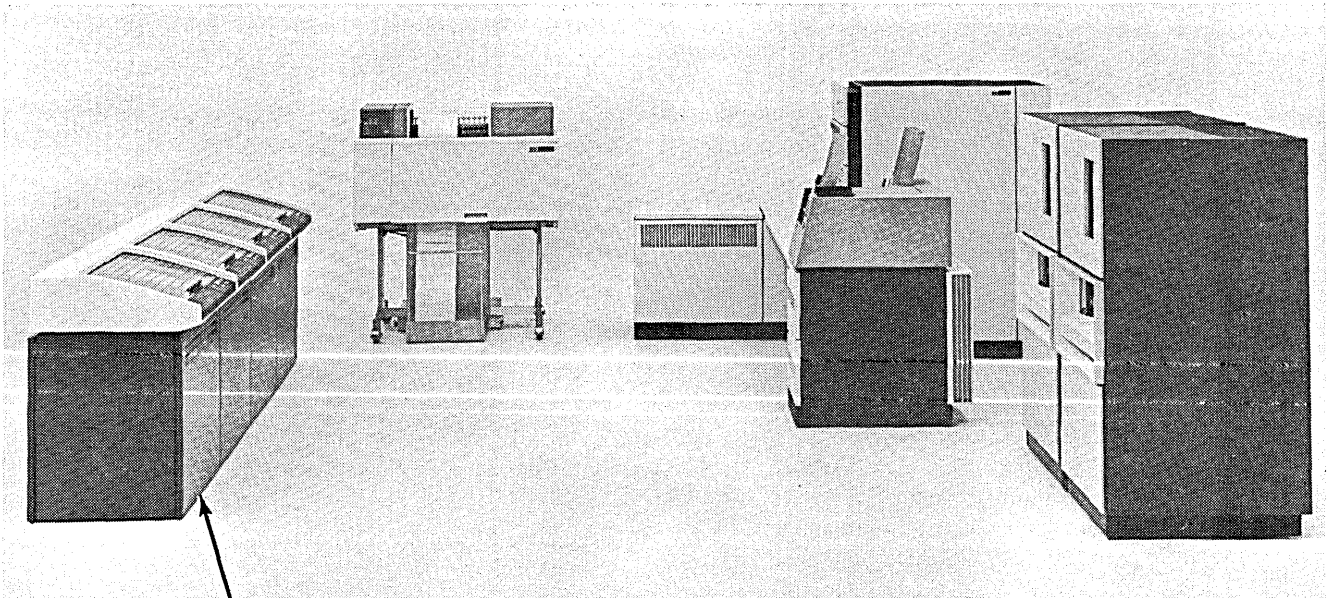

55301

3411 Magnetic Tape Unit and Control	3410 Magnetic Tape Unit	3410 Magnetic Tape Unit	3410 Magnetic Tape Unit
--	----------------------------------	----------------------------------	----------------------------------

## MAGNETIC TAPE UNIT CONTROLS AND INDICATORS

The operator's panel on the 3410 and 3411 Magnetic Tape Units contains the following keys and lights:

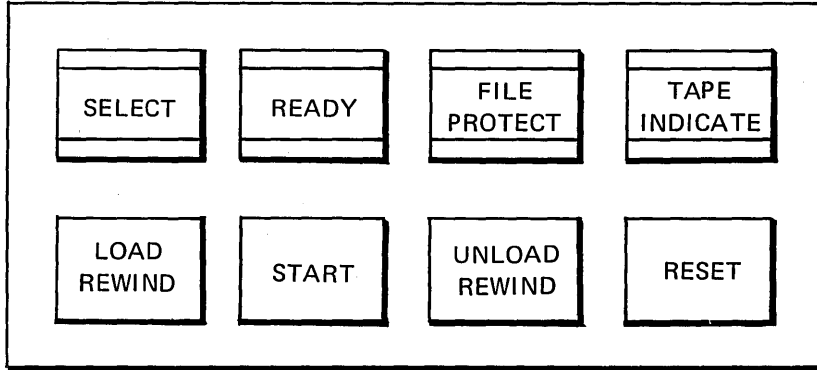

### Keys

**LOAD REWIND:** Press this key to load the tape into the vacuum columns and position the tape at the load point (see *Mounting a Reel*). If the tape has already been loaded, pressing this key rewinds tape to the load point.

**START:** Press this key to indicate that the tape unit is available for system operation. The **READY** light turns on; all keys except **RESET** are disabled. **START** may be pressed while tape reel is in motion.

**UNLOAD REWIND:** If the **READY** light is not on, press this key to rewind the tape to the load point and unload it (see *Removing a Reel*). If the **READY** light is on, press **RESET** before **UNLOAD REWIND**.

**RESET:** If tape unit is loaded and the **READY** light is on, press **RESET** to turn off **READY** and enable manual operation of the unit; then press **LOAD REWIND**, **START**, or **UNLOAD REWIND**, depending on the action you desire the unit to perform. If tape is rewinding, press **RESET** to stop rewinding. If tape unit is reading, writing, loading, or unloading, press **RESET** if you wish to unload the tape (then press **UNLOAD REWIND**).

### Lights

**SELECT:** The tape unit is under control of the tape control unit.

**READY:** The tape unit is available for operation with the tape control unit (columns are loaded, tape is not rewinding, and **START** key has been pressed). This does not necessarily mean the tape is positioned at load point.

**FILE PROTECT:** Indicates one of three conditions:

1. Loaded file reel does not have a write-enable ring; you cannot write on the tape or erase it.
2. No tape reel is mounted.
3. A load, rewind, or unload/rewind operation is in progress.

This light is turned off by mounting a reel which contains a write-enable ring.

**TAPE INDICATE:** The end-of-tape marker has been sensed during a forward operation. This light is turned off when the tape moves backward over the end-of-tape marker.

### MOUNTING A REEL

If system power is on and no tape reel is mounted on the unit, the **FILE PROTECT** light is on. Use the following procedure to mount a reel.

1. Raise the cover on the tape unit.



- 2 Select the reel to be mounted, as indicated on the program run sheet, and remove it from the case. Normally, the write-enable ring will not be present on the reel; therefore, if you want to do an erase or write operation you must insert the ring before mounting the reel.

- 3 Holding the reel with the write-enable ring groove away from you, mount the reel on the lefthand spindle and press down on the reel latch to lock it in place.

- 4 With your right hand, feed the tape through the slot at the top of the head cover.

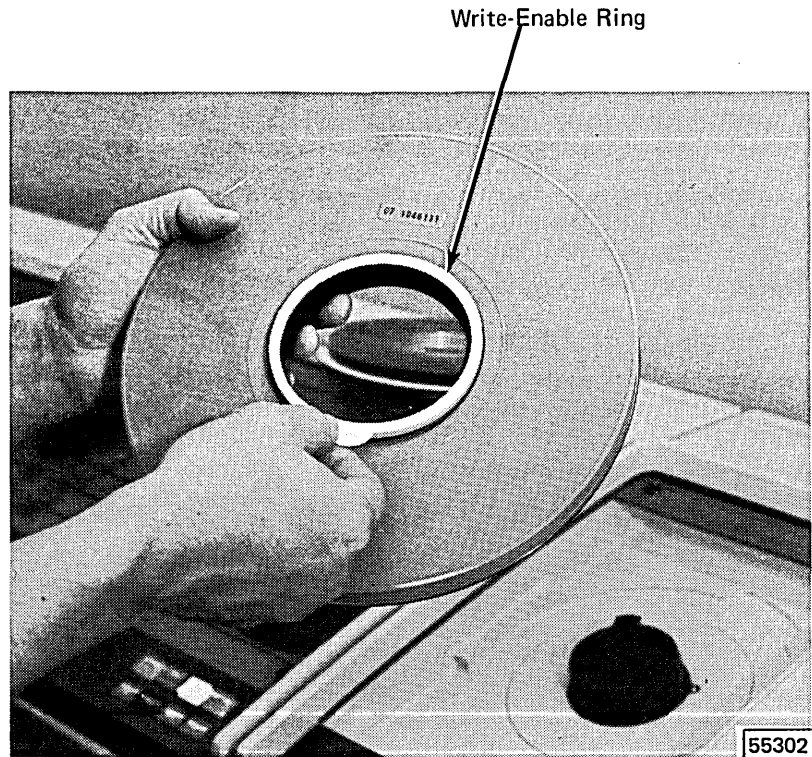

- 5 Place your finger about two inches from the end of the tape, holding the tape against the right-hand spindle. Rotate the spindle in a clockwise direction, allowing the free end of the tape to feed onto the reel.

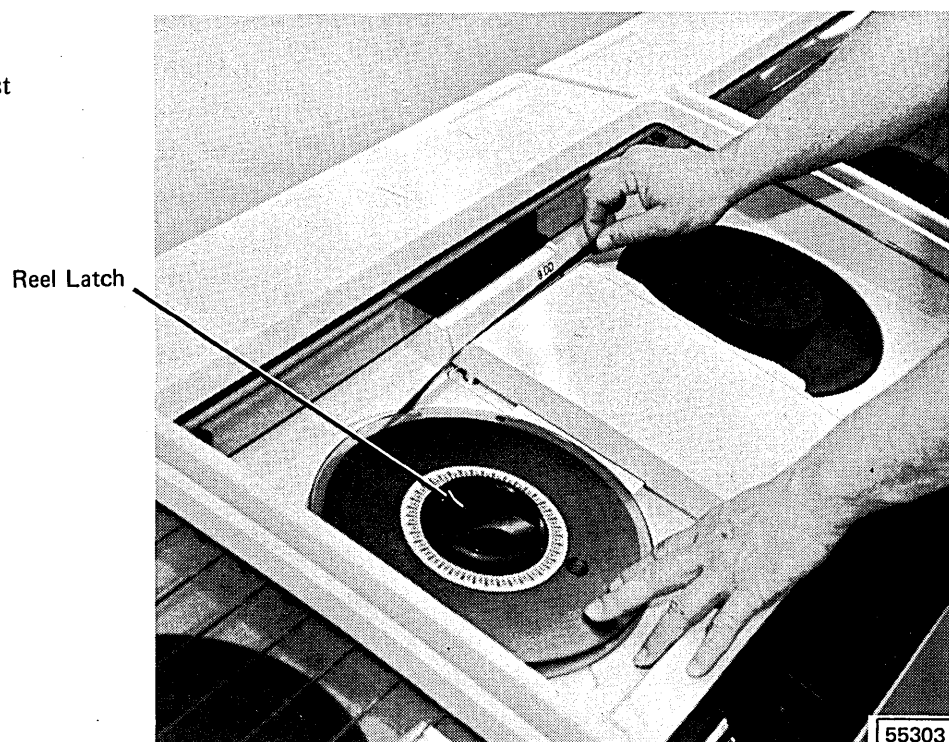

- 6 Wrap two or three turns of tape around the right-hand spindle; take up the slack. The load point marker should remain to the left of the read/write head.

*Note:* Ensure that you do not load tape beyond the load point marker (see *Replacing Tape Markers*). If you load the tape beyond the load point marker and then press LOAD REWIND, the tape unit may continue to search forward until it reaches the end of the tape. If this happens, push RESET to stop tape motion, then push LOAD REWIND; the tape will move backward until the load point is reached.



55304

- 7 Close the cover on the tape unit.
- 8 Press RESET.
- 9 Press LOAD REWIND. Tape is automatically fed to the tape heads and into the vacuum columns. The load point marker advances to the read/write head.
- 10 Press START. The READY LIGHT turns on.

*Note:* RESET, LOAD REWIND, and START may be pressed in succession without hesitating.

## REMOVING A REEL

- ① Press RESET.
- ② Press UNLOAD REWIND.  
The tape rewinds to the load point and is released from the vacuum column.
- ③ Raise the cover on the tape unit.
- ④ Unwind the remaining tape by rotating the tape reel in a counterclockwise direction.
- ⑤ Raise the reel latch.
- ⑥ While holding the loose end of the tape in place, lift the reel from the spindle.
- ⑦ Remove the write-enable ring, if present, and place the reel in the reel case.

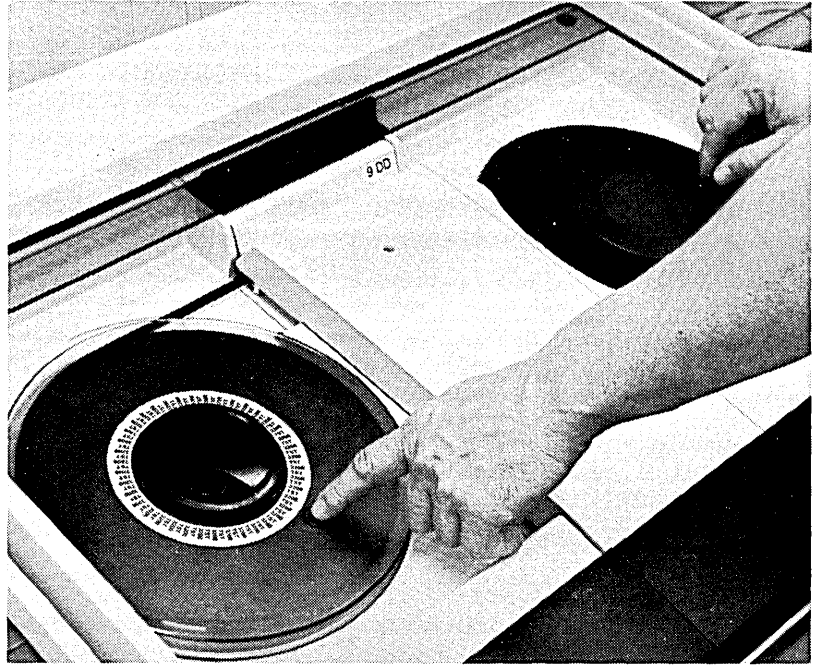

55205

## REPLACING TAPE MARKERS

A tape marker is a strip of transparent plastic with an aluminum coating covered by a pressure-sensitive adhesive. These markers are fastened to the uncoated (shiny) side of the tape.

Load Point Marker

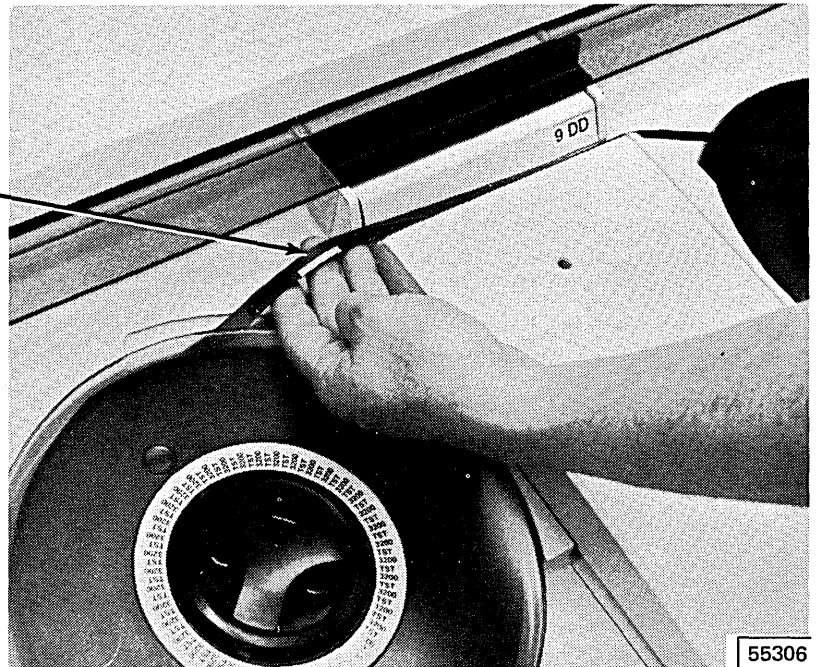

55306

EOT Marker

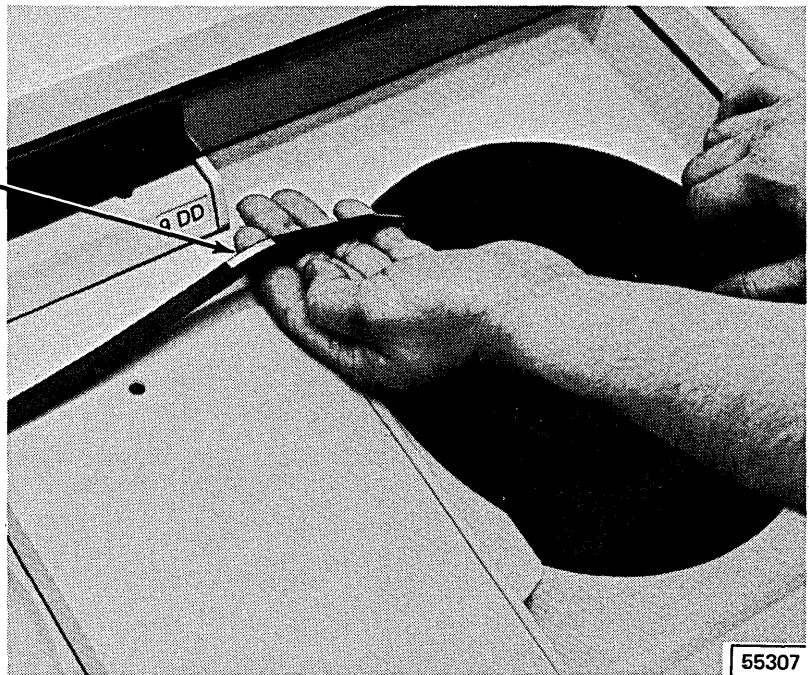

A load point marker is located approximately 10 feet from the beginning of the tape, on the edge of the tape which is nearest you when the reel is mounted. An end-of-tape (EOT) marker is located approximately 25 feet from the end of the tape, on the edge of the tape which is nearest the tape unit when the reel is mounted.

Photosensors on the tape unit detect the load point and EOT markers to determine the beginning and the end of the data on the tape. New reels of IBM magnetic tape are supplied with load point and EOT markers.

Occasionally, tape markers must be replaced. Most often, it is the load point marker which must be replaced, since the beginning of the tape is most susceptible to wear and damage. If the EOT marker is missing, the tape will probably be wound completely off of the reel (the unit stops in this case). It is best to replace markers while the tape is mounted on the tape unit to keep dust from collecting on the unrolled tape. Be sure to replace markers carefully, aligning them as described in the procedure that follows. Press new markers down firmly. If you wish to order tape markers, order Part Number 352407, Magnetic Tape Markers.

Replace the tape marker as follows:

- ① If the tape is damaged, cut off the end of the tape, including the old tape marker, if present.
- ② *Load Point Marker:* Unwind about 10 feet of tape (6-7 turns on the right-hand spindle).  
*EOT Marker:* Rewind about 25 feet of tape (about 15 turns on the left-hand spindle).
- ③ *Load Point Marker:* Place a tape marker on the side of the tape nearest you, parallel to and not more than 1/32 of an inch from the edge, but not overlapping the edge.  
*EOT Marker:* Place a tape marker on the side of the tape nearest the tape unit, parallel to and not more than 1/32 of an inch from the edge, but not overlapping the edge.

## CLEANING THE TAPE HEAD

If the tape unit is used daily, the tape head and vacuum columns should be cleaned at least once each day (more frequently, if the unit is used heavily). The following supplies are available from IBM for this purpose:

- IBM Tape Developer Medium and Tape Transport Cleaner, Part Number 453511
- 2108930 Cloth, Lint Free EC422702
- Swabs, Part Number 2754549

Clean the unit as follows:

- ① Open the head cover.
- ② Clean the vacuum columns using the cloth and swabs dampened with cleaning solution; pay particular attention to corners, which can be cleaned easily using a swab.
- ③ Clean the read/write and erase heads using a swab that has been dampened with cleaning solution.

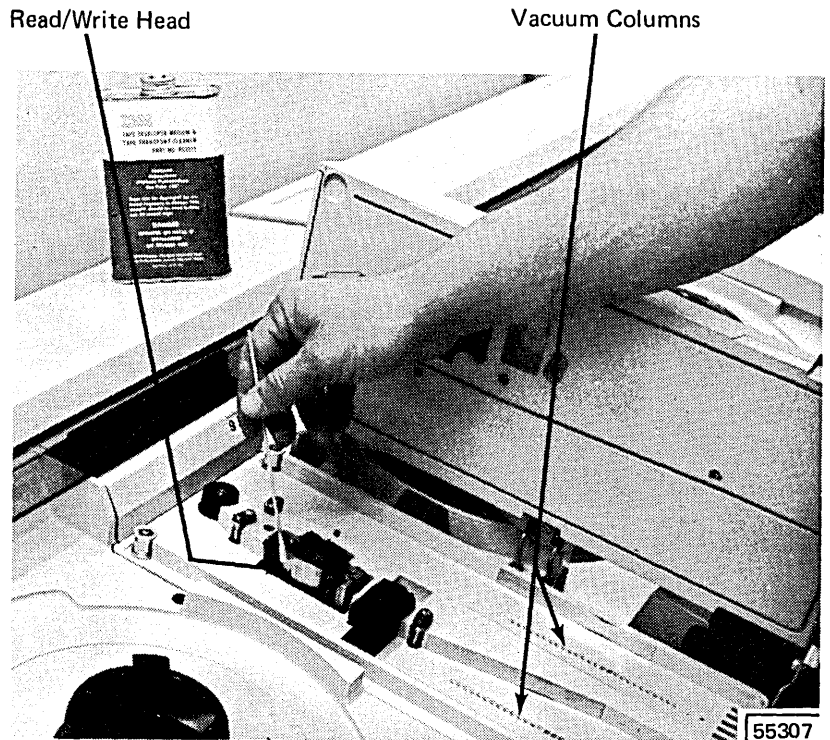

## MAGNETIC TAPE HANDLING

The following suggestions are offered to help you ensure maximum performance of your magnetic tape and tape units:

Clean tape units frequently, particularly the read/write head and vacuum columns. This prevents accumulation of dust and dirt which can interfere with contact between the tape and the read/write head.

Floors, ceilings, walls, draperies, and furnishings in the machine room should be composed of materials which are easy to clean, do not flake, and are free of lint and static.

- Store reel containers where they will not be exposed to dust.
- When a reel of tape is removed from the unit, always place it immediately in a container.
- Do not smoke near tape or tape units, since ashes can contaminate or burn tape.

- Use care in handling tape reels, since dropping or mishandling can damage the tape or the reel.
- To clean the magnetic tape, wipe it gently with a lint-free cloth which has been dampened with tape transport cleaner (see *Cleaning the Tape Head* for available products).
- Inspect reel containers periodically for dust or dirt.
- Do not expose magnetic tape to magnetism.
- If a roll of tape is dropped, inspect it immediately. If the reel is undamaged, thoroughly clean the exposed tape and rewind it on a good reel. If you feel the tape may be damaged, you should thoroughly clean it and attempt to check the data through a tape-to-printer job (using an RPG II program) or other operation.
- Do not grasp the tape reel at the outer edges, as the tape itself may be pinched and thereby damaged.
- Do not turn system power off until all tapes have been rewound and unloaded.



Chapter 6. IBM 5440 Disk Cartridge and IBM 5444 Disk Storage Drive

- Mounting a 5440 Disk Cartridge
- Removing a 5440 Disk Cartridge

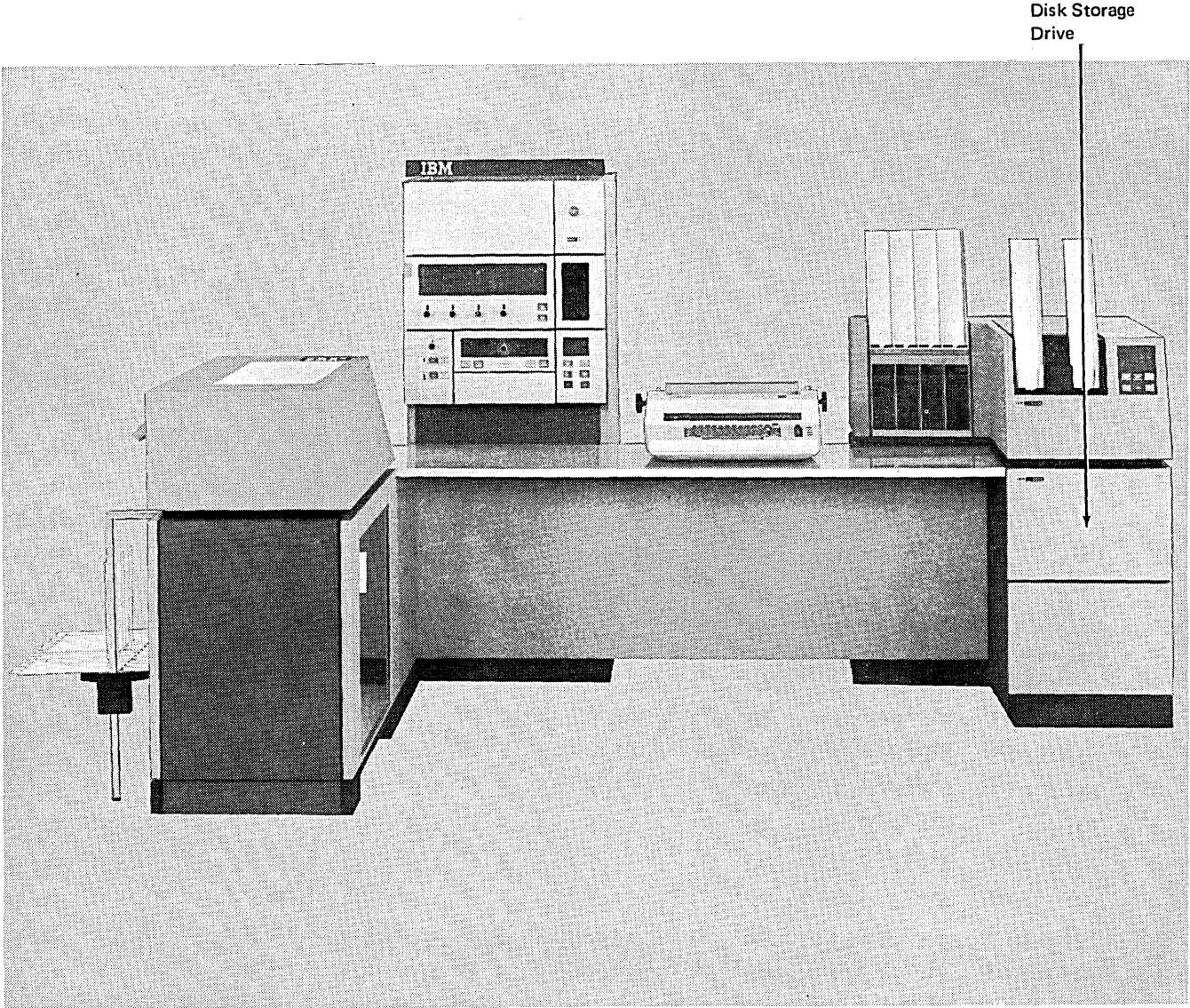

55239A

## **MOUNTING A 5440 DISK CARTRIDGE**

The following procedures are for mounting a cartridge. If a cartridge is on the disk drive, remove it before placing a new cartridge on the disk drive. Follow the procedures later in this chapter for removing a cartridge.

The cartridge to be used by the system should be in the environment in which it is to be used for at least three hours. This ensures the disk cartridge can be used properly by System/3. A cartridge should always be on the disk drive when the system is not in use. This keeps dust from entering the drive.



- 1 Check for the following conditions before mounting a cartridge:
- Disk panel START/STOP switch for the drive you are loading (R1 or R2) in the STOP position.
  - Disk panel OPEN light lit.
  - Disk storage drawer slid out.
  - Clamp arms extended out.

2 Select the cartridge to be mounted as indicated on the program run sheet.

3 Slide the release button to the left.

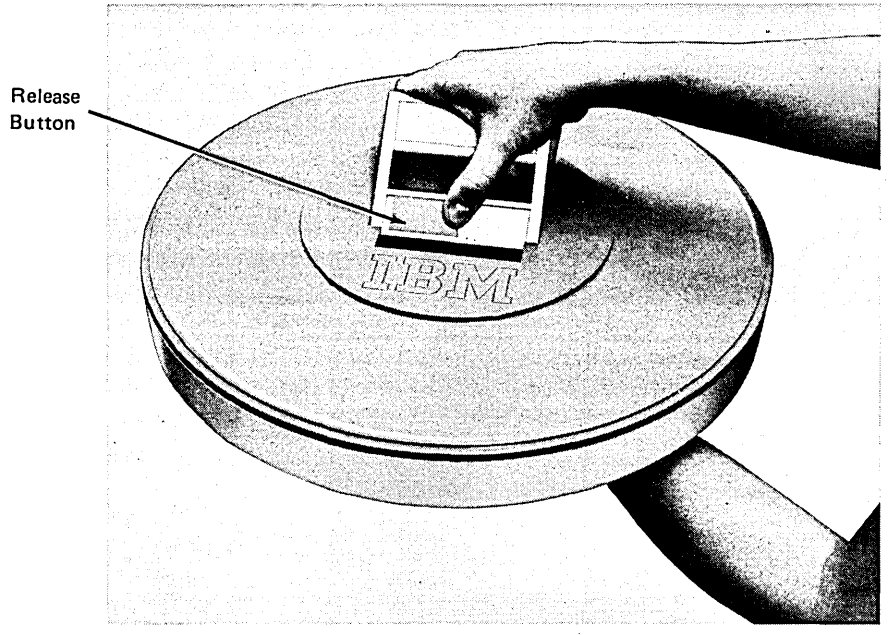

55231

4 With one hand under the bottom cover of the cartridge to catch the cover, raise the carrying handle to the upright position.

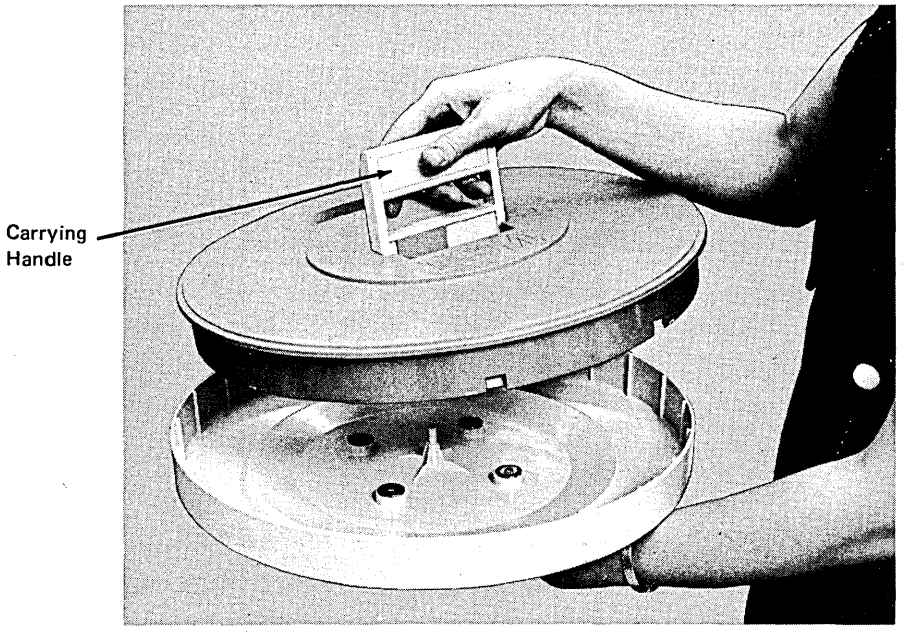

55232

**5** With the IBM label pointed toward the front of the disk storage drawer, mount the cartridge by lowering it on the disk drive.

**6** Release the carrying handle. It should be flush with the cartridge.

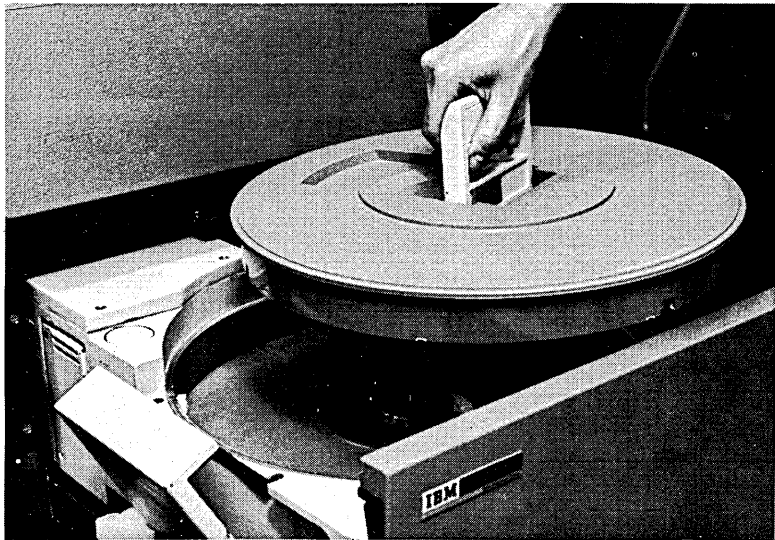

55233

**7** Invert the bottom cover and place it on top of the cartridge.



55234

- 8 Bring in the clamp arms over the cartridge.
- 9 Slide the disk storage drawer all the way in. The cartridge is now mounted and can be made ready for use by performing the following step.

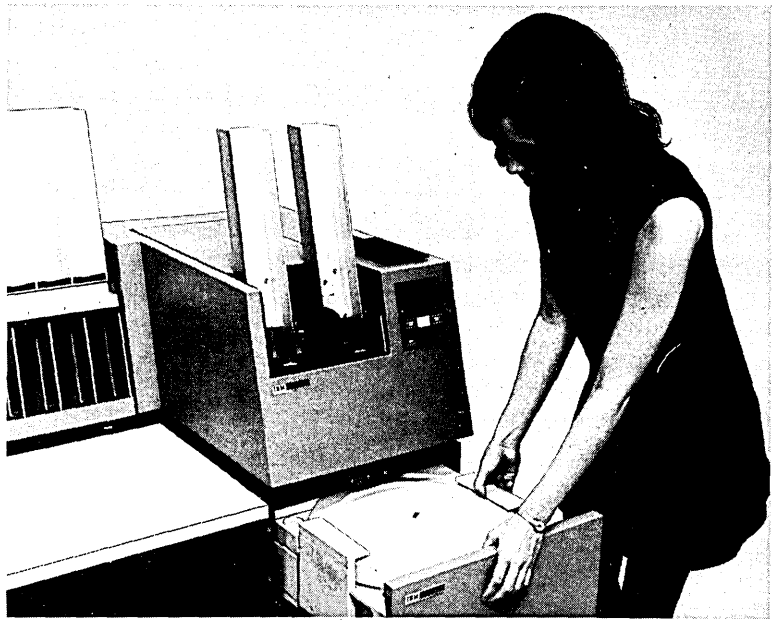

55235

- 10 Set the disk panel START/STOP switch, for the drive you are using, at START. The OPEN light turns off. The READY light is lit when the disk is up to speed. There is approximately a two-minute delay from the time you set the START/STOP switch at START until the READY light is lit. When the READY light is lit, the system can use the disks on the drive.

## REMOVING 5440 DISK CARTRIDGE

- 1 Set disk panel START/STOP switch at STOP for the cartridge to be dismantled (R1 or R2).  
*Note:* The disk storage drawer cannot be opened until the OPEN light for the selected disk (1 or 2) is lit.
- 2 When disk panel OPEN light is lit (READY light is off), squeeze drawer release lever and slide disk storage drawer out until it stops.

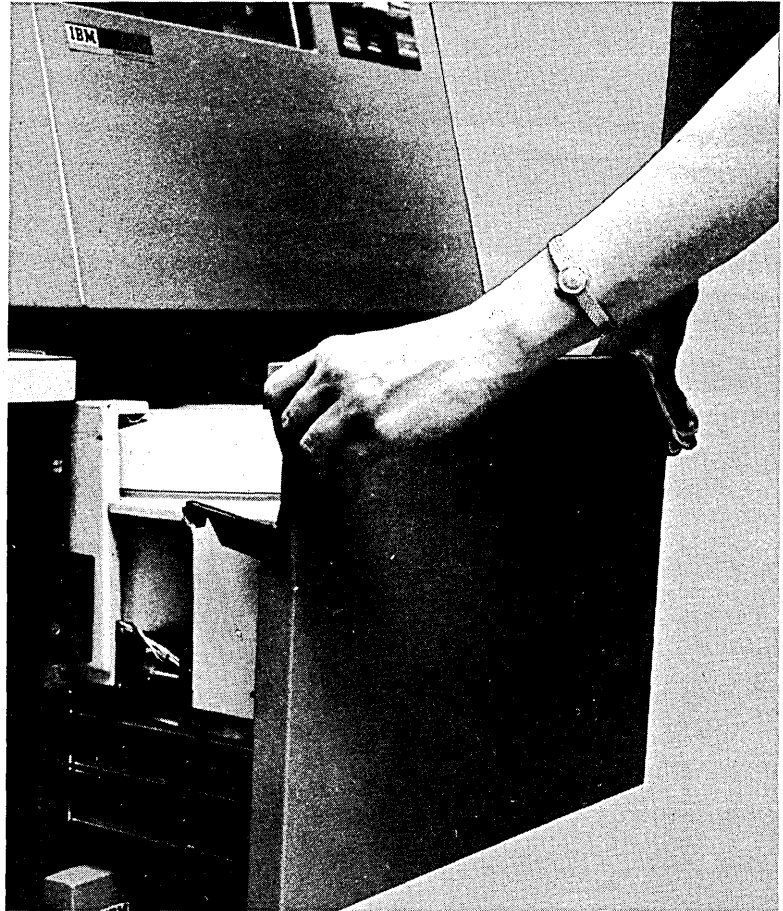

55236

3

Pull both clamp arms outward.



55237

Clamp Arms

- 4 Lift bottom cover off of cartridge.



55234

- 5 Push release button to left and raise carrying handle to release cartridge from disk drive.



55238

- 6 Lift cartridge from disk drive.



55233

Disk Drive

- 7 Invert bottom cover of cartridge and place it back on cartridge. Lower carrying handle until it is flush with cartridge. This locks bottom cover on cartridge.

- 8 Store cartridge.

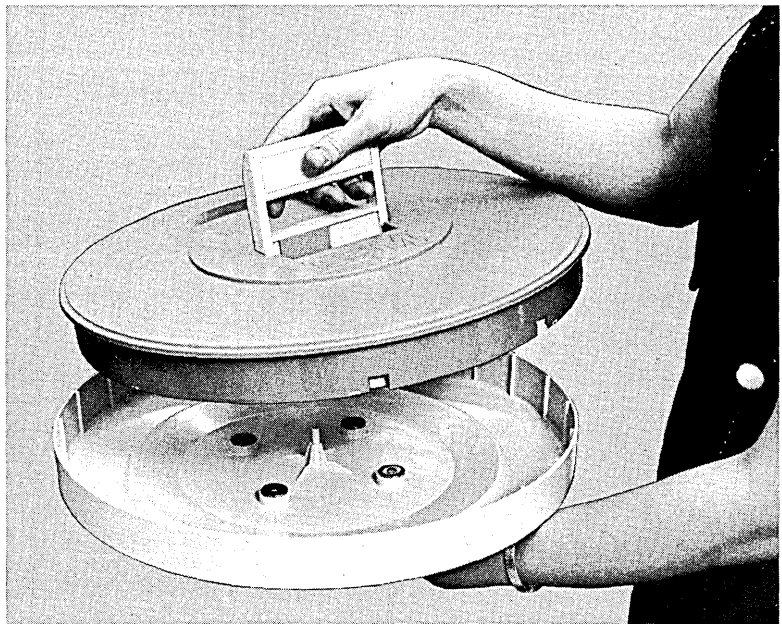

55232





## Chapter 7. IBM 2316 Disk Cartridge and IBM 5445 Disk Storage Drive

- Disk Controls and Indicators
- How to Mount a 2316 Disk Cartridge
- How to Remove a 2316 Disk Cartridge

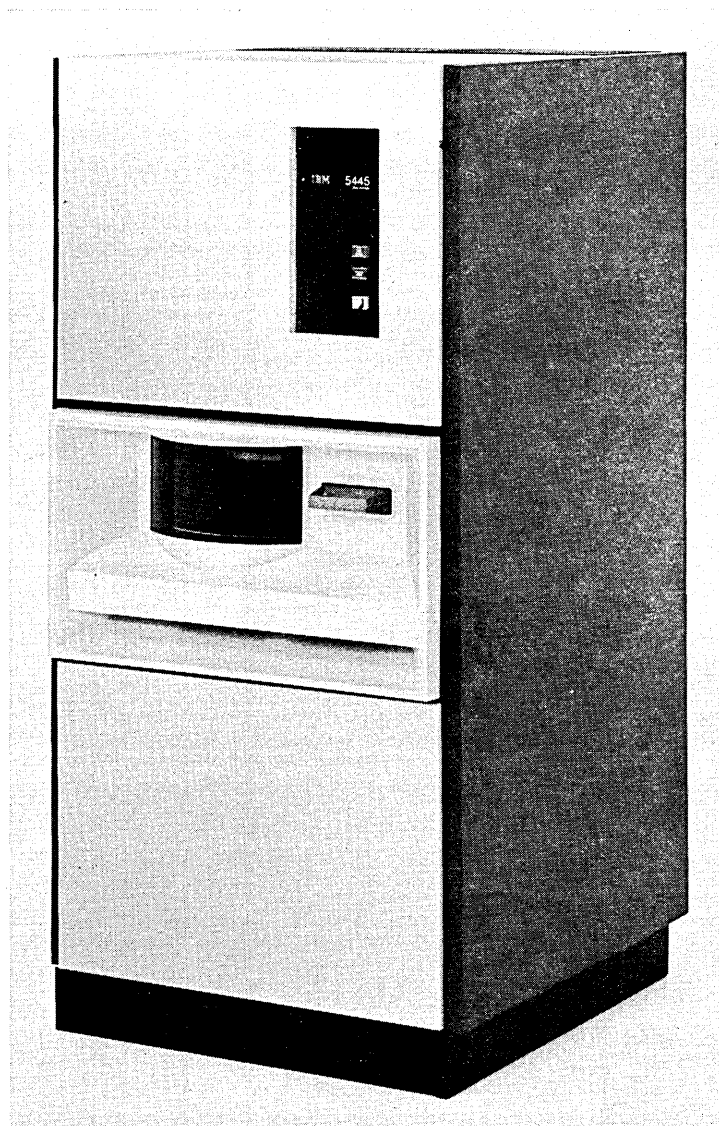

55290

## DISK CONTROLS AND INDICATORS

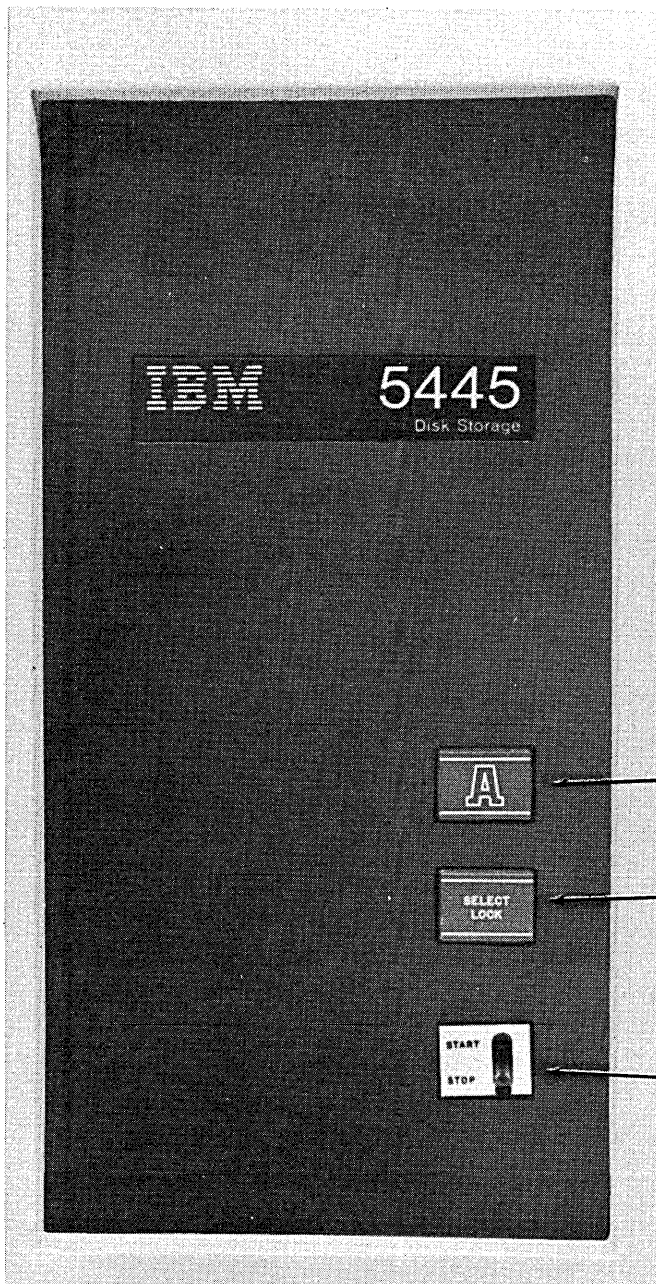

*READY Light:* This light comes on when the 5445 disk drive is ready for use.

*SELECT/LOCK Light:* This light comes on when a halt has occurred in the program being processed or when the 5445 disk storage drive is malfunctioning.

*START/STOP switch:* This switch turns the disk drive power on or off when the system power is on. With the switch at STOP, the drawer can be opened and the disk can be replaced.

55291

## MOUNTING A 2316 DISK CARTRIDGE

The following procedures are for mounting a cartridge. If a cartridge is on the disk drive, remove it before placing a new cartridge on the disk drive. Follow the procedures later in this chapter for removing a cartridge.

The cartridge to be used by the system should be in the environment in which it is to be used for at least three hours. This ensures the disk cartridge can be used properly by System/3.

A cartridge should always be on the disk drive when the system is not in use. This keeps dust from entering the drive.

- 1 Set START/STOP switch at STOP and wait until the disk drive stops.

- 2 Lift drawer handle and slide disk storage drawer open.

- 3 Select the cartridge to be mounted as indicated on the program run sheet.



55292

4

Remove the bottom cover of the disk cartridge by holding the top cover handle with one hand and turning the bottom cover handle counterclockwise with the other.

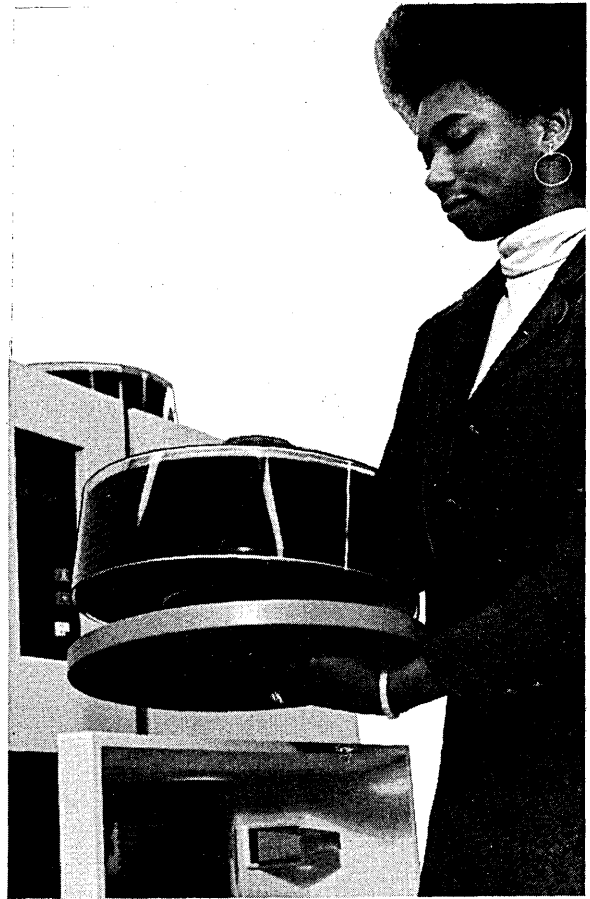

55293

5

Lower the cartridge on the disk drive.



55294

6

Turn the top cover handle clockwise until the handle is tight.

- 7 Lift off top cover.



55295

- 8 Slide the disk storage drawer closed.
- 9 Set the START/STOP switch to START. Within two minutes the green READY light comes on and the disk can be used.

#### REMOVING A 2316 DISK CARTRIDGE

- 1 Set START/STOP switch at STOP and wait until the disk drive stops.
- 2 Lift drawer handle and slide disk storage drawer out.

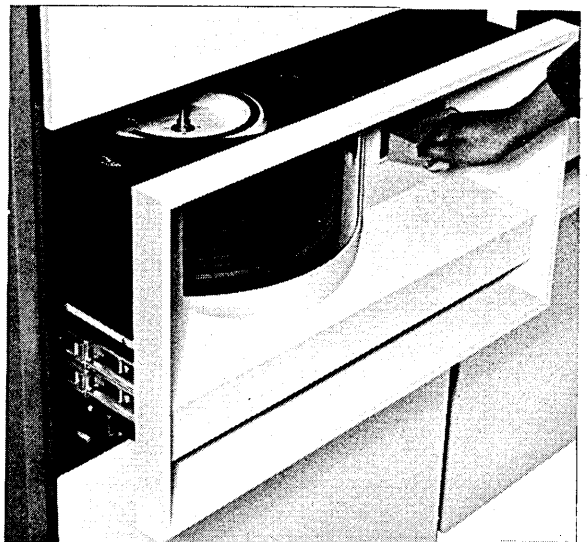

55296

3

Place the top cover on the cartridge.



55295

4

Turn top cover handle counter-clockwise until a clicking sound is heard.

5

Lift cartridge from disk drive.



55294



- 6 Place bottom cover on cartridge and turn bottom cover handle until handle will not turn.



55297

- 7 Store cartridge.



- Use of the Printer-Keyboards
- Removing the Typeball
- Replacing the Typeball
- Adjusting the Impression Selector
- Removing the Fabric Ribbon Cartridge
- Installing a Fabric Ribbon Cartridge
- Placing Forms in the Printer-Keyboards

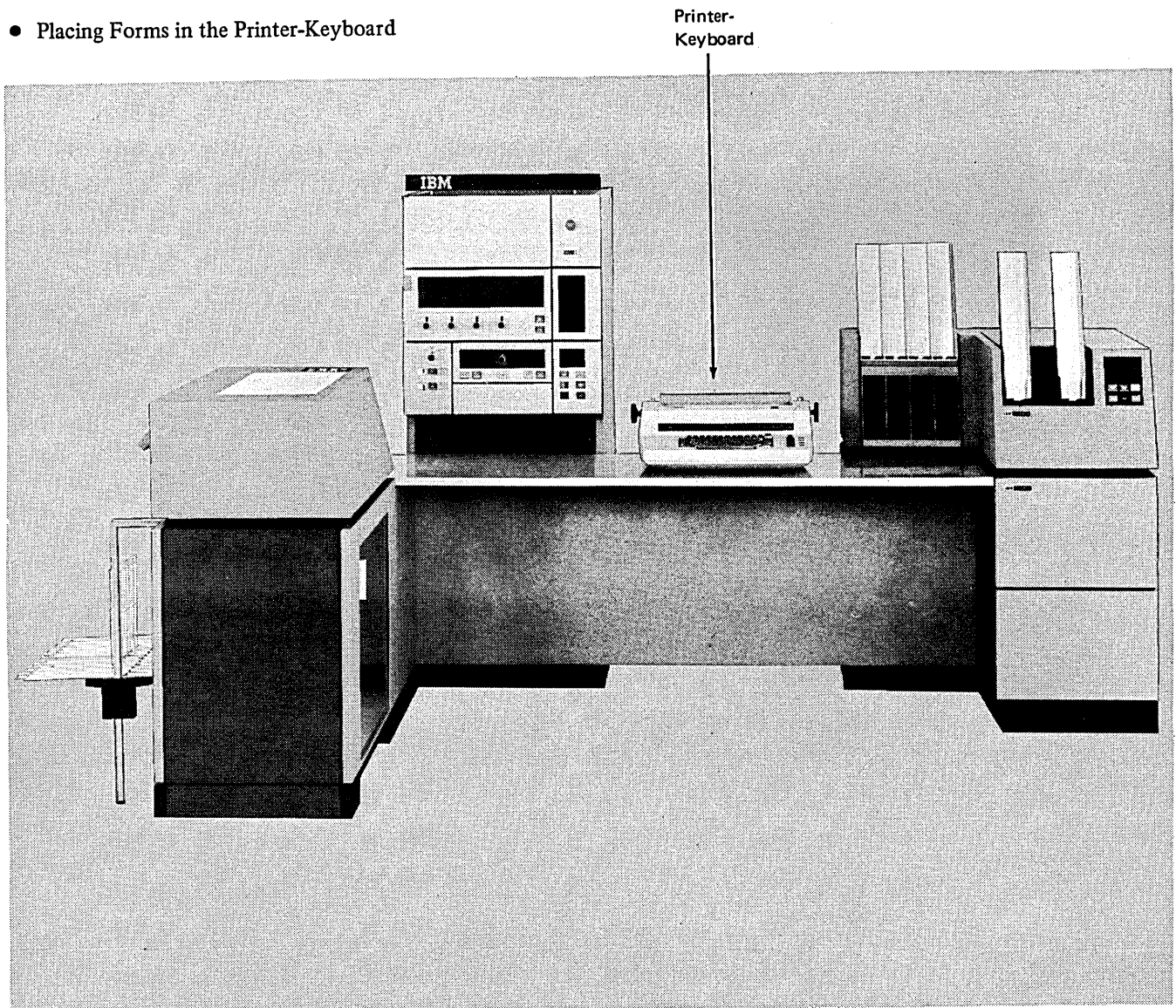

55239A

### USE OF THE PRINTER-KEYBOARD

The printer-keyboard (Figure 12) is an optional device for System/3 and consists of the printer and keyboard connected to the system processing unit. With the printer-keyboard, you can:

1. Request information from a disk file.
2. Print out requested information.
3. Enter data directly into the system.
4. Print out OCL statements and error codes for a program by using the printer-keyboard as a logging device.
5. Interrupt a program (if inquiry has been specified) by pressing the REQ key. You will be told when to do this on the program run sheet.

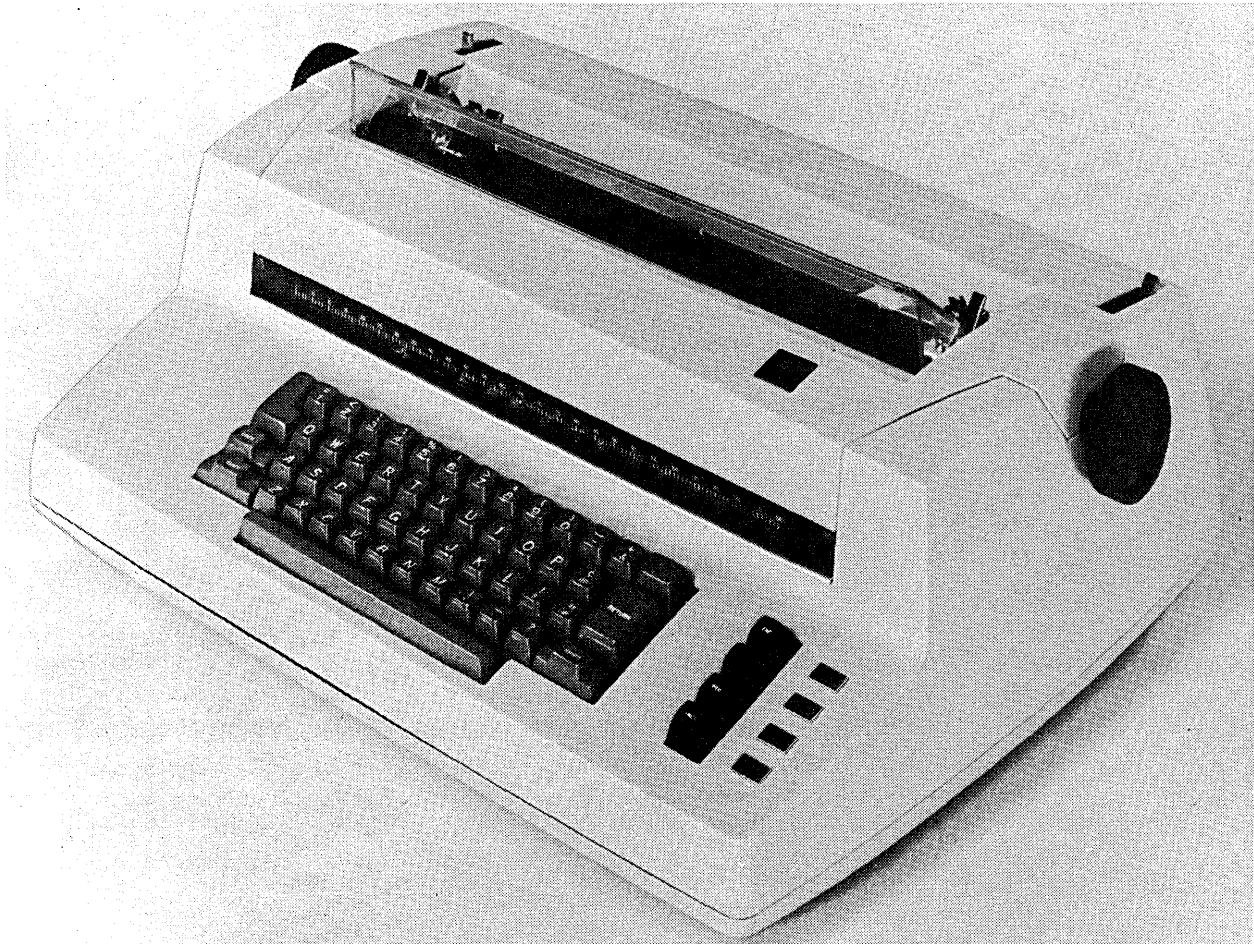

Figure 12. Printer - Keyboard

53297

**Keys**

Figure 13 shows the keyboard. The shaded keys are function keys; the other keys are data keys.

**LOCK:** This key locks the shift in the uppercase mode.

**SHIFT (one on each side of the keyboard):** This key allows you to key uppercase characters.

**SPACE:** This bar allows you to enter blanks.

**RETURN:** This key causes the carrier to return.

**END:** This key is pressed when you have keyed in the OCL statement or data. It tells the system that you are through with the line (OCL statement or data).

**REQ (Request):** This key allows you to interrupt a program if the program can be interrupted. If the request to interrupt the program is not allowed, the request is ignored.

**CANCEL:** This key is used to cancel the current line you keyed. (Used when you hit a wrong key.)

**Lights**

**REQUEST PENDING:** This light comes on when you press the REQ key. It means that the program you are trying to interrupt will not allow it at this time. The light is off when the request to interrupt the program is allowed.

**PROCEED:** When this light comes on, you can key OCL statements or data.

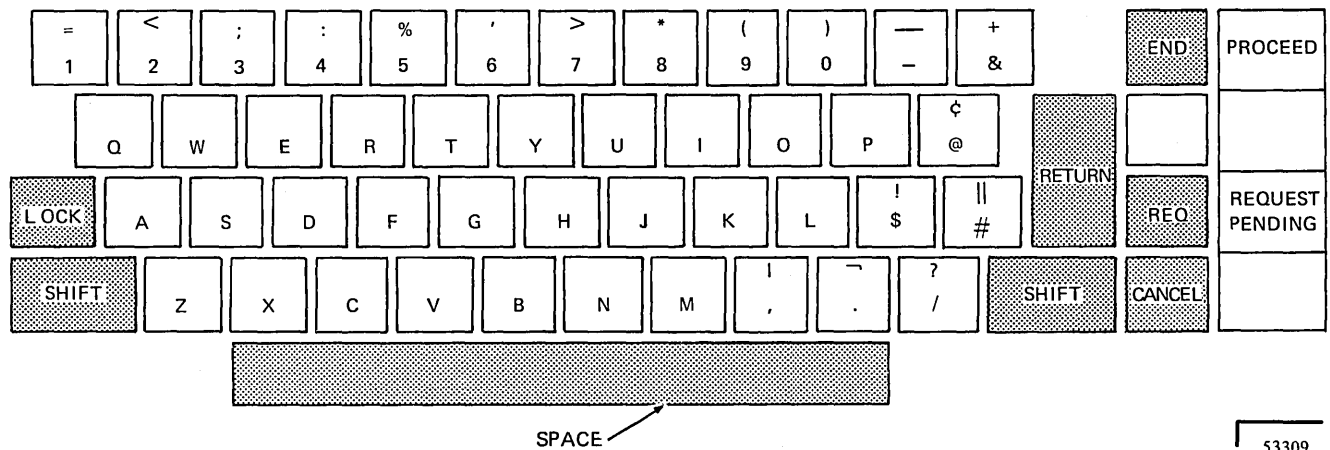
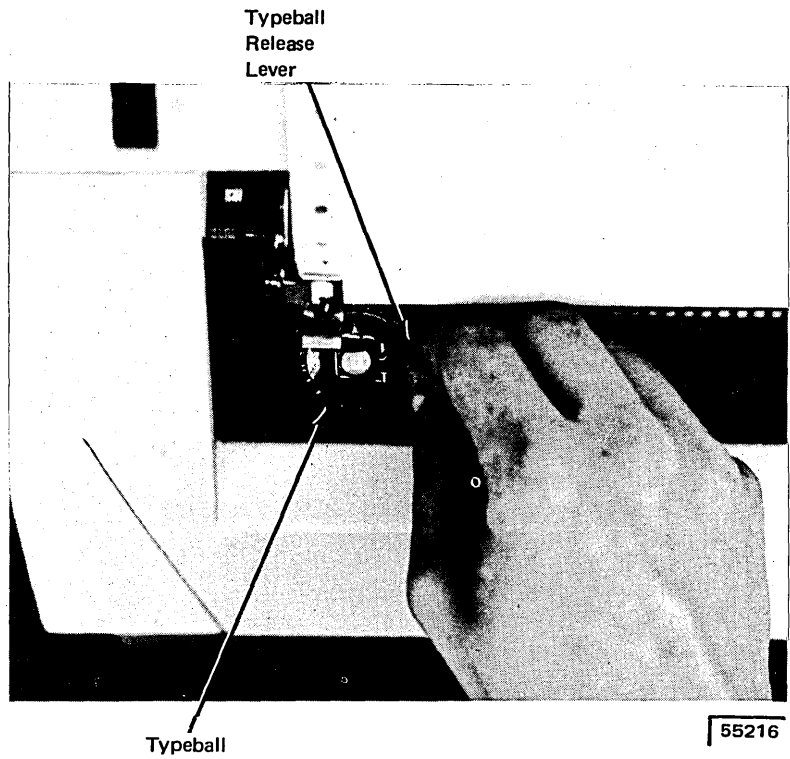

Figure 13. Keyboard

## REMOVING THE TYPEBALL

- 1 Lift the typeball release lever until the lever clicks into position.
- 2 Remove the typeball by lifting it off of the typeball post.



## REPLACING THE TYPEBALL

- 1 Lift the typeball release lever until it clicks into position.
- 2 Place the typeball on the typeball post with the triangle facing directly away from you.
- 3 Close the lever. Avoid using force.

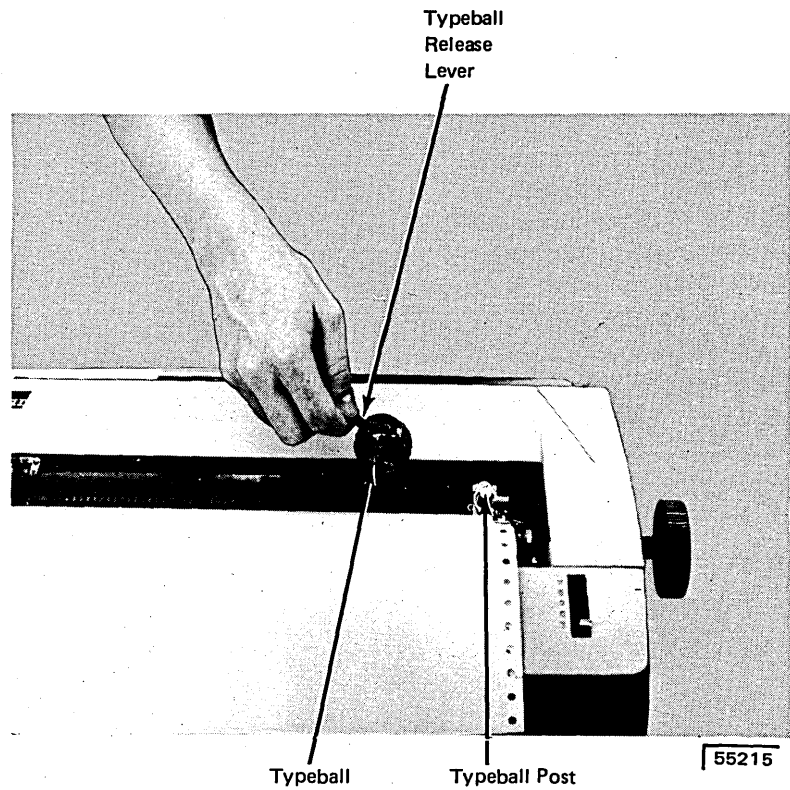

## ADJUSTING THE IMPRESSION SELECTOR

The impression selector on the right side of the typeball enables you to adjust the striking force of the typeball. Numbers on the impression selector range from one to five. Position 1 has the lightest striking force and position 5 has the hardest.

- 1 To change the setting, push the lever to the right and slide it either forward or backward to the desired number.

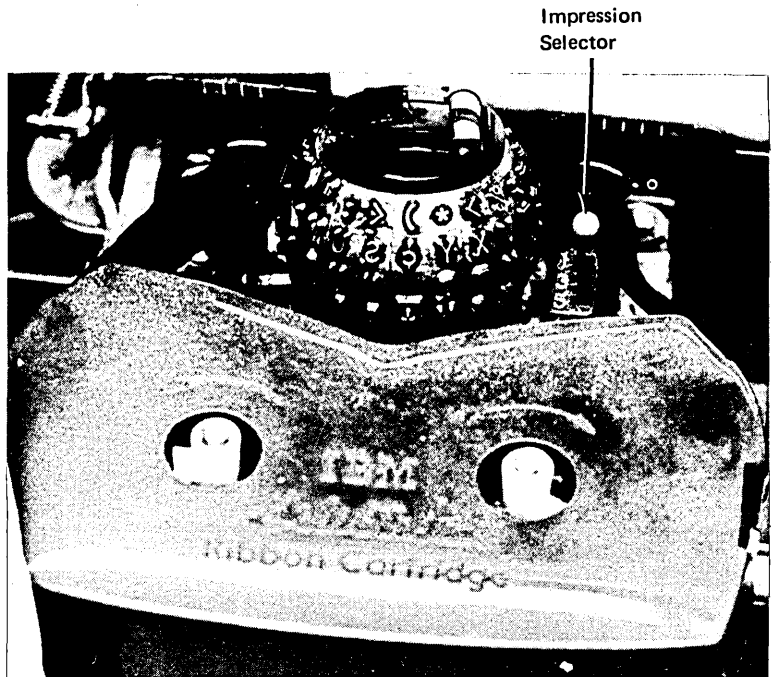

55214

- 2 When the impression selector is adjusted to increase the striking force of the typeball, the multiple copy control must also be moved the same number of positions away from you. When the impression selector is adjusted to decrease the striking force of the typeball, the multiple copy control must also be moved the same number of positions towards you.

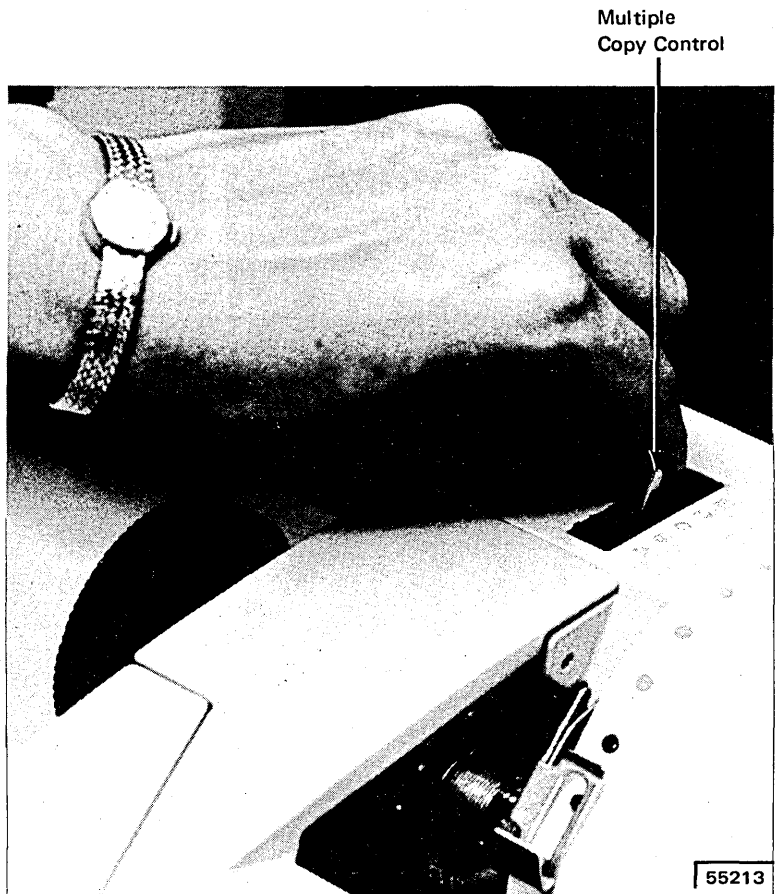

55213



## REMOVING THE FABRIC RIBBON CARTRIDGE

- 1 Lift the front cover.
- 2 Move the ribbon change lever to the right. This will raise the ribbon lifts for easier removal of the ribbon.

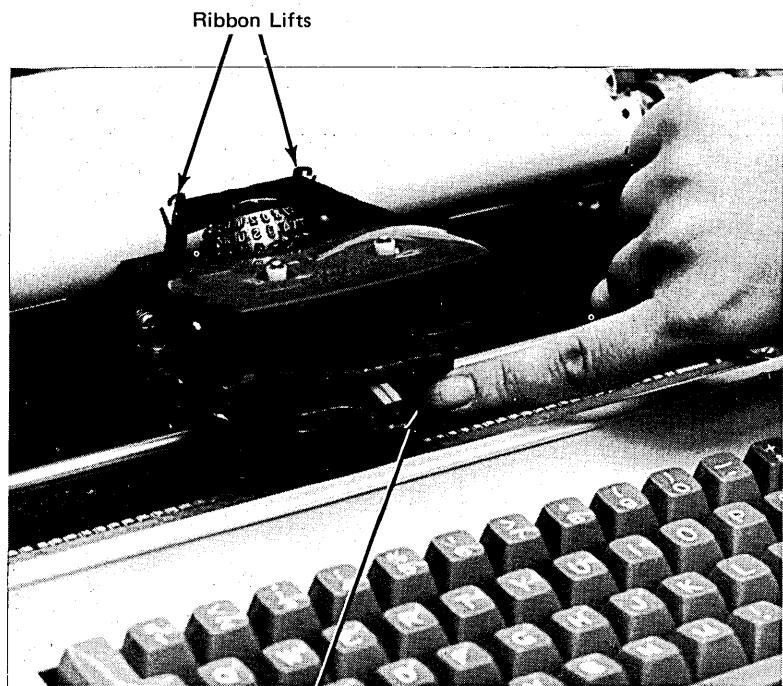

Ribbon Lifts  
Ribbon Change Lever

55219

- 3 Lift the cartridge upward and off the ribbon cartridge spindles.
- 4 Ease the ribbon out of the slots in the ribbon lifts.
- 5 To rewind excess ribbon, insert a pencil in either of the holes in the cartridge and turn in the direction of the arrow.

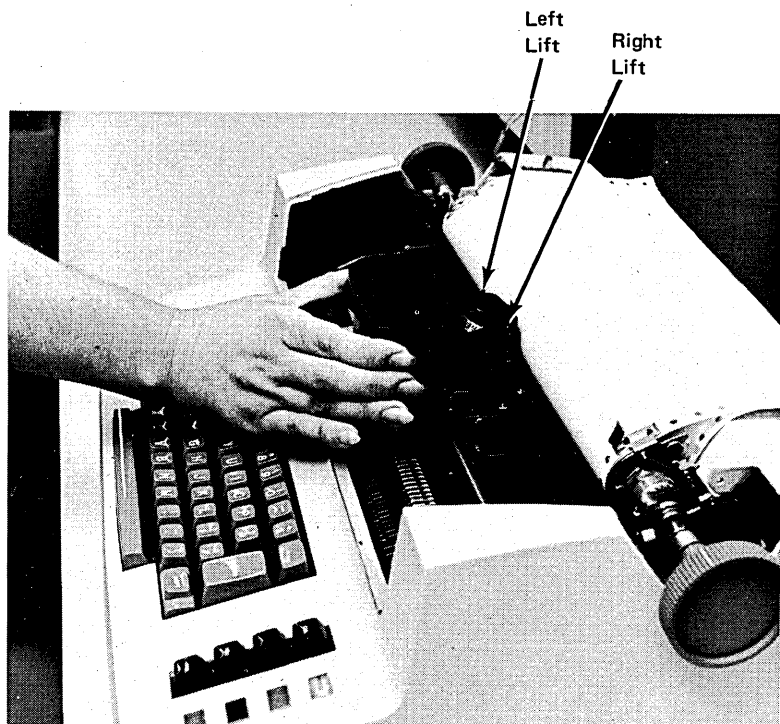

Left Lift  
Right Lift

55217

## INSTALLING A FABRIC RIBBON CARTRIDGE

- 1 Lift the front cover.
- 2 Make sure the ribbon change lever is all the way to the right.

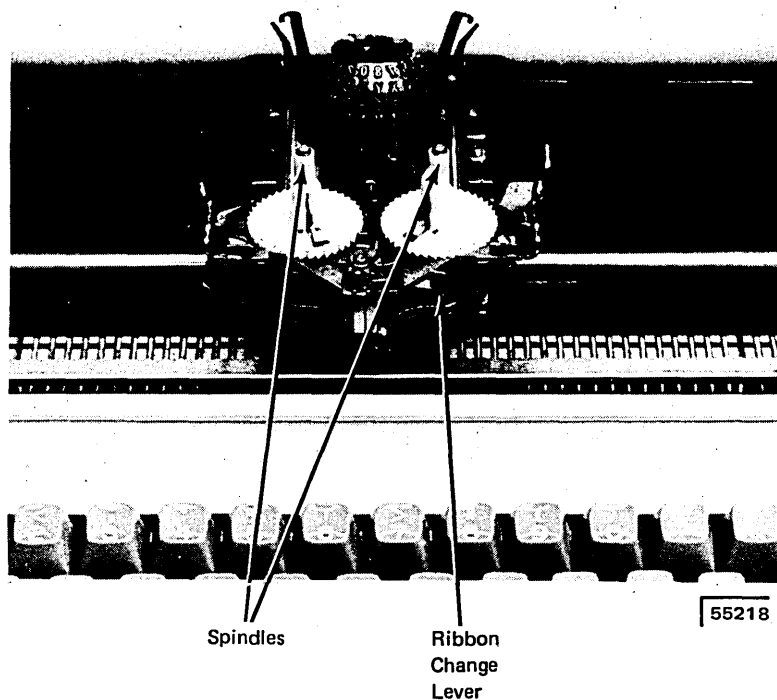

- 3 Position the cartridge in front of the ribbon lifts.
- 4 Slide the ribbon through the right ribbon lift.
- 5 Slide the ribbon down behind the typeball and through the left ribbon lift.
- 6 Place the cartridge on the ribbon spindles and press down evenly and firmly.

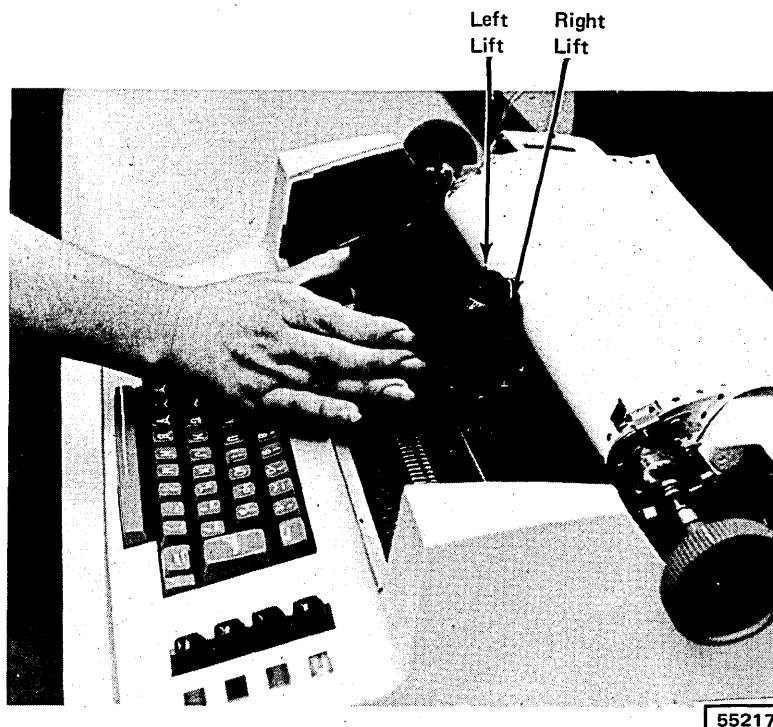

8

Move the ribbon change lever back to the left. This will lower the ribbon into typing position.

9

To rewind excess ribbon, turn either spindle in the direction of the arrow.

10

Close the cover.

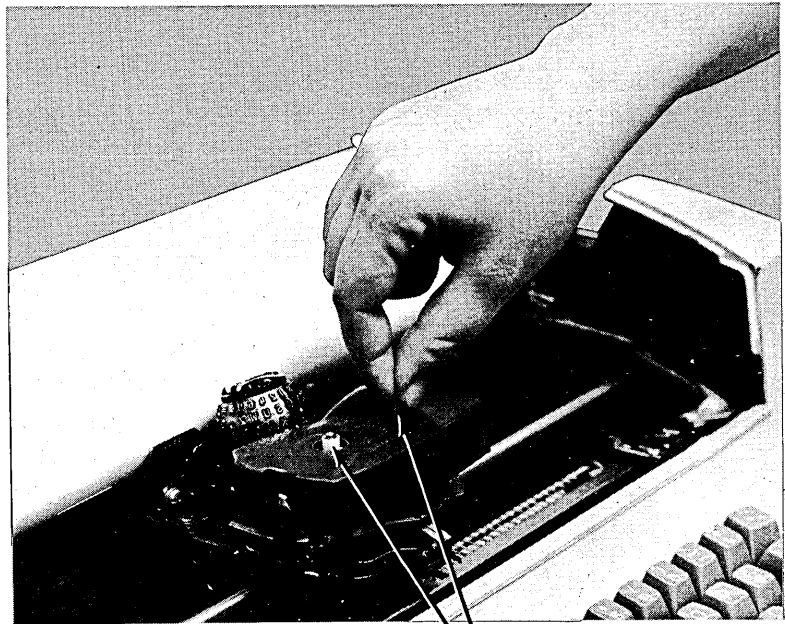

Spindles

This is the way the fabric ribbon cartridge will look when it is correctly inserted and ready for use. The arrows indicate the direction in which the ribbon can move.

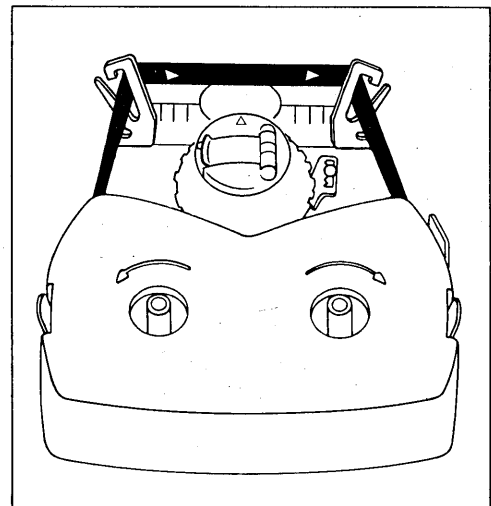

## PLACING FORMS IN THE PRINTER-KEYBOARD

- ① Move forms release lever forward.
- ② Raise bail.
- ③ Lift paper clamps on both sides of the platen.
- ④ Insert forms behind platen and push through until the forms appear on the side of the platen nearest you.

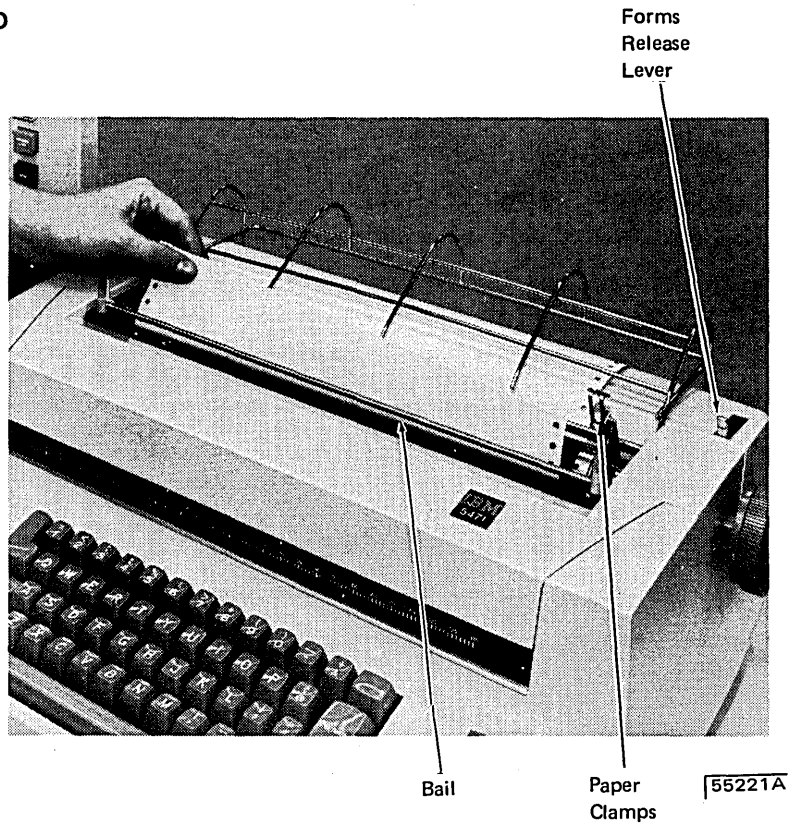

- ⑤ Align forms and place holes in forms onto the pin wheels.
- ⑥ Lower paper clamps.
- ⑦ Lower bail
- ⑧ Push forms release lever back.

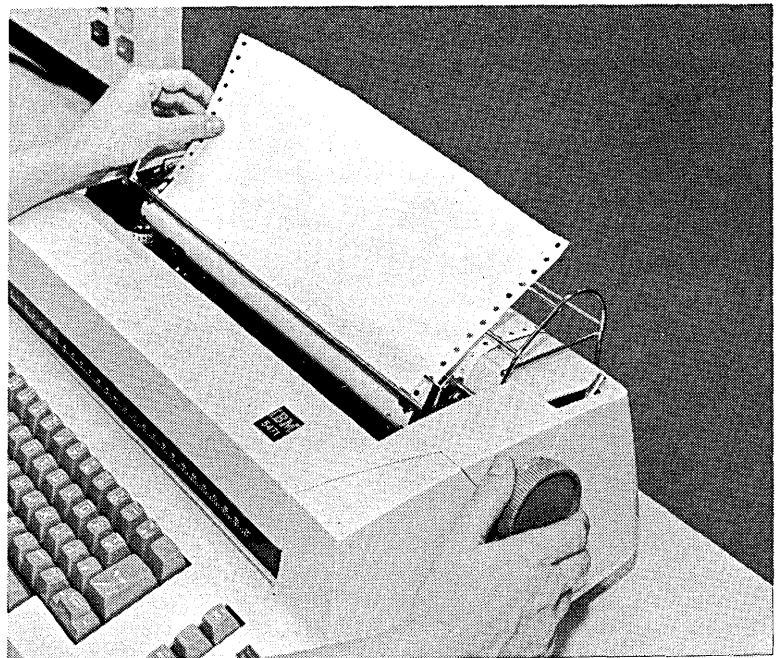



## Chapter 9. IBM 1442 Card Read Punch

- 1442 Controls and Indicators
- Clearing a Card Jam
- 1442 Power On and Ready Procedures
- 1442 Last Card Procedures

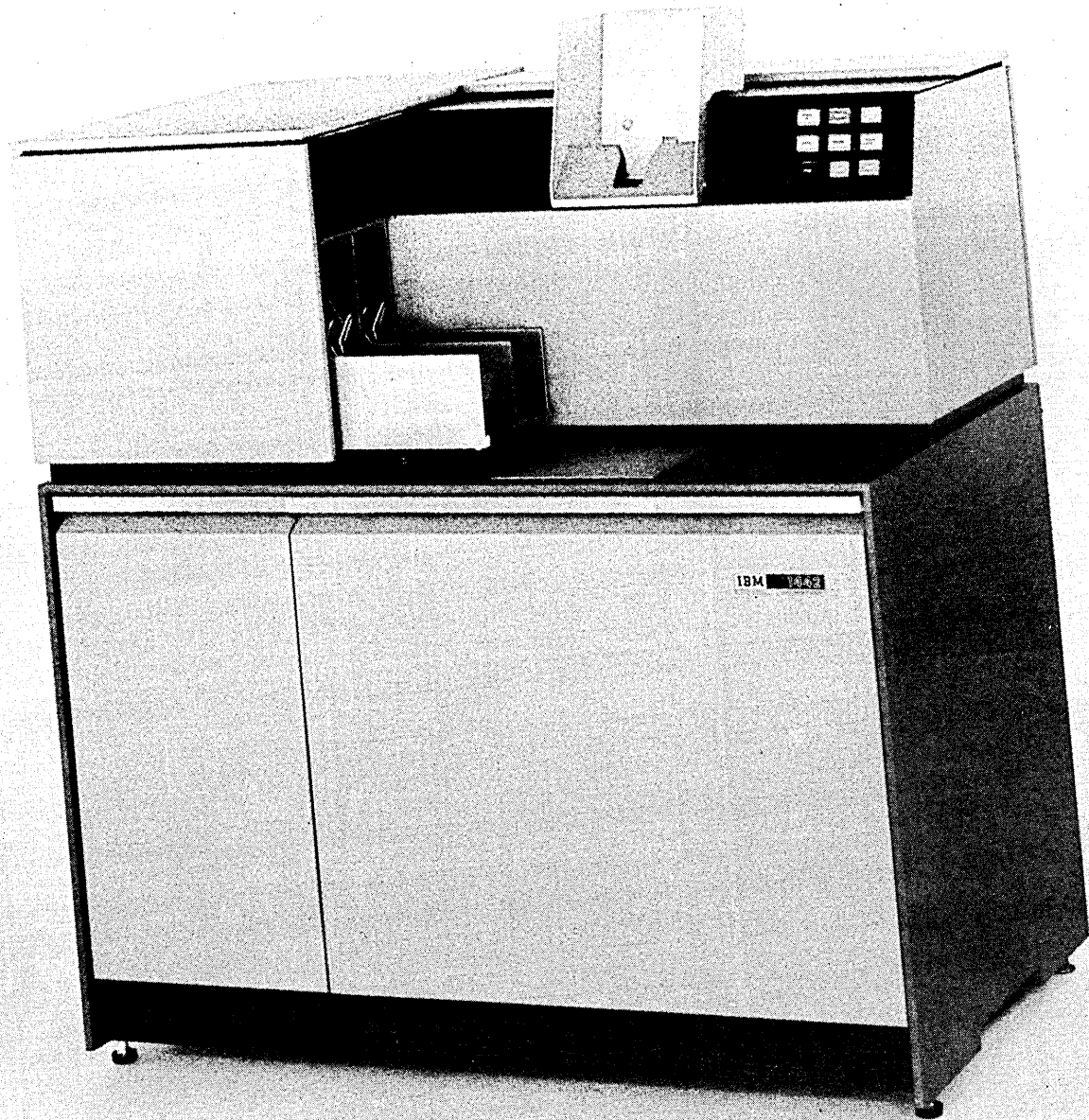

152298

## 1442 CONTROLS AND INDICATORS

All of the 1442 controls and indicators are on a single panel to the right of the card hopper. Eight of the indicators are on a backlit panel.

### Keys

The operator's panel (Figure 14) contains three keys:

**START Key:** Pressing the START key places the 1442 in a ready status if the following conditions are met:

1. System power on.
2. Cards in the hopper. One card is fed and registered at the pre-read station when the START key is pressed.
3. 1442 CHECK light off.
4. Stacker not full.
5. Chip box properly positioned and not full.
6. 1442 covers closed (after card jam removed).

The START key is also used to return the 1442 to a ready status after 1442 STOP has been pressed and to indicate the last card sequence.

**STOP Key:** Pressing the STOP key takes the 1442 out of ready status. The READY light turns off. Do not use the 1442 STOP key to stop a job, use console STOP.

**NPRO Key:** Pressing the Nonprocess Runout (NPRO) key clears all cards from the card feed path. The hopper must be empty before the NPRO key will operate.

NPRO is also used to turn off the CHECK light and HOPR sense light when the system is turned on. This procedure ensures that the card feed path is clear.

### Status Lights

Four lights, above the keys on the operator's panel, show 1442 status.

**POWER ON Light:** This light turns on when the system power is turned on.

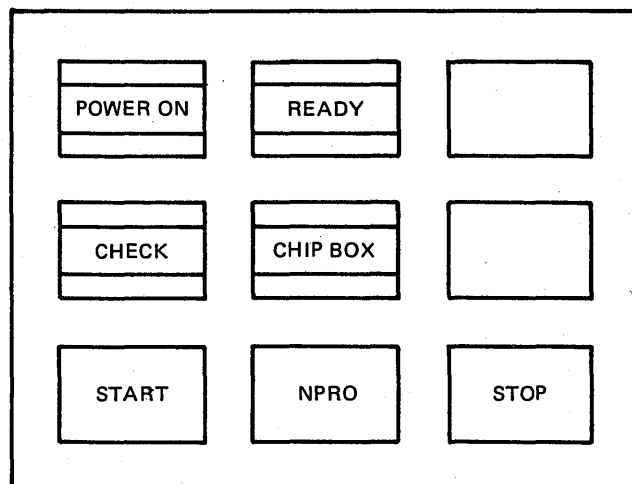

Figure 14. Operator's Panel



**READY Light:** When this light is on, the 1442 is ready to accept instructions from the processing unit. The READY light turns on if the following conditions are met:

1. System power on.
2. Cards in the hopper-except for last card sequence. Cards can also be in the card feed path if you press 1442 START after you press 1442 STOP.
3. 1442 CHECK light off.
4. Stacker not full.
5. 1442 START pressed.

**CHIP BOX Light:** The light turns on if the chip box is full or out of the machine. The READY light turns off when the CHIP BOX light turns on. The chip box is behind the left front cover.

**CHECK Light:** This light turns on when any of the backlit error indicators are lit. The READY light turns off. The CHECK light also turns on when system power is turned on. Press the NPRO key to turn off the CHECK light.

### Sense Lights

Seven lights, on a backlit panel to the left of the CHECK light (Figure 15), indicate errors in the card feed. An eighth light, OVER RUN, indicates a probable loss of data.

**HOPR:** A card failed to feed from the hopper. The HOPR light also turns on when system power is turned on. Press the NPRO key to turn off the HOPR light.

**READ STA:** A card is jammed at the read station.

**PUNCH STA:** A card is jammed at the punch station.

**TRANS:** A card is jammed in the stacker area.

**FEED CLU (Clutch):** All cards in the card feed path have advanced one position because of an unrequested feed cycle.

**READ REG:** Read error.

**PUNCH:** Punch error.

**OVER RUN:** Data is lost. The processing unit is unable to accept data from the 1442 or provide data to the 1442 as fast as is necessary.

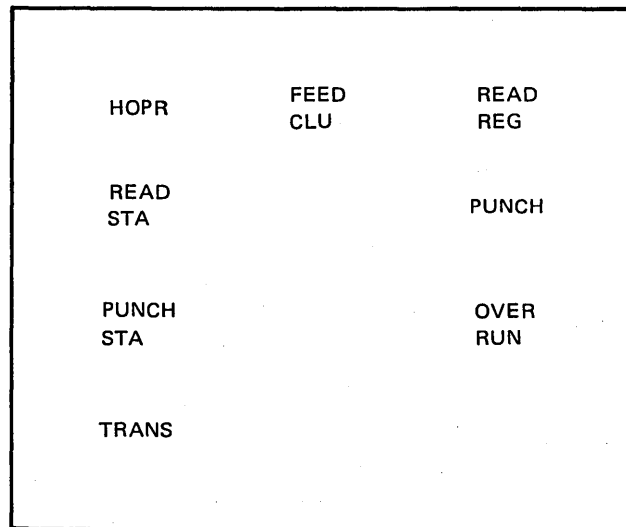

Figure 15. Sense Lights

## CLEARING A CARD JAM

The following procedure tells you how to physically remove cards from the 1442 card path. The program recovery procedures with corresponding halts – what to do with the cards to continue program operations – are listed in the program halts in the *IBM System/3 Model 10 Disk System Halt Guide*, GC21-7540.

### Indications

All of the following indicate a hopper misfeed or card jam in the 1442:

- C5, C6, C7, C8, or C9 halt in the console Message Display Unit.
- 1442 READY light not on.
- 1442 CHECK light on.
- A sense light on.

A sense light indicates the area in the card feed path where the trouble occurred. When a hopper misfeed or card jam occurs, record the error in your console log book. If the same error occurs repeatedly, it is an indication that the 1442 should be serviced.

### Removing Cards From the Card Feed Path

The 1442 card path is shown in Figure 16. The sense lights, whose names are shown in Figure 17, are lit to indicate where in the card path a card is jammed.

#### Hopper Misfeed :

1. Remove the cards from the hopper.
2. Check the bottom card for damage. All edges must be smooth. If the card is damaged, punch a new card to replace it.
3. Refer to the C5 halt in the *IBM System/3 Model 10 Disk System Halt Guide*, GC21-7540, for program recovery procedures.

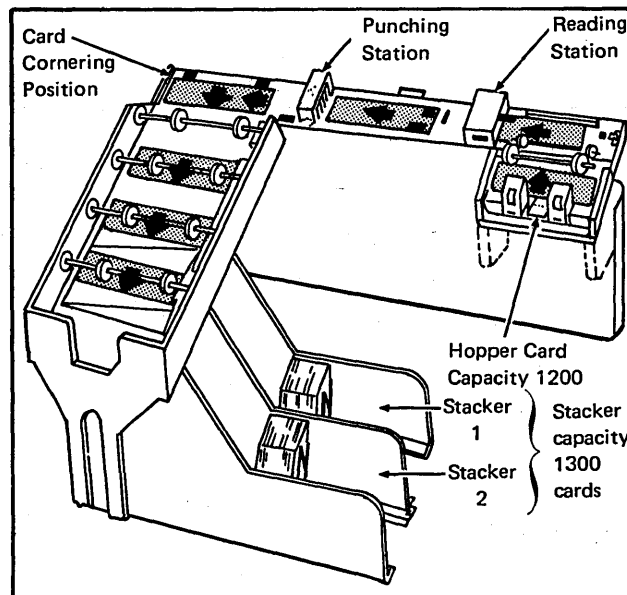

Figure 16. 1442 Card Path Schematic

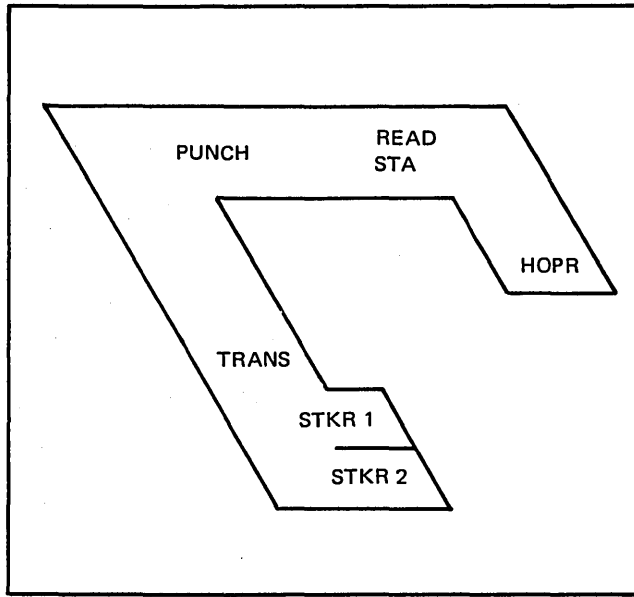

Figure 17. Card Path

*Card Jam in Card Path:*

①

Open the 1442 top covers.



53508

2

Raise the plastic card guides and remove all cards from the card path. If a card remains jammed under the punch unit, proceed with steps 3-7; otherwise go to step 8.

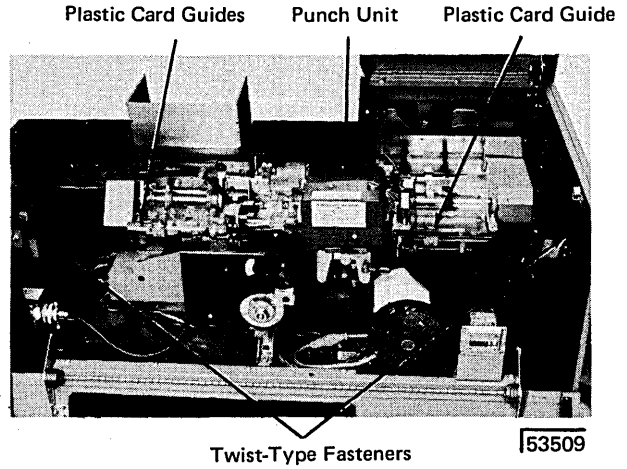

3

Open the two twist-type fasteners on the inside of the rear cover and lower the cover.

4

Turn the punch unit handwheel clockwise at least one-half revolution. System power must be on.

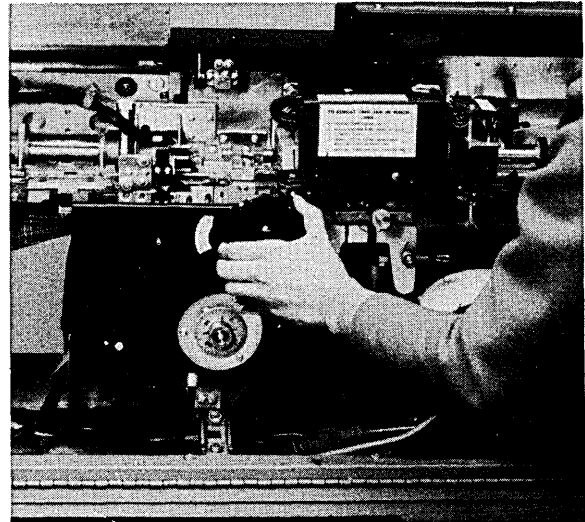

53510

5

Push down on the punch feed release lever and pull out the card.

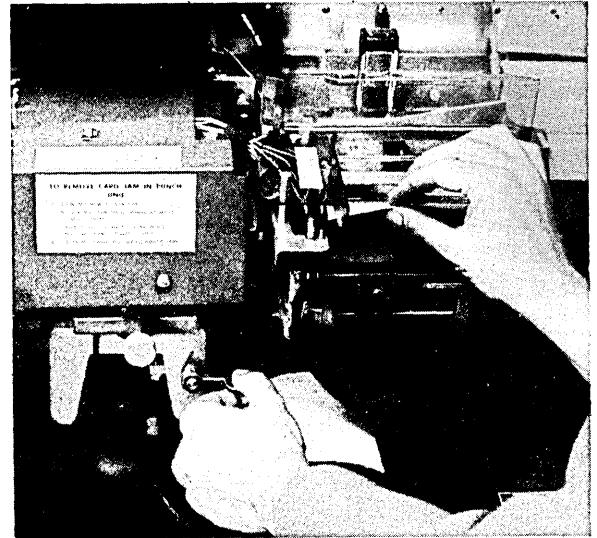

53511

6

If the card will still not come free, unscrew and pull out the lower punch guide. Remove the card and replace the lower punch guide.

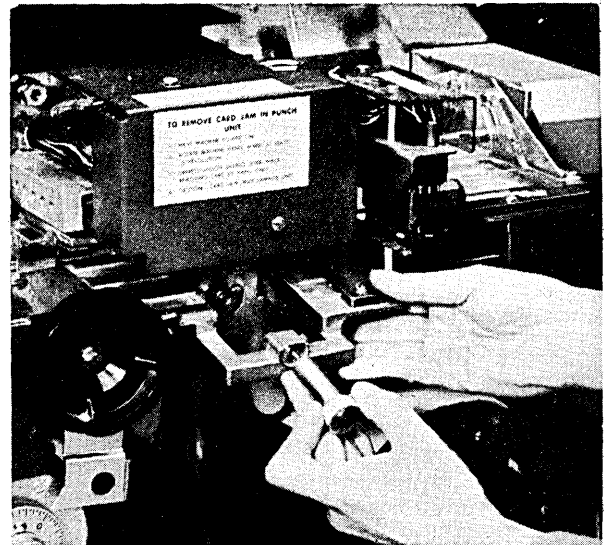

53512

7

Raise the rear cover and close the twist-type fasteners.

8

Lower the plastic card guides to their normal positions.

9

Close the 1442 top covers.

10

Refer to the appropriate halt in the *IBM System/3 Model 10 Disk System Halt Guide*, GC21-7540.

#### 1442 POWER ON AND READY PROCEDURES

1. Turn on the system POWER switch on the processing unit console. The 1442 CHECK and HOPR lights turn on.
2. Remove any cards from the 1442 card hopper.
3. Press the 1442 NPRO key. The CHECK and HOPR lights turn off.
4. Remove any cards from the stackers.
5. Place the cards to be processed, 9-edge first, face down in the card hopper.
6. Place the card weight behind these cards.
7. Press 1442 START. The first card in the hopper feeds to the pre-read station and the 1442 READY light turns on. The 1442 Card Read Punch is now ready for program operation.

#### 1442 LAST CARD PROCEDURES

When the last card is fed from the card hopper, the 1442 READY light turns off and the I/O ATTENTION light on the processing unit console turns on.

Operator action is determined by the program in operation:

1. More cards are required. Place the cards in the 1442 card hopper and press 1442 START. The program resumes operation.
2. Last card sequence. Press 1442 START. The last card is processed and the program resumes operation. Before proceeding to the next job(s), ready the 1442 (see *Using the 1442 as the Only Card Input Device, Chapter 10*).

*Note:* If a single card is being processed, it is necessary to press 1442 START twice. The first time START is pressed the card is registered at the pre-read station. The READY light turns on and off. The second time START is pressed the READY light turns on, and the card is ready to be processed as part of the last card sequence.

- Using the 1442 as the Only Card Input Device
- Preparing for System Operation
- Clearing I/O Attention
- Using the Console Log Sheet
- Stopping a Job Before It Is Completed
- Using the Machine Covers for Safety
- Turning System Power Off
- Restoring System Power
- Core Storage Dump
- Dual Program Operation

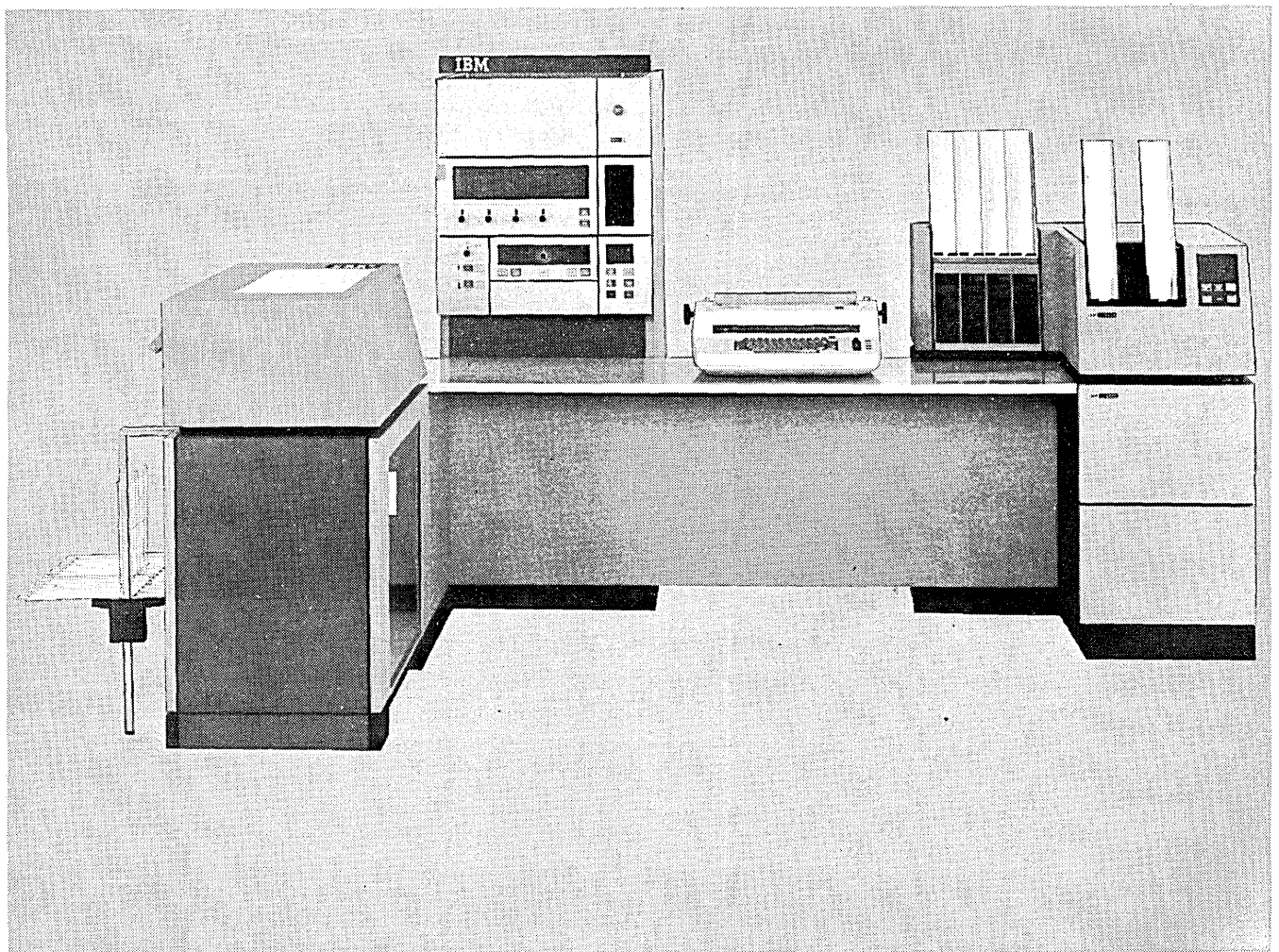

55239A



## USING THE 1442 AS THE ONLY CARD INPUT DEVICE

You may have a System/3 Model 10 Disk System that has the 1442 as the only card input device. In this case, you cannot run the following types of jobs:

- 96-List program.
- 96-96 Reproduce and Interpret program.
- MFCU Sort/Collate program.
- Data Recording program.
- Data Verifying program.

The following procedures describe the necessary steps that must be taken to run all jobs that can be run using the 1442 as the only card input device. Figure 18 shows the general input for the 1442.

1. Mount disk cartridges as specified on the program run sheet and ready disks.
2. Clear all cards from 1442. Remove any cards in stackers.
3. Place OCL and source statements in 1442 hopper. Place a blank card after the last card for the job in the 1442 hopper.

*Note:* If the job is going to punch cards, place blank cards after the last card for the job.

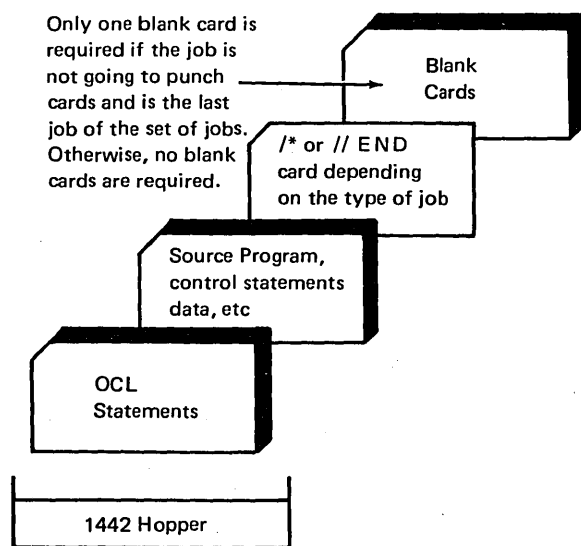

Figure 18. General 1442 Input for a Job

4. Press 1442 START. The READY light turns on.
5. Ready printer.
6. Press console START or appropriate HALT/RESET key if you have DPF. The job is complete when EJ is displayed in the message display unit.

*Note:* If the job is running with the // NOHALT statement in effect, a '9' halt may occur. If so, follow instructions in the *IBM System/3 Model 10 Disk System Halt Guide*, GC21-7540. To avoid this halt, a // HALT statement should be included in the last job's OCL to allow the EJ halt to occur so the operator can proceed to step 7.

7. After the job is complete, repeat steps 1-6 to start the next job.

If halts occur during the execution of the job, see *IBM System/3 Model 10 Disk System Halt Guide*, GC21-7540, for recovery procedures.

## PREPARING SYSTEM FOR PROGRAM OPERATION

To ready the system for operation, turn on system power. The power switch is on the system control panel on the processing unit console (Figures 19 and 20).

### Clear Cards from the MFCU

When power is on, the NPRO light is lit on the MFCU. To turn this light off:

1. Remove any cards from card hoppers.
2. Press NPRO key twice.
3. Remove any cards from stackers.

This procedure ensures that both card paths are free of cards.

### Place Forms in the Printer

To have the system ready for program operation, you should have forms in the printer. If you have not aligned the forms in the printer, you can do that now. See *Chapter 4. The IBM 5203 Printer* for procedures on loading and aligning forms.

### Perform IPL (Initial Program Load)

Next, you must initiate the IPL process. The IPL process that you initiate consists of a program that clears storage and loads into storage the control programs necessary to run your jobs. This must be done each time you turn the system power on and when indicated by recovery from halts.

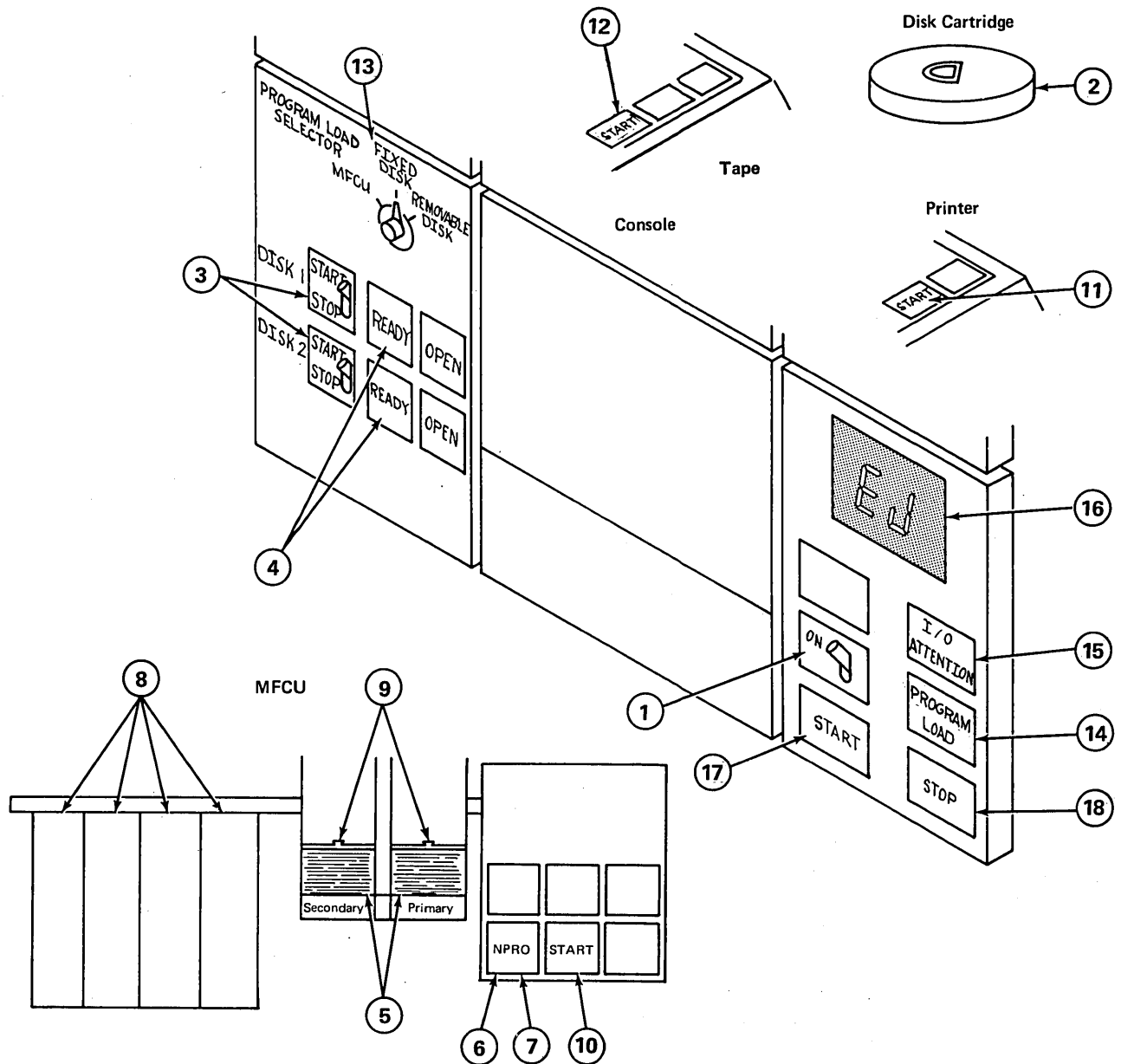

1. System power on.
2. Mount disk cartridge as specified on the program run sheet. Be sure the START/STOP switch is set at STOP and the OPEN light is on before mounting a cartridge.
3. Set START/STOP switch at START.
4. READY light comes on when disk is up to speed.
5. Remove cards from reader hoppers.
6. Press NPRO to clear primary feed path.
7. Press NPRO to clear secondary feed path.
8. Clear all cards from stacker.
9. Place OCL statements, data cards, and blank cards in hoppers, as required by program. Load cards face down, top edge to the left. Check program operating procedures in this manual, and run sheet provided by the programmer for specific instructions.
10. Press START on the card reader.
11. Ready printer if it is used by the program.
12. Ready tape units, if used by the program.
13. Set program load selector at position from which you will IPL.
14. Press PROGRAM LOAD.
15. I/O device not ready conditions are indicated by I/O ATTENTION light. Ready I/O devices to continue.
16. Programmed halts are displayed in message display unit. See *IBM System/3 Model 10 Disk System Halt Guide*, GC21-7540 for explanation of halts.
17. Press console START to continue.
18. Press console STOP when the system is not being used. Press console STOP before turning off system power.

Figure 19. Summary of Program Operating Procedures for a Dedicated System

You initiate the IPL process from one of three sources: MFCU, fixed disk (F1), or removable disk (R1). Normally the IPL process is initiated from the fixed disk or the removable disk depending on where the resident system is located. The IPL process cannot be initiated from R2 or F2.

You may have to select the device from which the system will begin reading after IPL. If you do not have an MFCU on your system, the data switches must be set before IPL. Set the data switches to 1442 if your system input device is the 1442 Card Read Punch (at this time the printer is assigned as the default logging device), or to 5471 if your system input device is the 5471 console. Do not have these numbers set in the data switches when you IPL if your system input device is the MFCU.

You may have to initiate the IPL process from the MFCU for some jobs. The program run sheet supplied to you by the programmer indicates when you have to do this. See the procedures later in this section on how to perform IPL from the MFCU.

If you have a dedicated (non-DPF) system, the system will not halt after IPL is performed. This is because the system is ready to begin reading OCL for the first job after IPL is complete. If the first job is ready to be run, ready the proper devices needed by the job. See *Chapter 11. Program Operation* for the procedures for running jobs.

If no jobs are to be run, you can still initiate the IPL process. When IPL is complete, the I/O ATTENTION light comes on and remains on until the appropriate input devices for the first job are ready. When the I/O devices are readied, the system immediately begins to execute the job.

If you have a DPF system, the system will halt with an EJ in both message display units after the IPL process is complete. When EJ appears in the message display units, the system is ready to accept jobs in both program levels.

The first statement supplied to the system after the IPL process is complete is a DATE statement. This statement is supplied to the system via the system input device (normally the primary hopper of the MFCU). The DATE statement has two different formats. The one you choose was defined at system generation time. See *Chapter 12. System Generation* for more information on the DATE statement.

The formats of a DATE statement are:

1	4	8	12	16	20	24	28	32	36	40	44
//	DATE	mm	dd	yy							
		OR									
//	DATE	dd	mm	yy							

Delimiters (/ , - , or any desired character except commas, quotes, numbers, and blanks) may be placed between the month (mm), day (dd), and year (yy). For example:

1	4	8	12	16	20	24	28	32	36	40	44
//	DATE	mm	/	dd	/	yy					
		OR									
//	DATE	dd	-	mm	-	yy					

Place the DATE statement in front of the first job to be run after the IPL process is complete.

The following procedures must be performed each time you initiate the IPL process from the fixed or removable disk:

1. Perform step 1a if the resident system disk cartridge has to be mounted. Perform step 1b if the disk cartridge is mounted or the resident system is on F1.
  - a. If your resident system is on a removable disk cartridge and it is not mounted, mount the cartridge on R1. (See the procedures in *Chapter 6. IBM 5440 Disk Cartridge and IBM 5444 Disk Storage Drive*, if you do not know how to mount or remove cartridges.)
  - b. If the proper cartridge is already mounted or if the resident system is on the fixed disk (F1), set the disk 1 START/STOP switch on the disk panel at START.

*Note:* For you to initiate the IPL process, a cartridge must be on R1. When your resident system is on F1, mount the cartridge for the first job on R1 if one is used by the first job. Otherwise, mount any cartridge so you can initiate the IPL process.
2. Set program load selector at FIXED DISK (F1) or REMOVABLE DISK (R1).
3. When the READY light for disk 1 is on, press PROGRAM LOAD. Initial program loading is performed.

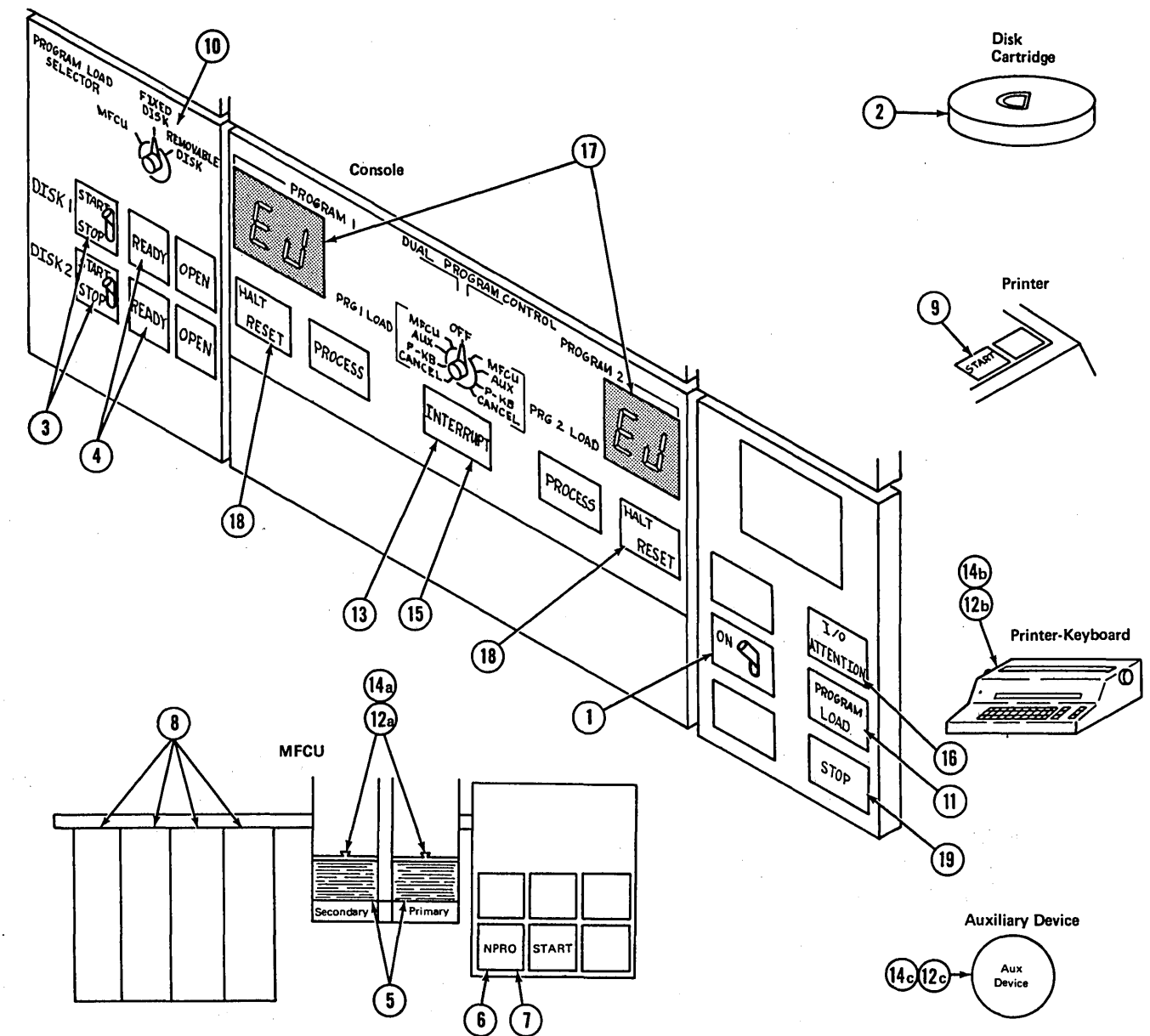

1. System power on.
2. Mount indicated disk cartridge as specified on program run sheet. Be sure the START/STOP switch is set at STOP and the OPEN light is on before mounting cartridge.
3. Set appropriate START/STOP switch to START.
4. READY light turns on when disk is up to speed.
5. Remove cards from MFCU hoppers.
6. Press NPRO to clear primary feed path.
7. Press NPRO to clear secondary feed path.
8. Clear all cards from stacker.
9. Ready printer if it is used by the program.
10. Set PROGRAM LOAD SELECTOR at position from which you will perform the IPL process.
11. Press PROGRAM LOAD.
12. Set DUAL-PROGRAM CONTROL switch to input device for program 1.
  - 12a. if MFCU, place OCL statements, data cards, and blank cards in hoppers as required by program. Load cards face down, top edge to the left. Check program run sheet and operating procedures in this manual. Press MFCU START.
  - 12b. if printer-keyboard, be ready to key information.
  - 12c. if auxiliary device, ready it.
13. Press INTERRUPT key.
14. Set DUAL-PROGRAM CONTROL switch to input device for program 2.
  - 14a. if MFCU, place OCL statements, data cards, and blank cards in hoppers as required by the program. Load cards face down, top edge to the left. Press MFCU START.
  - 14b. If printer-keyboard, be ready to key information.
  - 14c. If auxiliary device, ready it.
15. Press INTERRUPT key.
16. I/O devices not ready will be indicated by the I/O ATTENTION light. Ready the devices to continue.
17. Programmed halts are displayed on the DPF message display units. See *IBM System/3 Model 10 Disk System Halt Guide, GC21-7540*, for an explanation of halts.
18. Press HALT/RESET to continue.
19. Press console STOP when the system is not being used. Press console STOP before turning system power off.

Figure 20. Summary of Program Operating Procedures for a DPF System

## Initiating the IPL Process from the MFCU

Some programs require that you initiate the IPL process from the MFCU. These are known as stand-alone programs because they do not require system control programs to execute. The program run sheet supplied to you by the programmer will indicate when to initiate the IPL process from the MFCU. Perform the following procedures to initiate the IPL process from the MFCU:

1. Place cards for stand-alone job in primary hopper of MFCU.
2. Press MFCU START.
3. Set program load selector at MFCU.
4. Press PROGRAM LOAD.

Cards in the primary hopper of the MFCU are read into storage and the program is executed.

Initiate the IPL process from the fixed or removable disk after completion of the programs that required you to initiate the IPL process from the MFCU.

Figures 19 and 20 show the steps required to load and run a program on System/3. The necessary information you require to run the program can come from two sources, System/3 or the programmer:

1. Information from System/3. The system informs you of error conditions or special operating instructions by a displayed or printed message or both:
  - I/O ATTENTION means an I/O (input/output) device is not ready. See *Clearing I/O ATTENTION* in this chapter.
  - Programmed halts are displayed in the Message Display Unit and described in the *IBM System/3 Model 10 Disk System Halt Guide*, GC21-7540.
  - Unidentifiable halts should be recorded on the error log sheet described in this chapter.
2. Information from the programmer. The programmer can give you special instructions on the program run sheet.

## CLEARING I/O ATTENTION

The I/O ATTENTION light on the processing unit console turns on when any input/output device is selected by a program and the device is not ready. The device itself has additional indicators to guide you to the cause of the not-ready condition. I/O ATTENTION turns off when the device that required service is ready for operation. Conditions that cause I/O ATTENTION, along with recovery procedures, are listed in Figure 21.

## USING THE CONSOLE ERROR LOG SHEET

During system operation, a processor check or unidentifiable halt may occur. To determine the cause of the error, be sure to record the conditions that exist on the system at that moment. You can record these conditions on the System/3 Error Log Sheet (Figure 22). After you have filled out the error log sheet, rerun the program in which the error occurred and proceed according to the appropriate condition:

1. The same error occurs at the same point in the program. Note the condition under which the error occurs on the program run sheet and continue other program operations. Return the program decks, run sheet, and error log sheet to the programmer.
2. The same error occurs at a different point in the program. Contact the shift supervisor to determine if a service call is necessary.
3. The error does not recur. Set the error log sheet aside for review by the CE on his next service call. Continue program operations.

## STOPPING A JOB BEFORE IT IS COMPLETED

If you want to stop a job before reaching the normal end-of-job (EJ halt in message display unit), use the stop key on the processing unit. Do not use MFCU STOP or printer STOP.

When you press MFCU or printer STOP, the current program continues to run until it requires the device that is not ready. Then I/O ATTENTION will be on. In this case, if you clear the MFCU, place punched cards for a new program in either hopper, then press MFCU START (or printer START followed by MFCU START). The program that was waiting for the printer or MFCU will resume operations. If the program waiting for the MFCU starts a punch operation, the new program deck or data cards may be ruined.

Device	Device Indicator On	Cause	How to Clear
Printer	none	Printer not ready.	Press printer START.
Printer	FORMS	Forms end.	Load forms in printer and press printer START.
Printer	CHECK	Forms jam.	Clear forms jam and reload forms. Forms position for restart depends on program in operation. Press printer START.
Printer	INTERLOCK	INTERLOCK light is turned on by either of the following conditions:  1. Chute interlock.  2. Chain interlock.	Open forms compartment door. Push forms chute back to feed position. Close forms compartment door and press printer START.  This condition occurs when rear unit is open. Chain motor starts only when rear unit is closed. Close rear unit and press printer START.
MFCU	none*	MFCU not ready.	Ensure proper cards are in hoppers. Press MFCU START.
MFCU	STKR	A stacker is full.	Place cards in bin above stacker and press MFCU START.
MFCU	CHIP	Chip box is full or not in machine.	Open MFCU top cover. Empty and put back chip box. Close top cover and press MFCU START.
MFCU	CVR	MFCU top cover is open or not securely latched.	Close MFCU covers and press MFCU START.
Disk	None	Disk not up to speed.	Wait for READY light to turn on.
BSCA	BSCA ATTN	BSCA ATTN light is turned on by any of the following conditions:  1. Data set is not ready.  2. Autocall unit power is off.  3. BSCA is disabled.  4. External test switch is on test and BSCA is not in the test mode.  5. Data line in use.	Place call.  Turn autocall unit power on.  Place call.  Set external test switch to OPER.  Wait for BSCA ATTN light to turn off, then place call.

\*PRI or SEC light is on for all MFCU stops.

Figure 21 (Part 1 of 1). Clearing I/O ATTENTION

Device	Device Indicator On	Cause	How to Clear
1442	None	<p>1442 not ready. Can be caused by:</p> <ol style="list-style-type: none"> <li>1. No cards in hopper.</li> <li>2. Last card sequence.</li> <li>3. You pressed 1442 STOP.</li> <li>4. Stacker full.</li> <li>5. Top cover open or not securely latched.</li> </ol>	<ol style="list-style-type: none"> <li>1. On initial run in, load cards in hopper and press 1442 START.</li> <li>2. For last card, press 1442 START, or place cards in hopper and press 1442 START.</li> <li>3. Press 1442 START.</li> <li>4. Empty stacker and press 1442 START.</li> <li>5. Close covers and press 1442 START.</li> </ol>
1442	CHIP BOX	<p>Chip box is full or not in machine.</p>	<ol style="list-style-type: none"> <li>1. Empty the chip box or place it back in the machine. The chip box is located inside the left front cover.</li> <li>2. Press 1442 START.</li> </ol>
Tape	None	<p>Tape unit not ready Can be caused by:</p> <ol style="list-style-type: none"> <li>1. Cover not closed.</li> <li>2. Tape not mounted properly.</li> <li>3. Tape multivolume processing.</li> </ol>	<ol style="list-style-type: none"> <li>1. Close cover and press RESET, LOAD REWIND, and START.</li> <li>2. See procedures for tape mounting.</li> <li>3. When an end of volume is reached on a multivolume file, a message 'EOV Tx' (where x=1, 2, 3, or 4) is printed on the log device if available and the completed reel is rewound and unloaded. If the OCL specified multiple drives for this file and if the next volume is mounted on the next drive, processing continues without interruption. If the OCL specified a single drive for this file, the system comes to I/O ATTENTION. When the current volume is unloaded, the operator should mount the next volume on this drive and ready it. As soon as it becomes ready, processing continues. If the OCL specified multiple drives for this file and the next volume is not ready, the system comes to I/O ATTENTION. The operator should mount the next volume on the next drive and ready it. Processing continues as soon as the next drive is ready.</li> </ol>

Figure 21 (Part 2 of 2). Clearing I/O ATTENTION



It is necessary to perform the IPL process on the system to start a new job after using the console STOP key to stop a job. If you have DPF, you can cancel the job. (See *Dual Programming Operation, Procedures for Canceling Jobs.*)

#### USING THE MACHINE COVERS FOR SAFETY

Besides improving appearance, covers of IBM machines have been designed to protect you against possible injury during operation. While some hazards, such as moving mechanical parts, are obvious, others are not. Electrical potential and acoustical noise are in the latter category.

IBM maintains vigorous attention to safety on all its machines. However, the effectiveness of this effort is lessened when you fail to keep the covers closed while the system is running.

Covers have been designed to reduce noise levels to a more comfortable range. Operation with the covers open causes needless exposure to unseen hazards. Because of this, IBM strongly recommends that all people working with the equipment follow the simple safety-first procedure of keeping all covers closed while the system is operating.

The frames of all IBM equipment have been made electrically safe by recommended grounding practices.

In addition to the safety aspects of this procedure, the system runs quieter and looks better.

#### TURNING SYSTEM POWER OFF

When turning system power off, an EJ halt should be displayed in the message display unit. Perform the following procedures to turn system power off:

1. Press console STOP.
2. Set START/STOP switches on the disk panel at STOP.
3. Clear cards from MFCU.
4. Press RESET and UNLOAD REWIND on all tape units.
5. When the OPEN lights on the disk panel are lit and tapes have been rewound, set the console power switch at OFF.

If system power is turned off before the disk panel START/STOP switches are set STOP, perform the following procedures:

1. Set the power switch at ON and wait for the READY lights to turn on.
2. Set START/STOP switches at STOP and wait for the OPEN lights to turn on.
3. Clear cards from MFCU.
4. Set power switch at OFF.

Figure 22. System/3 Error Log Sheet

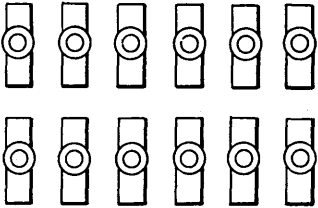

All of the above switches are normally in the down position. X any switch that is in the up position.

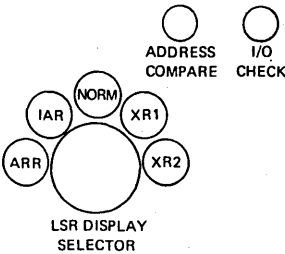

ADDRESS COMPARE I/O CHECK

LSR DISPLAY SELECTOR

Processing Unit Serial Number

Enter Meter Reading:

--	--	--	--	--	--

CONSOLE DISPLAY SELECTOR Note: X block if corresponding indicator is on.

1 SAR HI	P	0	1	2	3	4	5	6	7		P	0	1	2	3	4	5	6	7	SAR LO	1
2 LSR HI	P	0	1	2	3	4	5	6	7		P	0	1	2	3	4	5	6	7	LSR LO	2
3 OP REG	P	0	1	2	3	4	5	6	7		P	0	1	2	3	4	5	6	7	Q REG	3
4 B REG	P	0	1	2	3	4	5	6	7		DIG CAR	DEC	RE COMP	ADD	SUB	TEMP CAR	AND	OR		ALU CTRL	4
5 A REG	P	0	1	2	3	4	5	6	7		P	0	1	2	3	4	5	6	7	ALU OUT	5
6											P			BIN OVF	TF	DEC OVF	HI	LO	EQ	COND REG	6
7 CS ASNMT	P	0	1	2	3	4	5	6	7		0	1	2	3	4	5	6	7		INT LEV	7
8 PROC CHK	I/O LSR	LSR F1	LSR F2	LSR HI	LSR LO	SAR HI	SAR LO	INV ADDR	SDR		CAR	DBI	A/B REG	ALU	CPU DBO	OP/O REG	INV OP	CHAN DBO	INV O	PROC CHK	8

Set LSR DISPLAY SELECTOR to ARR.

2 LSR HI	P	0	1	2	3	4	5	6	7		P	0	1	2	3	4	5	6	7	LSR LO	2
----------	---	---	---	---	---	---	---	---	---	--	---	---	---	---	---	---	---	---	---	--------	---

Set LSR DISPLAY SELECTOR to IAR.

2 LSR HI	P	0	1	2	3	4	5	6	7		P	0	1	2	3	4	5	6	7	LSR LO	2
----------	---	---	---	---	---	---	---	---	---	--	---	---	---	---	---	---	---	---	---	--------	---

MACHINE CYCLE: IOP, IO, IR, IX1, IH1, IL1, IX2, IH2, IL2, EA, EB, I/O, INT LEV

CLOCK: 0, 1, 2, 3, 4, 5, 6, 7, 8, 9

Enter ADDRESS/DATA switch setting in circle

SIOC

DUAL PGM CTRL

OFF

MFCU

AUX

P-KB

CANCEL

PRG 1 LOAD

PRG 2 LOAD

PROCESS

INTERRUPT

PROCESS

STOP

PROCESSOR CHECK

I/O ATTENTION

READY

**SYSTEM/3 5410 ERROR LOG SHEET**

Date: \_\_\_\_\_ Time: \_\_\_\_\_

Operator: \_\_\_\_\_

Job Name: \_\_\_\_\_

Use this sheet to record console display at any unrecognizable halt.

- At the halt:
1. X all console lights that are on.
  2. X all console switch settings requested.
  3. X any MFCU or printer lights that are on.
  4. Set LSR display selector to NORM. Set console display selector to "1 SAR HI." X all insert blocks with corresponding indicators (P8421) on. Repeat for positions 2 through 8.
  5. Set LSR display selector to ARR. Set console display selector to "2 LSR HI." X any indicators that are on.
  6. Set LSR display selector to IAR. Set console display selector to "2 LSR HI." X any indicators that are on.

Comments: \_\_\_\_\_

\_\_\_\_\_

\_\_\_\_\_

\_\_\_\_\_ (Continue on back)

**MFCU Indicator Panel**

1	2	3	4	SEC	PRI
5	6	7	8	RD	HPR
9	10	11	12	NPRO	STKR
13	14	15	16	CHIP	CVR
17	18	19	20	A	B

SECONDARY READY      PRIMARY READY

**Printer Indicator Panel**

CHECK	INTERLOCK	FORMS
-------	-----------	-------

PROCESSOR CHECK      I/O ATTENTION

STOP

READY

## RESTORING SYSTEM POWER

System/3 can turn off as a result of internal or external power loss, or an overtemperature condition in the processing unit or printer electronics. The recovery procedure depends on the status of the TH CHK (thermal check) and PWR CHK (power check) lights on the processing unit display panel:

### PWR CHK Light Only

Power off was caused by voltage loss or overvoltage in the system. To restore power:

1. Turn the power on switch to OFF.
2. Press the CHECK RESET on the CE control panel.
3. Turn the power on switch to ON.

If power cannot be restored, call IBM for service.

### PWR CHK and TH CHK Lights

Power off was caused by a thermal condition or an external power loss. To restore power:

1. Turn the power switch to OFF. The power check light will go off immediately. The thermal check light should turn off when the processing unit internal temperature lowers to a safe operating level.
2. If there are any objects (such as boxes, papers, or coats) on or around the processing unit, remove them because they may be interfering with air circulation in the machine.
3. If the thermal check light turns off within five minutes, turn the power switch to ON.
4. If the thermal check light turns on again soon, or if it does not turn off within five minutes, call your customer engineer.

### No Lights

Check that line voltage is available to the system. Check that the emergency pull switch is in the normal (in) position. If the emergency pull switch is pulled, call IBM for service.

## CORE STORAGE DUMP

A core storage dump is a process by which the contents of core storage are printed on the printer. The printout is in

hexadecimal format and shows the contents at each address in storage.

You may have to take core storage dumps for the following reasons:

- A program is not executing properly. Taking a core storage dump at this time will provide valuable information to the programmer in determining what is wrong with his program. The programmer should indicate to you on the program run sheet when and under what conditions he wants you to take a core storage dump.
- Several halts described in the *IBM System/3 Model 10 Disk System Halt Guide*, GC21-7540, require you to take core storage dumps.
- If you ever get processor checks (the PROCESSOR CHECK light on the console is on), you should take a core storage dump. Processor checks indicate that an error occurred in the processing unit while it was attempting to execute a program.

### Considerations Before Taking a Core Storage Dump

- For DPF systems, take a core storage dump *only* when the other program level does not have any programs running. You should wait until the other level is at end-of-job. If it is not possible to wait until the other level is completed and an option is listed for the halt, select the option.
- When a core storage dump is taken and options are listed, the options are no longer valid. This is because you have to perform the IPL process after a core storage dump is taken.

A core storage dump is performed as follows:

1. Press console STOP.
2. Set each ADDRESS/DATA switch at 0.
3. Raise CE panel cover and press SYSTEM RESET.
4. Press console START. The entire System/3 core storage will be printed on the printer. When the printing of core storage is complete, EJ will be displayed in the message display unit.
5. Save the dump and return it to the programmer.
6. Perform IPL process before starting next job.

## DUAL PROGRAMMING OPERATION

The Dual Programming Feature (DPF) allows two jobs to execute at the same time within the system. These two jobs are referred to as program 1 and program 2 levels. Jobs can be initiated in either level first. In other words, a job can be loaded into the program 2 level before a job is loaded into the program 1 level. Running jobs under DPF is basically the same as running jobs on System/3 without DPF. The following differences should be noted:

- You select the system input device to be used for each level by using the dual program control switch.
- Press INTERRUPT to initiate the first job for the level, after selecting the input device.
- Press HALT/RESET to recover from programmed halts or to initiate the next job if the same input device for the level is being used.
- If you select a different input device for the level, you must again press INTERRUPT to initiate the job.
- You can use the same input device for both levels only when the first level loaded no longer requires the input device. Halt JP displayed in the DPF message display unit means you are trying to use an input device that is required by the other level.
- Halt JL displayed in the DPF message display unit means that there is not enough room in storage for the job you are trying to load. The PARTITION statement controls the amount of storage available for program 2.
- Contention for the system work area occurs when jobs running in program 1 and program 2 both require the use of the system work area. One program will appear to stop until the other program either finishes or frees up the system work area.

The *IBM System/3 Model 10 Disk System Halt Guide*, GC21-7540, lists the halts and the procedures you must take to recover from the halts.

### Procedures

The following general procedures tell you how to run programs if you have DPF:

1. Follow the steps under *Preparing the System for Program Operation* in this chapter to perform IPL. After performing IPL, the EJ halt appears on both DPF message display units.

2. Set dual program control switch on DPF panel to appropriate input device for level you are going to load first (program 1 or program 2). Be sure you supply a DATE statement in front of the first job to be loaded after performing IPL. The system expects the input from the device you selected. If the MFCU is the device, have the cards in the specified hoppers. If the printer-keyboard is the device, be ready to key-in the information.
3. Press INTERRUPT on DPF panel. The job is loaded and execution begins. If the printer-keyboard is the input device, you must key the job.
4. Set dual program control switch on DPF panel to the input device to be used for other program level. Remember, if one level is using an input device, the other level cannot use that device until the first level no longer requires it.
5. Press INTERRUPT on the DPF panel. The job is loaded and execution begins.
6. When a job in one of the levels (program 1 or program 2) is complete, an EJ halt is displayed on the DPF message display unit for that level. If the next job for that level uses the same input device as the preceding job, press HALT/RESET on the DPF panel to load the next job. If you are going to use a different device, repeat steps 2 and 3.
7. Repeat step 6 for the other level when EJ halt occurs.
8. Repeat steps 6 and 7 until there are no more jobs to be run.

While jobs are running, program halts can occur for both levels. See *IBM System/3 Model 10 Disk System Halt Guide*, GC21-7540, for recovery procedures when program halts occur. If program halts occur for both levels at the same time, handle them one at a time according to the procedures in *IBM System/3 Model 10 Disk System Halt Guide*, GC21-7540. See *Chapter 11. Program Operation* for information on running individual programs.

## Procedures for Canceling Jobs

The CANCEL position on the dual program control panel allows you to cancel programs. Programs cannot be cancelled if:

- The I/O ATTENTION light is on.
- An RPG II object program has been interrupted.
- The RECEIVE INITIAL light on the BSCA panel is on.
- The system is performing the end-of-job function (INTERRUPT light is off).

To cancel a job in either level, perform the following steps.

1. Set dual program control switch on DPF panel at CANCEL for the level (program 1 or program 2) you want to cancel.
2. Press INTERRUPT on DPF panel.
3. Set rightmost address/data switch on processing unit display panel at 2 or 3 when halt JU is displayed on the DPF message display unit.
4. Press HALT/RESET on DPF panel. An EJ halt is displayed on DPF message display unit when the job is canceled.



- Operation Control Language (OCL) Considerations
- RPG II Program
- | ● RPG II Telecommunications Program
- Device Counter Logout Program
- 96-List Program
- 96-96 Reproduce and Interpret Program
- MFCU Sort/Collate Program
- Data Recording Program
- Data Verifying Program
- Disk Sort Program
- | ● Tape Sort Program
- Basic Assembler Program
- Disk Utility Programs
- | ● Disk Resident Tape Utility Programs
- Checkpoint/Restart Program

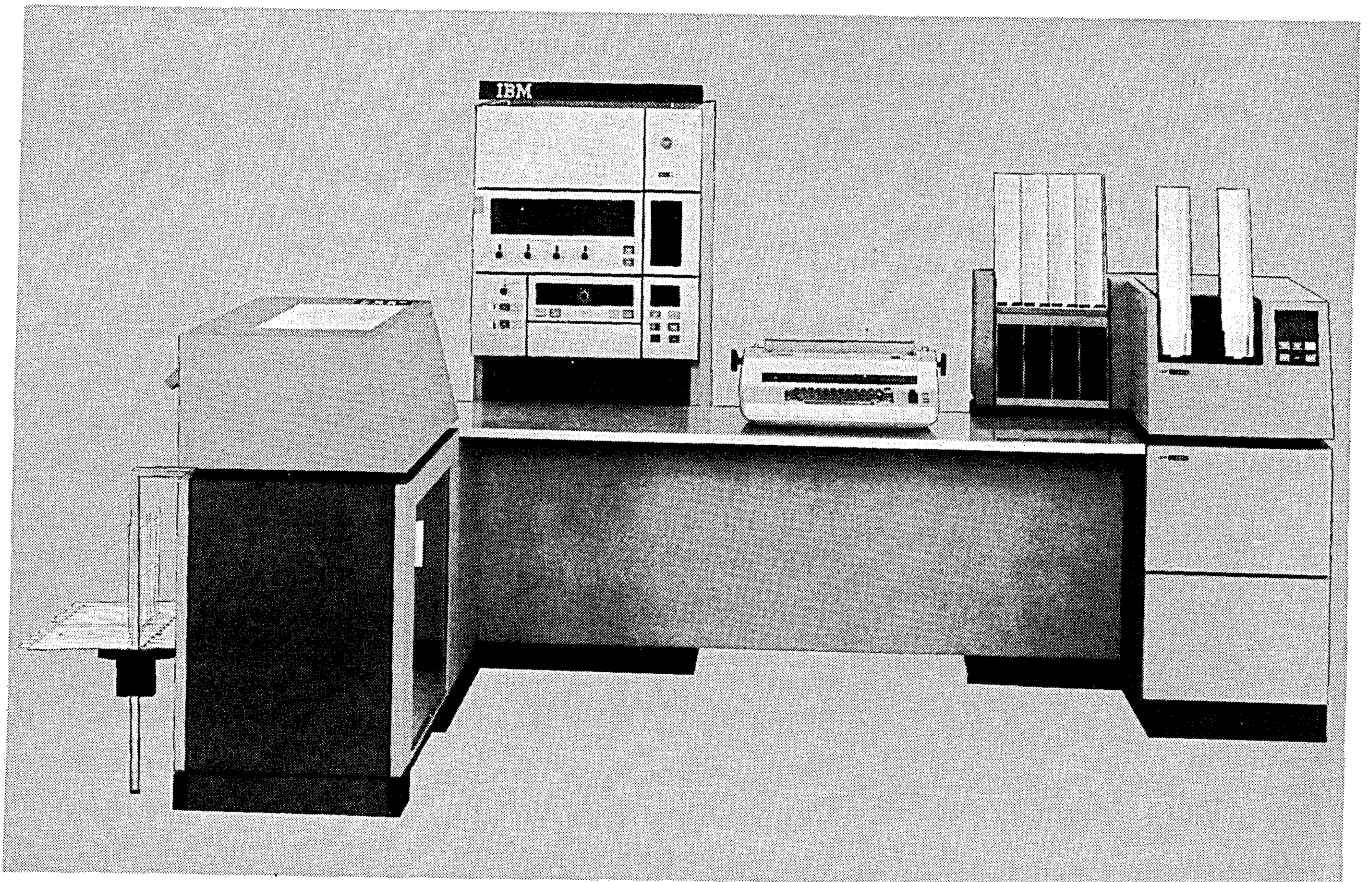

55239A

## OPERATION CONTROL LANGUAGE (OCL) CONSIDERATIONS

Every program that you run has certain statements in front of the deck called OCL (operation control language) statements. OCL provides the system the information about the job to be run (what program to use, what files to use, what input/output devices to use, etc.). It is a good idea to examine these statements because some of them require action from you. OCL statements used by a program should be listed on the program run sheet. Never change the order of the OCL statements. For more information on OCL, see *IBM System/3 Model 10 Disk System Control Programming Reference Manual*, GC21-7512.

### // DATE Statement

This card must always be the first statement supplied to the system after IPL. Each time the IPL process is performed, the system expects a DATE statement. The date supplied is used as the system date. Place it in the system input device (normally the primary hopper of the MFCU) ahead of the set of statements of the first job. If you have DPF, the DATE statement must be supplied with the program you load first. Do not provide a DATE statement for the other program.

### // READER Statement

The primary system input device is the primary hopper of the MFCU. The READER statement tells the system to use a different device (printer-keyboard, secondary hopper of the MFCU or 1442). When the READER statement is present, place it and any OCL statement preceding it into the primary hopper of the MFCU. The remaining OCL statements and jobs must be supplied from the device named on the READER statement. To change the system input device back to the primary hopper of the MFCU, perform IPL or supply another READER statement naming the primary hopper of the MFCU as the system input device. The READER statement should be preceded with a /& statement.

If the system input device is the 5471 Printer-Keyboard, the keyed input will be preceded by a blank, 1, or 2. These characters provide the following information:

Blank	Dedicated system.
1	DPF. Program level one has initiated the input request.
2	DPF. Program level two has initiated the input request.

### // LOG Statement

If your system has a printer-keyboard, OCL statements and error codes are printed by the printer-keyboard; otherwise, the statements and error codes are printed on the printer. The LOG statement can tell the system to do one of the following:

- Use the printer as the logging device.
- Use the printer-keyboard as the logging device.
- Stop printing OCL statements and error codes.
- Start printing OCL statements and error codes.

The logging device is turned on when you perform IPL. If your system has DPF, the following should be noted:

- The logging device will be off if LOG statements for *either* level (program 1 or program 2) specify that it be off.
- LOG statements for both program 1 and program 2 must state that the logging device be on before it can be used for logging.
- Only LOG statements for program 1 can tell the system to use a different logging device.
- When the printer is the logging device, OCL statements and error codes are not printed if *either* program 1 or program 2 are using the printer for other output.

If the logging device is the 5471 Printer-Keyboard, the logged output is preceded by a blank, 1, or 2. These characters provide the following information:

Blank	Dedicated system.
1	DPF. Program level one has initiated the log request.
2	DPF. Program level two has initiated the log request.

At end-of-job, the characters EJ preceded by a blank, 1, or 2 are logged if the 5471 Printer-Keyboard is the logging device.

### // LOAD Statement

This statement identifies the program to be run and indicates whether the program will be loaded from cards or disk.



#### **// RUN Statement**

This statement indicates the end of OCL statements for a job and tells the system to begin execution.

#### **// SWITCH Statement**

This statement is used to set one or more external indicators on or off. Once these indicators are on, they remain on until they are turned off by another SWITCH statement or until you perform the IPL process. The indicators are all off after the IPL process is performed.

#### **// NOHALT Statement**

This statement tells the system to continue, without stopping, when a program ends. The system continues until it reads a HALT statement. You can stop the system by pressing the console stop key. The NOHALT statement is invalid for program 2 (DPF system). Program 2 will always stop after each job is completed.

#### **// HALT Statement**

This statement is used only if you want to cancel the effect of a NOHALT statement. It tells the system to halt when a job is completed. You can tell the system to continue to the next job by pressing console START (or by pressing the HALT/RESET key if you have DPF). The HALT statement is ignored in program level 2 if you have DPF.

#### **// PAUSE Statement**

This statement causes the system to halt with a display of 90 in the message display unit. It is usually preceded by comments on the printer, informing you of some action to take. You may have to mount a different cartridge or insert special forms in the printer. When you have taken the necessary action, press console START (or the HALT/RESET key if you have DPF) to continue operation.

#### **// CALL Statement**

This statement is used only when OCL needed for the job is on disk as a procedure. Procedures are groups of OCL statements that have been placed in the source library on disk.

#### **// FILE Statement**

This statement is used to supply to the system information about groups of related records called files. The system uses this information to read records from and write records on disk.

#### **// PARTITION Statement**

This statement is used only if you have DPF. It tells the system the amount of storage you want for program 2.

#### **// COMPILE Statement**

This statement tells the system where the source program is located (on disk or on cards) and where the object program is to be placed.

#### **// FORMS Statement**

This statement is used to change the number of lines to be printed per page on the printer. The number of lines is normally 66 but could have been changed at system generation.

#### **// IMAGE Statement**

This statement must be supplied whenever the printer chain is changed. The printer requires characters matching those on the printer chain to be in a special area of storage called the chain-image area. When you replace the printer chain with one having different characters, the contents of the chain-image area must also be changed. See Appendix A for more information on the IMAGE statement.

#### **// PUNCH Statement**

This statement indicates the card output device that will be used to punch the object deck. Be sure to place blank cards following the /\* card in the hopper.

#### **// BSCA Statement**

This statement allows you to change all BSCA line specifications in the BSCA DTFs of your program.

#### **// LOCKOUT Statement**

This statement disables the other program level in a DPF system to allow fast job initiation in the program level in which it is entered. The program level remains disabled until job initiation is complete.

## RPG II PROGRAM

*Note:* If you are using the 1442 instead of the MFCU see *Using the 1442 as the Only Card Input Device in Chapter 10. System Operation.*

This section lists the steps required to compile and execute an RPG II program. *IBM System/3 Model 10 Disk System Halt Guide, GC21-7540*, lists compilation halts and object program execution halts.

### Compilation

The procedures for compiling an RPG II source program are:

1. Mount any disk cartridges specified on program run sheet, and ready disks.
2. Clear all cards from the MFCU by pressing NPRO twice.
3. Place OCL statements source program deck in the primary hopper (see Figures 23 and 24). Load cards facedown, top edge to the left. A source program deck may not be given to you if a // COMPILE statement is supplied in the OCL for the program. The COMPILE statement tells the system where the

source program is located (on disk or cards) and where to place the object program. When the source program is on disk, you will not be given a source program deck. This is all that is needed for diagnostics-only run.

4. If an object deck is to be punched, place blank cards in the secondary hopper. Load cards facedown top edge to the left.
5. Press MFCU START. PRIMARY READY and SECONDARY READY lights turn on.
6. Ready printer.
7. Press console START (or appropriate HALT/RESET key if you have DPF).

During compilation, a number of halts can occur. Check the list of program halts in *IBM System/3 Model 10 Disk System Halt Guide, GC21-7540*, for recovery procedures.

EJ in the Message Display Unit indicates the end of compilation, or the end of a diagnostics only run. Clear the MFCU according to the type of run just completed (see following methods). Always clear the primary hopper first.

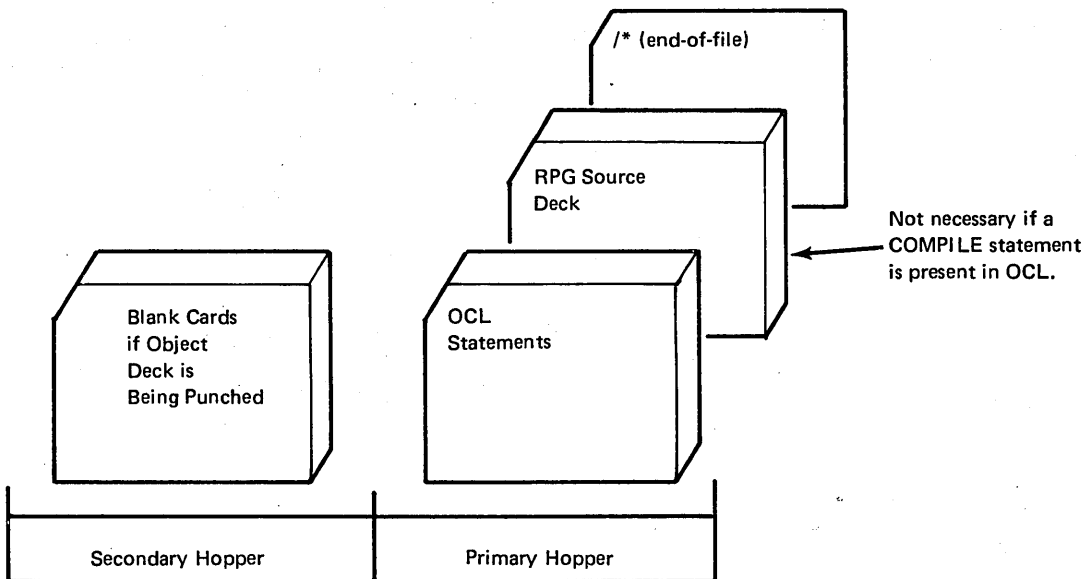

Figure 23. RPG II Input

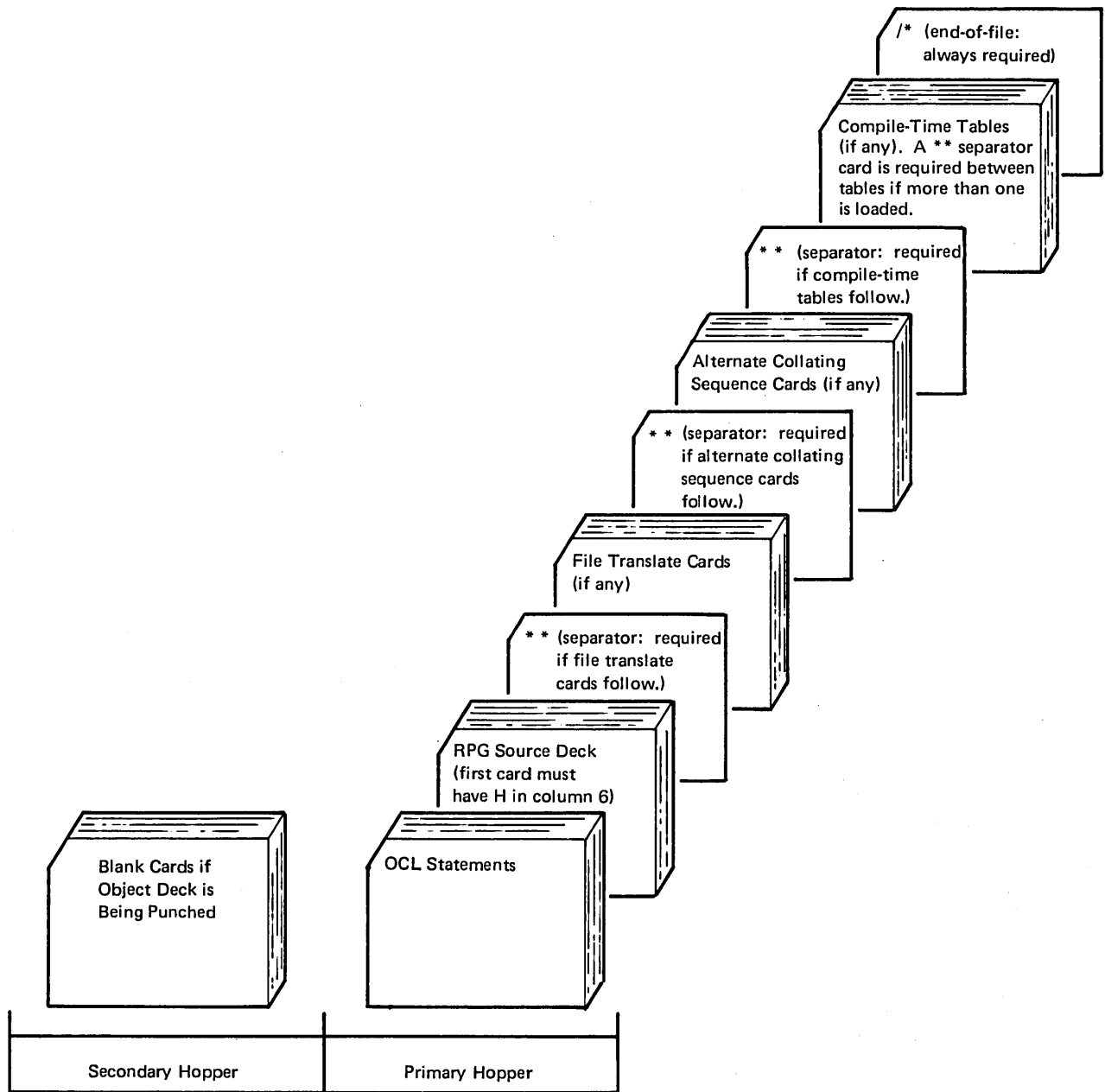

Figure 24. RPG II Input with Optional Source Material

#### *Clearing the MFCU After a Successful Compilation*

1. Press MFCU STOP.
2. Press NPRO to feed source deck end-of-file card into stacker 1.
3. Remove source deck from stacker 1.
4. If an object deck was punched, it will be in stacker 3. Use these cards for the execution portion of the RPG II program.
5. Remove blank cards from secondary hopper.
6. Press NPRO.
7. Remove blank card from stacker 1.

#### *Clearing the MFCU After a Diagnostic-Only Run*

1. Press MFCU STOP.
2. Press NPRO to feed source deck end-of-file card into stacker 1.
3. Remove source deck from stacker 1.

#### **Object Program Execution**

1. Mount disk cartridge specified on program run sheet, and ready disks.
2. Clear cards from MFCU.
3. Place OCL statement in primary hopper. Load cards face down, top edge to the left. If an object deck was punched, place it in the primary hopper of the MFCU.
4. If required, place object tables and data cards (Figure 25) in the hopper designated on program run sheet.
5. Press MFCU START. The PRIMARY READY light will come on. If any cards are in the secondary hopper, SECONDARY READY will come on.
6. Ready printer. If special forms are required, load them in the printer.
7. Ready tape units if required by the program.
8. Press console START (or appropriate HALT/RESET key if you have DPF).

During object program execution, a number of halts can occur. H1-H9 halts indicate that instructions for running this program are provided on the program run sheet or printer listing. A 1P halt means the forms in the printer need positioning. H1-H9 and 1P halts can occur only if the programmer specified them in the source program. All object program halts are included in the list of program halts in *IBM System/3 Model 10 Disk System Halt Guide*, GC21-7540.

EJ in the message display unit indicates a successful program execution.

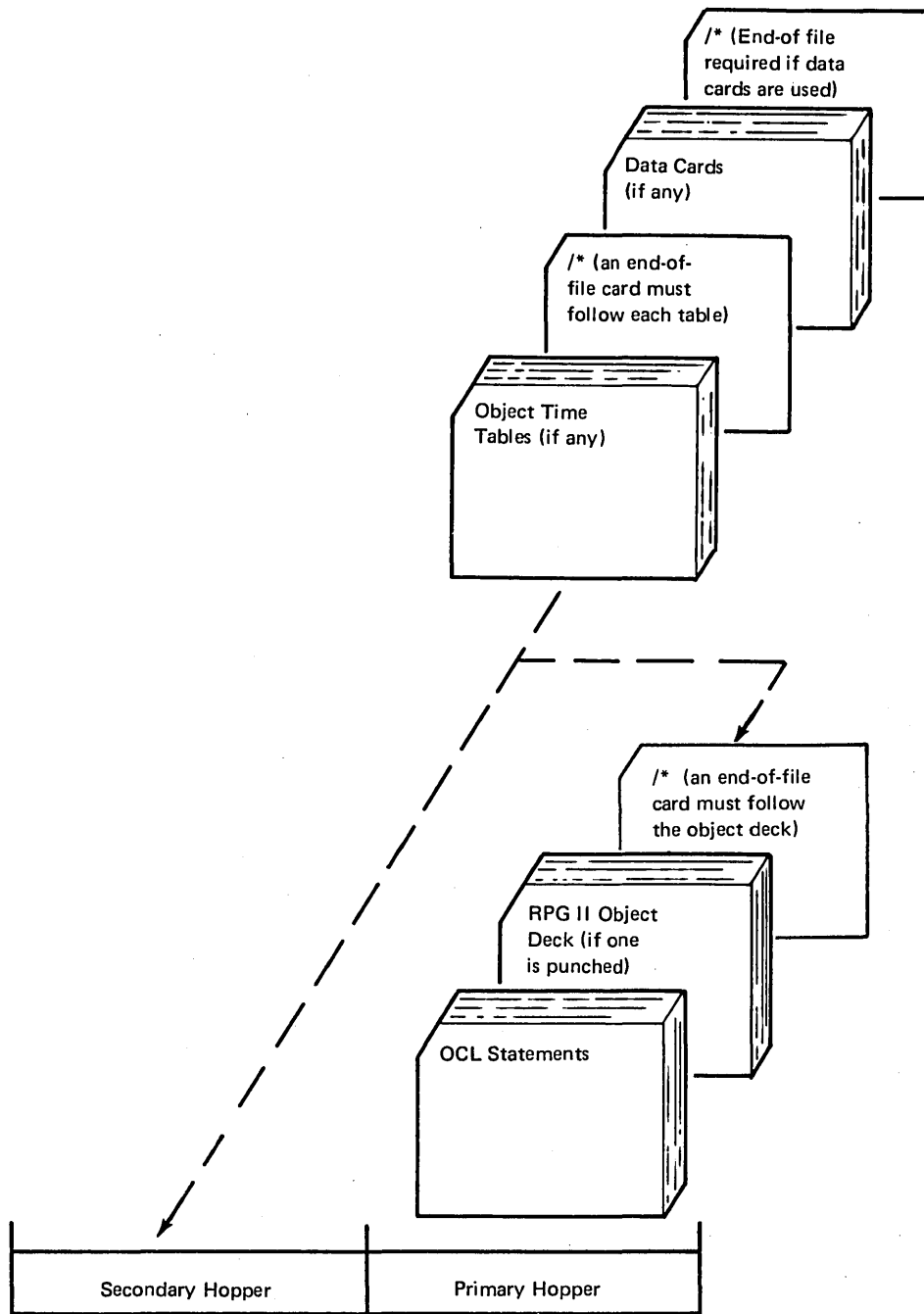

Figure 25. Input for RPG II Object Program Execution

## Executing an RPG II I-Type Program

RPG II I-Type programs are loaded into storage and remain there to be used as needed. I-Type programs can only be executed by an inquiry request (pressing REQ on the printer-keyboard). An I-Type program cannot be interrupted and placed on disk. I-Type programs can be used most efficiently with a DPF system, however, they can also be used on a dedicated (non-DPF) system. I-Type programs can also be loaded into storage after interrupting an RPG II object program. For information on executing I-Type programs after interrupting RPG II object programs, see *Interrupting an RPG II Object Program*.

The execution of an I-Type program depends on the input device (MFCU or printer-keyboard) being used.

### Execution of an I-Type Program Using the MFCU or 1442

1. Mount disk cartridge specified on program run sheet and ready disks.
2. Clear cards from reader.
3. Place OCL statements and data cards in hopper (primary hopper of MFCU).

*Note:* The OCL statements may be keyed using the printer-keyboard. This will be indicated on the program run sheet when you have to do this. The data cards will still be placed in the hopper.

4. Press START on the reader.
5. Press console START, or appropriate HALT/RESET key if you have DPF. The OCL statements are read and the I-Type program is loaded into storage.
6. Press REQ on printer-keyboard. The data cards are read and the I-Type program is executed. EJ is displayed in the message display unit when the job is complete. If any other halts occur, see *IBM System/3 Model 10 Disk System Halt Guide*, GC21-7540 for recovery procedures.

### Execution of an I-Type Program Using the Printer-Keyboards

1. Mount disk cartridge specified on the program run sheet and ready disks.
2. Key OCL statements using the printer-keyboard.

*Note:* The OCL statements can be on cards. The program run sheet will indicate to you when the OCL statements are on cards. Place the OCL statements in the primary hopper, press MFCU START, and console START, or appropriate HALT/RESET key if you have DPF.

3. Press REQ on printer-keyboard. PROCEED light turns on.
4. Key data record using printer-keyboard. The data record is processed and then the I-Type program goes into a wait state. It is waiting for the next data record to be processed.
5. Press REQ on printer-keyboard. PROCEED light turns on.
6. Key next data record when desired. The data record is processed and, again, the I-Type program goes into a wait state.
7. Repeat steps 5 and 6 for each data record to be processed.
8. When no more data records are to be processed, press REQ on printer-keyboard and key /\*. EJ is then displayed in the message display unit. If other halts occur, see *IBM System/3 Model 10 Disk System Halt Guide*, GC21-7540

### Interrupting an RPG II Object Program

RPG II object programs can be interrupted provided the job being executed allows interrupts and you have a printer-keyboard to initiate the interrupt. When the interrupt is initiated, the job in storage is placed on disk. A new job can then be loaded into storage and executed. The program run sheet will indicate when you have to interrupt an RPG II object program.

Perform the following procedures to interrupt an RPG II object program.

1. Press REQ on printer-keyboard. The REQUEST PENDING light is on. When the REQUEST PENDING light is off, the interrupt has been allowed. The RPG II job in storage is now placed out on disk by the system.
2. When halt JY is displayed in the message display unit, check the program run sheet to determine if the interrupted program is using the MFCU or the 1442. Then perform the following steps as required. If the MFCU is not being used, proceed to step 9. If the interrupted program was using tapes, do not rewind or dismount the tapes. These tape units are not available for use by the new program being loaded.  
*Note:* If the MFCU and/or the 1442 will not be needed by the new job, do not use NPRO to run cards out of the machines. When the J' halt occurs, select the option to bypass card repositioning.
3. Remove cards from primary hopper. Indicate that these cards came from the primary hopper. You will have to use these cards later.
4. Press MFCU NPRO. One card is fed into stacker 1. Place this card in front of cards removed from primary hopper.
5. Remove cards from stacker 1 and set them aside. They will not be used again by this job.
6. Remove any cards from the secondary hopper. Indicate that these cards came from the secondary hopper.
7. Press MFCU NPRO. One card is fed into stacker 1 if the secondary hopper is being used. Place this card in front of any cards removed from secondary hopper.

8. Remove any cards from stackers.
9. Check the program run sheet to determine if the interrupted program is using the 1442. If the 1442 is not being used, proceed to step 13.
10. Remove cards from stackers and set them aside. They will not be used again by this job.
11. Remove cards from the hopper. You will have to use these cards later.
12. Press 1442 NPRO. Two cards are fed into stacker 1. Place these cards in front of cards removed from the hopper.
13. Place cards, if necessary, for new job in specified hoppers of MFCU or the 1442 as indicated on the program run sheet.
14. Press MFCU START or 1442 START, if necessary.
15. Mount disk cartridge and tape reels as specified on the program run sheet for the new program, if any, and ready disks and tape units.
16. Ready printer.
17. Set rightmost ADDRESS/DATA switch at 0.
18. Press console START (or appropriate HALT/RESET key if you have DPF).

19. When the PROCEED light comes on, key OCL for new job via the printer-keyboard. You may only have to key a READER statement for the MFCU or the 1442 if the OCL for the new job is on cards. In this case, key-in the READER statement and place the OCL for the job in front of any cards in the primary hopper. If an I-Type program is being loaded (determine this by checking the program run sheet) and the printer-keyboard is being used as the input device, the following must be done after keying the OCL statements and the first data record:
- Press REQ on the printer-keyboard. The PROCEED light turns on.
  - Key next data record.
  - Repeat steps a and b for each data record, including the end-of-file (/\*) statement.

The new job is loaded and halt '5 occurs. This halt allows you to continue with or cancel the job.

20. Set rightmost ADDRESS/DATA switch at 0 to allow the job to execute or set rightmost ADDRESS/DATA switch at 3 to cancel the job.
21. Press console START (or appropriate HALT/RESET key if you have DPF). If you cancelled the job, go to step 24.

The job begins execution. When the job is complete, halt J' is displayed in the message display unit. You must now restore the conditions that existed before the RPG II job was interrupted.

If either the 1442 or the MFCU was used by the interrupting job, you must prepare both devices for card repositioning. If neither device was used and the cards were left in the machines, proceed to step 25.

22. Clear cards from MFCU and/or the 1442.
23. Remove cards from stacker.
24. If any cards for the interrupted program were removed from the machines, replace them in the appropriate hoppers of the MFCU and/or the 1442.
25. Press MFCU START or 1442 START.
26. Remount disk cartridge used by the interrupted job and ready disks.
27. Ready printer.
28. Set rightmost ADDRESS/DATA switch at 0 if card repositioning is needed; set at 1 if card repositioning is not needed.
29. Press console START (or appropriate HALT/RESET key if you have DPF) to continue operation of the interrupted job. If the J' halt occurs again, you may have mounted the wrong cartridge. After you have checked that the correct cartridge is mounted, set the rightmost address/data switch at 0 and press console START (or appropriate HALT/RESET key if you have DPF).

If any other halts occur during this operation, refer to the *IBM System/3 Model 10 Disk System Halt Guide*, GC21-7540, for recovery procedures.



## RPG II TELECOMMUNICATIONS PROGRAM

This section lists the steps required to compile and execute an RPG II program that contains specifications for the telecommunications feature. Any halts that occur are listed in the *IBM System/3 Model 10 Disk System Halt Guide*, GC21-7540.

### Compilation

1. Mount disk cartridges specified on the program run sheet and ready disks.
2. Clear cards from MFCU.
3. Remove cards from stackers.
4. Place OCL statements and source deck in primary hopper. Load cards face down, top edge to the left. This is all that is needed for a diagnostics-only run.
5. If an object deck is to be punched, place blank cards in the secondary hopper. Load cards face down, top edge to the left. (The object program is placed on disk when cards are not punched.)
6. Press MFCU START. PRIMARY READY and SECONDARY READY lights turn on.
7. Ready printer.
8. Press console START, or appropriate HALT/RESET key if you have DPF. During compilation, a number of halts can occur. Check the list of program halts in *IBM System/3 Model 10 Disk System Halt Guide*, GC21-7540, for recovery procedures.

EJ in the message display unit indicates the end of compilation or the end of a diagnostics-only run. Clear the MFCU according to the type of job just completed (see following methods). Always clear the primary hopper first.

### Clearing the MFCU After a Successful Compilation

1. Press MFCU STOP.
2. Press NPRO to feed source deck end-of-file card into stacker 1.
3. Remove source deck from stacker 1.
4. If an object deck was punched, it will be in stacker 3. Use these cards for the execution portion of the BSCA program.
5. Remove blank cards from secondary hopper.
6. Press NPRO.
7. Remove blank card from stacker 1.

### Clearing the MFCU After a Diagnostic-Only Run

1. Press MFCU STOP.
2. Press NPRO to feed source deck end-of-file card into stacker 1.
3. Remove source deck from stacker 1.

### Execution

There are two types of BSCA networks: nonswitched and switched. For nonswitched networks, there is always a direct communication line between the stations. The data phone is never used. Nonswitched networks can be further broken down into point-to-point and multipoint, nonswitched networks. For point-to-point, nonswitched networks, the communication lines are continuously established between two stations. A multipoint, nonswitched network has a central station and several tributary stations. The communication lines are continuously established, but the central station selects the tributary station that can send and receive data at a certain point in time.

For switched networks, a direct communication line is not always established. The data phone is used to establish the necessary communication lines. A switched network is point-to-point only, but communication is possible with many different stations. The procedures for executing BSCA object programs over switched and nonswitched networks follow.

A schedule must be established to ensure that each BSCA station loads its program at the correct time. On a leased network, the receiving station must start first. On a multi-point network, the System/3 terminal must start first. These programs will wait; a transmit program will not wait for the receiving program to be started. On a switched network, the answering terminal must be ready first.

#### *Nonswitched Networks*

1. Mount disk cartridges and tape reels specified on program run sheet and ready disk and tape units.
2. Clear cards from MFCU.
3. Remove cards from stackers.
4. Place OCL statements, object deck (if any), and data cards (if any) in hoppers as specified on program run sheet.
5. Press MFCU START. PRIMARY READY LIGHT turns on. If there are any cards in the secondary hopper, the SECONDARY READY light turns on.
6. Ready printer.
7. Press console START, or appropriate HALT/RESET key if you have DPF. The programs are loaded and transfer of data occurs. Transmission is complete when EJ is displayed in the message display unit.

#### *Switched Networks*

The procedures you perform when your system is on a switched network depends on whether you are initiating the call and whether the initiation of the call is being made manually or automatically.

#### *Initiating a Call Manually*

1. Mount disk cartridges and tape reels specified on program run sheet and ready disk and tape units.
2. Clear cards from MFCU.
3. Remove cards from stacker.

4. Place OCL statements, object deck (if any), and data cards (if any) in hoppers as specified on program run sheet.
5. Press MFCU START. PRIMARY READY light turns on. If there are any cards in the secondary hopper, the SECONDARY READY light turns on.
6. Ready printer.
7. Press console START, or appropriate HALT/RESET key if you have DPF. The program is loaded and execution begins.
8. When halt Y7 occurs, do the following:
  - a. Press TALK on data phone.
  - b. Set rightmost address/data switch at 0.
  - c. Press console START, or appropriate HALT/RESET key if you have DPF.
  - d. Wait for I/O ATTENTION and BSCA ATTN lights to turn on.
  - e. Pick up receiver and dial digits in proper sequence.
  - f. Verbally communicate with the operator on the other system, or if AUTO is pressed on the data phone of the other system, wait for a high-pitch tone.
  - g. Press DATA on your phone.
  - h. Place receiver back on phone.

#### *Initiating a Call Automatically*

1. Mount disk cartridges and tape reels specified on program run sheet and ready disks and tape units.
2. Press AUTO on data phone.
3. Clear cards from MFCU.
4. Remove cards from stackers.
5. Place OCL statements, object deck (if any), and data cards (if any) in hoppers as specified on program run sheet.
6. Press MFCU START. PRIMARY READY light turns on. If there are any cards in the secondary hopper, the SECONDARY READY light turns on.

7. Ready printer.
8. Press console START, or appropriate HALT/RESET key if you have DPF. When the operator or the other system answers, transmission of data occurs and is complete when EJ is displayed in the message display unit.

#### *Answering a Call Manually*

1. Mount disk cartridges and tape reels specified on program run sheet and ready disks and tape units.
2. Clear cards from MFCU.
3. Remove cards from stackers.
4. Place OCL statements, object deck (if any), and data cards (if any) in hoppers as specified on program run sheet.
5. Press MFCU START. PRIMARY READY light turns on. If there are any cards in the secondary hopper, the SECONDARY READY light turns on.
6. Ready printer.
7. Press console START, or appropriate HALT/RESET key if you have DPF. The program is loaded and execution begins.
8. When Y8 occurs, do the following:
  - a. Press TALK on data phone and wait for incoming call.
  - b. Set rightmost ADDRESS/DATA switch at 0.
  - c. Press console START, or appropriate HALT/RESET key if you have DPF.
  - d. Wait for RECEIVE INITIAL light on BSCA panel to turn on.
  - e. Lift receiver and verbally communicate with the operator of the other system or wait for a high-pitch tone if AUTO CALL is used by the calling station.
  - f. Press DATA on your phone.
  - g. Place receiver back on phone. Transmission of data occurs and is complete when EJ is displayed in the message display unit.

#### *Answering a Call Automatically*

1. Mount disk cartridges and tape reels specified on program run sheet and ready disks and tape units.
2. Press AUTO on data phone.
3. Clear cards from MFCU.
4. Remove cards from stackers.
5. Place OCL statements, object deck (if any) and data cards (if any) in hoppers specified on program run sheet.
6. Press MFCU START. PRIMARY READY light turns on. If there are any cards in the secondary hopper, the SECONDARY READY light turns on.
7. Ready Printer.
8. Press console START, or appropriate HALT/RESET key if you have DPF. When the connection is made, transmission of data occurs and is complete when EJ is displayed in the message display unit.

#### **DEVICE COUNTER LOGOUT PROGRAM**

The primary purpose of the Device Counter Logout program is to report information about errors that were recorded during the execution of a Binary Synchronous Communications (BSC) program, which contained the programming support to update these counters. You should run the Device Counter Logout program immediately following every such BSC program.

The Device Counter Logout program prints the counters for adapter 1 (and adapter 2 if available on the system). The contents of the terminal statistics table, MLTERFIL, which is a permanent file on F1 containing counters for multipoint control stations only, is printed following the counters. If MLTERFIL does not contain any entries for an adapter, the following message is printed in place of the contents of MLTERFIL:

**TERMINAL STATISTICS TABLE (MLTERFIL) EMPTY**

If MLTERFIL does not exist, the following message is printed:

**TERMINAL STATISTICS TABLE (MLTERFIL)  
NOT FOUND**

Adapter 2 information is printed on a separate page.

The system LOG must be ON when the Device Counter Logout program is run or the program will go to end of job. The contents of the counters will be displayed on the device assigned as the system LOG.

*Operating Procedure*

1. Place the following OCL cards in the MFCU primary hopper.

```
// LOG ON
// LOAD $$BSDL,F1 (Use R1 if your system pack
is mounted there.)
// RUN
```

2. Press MFCU START.
3. Ready the system LOG device.
4. Press console START (or appropriate HALT/RESET Key if you have DPF). The device counters will be printed in the following format:

BSCA LOG mm/dd/yy

ADAPTER 1

*****		
COUNTER DESCRIPTION	TOTAL	LAST JOB
*****		
TEXT BLOCKS SENT	nnnn	nnnn
TEXT BLOCKS RECEIVED	nnnn	nnnn
NAKS RECEIVED	nnnn	nnnn
DATA CHECKS	nnnn	nnnn
FORWARD ABORTS	nnnn	nnnn
ABORTS	nnnn	nnnn
ADAPTER CHECKS ON TRANSMIT	nnnn	nnnn
ADAPTER CHECKS ON RECEIVE	nnnn	nnnn
INVALID REPLIES	nnnn	nnnn
ENQS RECEIVED	nnnn	nnnn
LOST DATA COUNT	nnnn	nnnn
DISCONNECT TIMEOUTS	nnnn	nnnn
TIMEOUTS DURING RECEIVE DATA	nnnn	nnnn

*****		
TERMINAL ADDRESS	UNSUCCESSFUL I/O OPERATIONS	SUCCESSFUL I/O OPERATIONS
*****		

Address 1	nnnn	nnnn
Address 2	nnnn	nnnn
Address 3	nnnn	nnnn
Address 4	nnnn	nnnn
Address 5	nnnn	nnnn
Address 6	nnnn	nnnn
Address 7	nnnn	nnnn
Address 8	nnnn	nnnn
Address 9	nnnn	nnnn
Address 10	nnnn	nnnn

```

*****
COUNTER DESCRIPTION          TOTAL      LAST JOB
*****

TEXT BLOCKS SENT            nnnn      nnnn
TEXT BLOCKS RECEIVED        nnnn      nnnn
NAKS RECEIVED               nnnn      nnnn
DATA CHECKS                 nnnn      nnnn
FORWARD ABORTS              nnnn      nnnn
ABORTS                      nnnn      nnnn
ADAPTER CHECKS ON TRANSMIT  nnnn      nnnn
ADAPTER CHECKS ON RECEIVE   nnnn      nnnn
INVALID REPLIES             nnnn      nnnn
ENQS RECEIVED               nnnn      nnnn
LOST DATA COUNT            nnnn      nnnn
DISCONNECT TIMEOUTS        nnnn      nnnn
TIMEOUTS DURING RECEIVE DATA nnnn      nnnn

*****
      *****
      TERMINAL      UNSUCCESSFUL      SUCCESSFUL
      ADDRESS      I/O OPERATIONS  I/O OPERATIONS
      *****
Address 1          nnnn          nnnn
  
```

The entries have the following meaning:

- BSCA LOG — Heading to identify the printout.
- mm/dd/yy — Date stored in the System Communication area.
- ADAPTER — Identifies adapter being used.
- TEXT BLOCKS SENT — Number of blocks of data transmitted successfully from this terminal to a remote terminal.
- TEXT BLOCKS RECEIVED — Number of blocks of data received successfully by this terminal from a remote terminal.
- NAKS RECEIVED — Number of negative responses received by this terminal in response to data transmitted by this terminal.
- DATA CHECKS — Number of text blocks received with invalid error check bits.
- FORWARD ABORTS — Number of times a remote terminal has terminated transmission abnormally while transmitting data.



- ABORTS** — Number of times a remote terminal has terminated transmission abnormally while receiving data.
- ADAPTER CHECKS ON TRANSMIT** — Number of times the following errors occurred while the terminal was transmitting data:
  1. Parity check within the adapter.
  2. Cycle steal overrun.
  3. Local store register or control register check.
- ADAPTER CHECKS ON RECEIVE** — Number of times the following errors occurred while the terminal was receiving data:
  1. Parity check within the adapter.
  2. Cycle steal overrun.
  3. Local store register or control register check.
- INVALID REPLIES** — Number of abnormal responses (including no responses) from the remote terminal.
- ENQ'S RECEIVED** — Number of requests for retransmission of this terminal's last acknowledgement after the acknowledgement has already been sent.
- LOST DATA COUNT** — Number of text blocks received which do not fit into the receive area.
- DISCONNECT TIMEOUTS** — Number of times the data set has dropped ready status after that status was set on.
- TIMEOUTS DURING RECEIVE DATA** — Number of times this terminal expected to receive text but did not receive anything for 3.25 seconds.

## **CARD UTILITIES**

The procedures in this section are for the following card utilities:

1. 96-List
2. 96-96 Reproduce and Interpret
3. MFCU Sort/Collate
4. Data Recording
5. Data Verifying

## 96-LIST PROGRAM

1. Mount disk cartridge specified on the program run sheet, if any, and ready disks.
2. Clear cards from MFCU.
3. Place OCL statements and cards to be listed in primary hopper of MFCU (Figure 26). Load cards face-down, top edge to the left. Be sure two end-of-file (*/\**) cards are at the end of the deck to be listed.

More than one deck can be placed in the MFCU and listed. Each deck, however, must be followed by two end-of-file cards.

4. Press MFCU START. The PRIMARY READY light will turn on.
5. Ready printer.
6. Press console START (or appropriate HALT/RESET key if you have DPF). After the program is loaded, the system halts with CU displayed in the message display unit. If CU is not displayed, check the list of program halts in the *IBM System/3 Model 10 Disk System Halt Guide*, GC21-7540.

7. Set rightmost ADDRESS/DATA switch on console to select the program option you want to run, as indicated on the program run sheet:

- Card count only; no listing 0
- Single space with card count 1
- Double space with card count 2
- Triple space with card count 3

Any switch setting other than 0 through 3 selects the double-space-with-card-count option (same as 2).

8. Press console START (or appropriate HALT/RESET key if you have DPF). The selected program option is performed and all cards are placed in stacker 1.

When the end-of-file cards (*/\**) are read, the system halts with 52 in the message display unit. If there are no more list jobs to run, proceed to step 9. If more list jobs are to be run, follow the steps under *Restart Procedure*.

9. Set rightmost ADDRESS/DATA switch at 2.

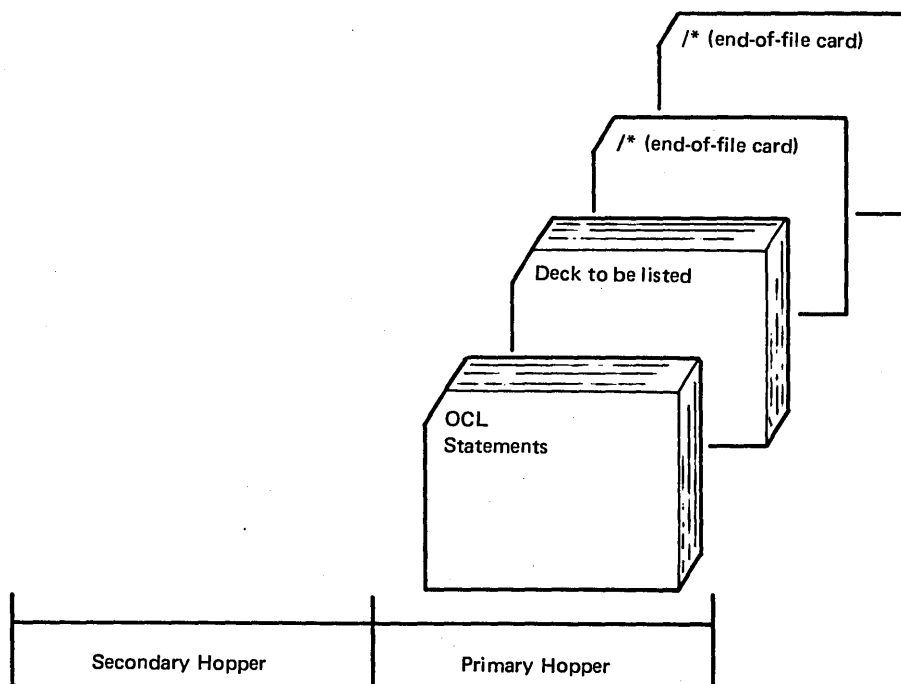

Figure 26. Input Deck for List Program



10. Press console START (or appropriate HALT/RESET key if you have DPF).
11. System halts with EJ in the message display unit. Clear cards from MFCU.

*Restart Procedure*

1. Set rightmost ADDRESS/DATA switch at 1.
2. Press console START (or appropriate HALT/RESET key if you have DPF). The message display unit changes to CU.
3. Place cards needed for this run in primary hopper of MFCU—if they are not already there—and ready MFCU.
4. Repeat operating procedure starting at step 7.

**96-96 REPRODUCE AND INTERPRET PROGRAM**

1. Mount proper disk cartridge if specified on program run sheet and ready disks.
2. Clear cards from MFCU.
3. Place OCL statements, followed by cards required for the job, in primary hopper of MFCU. Load cards face down, top edge to the left. Be sure two end-of-file (/\*) cards are at the end of the deck. Several reproduce and interpret jobs can be placed in the MFCU at the same time. Place the cards in the order shown in Figures 27 and 28. Each deck, however, must be followed by two end-of-file cards.
4. Place blank cards in secondary hopper if any deck in primary hopper is being reproduced. You will be able to tell this by looking at the program run sheet.
5. Press MFCU START. The PRIMARY READY light will turn on. If there are blank cards in the secondary hopper, the SECONDARY READY light will turn on.
6. Press console START (or appropriate HALT/RESET key if you have DPF). After the program is loaded, the system halts with CU displayed in the message display unit. If CU is not displayed, check the list of program halts in the *IBM System/3 Model 10 Disk System Halt Guide*, GC21-7540.

7. Set rightmost ADDRESS/DATA switch on console to select program option you want to run, as indicated on the program run sheet:

- Read and interpret (print as punched) 0
- Reproduce (punch a new card deck) 1
- Reproduce and interpret (punch and print on cards) 2
- Reproduce with reformatting 3
- Reproduce and interpret with reformatting 4

Any switch setting other than 0 through 4 selects the reproduce and interpret option (same as 2).

8. Press console START (or appropriate HALT/RESET key if you have DPF). The selected program option is performed. Cards from the primary hopper go to stacker 1 (nearest the hoppers). Cards from the secondary hopper go to stacker 4. If any reformat data cards are present, they go to stacker 2. When two consecutive end-of-file (/\*) cards are read, the system halts with 52 in the message display unit.
9. If there are no more reproduce and interpret jobs to run, set the rightmost ADDRESS/DATA switch at 2. If more reproduce and interpret jobs are to be run, follow the steps under *Restart Procedure*.
10. Press console START (or appropriate HALT/RESET key if you have DPF).
11. When system halts with EJ in the message display unit, clear cards from MFCU.

**Restart Procedure**

1. Set rightmost ADDRESS/DATA switch at 1.
2. Press console START (or appropriate HALT/RESET key if you have DPF). The message display unit changes to CU.
3. Place cards needed for this run in proper hoppers of MFCU—if they are not already there—and ready MFCU.
4. Repeat operating procedure starting at step 7.

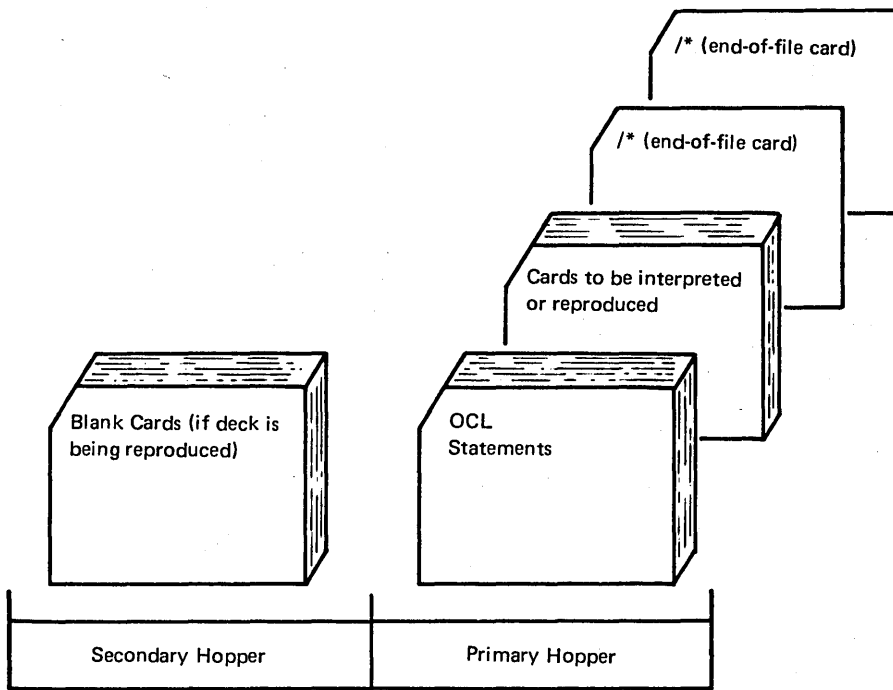

Figure 27. Input Deck for Reproduce or Interpret Without Reformatting

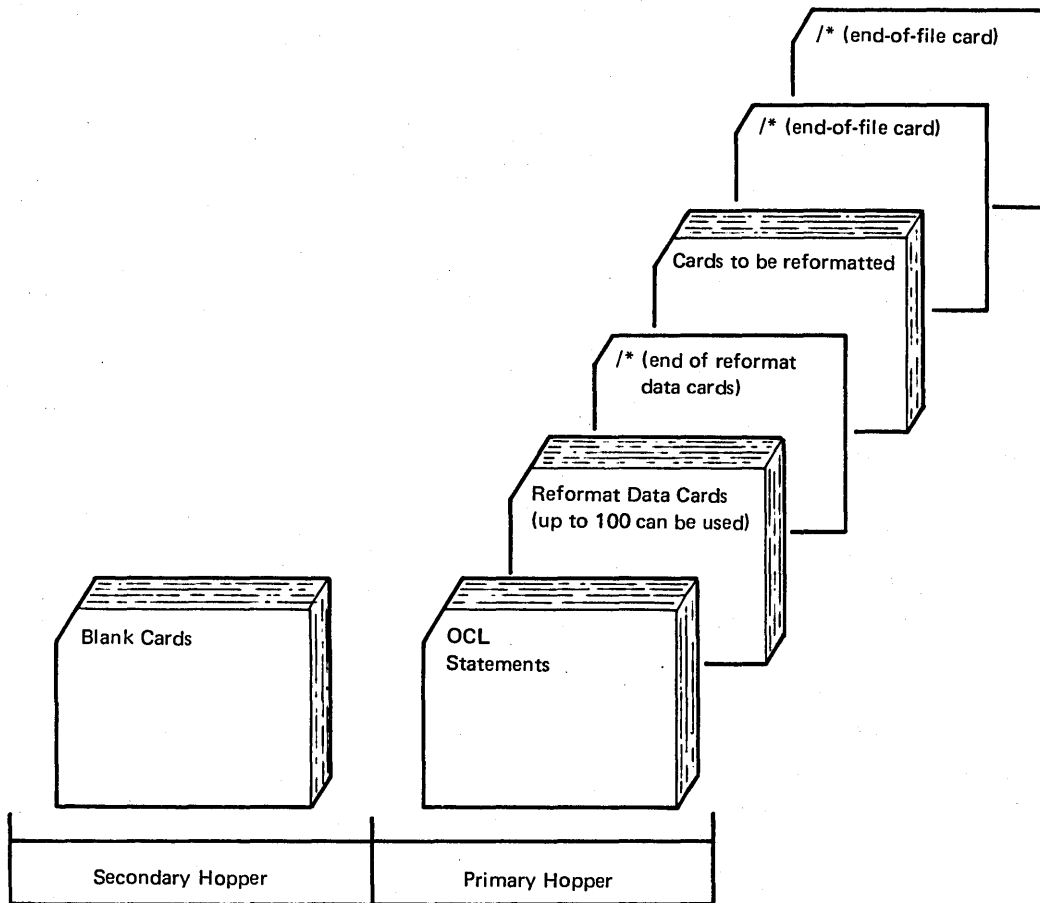

Figure 28. Input Deck for Reformatting

## Reformat Data Card

If reformatting is needed, reformat data cards must be punched to indicate the format of the new deck.

A reformat unit of six card columns is required to reformat a field. Up to 100 reformat units can be used. (A field is one or more columns on a card that contains the same or related information.) Several reformat units may be placed on one card or each unit can be placed on a separate card.

Figure 29 shows the format of a reformat data card. When reformatting is specified, all cards are reformatted except those with a /\* in columns 1 and 2; these cards are reproduced in their original format.

1	2	3	4	5	6	7	8	9	10
0	1	0	4	0	8				
a	a	b	b	c	c				
These six columns make one reformat unit									
A field beginning in column 01 (aa)		and ending in column 04 (bb) is being reproduced.				It will be reformatted so that in the new deck it will end in column 08 (cc). Therefore, the reformatted field will begin in column 05 in the new deck.			

Figure 29. Reformat Data Card Format

## Examples

**Moving Fields:** In this example, we want to switch fields 1 and 2. The deck to be reformatted is:

```
Card Column  1 2 3 4 5 6 7 8 9 10 11 12
             F I E L D 2 F I E L D 1
```

The reformat data card that will cause Fields 1 and 2 to be switched in the new deck is shown in Figure 30. The format of the new deck is:

```
Card Column  1 2 3 4 5 6 7 8 9 10 11 12
             F I E L D 1 F I E L D 2
```

**Deleting a Field:** In this example, we want to delete Field 6. The deck to be reformatted is:

```
Card
Column  51 52 53 54 55 56 57 58 59 60 61 62 63 64 65 66 67 68
        F I E L D 5 F I E L D 6 F I E L D 7
```

The reformat data card needed to punch a deck that does not contain Field 6 is shown in Figure 31. Columns 57-62 (Field 6) are not punched on the new cards because these columns are not included in the reformat data card. The format of the new deck is:

```
Card
Column  51 52 53 54 55 56 57 58 59 60 61 62 63 64 65 66 67 68
        F I E L D 5                               F I E L D 7
```

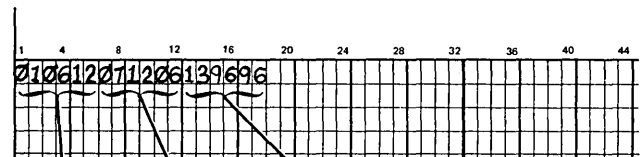

The field from columns 1-6 is punched in columns 7-12 in the new cards.

The field from columns 7-12 is punched in columns 1-6 in the new cards.

The remainder of the data fields are punched in their original position in the new cards.

Figure 30. Reformat Data Card: Moving Fields

0	1	5	6	5	6	6	3	9	6	9	6								
a	a	b	b	c	c	a	a	b	b	c	c								
All fields from columns 1-56 are punched in the same position in the new cards.						All fields from columns 63-96 are punched in the same position in the new cards.													

Figure 31. Reformat Data Card: Deleting a Field

For more information on reproduce and interpret, see the *IBM System/3 Sort/Collate and Card Utilities Reference Manual*, SC21-7529.

## MFCU SORT/COLLATE PROGRAM

The following steps are required for all sort/collate jobs.

1. Mount disk cartridge if specified on program run sheet, and ready disks.
2. Clear cards from MFCU.
3. Place OCL cards in primary hopper of MFCU. Load cards face down, top edge to the left.
4. Place sort specification cards in secondary hopper of MFCU. Figure 32 shows the input for sort/collate without alternate collating. Figure 33 shows the input for sort/collate with alternate collating.
5. Press MFCU START. PRIMARY READY and SECONDARY READY lights will turn on.
6. Ready printer.
7. Press console START (or appropriate HALT/RESET key if you have DPF) to load the program. When the program is loaded, it reads specifications cards and lists them on the logging device.

The system halts with one of the following values displayed in the message display unit:

- EE (ready to go halt). This halt signifies that the program is successfully loaded. Read the operating procedure for the job you are doing for further instructions.
- EL (conditional halt). Check message on logging device to determine cause (all sort/collate messages are described in Appendix B). Set rightmost ADDRESS/DATA switch to 0 and press console START (or appropriate HALT/RESET key if you have DPF) to continue. The message display unit changes to EE. Read the operating procedure for the job you are doing for further instructions.
- EA (terminal halt). This halt indicates that something is wrong with the specification deck. Check printout to determine the cause of the error. Set rightmost ADDRESS/DATA switch at 3 and press console START (or appropriate HALT/RESET key if you have DPF) to cancel the job. The sort/collate program must be reloaded after the error is corrected. If the message display unit contains a display other than EE, EL, or EA, check the list of program halts in the *IBM System/3 Model 10 Disk System Halt Guide*, GC21-7540.

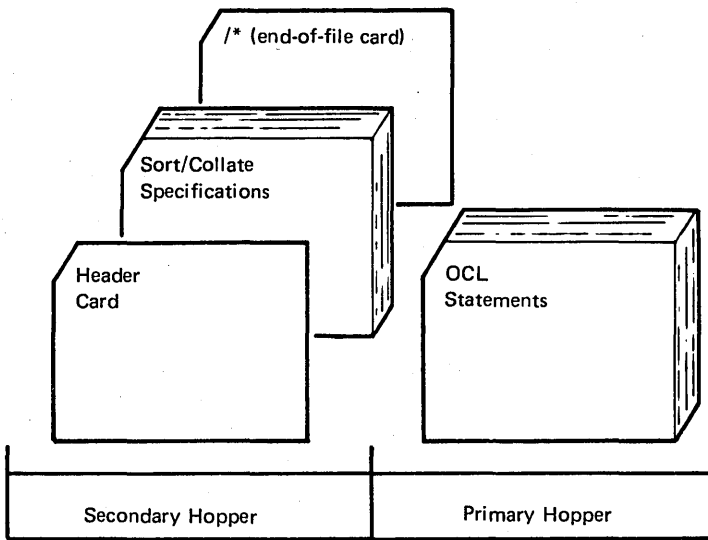

Figure 32. Input for Sort/Collate Without Alternate Collate Cards

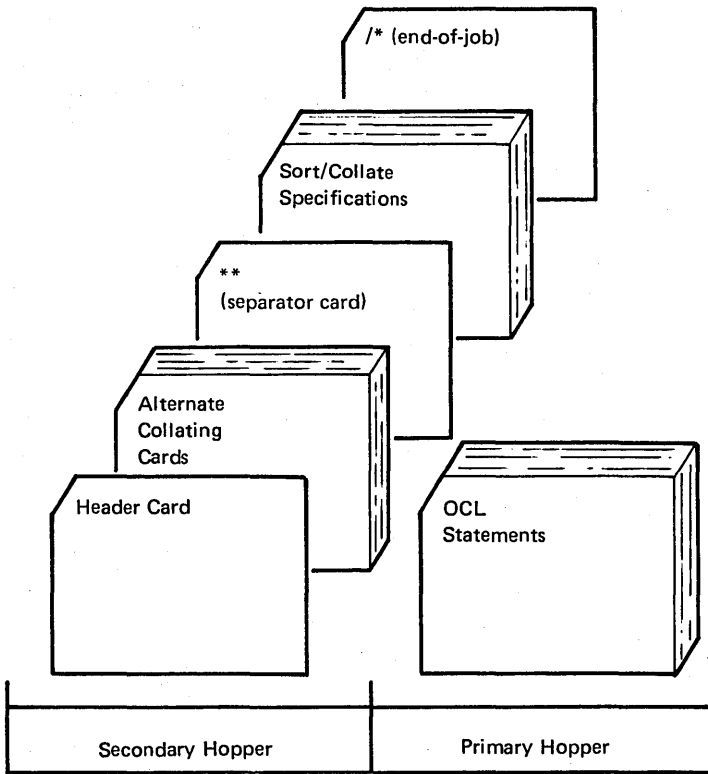

Figure 33. Input for Sort/Collate With Alternate Collate Cards

## Sort Operating Procedure

A complete file can be sorted or a file can be sorted after selected card types are removed. The first method is a simple sort; the second is a sort with omits.

### Sort (No Omits):

1. Clear cards from MFCU.
2. Divide card deck to be sorted. Place approximately one half of the card deck in the primary hopper of the MFCU and place the remaining cards in the secondary hopper.
3. Ensure that an end-of-file (/\*) card (if one is not there) is placed behind cards in each hopper. (Have two extra end-of-file cards available. These cards will save you time in the next pass of the program.)
4. Press MFCU START. The PRIMARY READY and SECONDARY READY lights turn on.
5. Set rightmost ADDRESS/DATA switch at 0.
6. Press console START (or appropriate HALT/RESET key if you have DPF).
7. Cards are read in from both hoppers and selected into all four stackers. If a stacker fills before the hoppers empty, take cards from stacker and place them in bin above stacker. Press MFCU START to continue.
8. When the pass is completed, the system halts with EP in the message display unit. A message indicating the number of passes remaining to complete the sort is printed on the logging device.
9. Place cards from stacker 1 and stacker 2 (in that order) in the primary hopper (Figure 34). Place cards (if any) from the stacker-1 bin in the primary hopper before the cards in stacker 1. The same procedure applies for stacker 2.
10. Place cards from stacker 3 and stacker 4 (in that order) in the secondary hopper (Figure 34). Before you place cards from stacker 3 in the secondary hopper, place the cards in the stacker-3 bin, if any, in the secondary hopper. The same procedure applies for stacker 4.
11. Place end-of-file cards behind decks in both hoppers.
12. Press MFCU START.
13. Set rightmost ADDRESS/DATA switch at 0.
14. Press console START (or appropriate HALT/RESET key if you have DPF).
15. The second pass of the sort is run and the system again halts with EP in the message display unit. Remove end-of-file cards from under the cards in stacker 1 and 3. You will use these cards in the next pass.
16. Repeat steps 9-15 until all cards are routed into stacker 1 (the end-of-file card from the secondary hopper will be in stacker 3). At this time, the system halts with EJ in the message display unit. Press MFCU NPRO key twice to run end-of-file cards out of unit. The sort is completed.

*Note:* If a halt other than EP or EJ occurs during the sort run, check list of program halts in the *IBM System/3 Model 10 Disk System Halt Guide, GC21-7540*.

*Note:* If you forget to remove one of the end-of-file cards (/\*) from under the cards in one of the stackers (step 15), you can save yourself an extra pass by performing the following:

1. Remove end-of-file cards from behind cards in both hoppers and let the pass continue.
2. Wait for I/O ATTENTION. One hopper is empty and the other hopper has cards in it. The cards remaining in the hopper are there because the system has read the misplaced end-of-file card and does not expect any more cards from that hopper, but is looking for more cards from the empty hopper.
3. Remove remaining cards from hopper and place them in empty hopper.
4. Place end-of-file card after cards in hopper.
5. Press MFCU START. The pass continues.

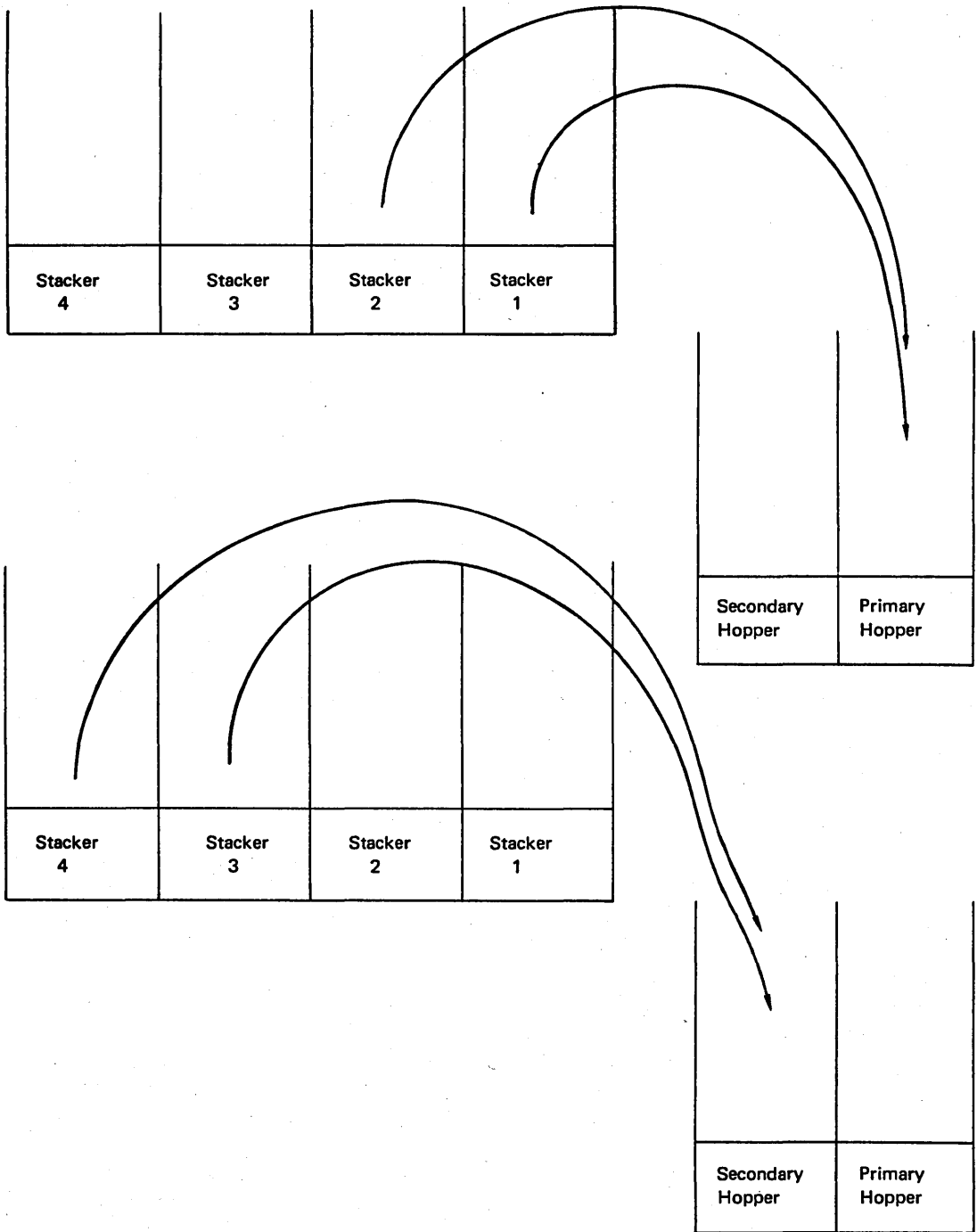

Figure 34. Stacker to Hopper Sequence During Sort. Don't forget any cards in bins. When the cards are sorted such that only stacker 1 and stacker 3 are used, place the cards in stacker 1 in the primary hopper; the cards in stacker 3 in the secondary hopper. When all cards being sorted are in stacker 1, the run is finished.



*Sort (With Omits):*

1. Clear cards from MFCU.
2. Divide card deck to be sorted. Place approximately one half of the card deck in the primary hopper of the MFCU and place the remaining cards in the secondary hopper.
3. Place an end-of-file (/\*) card (if one is not there) behind cards in each hopper. (Have two extra end-of-file cards available. These cards will save you time in the next pass of the program.)
4. Press MFCU START. PRIMARY READY and SECONDARY READY lights turn on.
5. Set rightmost ADDRESS/DATA switch at 0.
6. Press console START (or appropriate HALT/RESET key if you have DPF).
7. Cards are read from both hoppers and selected into all four stackers.  
  
If a stacker fills before hoppers empty, take cards from the stacker and place them in bin above stacker. Press MFCU START to continue.
8. When the pass is completed, the system halts with EO in the message display unit. A message indicating the number of passes remaining to complete the sort is printed on the logging device.
9. Take cards from stackers 2 and 4 and set them aside. These are the omitted cards.
10. Place any cards in bin above stacker 1 in primary hopper, then place cards from stacker 1 in primary hopper.

11. Place cards from stacker 3 in secondary hopper.
12. Place end-of-file cards behind decks in both hoppers.
13. Press MFCU START.
14. Set rightmost ADDRESS/DATA switch at 0.
15. Press console START (or appropriate HALT/RESET key if you have DPF).
16. The second pass of the sort is run and the system halts with EP in the message display unit. Remove end-of-file cards from under the cards in stackers 1 and 3. You will use these cards in the next pass.
17. Do steps 8-16 of the Sort (No Omits) procedure.

*Note:* If you forget to remove one of the end-of-file cards (/\*) from under the cards in one of the stackers (step 16), you can save yourself an extra pass by doing the following:

1. Remove end-of-file cards from behind cards in both hoppers and let the pass continue.
2. Wait for I/O ATTENTION. One hopper is empty and the other hopper has cards in it. The cards remaining in the hopper are there because the system has read the misplaced end-of-file card and does not expect any more cards from that hopper, but is looking for more cards from the empty hopper.
3. Remove remaining cards from hopper and place them in empty hopper.
4. Place end-of-file card after cards in hopper.
5. Press MFCU START. The pass continues.

### Merge

Merge is a one-pass operation.

1. Clear cards from MFCU.
2. Place primary file in primary hopper.
3. Place secondary file in secondary hopper.
4. Press MFCU START. PRIMARY READY and SECONDARY READY lights turn on.
5. Set rightmost ADDRESS/DATA switch at 0.
6. Press console START (or appropriate HALT/RESET key if you have DPF).
7. Cards are read in from both hoppers, merged, and routed to stacker 1.

A sequence error causes the system to halt with E1 (primary hopper) or E2 (secondary hopper) in the message display unit. The recovery procedures for these errors are included in the list of program halts in the *IBM System/3 Model 10 Disk System Halt Guide*, GC21-7540. Any omit cards from the primary hopper go to stacker 2. Any omit cards from the secondary hopper go to stacker 4.

When the pass is complete, the system halts with EJ in the message display unit. If the message display unit contains a display other than EJ, check the list of program halts in the *IBM System/3 Model 10 Disk System Halt Guide*, GC21-7540.

### Match

The program run sheet should indicate which type of output appears in which stacker.

1. Clear cards from MFCU.
2. Place primary file in primary hopper. The last card must be an end-of-file card.
3. Place secondary file in secondary hopper. The last card must be an end-of-file card.
4. Press MFCU START. PRIMARY READY and SECONDARY READY lights turn on.

5. Set rightmost ADDRESS/DATA switch at 0.
6. Press console START (or appropriate HALT/RESET key if you have DPF).
7. Cards are routed to any or all stackers.

A sequence error causes the system to halt with E1 (primary hopper) or E2 (secondary hopper) in the message display unit. The recovery procedures for these errors are included in the list of program halts in the *IBM System/3 Model 10 Disk System Halt Guide*, GC21-7540.

When the pass is completed, the system halts with EJ in the message display unit. If the message display unit contains a display other than EJ, check the list of program halts in the *IBM System/3 Model 10 Disk System Halt Guide*, GC21-7540.

### Select

1. Clear cards from MFCU.
2. Place file in primary hopper. The last card must be an end-of-file card.
3. Press MFCU START. PRIMARY READY turns on.
4. Set rightmost ADDRESS/DATA switch at 0.
5. Press console START (or appropriate HALT/RESET key if you have DPF).
6. Cards are routed to the stackers as follows:
  - Non-selected cards to stacker 4.
  - Selected cards to any or all of the remaining stackers (1, 2, and 3).

A sequence error in a sequenced file causes the system to halt with E1 in the message display unit. The recovery procedure for this error is in the list of program halts in the *IBM System/3 Model 10 Disk System Halt Guide*, GC21-7540.

When the pass is completed, the system halts with EJ in the message display unit. If the message display unit contains a display other than EJ, check the list of program halts in the *IBM System/3 Model 10 Disk System Halt Guide*, GC21-7540.

## DATA RECORDING PROGRAM

The data recording program enables you to use System/3 for recording data in punched cards, using the IBM 5475 Data Entry Keyboard. The following procedure is used for loading the data recording program into storage, allowing the data entry keyboard to be used for data recording. For more information on the data recording program and the data entry keyboard, see the *IBM System/3 Sort/Collate and Card Utilities Reference Manual*, SC21-7529.

### Program Load Procedure

1. Mount disk cartridge as specified on Program Run Sheet, if any, and ready disks.
2. Remove cards from both hoppers of MFCU.
3. Clear cards from MFCU.
4. Remove any cards from stackers.
5. Place OCL statements in primary hopper of MFCU. Load cards face down, top edge to the left.
6. Place cards to be punched in secondary hopper of MFCU. Load cards face down, top edge to the left.
7. Press MFCU START. PRIMARY READY and SECONDARY READY lights turn on.
8. Press console START (or appropriate HALT/RESET key if you have DPF).
9. When the column indicator on the keyboard panel comes on, showing 01, the program has been loaded. (If 01 does not light, check to make sure there are cards in the secondary hopper.)
10. When the column indicator shows 01, press MFCU STOP.
11. Press NPRO on the MFCU control panel once. (This removes the last card fed and stacks it in stacker 1.)
12. Press MFCU START. Data recording can now begin, unless program control cards are to be used.

A program control card causes specified functions to be performed automatically and must be loaded into storage before data recording can begin. For more information on the program control card and how to load it, see the *IBM System/3 Sort/Collate and Card Utilities Reference Manual*, SC21-7529.

## DATA VERIFYING PROGRAM

The Data Verifying program enables you to verify previously punched cards, using the IBM 5475 Data Entry Keyboard. The following procedure is used for loading the data verifying program into storage, allowing the data entry keyboard to be used for data verifying. For more information on the data verifying program and the data entry keyboard, see the *IBM System/3 Sort/Collate and Card Utilities Reference Manual*, SC21-7529.

### Program Load Procedure

1. Mount indicated disk cartridge as specified on Program Run Sheet, if any, and ready disks.
2. Remove cards from both hoppers of MFCU.
3. Clear cards from MFCU.
4. Remove any cards from stackers.
5. Place OCL statements in primary hopper of MFCU. Load cards face down, top edge to the left.
6. Place punched cards to be verified, followed by a blank card, in the secondary hopper. Load cards face down, top edge to the left.
7. Press MFCU START. PRIMARY READY and SECONDARY READY lights turn on.
8. Press console START (or appropriate HALT/RESET key if you have DPF).
9. When the column indicator on the keyboard panel comes on, showing 01, the system is ready for data verifying.
10. When the column indicator shows 01, press MFCU STOP.
11. Press MFCU NPRO and remove cards from stacker 1.
12. Press MFCU START. Data verifying can now begin, unless program control cards are to be used.

A program control card causes specified functions to be performed automatically and must be loaded into storage before data recording can begin. For more information on the program control card and how to load it, see the *IBM System/3 Sort/Collate and Card Utilities Reference Manual*, SC21-7529.

## DISK SORT PROGRAM

*Note:* If you are using the 1442, see *Using the 1442 as the Only Card Input Device* in Chapter 10. *System Operation*.

1. Mount disk cartridges (and tape reels, if you are using the Disk Sort Tape I/O Option) as specified on program run sheet and ready disks and tape units.
2. Ready printer.
3. Press console START (or appropriate HALT/RESET key if you have DPF). Various program halts can occur while the disk sort program is running. See the *IBM System/3 Model 10 Disk System Halt Guide*, GC21-7540, for the action you are to take.
4. Enter the required OCL statements and sort sequence specifications through the system input device (see Figure 35). When the job is complete, EJ is displayed on the message display unit.

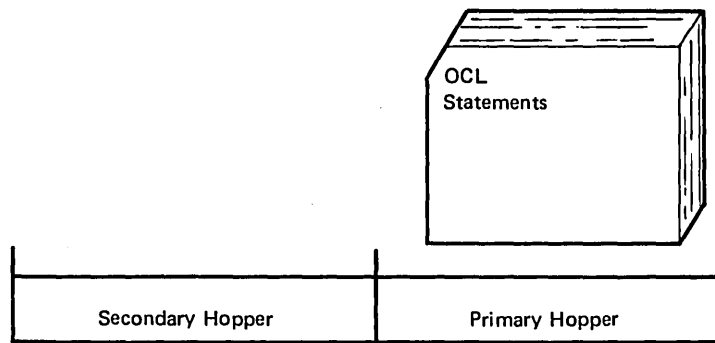

All sort specifications are in a procedure on disk. Only OCL statements are required to run the job.

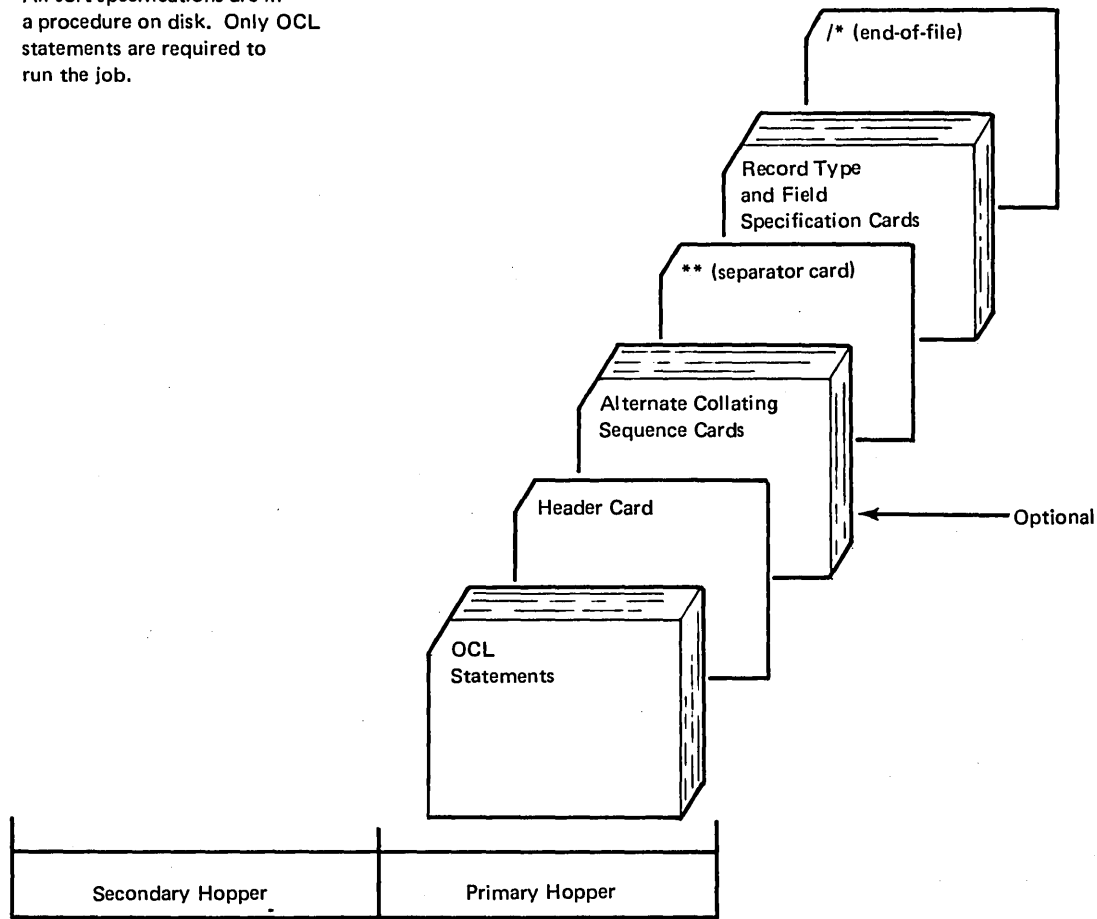

The sort specifications are on cards and follow the OCL statements.

Figure 35. Possible Input for Disk Sort

The sort OCL, the sort sequence specifications, or both may be copied from the source library on disk.

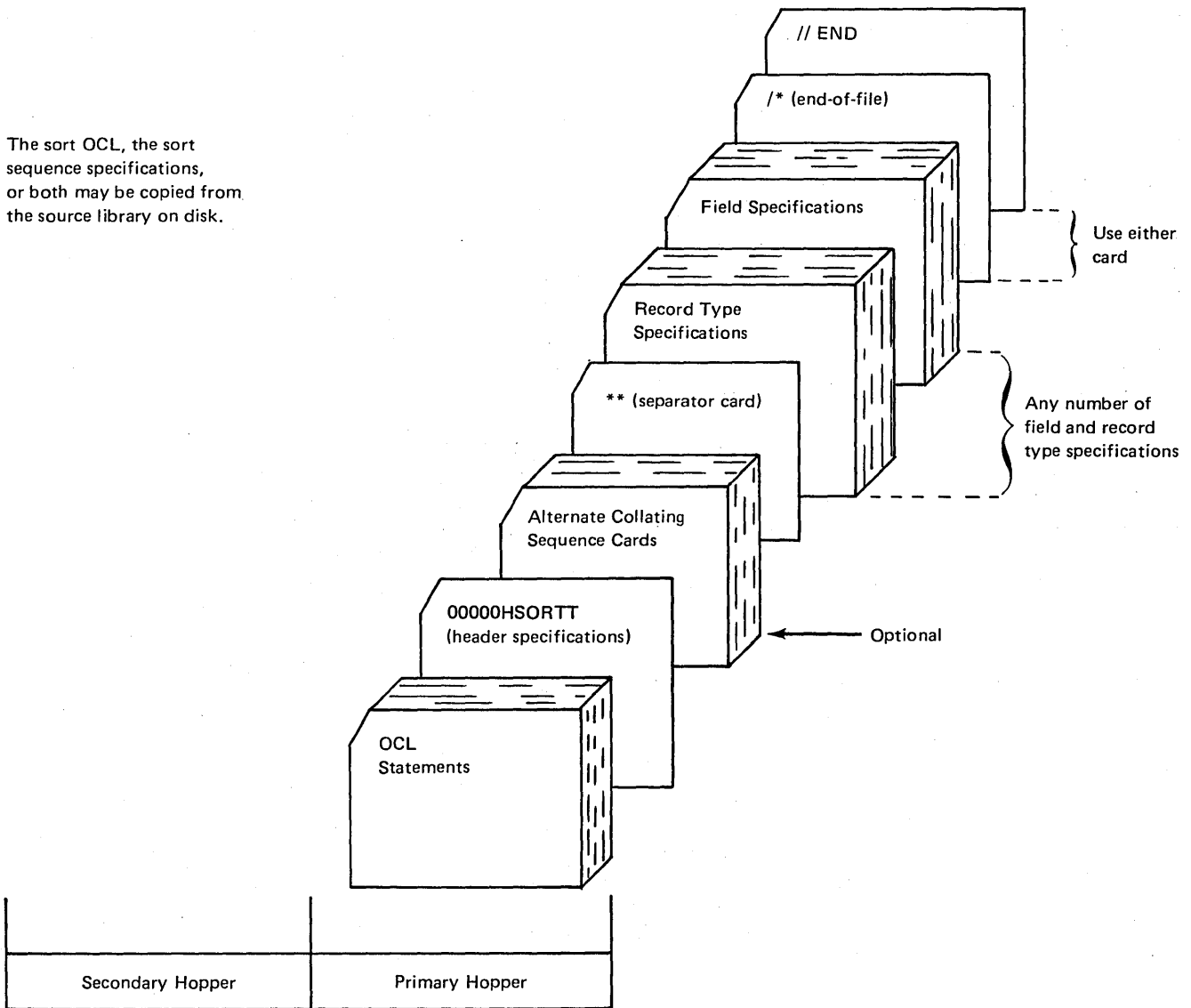

The sort specifications are on cards and follow the OCL statements.

● Figure 36. Possible Input for Tape Sort

## TAPE SORT PROGRAM

*Note:* If you are using the 1442, see *Using the 1442 as the Only Card Input Device* in Chapter 10. *System Operation*.

1. Mount disk cartridges and tape reels as specified on the program run sheet and ready disks and tape units.
2. Ready printer.
3. Press console START (or appropriate HALT/RESET key, if you have DPF). Various program halts can occur while the tape sort program is running. See the *IBM System/3 Model 10 Disk System Halt Guide*, GC21-7540, for the action you are to take.
4. Enter the required OCL statements and sort sequence specifications by means of the system input device (see Figure 36). When the job is complete, EJ is displayed on the message display unit.
4. The assembler program can punch an object deck if requested. This should be indicated to you on the program run sheet. If an object deck will be punched, place blank cards in the secondary hopper of the MFCU.
5. Press MFCU START. PRIMARY READY turns on. SECONDARY READY turns on if blank cards are in the secondary hopper.
6. Ready printer.
7. Press console START (or appropriate HALT/RESET if you have DPF),

See the *IBM System/3 Model 10 Disk System Halt Guide*, GC21-7540 for recovery procedures if program halts are displayed on the message display unit.

## BASIC ASSEMBLER PROGRAM

1. Mount disk cartridge as specified on program run sheet, and ready disks.
2. Clear cards from MFCU.
3. Place OCL statements and assembler source deck (Figure 37) in the primary hopper of the MFCU.
8. When the job is complete, EJ is displayed on the message display unit.
9. Punched cards, if any, will be in stacker 4 of the MFCU. The OCL statements and assembler source deck will be in stacker 1.

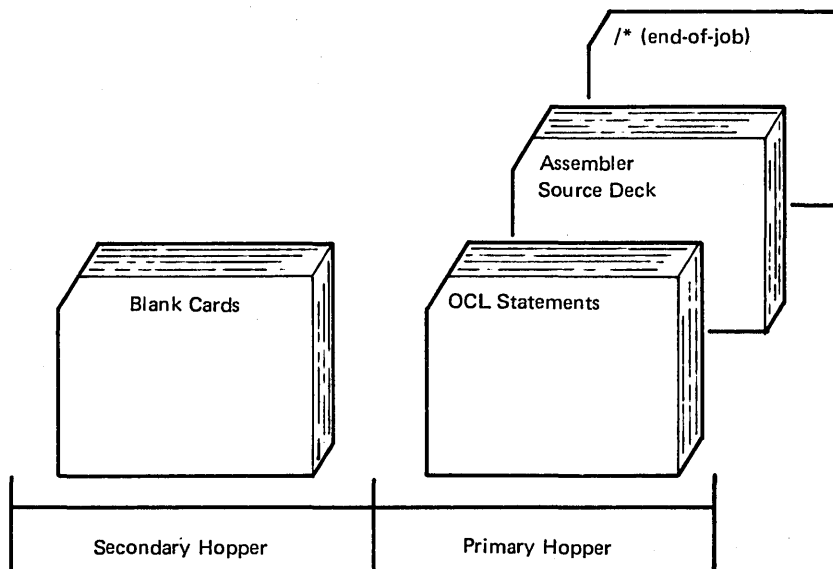

Figure 37. Input for Basic Assembler Program

### Execution of a Basic Assembler Object Program

1. Clear cards from MFCU.
2. Place punched absolute loader cards and object deck (Figure 38) in primary hopper of MFCU. Load cards face down, top edge to the left.
3. Press MFCU START. PRIMARY READY light turns on. If cards are in the secondary hopper, the SECONDARY READY turns on.
4. Ready printer.
5. Set program load selector at MFCU.
6. Press console PROGRAM LOAD. The object program is loaded and execution begins.
7. Perform the IPL process after execution of the Basic Assembly object program is complete.

During the execution of the object program, halts can occur. These halts are not necessarily related to the halts described in the *IBM System/3 Model 10 Disk System Halt Guide*, GC21-7540, because the programmer can use any halts desired. Also, the halt indicating that the object program is complete does not have to be EJ. The program run sheet, supplied to you by the programmer, indicates the halts that will occur and the action you should take.

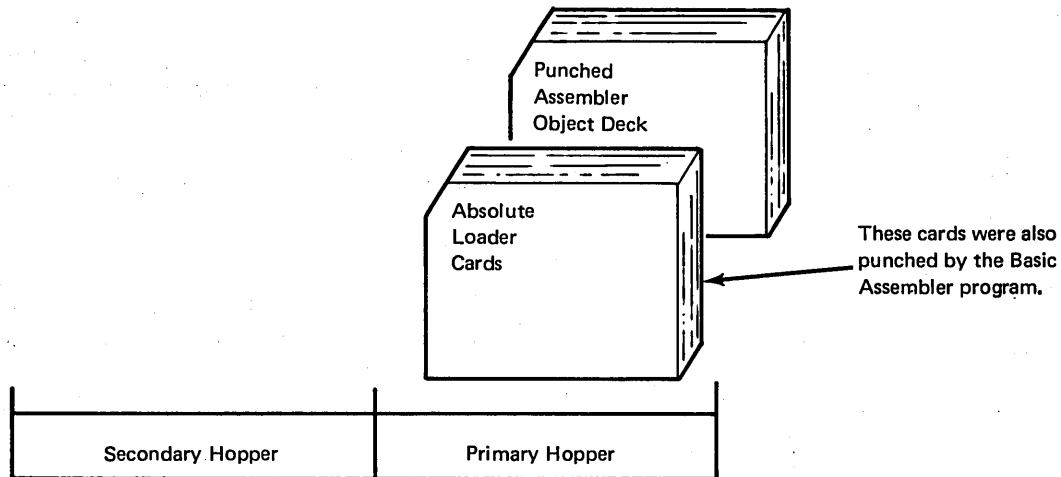

Figure 38. Input for Basic Assembler Object Program Execution



## DISK UTILITY PROGRAMS

Your resident system includes a group of disk utility programs. These programs do a variety of jobs, from preparing disks for use to adding new or changed programs to the system. The utility programs are:

- **Disk Initialization**—prepares a disk for use. This program must be run for each new disk that is used for the first time or when the contents of a disk can be erased.
- **Alternate Track Assignment**—assigns alternate tracks to disk tracks that become defective after they are initialized. The data on the defective track is transferred to the alternate track.
- **Alternate Track Rebuild**—corrects data that could not be transferred to an alternate track or was transferred in error.
- **File and Volume Label**—prints the contents of an area on disk called the volume table of contents (VTOC). This area contains information on all data files (groups of related records) on disk.
- **File Delete**—deletes files on disk by modifying the VTOC indicating the files no longer needed.
- **Disk Copy/Dump**—copies the contents of one disk to another, copies a data file from one disk to another, copies a data file from one location to another on the same disk, and prints the contents of a data file.
- **Library Maintenance**—builds, maintains, and services disk resident source and object libraries.

The source library is an area on disk used to store procedures and source statements. Procedures are groups of OCL statements that are used to run a particular program. The object library is an area on disk used to store executable programs and subroutines. The system programs are stored in an object library.

Each utility program to be run has OCL statements followed by control statements. The OCL statements consist of a LOAD statement, in some cases one or more FILE statements, and a RUN statement. The LOAD statement has the name of the utility program to be run. The FILE statement provides the system with information about groups of related records called files. The RUN statement tells the utility program to begin.

Control statements follow the OCL statements. These control statements are read by the utility program. They tell the utility program what to do. The last statement of the control statements is a // END card. This statement tells the utility that there are no more control statements.

For more information on the utility programs and their OCL and control statements, see the *IBM System/3 Model 10 Disk System Control Programming Reference Manual*, GC21-7512.

### Operating Procedures

Operating procedures for the disk utility programs are the same, except for the disk copy/dump and library maintenance programs. Procedures for Disk Copy/Dump and Library Maintenance are discussed later in this section.

#### *Operating Procedures for all Disk Utility Programs but Disk Copy/Dump and Library Maintenance*

1. Mount disk cartridge if specified on program run sheet, and ready disks.
2. Clear cards from the reader.
3. Place OCL statements and control statements in reader (primary hopper of MFCU, Figure 39).
4. Press reader START. The PRIMARY READY light comes on on the MFCU; READY on the 1442.
5. Ready the printer.
6. Press console START (or appropriate HALT/RESET key if you have DPF). The utility program performs the functions indicated on the control statements. An EJ halt appears on the message display unit when the utility program is completed.

See the *IBM System/3 Model 10 Disk System Halt Guide*, GC21-7540, for other programmed halts and how to recover from them.

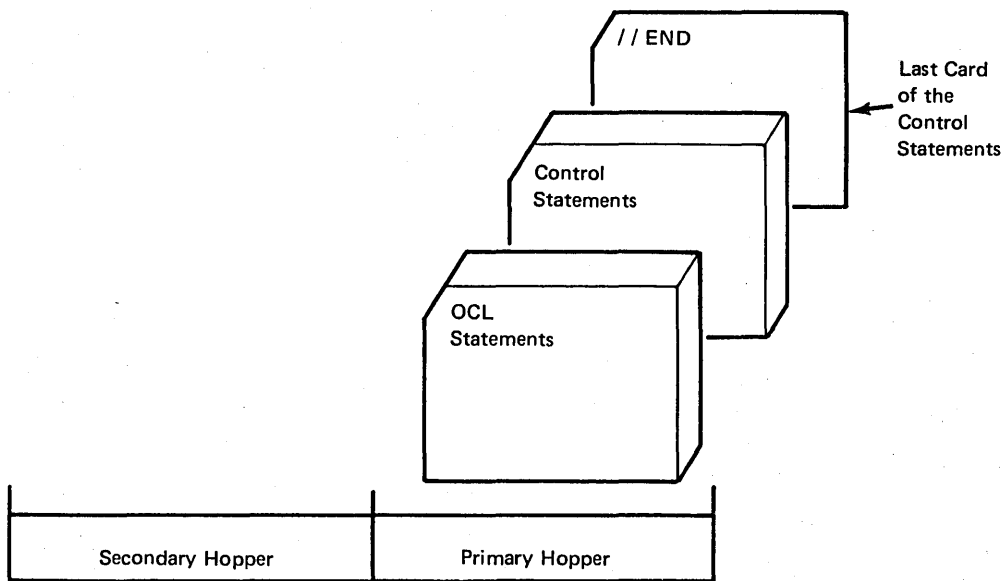

Figure 39. Input for All Utility Programs

#### Operating Procedures for Disk Copy/Dump Utility Program

Operating procedures for disk copy/dump are the same as for the other utility programs except when you have to mount several different cartridges on the same drive during the running of the program. The program run sheet indicates when this type of disk copy/dump program will be run.

1. Mount disk cartridge if specified on program run sheet, and ready disks.
  2. Clear cards from reader.
  3. Place OCL statements and control statements in the reader (primary hopper of the MFCU).
  4. Press reader START. PRIMARY READY comes on on the MFCU; READY on the 1442.
  5. Ready the printer.
  6. Press console START (or appropriate HALT/RESET key if you have DPF).
- For a particular type of disk copy/dump program you will have to mount several different cartridges. Program halts indicate when it is time to do this. This particular form of program works as follows:
- The program is going to copy data from one removable disk on R1 to another removable disk on R1. This kind of operation requires that you mount different cartridges at different times:
1. The preceding steps 1 through 6 have been performed. You have mounted the proper cartridge on R1.
  2. After the program has copied data to the fixed disk, a program halt of 37 will occur. At that time you must mount the cartridge the program is going to copy the data onto. Keep the cartridge you removed handy, you will have to mount it again in step 5.
  3. Set rightmost ADDRESS/DATA switch at 0.
  4. Press console START (or appropriate HALT/RESET key if you have DPF). If you mounted the wrong cartridge, a halt of 38 will occur. To correct this, mount the correct cartridge, set rightmost ADDRESS/DATA switch to 0, and press console START (or appropriate HALT/RESET key if you have DPF).
  5. When the data has been copied, another program halt of 37 will occur. At this time you must remount the cartridge you previously removed.
  6. Set rightmost ADDRESS/DATA switch at 0.
  7. Press console START (or appropriate HALT/RESET key if you have DPF).
  8. Perform steps 2 through 5 as many times as necessary to get all the data copied onto the removable cartridge.
  9. When the utility program is completed, EJ is displayed in the message display unit.

### Operating Procedures for Library Maintenance Utility Program

The library maintenance utility program can create, delete, reorganize or change the size of a library, copy data, read from cards to a library (Figure 40), punch data on cards (Figure 41), and print data on the printer from data in a library. The type of library maintenance utility program being run will be indicated on the program run sheet.

The following operating procedures cover all of these possibilities:

1. Mount disk cartridge as specified on program run sheet and ready disks.
2. Clear cards from MFCU.
3. Place OCL statements, control statements, and data cards (if any) in the primary hopper of the MFCU. Place cards face down, top edge to the left.
4. Place blank cards in secondary hopper of MFCU, if specified on the program run sheet.
5. Press MFCU START. PRIMARY READY turns on. SECONDARY READY turns on if cards are in the secondary hopper.
6. Ready the printer.
7. Press console START (or appropriate HALT/RESET key if you have DPF).
8. Halt EJ is displayed when the job is completed.
9. Any cards punched by this particular library maintenance utility program are deposited in stacker 4. Remove them from the stacker.

If any program halts occur while the utility program is running, see the *IBM System/3 Model 10 Disk System Halt Guide*, GC21-7540, for recovery procedures.

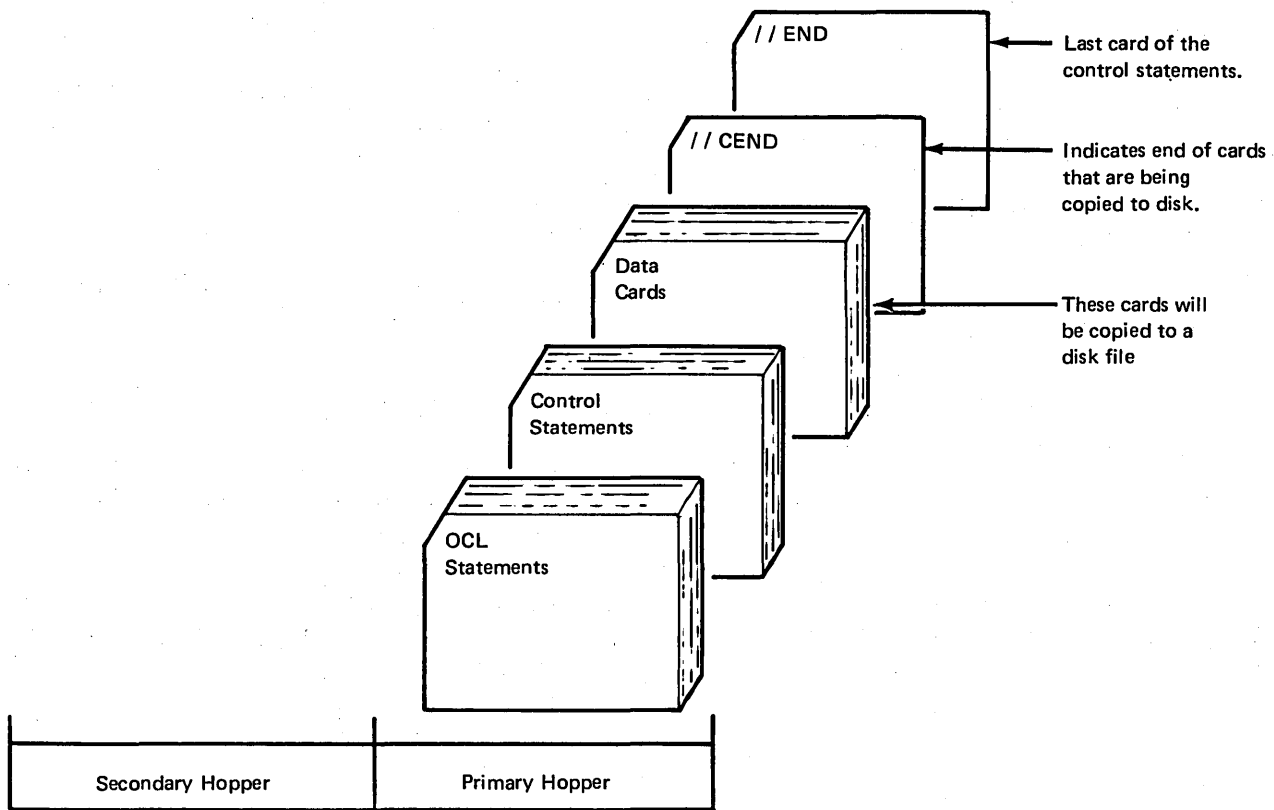

Figure 40. Input for Library Maintenance Utility Program That Copies Data from Cards to a Disk File

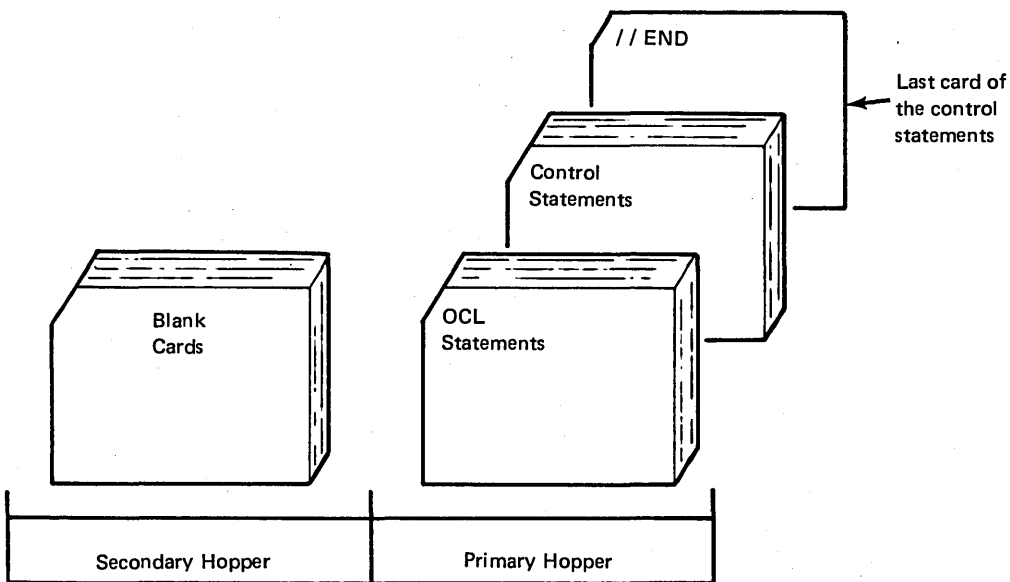

Figure 41. Input for Library Maintenance Utility Program That will Punch Cards

## DISK RESIDENT TAPE UTILITY PROGRAMS

If your system includes magnetic tape, the following tape utility programs are included in your resident system:

- **Tape Initialization** — prepares tapes for use. Checks labeled tapes for a volume label and unexpired files, writes IBM standard volume labels on them, and displays the volume and header labels.

*Note:* User labels are not checked by System/3 tape data management and cannot be written as part of the label group.

- **Tape Volume Error Statistics** — prints a summary by tape volume and tape unit of certain tape errors. Counters of these errors are recorded on the tracks reserved for the IBM Customer Engineer on disk unit F1.

For complete information about tape utility programs and the related OCL statements and utility control statements, see *IBM System/3 Model 10 Disk System Control Programming Reference Manual*, GC21-7512.

## Operating Procedures

Operating procedures are the same for the two tape utility programs:

1. Mount disk cartridges and tape reels (up to 4 for tape initialization — 1 per tape unit) specified on program run sheet, and ready disks and tape units.
2. Clear cards from MFCU.
3. Place OCL statements and control statements in primary hopper of MFCU (Figure 39).
4. Press MFCU START. The PRIMARY READY light comes on.
5. Ready the printer.
6. Press console START (or appropriate HALT/RESET key if you have DPF). The utility program performs the functions indicated on the control statements. An EJ halt appears on the message display unit when the utility program is completed.

See the *IBM System/3 Model 10 Disk System Halt Guide*, GC21-7540, for other programmed halts and how to recover from them.

### USE OF CHECKPOINT/RESTART AND EXECUTION OF A CHECKPOINT PROGRAM

Checkpoint is a means of recording the status of a user program at desired intervals. Restart is the facility to resume the execution of the checkpointed program from the last checkpoint rather than from the beginning, if processing is terminated for any reason (except controlled cancel) before the normal end of job. For example, some malfunction such as a power failure may occur and cause an interruption. No intervening program executions are allowed between the failure and the restart. The checkpoint request is accepted only if the checkpoint program is executed in program level 1.

*Note:* Compilers and linkage editors should not run in conjunction with a LOAD \* or temporary checkpoint program in program level 1. When the program is cataloged, because the checkpoint program is terminated (immediate cancel), the checkpoint program may be deleted before the restart.

1. When halt HY is displayed in the message display unit, perform the following procedures when a checkpoint request has been accepted (the program run sheet for the checkpoint program should be used to communicate repositioning aids to the operator). If the MFCU is being used, remove cards from stackers and set them aside. They will not be used again by this job.
2. If the printer is being used, record the number of the line printed so the paper in the printer can then be repositioned to this line if the program must be restarted.
3. If the 1442 is being used, see the program run sheet for 1442 repositioning procedures.
4. If tape is being used, record the external label information so the proper tape reel can be remounted and rewound if the program must be restarted.
5. Set rightmost ADDRESS/DATA switch at 0.
6. Press console START (or appropriate HALT/RESET key if you have DPF) and the checkpoint program will resume execution.

### Removing Cards Prior to Restarting a Checkpoint Program

1. Check the program run sheet to determine if the MFCU was being used. If the MFCU was not being used, proceed to step 7.
2. Remove cards from the primary hopper. Indicate that these cards came from the primary hopper. You will have to use these cards later.
3. Press MFCU NPRO. Place card fed into stacker 1 in front of cards removed from the primary hopper.
4. Remove cards from the secondary hopper. Indicate that these cards came from the secondary. You will have to use these cards later.
5. Press MFCU NPRO. Place card fed into stacker 2 in front of cards removed from the secondary hopper.
6. Remove any cards from stackers and place them in their proper order in front of cards for their appropriate hopper.

*Note:* Carefully consider the sequence in which the cards in the stackers were originally processed to ensure that they are reprocessed in the same sequence.

7. Check the program run sheet to determine if the checkpointed program was using the 1442. If the 1442 was being used, see the program run sheet for 1442 repositioning procedures.
8. Remove disk cartridges or packs or tapes as specified on program run sheet.

### Restarting a Checkpointed Program

1. Submit the following OCL statements to load Restart:

```

  // LOAD $$RSTR,unit
  // RUN
  
```

(In order to guarantee the required minimum size for program level 2, a PARTITION statement may be required. Also, to reestablish the log device a LOG statement may be required.)

2. When halt H~~h~~ is displayed in the message display unit the logged error code (or subhalt) gives the reason for the halt. You may have:
  - a. Subhalt AC: attempted restart without an active checkpoint.
  - b. Subhalt CS: reserved storage with the PARTITION statement required by the checkpointed program. Proceed to step 9 to cancel.
  - c. Subhalt nn where nn is the number of the requested checkpoint. You may:
    - Cancel, Proceed to step 9.
    - Control cancel to delete the active checkpoint and immediate cancel. Proceed to step 9.
    - Check the program run sheet to determine if the checkpoint program was using the MFCU. If the MFCU was not being used, proceed to step 4.
3. Place cards back in appropriate hoppers of the MFCU and press MFCU START.
4. Check the program run sheet to determine if the checkpointed program was using the printer. If the printer was not being used, proceed to step 6.
5. Reposition the paper in the printer to the line that was being printed when the last checkpoint was accepted. To reposition the paper:
  - a. Disengage the carriage clutch.
  - b. Position the forms using the vertical adjustment knob until the crease between the forms is aligned with the upper scribe line on the forms guide.
  - c. Press the CARRIAGE RESTORE key.
  - d. Engage the carriage clutch.
  - e. Press the carriage space key until the paper is at the line at which the checkpoint was accepted.
  - f. If the printer has dual feed carriage feature and two forms were used, both forms must be repositioned. Unequal length forms must maintain the same relative position after repositioning that they had when the checkpoint request was accepted.
  - g. Press printer START.
6. Check the program run sheet to determine if the checkpointed program was using the 1442. If the 1442 was not being used, proceed to step 8.
7. See the program run sheet for 1442 repositioning procedures.
8. Mount disk cartridges or packs as specified on program run sheet and ready disk drives.
9. Set rightmost ADDRESS/DATA switch at 0 to allow the job to restart, set rightmost ADDRESS/DATA switch at 2 to de-activate checkpoint and immediate cancel, or set rightmost ADDRESS/DATA switch at 3 to cancel the job.
10. Press console START (or appropriate HALT/RESET key if you have DPF). If you cancelled the job, go to step 1.

11. If H~~alt~~ occurs again:

- a. If the program uses tape files, you may have to mount a different tape reel or rewind the reel that is on the tape unit. When the proper tape reel is mounted, set the rightmost ADDRESS/DATA switch at 1 to allow the job to continue or set the switch at 3 to cancel the job. Press START (HALT/RESET if you have DPF).

If the halt reoccurs for the same tape unit, the file LABEL, or volume sequence number of the tape mounted does not match the file LABEL, or volume sequence number of the tape mounted at the last checkpoint. Mount the correct tape and select the appropriate option using the ADDRESS/DATA switch as in the preceding paragraph. If volumes of a multi-reel file were processed out of sequence, set the rightmost ADDRESS/DATA switch to 0.

- b. You may have mounted the wrong disk cartridge. After you have ensured that the correct cartridge is mounted, set the rightmost ADDRESS/DATA switch at 1 to allow the job to continue or set the switch at 3 to cancel the job.

If any other halts occur during the preceding procedures, refer to the *IBM System/3 Model 10 Disk System Halt Guide*, GC21-7540, for recovery procedures.

#### Intervening Programs

Programs can be executed in the time between failure and restart of a checkpointed program. The following list should be adhered to since there is no system protection provided:

- The checkpoint program must have been permanently cataloged. (LOAD \* must not be used.)
- If the intervening program must use the 1442 and the checkpointed program used the 1442, the user's restart routine must reposition the cards in the 1442 to the status at the active checkpoint.

- If any tapes processed by the basic tape access method (BTAM) or by direct call to tape IOS in the checkpointed program must be dismounted to allow the intervening program to use the tape units, the user's restart routine must reposition the tapes to the status at the active checkpoint.
- SMAINT must not be executed in the time between failure and restart of checkpointed program.
- The RPG II, FORTRAN, and COBOL compilers and the assembler can be executed if the object program is punched or cataloged to a pack other than the program (load) pack of the checkpoint program. That is, do not catalog something of the same name as the checkpoint program on the program pack of the checkpoint program.
- To execute the overlay linkage editor or the assembler all FILE statements must be supplied.
- Intervening programs must not access disk volumes used by the active checkpointed program for new, scratch, or RETAIN-A files.
- When copying from R1 to R1, any packs used by the active checkpointed programs must not be used if they contain new, scratch, or RETAIN-A files.
- Disk files used by the checkpointed program should not be modified by an intervening program if the user's restart routine restores selected records in the files. This destroys the updates of the intervening program.
- All fixed disk packs must be the same packs at restart, if used by the checkpointed program, as were online at the last checkpoint since the fixed packs are not verified.
- Intervening and active checkpointed programs must not add to the same file.

*Note:* The checkpoint must be deactivated before loading an inquiry-evoking program or loading a checkpoint program into program level 1.



- Performing System Generation Using the MFCU or 1442
- Performing System Generation Using the 5471 Printer/Keyboard

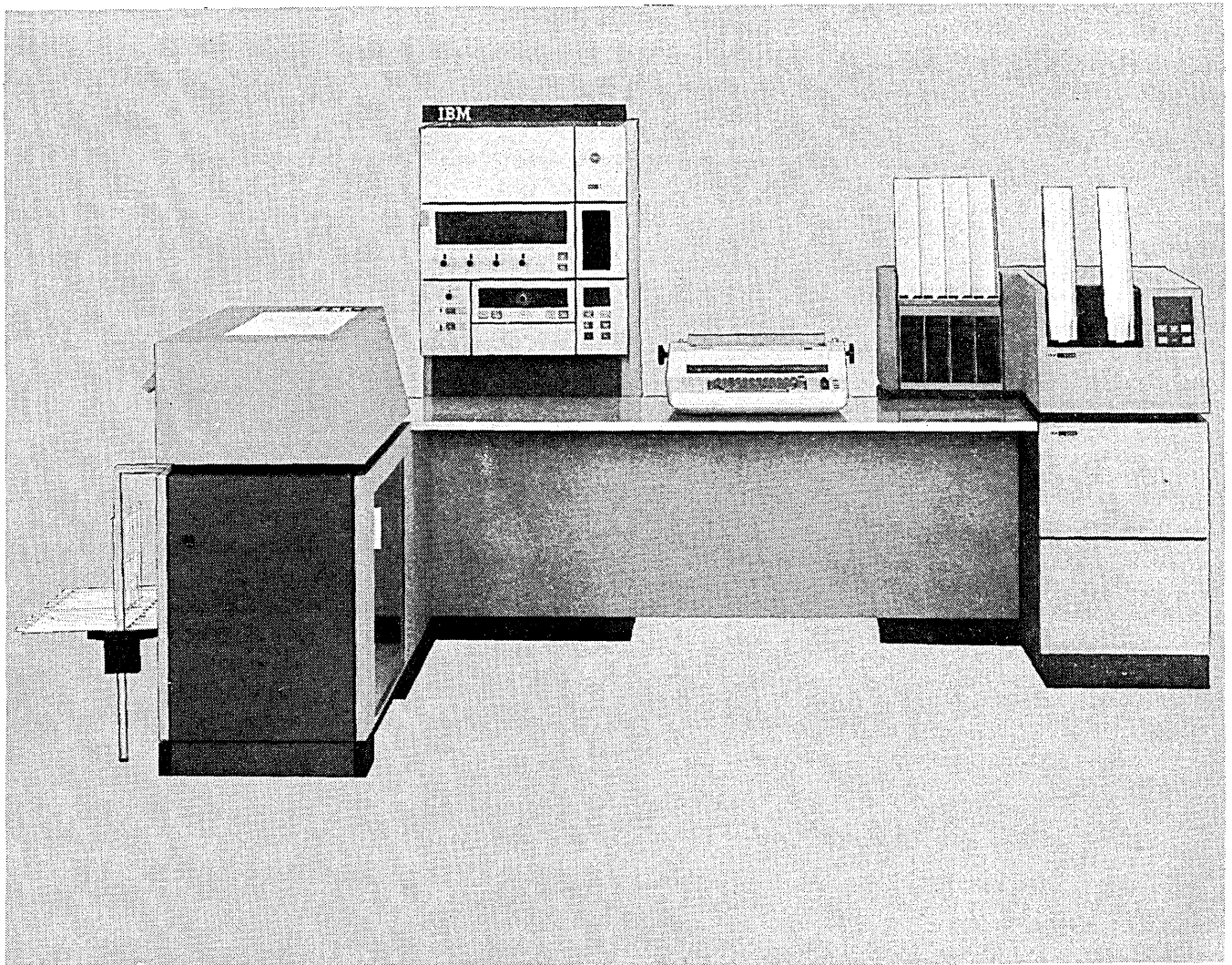

55239A





### System Control Program (SCP) Generation

#### *Punching the System Generation Instruction Cards from the Distribution Disk Cartridge*

1. Mount distribution disk cartridge for system generation on R1 and ready disks.
2. Place cards punched in *Preparing for System Generation* in primary hopper.
3. Place blank cards in secondary hopper of MFCU, or if your system input device is the 1442, place blank cards behind the cards from step 2.
4. Press reader START. PRIMARY READY light turns on.
5. Ready printer.
6. Set program load selector at REMOVABLE DISK and set the address/data switches to indicate 1442 if your system input device is the 1442.
7. Press PROGRAM LOAD. Initial program loading is performed and, when complete, the system begins reading cards from the reader.

*Note:* If you are using a printer chain other than the standard 48-character chain set, the DATE, IMAGE, and data cards are not printable. A halt of 7P is displayed in the message display unit. This halt occurs to ensure that you have the correct printer chain mounted. If the correct printer chain is not mounted, mount it at this time. After ensuring the correct printer chain is mounted, press console START (program 1 HALT/RESET key if you have DPF) to continue with system generation.

8. A halt of 91 is displayed in the message display unit. This halt is provided to give you time to read the instructions printed on the printer.
9. After reading the instructions, set rightmost ADDRESS/DATA switch on console at 0.
10. Press console START (program 1 HALT/RESET key if you have DPF). System generation continues.

When the EJ halt is displayed on the message display unit, a deck of punched cards (Figure 42) will be in stacker 4 of the MFCU, stacker 2 of the 1442 if your system input device is the 1442, and a listing of the punched cards will be printed on the printer. The deck of punched cards is used to continue with system generation. (Make sure your cards are kept in the correct order.) You can now initialize F1.

*Note:* If you are performing system generation from the 1442, the punched cards in stacker 2 are uninterpreted. It is suggested that you interpret all of these cards before continuing for ease in modifying them later.

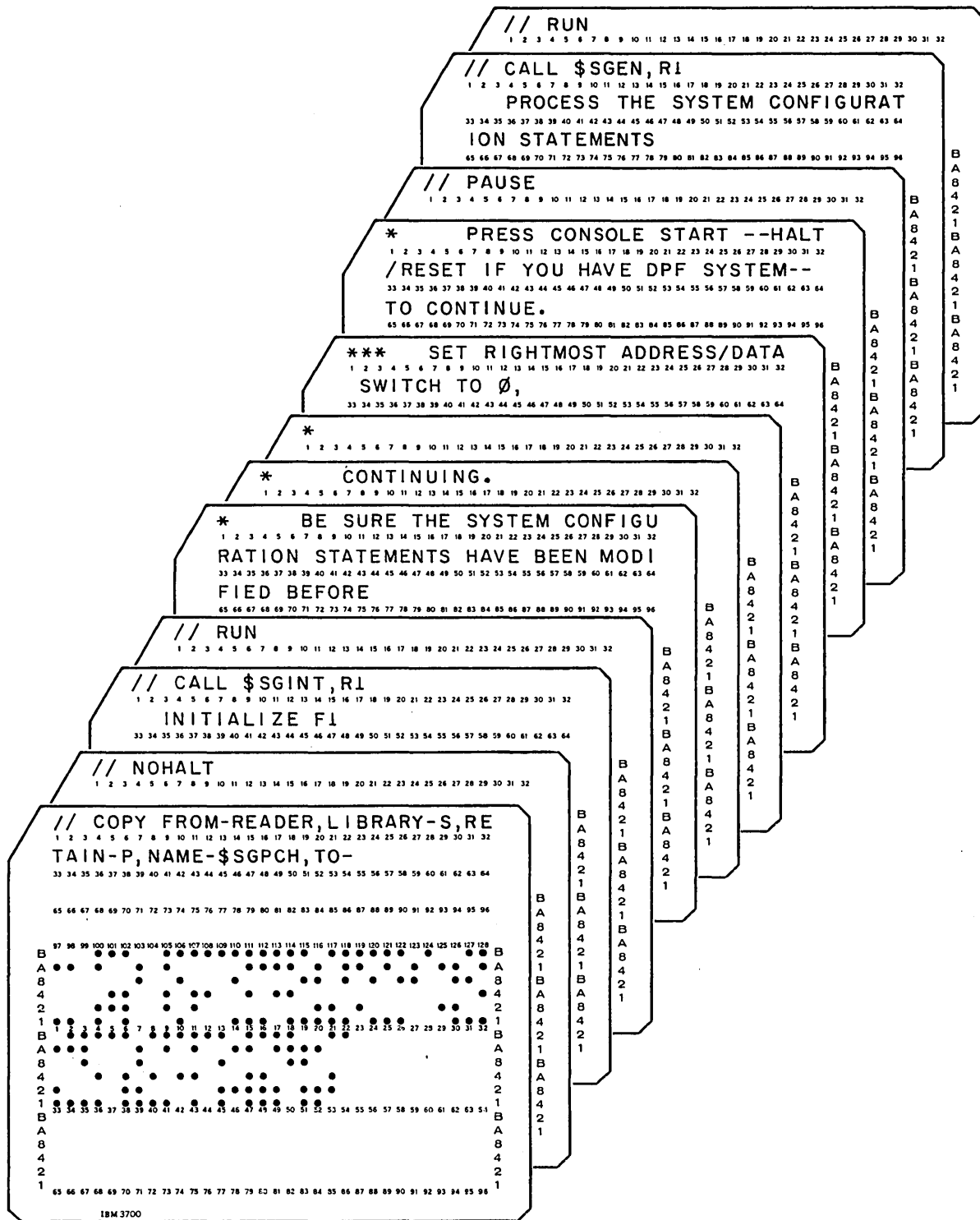

Note: If your system input device is the 1442, the punched cards are uninterpreted 80-column cards.

Figure 42 (Part 1 of 7). Punched Cards for SCP Generation

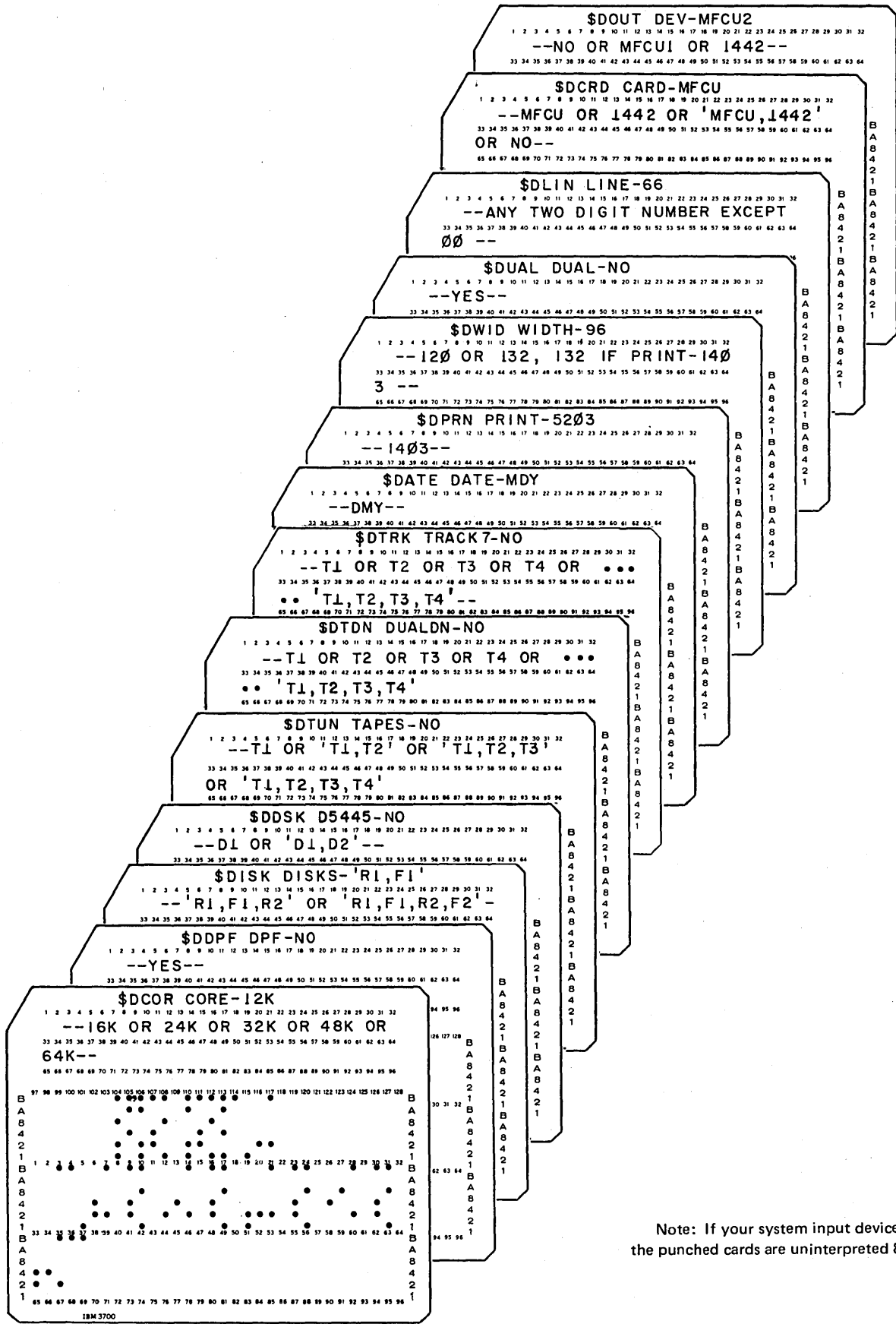

Note: If your system input device is the 1442, the punched cards are uninterpreted 80-column cards.

Figure 42 (Part 2 of 7). Punched Cards for SCP Generation

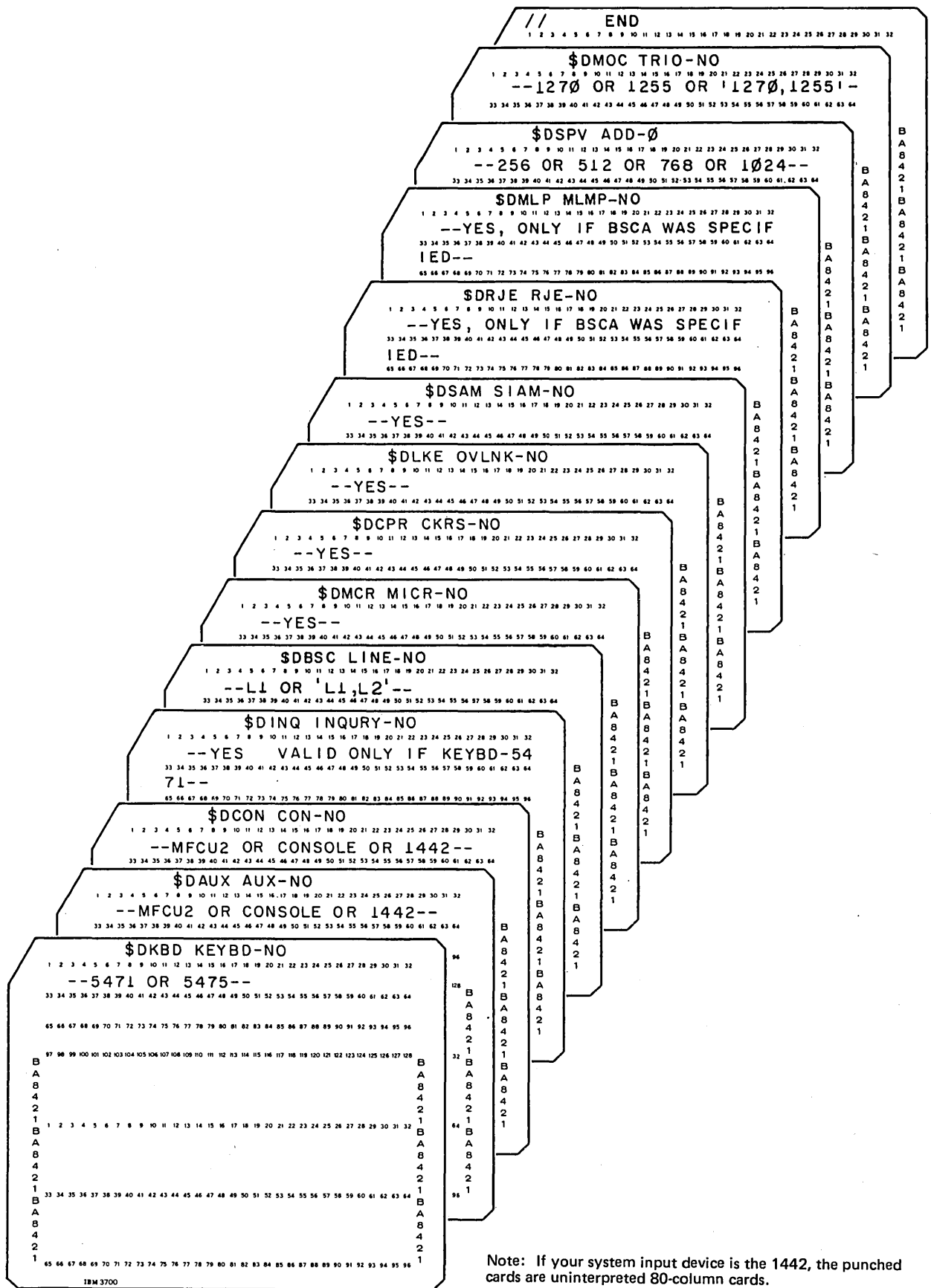

Note: If your system input device is the 1442, the punched cards are uninterpreted 80-column cards.

Figure 42 (Part 3 of 7). Punched Cards for SCP Generation

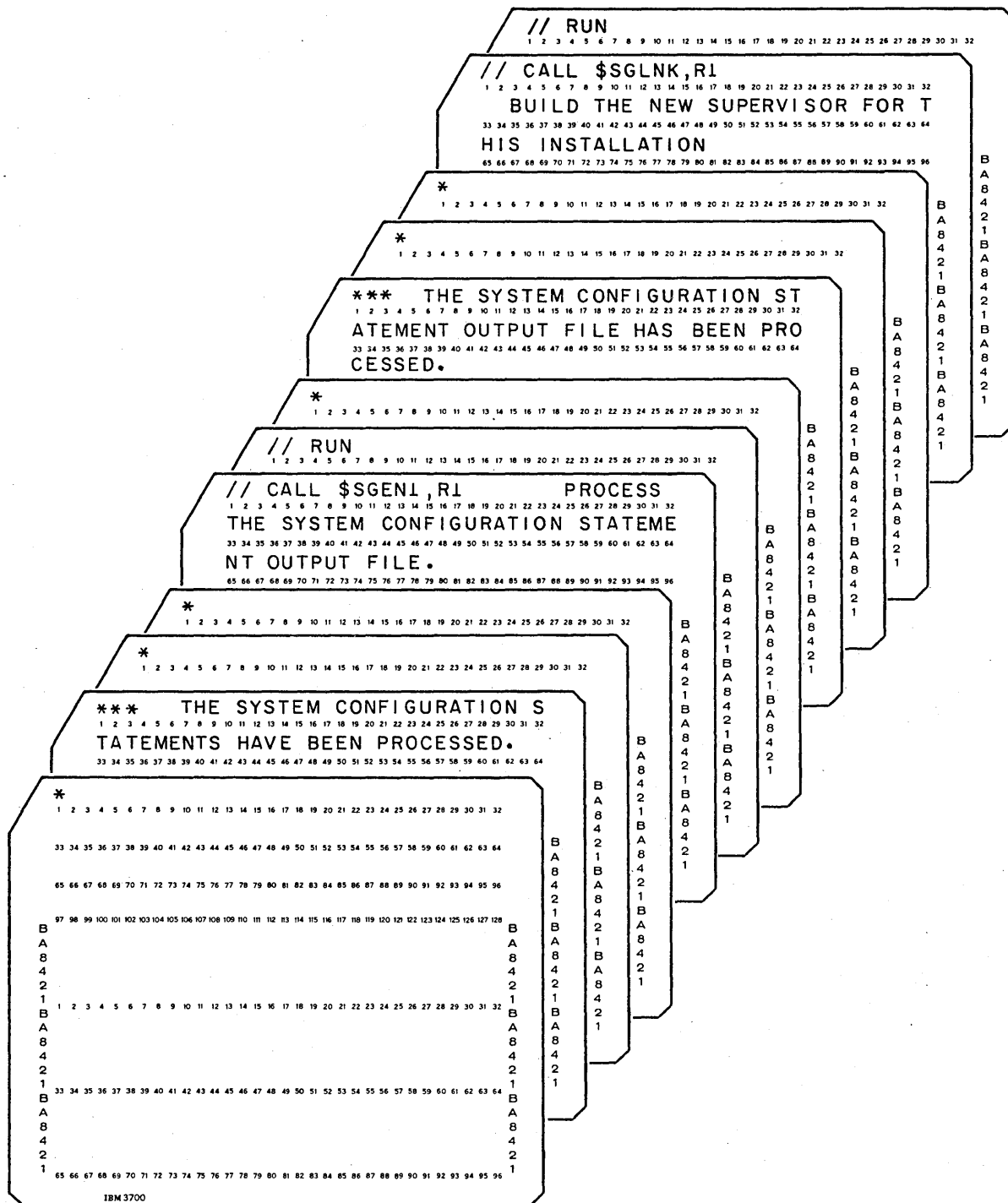

Note: If your system input device is the 1442, the punched cards are uninterpreted 80-column cards.

Figure 42 (Part 4 of 7). Punched Cards for SCP Generation



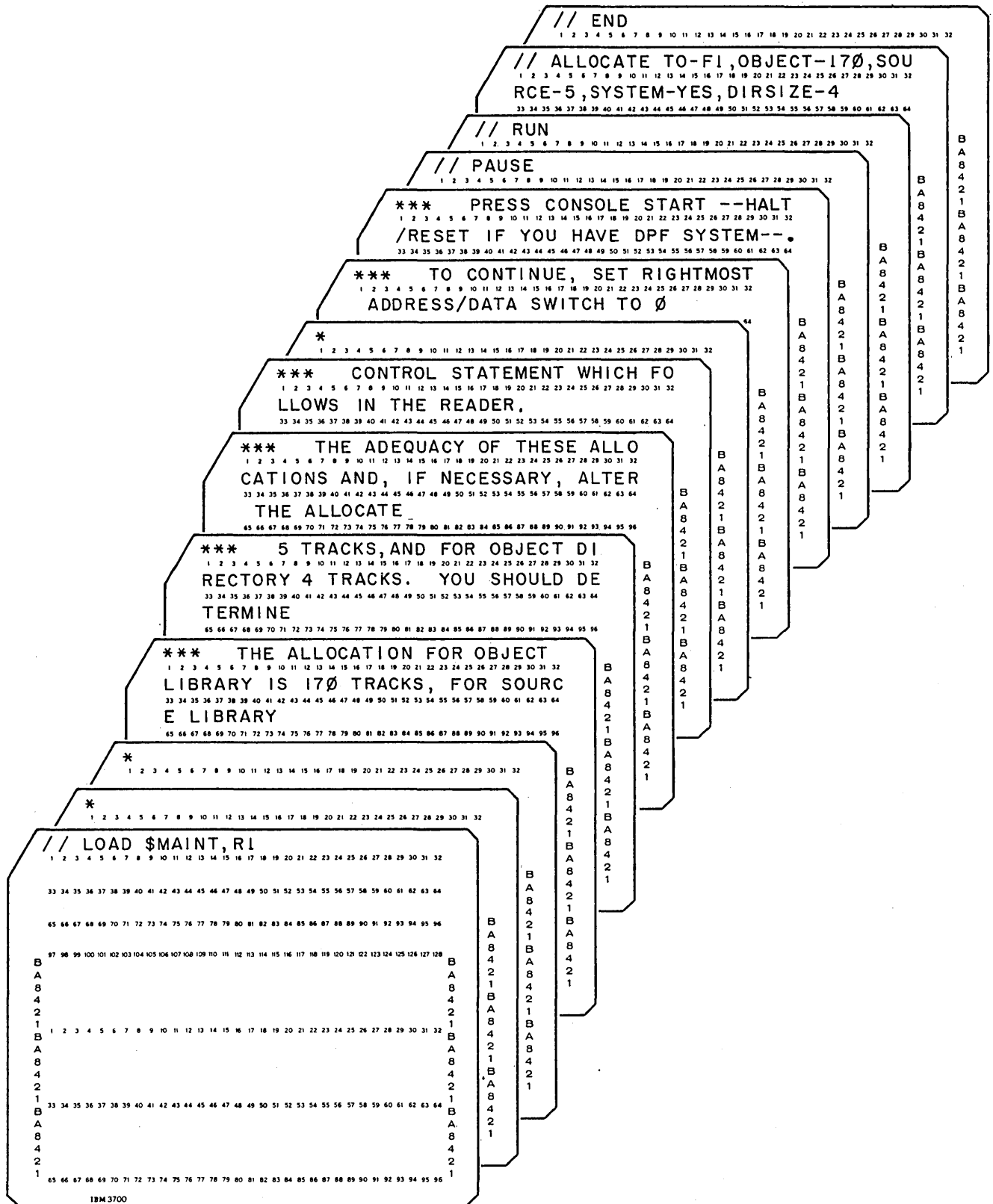

Note: If your system input device is the 1442, the punched cards are uninterpreted 80-column cards.

Figure 42 (Part 5 of 7). Punched Cards for SCP Generation



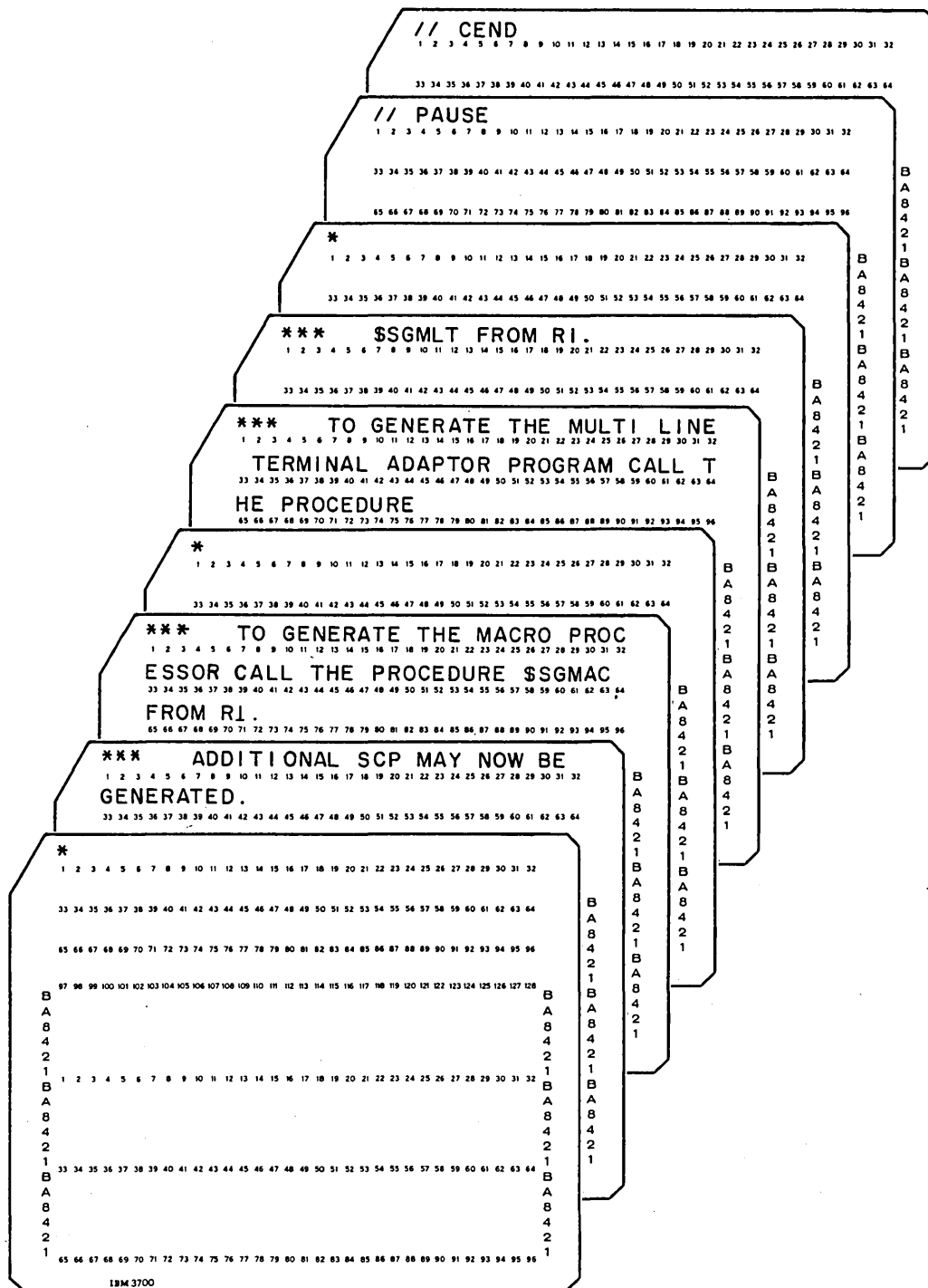

Note: If your system input device is the 1442, the punched cards are uninterpreted 80-column cards.

Figure 42 (Part 7 of 7). Punched Cards for SCP Generation

Initializing F1

1. Remove the punched cards from stacker,
2. Remove the following two cards from the deck and discard them:

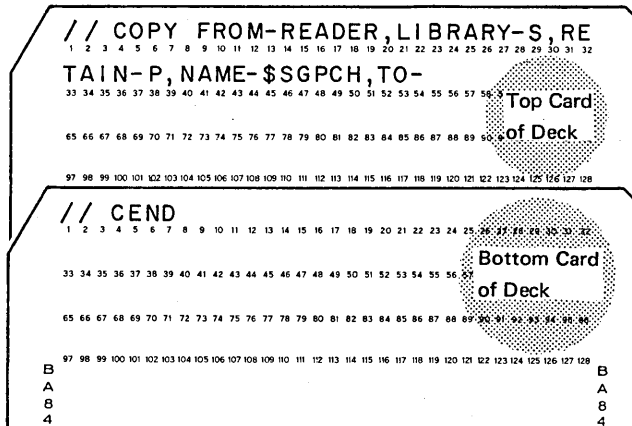

3. Clear cards from hopper.
4. Remove cards shown in Figure 43 from deck of punched cards and place them in primary hopper.
5. Press reader START. PRIMARY READY turns on.
6. Press console START (program 1 HALT/RESET key if you have DPF). The system begins reading the cards in the primary hopper and initialization of F1 begins.

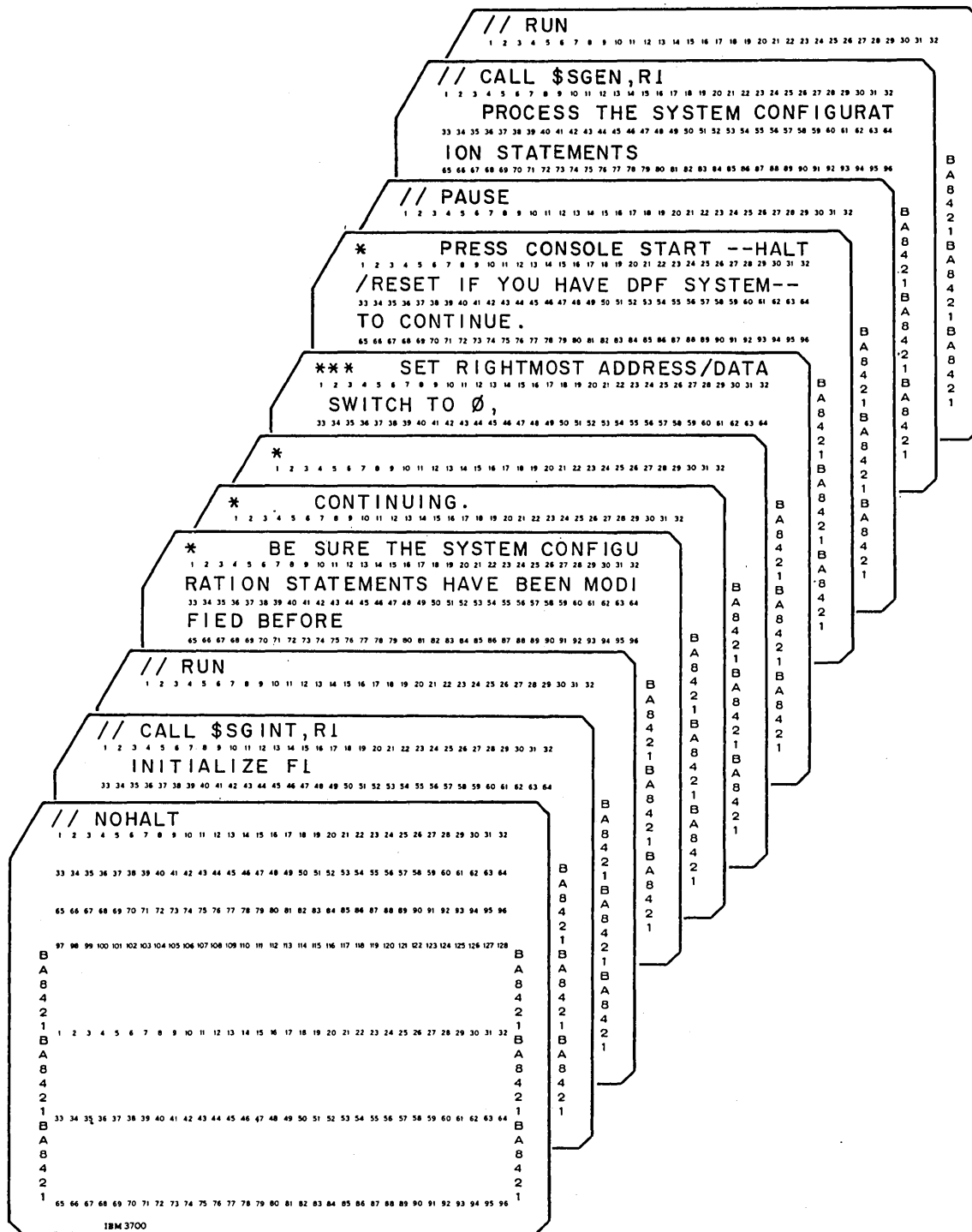

Note: If your system input device is the 1442, the punched cards are uninterpreted 80-column cards.

Figure 43. First Cards for System Generation

Halt 90 (caused by a // PAUSE statement) is displayed in the message display unit when the fixed disk (F1) has been initialized. There are still two cards in the primary hopper. Leave them there because they are part of the next procedure.

### *Modifying the System Configuration Statements*

You can now modify the system configuration statements shown in Figure 44, depending on your system configuration. Figure 45 discusses each of the system configuration statements and the options available for each. If you do not have to change any of these statements, leave them in the remaining deck of punched cards and proceed to step 2 in *Procedures for Modifying the System Configuration and Library Allocation Statements*.

*Note:* If you select DPF-NO when you have a DPF system and also select INQUERY-YES, the P2 switch located on the CE panel must be set at OFF when system generation is complete.

*Note:* If you select options that are not valid for your system configuration, you will not be able to successfully perform the IPL process from your generated system.

This punched deck of system configuration statements already contains an assumed option for your system configuration to the right of the dash sign. The options that follow the assumed options are the ones you may choose from if your system configuration does not agree with the assumed option. These options could contain more than one value to choose from, therefore, the options are separated by the word OR. If the options are within quotes, the quotes must also be punched in the new card. The dashes at either end of the options are not to be punched.

**\$DWDW WIDTH-96**  
 1 2 3 4 5 6 7 8 9 10 11 12 13 14 15 16 17 18 19 20 21 22 23 24 25 26 27 28 29 30 31 32  
 --120 OR 132, 132 IF PRINT-140  
 3 --  
 65 66 67 68 69 70 71 72 73 74 75 76 77 78 79 80 81 82 83 84 85 86 87 88 89 90 91 92 93 94 95 96

**\$DPRN PRINT-5203**  
 1 2 3 4 5 6 7 8 9 10 11 12 13 14 15 16 17 18 19 20 21 22 23 24 25 26 27 28 29 30 31 32  
 --1403--  
 33 34 35 36 37 38 39 40 41 42 43 44 45 46 47 48 49 50 51 52 53 54 55 56 57 58 59 60 61 62 63 64

**\$DATE DATE-MDY**  
 1 2 3 4 5 6 7 8 9 10 11 12 13 14 15 16 17 18 19 20 21 22 23 24 25 26 27 28 29 30 31 32  
 --DMY--  
 33 34 35 36 37 38 39 40 41 42 43 44 45 46 47 48 49 50 51 52 53 54 55 56 57 58 59 60 61 62 63 64

**\$DTRK TRACK 7-NO**  
 1 2 3 4 5 6 7 8 9 10 11 12 13 14 15 16 17 18 19 20 21 22 23 24 25 26 27 28 29 30 31 32  
 --T1 OR T2 OR T3 OR T4 OR ...  
 33 34 35 36 37 38 39 40 41 42 43 44 45 46 47 48 49 50 51 52 53 54 55 56 57 58 59 60 61 62 63 64  
 .. 'T1, T2, T3, T4' --  
 65 66 67 68 69 70 71 72 73 74 75 76 77 78 79 80 81 82 83 84 85 86 87 88 89 90 91 92 93 94 95 96

**\$DTDN DUALDN-NO**  
 1 2 3 4 5 6 7 8 9 10 11 12 13 14 15 16 17 18 19 20 21 22 23 24 25 26 27 28 29 30 31 32  
 --T1 OR T2 OR T3 OR T4 OR ...  
 33 34 35 36 37 38 39 40 41 42 43 44 45 46 47 48 49 50 51 52 53 54 55 56 57 58 59 60 61 62 63 64  
 .. 'T1, T2, T3, T4' --  
 65 66 67 68 69 70 71 72 73 74 75 76 77 78 79 80 81 82 83 84 85 86 87 88 89 90 91 92 93 94 95 96

**\$DTUN TAPES-NO**  
 1 2 3 4 5 6 7 8 9 10 11 12 13 14 15 16 17 18 19 20 21 22 23 24 25 26 27 28 29 30 31 32  
 --T1 OR 'T1, T2' OR 'T1, T2, T3'  
 33 34 35 36 37 38 39 40 41 42 43 44 45 46 47 48 49 50 51 52 53 54 55 56 57 58 59 60 61 62 63 64  
 OR 'T1, T2, T3, T4' --  
 65 66 67 68 69 70 71 72 73 74 75 76 77 78 79 80 81 82 83 84 85 86 87 88 89 90 91 92 93 94 95 96

**\$DDSK D5445-NO**  
 1 2 3 4 5 6 7 8 9 10 11 12 13 14 15 16 17 18 19 20 21 22 23 24 25 26 27 28 29 30 31 32  
 --D1 OR 'D1, D2' --  
 33 34 35 36 37 38 39 40 41 42 43 44 45 46 47 48 49 50 51 52 53 54 55 56 57 58 59 60 61 62 63 64

**\$DISK DISKS-'R1, F1'**  
 1 2 3 4 5 6 7 8 9 10 11 12 13 14 15 16 17 18 19 20 21 22 23 24 25 26 27 28 29 30 31 32  
 --'R1, F1, R2' OR 'R1, F1, R2, F2' --  
 33 34 35 36 37 38 39 40 41 42 43 44 45 46 47 48 49 50 51 52 53 54 55 56 57 58 59 60 61 62 63 64  
 --  
 65 66 67 68 69 70 71 72 73 74 75 76 77 78 79 80 81 82 83 84 85 86 87 88 89 90 91 92 93 94 95 96

**\$DDPF DPF-NO**  
 1 2 3 4 5 6 7 8 9 10 11 12 13 14 15 16 17 18 19 20 21 22 23 24 25 26 27 28 29 30 31 32  
 --YES--  
 33 34 35 36 37 38 39 40 41 42 43 44 45 46 47 48 49 50 51 52 53 54 55 56 57 58 59 60 61 62 63 64  
 65 66 67 68 69 70 71 72 73 74 75 76 77 78 79 80 81 82 83 84 85 86 87 88 89 90 91 92 93 94 95 96

**\$DCOR CORE-12K**  
 1 2 3 4 5 6 7 8 9 10 11 12 13 14 15 16 17 18 19 20 21 22 23 24 25 26 27 28 29 30 31 32  
 --16K OR 24K OR 32K OR 48K OR  
 64K--  
 65 66 67 68 69 70 71 72 73 74 75 76 77 78 79 80 81 82 83 84 85 86 87 88 89 90 91 92 93 94 95 96

97 98 99 100 101 102 103 104 105 106 107 108 109 110 111 112 113 114 115 116 117 118 119 120 121 122 123 124 125 126 127 128

IBM 3700

Figure 44 (Part 1 of 3). System Configuration Statements

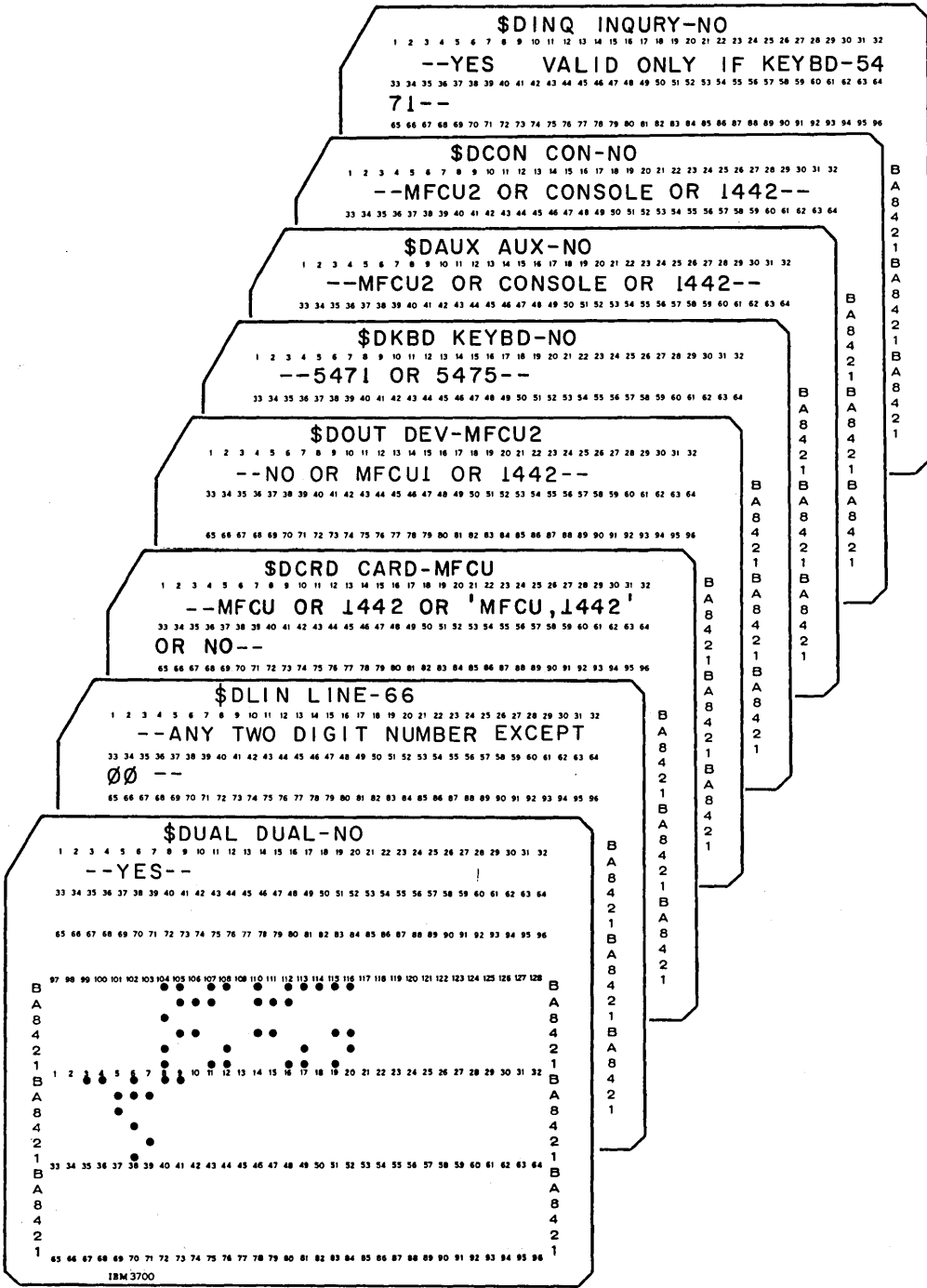

Figure 44 (Part 2 of 3). System Configuration Statements



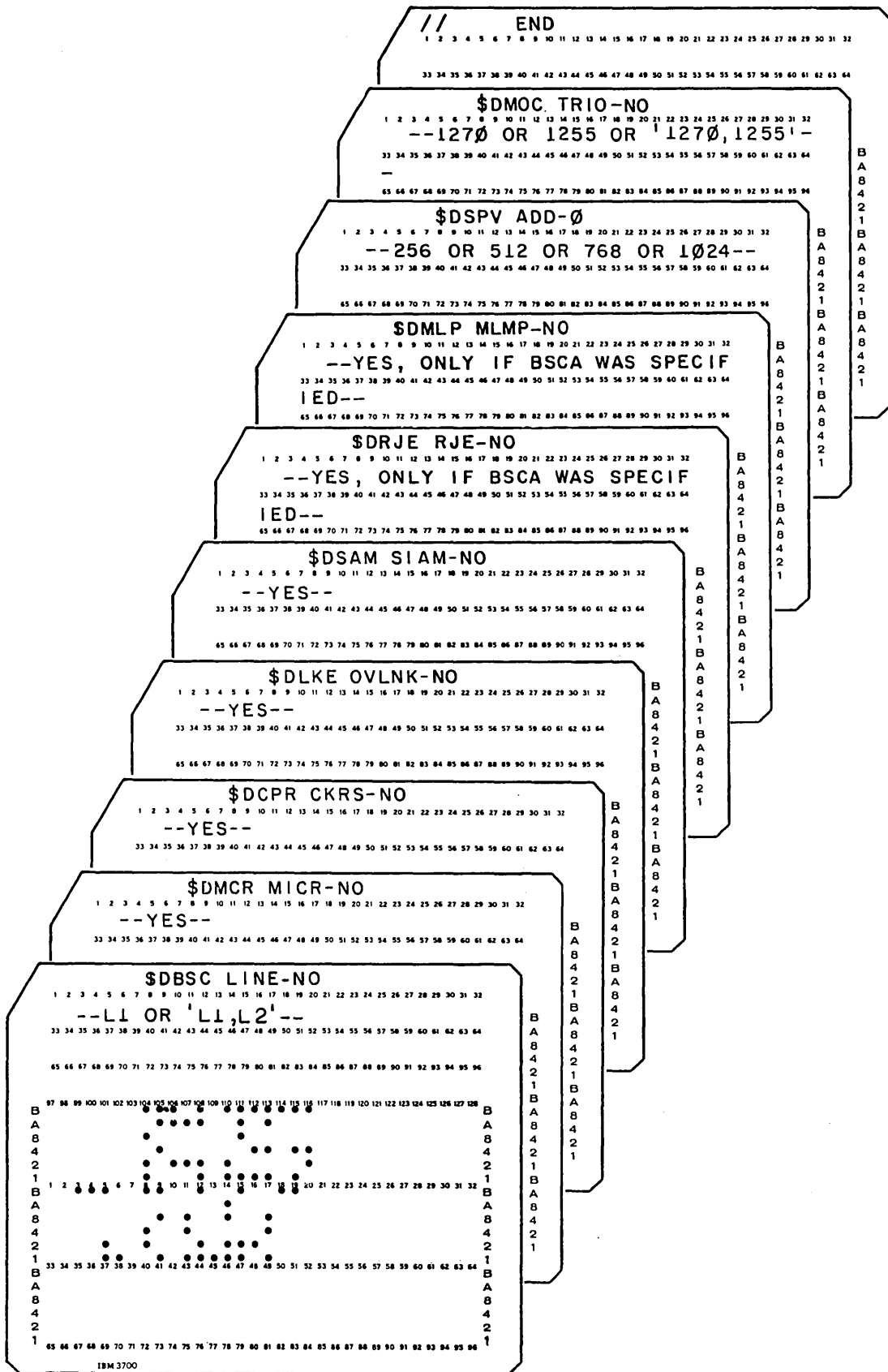

Figure 44 (Part 3 of 3). System Configuration Statements

Description Statement	Assumed Value	Optional Values	Description
\$DCOR CORE--	42K-16	16K or 24K or 32K or 48K or 64K	Indicates the storage size of your processing unit. (K = 1024 bytes)
\$DDPF DPF--	NO	YES	Indicates whether you have the Dual Programming Feature (DPF). (See Supervisor Size Considerations.)
\$DISK DISKS--	'R1,F1'	'R1,F1,R2' or 'R1,F1,R2,F2'	Indicates the number of 5444 disk units your system has. (See Supervisor Size Considerations.)
\$DDSK D5445--	NO	D1 or 'D1,D2'	Indicates the number of 5445 disk units your system has. (See Supervisor Size Considerations.)
\$DTUN TAPES--	NO	T1 or 'T1,T2' or 'T1,T2,T3' or 'T1,T2,T3,T4'	Indicates the number of magnetic tape units your system has. (See Supervisor Size Considerations.)
\$DTDN DUALDN--	NO	T1 or T2 or T3 or T4 or 'T1,T2' or 'T1,T3' or 'T1,T4' or 'T2,T3' or 'T2,T4' or 'T3,T4' or 'T1,T2,T3' or 'T1,T2,T4' or 'T1,T3,T4' or 'T2,T3,T4' or 'T1,T2,T3,T4'	Indicates which magnetic tape units have the dual density feature.
\$DTRK TRACK7--	NO	T1, or T2 or T3 or T4 or 'T1, T2' or 'T1, T3' or 'T1, T4' or 'T2, T3' or 'T2, T4' or 'T3, T4' or 'T1, T2, T3' or 'T1, T2, T4' or 'T1, T3, T4' or 'T2, T3, T4' or 'T1, T2, T3, T4'	Indicates which magnetic tape units have the 7-track feature.
\$DATE DATE--	mdy	dmy	Indicates the order for specifying month (m), day (d), and year (y) on the DATE OCL statement. Depending on the order you selected the format of the DATE statement is either:  // DATE mmddy or // DATE ddmmyy  Delimiters (/ , - , or any other characters except commas, quotes, numbers, and blanks) may be placed between the month, day, and year.  Examples:  // DATE mm/dd/yy  //DATE dd-mm-yy  You supply the system a DATE statement in front of the cards for the first job run after you perform the IPL process for the system.
\$DPRN PRINT--	5203	1403	Indicates the system printer being used.
\$DWID WIDTH--	96	120 or 132	Indicates the number of print positions on the printer. If you have the 1403 printer you must select 132 print positions.
\$DUAL DUAL--	NO	YES	Indicates whether your system has the dual feed carriage. Used with \$DPRN PRINT--5203 only.
\$DLIN LINE--	66	Any two digit number except 00	Indicates the number of lines to be printed per page.  <i>Note:</i> Some program products and utilities require a minimum of 12 lines per page.

Figure 45 (Part 1 of 2). Description of System Configuration Statements

Description Statement	Assumed Value	Optional Values	Description
\$DCRD CARD--	MFCU	NO or 1442 or 'MFCU, 1442'	Indicates the card devices you have.
\$DOUT DEV--	MFCU2	NO or MFCU1 or 1442	Indicates the system output device for punching.
\$DKBD KEYBD--	NO	5471 or 5475	Indicates the type of keyboard (5471 Printer-Keyboard or 5475 Date Entry Keyboard) you have, if any. (See Supervisor Size Considerations.)
\$DAUX AUX--	NO	*MFCU2 or CONSOLE or 1442	Indicates the device you want assigned to the AUX position on the DPF panel. Console refers to 5471 Printer-Keyboard.
\$DCON CON--	NO	*MFCU or CONSOLE or 1442	Indicates the device you want assigned to the P-KB position of the DPF panel. Console refers to 5471 Printer-Keyboard.
\$DINQ INQUIRY--	NO	YES	Indicates whether you want inquiry. You can have inquiry only if you have the 5471 Printer-Keyboard. Inquiry gives your system the capability of interrupting an RPG II program, placing the interrupted program on disk, loading and executing a new program, then loading the interrupted program back into storage.
\$DBSC LINE--	NO	L1 or 'L1,L2'	Indicates whether you have the Binary Synchronous Communications Adapter (BSCA). If you have BSCA, enter L1 if you have one adapter, 'L1,L2' if you have two adapters.
\$DMCR MICR--	NO	YES	Indicates whether you have the 1255 (Models 1, 2, or 3) Magnetic Ink Character Reader.
\$DCPR CKRS--	NO	YES	Indicates whether or not you have Checkpoint/Restart.
\$DLKE OVLNK--	NO	YES	Indicates whether or not you have the Overlay Link Editor.
\$DSAM SIAM--	NO	YES	Indicates whether you have shared I/O access methods.
\$DRJE RJE--	NO	YES	Indicates whether you have the Remote Job Entry (RJE) capability. You can have RJE only if you have BSCA with the EBCDIC adapter.
\$DMLP MLMP--	NO	YES (only if BSCA was specified)	Indicates whether you have the multiline/multipoint feature.
\$DSPV ADD--	0	256 or 512 or 768 or 1024	Indicates the number of bytes you may use to increase your supervisor area.
\$DMOC TRIO--	NO	1270 or 1255 or '1270, 1255'	Indicates the Terminal Reader In Optics (TRIO) devices you have (if any):  1270 Optical Reader Sorter 1255 Model 21, 22, or 23 Magnetic Character Reader You can select either or both of these devices to be supported by your system. These devices are not available in the United States.

\*\$DAUX AUX-- and \$DCON CON-- are used with DPF only and cannot be assigned the same device. If your only card input device is the 1442, you must specify \$DAUX AUX--1442.

Figure 45 (Part 2 of 2). Description of System Configuration Statements

*Supervisor Size Considerations:* The size of the supervisor generated for your system depends on the options you choose for the following configuration statements:

\$DDPF (Dual Programming Feature)

\$DISK (5444 disk units)

\$DDSK (5445 disk units)

\$DTUN (magnetic tape units)

\$DKBD (keyboard)

\$DBSC (BSCA Feature)

Supervisor size estimating is discussed in *Appendix E*.

*Procedures for Modifying the System Configuration and Library Allocation Statements*

Use the following procedure to change the system configuration statements:

1. Remove system configuration statements from the remaining deck of punched cards that you did not place in the primary hopper.
2. Select appropriate option for each statement using Figures 44 and 45. If the statement does not have to be changed, place it back in the deck and proceed to the next statement. (Make sure your system configuration statements are in the same order as when they were punched.)

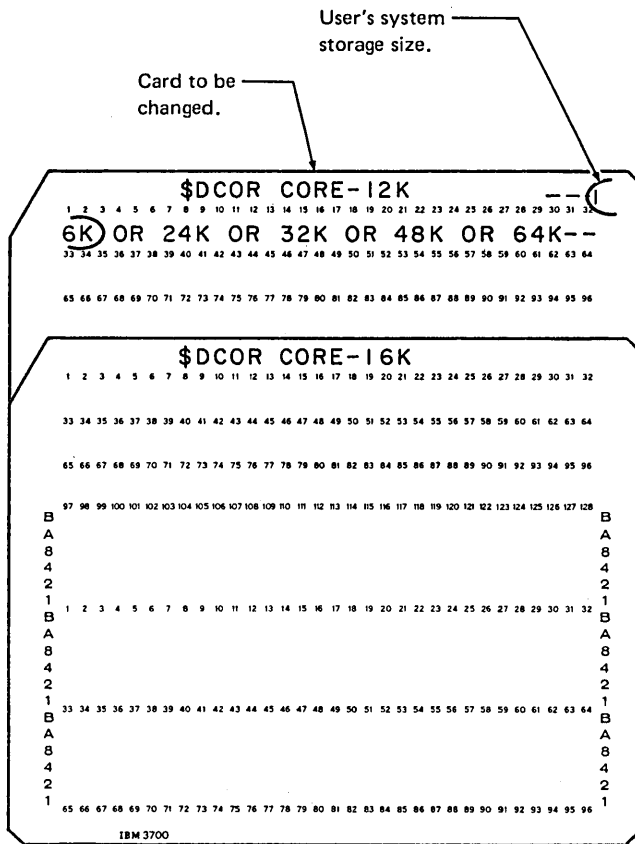

3. Punch the card to be changed in exactly the same format, up to and including the dash sign, then punch the option you choose.
4. Place each new card back in the deck. Discard the old card. Be sure to keep the cards in the same order shown in Figure 44.
5. When the changes are complete, place the system configuration statements back in front of the remaining deck of punched cards.
6. Place the system configuration statements after the two remaining cards from the preceding procedure in the primary hopper followed by the remaining deck of punched cards.
7. Press reader START.
8. Set rightmost ADDRESS/DATA switch at 0.
9. Press console START (program 1 HALT/RESET key if you have DPF).

When a halt of 91 is displayed in the message display unit, SCP generation is preparing to allocate F1 with a system, a source library, and an object library. This halt is given to allow you to modify these allocations if necessary. To modify these allocations do the following:

1. Remove cards from reader. The ALLOCATE statement is the second card in the MFCU hopper or the first card in the 1442 hopper.
2. Modify the ALLOCATE statement if necessary. For information on how to determine whether or not to modify this statement and how it should be done see *Determining Library Requirements on Generated System Packs and Program Packs* in Appendix E.
3. Replace cards, including new ALLOCATE statement, and press console START (program 1 HALT/RESET key if you have DPF).

When a halt of 90 is displayed in the message display unit, SCP generation is complete and the following has been accomplished:

- System configuration statements have been processed.
- Required SCP system has been built on F1.

Figure 46 is a sample printout of required SCP generation.

#### Generating Additional SCP

You may at this time generate additional SCP for the Macros Feature or for the Multiple Line Terminal Adapter (MLTA) RPQ Feature if you have ordered either or both of these programs. This is done by entering either or both of the following OCL sequences:

```
/// CALL $SGMAC, R1
/// RUN
/// CALL $SGMLT, R1
/// RUN
```

An example of the generation of these two programs can be found in Figure 46.

#### Completing SCP Generation

You can now perform program product generation, if desired. However, if you do not want to perform program product generation at this time, perform the following:

1. Set rightmost ADDRESS/DATA switch at 0.
2. Press console START (program 1 HALT/RESET key if you have DPF). I/O ATTENTION will then occur.
3. Proceed to *Completing System Generation and Installation Verification* to copy your SCP system on F1 to R1 to create a backup and build a minimal system on F1, if desired.

```

// DATE 000000
// CALL $SGPCH,R1
XX L1A0 $MAINT,R1
*
*
***** INSTRUCTIONS FOR SCP SYSTEM GENERATION *****
*
*** THIS CONTROL DECK PUNCHES OUT THE SCP SYSTEM GENERATION INSTRUCTION CARDS
*** AND PRINTS A LISTING OF THE PUNCHED CARDS ON THE PRINTER
*
*** THE FIRST CARD --A COPY CARD-- AND THE LAST CARD -- A CEND CARD-- THAT ARE
*** PUNCHED OUT MUST BE DISCARDED.
*
*** SEPARATE THE DECK INTO TWO PARTS BY TAKING THE CARDS UP TO AND INCLUDING
*** THE // RUN CARD THAT FOLLOWS THE // CALL $SGEN,R1 OFF THE FRONT OF THE
*** DECK. PLACE THESE CARDS INTO THE PRIMARY HOPPER OF THE READER AND PRESS
*** READER START.
*
*** THEN PRESS CONSOLE START --HALT/RESET IF YOU HAVE DPF SYSTEM--
*
*
*** WHEN A HALT 90 IS DISPLAYED IN THE MESSAGE DISPLAY UNIT, THE SYSTEM
*** CONFIGURATION STATEMENTS SHOULD BE MODIFIED AS REQUIRED TO REFLECT YOUR
*** SYSTEM HARDWARE CONFIGURATION.
*** BE SURE TO KEEP THESE CARDS IN THE SAME ORDER. WHEN CHANGES ARE COMPLETE,
*** PLACE THE SYSTEM CONFIGURATION STATEMENTS IN THE PRIMARY HOPPER OF THE
*** READER FOLLOWED BY THE REMAINING DECK OF PUNCHED CARDS AND PRESS READER
*** START.
*
*** SET RIGHTMOST ADDRESS/DATA SWITCH TO 0,
*** THEN PRESS CONSOLE START --HALT/RESET IF YOU HAVE DPF SYSTEM-- TO CONTINUE
*
*
*** WHEN A HALT 90 IS AGAIN DISPLAYED IN THE MESSAGE DISPLAY UNIT,
*** SCP GENERATION IS COMPLETE.
*
***** END OF INSTRUCTIONS FOR SCP SYSTEM GENERATION *****
*
*
*
* READ THE INSTRUCTIONS GIVEN ABOVE.
*
*
*** AFTER READING THE INSTRUCTIONS, SET RIGHTMOST ADDRESS/DATA SWITCH TO 0,
*** PRESS CONSOLE START --HALT/RESET IF YOU HAVE DPF SYSTEM--
*** TO CONTINUE WITH SCP SYSTEM GENERATION.
XX PAUSE
*
*
XX RUN
// RUN
*
*
// COPY NAME=$SGPCH,LIBRARY=S,FROM=R1,TO=PRTPCH

```

You prepared these cards.

Instructions telling you what to do for the SCP portion of system generation.

This portion of SCP generation causes the instruction cards to be punched by the MFCU and printed on the printer.

This statement causes the system to halt with 91 in the message display unit.

You prepared this card.

Figure 46 (Part 1 of 9). Example of System Control Program Generation

The following is a printout of the punched cards.

```

$SGPCH
// NOHALT
// CALL $SGINT,R1          INITIALIZE F1
// RUN
*   BE SURE THE SYSTEM CONFIGURATION STATEMENTS HAVE BEEN MODIFIED BEFORE
*   CONTINUING.
*
***  SET RIGHTMOST ADDRESS/DATA SWITCH TO 0,
*   PRESS CONSOLE START --HALT/RESET IF YOU HAVE DPF SYSTEM-- TO CONTINUE.
// PAUSE
// CALL $SGEN,R1          PROCESS THE SYSTEM CONFIGURATION STATEMENTS
// RUN
$DCOR CORE-12K           --16K OR 24K OR 32K OR 48K OR 64K--
$DDPF DPF-NO             --YES--
$DISK DISKS-'R1,F1'     --'R1,F1,R2' OR 'R1,F1,R2,F2'--
$DDSK D5445-NO          --D1 OR 'D1,D2'--
$DTUN TAPES-NO          --T1 OR 'T1,T2' OR 'T1,T2,T3' OR 'T1,T2,T3,T4'
$DTDN DUALDN-NO         --T1 OR T2 OR T3 OR T4 OR ..... 'T1,T2,T3,T4'
$DTRK TRACK7-NO        --T1 OR T2 OR T3 OR T4 OR ..... 'T1,T2,T3,T4'
$DATE DATE-MDY          --DMY--
$DPRN PRINT-5203        --1403--
$DWID WIDTH-96          --120 OR 132, 132 IF PRINT-1403 --
$DUAL DUAL-NO           --YES--
$DLIN LINE-66           --ANY TWO DIGIT NUMBER EXCEPT 00 --
$DCRD CARD-MFCU         --MFCU OR 1442 OR 'MFCU,1442' OR NO--
$DOUT DEV-MFCU2         --NO OR MFCU1 OR 1442--
$DKBD KEYBD-NO          --5471 OR 5475--
$DAUX AUX-NO            --MFCU2 OR CONSOLE OR 1442--
$DCON CON-NO            --MFCU2 OR CONSOLE OR 1442--
$DINQ INQUERY-NO       --YES VALID ONLY IF KEYBD-5471--
$DBSC LINE-NO           --L1 OR 'L1,L2'--
$DMCR MICR-NO           --YES--
$DCPK CKRS-NO           --YES--
$DLKE OVLNK-NO          --YES--
$DSAM SIAM-NO           --YES--
$DRJE RJE-NO            --YES, ONLY IF BSCA WAS SPECIFIED--
$DMLP NLMP-NO           --YES, ONLY IF BSCA WAS SPECIFIED--
$DSPV ADD-0             --256 OR 512 OR 768 OR 1024--
$DMDC TRIO-NO           --1270 OR 1255 OR '1270,1255'--
// END
    
```

Place these cards in the primary hopper of the MFCU and continue with SCP generation.

These are the system configuration statements. You may have to modify some of these statements. After modifying these statements, you will place them in the primary hopper of the MFCU.

● Figure 46 (Part 2 of 9). Example of System Control Program Generation



```

*
*** THE SYSTEM CONFIGURATION STATEMENTS HAVE BEEN PROCESSED.
*
*
// CALL $SGEN1,R1          PROCESS THE SYSTEM CONFIGURATION STATEMENT OUTPUT FILE.
// RUN
*
*** THE SYSTEM CONFIGURATION STATEMENT OUTPUT FILE HAS BEEN PROCESSED.
*
*
// CALL $SGLNK,R1          BUILD THE NEW SUPERVISOR FOR THIS INSTALLATION
// RUN
// LOAD $MAINT,R1
*
*
*** THE ALLOCATION FOR OBJECT LIBRARY IS 170 TRACKS, FOR SOURCE LIBRARY
*** 5 TRACKS, AND FOR OBJECT DIRECTORY 4 TRACKS. YOU SHOULD DETERMINE
*** THE ADEQUACY OF THESE ALLOCATIONS AND, IF NECESSARY, ALTER THE ALLOCATE
*** CONTROL STATEMENT WHICH FOLLOWS IN THE READER.
*
*** TO CONTINUE, SET RIGHTMOST ADDRESS/DATA SWITCH TO 0
*** PRESS CONSOLE START --HALT/RESET IF YOU HAVE DPF SYSTEM--

// PAUSE ← This statement causes the system to halt with 91 in the
// RUN          message display unit.
// ALLOCATE TO=F1,OBJECT=170,SOURCE=5,SYSTEM=YES,DIRSIZE=4
// END
// CALL $SGCOM,R1          BUILD REQUIRED SCP SYSTEM ON F1
// RUN
// CALL $SGOPT,R1          BUILD OPTIONAL SCP SYSTEM FUNCTIONS ONTO F1
// RUN
*
*** THE SYSTEM CONTROL PROGRAMS HAVE BEEN GENERATED
*
*** NORMAL END OF SCP GENERATION
*
*** ADDITIONAL SCP MAY NOW BE GENERATED.
*** TO GENERATE THE MACRO PROCESSOR CALL THE PROCEDURE $SGMAC FROM R1.
*
*** TO GENERATE THE MULTI LINE TERMINAL ADAPTOR PROGRAM CALL THE PROCEDURE
*** $SGMLT FROM R1.
// PAUSE ← This statement causes the system to halt with 90 in
// END          the message display unit.

```

After placing the system configuration statements in the primary hopper, place these cards in the hopper.

Figure 46 (Part 3 of 9). Example of System Control Program Generation

End of the printout of the punched cards.

Beginning of the printout of the cards you placed in the primary hopper of the MFCU.  
 The system is executing these instructions.

```
// NOHALT
// CALL $SGINT,R1          INITIALIZE F1
XX LOAD $INIT,R1
XX RUN
// RUN
// UIN UNIT-F1,TYPE-CLEAR
// VOL PACK-F1F1F1
// END
INITIALIZATION ON F1 COMPLETE
```

```
*      BE SURE THE SYSTEM CONFIGURATION STATEMENTS HAVE BEEN MODIFIED BEFORE
*      CONTINUING.
*
***   SET RIGHTMOST ADDRESS/DATA SWITCH TO J,
*      PRESS CONSOLE START --HALT/RESET IF YOU HAVE DPF SYSTEM-- TO CONTINUE.
// PAUSE
```

← This statement causes the system to halt with 90 in the message display unit.  
 The system configuration statements must be modified at this time before continuing.

```
// CALL $SGEN,R1          PROCESS THE SYSTEM CONFIGURATION STATEMENTS
XX LOAD $SGEN,R1
```

```
*
***   THE FOLLOWING CARDS AFTER THE // RUN AND BEFORE THE // END CARD ARE
***   THE SYSTEM CONFIGURATION STATEMENTS.
*
```

```
XX FILE NAME=MACOUT,UNIT-F1,PACK-F1F1F1,RETAIN-T,TRACKS-20
XX RUN
// RUN
```

```
$DCOR CORE-12K          --16K OR 24K OR 32K OR 48K OR 64K--
$DDPF DPF-NO           --YES--
$DISK DISKS-'R1,F1'    --'R1,F1,R2' OR 'R1,F1,R2,F2'--
$DDSK D5445-NO        --D1 OR 'D1,D2'--
$DTUN TAPES-NO        --T1 OR 'T1,T2' OR 'T1,T2,T3' OR 'T1,T2,T3,T4'
$DTDN DUALDN-NO       --T1 OR T2 OR T3 OR T4 OR ..... 'T1,T2,T3,T4'
$DTRK TRACK7-NO       --T1 OR T2 OR T3 OR T4 OR ..... 'T1,T2,T3,T4'
$DATE DATE-MOY        --DMY--
$DPRN PRINT-5203      --1403--
$DWID WIDTH-96        --120 OR 132, 132 IF PRINT-1403 --
$DUAL DUAL-NO         --YES--
$DLIN LINE-66         --ANY TWO DIGIT NUMBER EXCEPT 00 --
$DCRD CARD-MFCU       --MFCU OR 1442 OR 'MFCU,1442' OR NU--
$DOOT DEV-MFCU2       --NO OR MFCU1 OR 1442--
$DKBD KEYBD-NO        --5471 OR 5475--
$DAUX AUX-NO          --MFCU2 OR CONSOLE OR 1442--
$DCON CON-NO          --MFCU2 OR CONSOLE OR 1442--
$DINQ INQRY-NO        --YES  VALID ONLY IF KEYBD-5471--
$DBSC LINE-NO         --L1 OR 'L1,L2'--
$DMCR MICR-NO         --YES--
$DCPR CKRS-NO         --YES--
$DLKE QVLNK-NO        --YES--
$DSAM SIAM-NO         --YES--
$DRJE RJE-NO          --YES, ONLY IF BSCA WAS SPECIFIED--
$DMLP MLMP-NO         --YES, ONLY IF BSCA WAS SPECIFIED--
$DSPV ADU-Q           --256 OR 512 OR 768 OR 1024--
$DMOC TRIU-NO         --1270 OR 1255 OR '1270,1255'--
//
END
```

● Figure 46 (Part 4 of 9). Example of System Control Program Generation

```

*
*** THE SYSTEM CONFIGURATION STATEMENTS HAVE BEEN PROCESSED.
*
// CALL $SGEN1,R1          PROCESS THE SYSTEM CONFIGURATION STATEMENT OUTPUT FILE.
XX LOAD $SGEN1,R1
*
*** BUILD THE NEW CONFIGURATION RECORD.
*
XX FILE NAME=MACOUT,UNIT=F1,PACK=F1F1F1,RETAIN=S,TRACKS=20
XX FILE NAME=$WRK,UNIT=F1,PACK=F1F1F1,RETAIN=T,TRACKS=10
XX RUN
// RUN

```

```

*
*** THE SYSTEM CONFIGURATION STATEMENT OUTPUT FILE HAS BEEN PROCESSED.
*
// CALL $SGLNK,R1          BUILD THE NEW SUPERVISOR FOR THIS INSTALLATION
XX LOAD $LINK3,R1
XX FILE NAME=$WRK,UNIT=F1,PACK=F1F1F1,RETAIN=S,TRACKS=10
XX RUN
// RUN
SUPERVISOR SIZE - 2816 BYTES
TOTAL NUMBER OF LIBRARY SECTORS REQUIRED 12

```

```

// LOAD $MAINT,R1
*
*** THE ALLOCATION FOR OBJECT LIBRARY IS 170 TRACKS, FOR SOURCE LIBRARY
*** 5 TRACKS, AND FOR OBJECT DIRECTORY 4 TRACKS. YOU SHOULD DETERMINE
*** THE ADEQUACY OF THESE ALLOCATIONS AND, IF NECESSARY, ALTER THE ALLOCATE
*** CONTROL STATEMENT WHICH FOLLOWS IN THE READER.
*
*** TO CONTINUE, SET RIGHTMOST ADDRESS/DATA SWITCH TO 0
*** PRESS CONSOLE START --HALT/RESET IF YOU HAVE DPF SYSTEM--.
// PAUSE

```

This statement causes the system to halt with 91 in the message display unit.

```

// RUN
// ALLOCATE TO=F1,OBJECT=170,SOURCE=5,SYSTEM=YES,DIRSIZE=4
// END

```

Figure 46 (Part 5 of 9). Example of System Control Program Generation

```

// CALL $SGCJM,R1          BUILD REQUIRED SCP SYSTEM ON F1
XX LOAD $MAINT,R1
XX RUN
// RUN
// COPY FROM-R1,LIBRARY-O,NAME-SYSTEM,TO-F1
// COPY FROM-R1,TO-F1,LIBRARY-J,NAME-$GNSUP,RETAIN-R,NEW NAME-$$SPVR
// DELETE FROM-R1,RETAIN-P,LIBRARY-O,NAME-$GNSUP
// COPY FROM-R1,TO-F1,RETAIN-P,LIBRARY-U,NAME-$AL.ALL
// COPY FROM-R1,TO-F1,RETAIN-P,LIBRARY-O,NAME-$BU.ALL
// COPY FROM-R1,TO-F1,RETAIN-P,LIBRARY-O,NAME-$CO.ALL
// COPY FROM-R1,TO-F1,RETAIN-P,LIBRARY-O,NAME-$DE.ALL
// COPY FROM-R1,TO-F1,RETAIN-P,LIBRARY-O,NAME-$IN.ALL
// COPY FROM-R1,TO-F1,RETAIN-P,LIBRARY-O,NAME-$LA.ALL
// COPY FROM-R1,TO-F1,RETAIN-P,LIBRARY-O,NAME-$LI.ALL
// COPY FROM-R1,TO-F1,RETAIN-P,LIBRARY-O,NAME-$MA.ALL
// COPY FROM-R1,TO-F1,RETAIN-P,LIBRARY-R,NAME-$.ALL
// COPY FROM-R1,TO-F1,LIBRARY-P,RETAIN-P,NAME-$GCPY
// COPY FROM-R1,TO-F1,LIBRARY-P,RETAIN-P,NAME-$GINR
// COPY FROM-R1,TO-F1,LIBRARY-J,RETAIN-P,NAME-$GIVP
// COPY FROM-R1,TO-F1,LIBRARY-P,RETAIN-P,NAME-$GIVP
// COPY FROM-R1,TO-F1,LIBRARY-J,RETAIN-P,NAME-$GMYT
// END

```

```

// CALL $SGOPT,R1          BUILD OPTIONAL SCP SYSTEM FUNCTIONS ONTO F1
XX CALL $SGPO1,R1
XX LOAD $MAINT,R1
XX RUN
// RUN
// DELETE FROM-F1,RETAIN-P,LIBRARY-O,NAME-$$CLER
// DELETE FROM-F1,RETAIN-P,LIBRARY-U,NAME-$$DLGQ
// DELETE FROM-F1,RETAIN-P,LIBRARY-J,NAME-$$STOC
// DELETE FROM-F1,RETAIN-P,LIBRARY-O,NAME-$$STIC
// DELETE FROM-F1,RETAIN-P,LIBRARY-J,NAME-$$STCI
// DELETE FROM-F1,RETAIN-P,LIBRARY-O,NAME-$$DLG7
// DELETE FROM-F1,LIBRARY-J,RETAIN-P,NAME-$$STRI
// COPY FROM-R1,TO-F1,LIBRARY-J,RETAIN-P,NAME-$WDATE
// COPY FROM-F1,TO-PRINT,LIBRARY-SYSTEM,NAME-DIR

```

These COPY and DELETE statements will vary depending on the options you select.

Figure 46 (Part 6 of 9). Example of System Control Program Generation

SOURCE LIBRARY SECTION

SOURCE DIRECTORY LOCATION	008-00
NEXT AVAILABLE LIBRARY SECTOR	008-05
END OF LIBRARY	012-23
NUMBER OF DIRECTORY SECTORS	2
NUMBER OF PERMANENT LIBRARY SECTORS	3
NUMBER OF ACTIVE LIBRARY SECTORS	3
NUMBER OF AVAILABLE LIBRARY SECTORS	115
ALLOCATED SIZE OF LIBRARY	5

OBJECT LIBRARY SECTION

OBJECT DIRECTORY LOCATION	015-00
ALLOCATED SIZE OF DIRECTORY	4
START OF LIBRARY	019-00
ALLOCATED END OF LIBRARY	184-23
EXTENDED END OF LIBRARY	184-23
NUMBER OF AVAILABLE PERMANENT DIRECTORY ENTRIES	837
NUMBER OF AVAILABLE TEMPORARY DIRECTORY ENTRIES	837
FIRST TEMPORARY DIRECTORY ENTRY	000-00-000
NEXT AVAILABLE TEMPORARY DIRECTORY ENTRY	016-02-042
NEXT AVAILABLE LIBRARY SECTOR FOR PERMANENTS	071-02
NEXT AVAILABLE LIBRARY SECTOR FOR TEMPORARIES	071-02
NUMBER OF AVAILABLE LIBRARY SECTORS FOR PERMANENTS	2734
NUMBER OF AVAILABLE LIBRARY SECTORS FOR TEMPORARIES	2734
NUMBER OF ACTIVE LIBRARY SECTORS	1225
NUMBER OF ACTIVE OBJECT PERMANENT LIBRARY SECTORS	1087
NUMBER OF ACTIVE ROUTINE PERMANENT LIBRARY SECTORS	138
ALLOCATED SIZE OF LIBRARY	170
ROLL-IN/ROLL-OUT LOCATION	000-00
ROLL-IN/ROLL-OUT SIZE	0
SCHEDULER WORK AREA LOCATION	013-00
SCHEDULER WORK AREA SIZE	2
START OF LIBRARIES	008-00
END OF LIBRARIES	184-23

// END

```

*
*** THE SYSTEM CONTROL PROGRAMS HAVE BEEN GENERATED
*
*** NORMAL END OF SCP GENERATION
*
*** ADDITIONAL SCP MAY NOW BE GENERATED.
*** TO GENERATE THE MACRO PROCESSOR CALL THE PROCEDURE $SGMAC FROM R1.
*
*** TO GENERATE THE MULTI LINE TERMINAL ADAPTOR PROGRAM CALL THE PROCEDURE
*** $SGMLT FROM R1.
*
// PAUSE
    
```

← This statement causes the system to halt with 90 in the message display unit.

Figure 46 (Part 7 of 9). Example of System Control Program Generation

```
// CALL $SGMAC,R1
XX CALL $SGM01,R1
XX LOAD $MAINT,R1
*
***          MACRU PROCESSOR AND I/O MACROS
*
XX RUN
// RUN
// COPY FROM-R1,TO-F1,LIBRARY-D,RETAIN-P,NAME-$MPX.ALL
// COPY FROM-R1,TO-F1,LIBRARY-S,RETAIN-P,NAME-$ALOC
// COPY FROM-R1,TO-F1,LIBRARY-S,RETAIN-P,NAME-$CLOS
// COPY FROM-R1,TO-F1,LIBRARY-S,RETAIN-P,NAME-$DTFD
// COPY FROM-R1,TO-F1,LIBRARY-S,RETAIN-P,NAME-$EOJ
// COPY FROM-R1,TO-F1,LIBRARY-S,RETAIN-P,NAME-$FTCH
// COPY FROM-R1,TO-F1,LIBRARY-S,RETAIN-P,NAME-$FIND
// COPY FROM-R1,TO-F1,LIBRARY-S,RETAIN-P,NAME-$GETD
// COPY FROM-R1,TO-F1,LIBRARY-S,RETAIN-P,NAME-$IUBD
// COPY FROM-R1,TO-F1,LIBRARY-S,RETAIN-P,NAME-$IOED
// COPY FROM-R1,TO-F1,LIBRARY-S,RETAIN-P,NAME-$LOAD
// COPY FROM-R1,TO-F1,LIBRARY-S,RETAIN-P,NAME-$OPEN
// COPY FROM-R1,TO-F1,LIBRARY-S,RETAIN-P,NAME-$PRNT
// COPY FROM-R1,TO-F1,LIBRARY-S,RETAIN-P,NAME-$PUTD
// COPY FROM-R1,TO-F1,LIBRARY-S,RETAIN-P,NAME-$DTFT
// COPY FROM-R1,TO-F1,LIBRARY-S,RETAIN-P,NAME-$DTOT
// COPY FROM-R1,TO-F1,LIBRARY-S,RETAIN-P,NAME-$WTT
// END

XX CALL $SGM02,R1
XX LOAD $MAINT,R1
*
***          MACRD PROCESSOR AND I/O MACROS
*
XX RUN
// COPY FROM-R1,TO-F1,LIBRARY-S,RETAIN-P,NAME-$RDD
// COPY FROM-R1,TO-F1,LIBRARY-S,RETAIN-P,NAME-$DTON
// COPY FROM-R1,TO-F1,LIBRARY-S,RETAIN-P,NAME-$DTON
// COPY FROM-R1,TO-F1,LIBRARY-S,RETAIN-P,NAME-$DTFU
// COPY FROM-R1,TO-F1,LIBRARY-S,RETAIN-P,NAME-$SVC
// COPY FROM-R1,TO-F1,LIBRARY-S,RETAIN-P,NAME-$WAIT
// COPY FROM-R1,TO-F1,LIBRARY-S,RETAIN-P,NAME-$WR TD
// COPY FROM-R1,TO-F1,LIBRARY-S,RETAIN-P,NAME-$XCTL
// COPY FROM-R1,TO-F1,LIBRARY-S,RETAIN-P,NAME-$GPU
// COPY FROM-R1,TO-F1,LIBRARY-S,RETAIN-P,NAME-$PKBU
// COPY FROM-R1,TO-F1,LIBRARY-S,RETAIN-P,NAME-$CONN
// COPY FROM-R1,TO-F1,LIBRARY-S,RETAIN-P,NAME-$GETT
// COPY FROM-R1,TO-F1,LIBRARY-S,RETAIN-P,NAME-$PUTT
// COPY FROM-R1,TO-F1,LIBRARY-S,RETAIN-P,NAME-$RDT
// COPY FROM-R1,TO-F1,LIBRARY-S,RETAIN-P,NAME-$WR TT
// COPY FROM-R1,TO-F1,LIBRARY-S,RETAIN-P,NAME-$CTLT
// COPY FROM-R1,TO-F1,LIBRARY-S,RETAIN-P,NAME-$CHK
// COPY FROM-R1,TO-F1,LIBRARY-S,RETAIN-P,NAME-$CKL
// COPY FROM-R1,TO-F1,LIBRARY-S,RETAIN-P,NAME-$SNAP
// COPY FROM-R1,TO-F1,LIBRARY-S,RETAIN-P,NAME-$TRAN
// COPY FROM-R1,TO-F1,LIBRARY-S,RETAIN-P,NAME-$TRL
// COPY FROM-R1,TO-F1,LIBRARY-S,RETAIN-P,NAME-$TRTB
// COPY FROM-R1,TO-F1,LIBRARY-R,RETAIN-P,NAME=$COAM,NEWNAME=$COAM
// COPY FROM-R1,TO-F1,LIBRARY-R,RETAIN-P,NAME=$B.M.ALL,NEWNAME=$B.M
// END
```

● Figure 46 (Part 8 of 9). Example of System Control Program Generation

```

// CALL $SGMLT,K1
XX CALL $SGMJ3,K1
XX LOAD $MAINT,F1
*
***      ALTA PROGRAM
*
XX RJN
// RUN
// COPY FROM-R1,IU-F1,RETAIN-P,LIBRARY-K,NAME=$@ML.ALL,NEWNAME-$@ML
// COPY FROM-R1,IU-F1,RETAIN-P,LIBRARY-U,NAME=$@ML.ALL,NEWNAME-$@ML
// COPY FROM-R1,IU-F1,RETAIN-P,LIBRARY-U,NAME=$ML.ALL
// COPY FROM-R1,IU-F1,RETAIN-P,LIBRARY-S,NAME=$CLM
// COPY FROM-R1,IU-F1,RETAIN-P,LIBRARY-S,NAME=$CTLM
// COPY FROM-R1,IU-F1,RETAIN-P,LIBRARY-S,NAME=$DTFM
// COPY FROM-R1,IU-F1,RETAIN-P,LIBRARY-S,NAME=$DTQM
// COPY FROM-R1,IU-F1,RETAIN-P,LIBRARY-S,NAME=$OPM
// COPY FROM-R1,IU-F1,RETAIN-P,LIBRARY-S,NAME=$PULM
// COPY FROM-R1,IU-F1,RETAIN-P,LIBRARY-S,NAME=$RB40
// COPY FROM-R1,IU-F1,RETAIN-P,LIBRARY-S,NAME=$RC40
// COPY FROM-R1,IU-F1,RETAIN-P,LIBRARY-S,NAME=$RC41
// COPY FROM-R1,IU-F1,RETAIN-P,LIBRARY-S,NAME=$RC50
// COPY FROM-R1,IU-F1,RETAIN-P,LIBRARY-S,NAME=$RDM
// END

```

```

XX CALL $SGMJ4,K1
XX LOAD $MAINT,F1
*
***      ALTA PROGRAM
*
XX RJN
// COPY FROM-R1,IU-F1,RETAIN-P,LIBRARY-S,NAME=$RF40
// COPY FROM-R1,IU-F1,RETAIN-P,LIBRARY-S,NAME=$RF41
// COPY FROM-R1,IU-F1,RETAIN-P,LIBRARY-S,NAME=$RF50
// COPY FROM-R1,IU-F1,RETAIN-P,LIBRARY-S,NAME=$RJ40
// COPY FROM-R1,IU-F1,RETAIN-P,LIBRARY-S,NAME=$RB40
// COPY FROM-R1,IU-F1,RETAIN-P,LIBRARY-S,NAME=$JRM
// COPY FROM-R1,IU-F1,RETAIN-P,LIBRARY-S,NAME=$S040
// COPY FROM-R1,IU-F1,RETAIN-P,LIBRARY-S,NAME=$S041
// COPY FROM-R1,IU-F1,RETAIN-P,LIBRARY-S,NAME=$S050
// COPY FROM-R1,IU-F1,RETAIN-P,LIBRARY-S,NAME=$WRTM
// COPY FROM-R1,IU-F1,RETAIN-P,LIBRARY-S,NAME=$GEN
// END

```

● Figure 46 (Part 9 of 9). Example of System Control Program Generation

## Program Product Generation

### Consideration 1

Program product generation can be performed:

1. When SCP generation has just been completed. In this case, proceed to *Consideration 2*.
2. At any later time. For example, you did not want to perform program product generation immediately after SCP generation, or you ordered a new program product at a later time which does not require you to perform system control program generation again. In either case, perform the following to prepare F1 as if system control program generation has just been completed before going to *Consideration 2*.

### Backing up F1

1. Mount an initialized scratch disk cartridge on R1.
2. Ready disks.
3. Punch these statements:

1	4	8	12	16	20	24	28	32	36	40	44
//	DATE	00/00/00									
//	LOAD	#COPY,F1									
//	RUN										
//	COPYPACK	FROM-F1,TO-R1									
//	END										

4. Place statements you just punched in primary hopper.
5. Press reader START.
6. Ready printer.
7. Set program load selector at FIXED DISK and data switches to indicate 1442 if your system input device is the 1442.
8. Press PROGRAM LOAD. If your system has DPF, EJ is displayed in both message display units when initial program loading is complete. Press appropriate HALT/RESET key to continue.

When EJ is displayed in the message display unit, your system on F1 has been copied to R1. This is your backup disk cartridge. You now delete all libraries and files on F1.

### Deleting All Libraries and Files on F1

1. Clear cards from reader.
2. Remove cards from stacker 1.
3. Remove backup disk cartridge on R1.
4. Mount your tailored system disk cartridge on R1, and ready disks.
5. Punch these statements:

1	4	8	12	16	20	24	28	32	36	40	44
//	DATE	00/00/00									
//	NOHALT										
//	LOAD	SMAINT,R1									
//	RUN										
//	ALLOCATE	TO-F1,SOURCE-0,OBJECT-0									
//	END										
//	HALT										
//	LOAD	#DELET,R1									
//	RUN										
//	REMOVE	UNIT-F1,LABEL-VTOC,PACK-nnnnnn									
//	END										

Note: nnnnnn is the name of the pack.  
You must fill in this parameter.



6. Place punched statements in primary hopper.
7. Set program load selector at REMOVABLE DISK and data switches to indicate 1442 if your system input device is the 1442.
8. Press PROGRAM LOAD. If your system has DPF, EJ is displayed in both message display units. Press appropriate HALT/RESET key to continue.

All libraries and files on F1 are deleted when EJ is displayed in the message display unit. You can now copy your tailored system on R1 to F1.

*Copying R1 to F1*

1. Clear cards from reader.
2. Remove cards from stacker 1.
3. Punch these statements:

1	4	8	12	16	20	24	28	32	36	40	44
///	LOAD	BCOPY,	R1								
///	RUN										
///	COPYPACK	FROM-R1,	TO-F1								
///	END										

4. Place punched statements in primary hopper.
5. Press reader START.
6. Press console START (or appropriate HALT/RESET key if you have DPF).

Your tailored system on R1 is copied to F1 and, when complete, EJ is displayed in the message display unit. You can now proceed to *Consideration 2*.

*Consideration 2*

A program product can be distributed to you on:

1. The same cartridge as the distribution disk cartridge that contains the system generation programs and the system control programs. In this case, perform *Procedure 1*.
2. A separate disk cartridge. In this case, perform *Procedure 2*.

*Note:* If you have program products on the distribution disk cartridge and also on separate disk cartridges, perform *Procedure 1* first for the program products on the distribution disk cartridge, then perform *Procedure 2* for the program products on separate disk cartridges.

### Procedure 1

1. Figure 47 shows the OCL needed for each program product. Punch the two cards indicated for each program product ordered.
2. Clear cards from reader.
3. Place punched cards in primary hopper.
4. Press reader START.
5. Ready printer.
6. Set rightmost ADDRESS/DATA switch at 0.
7. Press console START (program 1 HALT/RESET key if you have DPF). The program products are copied to F1.

If the program products are only on the distribution disk cartridge, program product generation is complete. At this point you have a tailored system on F1, because it has been generated according to your system configuration and the programs you wanted. I/O ATTENTION occurs when program product generation is complete, because the system is expecting more cards. Proceed to *Completing System Generation* and punch the indicated cards.

If you also have program products on a separate cartridge, perform Procedure 2 before going to *Completing System Generation*.

### Procedure 2

1. Mount disk cartridge containing the program product on R1.
2. Clear cards from reader.
3. Punch a DATE statement and place it in the primary hopper.
4. Figure 47 shows the OCL needed for each program product. Punch the two cards indicated for each program product ordered.
5. Place punched cards in primary hopper.

6. Ready printer.
7. Set program load selector at FIXED DISK and the data switches to indicate 1442 if your system input device is the 1442.
8. Press PROGRAM LOAD.
9. Press reader START. The program product is copied to F1 and, when complete, EJ is displayed in the message display unit.  
*Note:* Repeat steps 1 through 9 for each program product that is on a separate disk cartridge, then perform steps 10 through 14.
10. Remove disk cartridge containing the program products from R1.
11. Mount distribution disk cartridge (the one you used to perform SCP system generation) on R1.
12. Punch a DATE statement and place it in the primary hopper.
13. Set program load selector at REMOVABLE DISK and data switches to indicate 1442 if your system input device is the 1442.
14. Press PROGRAM LOAD. The DATE statement is read and I/O ATTENTION occurs.

At this point you have a tailored system on F1, because it has been generated according to your system configuration and the programs you wanted. I/O ATTENTION occurs when program product generation is complete, because the system is expecting more cards. Proceed to *Completing System Generation* and punch the indicated cards.

Figure 48 is a sample printout of program product generation.

// CALL \$SGRPG, R1	} RPG II Program
// RUN	
// CALL \$SGRPA, R1	} RPG II Program Support for 5445 Disk (see note 1)
// RUN	
// CALL \$SGRPT, R1	} RPG II Program Support for Magnetic Tape (see note 1)
// RUN	
// CALL \$SGBSC, R1	} RPG II Telecommunications Feature
// RUN	
// CALL \$SGAU, R1	} RPG II Auto Report Feature
// RUN	
// CALL \$SGSRT, R1	} Disk Sort Program (see notes 2 and 3)
// RUN	
// CALL \$SGSR5, R1	} Disk Sort 5445 Disk Storage Drive Feature (see note 2)
// RUN	
// CALL \$SGTST, R1	} Disk Resident Magnetic Tape Sort Program
// RUN	
// CALL \$SGCOB, R1	} Subset ANS COBOL Program
// RUN	
// CALL \$SGFTN, R1	} Disk FORTRAN IV Program
// RUN	
// CALL \$SGUTL, R1	} Disk Resident Card Utility Programs
// RUN	
// CALL \$SGASM, R1	} Basic Assembler Program
// RUN	
// CALL \$SGMGR, R1	} 1255 Magnetic Character Reader Utility Program
// RUN	
// CALL \$SGDMO, R1	} 1270/1255 Utility Program
// RUN	

**Note 1:** If you have RPG II and 5445 Disk and/or magnetic tape, you must copy 5445 Disk and/or magnetic tape support for Disk Sort.

**Note 2:** If you have Disk Sort and 5445 Disk you must copy 5445 Disk support for Disk Sort.

**Note 3:** If you need tape I/O support, use // CALL \$SGDST to copy the necessary modules.

- Figure 47. OCL for Program Products and Features

```

// CALL $SGRPG,R1
XX LOAD $MAINT,F1
*
***      RPG II COMPILER PROGRAM
*
XX RUN
// RUN
// COPY FROM-R1,TO-F1,RETAIN-P,LIBRARY-P,NAME-$RPG,NEWNAME-RPG
// COPY FROM-R1,TO-F1,RETAIN-P,LIBRARY-O,NAME-$RP.ALL
// COPY FROM-R1,TO-F1,RETAIN-P,LIBRARY-R,NAME-$@PG.ALL,NEWNAME-$SPG
// COPY FROM-R1,TO-F1,LIBRARY-R,RETAIN-P,NAME-$@R.ALL,NEWNAME-SUBR
// END
// CALL $SGSRT,R1
XX LOAD $MAINT,F1
*
***      DISK SORT PROGRAM
*
XX RUN
// RUN
// COPY FROM-R1,TO-F1,LIBRARY-O,RETAIN-P,NAME-$DS.ALL
// END
// CALL $SGASM,R1
XX LOAD $MAINT,F1
*
***      BASIC ASSEMBLER PROGRAM
*
XX RUN
// RUN
// COPY FROM-R1,TO-F1,LIBRARY-O,RETAIN-P,NAME-$AS.ALL
// END
// CALL $GBSC,R1
XX LOAD $MAINT,F1
*
***      RPG II SUPPORT FOR BINARY SYNCHRONOUS COMMUNICATIONS
*
XX RUN
// RUN
// COPY FROM-R1,TO-F1,RETAIN-R,LIBRARY-R,NAME-$@PB.ALL,NEWNAME-$SPG
// COPY FROM-R1,TO-F1,RETAIN-R,LIBRARY-O,NAME-$RB.ALL,NEWNAME-$RP
// END
// CALL $SGRPA,R1
XX LOAD $MAINT,F1
*
***      RPG II 5445 DISK SUPPORT
*
XX RUN
// RUN
// COPY FROM-R1,TO-F1,LIBRARY-O,RETAIN-P,NAME-$RXXA,NEWNAME-$RPXA
// END

```

```

// CALL $SGRPT,R1
XX LOAD $MAINT,R1
*
***      RPG II SUPPORT FOR TAPE
*
XX RUN
// RUN
// COPY FROM-R1,TO-F1,LIBRARY-O,RETAIN-P,NAME-$RXXB,NEWNAME-$RPXB
// END
// CALL $SGAU,R1
XX LOAD $MAINT,F1
*
***      AUTO REPORT PROGRAM
*
XX RUN
// RUN
// COPY FROM-R1,TO-F1,RETAIN-P,LIBRARY-ALL,NAME-$AU.ALL
// COPY FROM-R1,TO-F1,RETAIN-P,LIBRARY-P,NAME-AUTO
// END
// CALL $SGDST,R1
XX LOAD $MAINT,R1
*
***      DISK SORT SUPPORT FOR TAPE INPUT/OUTPUT
*
XX RUN
// RUN
// COPY FROM-R1,TO-F1,RETAIN-P,LIBRARY-O,NAME-$DZ.ALL,NEWNAME-$DS
// END
// CALL $SGTST,R1
XX LOAD $MAINT,R1
*
***      TAPE SORT
*
XX RUN
// RUN
// COPY FROM-R1,TO-F1,RETAIN-P,LIBRARY-O,NAME-$TS.ALL
// END

```

Figure 48 (Part 1 of 4). Example of Program Product Generation

```

// CALL $SGSR5,R1
XX LOAD $MAINT,R1
*
***      DISK SORT FOR DISK 5445 SUPPORT
*
XX RUN
// RUN
// COPY FROM-R1,TO-F1,RETAIN-P,LIBRARY-O,NAME-$DX.ALL,NEWNAME-$DS
// END
// CALL $SGDMO,R1
XX LOAD $MAINT,F1
*
***      TERMINAL READER IN OPTICS UTILITY PROGRAM
*
XX RUN
// RUN
// COPY FROM-R1,TO-F1,RETAIN-P,LIBRARY-O,NAME-$MO.ALL
// END
// CALL $SGMCR,R1
XX LOAD $MAINT,F1
*
***      1255 MAGNETIC INK CHARACTER READER UTILITY PROGRAM
*
XX RUN
// RUN
// COPY FROM-R1,TO-F1,LIBRARY-O,RETAIN-P,NAME-$MI.ALL
// END
// CALL $SGUTL,R1
XX LOAD $MAINT,F1
*
***      CARD UTILITY PROGRAMS
*
XX RUN
// RUN
// COPY FROM-R1,TO-F1,RETAIN-P,LIBRARY-O,NAME-$CS.ALL
// COPY FROM-R1,TO-F1,RETAIN-P,LIBRARY-O,NAME-$REPRO
// COPY FROM-R1,TO-F1,RETAIN-P,LIBRARY-O,NAME-$CLIST
// COPY FROM-R1,TO-F1,RETAIN-P,LIBRARY-O,NAME-$DREC
// COPY FROM-R1,TO-F1,RETAIN-P,LIBRARY-O,NAME-$DVER
// COPY FROM-R1,TO-F1,RETAIN-P,LIBRARY-O,NAME-$CNVRT
// END
// CALL $SGCOB,R1
XX LOAD $MAINT,F1
*
***      COBOL COMPILER PROGRAM
*
XX RUN
// RUN
// COPY FROM-R1,TO-F1,LIBRARY-S,RETAIN-P,NAME-CBLTST
// COPY FROM-R1,TO-F1,LIBRARY-P,RETAIN-P,NAME-COBOL
// COPY FROM-R1,TO-F1,LIBRARY-O,RETAIN-P,NAME-$CB.ALL
// COPY FROM-R1,TO-F1,LIBRARY-R,RETAIN-P,NAME-$CB.ALL
// END

```

Figure 48 (Part 2 of 4). Example of Program Product Generation



```

$SGF03
// LOAD $MAINT,F1
*
***          FORTRAN COMPILER PROGRAM
*
// RUN
// COPY FROM-R1,IO-F1,RETAIN-P,LIBRARY-R,NAME-READ
// COPY FROM-R1,IO-F1,RETAIN-P,LIBRARY-R,NAME-SETINQ
// COPY FROM-R1,IO-F1,RETAIN-P,LIBRARY-R,NAME-SIN
// COPY FROM-R1,IO-F1,RETAIN-P,LIBRARY-R,NAME-SKIP
// COPY FROM-R1,IO-F1,RETAIN-P,LIBRARY-R,NAME-SLITE
// COPY FROM-R1,IO-F1,RETAIN-P,LIBRARY-R,NAME-SLITET
// COPY FROM-R1,IO-F1,RETAIN-P,LIBRARY-R,NAME-SPACE
// COPY FROM-R1,IO-F1,RETAIN-P,LIBRARY-R,NAME-SP1403
// COPY FROM-R1,IO-F1,RETAIN-P,LIBRARY-R,NAME-SQRT
// COPY FROM-R1,IO-F1,RETAIN-P,LIBRARY-R,NAME-STACK
// COPY FROM-R1,IO-F1,RETAIN-P,LIBRARY-R,NAME-SUB
// COPY FROM-R1,IO-F1,RETAIN-P,LIBRARY-R,NAME-S1403
// COPY FROM-R1,IO-F1,RETAIN-P,LIBRARY-R,NAME-TANH
// COPY FROM-R1,IO-F1,RETAIN-P,LIBRARY-R,NAME-TYPER
// COPY FROM-R1,IO-F1,RETAIN-P,LIBRARY-R,NAME-UNPAC
// COPY FROM-R1,IO-F1,RETAIN-P,LIBRARY-R,NAME-WHOLE
// COPY FROM-R1,IO-F1,RETAIN-P,LIBRARY-R,NAME-I20R4
// COPY FROM-R1,IO-F1,RETAIN-P,LIBRARY-R,NAME-SHIFT
// COPY FROM-R1,IO-F1,RETAIN-P,LIBRARY-R,NAME-SHIFTR
// COPY FROM-R1,IO-F1,RETAIN-P,LIBRARY-R,NAME-SET1
// COPY FROM-R1,IO-F1,RETAIN-P,LIBRARY-R,NAME-SET0
// COPY FROM-R1,IO-F1,RETAIN-P,LIBRARY-R,NAME-IBTST
// COPY FROM-R1,IO-F1,RETAIN-P,LIBRARY-O,NAME-$FOO1
// END
    
```

```

$SGF05
// LOAD $MAINT,F1
*
***          FORTRAN COMPILER PROGRAM
*
// RUN
// COPY FROM-R1,TO-F1,RETAIN-P,LIBRARY-O,NAME-$FO24
// COPY FROM-R1,TO-F1,RETAIN-P,LIBRARY-O,NAME-$FO25
// COPY FROM-R1,IO-F1,RETAIN-P,LIBRARY-O,NAME-$FO26
// COPY FROM-R1,TO-F1,RETAIN-P,LIBRARY-O,NAME-$FO27
// COPY FROM-R1,IO-F1,RETAIN-P,LIBRARY-O,NAME-$FO28
// COPY FROM-R1,TO-F1,RETAIN-P,LIBRARY-O,NAME-$FO29
// COPY FROM-R1,IO-F1,RETAIN-P,LIBRARY-O,NAME-$FO30
// COPY FROM-R1,TO-F1,RETAIN-P,LIBRARY-O,NAME-$FO31
// COPY FROM-R1,IO-F1,RETAIN-P,LIBRARY-O,NAME-$FO32
// COPY FROM-R1,TO-F1,RETAIN-P,LIBRARY-O,NAME-$FO33
// COPY FROM-R1,IO-F1,RETAIN-P,LIBRARY-O,NAME-$FO34
// COPY FROM-R1,TO-F1,RETAIN-P,LIBRARY-O,NAME-$FO35
// COPY FROM-R1,IO-F1,RETAIN-P,LIBRARY-O,NAME-$FO36
// COPY FROM-R1,TO-F1,RETAIN-P,LIBRARY-O,NAME-$FO37
// COPY FROM-R1,IO-F1,RETAIN-P,LIBRARY-O,NAME-$FO38
// COPY FROM-R1,TO-F1,RETAIN-P,LIBRARY-O,NAME-$FO39
// COPY FROM-R1,IO-F1,RETAIN-P,LIBRARY-O,NAME-$FO30A
// COPY FROM-R1,TO-F1,RETAIN-P,LIBRARY-O,NAME-$FO00D
// COPY FROM-R1,IO-F1,RETAIN-P,LIBRARY-O,NAME-$FORTN
// COPY FROM-R1,TO-F1,RETAIN-P,LIBRARY-P,NAME-FORTB
// COPY FROM-R1,IO-F1,RETAIN-P,LIBRARY-P,NAME-FORTC
// COPY FROM-R1,TO-F1,RETAIN-P,LIBRARY-P,NAME-FORTL
// COPY FROM-R1,TO-PUNCH,LIBRARY-S,NAME-FNTST
// END
    
```

● Figure 48 (Part 3 of 3). Example of Program Product Generation

*Note:* This example is Fortran IV Version 1 Modification Level 1.

```

$SGF04
// LOAD $MAINT,F1
*
***          FORTRAN COMPILER PROGRAM
*
// RUN
// COPY FROM-R1,TO-F1,RETAIN-P,LIBRARY-O,NAME-$FO02
// COPY FROM-R1,TO-F1,RETAIN-P,LIBRARY-O,NAME-$FO03
// COPY FROM-R1,TO-F1,RETAIN-P,LIBRARY-O,NAME-$FO04
// COPY FROM-R1,TO-F1,RETAIN-P,LIBRARY-O,NAME-$FO05
// COPY FROM-R1,TO-F1,RETAIN-P,LIBRARY-O,NAME-$FO06
// COPY FROM-R1,TO-F1,RETAIN-P,LIBRARY-O,NAME-$FO07
// COPY FROM-R1,TO-F1,RETAIN-P,LIBRARY-O,NAME-$FO08
// COPY FROM-R1,TO-F1,RETAIN-P,LIBRARY-O,NAME-$FO09
// COPY FROM-R1,TO-F1,RETAIN-P,LIBRARY-O,NAME-$FO59
// COPY FROM-R1,TO-F1,RETAIN-P,LIBRARY-O,NAME-$FO10
// COPY FROM-R1,TO-F1,RETAIN-P,LIBRARY-O,NAME-$FO11
// COPY FROM-R1,TO-F1,RETAIN-P,LIBRARY-O,NAME-$FO12
// COPY FROM-R1,TO-F1,RETAIN-P,LIBRARY-O,NAME-$FO13
// COPY FROM-R1,TO-F1,RETAIN-P,LIBRARY-O,NAME-$FO14
// COPY FROM-R1,TO-F1,RETAIN-P,LIBRARY-O,NAME-$FO15
// COPY FROM-R1,TO-F1,RETAIN-P,LIBRARY-O,NAME-$FO16
// COPY FROM-R1,TO-F1,RETAIN-P,LIBRARY-O,NAME-$FO17
// COPY FROM-R1,TO-F1,RETAIN-P,LIBRARY-O,NAME-$FO18
// COPY FROM-R1,TO-F1,RETAIN-P,LIBRARY-O,NAME-$FO19
// COPY FROM-R1,TO-F1,RETAIN-P,LIBRARY-O,NAME-$FO20
// COPY FROM-R1,TO-F1,RETAIN-P,LIBRARY-O,NAME-$FO21
// COPY FROM-R1,TO-F1,RETAIN-P,LIBRARY-O,NAME-$FO22
// COPY FROM-R1,TO-F1,RETAIN-P,LIBRARY-O,NAME-$FO23
// END
    
```

● Figure 48 (Part 2 of 3). Example of Program Product Generation

**Completing System Generation and Installation Verification**

Although you have a usable, tailored system on F1 at this time, the system generation procedure is not complete until the tailored system on F1 has been copied to R1 to create a removable system pack. The tailored system on F1 contains the following programs:

- Minimum system SCP and the SCP to support the system configuration options you selected.
- Disk utilities.
- Data management routines to support the 5444 disk, MFCU, and 5203 printer.
- Other SCP program features you have generated.
- Program products and features you have generated.

The procedure to copy your tailored system from F1 to R1 is initiated as follows:

1. Punch the following cards:

1	4	8	12	16	20	24	28	32	36	40	44
//	HALT										
//	CALL	\$SGUPC, R1									
//	RUN										

2. Clear cards from reader.
3. Place the three punched cards in primary hopper.
4. Place blank cards in secondary hopper of MFCU, or behind cards from step 3 if your system input device is the 1442.
5. Press reader START. PRIMARY READY light turns on. System generation continues.

A deck of punched cards (Figure 49), needed to continue with system generation, is in stacker 4. Halt EJ is displayed in the message display unit. You can now copy the system from F1 to R1.

*Note:* If you are performing system generation from the 1442, the punched cards will go to stacker 2.

*Preparing for the Copy of Your Tailored System on F1 to R1*

1. Clear cards from reader and remove cards from stacker 1.
2. Remove deck of punched cards from stacker 4.
3. Remove these two cards from the deck and discard them:

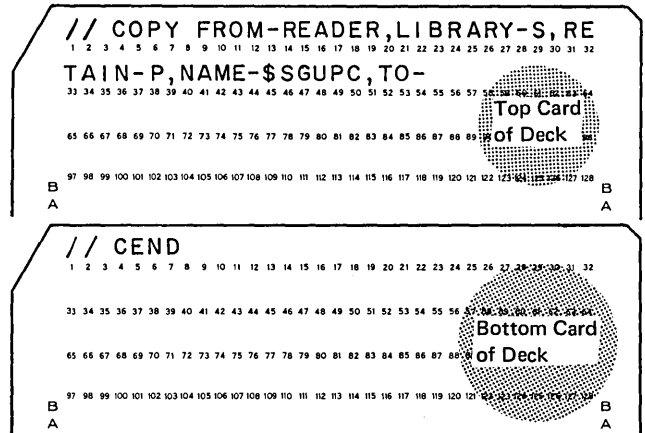

4. Place punched cards in primary hopper.
5. Press reader START.
6. Remove distribution disk cartridge from R1 and store it.
7. Mount a scratch cartridge on R1 and ready disks.
8. Set program load selector at FIXED DISK and data switches to 1442 if your system input device is the 1442.
9. Press PROGRAM LOAD. Initial program loading is performed and, when complete, the system begins reading cards from the reader.

If your system has DPF, EJ will be displayed in both message display units when initial program loading is complete. Press program 1 HALT/RESET key to continue.

A halt of 90 is displayed in the message display unit. This halt is provided to ensure that you have a scratch cartridge on R1. The cartridge on R1 will now be initialized. The volume label will be SYSTEM.





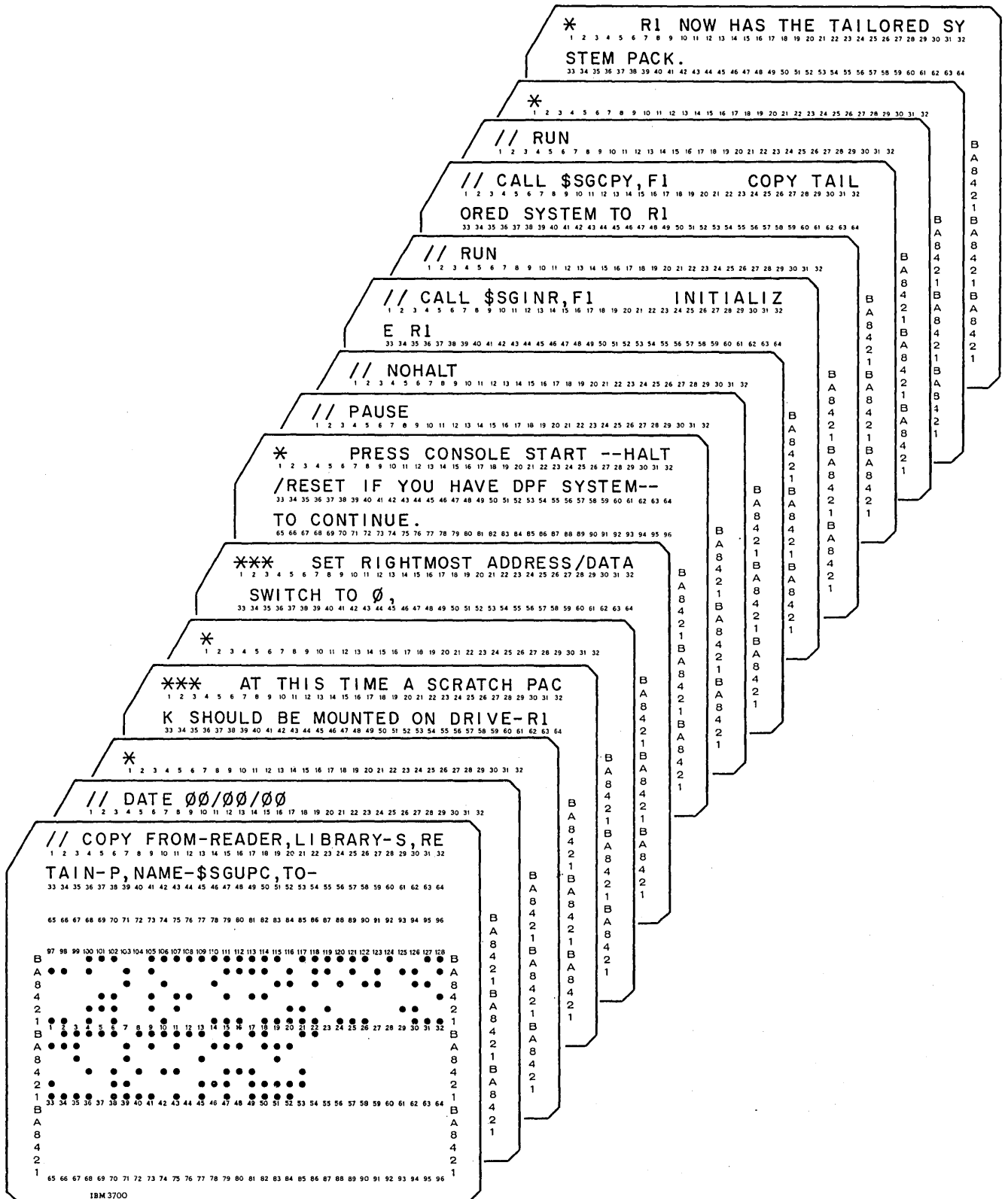

Figure 49 (Part 1 of 2). Punched Cards for Completing System Generation

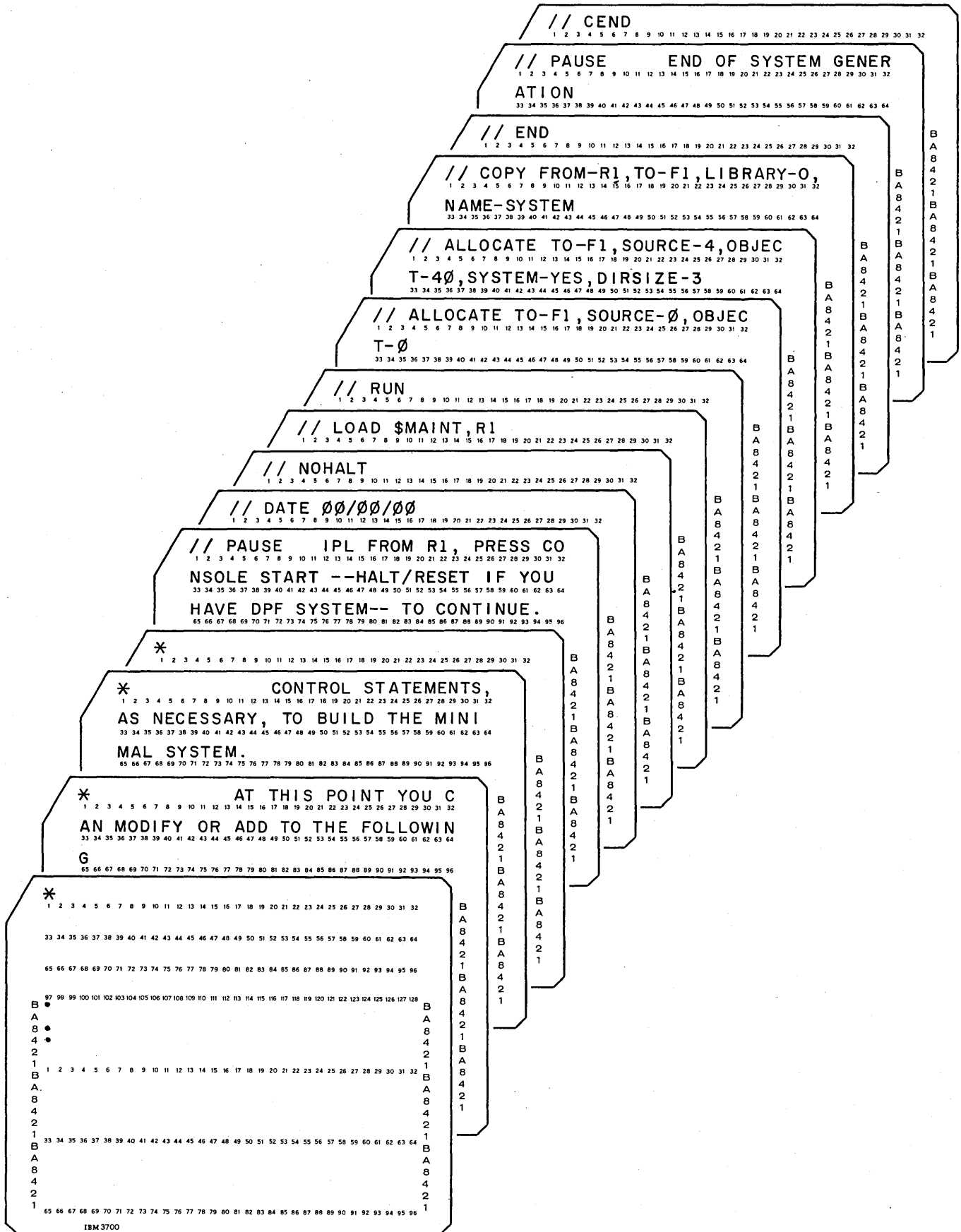

Figure 49 (Part 2 of 2). Punched Cards for Completing System Generation

### Copying Your Tailored System on F1 to R1

1. Set rightmost ADDRESS/DATA switch at 0.
2. Press console START (program 1 HALT/RESET key if you have DPF).

The disk on R1 is initialized and your system is copied to R1. You now have two identical tailored systems on R1 and F1 containing all the programs generated. The system halts with 90 displayed in the message display unit.

Identify the cartridge on R1 as your tailored system disk cartridge (the disk name is SYSTEM). After you have done this, you should run sample programs to ensure that your system has been generated properly. Information necessary to run the RPG II sample program is provided in *Appendix C*.

### Options and Considerations After System Generation

System generation is complete; you do not have to perform the following procedures if you want to leave the entire tailored system on F1. However, if you want to create a minimal system on F1, create program packs, or delete unneeded programs and procedures from these packs, use the procedures in the following sections.

#### Building a Minimal Resident System on F1

The following procedures will delete the tailored system on F1 and replace it with a *minimal resident system*. The minimal resident system will consist of the system control programs needed to sustain the IPL process and read OCL statements. If any disk utility programs or program products are desired on F1, COPY statements have to be prepared to include them. The second ALLOCATE statement can also be modified to increase or decrease the size of your libraries. COPY/DELETE statement parameters, number of modules, and library space requirements for all separately-callable programs are given in *Appendix E*, under the heading *Determining Library Requirements on Generated System Packs and Program Packs*. You can determine the number of tracks required for source and object libraries by using the tables and examples in that section. If you expect to add any programs to these libraries later, you should leave space for them now.

Use the following procedure to build a minimal resident system on F1:

1. Modify or add more of the following statements:

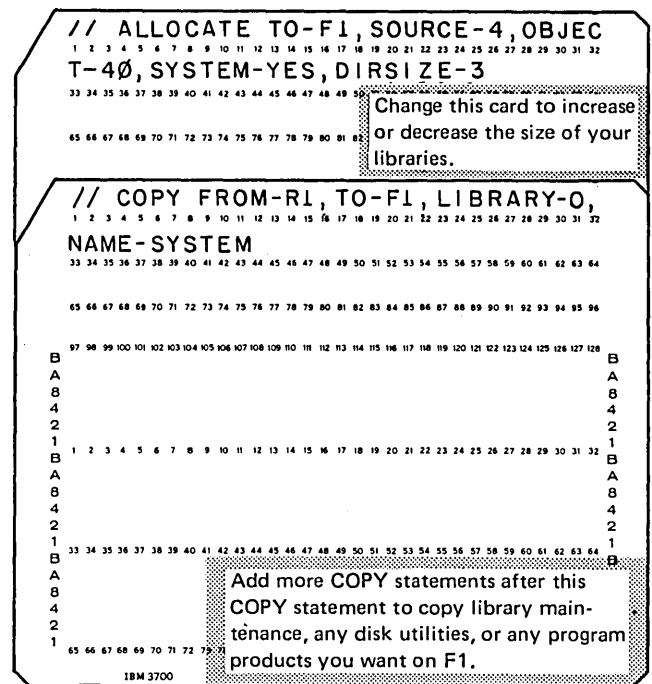

2. Press reader STOP and remove the cards from the primary hopper. If you have modified the ALLOCATE statement, replace the second ALLOCATE statement in the deck with the modified statement. If you wish to copy additional programs to F1, place the additional COPY statements in front of the END statement.
3. Press reader START.
4. Set program load selector at REMOVABLE DISK and data switches to 1442 if your system input device is the 1442.
5. Press PROGRAM LOAD. Initial program loading is performed and, when complete, the system begins reading cards from the reader.

If your system has DPF, EJ will be displayed in both message display units when initial program loading is complete. Press program 1 HALT/RESET key to continue.

System generation of the minimal resident system on F1 is complete when a halt of 90 is displayed in the message display unit. Figure 50 is a sample printout of completing system generation.

```
// HALT
// CALL $SGUPC,RI
XX LOAD $MAINT,RI
*
*** THIS CONTROL DECK PUNCHES OUT THE FOLLOW-UP SYSTEM GENERATION INSTRUCTION
*** CARDS.
*** THE FIRST CARD --A COPY CARD-- AND THE LAST CARD -- A END CARD-- THAT ARE
*** PUNCHED OUT MUST BE DISCARDED BEFORE PLACING THE INSTRUCTION CARDS INTO
*** THE READER.
```

You prepared these cards.

```
XX RUN
// RUN
// COPY FROM-RI, TO-PRTPH, LIBRARY-S, NAME-$SGUPC
```

You prepared this card.

```
$SGUPC
// DATE 00/00/00
*
*** AT THIS TIME A SCRATCH PACK SHOULD BE MOUNTED ON DRIVE-RI
*
*** SET RIGHTMOST ADDRESS/DATA SWITCH TO 0,
* PRESS CONSOLE START --HALT/RESET IF YOU HAVE DPF SYSTEM-- TO CONTINUE.
// PAUSE
// NUHALT
// CALL $SGINR,F1 INITIALIZE RI
// RUN
// CALL $SGCPY,F1 COPY TAILORED SYSTEM TO RI
// RUN
// CALL $SGIVP,F1
// RUN
*
RI NOW HAS THE TAILORED SYSTEM PACK.
*
AT THIS POINT YOU CAN MODIFY OR ADD TO THE FOLLOWING
CONTROL STATEMENTS, AS NECESSARY, TO BUILD THE MINIMAL SYSTEM.
*
// PAUSE IPL FROM RI, PRESS CONSOLE START --HALT/RESET IF YOU HAVE DPF SYSTEM-
// DATE 00/00/00
// NUHALT
// LOAD $MAINT,RI
// RUN
// ALLOCATE TO-F1, SOURCE-0, OBJECT-0
// ALLOCATE TO-F1, SOURCE-4, OBJECT-40, SYSTEM-YES, DIRSIZE-3
// COPY FROM-RI, TO-F1, LIBRARY-U, NAME-SYSTEM
// END
// PAUSE END OF SYSTEM GENERATION
// END
```

Printout of the punched cards. Place these cards in the primary hopper and continue.

```
// DATE 00/00/00
*
*** AT THIS TIME A SCRATCH PACK SHOULD BE MOUNTED ON DRIVE-RI
*
*** SET RIGHTMOST ADDRESS/DATA SWITCH TO 0,
* PRESS CONSOLE START --HALT/RESET IF YOU HAVE DPF SYSTEM-- TO CONTINUE.
// PAUSE
```

This statement causes the system to halt with 90 in the message display unit. Ensure a scratch cartridge is mounted on RI.

```
// NUHALT
// CALL $SGINR,F1 INITIALIZE RI
XX LOAD $INIT,F1
XX RUN
// RUN
// UIN UNIT-RI, TYPE-CLEAR
// VOL PACK-SYSTEM
// END
INITIALIZATION ON RI COMPLETE
// CALL $SGCPY,F1 COPY TAILORED SYSTEM TO RI
XX LOAD $COPY,F1
*
*** START OF SYSTEM VERIFICATION
*
XX RUN
// RUN
// COPYPACK FROM-F1, TO-RI
// END
COPYPACK IS COMPLETE
// CALL $SGIVP,F1
XX LOAD $SGIVP,F1
XX RUN
// RUN
END OF SYSTEM VERIFICATION
```

```
*
RI NOW HAS THE TAILORED SYSTEM PACK.
*
AT THIS POINT YOU CAN MODIFY OR ADD TO THE FOLLOWING
CONTROL STATEMENTS, AS NECESSARY, TO BUILD THE MINIMAL SYSTEM.
*
// PAUSE IPL FROM RI, PRESS CONSOLE START --HALT/RESET IF YOU HAVE DPF SYSTEM-
```

This statement causes the system to halt with 90 in the message display unit. The ALLOCATE statement can be changed or more COPY statements added at this time.

```
// DATE 00/00/00
// NUHALT
// LOAD $MAINT,RI
// RUN
// ALLOCATE TO-F1, SOURCE-0, OBJECT-0
// ALLOCATE TO-F1, SOURCE-4, OBJECT-40, SYSTEM-YES, DIRSIZE-3
// COPY FROM-RI, TO-F1, LIBRARY-U, NAME-SYSTEM
// END
```

The halt of 90 allows you to:

1. Change this statement.
2. Add COPY statements here to copy additional programs to F1.

```
// PAUSE END OF SYSTEM GENERATION
```

This statement causes the system to halt with 90 in the message display unit.

Figure 50. Example of Completing System Generation

### Deleting Unneeded Programs and Procedures

At the end of system generation, your tailored system (on R1 or F1) contains some system generation procedures not needed in your day-to-day operation; it may also contain other programs and procedures you do not need (see *Appendix E* for additional considerations in this case, and for DELETE parameters). If you wish to have this space available for some other use, you can simply delete these procedures using the following load sequence. However, you must not attempt to remove these procedures from the distribution disk cartridge.

```

// LOAD $MAINT, (R1) or (F1)
// RUN
// DELETE FROM (R1) or (F1), RETAIN-P, LIBRARY-P, NAME-$SG.ALL
(other DELETE statements if desired)
// END

```

### Restoring Active Data Files on F1

After completing your system generation, be sure to copy any active data files to F1 from the back-up disk cartridge that contains your previous-release resident system. This will ensure that you do not inadvertently destroy active data files.

### Building a Program Pack

A program pack may be built anytime after system generation. If you have a 100 cylinder disk, there may not be enough room on one pack for the system and all of your program products; or if you want to have more file space on the system pack, separate your program products by putting them on different packs.

The following procedures tell you how to build a program pack. First, be sure you have a back up copy of the system on F1. Next, determine the number of tracks required for the source and object libraries using *Appendix E*.

If you expect to add any programs to these libraries later, leave space for them now.

### Deleting All Libraries and Files on F1

1. Mount tailored system disk cartridge on R1, and ready disks.
2. Set program load selector at REMOVABLE DISK. If your system input device is the 1442 set data switches appropriately. Press PROGRAM LOAD.
3. Enter the following statements.

```

1  4  8  12  16  20  24  28  32  36  40  44
// DATE 08/08/00
// NOHALT
// LOAD $MAINT, R1
// RUN
// ALLOCATE TO F1, SOURCE-0, OBJECT-0
// END
// HALT
// LOAD $DELETE, R1
// RUN
// REMOVE UNIT-F1, LABEL-VTOC, PACK-nnnnnn
// END

```

Note: nnnnnn is the name of the pack. You must fill in this parameter.

If you have DPF, EJ is displayed in both message display units when initial program loading is complete. Press appropriate HALT/RESET key to continue.

```
// DATE 00/00/00
// LOAD $MAINT,F1
// RUN
// END
```

All files on F1 are deleted when EJ is displayed in the message display unit. You can now copy from R1 to F1.

**Copying from R1 to F1**

1. Set program load selector at REMOVABLE DISK. If your system input device is the 1442 set data switches appropriately. Press PROGRAM LOAD.
2. Punch the following statements.

Note: Place a COPY statement before the // END statement for each program that you want to copy. (See *Determining Library Requirements on Generated System Packs and Program Packs in Appendix E* for the detailed information required to copy or delete individual programs.)

```
// DATE 00/00/00
// LOAD $MAINT,R1
// RUN
// ALLOCATE TO-F1, SOURCE-5, OBJECT-160, SYSTEM-YES
// COPY FROM-R1, LIBRARY-0, NAME-SYSTEM, TO-F1
// COPY FROM-R1, TO-F1, LIBRARY-0, RETAIN-R, NAME-$MA.ALL
// COPY FROM-R1, TO-F1, LIBRARY-0, RETAIN-R, NAME-$CO.ALL
// COPY FROM-R1, TO-F1, LIBRARY-0, RETAIN-R, NAME-$DE.ALL
// COPY FROM-R1, TO-F1, LIBRARY-0, RETAIN-R, NAME-$IN.ALL
// END
```

Note: If the program products that you want to copy to your program pack are currently on R1, place additional COPY statements, for them, in front of the // END card. (See *Determining Library Requirements on Generated System Packs and Program Packs in Appendix E* for detailed information required to copy or delete individual programs.)

If your system has DPF, EJ is displayed in both message display units when initial program loading is complete. Press appropriate HALT/RESET key to continue. EJ will be displayed when the copy is complete.

If your system has DPF, EJ is displayed in both message display units when initial program loading is complete. Press appropriate HALT/RESET key to continue. EJ will be displayed when copy is complete.

Now you are ready to copy the program products to the program pack.

If the program products to be copied are on another pack or packs, you must perform the following six steps for each pack. If the program products are on the pack currently mounted, go to *Copy F1 to Program Pack*.

**Copying F1 to Program Pack**

1. Remove the tailored system pack from R1.
2. Mount the pack containing program products on R1.
3. Set program load selector at FIXED DISK. If your system input device is the 1442 set data switches appropriately. Press PROGRAM LOAD.
4. Enter the following statements.
1. Mount an initialized scratch disk cartridge on R1 and ready disks. This will be your program pack.
2. Set program load selector at FIXED DISK. If your system input device is the 1442 set data switches appropriately. Press PROGRAM LOAD.
3. Enter one of the following sets of cards.

Note: Replace nnn on the ALLOCATE statements with the number of tracks that you have determined are required for your source and object libraries.

Statements to Copy All of F1 to R1:

```
// DATE 00/00/00
// LOAD $MAINT,F1
// RUN
// ALLOCATE TO-R1,SOURCE-nnn,OBJECT-nnn,SYSTEM-YES
// COPY FROM-F1,TO-R1,RETAIN-R,LIBRARY-ALL,NAME-ALL
// END
```

Statements to Copy the System and Selected Programs:

```
// DATE 00/00/00
// LOAD $MAINT,F1
// RUN
// ALLOCATE TO-R1,SOURCE-nnn,OBJECT-nnn,SYSTEM-YES
// COPY FROM-F1,TO-R1,LIBRARY-D,NAME-SYSTEM
// END
```

Note: Place a COPY statement for each program you want to copy in front of the // END statement. (See *Determining Library Requirements on Generated System Packs and Program Packs in Appendix E* for the detailed information required to copy or delete individual programs.)

Statements to Copy Selected Programs:

```
// DATE 00/00/00
// LOAD $MAINT,F1
// RUN
// ALLOCATE TO-R1,SOURCE-nnn,OBJECT-nnn
// END
```

Note: Place a COPY statement for each program you want to copy in front of the // END statement. (See *Determining Library Requirements on Generated System Packs and Program Packs in Appendix E* for the detailed information required to copy or delete individual programs.)

If you have DPF, EJ is displayed in both message display units when initial program loading is complete. Press the appropriate HALT/RESET key to continue. EJ will be displayed when copying is complete.

## PERFORMING SYSTEM GENERATION USING THE 5471 PRINTER/KEYBOARD

### Backing Up your Resident System

*Note:* If you are performing system generation for the first time, proceed to *System Control Program (SCP) Generation*.

#### Initializing a Scratch Disk Cartridge to Which Your Resident System is Copied

1. Mount a scratch disk cartridge (a cartridge that has not been used or a cartridge that can be reused) on R1.
2. Ready disks.
3. Set program load selector at FIXED DISK.
4. Press PROGRAM LOAD. After initial program loading has taken place, the PROCEED light on the 5471 turns on.

If your system has DPF, EJ is displayed in both message display units when initial program loading is complete. Press appropriate HALT/RESET key; 5471 PROCEED light turns on.

5. Key in a DATE statement.

If the scratch disk mounted on R1 in step 1 is not initialized, it must be initialized before continuing. For information on how to initialize a disk, see *IBM System/3 Disk System Control Programming Reference Manual*, GC21-7512.

#### Copying Your Resident System from F1 to R1

After you have initialized the scratch disk cartridge on R1, you must copy your resident system from F1 to R1. To do this, enter the following OCL statements on the console:

```
// LOAD $COPY, F1
// RUN
// COPYPACK FROM-F1, TO-R1
// END
```

When EJ is displayed on the message display unit, your resident system on F1 has been copied to R1. This is your backup disk cartridge. You can now perform system control program generation.

### System Control Program (SCP) Generation

1. Mount distribution disk cartridge for system generation on R1 and ready disks.
2. Ready printer.
3. Set program load selector at REMOVABLE DISK.
4. Set data switches to 5471.
5. Press PROGRAM LOAD. After initial program loading is complete, the 5471 PROCEED light turns on.
6. Enter the current DATE statement on the console.
7. If you are using the standard 48-character printer chain, go to step 8. If a different printer chain is used, an IMAGE statement must be entered after the DATE statement. See *Appendix A* for instructions on using an IMAGE statement.
8. Enter the following OCL statements:

```
// CALL $SGINT, R1
// RUN
```

The procedure \$SGINT initializes F1.

9. Enter the following OCL statements:

```
// CALL $SGEN, R1
// RUN
```



The procedure SSGEN calls a system generation program that enables you to enter system configuration statements on the console. When the 5471 PROCEED light turns on, you may begin entering the statements. The configuration statements must be entered in the correct format and in the correct order. If you make a mistake in entering the statements and a halt occurs, refer to *IBM System/3 Disk System Halt Guide*, GC21-7540, for instructions to recover from these halts.

The size of the supervisor generated for your system depends upon the system generation statements you enter. For information on controlling the size of your supervisor, see *Appendix E*.

The following is an example of the system generation statements you would enter and some of the options you might choose. See Figure 45 for an explanation of the system generation statements. Remember, you must enter all of the system generation statements. However, if you select an option which is not available on your system, the system you generate will not function properly and you must repeat system generation.

Enter the following statements when the 5471 PROCEED light is on; follow by pressing the END key:

```

1      4      8      12     16     20     24     28
// $DCOR CORE-12K
// $DDPF DPF-NO
// $DISK DISKS-'RL,FL'
// $DDSK D5445-NO
// $DTUN TAPES-NO
// $DTON DUALON-NO
// $DTRK TRACK7-NO
// $DATE DATE-MDY
// $DPRN PRINT-5203
// $DWID WIDTH-96
// $DUAL DUAL-NO
// $DLIN LINE-66
// $DCRD CARD-NO
// $DOUT DEV-NO
// $DKBD KEYBD-5471
// $DAUX AUX-NO
// $DCON CON-NO
// $DING INQUIRY-NO
// $DBSC LINE-NO
// $DMCR MICR-NO
// $DCPR CKRS-NO
// $DLKE OVLNK-NO
// $DSAM SIAM-NO
// $DRJE RJE-NO
// $DMLP MLMP-NO
// $DSPV ADD-0
// $DMOC TRIO-NO
// END
    
```

After you have entered the END statement, system generation proceeds to build your system. When EJ is again displayed in the message display unit, press console START (or the program level 1 HALT/RESET key, if you have DPF) to continue and the PROCEED light again turns on.

Enter the following OCL when the 5471 PROCEED light is on:

```

1      4      8      12     16     20     24     28     32     36     40     44     48     52     56
// CALL $SGEN1,RL
// RUN
// CALL $SGLNK,RL
// RUN
// LOAD $MAINT,RL
// RUN
// ALLOCATE TG-FL,OBJECT-nnn,SOURCE-n,SYSTEM-YES,DIRSIZE-n
// END
// CALL $SGCOM,RL
// RUN
// CALL $SGOPT,RL
// RUN
    
```

Note: See *Determining Library Requirements on Generated System Packs and Program Packs* in *Appendix E* for procedures to calculate the OBJECT, SOURCE, and DIRSIZE parameters for the ALLOCATE statement.

SCP generation is complete; the required SCP system resides on F1. Optionally, you can generate additional SCP programs, if you have ordered them, by entering the following:

```

// CALL $SGMAC,R1      Macros and Macro Processor
// RUN
// CALL $SGMLT,R1      Multiple Line Terminal
// RUN                  Adapter RPU (MLTA)
    
```

If you wish, you can now perform program product generation. If you do not wish to perform program product generation at this time, continue with *Completing System Generation and Installation Verification*, later in this section.

### Program Product Generation

Program product generation may be performed immediately after SCP generation or at a later time. If SCP generation has just been completed, perform the procedure under *Program Product Generation*; otherwise, proceed with step 1.

**Backing Up F1**

*Note:* You must not have your distribution cartridge on R1 at this time.

1. Mount an initialized scratch disk cartridge on R1.
2. Ready disks.
3. Enter the following OCL statements:

```
// DATE 00/00/00
// LOAD $COPY, F1
// RUN
// COPYPACK FRDM-F1, TO-R1
// END
```

When EJ is displayed in the message display unit, your system on F1 has been copied to R1. This is your backup disk cartridge. You can now delete all files on F1.

**Deleting All Libraries and Files on F1**

1. Remove backup disk cartridge on R1.
2. Mount your tailored system disk cartridge on R1, ready disks, and perform the IPL process from R1.
3. Enter the following OCL statements:

```
// DATE 00/00/00
// NOHALT
// LOAD $MAINT, R1
// RUN
// ALLOCATE TO-F1, SOURCE-0, OBJECT-0
// END
// HALT
// LOAD $DELET, R1
// RUN
// REMOVE UNIT-F1, LABEL-VTOC, PACK-nnnnnn
// END
```

*Note:* nnnnnn is the name you have assigned to the disk pack F1.

You can now copy your tailored system on R1 to F1.

**Copying R1 to F1**

Enter the following OCL statements:

```
// LOAD $COPY, F1
// RUN
// COPYPACK FROM-R1, TO-F1
// END
```

When R1 has been copied to F1, EJ is displayed in the message display unit.

**Generating Program Products**

1. Mount the distribution disk cartridge on R1 which contains the program products you wish to generate.
2. Ready disks.
3. Set program load selector at FIXED DISK.
4. Press PROGRAM LOAD.
5. Enter the OCL needed for each program product you wish to copy. Refer to Figure 47 for the required OCL.
6. Repeat steps 1-5 for each separate disk cartridge which contains program products you wish to copy. Then proceed with *Completing System Generation and Installation Verification*.

**Completing System Generation and Installation Verification**

1. Mount a scratch disk cartridge on R1.
2. Enter the following OCL statements:

```
// CALL $SGINR, F1 This will initialize R1.
// RUN
// CALL $SGCPY, F1 This will copy the tailored
// RUN system to R1.
```

You now have two identical tailored systems on R1 and F1, containing all the programs generated. Identify the cartridge on R1 as your tailored system disk cartridge (the disk name is SYSTEM). After you have done this, you should run sample programs to ensure that your system has been generated properly. Information necessary to run the RPG II sample program is provided in *Appendix C*.

### Options and Considerations After System Generation

System generation is complete; you do not have to perform the following procedures if you want to leave the entire tailored system on F1. However, if you want to create a minimal system on F1 or delete unneeded programs and procedures from these packs, use the procedures in the following sections. If you want to create separate program packs, see *Building a Program Pack* under *Performing System Generation Using the MFCU or 1442*, modifying the procedure as necessary if your system input device is the 5471.

#### *Building a Minimal Resident System on F1*

The minimal resident system you build on F1 must contain the system control programs needed for the IPL process and those needed to process OCL statements, in addition to any utility programs and program products you desire.

1. Determine the number of tracks required for the source library and directory, object library, and object library directory for the programs you wish to copy by following the procedures under *Determining Library Requirements on Generated System Packs and Program Packs* in *Appendix E*.
2. Enter the following OCL statements:

```
// LOAD $MAINT, R1
// RUN
// ALLOCATE TO-F1, OBJECT-nnn, SOURCE-n, SYSTEM-YES, DIRSIZE-n
// COPY FROM-R1, TO-F1, LIBRARY-Q, NAME-SYSTEM
```

**Note:** The OBJECT, SOURCE, and DIRSIZE parameters in the ALLOCATE statement are those which were calculated in step 1.

3. Enter the COPY statements for the additional utilities, program products, and disk data management routines you wish to include in your minimal system. See *Appendix E* for the LIBRARY and NAME parameters for each program and the library space requirements for each.
4. Enter a // END statement.

You now have a minimal resident system on F1.

### *Deleting Unneeded Programs and Procedures*

At the end of system generation, your tailored system (on R1 or F1) contains some system generation procedures not needed in your day-to-day operation; it may also contain other programs and procedures you do not need (see *Appendix E* for additional considerations in this case, and for DELETE parameters). If you wish to have this space available for some other use, you can simply delete these procedures using the following load sequence. However, you must not attempt to remove these procedures from the distribution disk cartridge.

```
// LOAD $MAINT, R1
// LOAD $MAINT, F1
// RUN
// DELETE FROM-R1, RETAIN-P, LIBRARY-P, NAME-$SG, ALL
// END
```

(Other DELETE statements if desired)

















During loading and execution the sort/collate program prints a job history on the printer. This printout includes a card image of the specifications cards, error messages, and informational messages that tell you what to do to continue the job. Some of these messages are accompanied by programmed halts. The halts are discussed in *IBM System/3 Model 10 Disk System Halt Guide, GC21-7540*.

Sort/collate messages are printed in the following format:

SC xxx X (message)

- SC indicates the sort/collate program
- xxx is the message serial number
- X is the significance code:
  - A—Operator action required.
  - I—Information only.
  - W—Warning message. An abnormal, though possibly deliberate, condition exists. Check the program run sheet.
  - T—Terminal errors in the specification cards. These errors must be corrected before the job can be run.

Generation Phase Messages

SYSTEM/3 MODEL D SORT/COLLATE VERSION xx,  
MODIFICATION LEVEL xx xx/xx/xx

This heading is printed before the listing of the specification cards. The date is the date entered on the // DATE statement read after you performed the IPL process.

SC 011 W INVALID PRINT OPTION, COL. 27

Header card. Valid entries are blank, 0, 1, 2, or 3. All print (blank or 0) is assumed.

SC 009 W INVALID ALT. COLLATING SEQ. ENTRY,  
COL. 26

Header card. Column 26 must be blank or S. S alters the normal collating sequence. S is assumed.

SC 011 LARGEST TOTAL OF CONTROL FIELDS  
INVALID

Header card. Columns 7-12 must contain SORT, MERGE, MATCH, or SELECT. Job is terminated.

SC 011 T SUM OF LENGTHS OF CONTROL FIELDS  
INVALID

Header card. Columns 15-17 must contain a number from 1-100. Job is terminated.

SC 012 T SEQUENCE, COL. 18, NOT VALID

Header card. Sequence entry is not A or D or, in the case of a select run, is not A, D, or S. Job is terminated.

SC 013 T INVALID STACKER SELECT, COL. 19-24

Header card. Columns 19-24 must contain a number from 1-4 or be blank. Job is terminated.

SC 014 T INVALID NUMBER SPECIFICATION,  
COL. 25

Header card. For a MATCH job, entry in column 25 must be 1 or N. Job is terminated.

SC 015 A INVALID ALTERNATE COLLATING  
SEQUENCE CARD

An alternate collating sequence card is missing or unidentifiable (columns 1-8 not ALTSEQ blank blank), or a separator card (\*\*\*) is missing. The recovery procedure for this message is listed under the E5 halt in *IBM System/3 Model 10 Disk System Halt Guide*, GC21-7540.

SC 016 T ALTERNATE COLLATING SEQUENCE  
DATA INVALID

Entries on ALTSEQ cards must consist of 4-column sets of hexadecimal characters (A-F and 0-9). Asterisks are printed under invalid or missing entries. Job is terminated.

SC 017 T INVALID SPECIFICATION TYPE, COL. 6

Column 6 is not I, O, or F (or H for first card). Card is bypassed.

SC 018 W FIRST SPEC. IN SET NEEDS BLANK  
CONTINUATION

Column 7 in the first record type specification of a set must be blank. Record type specifications have an I or O in column 6. Blank is assumed.

SC 019 T INVALID CONTINUATION, COL. 7

Column 7 of a record type specification (I or O in column 6) is not A, O, or blank. Card is bypassed.

SC 020 W INVALID C/Z/D/U SPECIFICATION, COL. 8

Entry in column 8 must be C, Z, D, or U except for forced fields, where only C, Z, and D are valid. *C is assumed.*

SC 021 T ILLEGAL ORDER OF SPECIFICATIONS

Specifications are out of order. This error is caused by:

1. Field specification (F in column 6) following an omit specification (O in column 6).
2. Omit specification (O in column 6) following an include specification (I in column 6).
3. Include-all following another include.

Card is bypassed.

SC 022 T INCLUDE OR OMIT AFTER INCLUDE ALL

The include-all card must be the last record type card. Job is terminated.

SC 023 T NO CONTROL FIELD CARDS FOR RECORD TYPE

Control field cards must be used for all jobs except SELECT job with SELECT sequence. Job is terminated.

SC 024 T TOO MANY SOURCE CARDS OR ERRORS

The source cards and diagnostic messages, if any, require more core storage than is available. Reduce the number of source cards or correct the errors. Job is terminated.

SC 025 T ZONE SPECIFIED, FIELD LENGTH MORE THAN 1

When column 8 contains a Z, field length (columns 9-16) must be 1. Job is terminated.

SC 026 T COL. 9-16 OR 20-27 ARE INVALID

Entry in Factor 1, Factor 2, or location fields must be a number from 1 to 96. The number must be right-justified. Job is terminated.

SC 027 T DIGIT OR UNPACKED FIELD LENGTH EXCEEDS 16

When column 8 contains a D or U, field length (columns 9-16 or 20-27) cannot be greater than 16. Job is terminated.

SC 028 T FACTOR 1 LENGTH EXCEEDS 20 FOR CONSTANT

When columns 8 and 19 contain C, the length specified in Factor 1 (columns 9-16) cannot exceed 20. Job is terminated.

SC 029 W SAME SPEC TYPE AS PREVIOUS ASSUMED, COL. 6

Column 6 is blank. If column 7 contains A or O and the preceding spec had an I or O in column 6, I or O from preceding record spec is assumed.

SC 030 W OR CONTINUATION ASSUMED, COL. 7

Column 7 is blank; therefore, an OR condition is assumed. O is assumed.

SC 031 T ZONE SPECIFIED, FACTOR 2 NOT A CONSTANT

When column 8 contains a Z, Factor 2 must be a constant. Job is terminated.

SC 032 T ZONE SPECIFIED, RELATIONSHIP NOT EQ OR NE

When column 8 contains a Z, EQ or NE must be entered in columns 17-18. Job is terminated.

SC 033 T INVALID RELATIONSHIP, COL. 17-18	Columns 17-18 must contain EQ, NE, LT, GT, LE, or GE. Job is terminated.
SC 034 T INVALID FACTOR 2 TYPE, COL. 19	Column 19 must contain C or F. Job is terminated.
SC 035 W DEFAULT STACKER, NO. 1 ASSUMED, COL. 9	Column 9 must contain 1, 2, or 3. 1 is assumed.
SC 036 W UNPACKED FACTOR 1 USED WITH ALTSEQ	Factor 1 and Factor 2 are changed as indicated by ALTSEQ statements. This change may affect the units position (and sign) of an unpacked decimal number. If it does, you may not include or omit the desired records. Do not use U (unpacked) record type entries when you specify alternate collating sequence.
SC 040 W INVALID CONTROL FIELD TYPE, COL. 7	Column 7 must contain N, O, or F. N is assumed.
SC 041 W OPPOSITE SPECIFIED, COL. 7. ONLY D AND U ARE VALID	When column 7 contains an O, column 8 must contain a D or U. D is assumed.
SC 042 TOTAL LENGTH OF CONTROL FIELDS EXCEEDED	Sum of control field lengths is greater than length specified on header card. Job is terminated.
SC 040 W INVALID CONTROL FIELD TYPE, COL. 7	Column 7 must contain N, O, or F. N is assumed.
SC 041 W OPPOSITE SPECIFIED, COL. 7. ONLY D IS VALID	When column 7 contains an O, column 8 must contain a D. D is assumed.
SC 042 T CONTROL FIELD GREATER THAN SUM OF LENGTHS	Sum of control field lengths is greater than length specified on header card. Job is terminated.
SC 043 T ILLEGAL FORCE SEQUENCE CONTINUATION	Force-all line with continuation entry in column 19 can only follow a force spec. Job is terminated.
SC 090 I END OF GENERATION PHASE	All specification cards have been read and processed. The Sort/Collate program now prints one of the next three messages.
SC 091 I NO ERRORS IN SOURCE DECK	The specification cards were processed successfully. The Sort/Collate program is ready to do the job. The recovery procedures for this message are listed under the EE halt in <i>IBM System/3 Model 10 Disk System Halt Guide</i> , GC21-7540.
SC 092 A REVIEW WARNING MESSAGE	There are no known errors in source deck; however, abnormal conditions as defined by warning messages exist. The recovery procedures for this message are listed under the EL halt in <i>IBM System/3 Model 10 Disk System Halt Guide</i> , GC21-7540.
SC 093 A ERRORS IN SOURCE DECK, JOB TERMINATED	The job cannot be completed because of errors in the source deck. The recovery procedure for this message is listed under the EA halt in <i>IBM System/3 Model 10 Disk System Halt Guide</i> , GC21-7540.

Execution Phase Messages

*Sort Job*

SC 101 I SORT/COLLATE – SORT JOB – PASS nnnnn

Heading for each pass of a sort job. nnnnn is the number of the pass just completed.

SC 105 I NUMBER OF OMIT CARDS nnnnn

On a sort with omits, nnnnn is the number of omitted cards selected to stackers 2 and 4.

SC 107 I NUMBER OF DATA CARDS nnnnn

nnnnn is the number of cards being sorted. This number does not include a count of omitted cards. Any time the number of cards read does not agree with the number of cards read on the preceding pass, the card count is followed by \*\*\*.

SC 109 I REMAINING STRINGS nnnnn

Strings are groups of sequenced cards.

SC 111 I MAXIMUM PASSES LEFT nnnnn

nnnnn is the maximum number of passes remaining to complete the sort. It is possible that the job will be completed in less passes.

SC 121 A STACKS 1, 2 TO PRI – STACKS 3, 4 TO SEC

Instructions for intermediate passes of a sort job where cards have been selected to all four stackers. Reposition cards as follows:

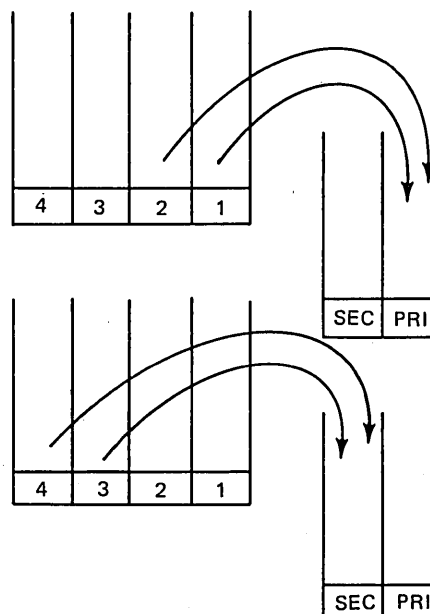

SC 123 A SHORT STRINGS TO PRI AND SEC – CLEAR STACK 1

Instructions for intermediate pass of sort job where cards have been selected to three of the four stackers. Take the smallest group of cards from a stacker and place it in a hopper. It doesn't matter which hopper. Take the next smallest group and place it in the other hopper. This leaves the largest group of cards in a stacker. If these cards are in stacker 2, 3, or 4, they can remain where they are. If they are in stacker 1, remove them from the stacker and set them aside for the next pass.

SC 125 A FEED STACK 1 TO PRI – STACK 3 TO SEC

Printed on omit pass to indicate positioning of data cards for start of sort. Also printed on sort job where cards have been selected to two of four stackers. Reposition cards as follows:

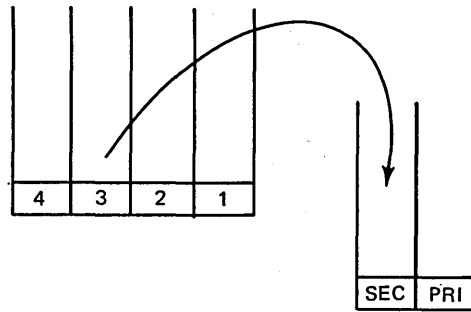
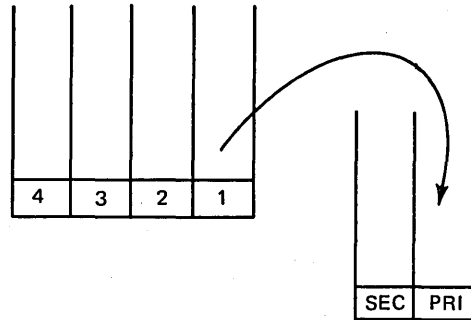

SC 127 A SET ASIDE CARDS FROM STACKS 2 AND 4

On an omit pass, the cards in stackers 2 and 4 are the omitted cards. Set these cards aside before continuing.

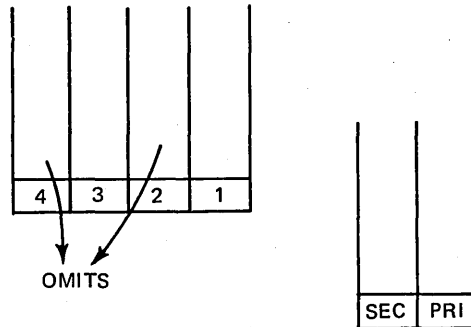

SC 129 A OUTPUT IN STACK 1 – OMITS IN STACKS 2 AND 4

This message indicates that all sorting was completed during the omit pass.

SC 131 A ONE STRING TO PRI AND OTHER TO SEC

Instructions for final pass following a three stack pass. Place the cards from stacker 1 in a hopper. It doesn't matter which one. Place the other group of cards in the other hopper. These cards are in stacker 2, 3, or 4, or were set aside for the last pass.

SC 197 A PRESS MFCU START AND CONSOLE START

Instructions for starting next pass.

SC 199 A SORTING COMPLETED

The job is finished. The sorted cards are in stacker 1.



*Merge Job*

SC 201 I SORT/COLLATE—MERGE JOB	Heading for merge job.
SC 211 I MERGED CARDS nnnnn	Total of cards merged and selected to stacker 1. This number does not include any cards omitted to stackers 2 and 4.
SC 221 I PRIMARY OMIT CARDS nnnnn	nnnnn is the number of cards omitted from the primary hopper and selected into stacker 2.
SC 231 I SECONDARY OMIT CARDS nnnnn	nnnnn is the number of cards omitted from the secondary hopper and selected into stacker 4.
SC 241 A SEQUENCE ERROR —XXX	Cards are out of sequence in XXX, where XXX is PRI or SEC. The recovery procedures for this message are listed under the E1 (primary) or E2 (secondary) halts in <i>IBM System/3 Model 10 Disk System Halt Guide</i> , GC21-7540.
SC 251 I MERGING COMPLETED	The job is finished. The merged cards are in stacker 1.

*Match Job*

SC 301 I SORT/COLLATE—MATCH JOB	Heading for match job.
SC 311 I PRIMARY MATCHED CARDS nnnnn	nnnnn is the number of matched cards from the primary hopper.
SC 321 I SECONDARY MATCHED CARDS nnnnn	nnnnn is the number of matched cards from the secondary hopper.
SC 331 I PRIMARY UNMATCHED CARDS nnnnn	nnnnn is the number of unmatched cards from the primary hopper.
SC 341 I SECONDARY UNMATCHED CARDS nnnnn	nnnnn is the number of unmatched cards from the secondary hopper.
SC 351 I PRIMARY OMIT CARDS nnnnn	nnnnn is the number of omitted cards from the primary hopper.
SC 161 I SECONDARY OMIT CARDS nnnnn	nnnnn is the number of omitted cards from the secondary hopper.
SC 371 A SEQUENCE ERROR — XXX	Cards are out of sequence in XXX, where XXX is PRI or SEC. The recovery procedures for this message are listed under the E1 (primary) or E2 (secondary) halts in <i>IBM System/3 Model 10 Disk System Halt Guide</i> , GC21-7540.
SC 381 A MATCHING COMPLETED	The job is finished. The matched and unmatched cards are in the stackers designated by the programmer on the program run sheet.

*Select Job*

SC 401 I SORT/COLLATE – SELECT JOB

Heading for select job.

SC 411 I INCLUDED CARDS – STACK 1 nnnnn

nnnnn is the number of cards in stacker 1.

SC 421 I INCLUDED CARDS – STACK 2 nnnnn

nnnnn is the number of cards in stacker 2.

SC 431 I INCLUDED CARDS – STACK 3 nnnnn

nnnnn is the number of cards in stacker 3.

SC 441 I OMITTED CARDS nnnnn

nnnnn is the number of non-selected cards routed to stacker 4.

SC 451 A SEQUENCE ERROR–PRI

Cards are out of sequence in the primary hopper. The recovery procedure for this message is included under the E1 halt in *IBM System/3 Model 10 Disk System Halt Guide*, GC21-7540.

SC 461 A SELECTING COMPLETED

The job is finished. The selected cards can appear in all stackers except stacker 4.

## Appendix C. RPG II Sample Program

A sample RPG II program is in a procedure on the distribution disk cartridge. The RPG II sample program actually consists of two individual programs (SAMPL1 and SAMPL2). The SAMPL2 program must be run after the SAMPL1 program since SAMPL2 program uses the output of the SAMPL1 program. The sample programs must be run after system generation is complete. The successful execution of the sample programs indicates that your system has been generated properly. Operating procedures for running the sample programs are shown in the following paragraphs. For a description of what this program is doing and how it is doing it, see *IBM System/3 Disk System RPG II Reference Manual*, GC21-7504.

If your system input device is the 5471 printer/keyboard, ignore the references in the following procedures to MFCU, punching cards, and card reader. Instead, enter OCL statements using the 5471.

### Preparing the Sample Programs for Compilation

1. Mount distribution disk cartridge on R1 and ready disks.
2. Set program load selector to FIXED DISK.
3. Punch the following statements:

//	DATE	00	/	00	/	00	/	00	
//	CALL	\$RPSPL,	R1						
//	RUN								

4. Remove any cards from the stackers.
5. Press reader NPRO. Any cards in the wait station are fed into stacker 1.
6. Place punched statements in primary hopper.
7. Press reader START.
8. Ready printer.
9. Press PROGRAM LOAD. Initial program loading is performed and, when complete, the system begins reading cards from the MFCU.

If your system has DPF, EJ is displayed in the message display unit when initial program loading is complete. Press HALT/RESET to continue.

The system copies the sample programs and all procedures needed to compile and execute the sample programs to F1.









```

// CALL $RPSP2,F1
XX LOAD $RPG,R1
XX FILE NAME=$WORK,UNIT-R1,RETAIN-S,TRACKS-05,PACK-SYSTEM
XX FILE NAME=$SOURCE,UNIT-R1,RETAIN-T,TRACKS-05,PACK-SYSTEM
XX COMPILE UNIT-F1,SOURCE-$SAMP2
XX RUN
// RUN

```

SYSTEM/3 MODEL D

RPGII VERSION 06, MODIFICATION LEVEL 00

12/20/71

```

0101 H      008                                     SAMPL2

0102 F*****
0103 F*                                           *
0104 F* THIS PROGRAM -                           *
0105 F*                                           *
0106 F* 1. MUST BE PRECEDED BY SAMPLE PROGRAM 1 *
0107 F* WHICH LOADS AN INDEXED FILE.           *
0108 F*                                           *
0109 F* 2. READS AN INDEXED FILE SEQUENTIALLY. *
0110 F*                                           *
0111 F* 3. USES A BLOCK LENGTH FOR DISK WHICH  *
0112 F* IS DIFFERENT FROM THAT USED FOR        *
0113 F* LOADING THE FILE IN SAMPLE PROGRAM 1.  *
0114 F*                                           *
0115 F* 4. COUNTS THE NUMBER OF RECORDS READ SO *
0116 F* THAT THE USER CAN QUICKLY VERIFY THAT *
0117 F* 100 RECORDS WERE LOADED.               *
0118 F*                                           *
0119 F*****
0001 0120 FDISKIN IPE F 512 128 06AI 1 DISK      01
0002 0121 FPRINTER O F 96 96 OF PRINTER         SAMPL2

0003 0201 IDISKIN NS 01 1 CO                     SAMPL2
0004 0202 I                                     1 6 KEY   SAMPL2
0005 0203 I                                     82 94 DESC SAMPL2
0006 0204 I                                     126 1280RECNBR SAMPL2

0007 0301 C 01 COUNT ADD 1 COUNT 30             SAMPL2

0008 0401 OPRINTER H 204 1P                     SAMPL2
0009 0402 O OR OF                               SAMPL2
0010 0403 O 5 *KEY*                             SAMPL2
0011 0404 O 22 *DESCRIPTION*                   SAMPL2
0012 0405 O 30 *PAGE*                          SAMPL2
0013 0406 O PAGE Z 35                          SAMPL2
0014 0407 O D 1 01                             SAMPL2
0015 0408 O KEY 6                              SAMPL2
0016 0409 O DESC 21                            SAMPL2
0017 0410 O RECNBRZ 25                         SAMPL2
0018 0411 O T 3 01 LR                          SAMPL2
0019 0412 O COUNT Z 3                          SAMPL2
0020 0413 O 26 *RECORDS WERE READ FROM*       SAMPL2
0021 0414 O 44 *THE INDEXED FILE.*            SAMPL2

```



INDICATORS USED  
LR OF IP 01

FIELD NAMES USED				
STMT#	NAME	DEC	LGTH	DISP
0013	PAGE	0	004	011C
0004	KEY		006	0105
0005	DESC		013	0112
0006	RECNBR	0	003	0115
0007	COUNT	0	003	0118

START ADDR	NAME IF OVERLAY	CODE LENGTH	NAME	CORE USAGE OF RPGII CODE TITLE
1300		06AC	RGROOT	ROOT
1A04		00A0	RGMAIN	INPUT MAINLINE
1AA4		003A	RGSUBS	RECORD ID
1ADE		0026	RGSUBS	CONTROL FIELDS
19AC		0050	RGSUBS	INPUT CTRL RTN
19FC		0008	RGSUBS	SUBSEG
1B04		003B	\$\$\$ISIP	5444 IDX SEQ INPUT
1B3F		0079	\$\$\$SRBR	SYSTEM SUBR
1BB8		0038	\$\$\$SRDI	SYSTEM SUBR
1BFO		006D	\$\$\$SRIC	SYSTEM SUBR
1C5D		007B	\$\$\$SRRC	SYSTEM SUBR
1CD8		0029	\$\$\$SRRRI	SYSTEM SUBR
1D01		001C	\$\$\$SRTC	SYSTEM SUBR
1D1D		0081	\$\$\$SRMD	SYSTEM SUBR
1D9E		0043	\$\$\$SRSB	SYSTEM SUBR
1DE1		002F	\$\$\$SRBP	SYSTEM SUBR
1E10		002C	RGMAIN	INPUT FIELDS
1E3D		0010	RGMAIN	DETAIL CALCS
1E3C		0001	RGSUBS	CONSTANTS
1EFB		0032	RGMAIN	DETAIL OUTPUT
1EF6		0005	RGSUBS	CONSTANTS
1E4D		009D	RGSUBS	OUTPUT CTRL RTN
1EEA		000C	RGSUBS	SUBSEG
1F2D		00FB	\$\$\$LPRT	5203 PRINT
2028		000B	RGMAIN	TOTAL OUTPUT
206E		0024	RGMAIN	LR & OVERFLOW PROCESSING
2033		0017	RGSUBS	CONSTANTS
204A		0024	RGSUBS	OVERFLOW SUBSEGMENT
2092		008E	RGMAIN	OPEN
2120		0028	RGSUBS	SUBSEG
2174		0021	RGMAIN	CLOSE
2148		002C	RGSUBS	CONSTANTS
2195		0030	RGSUBS	LR PROCESSING

03781      SAMPL2      TOTAL CORE USAGE REQUIRED TO EXECUTE  
TOTAL NUMBER OF LIBRARY SECTORS REQUIRED      16

```
// CALL $RPSP3,F1
XX LOAD SAMPL1,R1
XX FILE NAME-$SOURCE,UNIT-R1,RETAIN-S,PACK-SYSTEM
XX FILE NAME-DISKOUT,UNIT-R1,RETAIN-T,PACK-SYSTEM,RECORDS-100
XX RUN
// RUN
```

SAMPLE PROGRAM 1 HAS LOADED 100 RECORDS INTO AN INDEXED FILE.

KEYS ARE IN ASCENDING SEQUENCE STARTING AT 000005 AND INCREASING IN INCREMENTS OF 5.

SAMPLE PROGRAM 2 WILL PRINT FROM THE INDEXED FILE TO SHOW THAT IT WAS PROPERLY LOADED.

```
// CALL $RPSP4,F1
XX LOAD SAMPL2,R1
XX FILE NAME-DISK IN,LABEL-DISKOUT,UNIT-R1,PACK-SYSTEM,RETAIN-S
XX RUN
// RUN
```

KEY	DESCRIPTION	PAGE	1
000005	RECORD NUMBER	1	
000010	RECORD NUMBER	2	
000015	RECORD NUMBER	3	
000020	RECORD NUMBER	4	
000025	RECORD NUMBER	5	
000030	RECORD NUMBER	6	
000035	RECORD NUMBER	7	
000040	RECORD NUMBER	8	
000045	RECORD NUMBER	9	
000050	RECORD NUMBER	10	
000055	RECORD NUMBER	11	
000060	RECORD NUMBER	12	
000065	RECORD NUMBER	13	
000070	RECORD NUMBER	14	
000075	RECORD NUMBER	15	
000080	RECORD NUMBER	16	
000085	RECORD NUMBER	17	
000090	RECORD NUMBER	18	
000095	RECORD NUMBER	19	
000100	RECORD NUMBER	20	
000105	RECORD NUMBER	21	
000110	RECORD NUMBER	22	
000115	RECORD NUMBER	23	
000120	RECORD NUMBER	24	
000125	RECORD NUMBER	25	
000130	RECORD NUMBER	26	
000135	RECORD NUMBER	27	
000140	RECORD NUMBER	28	
000145	RECORD NUMBER	29	
000150	RECORD NUMBER	30	
000155	RECORD NUMBER	31	
000160	RECORD NUMBER	32	
000165	RECORD NUMBER	33	
000170	RECORD NUMBER	34	
000175	RECORD NUMBER	35	
000180	RECORD NUMBER	36	
000185	RECORD NUMBER	37	
000190	RECORD NUMBER	38	
000195	RECORD NUMBER	39	
000200	RECORD NUMBER	40	
000205	RECORD NUMBER	41	
000210	RECORD NUMBER	42	
000215	RECORD NUMBER	43	
000220	RECORD NUMBER	44	
000225	RECORD NUMBER	45	
000230	RECORD NUMBER	46	
000235	RECORD NUMBER	47	
000240	RECORD NUMBER	48	
000245	RECORD NUMBER	49	
000250	RECORD NUMBER	50	
000255	RECORD NUMBER	51	
000260	RECORD NUMBER	52	
000265	RECORD NUMBER	53	
000270	RECORD NUMBER	54	
000275	RECORD NUMBER	55	

KEY	DESCRIPTION	PAGE	2
000280	RECORD NUMBER	56	
000285	RECORD NUMBER	57	
000290	RECORD NUMBER	58	
000295	RECORD NUMBER	59	
000300	RECORD NUMBER	60	
000305	RECORD NUMBER	61	
000310	RECORD NUMBER	62	
000315	RECORD NUMBER	63	
000320	RECORD NUMBER	64	
000325	RECORD NUMBER	65	
000330	RECORD NUMBER	66	
000335	RECORD NUMBER	67	
000340	RECORD NUMBER	68	
000345	RECORD NUMBER	69	
000350	RECORD NUMBER	70	
000355	RECORD NUMBER	71	
000360	RECORD NUMBER	72	
000365	RECORD NUMBER	73	
000370	RECORD NUMBER	74	
000375	RECORD NUMBER	75	
000380	RECORD NUMBER	76	
000385	RECORD NUMBER	77	
000390	RECORD NUMBER	78	
000395	RECORD NUMBER	79	
000400	RECORD NUMBER	80	
000405	RECORD NUMBER	81	
000410	RECORD NUMBER	82	
000415	RECORD NUMBER	83	
000420	RECORD NUMBER	84	
000425	RECORD NUMBER	85	
000430	RECORD NUMBER	86	
000435	RECORD NUMBER	87	
000440	RECORD NUMBER	88	
000445	RECORD NUMBER	89	
000450	RECORD NUMBER	90	
000455	RECORD NUMBER	91	
000460	RECORD NUMBER	92	
000465	RECORD NUMBER	93	
000470	RECORD NUMBER	94	
000475	RECORD NUMBER	95	
000480	RECORD NUMBER	96	
000485	RECORD NUMBER	97	
000490	RECORD NUMBER	98	
000495	RECORD NUMBER	99	
000500	RECORD NUMBER	100	

100 RECORDS WERE READ FROM THE INDEXED FILE.

To determine a malfunctioning device or program, and who should correct it, you can follow a prescribed procedure called *problem determination*. Problem determination does not give you the precise cause of a malfunction nor correct it, but it can reduce the amount of system down time if performed prior to calling IBM.

### PERFORMING PROBLEM DETERMINATION

The following pages tell you how to do problem determination. The meanings of indicators that show various types of failures are included. Also, when possible, you are told whether the failure is the result of a machine or user error.

#### Halts

Halts displayed on the message display unit indicate incorrect program operation, machine errors, or in some cases, information or instructions. If the log option is used, error codes are printed on the logging device. Whenever a programmed halt occurs, take the appropriate action indicated in the *IBM System/3 Model 10 Disk System Halt Guide*, GC21-7540.

#### Processor Checks

The PROCESSOR CHECK light on the display panel indicates that an abnormal condition has occurred in the processing unit and the system is stopped. Processor checks commonly caused by programming malfunctions are: invalid address, invalid op code, and invalid Q byte. All other processor checks indicate hardware malfunctions. If a combination of lights is on, such as invalid op code and invalid Q byte, you should suspect a hardware malfunction. The system stops with the PROCESSOR CHECK light on and the type of check is indicated in position 8 (PROC CHK) on the register display unit.

If a hardware malfunction is not indicated, the program must be examined closely to determine the cause of the processor check. If the system stops with a processor check, certain information needed for problem determination is retained in the system: type of check, contents of the local storage registers (LSRs), and contents of main storage. See Figures 57 and 58 for the procedures you can follow to obtain this information.

#### System Loops

A loop in a system is the repetitive execution of a sequence of instructions. A loop can be recognized in several ways.

- A steady flow in the lights of the processing unit display panel when the STOP light is off.
- A rhythmic pattern in the lights of the processing unit display panel.
- A pointless recurrence of input/output activity.
- A job that does not change status for a long period of time.

Loops can be caused by:

- Deliberate coding by a programmer as a debugging aid.
- A logic or coding error by a programmer.
- An incorrect setup by the operator.
- A hardware malfunction.

When a loop occurs, it continues until the operator intervenes and cancels the job. (See Figure 59 for operator-programmer action for a loop.) The operator's main responsibility when a loop occurs is to gather pertinent information as follows:

1. Determine whether the job is set up correctly. If it is not, correct it and rerun the job. If the job is set up correctly, follow the procedures in Figure 60.
2. If the loop is a long one, try to get random addresses in the loop. Set the CE mode selector to PROCESS, press START and STOP, and record the address. By repeating this procedure, you can obtain a random list of addresses in the loop.
3. Have the loop addresses, program listing, and storage dump available for the programmer.

It is the programmer's responsibility to determine the cause of a program loop. He should thoroughly examine the logic of his program to make sure he did not code a loop. If his program appears to be coded correctly, he should have the information supplied by the operator available and contact IBM for assistance.

#### **Incorrect Output**

If output is incorrect after a job has apparently been completed successfully, the incorrect output falls into the following categories:

- Missing records.
- Duplicate records.
- Invalid data containing sequence errors, incorrect values, format errors, or meaningless information.

To perform problem determination for errors of this type:

1. Isolate the failing program.
2. Check for a possible hardware error (do other programs fail in the same way?).
3. Perform the appropriate data collection procedure in Figure 60.

If several programs are involved in a failure, locate the program that you know has correct input, but incorrect output. The fastest method of analyzing a series of programs is to check the output of one of the programs in the middle of the job stream, then repeat the check for the remaining programs until one has been isolated. After that, use Figure 60 to complete problem determination.

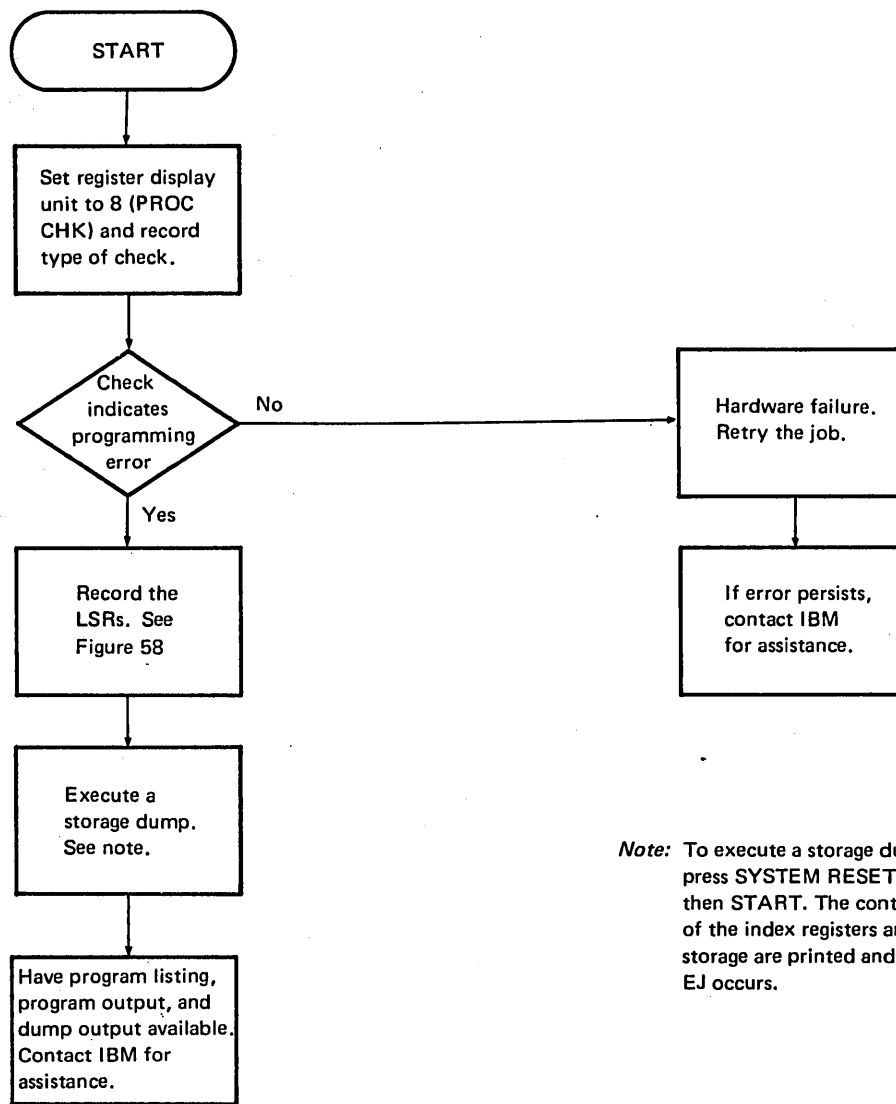

*Note:* To execute a storage dump, press SYSTEM RESET and then START. The contents of the index registers and storage are printed and halt EJ occurs.

Figure 57. Operator Procedures for Processor Check

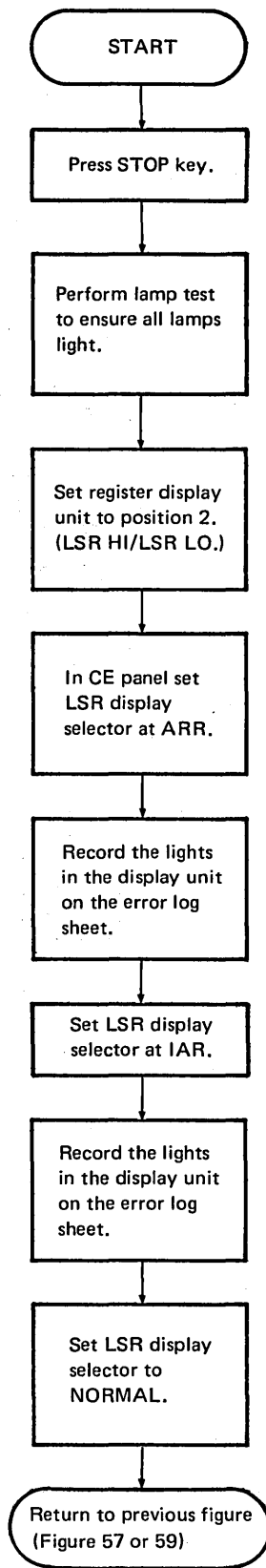
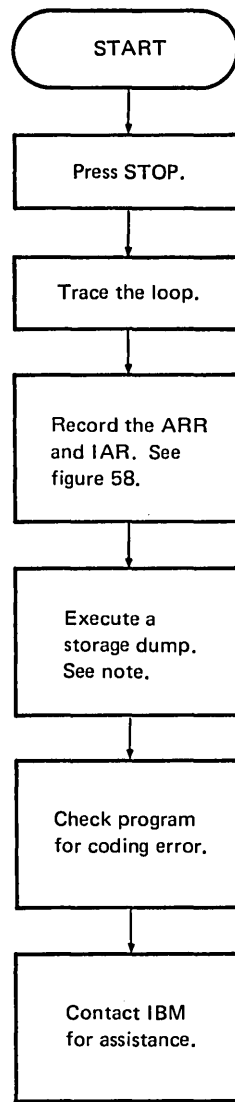

Figure 58. Operator Procedures for Displaying Local Storage Registers





*Note:* To execute a storage dump, press SYSTEM RESET and then START. The contents of the index registers and storage are printed and halt EJ occurs.

Figure 59. Operator and Programmer Action for a System Loop

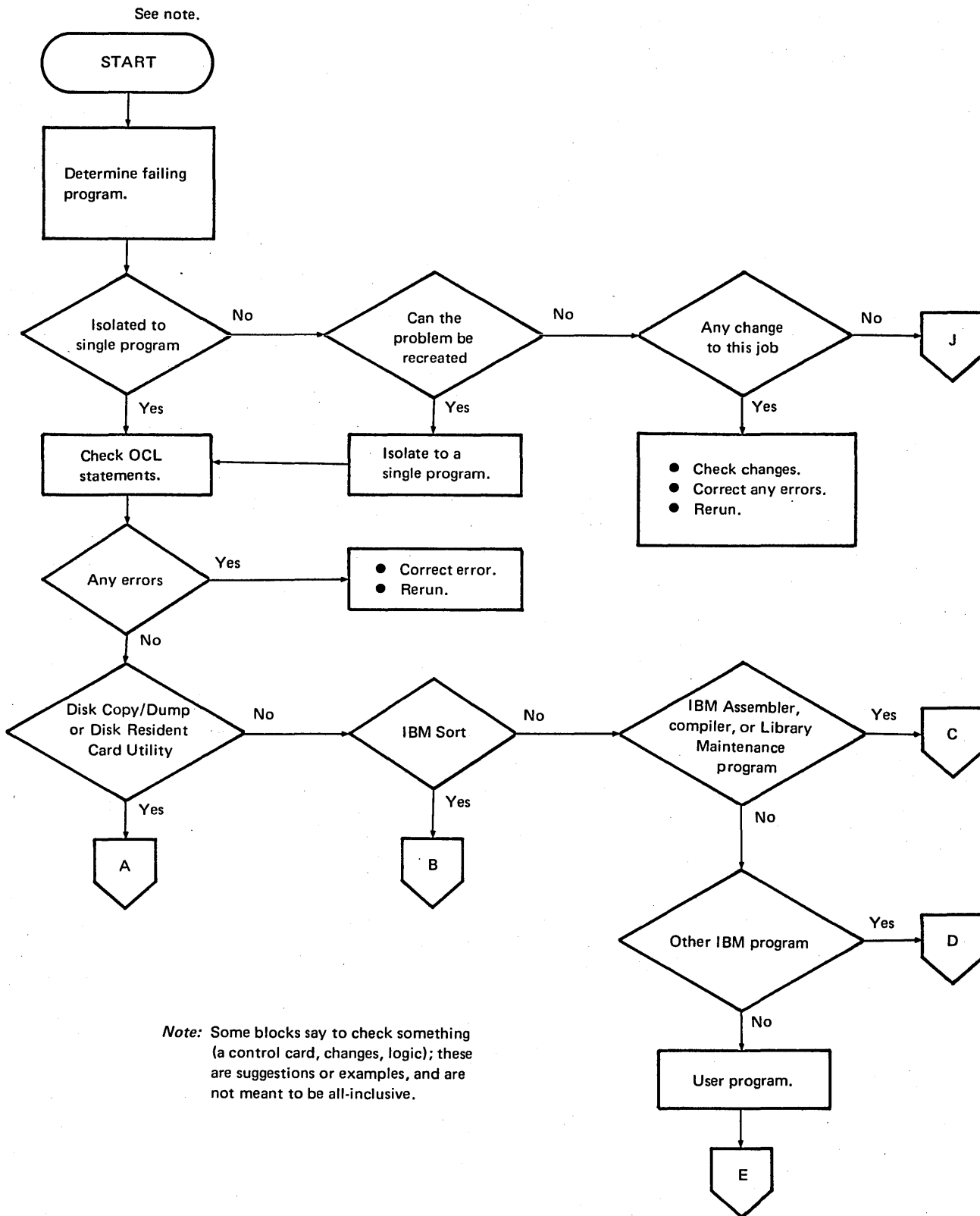

Figure 60 (Part 1 of 7). Operating Procedures for Incorrect Output

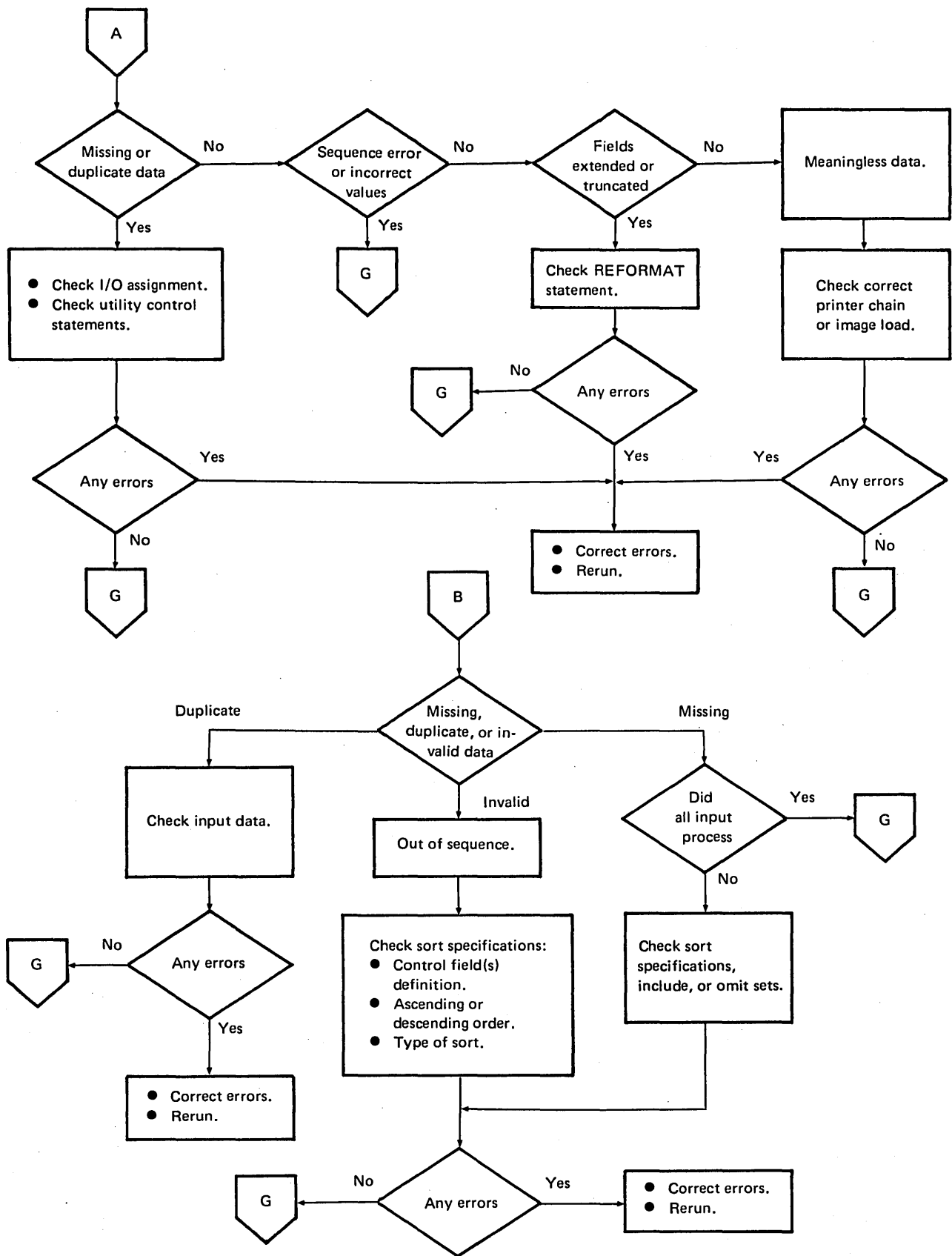

Figure 60 (Part 2 of 7). Operating Procedures for Incorrect Output

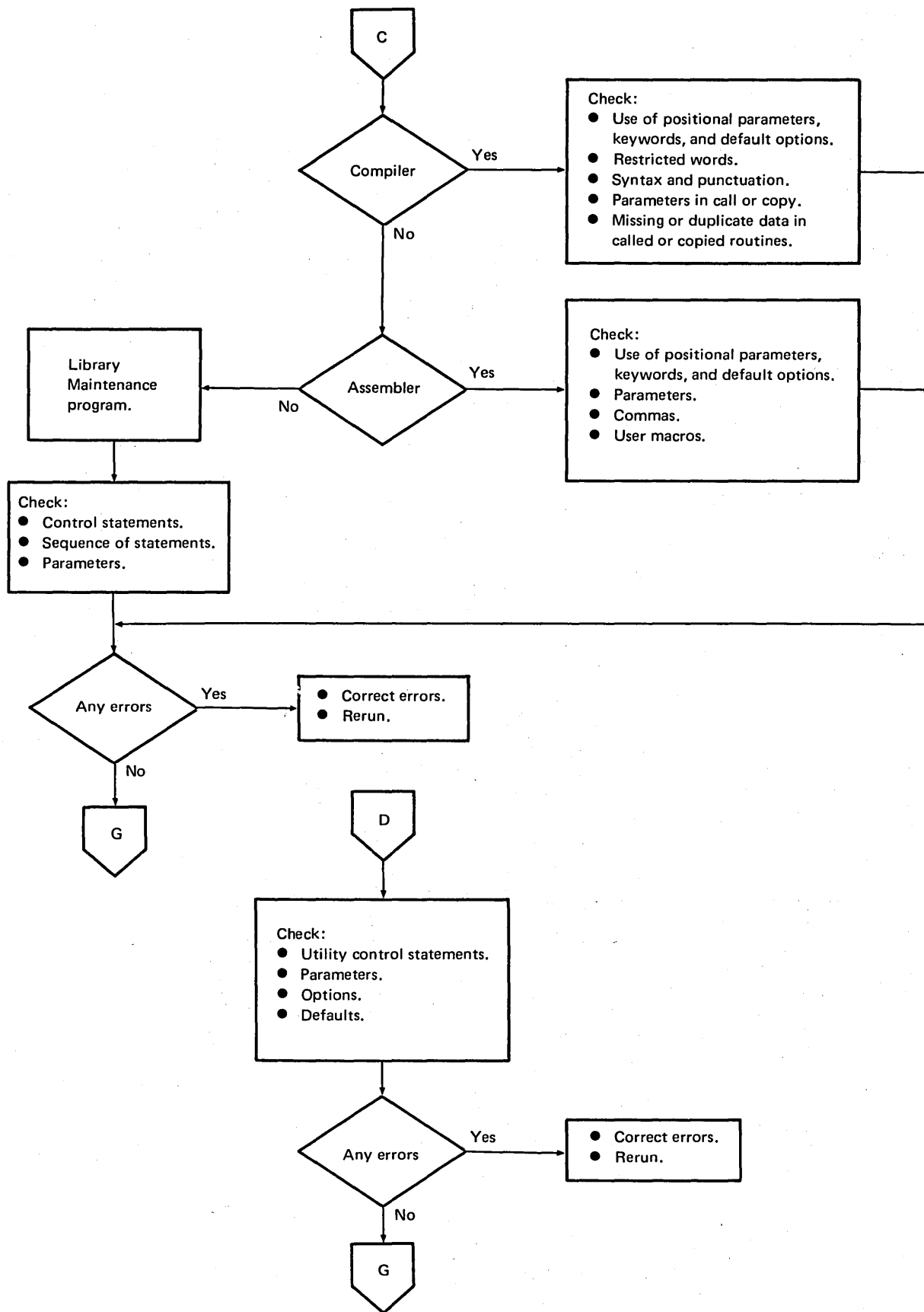

Figure 60 (Part 3 of 7). Operating Procedures for Incorrect Ouptu'

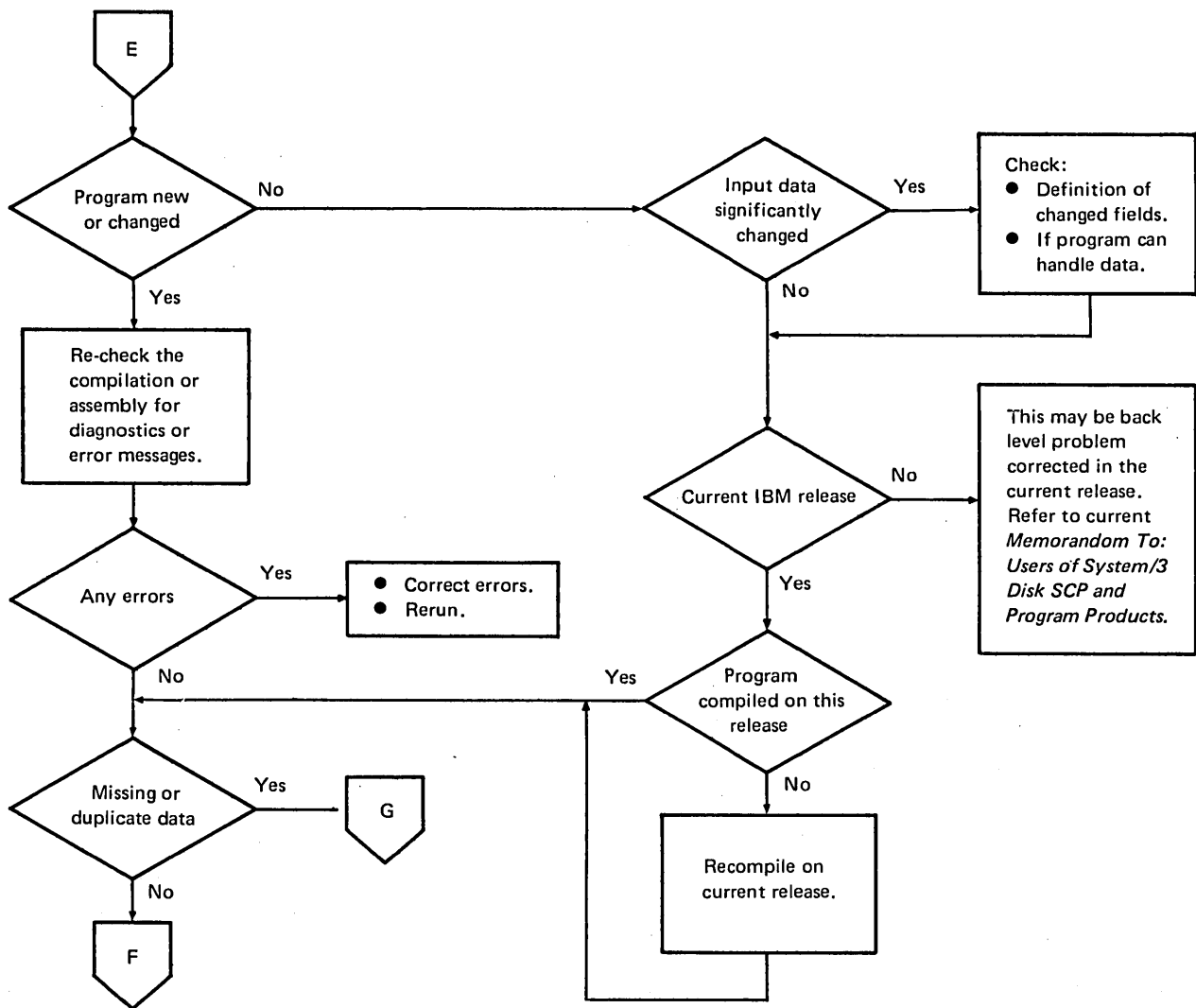

Figure 60 (Part 4 of 7). Operating Procedures for Incorrect Output

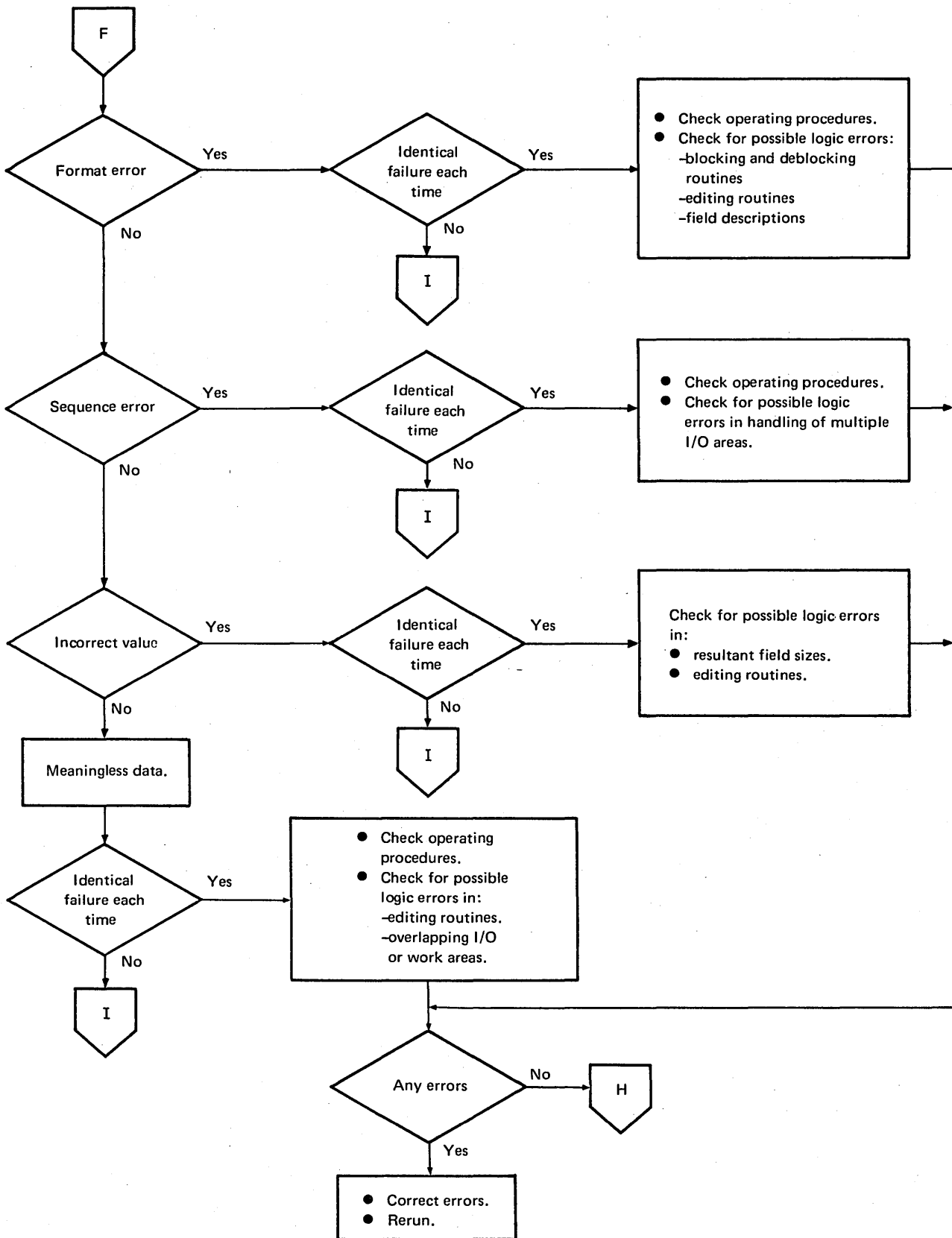

Figure 60 (Part 5 of 7). Operating Procedures for Incorrect Output

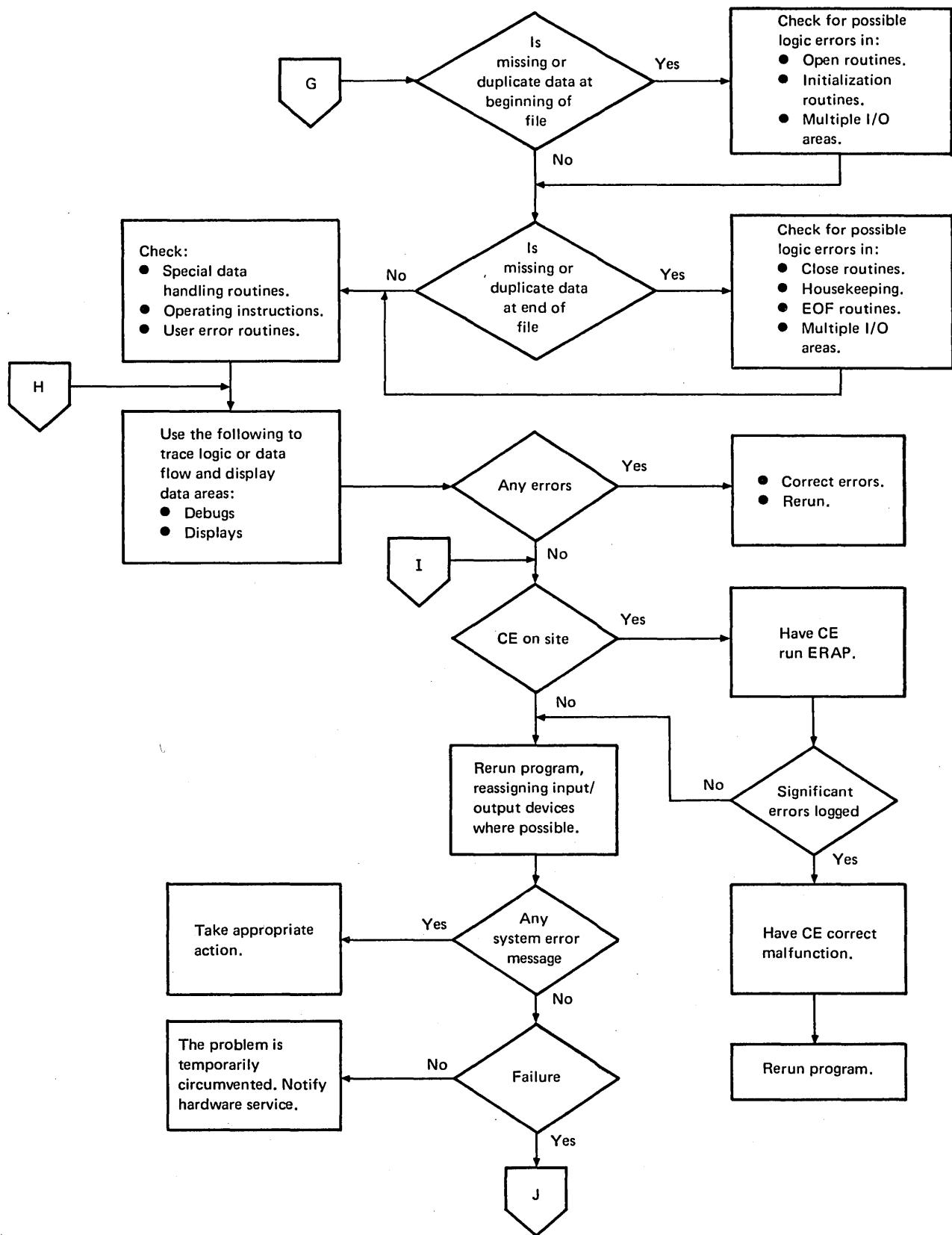

Figure 60 (Part 6 of 7). Operating Procedures for Incorrect Output

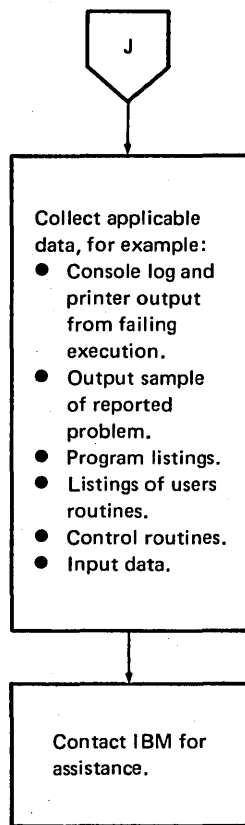

Figure 60 (Part 7 of 7). Operating Procedures for Incorrect Output



This appendix contains storage estimates for IBM System/3 Model 10 Disk System control programs (SCP), SCP features, program products, and program product features. These estimates will aid you during pre-installation planning in determining system configuration requirements and in planning for efficient use of main storage and secondary storage.

The following estimates are included:

- Main storage requirements of the supervisor and data management routines for all system configurations.
- Secondary (disk) storage requirements for individual SCP components and features, program products and features, and IBM reserved areas.

### MAIN STORAGE ESTIMATES

The following tables are intended to assist you in estimating the main storage requirements of the Model 10 Disk System Supervisor and of the various data management modules. With this knowledge, you can estimate the amount of main storage available to your other system programs, application programs, and program products.

#### Supervisor Size Estimates

The size of the supervisor generated for your system depends on the options you select during system generation for the following configuration statements:

\$DDPF	DPF-NO
\$DISK	DISKS-'R1,F1'
\$DDSK	D5445-NO
\$DTUN	TAPES-NO
\$DKBD	KEYBD-NO
\$DBSC	LINE-NO

Use the preceding options to build the minimum supervisor. These options give you a dedicated supervisor, input/output support for disk drive 1, and no program support for a keyboard device. When you select an alternate for any of these options, you may increase the size of the supervisor. The size of the supervisor generated will be printed for you during system generation.

You may build a minimum supervisor even if your System/3 has DPF, both 5444 disk drives, 5445 disk support, magnetic tape, and a 5471 console keyboard device. If you have an application which will not fit into main storage with a large supervisor, you might want to generate an additional supervisor especially for this application. For the configuration statements mentioned earlier, select only those options required by the application. This would give you the smallest supervisor capable of supporting this application. However, do not select options to support devices that you do not have.

Figure 61 can be used to determine the main storage requirements of the System/3 Model 10 Disk System Supervisor for all system configurations. For example, if you want a system that includes disk units F1, R1, F2, R2, and D1, locate that line on the chart in Figure 61. If your system also will include four tape units, the value you should obtain from the chart is 2031. If you have a DPF system with a printer/keyboard but no BSCA feature, add the base value of the supervisor, the chart value for disk and tape units, the value for DPF, and the value for printer/keyboard to obtain the total size of the supervisor.

1921	(base supervisor)
+2031	(disk and tape units)
849	(DPF)
<u>235</u>	(printer/keyboard)
5036	bytes for the supervisor

Disk Units		Number of Magnetic Tape Units				
5444	5445	0	1	2	3	4
F1,R1	—	736	1264	1311	1351	1382
F1,R1,F2,R2	—	956	1358	1405	1445	1476
F1,R1	D1	1400	1819	1866	1906	1937
F1,R1,F2,R2	D1	1494	1913	1960	2000	2031
F1,R1	D1,D2	1548	1967	2014	2054	2085
F1,R1,F2,R2	D1,D2	1642	2061	2108	2148	2179

*Note:* For a configuration with F1,R1, and R2, use the line above which shows F1,R1,F2, and R2.

Calculate the main storage requirement of the supervisor as follows:

- To the base size of the supervisor (always included):----- 1921 bytes
- Add the value from the table above which corresponds to the number of disk and tape units in your configuration:----- (value from table)
- If you have DPF, add:----- +849 bytes
- If you have BSCA with line 1 and line 2 or ML/MP, add:----- +139 bytes
- If you have the 5471 printer/keyboard, add:----- +235 bytes

Total size of supervisor = (total of values for  
 (round up to the next multiple of 256 bytes) your configuration)

Figure 61. Determining the Main Storage Requirements of the Supervisor

Since 5036 is not a multiple of 256, it must be rounded up to the next multiple of 256, or 5120.

### Data Management Estimates

*Data management* includes the SCP modules which allow a program that is processing a data file to organize, locate, write, read, and maintain the records in the file. The data management modules discussed in this section are relocatable object modules (R modules in the object library). The modules required by a particular program are selected by the compiler and are linkage edited with the user program after compilation to form a complete object program.

The main storage requirement of the data management for a particular program can be estimated using the examples and tables in this section. The storage requirement can vary greatly depending on the types of devices and files being used by the program. The data management storage estimates do not include the storage required for input/output areas, buffers, DTFs (define the file areas), or IOBs (input/output blocks).

*Calculating the Main Storage Requirement for Disk or Tape Data Management*

Figures 62-65 show the estimated main storage requirements of the data management modules for the 5444 disk drive, 5445 disk drive, 5444 with shared I/O, and the 3410/3411 magnetic tape units. Main routine bytes and total bytes for each access method are given, along with the module name. The data management subroutines are listed to the right of the module names along with their size in bytes.

The number of bytes of main storage required for disk data management depends on the type of files you are processing and how you are processing them. For example, if your program processes two sequential 5444 disk files (single volume), one as a consecutive input file and the other as a consecutive output file, you require the following access methods:

Consecutive Input – \$\$CSIP  
Consecutive Output – \$\$CSOP

Figure 62. Estimated Main Storage Requirements of 5444 Disk Data Management Modules

5444 Access Methods (MVF=Multivolume File)	Main Routine (Bytes)	Complete Access Method (Bytes)	Module Name (\$\$----)	Subroutines - Name (\$\$----) and Size in Bytes																																																																																																																																																																																																																																																																																																																																																																																																																																																																																																																																																																																																																																																																																																																																																																																																																																																																																																																																																																																																																																																																																																																					
				SRB1 (152)	SRBP (67)	SRBR (121)	SRCS (78)	SRCL (91)	SRCM (183)	SRDA (153)	SRDF (28)	SRDI (58)	SRIC (109)	SRLP (70)	SRML (40)	SRMO (51)	SRRC (129)	SRRI (41)	SRSB (67)	SRSC (174)	SRSI (97)	SRSM (95)	SRSO (100)	SRTC (28)	SRTS (248)	SRUA (38)																																																																																																																																																																																																																																																																																																																																																																																																																																																																																																																																																																																																																																																																																																																																																																																																																																																																																																																																																																																																																																																																																															
<b>Consecutive</b>																											Output	29	543	CSOP		X	X				X	X			X			X						X		X	Output - MVF	43	597	CSOM		X	X				X	X		X	X		X						X		X	Input	39	525	CSIP		X	X				X			X		X		X					X		X	Input - MVF	50	576	CSIM		X	X				X		X	X		X		X					X		X	Update	137	435	CSUP		X					X			X		X							X		X	Update - MVF	149	487	CSUM		X					X		X	X		X							X		X	<b>Direct</b>																										*Binary Input	64	465	DAIB						X	X				X	X							X			*Binary Input - MVF	171	572	DAIT						X	X				X	X							X			Decimal Input	91	568	DAID			X		X	X					X	X							X			Decimal Input - MVF	196	673	DAIM			X		X	X					X	X							X			*Binary Update	104	634	DAUB					X	X				X	X	X							X			*Binary Update - MVF	211	741	DAUT					X	X				X	X	X							X			Decimal Update	131	737	DAUD			X		X	X				X	X	X							X			Decimal Update - MVF	236	842	DAUM			X		X	X				X	X	X							X			<b>Indexed</b>																										Output	89	755	IOUT	X	X	X				X	X			X			X					X		X	Output - MVF	134	840	IOUM	X	X	X				X	X		X	X		X						X		X	Output Add	119	1251	IOAD	X	X	X				X	X			X		X	X	X	X	X	X	X	X	X	Output Add - MVF	240	1413	IOAM	X	X					X	X		X	X		X	X	X	X	X	X	X	X	X	<b>Indexed Random</b>																										Input	69	683	IRIP							X					X	X	X	X	X	X		X			Input - MVF	106	1008	IRIM							X		X		X	X	X	X	X	X	X	X	X	X	X	Update	106	919	IRUP							X	X			X	X	X	X	X	X	X		X			Update - MVF	143	1244	IRUM							X	X	X		X	X	X	X	X	X	X		X	X		Input Add	286	1394	IRAD	X	X					X	X			X	X	X	X	X	X	X	X	X		X	Input Add - MVF	330	1726	IRAM	X	X					X	X		X	X	X	X	X	X	X	X	X	X	X	X	Update Add	319	1497	IRUA	X	X					X	X	X		X	X	X	X	X	X	X	X	X		X	Update Add - MVF	362	1828	IRBM	X	X					X	X	X	X	X	X	X	X	X	X	X	X	X	X	X	<b>Indexed Sequential</b>																										Input	59	780	ISIP		X	X				X	X			X	X	X	X					X			Input - MVF	72	833	ISIM		X	X				X	X	X		X	X	X	X					X			Input - Limits	80	841	ISIL		X	X				X	X	X		X	X	X	X					X			Update	125	728	ISUP		X					X	X	X		X	X	X						X			Update - MVF	140	783	ISUM		X					X	X	X	X	X	X	X						X			Update - Limits	136	779	ISUL		X					X	X	X	X	X	X							X			Input Add	321	1214	ISAD	X	X		X			X	X	X		X	X	X	X					X		X	Input Add - MVF	338	1333	ISAM	X	X		X			X	X	X	X	X	X	X	X					X		X	Update Add	395	1358	ISUA	X	X		X			X	X	X	X	X	X	X						X		X	Update Add - MVF	415	1480	ISBM	X	X		X			X	X	X	X	X	X	X	X					X		X	Input - Variable Limits	105	866	ISIC		X	X				X	X	X	X	X	X	X	X					X			Update - Variable Limits	161	804	ISUC		X					X	X	X	X	X	X							X		
Output	29	543	CSOP		X	X				X	X			X			X						X		X	Output - MVF	43	597	CSOM		X	X				X	X		X	X		X						X		X	Input	39	525	CSIP		X	X				X			X		X		X					X		X	Input - MVF	50	576	CSIM		X	X				X		X	X		X		X					X		X	Update	137	435	CSUP		X					X			X		X							X		X	Update - MVF	149	487	CSUM		X					X		X	X		X							X		X	<b>Direct</b>																										*Binary Input	64	465	DAIB						X	X				X	X							X			*Binary Input - MVF	171	572	DAIT						X	X				X	X							X			Decimal Input	91	568	DAID			X		X	X					X	X							X			Decimal Input - MVF	196	673	DAIM			X		X	X					X	X							X			*Binary Update	104	634	DAUB					X	X				X	X	X							X			*Binary Update - MVF	211	741	DAUT					X	X				X	X	X							X			Decimal Update	131	737	DAUD			X		X	X				X	X	X							X			Decimal Update - MVF	236	842	DAUM			X		X	X				X	X	X							X			<b>Indexed</b>																										Output	89	755	IOUT	X	X	X				X	X			X			X					X		X	Output - MVF	134	840	IOUM	X	X	X				X	X		X	X		X						X		X	Output Add	119	1251	IOAD	X	X	X				X	X			X		X	X	X	X	X	X	X	X	X	Output Add - MVF	240	1413	IOAM	X	X					X	X		X	X		X	X	X	X	X	X	X	X	X	<b>Indexed Random</b>																										Input	69	683	IRIP							X					X	X	X	X	X	X		X			Input - MVF	106	1008	IRIM							X		X		X	X	X	X	X	X	X	X	X	X	X	Update	106	919	IRUP							X	X			X	X	X	X	X	X	X		X			Update - MVF	143	1244	IRUM							X	X	X		X	X	X	X	X	X	X		X	X		Input Add	286	1394	IRAD	X	X					X	X			X	X	X	X	X	X	X	X	X		X	Input Add - MVF	330	1726	IRAM	X	X					X	X		X	X	X	X	X	X	X	X	X	X	X	X	Update Add	319	1497	IRUA	X	X					X	X	X		X	X	X	X	X	X	X	X	X		X	Update Add - MVF	362	1828	IRBM	X	X					X	X	X	X	X	X	X	X	X	X	X	X	X	X	X	<b>Indexed Sequential</b>																										Input	59	780	ISIP		X	X				X	X			X	X	X	X					X			Input - MVF	72	833	ISIM		X	X				X	X	X		X	X	X	X					X			Input - Limits	80	841	ISIL		X	X				X	X	X		X	X	X	X					X			Update	125	728	ISUP		X					X	X	X		X	X	X						X			Update - MVF	140	783	ISUM		X					X	X	X	X	X	X	X						X			Update - Limits	136	779	ISUL		X					X	X	X	X	X	X							X			Input Add	321	1214	ISAD	X	X		X			X	X	X		X	X	X	X					X		X	Input Add - MVF	338	1333	ISAM	X	X		X			X	X	X	X	X	X	X	X					X		X	Update Add	395	1358	ISUA	X	X		X			X	X	X	X	X	X	X						X		X	Update Add - MVF	415	1480	ISBM	X	X		X			X	X	X	X	X	X	X	X					X		X	Input - Variable Limits	105	866	ISIC		X	X				X	X	X	X	X	X	X	X					X			Update - Variable Limits	161	804	ISUC		X					X	X	X	X	X	X							X																													
Output - MVF	43	597	CSOM		X	X				X	X		X	X		X						X		X	Input	39	525	CSIP		X	X				X			X		X		X					X		X	Input - MVF	50	576	CSIM		X	X				X		X	X		X		X					X		X	Update	137	435	CSUP		X					X			X		X							X		X	Update - MVF	149	487	CSUM		X					X		X	X		X							X		X	<b>Direct</b>																										*Binary Input	64	465	DAIB						X	X				X	X							X			*Binary Input - MVF	171	572	DAIT						X	X				X	X							X			Decimal Input	91	568	DAID			X		X	X					X	X							X			Decimal Input - MVF	196	673	DAIM			X		X	X					X	X							X			*Binary Update	104	634	DAUB					X	X				X	X	X							X			*Binary Update - MVF	211	741	DAUT					X	X				X	X	X							X			Decimal Update	131	737	DAUD			X		X	X				X	X	X							X			Decimal Update - MVF	236	842	DAUM			X		X	X				X	X	X							X			<b>Indexed</b>																										Output	89	755	IOUT	X	X	X				X	X			X			X					X		X	Output - MVF	134	840	IOUM	X	X	X				X	X		X	X		X						X		X	Output Add	119	1251	IOAD	X	X	X				X	X			X		X	X	X	X	X	X	X	X	X	Output Add - MVF	240	1413	IOAM	X	X					X	X		X	X		X	X	X	X	X	X	X	X	X	<b>Indexed Random</b>																										Input	69	683	IRIP							X					X	X	X	X	X	X		X			Input - MVF	106	1008	IRIM							X		X		X	X	X	X	X	X	X	X	X	X	X	Update	106	919	IRUP							X	X			X	X	X	X	X	X	X		X			Update - MVF	143	1244	IRUM							X	X	X		X	X	X	X	X	X	X		X	X		Input Add	286	1394	IRAD	X	X					X	X			X	X	X	X	X	X	X	X	X		X	Input Add - MVF	330	1726	IRAM	X	X					X	X		X	X	X	X	X	X	X	X	X	X	X	X	Update Add	319	1497	IRUA	X	X					X	X	X		X	X	X	X	X	X	X	X	X		X	Update Add - MVF	362	1828	IRBM	X	X					X	X	X	X	X	X	X	X	X	X	X	X	X	X	X	<b>Indexed Sequential</b>																										Input	59	780	ISIP		X	X				X	X			X	X	X	X					X			Input - MVF	72	833	ISIM		X	X				X	X	X		X	X	X	X					X			Input - Limits	80	841	ISIL		X	X				X	X	X		X	X	X	X					X			Update	125	728	ISUP		X					X	X	X		X	X	X						X			Update - MVF	140	783	ISUM		X					X	X	X	X	X	X	X						X			Update - Limits	136	779	ISUL		X					X	X	X	X	X	X							X			Input Add	321	1214	ISAD	X	X		X			X	X	X		X	X	X	X					X		X	Input Add - MVF	338	1333	ISAM	X	X		X			X	X	X	X	X	X	X	X					X		X	Update Add	395	1358	ISUA	X	X		X			X	X	X	X	X	X	X						X		X	Update Add - MVF	415	1480	ISBM	X	X		X			X	X	X	X	X	X	X	X					X		X	Input - Variable Limits	105	866	ISIC		X	X				X	X	X	X	X	X	X	X					X			Update - Variable Limits	161	804	ISUC		X					X	X	X	X	X	X							X																																																							
Input	39	525	CSIP		X	X				X			X		X		X					X		X	Input - MVF	50	576	CSIM		X	X				X		X	X		X		X					X		X	Update	137	435	CSUP		X					X			X		X							X		X	Update - MVF	149	487	CSUM		X					X		X	X		X							X		X	<b>Direct</b>																										*Binary Input	64	465	DAIB						X	X				X	X							X			*Binary Input - MVF	171	572	DAIT						X	X				X	X							X			Decimal Input	91	568	DAID			X		X	X					X	X							X			Decimal Input - MVF	196	673	DAIM			X		X	X					X	X							X			*Binary Update	104	634	DAUB					X	X				X	X	X							X			*Binary Update - MVF	211	741	DAUT					X	X				X	X	X							X			Decimal Update	131	737	DAUD			X		X	X				X	X	X							X			Decimal Update - MVF	236	842	DAUM			X		X	X				X	X	X							X			<b>Indexed</b>																										Output	89	755	IOUT	X	X	X				X	X			X			X					X		X	Output - MVF	134	840	IOUM	X	X	X				X	X		X	X		X						X		X	Output Add	119	1251	IOAD	X	X	X				X	X			X		X	X	X	X	X	X	X	X	X	Output Add - MVF	240	1413	IOAM	X	X					X	X		X	X		X	X	X	X	X	X	X	X	X	<b>Indexed Random</b>																										Input	69	683	IRIP							X					X	X	X	X	X	X		X			Input - MVF	106	1008	IRIM							X		X		X	X	X	X	X	X	X	X	X	X	X	Update	106	919	IRUP							X	X			X	X	X	X	X	X	X		X			Update - MVF	143	1244	IRUM							X	X	X		X	X	X	X	X	X	X		X	X		Input Add	286	1394	IRAD	X	X					X	X			X	X	X	X	X	X	X	X	X		X	Input Add - MVF	330	1726	IRAM	X	X					X	X		X	X	X	X	X	X	X	X	X	X	X	X	Update Add	319	1497	IRUA	X	X					X	X	X		X	X	X	X	X	X	X	X	X		X	Update Add - MVF	362	1828	IRBM	X	X					X	X	X	X	X	X	X	X	X	X	X	X	X	X	X	<b>Indexed Sequential</b>																										Input	59	780	ISIP		X	X				X	X			X	X	X	X					X			Input - MVF	72	833	ISIM		X	X				X	X	X		X	X	X	X					X			Input - Limits	80	841	ISIL		X	X				X	X	X		X	X	X	X					X			Update	125	728	ISUP		X					X	X	X		X	X	X						X			Update - MVF	140	783	ISUM		X					X	X	X	X	X	X	X						X			Update - Limits	136	779	ISUL		X					X	X	X	X	X	X							X			Input Add	321	1214	ISAD	X	X		X			X	X	X		X	X	X	X					X		X	Input Add - MVF	338	1333	ISAM	X	X		X			X	X	X	X	X	X	X	X					X		X	Update Add	395	1358	ISUA	X	X		X			X	X	X	X	X	X	X						X		X	Update Add - MVF	415	1480	ISBM	X	X		X			X	X	X	X	X	X	X	X					X		X	Input - Variable Limits	105	866	ISIC		X	X				X	X	X	X	X	X	X	X					X			Update - Variable Limits	161	804	ISUC		X					X	X	X	X	X	X							X																																																																																
Input - MVF	50	576	CSIM		X	X				X		X	X		X		X					X		X	Update	137	435	CSUP		X					X			X		X							X		X	Update - MVF	149	487	CSUM		X					X		X	X		X							X		X	<b>Direct</b>																										*Binary Input	64	465	DAIB						X	X				X	X							X			*Binary Input - MVF	171	572	DAIT						X	X				X	X							X			Decimal Input	91	568	DAID			X		X	X					X	X							X			Decimal Input - MVF	196	673	DAIM			X		X	X					X	X							X			*Binary Update	104	634	DAUB					X	X				X	X	X							X			*Binary Update - MVF	211	741	DAUT					X	X				X	X	X							X			Decimal Update	131	737	DAUD			X		X	X				X	X	X							X			Decimal Update - MVF	236	842	DAUM			X		X	X				X	X	X							X			<b>Indexed</b>																										Output	89	755	IOUT	X	X	X				X	X			X			X					X		X	Output - MVF	134	840	IOUM	X	X	X				X	X		X	X		X						X		X	Output Add	119	1251	IOAD	X	X	X				X	X			X		X	X	X	X	X	X	X	X	X	Output Add - MVF	240	1413	IOAM	X	X					X	X		X	X		X	X	X	X	X	X	X	X	X	<b>Indexed Random</b>																										Input	69	683	IRIP							X					X	X	X	X	X	X		X			Input - MVF	106	1008	IRIM							X		X		X	X	X	X	X	X	X	X	X	X	X	Update	106	919	IRUP							X	X			X	X	X	X	X	X	X		X			Update - MVF	143	1244	IRUM							X	X	X		X	X	X	X	X	X	X		X	X		Input Add	286	1394	IRAD	X	X					X	X			X	X	X	X	X	X	X	X	X		X	Input Add - MVF	330	1726	IRAM	X	X					X	X		X	X	X	X	X	X	X	X	X	X	X	X	Update Add	319	1497	IRUA	X	X					X	X	X		X	X	X	X	X	X	X	X	X		X	Update Add - MVF	362	1828	IRBM	X	X					X	X	X	X	X	X	X	X	X	X	X	X	X	X	X	<b>Indexed Sequential</b>																										Input	59	780	ISIP		X	X				X	X			X	X	X	X					X			Input - MVF	72	833	ISIM		X	X				X	X	X		X	X	X	X					X			Input - Limits	80	841	ISIL		X	X				X	X	X		X	X	X	X					X			Update	125	728	ISUP		X					X	X	X		X	X	X						X			Update - MVF	140	783	ISUM		X					X	X	X	X	X	X	X						X			Update - Limits	136	779	ISUL		X					X	X	X	X	X	X							X			Input Add	321	1214	ISAD	X	X		X			X	X	X		X	X	X	X					X		X	Input Add - MVF	338	1333	ISAM	X	X		X			X	X	X	X	X	X	X	X					X		X	Update Add	395	1358	ISUA	X	X		X			X	X	X	X	X	X	X						X		X	Update Add - MVF	415	1480	ISBM	X	X		X			X	X	X	X	X	X	X	X					X		X	Input - Variable Limits	105	866	ISIC		X	X				X	X	X	X	X	X	X	X					X			Update - Variable Limits	161	804	ISUC		X					X	X	X	X	X	X							X																																																																																																									
Update	137	435	CSUP		X					X			X		X							X		X	Update - MVF	149	487	CSUM		X					X		X	X		X							X		X	<b>Direct</b>																										*Binary Input	64	465	DAIB						X	X				X	X							X			*Binary Input - MVF	171	572	DAIT						X	X				X	X							X			Decimal Input	91	568	DAID			X		X	X					X	X							X			Decimal Input - MVF	196	673	DAIM			X		X	X					X	X							X			*Binary Update	104	634	DAUB					X	X				X	X	X							X			*Binary Update - MVF	211	741	DAUT					X	X				X	X	X							X			Decimal Update	131	737	DAUD			X		X	X				X	X	X							X			Decimal Update - MVF	236	842	DAUM			X		X	X				X	X	X							X			<b>Indexed</b>																										Output	89	755	IOUT	X	X	X				X	X			X			X					X		X	Output - MVF	134	840	IOUM	X	X	X				X	X		X	X		X						X		X	Output Add	119	1251	IOAD	X	X	X				X	X			X		X	X	X	X	X	X	X	X	X	Output Add - MVF	240	1413	IOAM	X	X					X	X		X	X		X	X	X	X	X	X	X	X	X	<b>Indexed Random</b>																										Input	69	683	IRIP							X					X	X	X	X	X	X		X			Input - MVF	106	1008	IRIM							X		X		X	X	X	X	X	X	X	X	X	X	X	Update	106	919	IRUP							X	X			X	X	X	X	X	X	X		X			Update - MVF	143	1244	IRUM							X	X	X		X	X	X	X	X	X	X		X	X		Input Add	286	1394	IRAD	X	X					X	X			X	X	X	X	X	X	X	X	X		X	Input Add - MVF	330	1726	IRAM	X	X					X	X		X	X	X	X	X	X	X	X	X	X	X	X	Update Add	319	1497	IRUA	X	X					X	X	X		X	X	X	X	X	X	X	X	X		X	Update Add - MVF	362	1828	IRBM	X	X					X	X	X	X	X	X	X	X	X	X	X	X	X	X	X	<b>Indexed Sequential</b>																										Input	59	780	ISIP		X	X				X	X			X	X	X	X					X			Input - MVF	72	833	ISIM		X	X				X	X	X		X	X	X	X					X			Input - Limits	80	841	ISIL		X	X				X	X	X		X	X	X	X					X			Update	125	728	ISUP		X					X	X	X		X	X	X						X			Update - MVF	140	783	ISUM		X					X	X	X	X	X	X	X						X			Update - Limits	136	779	ISUL		X					X	X	X	X	X	X							X			Input Add	321	1214	ISAD	X	X		X			X	X	X		X	X	X	X					X		X	Input Add - MVF	338	1333	ISAM	X	X		X			X	X	X	X	X	X	X	X					X		X	Update Add	395	1358	ISUA	X	X		X			X	X	X	X	X	X	X						X		X	Update Add - MVF	415	1480	ISBM	X	X		X			X	X	X	X	X	X	X	X					X		X	Input - Variable Limits	105	866	ISIC		X	X				X	X	X	X	X	X	X	X					X			Update - Variable Limits	161	804	ISUC		X					X	X	X	X	X	X							X																																																																																																																																		
Update - MVF	149	487	CSUM		X					X		X	X		X							X		X	<b>Direct</b>																										*Binary Input	64	465	DAIB						X	X				X	X							X			*Binary Input - MVF	171	572	DAIT						X	X				X	X							X			Decimal Input	91	568	DAID			X		X	X					X	X							X			Decimal Input - MVF	196	673	DAIM			X		X	X					X	X							X			*Binary Update	104	634	DAUB					X	X				X	X	X							X			*Binary Update - MVF	211	741	DAUT					X	X				X	X	X							X			Decimal Update	131	737	DAUD			X		X	X				X	X	X							X			Decimal Update - MVF	236	842	DAUM			X		X	X				X	X	X							X			<b>Indexed</b>																										Output	89	755	IOUT	X	X	X				X	X			X			X					X		X	Output - MVF	134	840	IOUM	X	X	X				X	X		X	X		X						X		X	Output Add	119	1251	IOAD	X	X	X				X	X			X		X	X	X	X	X	X	X	X	X	Output Add - MVF	240	1413	IOAM	X	X					X	X		X	X		X	X	X	X	X	X	X	X	X	<b>Indexed Random</b>																										Input	69	683	IRIP							X					X	X	X	X	X	X		X			Input - MVF	106	1008	IRIM							X		X		X	X	X	X	X	X	X	X	X	X	X	Update	106	919	IRUP							X	X			X	X	X	X	X	X	X		X			Update - MVF	143	1244	IRUM							X	X	X		X	X	X	X	X	X	X		X	X		Input Add	286	1394	IRAD	X	X					X	X			X	X	X	X	X	X	X	X	X		X	Input Add - MVF	330	1726	IRAM	X	X					X	X		X	X	X	X	X	X	X	X	X	X	X	X	Update Add	319	1497	IRUA	X	X					X	X	X		X	X	X	X	X	X	X	X	X		X	Update Add - MVF	362	1828	IRBM	X	X					X	X	X	X	X	X	X	X	X	X	X	X	X	X	X	<b>Indexed Sequential</b>																										Input	59	780	ISIP		X	X				X	X			X	X	X	X					X			Input - MVF	72	833	ISIM		X	X				X	X	X		X	X	X	X					X			Input - Limits	80	841	ISIL		X	X				X	X	X		X	X	X	X					X			Update	125	728	ISUP		X					X	X	X		X	X	X						X			Update - MVF	140	783	ISUM		X					X	X	X	X	X	X	X						X			Update - Limits	136	779	ISUL		X					X	X	X	X	X	X							X			Input Add	321	1214	ISAD	X	X		X			X	X	X		X	X	X	X					X		X	Input Add - MVF	338	1333	ISAM	X	X		X			X	X	X	X	X	X	X	X					X		X	Update Add	395	1358	ISUA	X	X		X			X	X	X	X	X	X	X						X		X	Update Add - MVF	415	1480	ISBM	X	X		X			X	X	X	X	X	X	X	X					X		X	Input - Variable Limits	105	866	ISIC		X	X				X	X	X	X	X	X	X	X					X			Update - Variable Limits	161	804	ISUC		X					X	X	X	X	X	X							X																																																																																																																																																											
<b>Direct</b>																										*Binary Input	64	465	DAIB						X	X				X	X							X			*Binary Input - MVF	171	572	DAIT						X	X				X	X							X			Decimal Input	91	568	DAID			X		X	X					X	X							X			Decimal Input - MVF	196	673	DAIM			X		X	X					X	X							X			*Binary Update	104	634	DAUB					X	X				X	X	X							X			*Binary Update - MVF	211	741	DAUT					X	X				X	X	X							X			Decimal Update	131	737	DAUD			X		X	X				X	X	X							X			Decimal Update - MVF	236	842	DAUM			X		X	X				X	X	X							X			<b>Indexed</b>																										Output	89	755	IOUT	X	X	X				X	X			X			X					X		X	Output - MVF	134	840	IOUM	X	X	X				X	X		X	X		X						X		X	Output Add	119	1251	IOAD	X	X	X				X	X			X		X	X	X	X	X	X	X	X	X	Output Add - MVF	240	1413	IOAM	X	X					X	X		X	X		X	X	X	X	X	X	X	X	X	<b>Indexed Random</b>																										Input	69	683	IRIP							X					X	X	X	X	X	X		X			Input - MVF	106	1008	IRIM							X		X		X	X	X	X	X	X	X	X	X	X	X	Update	106	919	IRUP							X	X			X	X	X	X	X	X	X		X			Update - MVF	143	1244	IRUM							X	X	X		X	X	X	X	X	X	X		X	X		Input Add	286	1394	IRAD	X	X					X	X			X	X	X	X	X	X	X	X	X		X	Input Add - MVF	330	1726	IRAM	X	X					X	X		X	X	X	X	X	X	X	X	X	X	X	X	Update Add	319	1497	IRUA	X	X					X	X	X		X	X	X	X	X	X	X	X	X		X	Update Add - MVF	362	1828	IRBM	X	X					X	X	X	X	X	X	X	X	X	X	X	X	X	X	X	<b>Indexed Sequential</b>																										Input	59	780	ISIP		X	X				X	X			X	X	X	X					X			Input - MVF	72	833	ISIM		X	X				X	X	X		X	X	X	X					X			Input - Limits	80	841	ISIL		X	X				X	X	X		X	X	X	X					X			Update	125	728	ISUP		X					X	X	X		X	X	X						X			Update - MVF	140	783	ISUM		X					X	X	X	X	X	X	X						X			Update - Limits	136	779	ISUL		X					X	X	X	X	X	X							X			Input Add	321	1214	ISAD	X	X		X			X	X	X		X	X	X	X					X		X	Input Add - MVF	338	1333	ISAM	X	X		X			X	X	X	X	X	X	X	X					X		X	Update Add	395	1358	ISUA	X	X		X			X	X	X	X	X	X	X						X		X	Update Add - MVF	415	1480	ISBM	X	X		X			X	X	X	X	X	X	X	X					X		X	Input - Variable Limits	105	866	ISIC		X	X				X	X	X	X	X	X	X	X					X			Update - Variable Limits	161	804	ISUC		X					X	X	X	X	X	X							X																																																																																																																																																																																				
*Binary Input	64	465	DAIB						X	X				X	X							X			*Binary Input - MVF	171	572	DAIT						X	X				X	X							X			Decimal Input	91	568	DAID			X		X	X					X	X							X			Decimal Input - MVF	196	673	DAIM			X		X	X					X	X							X			*Binary Update	104	634	DAUB					X	X				X	X	X							X			*Binary Update - MVF	211	741	DAUT					X	X				X	X	X							X			Decimal Update	131	737	DAUD			X		X	X				X	X	X							X			Decimal Update - MVF	236	842	DAUM			X		X	X				X	X	X							X			<b>Indexed</b>																										Output	89	755	IOUT	X	X	X				X	X			X			X					X		X	Output - MVF	134	840	IOUM	X	X	X				X	X		X	X		X						X		X	Output Add	119	1251	IOAD	X	X	X				X	X			X		X	X	X	X	X	X	X	X	X	Output Add - MVF	240	1413	IOAM	X	X					X	X		X	X		X	X	X	X	X	X	X	X	X	<b>Indexed Random</b>																										Input	69	683	IRIP							X					X	X	X	X	X	X		X			Input - MVF	106	1008	IRIM							X		X		X	X	X	X	X	X	X	X	X	X	X	Update	106	919	IRUP							X	X			X	X	X	X	X	X	X		X			Update - MVF	143	1244	IRUM							X	X	X		X	X	X	X	X	X	X		X	X		Input Add	286	1394	IRAD	X	X					X	X			X	X	X	X	X	X	X	X	X		X	Input Add - MVF	330	1726	IRAM	X	X					X	X		X	X	X	X	X	X	X	X	X	X	X	X	Update Add	319	1497	IRUA	X	X					X	X	X		X	X	X	X	X	X	X	X	X		X	Update Add - MVF	362	1828	IRBM	X	X					X	X	X	X	X	X	X	X	X	X	X	X	X	X	X	<b>Indexed Sequential</b>																										Input	59	780	ISIP		X	X				X	X			X	X	X	X					X			Input - MVF	72	833	ISIM		X	X				X	X	X		X	X	X	X					X			Input - Limits	80	841	ISIL		X	X				X	X	X		X	X	X	X					X			Update	125	728	ISUP		X					X	X	X		X	X	X						X			Update - MVF	140	783	ISUM		X					X	X	X	X	X	X	X						X			Update - Limits	136	779	ISUL		X					X	X	X	X	X	X							X			Input Add	321	1214	ISAD	X	X		X			X	X	X		X	X	X	X					X		X	Input Add - MVF	338	1333	ISAM	X	X		X			X	X	X	X	X	X	X	X					X		X	Update Add	395	1358	ISUA	X	X		X			X	X	X	X	X	X	X						X		X	Update Add - MVF	415	1480	ISBM	X	X		X			X	X	X	X	X	X	X	X					X		X	Input - Variable Limits	105	866	ISIC		X	X				X	X	X	X	X	X	X	X					X			Update - Variable Limits	161	804	ISUC		X					X	X	X	X	X	X							X																																																																																																																																																																																																														
*Binary Input - MVF	171	572	DAIT						X	X				X	X							X			Decimal Input	91	568	DAID			X		X	X					X	X							X			Decimal Input - MVF	196	673	DAIM			X		X	X					X	X							X			*Binary Update	104	634	DAUB					X	X				X	X	X							X			*Binary Update - MVF	211	741	DAUT					X	X				X	X	X							X			Decimal Update	131	737	DAUD			X		X	X				X	X	X							X			Decimal Update - MVF	236	842	DAUM			X		X	X				X	X	X							X			<b>Indexed</b>																										Output	89	755	IOUT	X	X	X				X	X			X			X					X		X	Output - MVF	134	840	IOUM	X	X	X				X	X		X	X		X						X		X	Output Add	119	1251	IOAD	X	X	X				X	X			X		X	X	X	X	X	X	X	X	X	Output Add - MVF	240	1413	IOAM	X	X					X	X		X	X		X	X	X	X	X	X	X	X	X	<b>Indexed Random</b>																										Input	69	683	IRIP							X					X	X	X	X	X	X		X			Input - MVF	106	1008	IRIM							X		X		X	X	X	X	X	X	X	X	X	X	X	Update	106	919	IRUP							X	X			X	X	X	X	X	X	X		X			Update - MVF	143	1244	IRUM							X	X	X		X	X	X	X	X	X	X		X	X		Input Add	286	1394	IRAD	X	X					X	X			X	X	X	X	X	X	X	X	X		X	Input Add - MVF	330	1726	IRAM	X	X					X	X		X	X	X	X	X	X	X	X	X	X	X	X	Update Add	319	1497	IRUA	X	X					X	X	X		X	X	X	X	X	X	X	X	X		X	Update Add - MVF	362	1828	IRBM	X	X					X	X	X	X	X	X	X	X	X	X	X	X	X	X	X	<b>Indexed Sequential</b>																										Input	59	780	ISIP		X	X				X	X			X	X	X	X					X			Input - MVF	72	833	ISIM		X	X				X	X	X		X	X	X	X					X			Input - Limits	80	841	ISIL		X	X				X	X	X		X	X	X	X					X			Update	125	728	ISUP		X					X	X	X		X	X	X						X			Update - MVF	140	783	ISUM		X					X	X	X	X	X	X	X						X			Update - Limits	136	779	ISUL		X					X	X	X	X	X	X							X			Input Add	321	1214	ISAD	X	X		X			X	X	X		X	X	X	X					X		X	Input Add - MVF	338	1333	ISAM	X	X		X			X	X	X	X	X	X	X	X					X		X	Update Add	395	1358	ISUA	X	X		X			X	X	X	X	X	X	X						X		X	Update Add - MVF	415	1480	ISBM	X	X		X			X	X	X	X	X	X	X	X					X		X	Input - Variable Limits	105	866	ISIC		X	X				X	X	X	X	X	X	X	X					X			Update - Variable Limits	161	804	ISUC		X					X	X	X	X	X	X							X																																																																																																																																																																																																																																							
Decimal Input	91	568	DAID			X		X	X					X	X							X			Decimal Input - MVF	196	673	DAIM			X		X	X					X	X							X			*Binary Update	104	634	DAUB					X	X				X	X	X							X			*Binary Update - MVF	211	741	DAUT					X	X				X	X	X							X			Decimal Update	131	737	DAUD			X		X	X				X	X	X							X			Decimal Update - MVF	236	842	DAUM			X		X	X				X	X	X							X			<b>Indexed</b>																										Output	89	755	IOUT	X	X	X				X	X			X			X					X		X	Output - MVF	134	840	IOUM	X	X	X				X	X		X	X		X						X		X	Output Add	119	1251	IOAD	X	X	X				X	X			X		X	X	X	X	X	X	X	X	X	Output Add - MVF	240	1413	IOAM	X	X					X	X		X	X		X	X	X	X	X	X	X	X	X	<b>Indexed Random</b>																										Input	69	683	IRIP							X					X	X	X	X	X	X		X			Input - MVF	106	1008	IRIM							X		X		X	X	X	X	X	X	X	X	X	X	X	Update	106	919	IRUP							X	X			X	X	X	X	X	X	X		X			Update - MVF	143	1244	IRUM							X	X	X		X	X	X	X	X	X	X		X	X		Input Add	286	1394	IRAD	X	X					X	X			X	X	X	X	X	X	X	X	X		X	Input Add - MVF	330	1726	IRAM	X	X					X	X		X	X	X	X	X	X	X	X	X	X	X	X	Update Add	319	1497	IRUA	X	X					X	X	X		X	X	X	X	X	X	X	X	X		X	Update Add - MVF	362	1828	IRBM	X	X					X	X	X	X	X	X	X	X	X	X	X	X	X	X	X	<b>Indexed Sequential</b>																										Input	59	780	ISIP		X	X				X	X			X	X	X	X					X			Input - MVF	72	833	ISIM		X	X				X	X	X		X	X	X	X					X			Input - Limits	80	841	ISIL		X	X				X	X	X		X	X	X	X					X			Update	125	728	ISUP		X					X	X	X		X	X	X						X			Update - MVF	140	783	ISUM		X					X	X	X	X	X	X	X						X			Update - Limits	136	779	ISUL		X					X	X	X	X	X	X							X			Input Add	321	1214	ISAD	X	X		X			X	X	X		X	X	X	X					X		X	Input Add - MVF	338	1333	ISAM	X	X		X			X	X	X	X	X	X	X	X					X		X	Update Add	395	1358	ISUA	X	X		X			X	X	X	X	X	X	X						X		X	Update Add - MVF	415	1480	ISBM	X	X		X			X	X	X	X	X	X	X	X					X		X	Input - Variable Limits	105	866	ISIC		X	X				X	X	X	X	X	X	X	X					X			Update - Variable Limits	161	804	ISUC		X					X	X	X	X	X	X							X																																																																																																																																																																																																																																																																
Decimal Input - MVF	196	673	DAIM			X		X	X					X	X							X			*Binary Update	104	634	DAUB					X	X				X	X	X							X			*Binary Update - MVF	211	741	DAUT					X	X				X	X	X							X			Decimal Update	131	737	DAUD			X		X	X				X	X	X							X			Decimal Update - MVF	236	842	DAUM			X		X	X				X	X	X							X			<b>Indexed</b>																										Output	89	755	IOUT	X	X	X				X	X			X			X					X		X	Output - MVF	134	840	IOUM	X	X	X				X	X		X	X		X						X		X	Output Add	119	1251	IOAD	X	X	X				X	X			X		X	X	X	X	X	X	X	X	X	Output Add - MVF	240	1413	IOAM	X	X					X	X		X	X		X	X	X	X	X	X	X	X	X	<b>Indexed Random</b>																										Input	69	683	IRIP							X					X	X	X	X	X	X		X			Input - MVF	106	1008	IRIM							X		X		X	X	X	X	X	X	X	X	X	X	X	Update	106	919	IRUP							X	X			X	X	X	X	X	X	X		X			Update - MVF	143	1244	IRUM							X	X	X		X	X	X	X	X	X	X		X	X		Input Add	286	1394	IRAD	X	X					X	X			X	X	X	X	X	X	X	X	X		X	Input Add - MVF	330	1726	IRAM	X	X					X	X		X	X	X	X	X	X	X	X	X	X	X	X	Update Add	319	1497	IRUA	X	X					X	X	X		X	X	X	X	X	X	X	X	X		X	Update Add - MVF	362	1828	IRBM	X	X					X	X	X	X	X	X	X	X	X	X	X	X	X	X	X	<b>Indexed Sequential</b>																										Input	59	780	ISIP		X	X				X	X			X	X	X	X					X			Input - MVF	72	833	ISIM		X	X				X	X	X		X	X	X	X					X			Input - Limits	80	841	ISIL		X	X				X	X	X		X	X	X	X					X			Update	125	728	ISUP		X					X	X	X		X	X	X						X			Update - MVF	140	783	ISUM		X					X	X	X	X	X	X	X						X			Update - Limits	136	779	ISUL		X					X	X	X	X	X	X							X			Input Add	321	1214	ISAD	X	X		X			X	X	X		X	X	X	X					X		X	Input Add - MVF	338	1333	ISAM	X	X		X			X	X	X	X	X	X	X	X					X		X	Update Add	395	1358	ISUA	X	X		X			X	X	X	X	X	X	X						X		X	Update Add - MVF	415	1480	ISBM	X	X		X			X	X	X	X	X	X	X	X					X		X	Input - Variable Limits	105	866	ISIC		X	X				X	X	X	X	X	X	X	X					X			Update - Variable Limits	161	804	ISUC		X					X	X	X	X	X	X							X																																																																																																																																																																																																																																																																																									
*Binary Update	104	634	DAUB					X	X				X	X	X							X			*Binary Update - MVF	211	741	DAUT					X	X				X	X	X							X			Decimal Update	131	737	DAUD			X		X	X				X	X	X							X			Decimal Update - MVF	236	842	DAUM			X		X	X				X	X	X							X			<b>Indexed</b>																										Output	89	755	IOUT	X	X	X				X	X			X			X					X		X	Output - MVF	134	840	IOUM	X	X	X				X	X		X	X		X						X		X	Output Add	119	1251	IOAD	X	X	X				X	X			X		X	X	X	X	X	X	X	X	X	Output Add - MVF	240	1413	IOAM	X	X					X	X		X	X		X	X	X	X	X	X	X	X	X	<b>Indexed Random</b>																										Input	69	683	IRIP							X					X	X	X	X	X	X		X			Input - MVF	106	1008	IRIM							X		X		X	X	X	X	X	X	X	X	X	X	X	Update	106	919	IRUP							X	X			X	X	X	X	X	X	X		X			Update - MVF	143	1244	IRUM							X	X	X		X	X	X	X	X	X	X		X	X		Input Add	286	1394	IRAD	X	X					X	X			X	X	X	X	X	X	X	X	X		X	Input Add - MVF	330	1726	IRAM	X	X					X	X		X	X	X	X	X	X	X	X	X	X	X	X	Update Add	319	1497	IRUA	X	X					X	X	X		X	X	X	X	X	X	X	X	X		X	Update Add - MVF	362	1828	IRBM	X	X					X	X	X	X	X	X	X	X	X	X	X	X	X	X	X	<b>Indexed Sequential</b>																										Input	59	780	ISIP		X	X				X	X			X	X	X	X					X			Input - MVF	72	833	ISIM		X	X				X	X	X		X	X	X	X					X			Input - Limits	80	841	ISIL		X	X				X	X	X		X	X	X	X					X			Update	125	728	ISUP		X					X	X	X		X	X	X						X			Update - MVF	140	783	ISUM		X					X	X	X	X	X	X	X						X			Update - Limits	136	779	ISUL		X					X	X	X	X	X	X							X			Input Add	321	1214	ISAD	X	X		X			X	X	X		X	X	X	X					X		X	Input Add - MVF	338	1333	ISAM	X	X		X			X	X	X	X	X	X	X	X					X		X	Update Add	395	1358	ISUA	X	X		X			X	X	X	X	X	X	X						X		X	Update Add - MVF	415	1480	ISBM	X	X		X			X	X	X	X	X	X	X	X					X		X	Input - Variable Limits	105	866	ISIC		X	X				X	X	X	X	X	X	X	X					X			Update - Variable Limits	161	804	ISUC		X					X	X	X	X	X	X							X																																																																																																																																																																																																																																																																																																																		
*Binary Update - MVF	211	741	DAUT					X	X				X	X	X							X			Decimal Update	131	737	DAUD			X		X	X				X	X	X							X			Decimal Update - MVF	236	842	DAUM			X		X	X				X	X	X							X			<b>Indexed</b>																										Output	89	755	IOUT	X	X	X				X	X			X			X					X		X	Output - MVF	134	840	IOUM	X	X	X				X	X		X	X		X						X		X	Output Add	119	1251	IOAD	X	X	X				X	X			X		X	X	X	X	X	X	X	X	X	Output Add - MVF	240	1413	IOAM	X	X					X	X		X	X		X	X	X	X	X	X	X	X	X	<b>Indexed Random</b>																										Input	69	683	IRIP							X					X	X	X	X	X	X		X			Input - MVF	106	1008	IRIM							X		X		X	X	X	X	X	X	X	X	X	X	X	Update	106	919	IRUP							X	X			X	X	X	X	X	X	X		X			Update - MVF	143	1244	IRUM							X	X	X		X	X	X	X	X	X	X		X	X		Input Add	286	1394	IRAD	X	X					X	X			X	X	X	X	X	X	X	X	X		X	Input Add - MVF	330	1726	IRAM	X	X					X	X		X	X	X	X	X	X	X	X	X	X	X	X	Update Add	319	1497	IRUA	X	X					X	X	X		X	X	X	X	X	X	X	X	X		X	Update Add - MVF	362	1828	IRBM	X	X					X	X	X	X	X	X	X	X	X	X	X	X	X	X	X	<b>Indexed Sequential</b>																										Input	59	780	ISIP		X	X				X	X			X	X	X	X					X			Input - MVF	72	833	ISIM		X	X				X	X	X		X	X	X	X					X			Input - Limits	80	841	ISIL		X	X				X	X	X		X	X	X	X					X			Update	125	728	ISUP		X					X	X	X		X	X	X						X			Update - MVF	140	783	ISUM		X					X	X	X	X	X	X	X						X			Update - Limits	136	779	ISUL		X					X	X	X	X	X	X							X			Input Add	321	1214	ISAD	X	X		X			X	X	X		X	X	X	X					X		X	Input Add - MVF	338	1333	ISAM	X	X		X			X	X	X	X	X	X	X	X					X		X	Update Add	395	1358	ISUA	X	X		X			X	X	X	X	X	X	X						X		X	Update Add - MVF	415	1480	ISBM	X	X		X			X	X	X	X	X	X	X	X					X		X	Input - Variable Limits	105	866	ISIC		X	X				X	X	X	X	X	X	X	X					X			Update - Variable Limits	161	804	ISUC		X					X	X	X	X	X	X							X																																																																																																																																																																																																																																																																																																																																											
Decimal Update	131	737	DAUD			X		X	X				X	X	X							X			Decimal Update - MVF	236	842	DAUM			X		X	X				X	X	X							X			<b>Indexed</b>																										Output	89	755	IOUT	X	X	X				X	X			X			X					X		X	Output - MVF	134	840	IOUM	X	X	X				X	X		X	X		X						X		X	Output Add	119	1251	IOAD	X	X	X				X	X			X		X	X	X	X	X	X	X	X	X	Output Add - MVF	240	1413	IOAM	X	X					X	X		X	X		X	X	X	X	X	X	X	X	X	<b>Indexed Random</b>																										Input	69	683	IRIP							X					X	X	X	X	X	X		X			Input - MVF	106	1008	IRIM							X		X		X	X	X	X	X	X	X	X	X	X	X	Update	106	919	IRUP							X	X			X	X	X	X	X	X	X		X			Update - MVF	143	1244	IRUM							X	X	X		X	X	X	X	X	X	X		X	X		Input Add	286	1394	IRAD	X	X					X	X			X	X	X	X	X	X	X	X	X		X	Input Add - MVF	330	1726	IRAM	X	X					X	X		X	X	X	X	X	X	X	X	X	X	X	X	Update Add	319	1497	IRUA	X	X					X	X	X		X	X	X	X	X	X	X	X	X		X	Update Add - MVF	362	1828	IRBM	X	X					X	X	X	X	X	X	X	X	X	X	X	X	X	X	X	<b>Indexed Sequential</b>																										Input	59	780	ISIP		X	X				X	X			X	X	X	X					X			Input - MVF	72	833	ISIM		X	X				X	X	X		X	X	X	X					X			Input - Limits	80	841	ISIL		X	X				X	X	X		X	X	X	X					X			Update	125	728	ISUP		X					X	X	X		X	X	X						X			Update - MVF	140	783	ISUM		X					X	X	X	X	X	X	X						X			Update - Limits	136	779	ISUL		X					X	X	X	X	X	X							X			Input Add	321	1214	ISAD	X	X		X			X	X	X		X	X	X	X					X		X	Input Add - MVF	338	1333	ISAM	X	X		X			X	X	X	X	X	X	X	X					X		X	Update Add	395	1358	ISUA	X	X		X			X	X	X	X	X	X	X						X		X	Update Add - MVF	415	1480	ISBM	X	X		X			X	X	X	X	X	X	X	X					X		X	Input - Variable Limits	105	866	ISIC		X	X				X	X	X	X	X	X	X	X					X			Update - Variable Limits	161	804	ISUC		X					X	X	X	X	X	X							X																																																																																																																																																																																																																																																																																																																																																																				
Decimal Update - MVF	236	842	DAUM			X		X	X				X	X	X							X			<b>Indexed</b>																										Output	89	755	IOUT	X	X	X				X	X			X			X					X		X	Output - MVF	134	840	IOUM	X	X	X				X	X		X	X		X						X		X	Output Add	119	1251	IOAD	X	X	X				X	X			X		X	X	X	X	X	X	X	X	X	Output Add - MVF	240	1413	IOAM	X	X					X	X		X	X		X	X	X	X	X	X	X	X	X	<b>Indexed Random</b>																										Input	69	683	IRIP							X					X	X	X	X	X	X		X			Input - MVF	106	1008	IRIM							X		X		X	X	X	X	X	X	X	X	X	X	X	Update	106	919	IRUP							X	X			X	X	X	X	X	X	X		X			Update - MVF	143	1244	IRUM							X	X	X		X	X	X	X	X	X	X		X	X		Input Add	286	1394	IRAD	X	X					X	X			X	X	X	X	X	X	X	X	X		X	Input Add - MVF	330	1726	IRAM	X	X					X	X		X	X	X	X	X	X	X	X	X	X	X	X	Update Add	319	1497	IRUA	X	X					X	X	X		X	X	X	X	X	X	X	X	X		X	Update Add - MVF	362	1828	IRBM	X	X					X	X	X	X	X	X	X	X	X	X	X	X	X	X	X	<b>Indexed Sequential</b>																										Input	59	780	ISIP		X	X				X	X			X	X	X	X					X			Input - MVF	72	833	ISIM		X	X				X	X	X		X	X	X	X					X			Input - Limits	80	841	ISIL		X	X				X	X	X		X	X	X	X					X			Update	125	728	ISUP		X					X	X	X		X	X	X						X			Update - MVF	140	783	ISUM		X					X	X	X	X	X	X	X						X			Update - Limits	136	779	ISUL		X					X	X	X	X	X	X							X			Input Add	321	1214	ISAD	X	X		X			X	X	X		X	X	X	X					X		X	Input Add - MVF	338	1333	ISAM	X	X		X			X	X	X	X	X	X	X	X					X		X	Update Add	395	1358	ISUA	X	X		X			X	X	X	X	X	X	X						X		X	Update Add - MVF	415	1480	ISBM	X	X		X			X	X	X	X	X	X	X	X					X		X	Input - Variable Limits	105	866	ISIC		X	X				X	X	X	X	X	X	X	X					X			Update - Variable Limits	161	804	ISUC		X					X	X	X	X	X	X							X																																																																																																																																																																																																																																																																																																																																																																																													
<b>Indexed</b>																										Output	89	755	IOUT	X	X	X				X	X			X			X					X		X	Output - MVF	134	840	IOUM	X	X	X				X	X		X	X		X						X		X	Output Add	119	1251	IOAD	X	X	X				X	X			X		X	X	X	X	X	X	X	X	X	Output Add - MVF	240	1413	IOAM	X	X					X	X		X	X		X	X	X	X	X	X	X	X	X	<b>Indexed Random</b>																										Input	69	683	IRIP							X					X	X	X	X	X	X		X			Input - MVF	106	1008	IRIM							X		X		X	X	X	X	X	X	X	X	X	X	X	Update	106	919	IRUP							X	X			X	X	X	X	X	X	X		X			Update - MVF	143	1244	IRUM							X	X	X		X	X	X	X	X	X	X		X	X		Input Add	286	1394	IRAD	X	X					X	X			X	X	X	X	X	X	X	X	X		X	Input Add - MVF	330	1726	IRAM	X	X					X	X		X	X	X	X	X	X	X	X	X	X	X	X	Update Add	319	1497	IRUA	X	X					X	X	X		X	X	X	X	X	X	X	X	X		X	Update Add - MVF	362	1828	IRBM	X	X					X	X	X	X	X	X	X	X	X	X	X	X	X	X	X	<b>Indexed Sequential</b>																										Input	59	780	ISIP		X	X				X	X			X	X	X	X					X			Input - MVF	72	833	ISIM		X	X				X	X	X		X	X	X	X					X			Input - Limits	80	841	ISIL		X	X				X	X	X		X	X	X	X					X			Update	125	728	ISUP		X					X	X	X		X	X	X						X			Update - MVF	140	783	ISUM		X					X	X	X	X	X	X	X						X			Update - Limits	136	779	ISUL		X					X	X	X	X	X	X							X			Input Add	321	1214	ISAD	X	X		X			X	X	X		X	X	X	X					X		X	Input Add - MVF	338	1333	ISAM	X	X		X			X	X	X	X	X	X	X	X					X		X	Update Add	395	1358	ISUA	X	X		X			X	X	X	X	X	X	X						X		X	Update Add - MVF	415	1480	ISBM	X	X		X			X	X	X	X	X	X	X	X					X		X	Input - Variable Limits	105	866	ISIC		X	X				X	X	X	X	X	X	X	X					X			Update - Variable Limits	161	804	ISUC		X					X	X	X	X	X	X							X																																																																																																																																																																																																																																																																																																																																																																																																																						
Output	89	755	IOUT	X	X	X				X	X			X			X					X		X	Output - MVF	134	840	IOUM	X	X	X				X	X		X	X		X						X		X	Output Add	119	1251	IOAD	X	X	X				X	X			X		X	X	X	X	X	X	X	X	X	Output Add - MVF	240	1413	IOAM	X	X					X	X		X	X		X	X	X	X	X	X	X	X	X	<b>Indexed Random</b>																										Input	69	683	IRIP							X					X	X	X	X	X	X		X			Input - MVF	106	1008	IRIM							X		X		X	X	X	X	X	X	X	X	X	X	X	Update	106	919	IRUP							X	X			X	X	X	X	X	X	X		X			Update - MVF	143	1244	IRUM							X	X	X		X	X	X	X	X	X	X		X	X		Input Add	286	1394	IRAD	X	X					X	X			X	X	X	X	X	X	X	X	X		X	Input Add - MVF	330	1726	IRAM	X	X					X	X		X	X	X	X	X	X	X	X	X	X	X	X	Update Add	319	1497	IRUA	X	X					X	X	X		X	X	X	X	X	X	X	X	X		X	Update Add - MVF	362	1828	IRBM	X	X					X	X	X	X	X	X	X	X	X	X	X	X	X	X	X	<b>Indexed Sequential</b>																										Input	59	780	ISIP		X	X				X	X			X	X	X	X					X			Input - MVF	72	833	ISIM		X	X				X	X	X		X	X	X	X					X			Input - Limits	80	841	ISIL		X	X				X	X	X		X	X	X	X					X			Update	125	728	ISUP		X					X	X	X		X	X	X						X			Update - MVF	140	783	ISUM		X					X	X	X	X	X	X	X						X			Update - Limits	136	779	ISUL		X					X	X	X	X	X	X							X			Input Add	321	1214	ISAD	X	X		X			X	X	X		X	X	X	X					X		X	Input Add - MVF	338	1333	ISAM	X	X		X			X	X	X	X	X	X	X	X					X		X	Update Add	395	1358	ISUA	X	X		X			X	X	X	X	X	X	X						X		X	Update Add - MVF	415	1480	ISBM	X	X		X			X	X	X	X	X	X	X	X					X		X	Input - Variable Limits	105	866	ISIC		X	X				X	X	X	X	X	X	X	X					X			Update - Variable Limits	161	804	ISUC		X					X	X	X	X	X	X							X																																																																																																																																																																																																																																																																																																																																																																																																																																																
Output - MVF	134	840	IOUM	X	X	X				X	X		X	X		X						X		X	Output Add	119	1251	IOAD	X	X	X				X	X			X		X	X	X	X	X	X	X	X	X	Output Add - MVF	240	1413	IOAM	X	X					X	X		X	X		X	X	X	X	X	X	X	X	X	<b>Indexed Random</b>																										Input	69	683	IRIP							X					X	X	X	X	X	X		X			Input - MVF	106	1008	IRIM							X		X		X	X	X	X	X	X	X	X	X	X	X	Update	106	919	IRUP							X	X			X	X	X	X	X	X	X		X			Update - MVF	143	1244	IRUM							X	X	X		X	X	X	X	X	X	X		X	X		Input Add	286	1394	IRAD	X	X					X	X			X	X	X	X	X	X	X	X	X		X	Input Add - MVF	330	1726	IRAM	X	X					X	X		X	X	X	X	X	X	X	X	X	X	X	X	Update Add	319	1497	IRUA	X	X					X	X	X		X	X	X	X	X	X	X	X	X		X	Update Add - MVF	362	1828	IRBM	X	X					X	X	X	X	X	X	X	X	X	X	X	X	X	X	X	<b>Indexed Sequential</b>																										Input	59	780	ISIP		X	X				X	X			X	X	X	X					X			Input - MVF	72	833	ISIM		X	X				X	X	X		X	X	X	X					X			Input - Limits	80	841	ISIL		X	X				X	X	X		X	X	X	X					X			Update	125	728	ISUP		X					X	X	X		X	X	X						X			Update - MVF	140	783	ISUM		X					X	X	X	X	X	X	X						X			Update - Limits	136	779	ISUL		X					X	X	X	X	X	X							X			Input Add	321	1214	ISAD	X	X		X			X	X	X		X	X	X	X					X		X	Input Add - MVF	338	1333	ISAM	X	X		X			X	X	X	X	X	X	X	X					X		X	Update Add	395	1358	ISUA	X	X		X			X	X	X	X	X	X	X						X		X	Update Add - MVF	415	1480	ISBM	X	X		X			X	X	X	X	X	X	X	X					X		X	Input - Variable Limits	105	866	ISIC		X	X				X	X	X	X	X	X	X	X					X			Update - Variable Limits	161	804	ISUC		X					X	X	X	X	X	X							X																																																																																																																																																																																																																																																																																																																																																																																																																																																																									
Output Add	119	1251	IOAD	X	X	X				X	X			X		X	X	X	X	X	X	X	X	X	Output Add - MVF	240	1413	IOAM	X	X					X	X		X	X		X	X	X	X	X	X	X	X	X	<b>Indexed Random</b>																										Input	69	683	IRIP							X					X	X	X	X	X	X		X			Input - MVF	106	1008	IRIM							X		X		X	X	X	X	X	X	X	X	X	X	X	Update	106	919	IRUP							X	X			X	X	X	X	X	X	X		X			Update - MVF	143	1244	IRUM							X	X	X		X	X	X	X	X	X	X		X	X		Input Add	286	1394	IRAD	X	X					X	X			X	X	X	X	X	X	X	X	X		X	Input Add - MVF	330	1726	IRAM	X	X					X	X		X	X	X	X	X	X	X	X	X	X	X	X	Update Add	319	1497	IRUA	X	X					X	X	X		X	X	X	X	X	X	X	X	X		X	Update Add - MVF	362	1828	IRBM	X	X					X	X	X	X	X	X	X	X	X	X	X	X	X	X	X	<b>Indexed Sequential</b>																										Input	59	780	ISIP		X	X				X	X			X	X	X	X					X			Input - MVF	72	833	ISIM		X	X				X	X	X		X	X	X	X					X			Input - Limits	80	841	ISIL		X	X				X	X	X		X	X	X	X					X			Update	125	728	ISUP		X					X	X	X		X	X	X						X			Update - MVF	140	783	ISUM		X					X	X	X	X	X	X	X						X			Update - Limits	136	779	ISUL		X					X	X	X	X	X	X							X			Input Add	321	1214	ISAD	X	X		X			X	X	X		X	X	X	X					X		X	Input Add - MVF	338	1333	ISAM	X	X		X			X	X	X	X	X	X	X	X					X		X	Update Add	395	1358	ISUA	X	X		X			X	X	X	X	X	X	X						X		X	Update Add - MVF	415	1480	ISBM	X	X		X			X	X	X	X	X	X	X	X					X		X	Input - Variable Limits	105	866	ISIC		X	X				X	X	X	X	X	X	X	X					X			Update - Variable Limits	161	804	ISUC		X					X	X	X	X	X	X							X																																																																																																																																																																																																																																																																																																																																																																																																																																																																																																		
Output Add - MVF	240	1413	IOAM	X	X					X	X		X	X		X	X	X	X	X	X	X	X	X	<b>Indexed Random</b>																										Input	69	683	IRIP							X					X	X	X	X	X	X		X			Input - MVF	106	1008	IRIM							X		X		X	X	X	X	X	X	X	X	X	X	X	Update	106	919	IRUP							X	X			X	X	X	X	X	X	X		X			Update - MVF	143	1244	IRUM							X	X	X		X	X	X	X	X	X	X		X	X		Input Add	286	1394	IRAD	X	X					X	X			X	X	X	X	X	X	X	X	X		X	Input Add - MVF	330	1726	IRAM	X	X					X	X		X	X	X	X	X	X	X	X	X	X	X	X	Update Add	319	1497	IRUA	X	X					X	X	X		X	X	X	X	X	X	X	X	X		X	Update Add - MVF	362	1828	IRBM	X	X					X	X	X	X	X	X	X	X	X	X	X	X	X	X	X	<b>Indexed Sequential</b>																										Input	59	780	ISIP		X	X				X	X			X	X	X	X					X			Input - MVF	72	833	ISIM		X	X				X	X	X		X	X	X	X					X			Input - Limits	80	841	ISIL		X	X				X	X	X		X	X	X	X					X			Update	125	728	ISUP		X					X	X	X		X	X	X						X			Update - MVF	140	783	ISUM		X					X	X	X	X	X	X	X						X			Update - Limits	136	779	ISUL		X					X	X	X	X	X	X							X			Input Add	321	1214	ISAD	X	X		X			X	X	X		X	X	X	X					X		X	Input Add - MVF	338	1333	ISAM	X	X		X			X	X	X	X	X	X	X	X					X		X	Update Add	395	1358	ISUA	X	X		X			X	X	X	X	X	X	X						X		X	Update Add - MVF	415	1480	ISBM	X	X		X			X	X	X	X	X	X	X	X					X		X	Input - Variable Limits	105	866	ISIC		X	X				X	X	X	X	X	X	X	X					X			Update - Variable Limits	161	804	ISUC		X					X	X	X	X	X	X							X																																																																																																																																																																																																																																																																																																																																																																																																																																																																																																																											
<b>Indexed Random</b>																										Input	69	683	IRIP							X					X	X	X	X	X	X		X			Input - MVF	106	1008	IRIM							X		X		X	X	X	X	X	X	X	X	X	X	X	Update	106	919	IRUP							X	X			X	X	X	X	X	X	X		X			Update - MVF	143	1244	IRUM							X	X	X		X	X	X	X	X	X	X		X	X		Input Add	286	1394	IRAD	X	X					X	X			X	X	X	X	X	X	X	X	X		X	Input Add - MVF	330	1726	IRAM	X	X					X	X		X	X	X	X	X	X	X	X	X	X	X	X	Update Add	319	1497	IRUA	X	X					X	X	X		X	X	X	X	X	X	X	X	X		X	Update Add - MVF	362	1828	IRBM	X	X					X	X	X	X	X	X	X	X	X	X	X	X	X	X	X	<b>Indexed Sequential</b>																										Input	59	780	ISIP		X	X				X	X			X	X	X	X					X			Input - MVF	72	833	ISIM		X	X				X	X	X		X	X	X	X					X			Input - Limits	80	841	ISIL		X	X				X	X	X		X	X	X	X					X			Update	125	728	ISUP		X					X	X	X		X	X	X						X			Update - MVF	140	783	ISUM		X					X	X	X	X	X	X	X						X			Update - Limits	136	779	ISUL		X					X	X	X	X	X	X							X			Input Add	321	1214	ISAD	X	X		X			X	X	X		X	X	X	X					X		X	Input Add - MVF	338	1333	ISAM	X	X		X			X	X	X	X	X	X	X	X					X		X	Update Add	395	1358	ISUA	X	X		X			X	X	X	X	X	X	X						X		X	Update Add - MVF	415	1480	ISBM	X	X		X			X	X	X	X	X	X	X	X					X		X	Input - Variable Limits	105	866	ISIC		X	X				X	X	X	X	X	X	X	X					X			Update - Variable Limits	161	804	ISUC		X					X	X	X	X	X	X							X																																																																																																																																																																																																																																																																																																																																																																																																																																																																																																																																																				
Input	69	683	IRIP							X					X	X	X	X	X	X		X			Input - MVF	106	1008	IRIM							X		X		X	X	X	X	X	X	X	X	X	X	X	Update	106	919	IRUP							X	X			X	X	X	X	X	X	X		X			Update - MVF	143	1244	IRUM							X	X	X		X	X	X	X	X	X	X		X	X		Input Add	286	1394	IRAD	X	X					X	X			X	X	X	X	X	X	X	X	X		X	Input Add - MVF	330	1726	IRAM	X	X					X	X		X	X	X	X	X	X	X	X	X	X	X	X	Update Add	319	1497	IRUA	X	X					X	X	X		X	X	X	X	X	X	X	X	X		X	Update Add - MVF	362	1828	IRBM	X	X					X	X	X	X	X	X	X	X	X	X	X	X	X	X	X	<b>Indexed Sequential</b>																										Input	59	780	ISIP		X	X				X	X			X	X	X	X					X			Input - MVF	72	833	ISIM		X	X				X	X	X		X	X	X	X					X			Input - Limits	80	841	ISIL		X	X				X	X	X		X	X	X	X					X			Update	125	728	ISUP		X					X	X	X		X	X	X						X			Update - MVF	140	783	ISUM		X					X	X	X	X	X	X	X						X			Update - Limits	136	779	ISUL		X					X	X	X	X	X	X							X			Input Add	321	1214	ISAD	X	X		X			X	X	X		X	X	X	X					X		X	Input Add - MVF	338	1333	ISAM	X	X		X			X	X	X	X	X	X	X	X					X		X	Update Add	395	1358	ISUA	X	X		X			X	X	X	X	X	X	X						X		X	Update Add - MVF	415	1480	ISBM	X	X		X			X	X	X	X	X	X	X	X					X		X	Input - Variable Limits	105	866	ISIC		X	X				X	X	X	X	X	X	X	X					X			Update - Variable Limits	161	804	ISUC		X					X	X	X	X	X	X							X																																																																																																																																																																																																																																																																																																																																																																																																																																																																																																																																																																														
Input - MVF	106	1008	IRIM							X		X		X	X	X	X	X	X	X	X	X	X	X	Update	106	919	IRUP							X	X			X	X	X	X	X	X	X		X			Update - MVF	143	1244	IRUM							X	X	X		X	X	X	X	X	X	X		X	X		Input Add	286	1394	IRAD	X	X					X	X			X	X	X	X	X	X	X	X	X		X	Input Add - MVF	330	1726	IRAM	X	X					X	X		X	X	X	X	X	X	X	X	X	X	X	X	Update Add	319	1497	IRUA	X	X					X	X	X		X	X	X	X	X	X	X	X	X		X	Update Add - MVF	362	1828	IRBM	X	X					X	X	X	X	X	X	X	X	X	X	X	X	X	X	X	<b>Indexed Sequential</b>																										Input	59	780	ISIP		X	X				X	X			X	X	X	X					X			Input - MVF	72	833	ISIM		X	X				X	X	X		X	X	X	X					X			Input - Limits	80	841	ISIL		X	X				X	X	X		X	X	X	X					X			Update	125	728	ISUP		X					X	X	X		X	X	X						X			Update - MVF	140	783	ISUM		X					X	X	X	X	X	X	X						X			Update - Limits	136	779	ISUL		X					X	X	X	X	X	X							X			Input Add	321	1214	ISAD	X	X		X			X	X	X		X	X	X	X					X		X	Input Add - MVF	338	1333	ISAM	X	X		X			X	X	X	X	X	X	X	X					X		X	Update Add	395	1358	ISUA	X	X		X			X	X	X	X	X	X	X						X		X	Update Add - MVF	415	1480	ISBM	X	X		X			X	X	X	X	X	X	X	X					X		X	Input - Variable Limits	105	866	ISIC		X	X				X	X	X	X	X	X	X	X					X			Update - Variable Limits	161	804	ISUC		X					X	X	X	X	X	X							X																																																																																																																																																																																																																																																																																																																																																																																																																																																																																																																																																																																																							
Update	106	919	IRUP							X	X			X	X	X	X	X	X	X		X			Update - MVF	143	1244	IRUM							X	X	X		X	X	X	X	X	X	X		X	X		Input Add	286	1394	IRAD	X	X					X	X			X	X	X	X	X	X	X	X	X		X	Input Add - MVF	330	1726	IRAM	X	X					X	X		X	X	X	X	X	X	X	X	X	X	X	X	Update Add	319	1497	IRUA	X	X					X	X	X		X	X	X	X	X	X	X	X	X		X	Update Add - MVF	362	1828	IRBM	X	X					X	X	X	X	X	X	X	X	X	X	X	X	X	X	X	<b>Indexed Sequential</b>																										Input	59	780	ISIP		X	X				X	X			X	X	X	X					X			Input - MVF	72	833	ISIM		X	X				X	X	X		X	X	X	X					X			Input - Limits	80	841	ISIL		X	X				X	X	X		X	X	X	X					X			Update	125	728	ISUP		X					X	X	X		X	X	X						X			Update - MVF	140	783	ISUM		X					X	X	X	X	X	X	X						X			Update - Limits	136	779	ISUL		X					X	X	X	X	X	X							X			Input Add	321	1214	ISAD	X	X		X			X	X	X		X	X	X	X					X		X	Input Add - MVF	338	1333	ISAM	X	X		X			X	X	X	X	X	X	X	X					X		X	Update Add	395	1358	ISUA	X	X		X			X	X	X	X	X	X	X						X		X	Update Add - MVF	415	1480	ISBM	X	X		X			X	X	X	X	X	X	X	X					X		X	Input - Variable Limits	105	866	ISIC		X	X				X	X	X	X	X	X	X	X					X			Update - Variable Limits	161	804	ISUC		X					X	X	X	X	X	X							X																																																																																																																																																																																																																																																																																																																																																																																																																																																																																																																																																																																																																																
Update - MVF	143	1244	IRUM							X	X	X		X	X	X	X	X	X	X		X	X		Input Add	286	1394	IRAD	X	X					X	X			X	X	X	X	X	X	X	X	X		X	Input Add - MVF	330	1726	IRAM	X	X					X	X		X	X	X	X	X	X	X	X	X	X	X	X	Update Add	319	1497	IRUA	X	X					X	X	X		X	X	X	X	X	X	X	X	X		X	Update Add - MVF	362	1828	IRBM	X	X					X	X	X	X	X	X	X	X	X	X	X	X	X	X	X	<b>Indexed Sequential</b>																										Input	59	780	ISIP		X	X				X	X			X	X	X	X					X			Input - MVF	72	833	ISIM		X	X				X	X	X		X	X	X	X					X			Input - Limits	80	841	ISIL		X	X				X	X	X		X	X	X	X					X			Update	125	728	ISUP		X					X	X	X		X	X	X						X			Update - MVF	140	783	ISUM		X					X	X	X	X	X	X	X						X			Update - Limits	136	779	ISUL		X					X	X	X	X	X	X							X			Input Add	321	1214	ISAD	X	X		X			X	X	X		X	X	X	X					X		X	Input Add - MVF	338	1333	ISAM	X	X		X			X	X	X	X	X	X	X	X					X		X	Update Add	395	1358	ISUA	X	X		X			X	X	X	X	X	X	X						X		X	Update Add - MVF	415	1480	ISBM	X	X		X			X	X	X	X	X	X	X	X					X		X	Input - Variable Limits	105	866	ISIC		X	X				X	X	X	X	X	X	X	X					X			Update - Variable Limits	161	804	ISUC		X					X	X	X	X	X	X							X																																																																																																																																																																																																																																																																																																																																																																																																																																																																																																																																																																																																																																																									
Input Add	286	1394	IRAD	X	X					X	X			X	X	X	X	X	X	X	X	X		X	Input Add - MVF	330	1726	IRAM	X	X					X	X		X	X	X	X	X	X	X	X	X	X	X	X	Update Add	319	1497	IRUA	X	X					X	X	X		X	X	X	X	X	X	X	X	X		X	Update Add - MVF	362	1828	IRBM	X	X					X	X	X	X	X	X	X	X	X	X	X	X	X	X	X	<b>Indexed Sequential</b>																										Input	59	780	ISIP		X	X				X	X			X	X	X	X					X			Input - MVF	72	833	ISIM		X	X				X	X	X		X	X	X	X					X			Input - Limits	80	841	ISIL		X	X				X	X	X		X	X	X	X					X			Update	125	728	ISUP		X					X	X	X		X	X	X						X			Update - MVF	140	783	ISUM		X					X	X	X	X	X	X	X						X			Update - Limits	136	779	ISUL		X					X	X	X	X	X	X							X			Input Add	321	1214	ISAD	X	X		X			X	X	X		X	X	X	X					X		X	Input Add - MVF	338	1333	ISAM	X	X		X			X	X	X	X	X	X	X	X					X		X	Update Add	395	1358	ISUA	X	X		X			X	X	X	X	X	X	X						X		X	Update Add - MVF	415	1480	ISBM	X	X		X			X	X	X	X	X	X	X	X					X		X	Input - Variable Limits	105	866	ISIC		X	X				X	X	X	X	X	X	X	X					X			Update - Variable Limits	161	804	ISUC		X					X	X	X	X	X	X							X																																																																																																																																																																																																																																																																																																																																																																																																																																																																																																																																																																																																																																																																																		
Input Add - MVF	330	1726	IRAM	X	X					X	X		X	X	X	X	X	X	X	X	X	X	X	X	Update Add	319	1497	IRUA	X	X					X	X	X		X	X	X	X	X	X	X	X	X		X	Update Add - MVF	362	1828	IRBM	X	X					X	X	X	X	X	X	X	X	X	X	X	X	X	X	X	<b>Indexed Sequential</b>																										Input	59	780	ISIP		X	X				X	X			X	X	X	X					X			Input - MVF	72	833	ISIM		X	X				X	X	X		X	X	X	X					X			Input - Limits	80	841	ISIL		X	X				X	X	X		X	X	X	X					X			Update	125	728	ISUP		X					X	X	X		X	X	X						X			Update - MVF	140	783	ISUM		X					X	X	X	X	X	X	X						X			Update - Limits	136	779	ISUL		X					X	X	X	X	X	X							X			Input Add	321	1214	ISAD	X	X		X			X	X	X		X	X	X	X					X		X	Input Add - MVF	338	1333	ISAM	X	X		X			X	X	X	X	X	X	X	X					X		X	Update Add	395	1358	ISUA	X	X		X			X	X	X	X	X	X	X						X		X	Update Add - MVF	415	1480	ISBM	X	X		X			X	X	X	X	X	X	X	X					X		X	Input - Variable Limits	105	866	ISIC		X	X				X	X	X	X	X	X	X	X					X			Update - Variable Limits	161	804	ISUC		X					X	X	X	X	X	X							X																																																																																																																																																																																																																																																																																																																																																																																																																																																																																																																																																																																																																																																																																																											
Update Add	319	1497	IRUA	X	X					X	X	X		X	X	X	X	X	X	X	X	X		X	Update Add - MVF	362	1828	IRBM	X	X					X	X	X	X	X	X	X	X	X	X	X	X	X	X	X	<b>Indexed Sequential</b>																										Input	59	780	ISIP		X	X				X	X			X	X	X	X					X			Input - MVF	72	833	ISIM		X	X				X	X	X		X	X	X	X					X			Input - Limits	80	841	ISIL		X	X				X	X	X		X	X	X	X					X			Update	125	728	ISUP		X					X	X	X		X	X	X						X			Update - MVF	140	783	ISUM		X					X	X	X	X	X	X	X						X			Update - Limits	136	779	ISUL		X					X	X	X	X	X	X							X			Input Add	321	1214	ISAD	X	X		X			X	X	X		X	X	X	X					X		X	Input Add - MVF	338	1333	ISAM	X	X		X			X	X	X	X	X	X	X	X					X		X	Update Add	395	1358	ISUA	X	X		X			X	X	X	X	X	X	X						X		X	Update Add - MVF	415	1480	ISBM	X	X		X			X	X	X	X	X	X	X	X					X		X	Input - Variable Limits	105	866	ISIC		X	X				X	X	X	X	X	X	X	X					X			Update - Variable Limits	161	804	ISUC		X					X	X	X	X	X	X							X																																																																																																																																																																																																																																																																																																																																																																																																																																																																																																																																																																																																																																																																																																																																				
Update Add - MVF	362	1828	IRBM	X	X					X	X	X	X	X	X	X	X	X	X	X	X	X	X	X	<b>Indexed Sequential</b>																										Input	59	780	ISIP		X	X				X	X			X	X	X	X					X			Input - MVF	72	833	ISIM		X	X				X	X	X		X	X	X	X					X			Input - Limits	80	841	ISIL		X	X				X	X	X		X	X	X	X					X			Update	125	728	ISUP		X					X	X	X		X	X	X						X			Update - MVF	140	783	ISUM		X					X	X	X	X	X	X	X						X			Update - Limits	136	779	ISUL		X					X	X	X	X	X	X							X			Input Add	321	1214	ISAD	X	X		X			X	X	X		X	X	X	X					X		X	Input Add - MVF	338	1333	ISAM	X	X		X			X	X	X	X	X	X	X	X					X		X	Update Add	395	1358	ISUA	X	X		X			X	X	X	X	X	X	X						X		X	Update Add - MVF	415	1480	ISBM	X	X		X			X	X	X	X	X	X	X	X					X		X	Input - Variable Limits	105	866	ISIC		X	X				X	X	X	X	X	X	X	X					X			Update - Variable Limits	161	804	ISUC		X					X	X	X	X	X	X							X																																																																																																																																																																																																																																																																																																																																																																																																																																																																																																																																																																																																																																																																																																																																																													
<b>Indexed Sequential</b>																										Input	59	780	ISIP		X	X				X	X			X	X	X	X					X			Input - MVF	72	833	ISIM		X	X				X	X	X		X	X	X	X					X			Input - Limits	80	841	ISIL		X	X				X	X	X		X	X	X	X					X			Update	125	728	ISUP		X					X	X	X		X	X	X						X			Update - MVF	140	783	ISUM		X					X	X	X	X	X	X	X						X			Update - Limits	136	779	ISUL		X					X	X	X	X	X	X							X			Input Add	321	1214	ISAD	X	X		X			X	X	X		X	X	X	X					X		X	Input Add - MVF	338	1333	ISAM	X	X		X			X	X	X	X	X	X	X	X					X		X	Update Add	395	1358	ISUA	X	X		X			X	X	X	X	X	X	X						X		X	Update Add - MVF	415	1480	ISBM	X	X		X			X	X	X	X	X	X	X	X					X		X	Input - Variable Limits	105	866	ISIC		X	X				X	X	X	X	X	X	X	X					X			Update - Variable Limits	161	804	ISUC		X					X	X	X	X	X	X							X																																																																																																																																																																																																																																																																																																																																																																																																																																																																																																																																																																																																																																																																																																																																																																																						
Input	59	780	ISIP		X	X				X	X			X	X	X	X					X			Input - MVF	72	833	ISIM		X	X				X	X	X		X	X	X	X					X			Input - Limits	80	841	ISIL		X	X				X	X	X		X	X	X	X					X			Update	125	728	ISUP		X					X	X	X		X	X	X						X			Update - MVF	140	783	ISUM		X					X	X	X	X	X	X	X						X			Update - Limits	136	779	ISUL		X					X	X	X	X	X	X							X			Input Add	321	1214	ISAD	X	X		X			X	X	X		X	X	X	X					X		X	Input Add - MVF	338	1333	ISAM	X	X		X			X	X	X	X	X	X	X	X					X		X	Update Add	395	1358	ISUA	X	X		X			X	X	X	X	X	X	X						X		X	Update Add - MVF	415	1480	ISBM	X	X		X			X	X	X	X	X	X	X	X					X		X	Input - Variable Limits	105	866	ISIC		X	X				X	X	X	X	X	X	X	X					X			Update - Variable Limits	161	804	ISUC		X					X	X	X	X	X	X							X																																																																																																																																																																																																																																																																																																																																																																																																																																																																																																																																																																																																																																																																																																																																																																																																																
Input - MVF	72	833	ISIM		X	X				X	X	X		X	X	X	X					X			Input - Limits	80	841	ISIL		X	X				X	X	X		X	X	X	X					X			Update	125	728	ISUP		X					X	X	X		X	X	X						X			Update - MVF	140	783	ISUM		X					X	X	X	X	X	X	X						X			Update - Limits	136	779	ISUL		X					X	X	X	X	X	X							X			Input Add	321	1214	ISAD	X	X		X			X	X	X		X	X	X	X					X		X	Input Add - MVF	338	1333	ISAM	X	X		X			X	X	X	X	X	X	X	X					X		X	Update Add	395	1358	ISUA	X	X		X			X	X	X	X	X	X	X						X		X	Update Add - MVF	415	1480	ISBM	X	X		X			X	X	X	X	X	X	X	X					X		X	Input - Variable Limits	105	866	ISIC		X	X				X	X	X	X	X	X	X	X					X			Update - Variable Limits	161	804	ISUC		X					X	X	X	X	X	X							X																																																																																																																																																																																																																																																																																																																																																																																																																																																																																																																																																																																																																																																																																																																																																																																																																																									
Input - Limits	80	841	ISIL		X	X				X	X	X		X	X	X	X					X			Update	125	728	ISUP		X					X	X	X		X	X	X						X			Update - MVF	140	783	ISUM		X					X	X	X	X	X	X	X						X			Update - Limits	136	779	ISUL		X					X	X	X	X	X	X							X			Input Add	321	1214	ISAD	X	X		X			X	X	X		X	X	X	X					X		X	Input Add - MVF	338	1333	ISAM	X	X		X			X	X	X	X	X	X	X	X					X		X	Update Add	395	1358	ISUA	X	X		X			X	X	X	X	X	X	X						X		X	Update Add - MVF	415	1480	ISBM	X	X		X			X	X	X	X	X	X	X	X					X		X	Input - Variable Limits	105	866	ISIC		X	X				X	X	X	X	X	X	X	X					X			Update - Variable Limits	161	804	ISUC		X					X	X	X	X	X	X							X																																																																																																																																																																																																																																																																																																																																																																																																																																																																																																																																																																																																																																																																																																																																																																																																																																																																		
Update	125	728	ISUP		X					X	X	X		X	X	X						X			Update - MVF	140	783	ISUM		X					X	X	X	X	X	X	X						X			Update - Limits	136	779	ISUL		X					X	X	X	X	X	X							X			Input Add	321	1214	ISAD	X	X		X			X	X	X		X	X	X	X					X		X	Input Add - MVF	338	1333	ISAM	X	X		X			X	X	X	X	X	X	X	X					X		X	Update Add	395	1358	ISUA	X	X		X			X	X	X	X	X	X	X						X		X	Update Add - MVF	415	1480	ISBM	X	X		X			X	X	X	X	X	X	X	X					X		X	Input - Variable Limits	105	866	ISIC		X	X				X	X	X	X	X	X	X	X					X			Update - Variable Limits	161	804	ISUC		X					X	X	X	X	X	X							X																																																																																																																																																																																																																																																																																																																																																																																																																																																																																																																																																																																																																																																																																																																																																																																																																																																																																											
Update - MVF	140	783	ISUM		X					X	X	X	X	X	X	X						X			Update - Limits	136	779	ISUL		X					X	X	X	X	X	X							X			Input Add	321	1214	ISAD	X	X		X			X	X	X		X	X	X	X					X		X	Input Add - MVF	338	1333	ISAM	X	X		X			X	X	X	X	X	X	X	X					X		X	Update Add	395	1358	ISUA	X	X		X			X	X	X	X	X	X	X						X		X	Update Add - MVF	415	1480	ISBM	X	X		X			X	X	X	X	X	X	X	X					X		X	Input - Variable Limits	105	866	ISIC		X	X				X	X	X	X	X	X	X	X					X			Update - Variable Limits	161	804	ISUC		X					X	X	X	X	X	X							X																																																																																																																																																																																																																																																																																																																																																																																																																																																																																																																																																																																																																																																																																																																																																																																																																																																																																																																				
Update - Limits	136	779	ISUL		X					X	X	X	X	X	X							X			Input Add	321	1214	ISAD	X	X		X			X	X	X		X	X	X	X					X		X	Input Add - MVF	338	1333	ISAM	X	X		X			X	X	X	X	X	X	X	X					X		X	Update Add	395	1358	ISUA	X	X		X			X	X	X	X	X	X	X						X		X	Update Add - MVF	415	1480	ISBM	X	X		X			X	X	X	X	X	X	X	X					X		X	Input - Variable Limits	105	866	ISIC		X	X				X	X	X	X	X	X	X	X					X			Update - Variable Limits	161	804	ISUC		X					X	X	X	X	X	X							X																																																																																																																																																																																																																																																																																																																																																																																																																																																																																																																																																																																																																																																																																																																																																																																																																																																																																																																																													
Input Add	321	1214	ISAD	X	X		X			X	X	X		X	X	X	X					X		X	Input Add - MVF	338	1333	ISAM	X	X		X			X	X	X	X	X	X	X	X					X		X	Update Add	395	1358	ISUA	X	X		X			X	X	X	X	X	X	X						X		X	Update Add - MVF	415	1480	ISBM	X	X		X			X	X	X	X	X	X	X	X					X		X	Input - Variable Limits	105	866	ISIC		X	X				X	X	X	X	X	X	X	X					X			Update - Variable Limits	161	804	ISUC		X					X	X	X	X	X	X							X																																																																																																																																																																																																																																																																																																																																																																																																																																																																																																																																																																																																																																																																																																																																																																																																																																																																																																																																																																						
Input Add - MVF	338	1333	ISAM	X	X		X			X	X	X	X	X	X	X	X					X		X	Update Add	395	1358	ISUA	X	X		X			X	X	X	X	X	X	X						X		X	Update Add - MVF	415	1480	ISBM	X	X		X			X	X	X	X	X	X	X	X					X		X	Input - Variable Limits	105	866	ISIC		X	X				X	X	X	X	X	X	X	X					X			Update - Variable Limits	161	804	ISUC		X					X	X	X	X	X	X							X																																																																																																																																																																																																																																																																																																																																																																																																																																																																																																																																																																																																																																																																																																																																																																																																																																																																																																																																																																																															
Update Add	395	1358	ISUA	X	X		X			X	X	X	X	X	X	X						X		X	Update Add - MVF	415	1480	ISBM	X	X		X			X	X	X	X	X	X	X	X					X		X	Input - Variable Limits	105	866	ISIC		X	X				X	X	X	X	X	X	X	X					X			Update - Variable Limits	161	804	ISUC		X					X	X	X	X	X	X							X																																																																																																																																																																																																																																																																																																																																																																																																																																																																																																																																																																																																																																																																																																																																																																																																																																																																																																																																																																																																																								
Update Add - MVF	415	1480	ISBM	X	X		X			X	X	X	X	X	X	X	X					X		X	Input - Variable Limits	105	866	ISIC		X	X				X	X	X	X	X	X	X	X					X			Update - Variable Limits	161	804	ISUC		X					X	X	X	X	X	X							X																																																																																																																																																																																																																																																																																																																																																																																																																																																																																																																																																																																																																																																																																																																																																																																																																																																																																																																																																																																																																																																	
Input - Variable Limits	105	866	ISIC		X	X				X	X	X	X	X	X	X	X					X			Update - Variable Limits	161	804	ISUC		X					X	X	X	X	X	X							X																																																																																																																																																																																																																																																																																																																																																																																																																																																																																																																																																																																																																																																																																																																																																																																																																																																																																																																																																																																																																																																																										
Update - Variable Limits	161	804	ISUC		X					X	X	X	X	X	X							X																																																																																																																																																																																																																																																																																																																																																																																																																																																																																																																																																																																																																																																																																																																																																																																																																																																																																																																																																																																																																																																																																																			

\*The direct binary access methods use a disk ADDRROUT file to process another disk file. See IBM System/3 Disk Sort Reference Manual, SC21-7522 for a description of ADDRROUT files.



Figure 64. Estimated Main Storage Requirements of Data Management Modules for 5444 Disk with Shared I/O

	Main Routine (Bytes)	Complete Access Method (Bytes)	Module Name (\$\$----)	Subroutines – Name (\$\$----) and Size in Bytes																
				SCBI (174)	SCCB (75)	SCCL (91)	SCDA (151)	SCDF (33)	SCDI (55)	SCIC (70)	SCIF (48)	SCIU (70)	SCLC (28)	SCMI (51)	SCMO (155)	SCSC (50)	SCSI (172)	SCSO (95)	SRTC (21)	SCUA (28)
<b>5444 Shared I/O Access Methods</b>																				
<b>Consecutive</b>																				
Output	22	351	SCCO				X	X					X					X	X	
Input	63	387	SCCI							X	X							X	X	
Update	96	420	SCCU							X	X							X	X	
<b>Direct</b>																				
*Binary Input	68	528	SCBR			X	X		X	X	X							X		
Decimal Input	93	628	SCDR		X	X	X		X	X	X							X		
*Binary Update	94	554	SCBU			X	X		X	X	X							X		
Decimal Update	113	648	SCDU		X	X	X		X	X	X							X		
<b>Indexed</b>																				
Output	82	613	SCIO	X			X	X				X						X	X	X
Output Add	72	934	SCIA	X			X	X				X		X	X	X	X	X	X	
<b>Indexed Random</b>																				
Input	48	621	SCRK					X		X	X	X	X					X		
Update	69	712	SCRU					X	X	X	X	X	X					X		
Input Add	144	1112	SCRA	X			X	X		X	X	X	X	X	X	X	X	X	X	
Update Add	169	1207	SCRB	X			X	X		X	X	X	X	X	X	X	X	X	X	
<b>Indexed Sequential</b>																				
Input	63	488	SCSR				X	X	X		X	X	X					X		
Input – Limits	90	515	SCIL				X	X	X		X	X	X					X		
Update	83	578	SCSU				X	X	X	X	X	X	X					X		
Update – Limits	122	617	SCUL				X	X	X	X	X	X	X					X		
Input Add	166	1033	SCSA	X	X		X	X	X	X	X	X	X					X	X	X
Update Add	192	1129	SCSB	X	X		X	X	X	X	X	X	X					X	X	X

\*The direct binary access methods use a disk ADDRROUT file to process another disk file. See *IBM System/3 Disk Sort Reference Manual*, SC21-7522 for a description of ADDRROUT files.



Figure 62 shows that \$\$CSIP requires 525 bytes of main storage. This total includes the main routine and seven subroutines:

Main routine: \$\$CSIP-	39 bytes
Subroutines: \$\$SRUA-	38 bytes
\$\$SRTC-	28 bytes
\$\$RSRB-	67 bytes
\$\$SRMO-	129 bytes
\$\$SRDI-	56 bytes
\$\$SRBR-	121 bytes
\$\$SRBP-	47 bytes
<hr/>	
Total:	525 bytes

Figure 62 also shows that \$\$CSOP requires eight subroutines, seven of which are already used by \$\$CSIP. Since these subroutines are already used by \$\$CSIP, *they are not duplicated*. Only the main routine, \$\$CSOP (29 bytes) and the additional subroutine, \$\$SRDF (28 bytes), need be included with \$\$CSIP and its subroutines to provide the complete data management for a consecutive input file and a consecutive output file. Thus, the total main storage required for disk data management is 582 bytes (525+29+28).

Suppose, in addition to the two 5444 disk files just described, your program writes fixed length records on a tape file. According to Figure 64, the data management access method \$\$CSOT must be included in your program to support this type of processing. The total size of this access method (main routine plus three subroutines) is 768 bytes. As in disk data management, if two or more tape access methods are used by a program, common subroutines are not duplicated.

Certain 5444 and 5445 disk data management access methods are able to support more than one type of file processing. For example, some multivolume access methods can support either single volume or multivolume files; direct and indexed random access methods that support update files also support input files. Figures 66 and 67 show the relationships among the access methods for 5444 and 5445 disk.

In calculating the main storage requirement for data management, these relationships must be taken into account. For example, if a program consecutively processes two 5444 disk input files, a multivolume sequential input file and a single volume sequential input file, only the multivolume access method (\$\$CSIM) is used for data management support (see Figure 66), since that access method can also support a single volume file.

Access Method	Performs Functions Of
<i>Sequential Files</i>	
\$\$CSOM	\$\$CSOP
\$\$CSIM	\$\$CSIP
\$\$CSUM	\$\$CSUP
<i>Direct Files</i>	
\$\$DAUM	\$\$DAIM, \$\$DAUD, \$\$DAUT, \$\$DAID, \$\$DAIT, \$\$DAUB, \$\$DAIB
\$\$DAIM	\$\$DAID, \$\$DAIT, \$\$DAIB
\$\$DAUD	\$\$DAID, \$\$DAUD, \$\$DAIB
\$\$DAUT	\$\$DAIT, \$\$DAUB, \$\$DAIB
\$\$DAID	\$\$DAIB
\$\$DAIT	\$\$DAIB
\$\$DAUB	\$\$DAIB
<i>Indexed Files (Sequential Processing)</i>	
\$\$ISIL	\$\$ISIP
\$\$ISUL	\$\$ISUP
\$\$ISUA	\$\$ISAD
<i>Indexed Files (Random Processing)</i>	
\$\$IRUA	\$\$IRUP, \$\$IRAD, \$\$IRIP, \$\$IOAD
\$\$IRUP	\$\$IRIP
\$\$IRAD	\$\$IRIP, \$\$IOAD

Figure 66. Relationships Among 5444 Disk Data Management Access Methods



Access Method	Performs Functions Of
<i>Sequential Files</i>	
\$\$CFOM	\$\$CFOP
\$\$CFIM	\$\$CFIP
\$\$CFUM	\$\$CFUP
<i>Direct Files</i>	
\$\$DFUM	\$\$DFIM, \$\$DFUT, \$\$DFUD, \$\$DFID, \$\$DFIT, \$\$DFUB, \$\$DFIB
\$\$DFIM	\$\$DFID, \$\$DFIB, \$\$DFIT
\$\$DFUD	\$\$DFID, \$\$DFIB, \$\$DFUB
\$\$DFUT	\$\$DFIT, \$\$DFUB, \$\$DFIB
\$\$DFID	\$\$DFIB
\$\$DFIT	\$\$DFIB
\$\$DFUT	\$\$DFIB
<i>Indexed Files (Sequential Processing)</i>	
\$\$IHIL	\$\$IHIP
\$\$IHUL	\$\$IHUP
\$\$IHUA	\$\$IHAD
<i>Indexed Files (Random Processing)</i>	
\$\$IGUA	\$\$IGUP, \$\$IGIP, \$\$IGAD, \$\$IFAD
\$\$IGUP	\$\$IGIP
\$\$IGAD	\$\$IGIP, \$\$IFAD

Figure 67. Relationships Among 5445 Disk Data Management Access Methods

As another example, suppose your program adds records randomly to a 5445 indexed file and reads records randomly from a separate 5445 indexed file. If these two types of processing occurred in separate programs, one program would require \$\$IGAD and the other program would require \$\$IGIP. However, since both files are used in the same program, only \$\$IGAD is used, since it also performs the functions of \$\$IGIP.

If your program includes both 5444 and 5445 files, notice that 5445 data management includes two subroutines that are also used for 5444, \$\$SRTC and \$\$SRLP. Therefore, if these subroutines have already been included in the 5444 data management totals, they are not duplicated for 5445.

### Calculating the Total Main Storage Requirement for Data Management

In order to arrive at the total main storage requirement for data management, you must add the total bytes for disk and tape data management to the totals required for the remaining I/O devices in your system which are used by your program, (see Figure 68). The total bytes for disk and tape data management calculated earlier were:

Disk data management — 582 bytes  
Tape data management — 768 bytes

If your program reads cards from the MFCU and prints a report in addition to accessing the disk and tape files described earlier, calculate your total main storage requirement for data management as follows:

Disk data management . . . . . 582 bytes  
Tape data management . . . . . 768 bytes  
MFCU Read (\$\$MFRD) . . . . . 325 bytes  
5203/1403 Print . . . . . 251 bytes

Total data management   
for the program 1926 bytes

### SECONDARY (DISK) STORAGE ESTIMATING

#### Storage Requirements on the Distribution Disk Cartridge

Figure 69 shows the estimated secondary storage requirements of the SCP and program product components on the distribution disk cartridge. The number of modules and sectors required for programs on the distribution pack is often greater than the number of modules and sectors required for the same programs on the generated system pack (see *Estimating Library Requirements on Generated System Packs and Program Packs*, later in this appendix). This difference exists because many of the source library and object library modules which are present on the distribution pack are used only during the system generation process (such as the system generation program and sample programs). Therefore, these programs are not copied to the generated system pack.

Device	Module Name	Bytes (decimal)
1442 Card Read/Punch	\$\$ARFF	493
5471 Printer/Keyboard (console)	\$\$CODM	164
(add for Macros Feature)	\$\$COAM	129
5424 MFCU Read/Punch	\$\$MFRU	372
Read/Print	\$\$MFRP	441
Read Only	\$\$MFRD	325
Punch Only	\$\$MFPU	452
Print Only	\$\$MFPR	266
Print/Punch	\$\$MFPP	316
Full Function	\$\$MFFF	487
5203/1403 Printer	\$\$LPRT	251

Figure 68. Main Storage Requirements for Other Data Management and IOS

For example, suppose you have received the base SCP (5702-SC1 with no features) and RPG II (5702-RG1). You can calculate the secondary storage requirement of the distribution disk cartridge as follows:

- Using Figure 69, determine the number of directory entries and sectors required for the source and object libraries.

	Base SCP	RPG II	Total
Object library directory entries	444	147	591
Object library sectors	1935	1262	3197
Source library directory entries	40	9	49
Source library sectors	128	23	151

- Convert these totals to tracks for the object library.

Note:  $\lceil \quad \rceil$  means the resulting quantity should be rounded upward to the next whole number.

Number of directory tracks:

$$\left\lceil \frac{591 \text{ entries}}{288 \text{ entries/track}} \right\rceil = 3 \text{ tracks}$$

(287 on the last track)

Total tracks for object library and directory:

$$\left\lceil \frac{3197 \text{ sectors}}{24 \text{ sectors/track}} \right\rceil + 3 \text{ tracks for directory} = 137 \text{ tracks}$$

- Convert these totals to tracks for the source library.

Number of directory sectors (minimum of 2 sectors):

$$\left\lceil \frac{49 \text{ entries}}{19 \text{ entries/sector}} \right\rceil = 3 \text{ sectors}$$

Total sectors for source library and directory:

$$151 \text{ sectors library} + 3 \text{ sectors directory} = 154 \text{ sectors}$$

Total tracks:

$$\left\lceil \frac{154 \text{ sectors}}{24 \text{ sectors/track}} \right\rceil = 7 \text{ tracks}$$

- Find the total number of tracks required on the distribution disk cartridge by the programs you have ordered:

	Tracks
Object library directory	3
Object library and directory	137
Source library and directory	7
Scheduler work area (always required)	2
Cylinder zero (always reserved for system use)	2
<b>Total</b>	<b>151</b>

Order and Feature Number	Program Component	Object Library		Source Library	
		Directory Entries	Sectors	Directory Entries	Sectors
<i>System Control Programming and Features</i>					
5702-SC1	Base SCP	449	1962*	41	164**
(6004/6006)	Remote Job Entry Feature	19	66		
(6020/6021)	Macros Feature	10	74	41	267
(6022/6023)	5445 Feature	148	558		
(6026/6027)	Overlay Linkage Editor and Checkpoint/Restart Feature	22	235		
(6030/6031)	ML/MP Feature	21	85	13	159
(6024/6025)	Magnetic Tape Feature	46	162		
(6032/6033)	CCP	Information not yet available.			
<i>Program Products and Features</i>					
5702-RG1	Disk RPG II	147	1266	9	23
(6000/6002)	RPG II BSCA Feature	9	33	1	1
(6012/6014)	RPG II 5445 Feature	1	7	1	1
(6028/6029)	RPG II Auto Report Feature	17	183	9	30
(6016/6018)	RPG II Tape Features	1	4	1	1
5702-CB1	Subset ANS COBOL	60	721	3	20
5702-FO1	Disk FORTRAN IV	226	854	8	51
5702-AS1	Basic Assembler Program	13	145	2	11
5702-SM1	Disk Sort	46	296	5	6
(6008/6010)	Disk Sort 5445 Feature	4	11	1	1
5702-SM2	Disk Resident Tape Sort	30	233	1	1
5702-UT1	Disk Resident Card Utilities	11	164	2	11
5702-UT2	1255 Utility	6	79	1	1
5702-UT3	1270/1255 Utility	6	81	1	1
<i>Programming Support for Hardware RPG</i>					
5799-WAU	Multiple Line Terminal Adapter (MLTA) Feature	42	119	25	213
* Includes a 120-sector work space used by the system generation program.					
** Includes a 30-sector work space used by the system generation program.					

● Figure 69. Disk Storage Requirements of Program Components on the Distribution Disk Cartridge

In this example, the features ordered for the system easily fit onto either a half-capacity disk (200 tracks) or a full-capacity disk (400 tracks). If several large SCP programs and program products are ordered, however, the storage requirement of the system can exceed the capacity of a single half-capacity disk cartridge.

#### **Determining Library Requirements on Generated System Packs and Program Packs**

This topic provides you with the information you need to estimate the disk space requirements of generated SCP programs and program products, and provides the COPY statement and DELETE statement parameters you will need to transfer your programs from one pack to another or delete them from a pack. (*See Tailoring System or Program Packs for Unique Requirements* later in this section for COPY and DELETE statement models.)

You may need this information for several reasons. Perhaps you need to know the disk storage requirements of the SCP programs and program products so that you can determine the adequacy of the library allocations during system generation and modify those allocations if necessary. You might need to determine library size requirements on separate system packs you are creating or on program packs you are building for certain program products. Perhaps you want to calculate the amount of file space which will be available on a pack that contains one or more of your system programs.

Figures 70 and 71 list the library space requirements and the COPY/DELETE parameters for selected SCP programs and data management modules and for all program products. The library space requirements reflect the latest estimates for these programs.

Program	COPY/DELETE Parameters		Object Library		Source Library		Notes
	LIBRARY-	NAME-	Directory	Sectors	Directory	Sectors	
			Entries		Entries		
<i>Minimum SCP<sup>1</sup></i>	O	SYSTEM <sup>1</sup>					
* <i>Always included</i>			138	516 <sup>2</sup>	—	—	1 Minimum SCP includes all LIBRARY-0 modules that begin with the characters \$\$\$. This includes the additional modules for each <i>Option</i> listed. Do not delete these modules.
<i>Options</i>							
* DPF			2	5	—	—	2 This quantity includes only the minimum supervisor (13 sectors).
5445 Disk			56	214	—	—	
Magnetic Tape			20	75	—	—	3 These modules are included if either the MFCU or the 1442 or both are selected.
5445 or Magnetic Tape			—	13	—	—	
* MFCU or 1442 <sup>3</sup>			2	5	—	—	4 This module is included if Inquiry and Magnetic Tape are both selected.
* MFCU			5	16	—	—	
* 1442			2	6	—	—	5 COPY/DELETE parameters apply to both the SCP base modules and the 5445 modules (if present).
* 5471 Printer/Keyboard			5	15	—	—	
* Inquiry			6	22	—	—	* = Part of Base SCP (5702-SC1)
Inquiry and Magnetic Tape <sup>4</sup>			1	3	—	—	
Checkpoint/Restart			6	37	—	—	
* BSCA			12	42	—	—	
Remote Job Entry			19	66	—	—	
ML/MP			13	49	—	—	
MLTA (RPQ)			19	44	—	—	
<i>Other SCP</i>							
* Alternate Track Assignment <sup>5</sup>	O	\$AL.ALL	6	42	—	—	
Add for 5445 Feature			6	32	—	—	
* Alternate Track Rebuild <sup>5</sup>	O	\$BU.ALL	3	19	—	—	
Add for 5445 Feature			1	3	—	—	
* Disk Copy/Dump <sup>5</sup>	O	\$CO.ALL	23	143	—	—	
Add for 5445 Feature			15	104	—	—	
* File Delete <sup>5</sup>	O	\$DE.ALL	3	25	—	—	
Add for 5445 Feature			1	12	—	—	
* Disk Initialization <sup>5</sup>	O	\$IN.ALL	5	39	—	—	
Add for 5445 Feature			4	25	—	—	
* File and Volume Label Display <sup>5</sup>	O	\$LA.ALL	3	25	—	—	
Add For 5445 Feature			2	19	—	—	

● Figure 70 (Part 1 of 4) Library Requirements and COPY/DELETE Parameters for SCP Programs

Program	COPY/DELETE Parameters		Object Library		Source Library		Notes
	LIBRARY-	NAME-	Directory	Sectors	Directory	Sectors	
			Entries		Entries		
* Library Maintenance	O	\$MA.ALL	35	204	-	-	6 Sector and directory entry counts include the macro processor and all macros; the COPY/DELETE parameters apply only to the macro processor. The source library names of the individual macros are: \$ALOC \$FTCH \$PUTT \$CHK \$FIND \$RDD \$CKL \$GETD \$RDT \$CLOS \$GETT \$SNAP \$COMN \$GPU \$SVC \$CTLT \$IOBD \$STRAN \$DTFD \$IOED \$TRL \$DTFT \$LOAD \$WAIT \$DTFU \$OPEN \$WRDT \$DTOD \$PKBU \$WRTT \$DTOT \$PRNT \$WTT \$DOU \$PUTD \$XCTL \$EOJ
* World Trade Date Utility	O	\$WDATE	1	8	-	-	
5445 Data Interchange Utility	O	\$VT.ALL	3	27	-	-	
* Linkage Editor (see note under RPG II in the next figure)	O	\$LI.ALL	12	64	-	-	
Overlay Linkage Editor (see note under COBOL/FORTRAN IV/assembler in the next figure)	O	\$OL.ALL	15	199	-	-	
Tape Initialization	O	\$TI.ALL	2	20	-	-	
Magnetic Tape Error Summary Utility	O	\$TVES	1	9	-	-	
System Generation	O P	\$SG.ALL \$SG.ALL	2	2	3	3	
Macros Feature <sup>6</sup>	O R R R R	\$MP.ALL \$COAM <sup>7</sup> \$BMCC <sup>7</sup> \$BMCH <sup>7</sup> \$BMDP <sup>7</sup>	5	58	38	256	
MLTA (Multiple Line Terminal Adapter) RPQ <sup>8</sup>	O O R	\$MLMC1 \$ML.ALL <sup>9</sup> \$ML.ALL <sup>7</sup>	1	10	22	205	
ML/MP (Multiline/Multipoint) Feature <sup>10</sup>	O R	\$BS.ALL <sup>9</sup> \$BS.ALL <sup>7</sup>	-	-	13	159	

7 Directory entries and sectors are counted under data management.

8 The source library names of the individual macros are:

9 Directory entries and sectors are counted under *Minimum SCP Options*.

\* = Part of Base SCP(5702-SC1)

● Figure 70 (Part 2 of 4) Library Requirements and COPY/DELETE Parameters for SCP Programs

Program	COPY/DELETE Parameters		Object Library		Source Library		Notes
	LIBRARY-	NAME-	Directory	Sectors	Directory	Sectors	
			Entries		Entries		
<i>Disk Data Management and Subroutines</i>							
* 5444 Disk Data Management <sup>11</sup>							10 The source library names of the individual macros are: \$BCPL \$CANB \$GETB \$PUTB \$DFOB \$DTFB \$POLB \$RFT
Consecutive	R	\$\$CSIM \$\$CSIP \$\$CSOM \$\$CSOP \$\$CSUM \$\$CSUP	6	8	-	-	
Direct	R	\$\$DA.ALL	8	17	-	-	11 See table under Data Management Estimates in this appendix for the individual access method names and subroutine names.
Indexed Output	R	\$\$IO.ALL	4	9	-	-	
Indexed Random	R	\$\$IR.ALL	8	22	-	-	
Indexed Sequential	R	\$\$IS.ALL	12	30	-	-	12 These modules are included only if the corresponding option is selected at system generation time. See the list of options under <i>Minimum SCP</i> in this figure.
5444 Subroutines	R	\$\$SR.ALL	24	33	-	-	
Shared I/O <sup>11</sup>	R	\$\$SC.ALL	37	69	-	-	13 See figure entitled "Data Management Main Storage Requirement for Card Devices and Printer/Keyboard" earlier in this appendix for a list of the individual MFCU module names.
<i>5445 Disk Data Management<sup>11</sup></i>							
Consecutive	R	\$\$CF.ALL	6	8	-	-	
Direct	R	\$\$DF.ALL	8	17	-	-	
Indexed Output	R	\$\$IF.ALL	4	9	-	-	
Indexed Random	R	\$\$IG.ALL	8	22	-	-	
Indexed Sequential	R	\$\$IH.ALL	12	31	-	-	
5445 Subroutines	R	\$\$SF.ALL	22	36	-	-	
<i>Other Data Management and Subroutines</i>							
* 5203/1403 Printer Data Management and IOS	R	\$\$LPRT	1	2	-	-	
* MFCU Data Management and IOS <sup>12</sup>	R	\$\$MF.ALL <sup>13</sup>	7	17	-	-	
* 1442 Card Read/Punch Data Management and IOS <sup>12</sup>	R	\$\$ARFF	1	3	-	-	
* 5471 Printer/Keyboard Data Management and Interrupt Handler <sup>12</sup>	R	\$\$CO.ALL	1	2	-	-	
Add for Macros Feature			1	2	-	-	
* BSCA IOS <sup>12</sup>	R	\$\$BS.ALL	9	82	-	-	
Add for BSCA Line 2 or MLMP			-	3	-	-	
* = Part of Base SCP (5702-SC1)							

Figure 70 (Part 3 of 4). Library Requirements and COPY/DELETE Parameters for SCP Programs

Program	COPY/DELETE		Object Library		Source Library		Notes
	Parameters		Directory	Sector	Directory	Sector	
	LIBRARY-	NAME-	Entries		Entries		
Add for MLMP			3	24	-	-	14 See figure entitled "Estimated Main Storage Requirements of 3410/3411 Magnetic Tape Units Data Management" under <i>Data Management Estimates</i> , earlier in this appendix, for a list of individual modules and subroutines.
MLTA or MLMP	R	\$\$BM.ALL	3	12	-	-	
Magnetic Tape Data Management 12							
Variable/fixed 14	R	\$\$CV.ALL	4	12	-	-	15 Planned for FORTRAN IV only.
Fixed 14	R	\$\$CSIA	4	10	-	-	
	R	\$\$CSIT					
	R	\$\$CSOA					
	R	\$\$CSOT					
Magnetic Tape Sub-routines 14	R	\$\$TS.ALL	13	30	-	-	
MLTA (RPQ) IOS 12	R	\$\$ML.ALL	22	65	-	-	
Basic Tape Data Management 15	R	\$\$BTAM	1	3	-	-	
* = Part of Base SCP(5702-SC1)							

Figure 70 (Part 4 of 4) Library Requirements and COPY/DELETE Parameters for SCP Programs



Program	COPY/DELETE Parameters		Object Library		Source Library		Notes
	LIBRARY-	NAME-	Directory	Sectors	Directory	Sectors	
			Entries		Entries		
RPG II <sup>1</sup>	R	SUBR95	147	1266	1	1	1 To copy RPG II (including the 5445 feature, magnetic tape feature, and BSCA feature, if present), copy also the linkage editor (\$LI.ALL). To delete RPG II, delete only \$RP.ALL, \$\$PG.ALL, and RPG. The Auto Report Feature must be copied or deleted separately.
	O	\$RP.ALL					
	R	\$\$PG.ALL					
	P	RPG					
Add for 5445 Feature			1	7	-	-	
Add for Magnetic Tape Feature			1	4	-	-	
Add for BSCA Feature			9	33	-	-	
Add for Auto Report Feature <sup>1</sup>	O	\$AU.ALL	17	183	1	1	2 To copy, copy also the overlay linkage editor (\$OL.ALL); to delete, delete only the program product.
	P	AUTO					
Subset ANS COBOL <sup>2</sup>	O	\$CB.ALL	60	721	1	1	3 The object library names of the individual subroutines are:
	P	COBOL					
	P	\$CB.ALL					
Disk FORTRAN IV <sup>2</sup>	O	\$FO.ALL	226	854	1	1	ADD DECA1 DUMP ALOG DEXP DUNPK ALOG10 DIV DVCHK ATAN DLOG EDIT A1DEC DLOG10 EXIT BUG DMOD EXP COS DPACK FCTST DATAN DSIN FILL DATSW DSQRT GET DCOS DTANH ICOMP
	P	FORTRN					
	R	\$FO.ALL <sup>3</sup>					
Basic Assembler Program <sup>2</sup>	O	\$AS.ALL	13	145	-	-	
Disk Sort	O	\$DS.ALL	41	265	-	-	
Add for 5445 Feature			4	11	-	-	
Add for Magnetic Tape Support			4	21	-	-	INQCHK PRINT SPACE KEYBD PUNCH SP1403 LCOMP PUT SQRT MOVE P1403 STACK MPY READ SUB
Disk Resident Tape Sort	O	\$TS.ALL	30	233	-	-	NCOMP SETINQ S1403 NSIGN SIN TANH NZONE SKIP TYPER OVERFL SLITE UNPAC PACK SLITET WHOLE PDUMP
Disk Resident Card Utilities							
96 List	O	\$CLIST	1	11	-	-	
80-96 Conversion	O	\$CNVRT	1	23	-	-	
MFCU Sort/Collate	O	\$CS.ALL	6	71	-	-	4 Includes the 5445 feature and/or Tape I/O option, if present.
Data Recording	O	\$DREC	1	21	-	-	Note: All data management and data management subroutines to be used during assembly and/or compilation must be on the same pack as the assembler or compiler.
Data Verifying	O	\$DVER	1	23	-	-	
96-96 Reproduce and Interpret	O	\$REPRO	1	15	-	-	
1255 Magnetic Character Reader Utility	O	\$MI.ALL	6	79	-	-	
1270/1255 Utility	O	\$MO.ALL	6	81	-	-	

● Figure 71. Library Requirements and COPY/DELETE Parameters for Program Products

### *Changing the Default Library Allocations*

When halt 91 is issued during system generation, the following message is given (see *Chapter 12. System Generation* for an example of SCP generation):

THE ALLOCATION FOR THE OBJECT LIBRARY IS  
170 TRACKS, FOR THE SOURCE LIBRARY 5 TRACKS,  
AND FOR THE OBJECT LIBRARY DIRECTORY  
4 TRACKS. YOU SHOULD DETERMINE THE ADE-  
QUACY OF THESE ALLOCATIONS AND, IF NECES-  
SARY, ALTER THE ALLOCATE CONTROL STATE-  
MENT WHICH FOLLOWS IN THE READER.

This halt allows you to change the default allocations. You may want to change the allocations for two reasons:

1. If the system you generate fills or nearly fills the libraries, you must reallocate at the completion of system generation before you can add your own programs to the libraries.

2. If you have ordered the SCP including all of its features and several of the larger program products or features, the required object library allocation may be in excess of 200 tracks. If you allow system generation to continue with the default object library allocation of 170 tracks, a halt of 68 is displayed on the message display unit. This halt indicates that the library is full. If a halt 68 occurs, you should take option 3, check your allocation, and repeat the system generation procedure.

The following example uses Figures 70 and 71 to estimate a library allocation. Suppose you wish to generate the Base SCP (5702-SC1), RPG II, and Disk Sort. Assume that you have the following devices: MFCU, 5203 printer, 5471 printer/keyboard, and 5444 disk; you want no other SCP or program product options or features. You can calculate library requirements for these programs as follows:

1. Determine the number of directory entries and sectors required for the source and object libraries.

	<i>Object Library Directory</i>		<i>Source Library Directory</i>	
	<i>Entries</i>	<i>Sectors</i>	<i>Entries</i>	<i>Sectors</i>
<i>SCP (from Figure 70)</i>				
Minimum SCP				
Always included	138	513	--	--
Options				
MFCU or 1442	2	5	--	--
MFCU	5	16	--	--
5471 printer/keyboard	5	15	--	--
Other SCP (9 programs)	89	554	--	--
Disk Data Management and Subroutines				
5444 Disk	99	187	--	--
Other Data Management and Subroutines				
5203 printer	1	2	--	--
MFCU	7	17	--	--
5471	1	2	--	--
<i>Total SCP</i>	<u>347</u>	<u>1311</u>	--	--

*Program Products (from Figure 71)*

RPG II	147	1262	1	1
Disk Sort	41	256	--	--
<i>Total Program Products</i>	<u>188</u>	<u>1518</u>	<u>1</u>	<u>1</u>
<i>Total SCP and Program Products</i>	535	2829	1	1

2. Convert these totals to tracks (to be used as ALLOCATE statement parameters) for the object library.

Note:  $\left\{ \left\{ \right. \right\}$  means the resulting quantity should be rounded upward to the next whole number.

*Number of directory tracks (DIRSIZE parameter):*

$$\left\{ \frac{535 \text{ entries}}{288 \text{ entries/track}} \right\} = 2 \text{ tracks}$$

(287 on the last track)

See IBM System/3 Model 10 Disk System Control Programming Reference Manual, GC21-7512, for default values when the DIRSIZE parameter is omitted.

*Total tracks for object library and directory (OBJECT parameter):*

$$\left\{ \frac{2829 \text{ sectors}}{24 \text{ sectors/tracks}} \right\} + 2 \text{ tracks for directory} = 120 \text{ tracks}$$

3. Convert these totals to tracks (to be used as SOURCE parameter to ALLOCATE statement for the source library).

*Number of directory sectors (minimum of 2 sectors):*

$$\left\{ \frac{1 \text{ entry}}{19 \text{ entries/sector}} \right\} = 1 \text{ sector (must use the 2-sector minimum, in this case)}$$

*Total sectors for source library and directory:*

2 sectors directory  
1 sector library  
 3 total sectors

*Total tracks:*

$$\left\{ \frac{3 \text{ sectors}}{24 \text{ sectors/track}} \right\} = 1 \text{ track}$$

4. Use the results of these calculations to code the ALLOCATE statement.

// ALLOCATE TO-F1,OBJECT-120,SOURCE-1,  
 SYSTEM-YES,DIRSIZE-2

In this case, the default allocations could have been reduced. In order to add user programs and to provide adequate library space on the system pack for the maintenance of these programs, you should increase these allocations beyond those necessary to complete system generation. For example:

// ALLOCATE TO-F1,OBJECT-150,SOURCE-3,  
 SYSTEM-YES,DIRSIZE-3

*Note:* If the total number of tracks required for your system plus program products is in excess of your disk capacity, you must generate two system packs (see *Generating Two System Packs*).

If Inquiry and/or Checkpoint/Restart are selected during system generation, the size of the scheduler work area varies with the size of main storage and whether the system is dedicated or DPF:

Main Storage Bytes	Scheduler Work Area with Inquiry and/or Checkpoint/Restart		Scheduler Work Area without Inquiry and/or Checkpoint/Restart	
	Dedicated	DPF	Dedicated	DPF
12K (12,228 bytes)	6	8	2	4
16K (16,384 bytes)	7	9	2	4
24K (24,576 bytes)	8	10	2	4
32K (32,768 bytes)	10	12	2	4
48K (49,152 bytes)	12	14	2	4
64K (65,536 bytes)	15	17	2	4

Figure 72. Determining the Number of Tracks Required for the Scheduler Work Area

### Determining File Space

You can determine how much file space is available on your system pack by subtracting the number of tracks you have allocated for the source and object libraries, scheduler work area (see Figure 72), and the constant 2 (cylinder 0, reserved for system use) from the number of tracks you have on your disk (200 tracks for half-capacity, 400 tracks for full-capacity). For example:

153 tracks for the source and object libraries  
+2 tracks for the minimum scheduler work area  
+2 tracks used by the system on all packs

---

157 tracks total

This leaves 43 tracks for files on a half-capacity system.

### Generating Two System Packs

You must generate two system packs if the total number of tracks required for your system and program products is greater than your disk capacity. Before you generate your system packs, you must first determine which program products are desired on each system pack. Place the program products you frequently use on one system pack and place the remaining program products on the other system pack. To generate your system packs, use the following procedure:

1. Establish your allocation requirements for each pack (see *Changing the Default Library Allocations*).
2. Complete SCP generation and installation verification using the larger of the two allocations.
3. Remove the distribution cartridge and build a backup pack of F1 by copying F1 to an initialized scratch pack on R1. Remove R1 and label it System Pack 1.
4. Mount the distribution pack containing the program products desired and call the appropriate procedures (see Figure 47) to build on F1 those program products you desire on System Pack 2. (Use the procedure for program product generation.)
5. Remove the distribution cartridge and copy F1 to an initialized scratch pack on R1. Label this System Pack 2.
6. Remove this pack from R1 and mount System Pack 1.
7. Initialize F1 and copy R1 to F1.
8. Repeat step 4 for the remaining program products which you desire on System Pack 1.
9. Place System Pack 1 on R1, initialize R1, and copy F1 to R1.

You now have your full system support on the two packs. These are your backup system packs. You may now continue with the procedures under *Completing System Generation and Installation Verification*, in Chapter 12. *System Generation*.

### Tailoring System or Program Packs for Unique Requirements

Any time after system generation, you may add programs or procedures to your libraries or delete library members which are not needed. The following list of reasons for adding to or deleting from your libraries after system generation is provided as a sample; your unique situation may suggest many other possibilities:

- Delete the World Trade Date (\$WDATE) Utility if you do not need it.
- If you have magnetic tape, but no variable length record tape files, you may want to delete that part of the tape data management.
- 5445 disk users may want to delete the 5445 Data Interchange Utility if they do not need data interchange with an IBM System/360 or System/370.
- You may want to delete utility programs that are seldom used.
- You may want to delete data management modules that are not needed. For example, if you have no multi-volume files, you can delete all of the multivolume data management modules; or, if you have no direct files, you can delete the data management for those files. To delete specific data management modules, use the module names given in the section entitled *Data Management Estimates*.

Procedures for creating minimal systems and program packs and deleting unwanted modules from your libraries are given in Chapter 12. *System Generation*.

The following model COPY and DELETE statements show how Figures 70 and 71 are used to obtain the LIBRARY and NAME parameters needed to copy or delete individual SCP programs, program products, and features:

1 4 8 12 16 20 24 28 32 36 40 44 48 52 56 60 64 68 72

// COPY FROM  $\left. \begin{matrix} (R1) \\ F1 \end{matrix} \right\}$  TO  $\left. \begin{matrix} (R1) \\ F1 \end{matrix} \right\}$  RETAIN-R, LIBRARY-  $\left. \begin{matrix} \text{Obtain from} \\ \text{Figure 70 or 71} \end{matrix} \right\}$  , NAME-  $\left. \begin{matrix} \text{Obtain from} \\ \text{Figure 70 or 71} \end{matrix} \right\}$   
 $\left. \begin{matrix} (R2) \\ F2 \end{matrix} \right\}$   $\left. \begin{matrix} (R2) \\ F2 \end{matrix} \right\}$

// DELETE FROM  $\left. \begin{matrix} (R1) \\ F1 \end{matrix} \right\}$  RETAIN-P, LIBRARY-  $\left. \begin{matrix} \text{Obtain from} \\ \text{Figure 70 or 71} \end{matrix} \right\}$  , NAME-  $\left. \begin{matrix} \text{Obtain from} \\ \text{Figure 70 or 71} \end{matrix} \right\}$   
 $\left. \begin{matrix} (R2) \\ F2 \end{matrix} \right\}$

## Appendix F: Procedures for Applying Program Temporary Fixes

### Considerations Before Applying PTFs

Sometimes it is necessary to modify programs between normal maintenance releases of the system. Such program modifications are made available in the form of PTFs (Program Temporary Fixes). PTFs are applied to programs residing in the object library (on F1) by using the Field Engineering Maintenance program (\$SGPTF).

Perform the following before applying the PTFs.

1. Ensure that the system containing the Library Maintenance program (\$MAINT) and the programs or modules to which PTFs are to be applied resides on F1.
2. Examine the comment cards in each PTF deck to make certain that this is the required PTF.

### Applying the PTF

1. Mount the user distribution disk cartridge (PID pack) on R1. This pack contains the Field Engineering Maintenance program (\$SGPTF).
2. Perform the IPL procedure from disk F1. Include the DATE statement at IPL time.
3. Clear the reader primary hopper of cards and place the PTF deck into the reader primary hopper. The PTF deck contains the information to be inserted into a module or the replacement for a module. The PTF deck also includes the // LOAD and // RUN cards necessary to apply the information to the module(s) on F1.

4. Press reader START.
5. Press console START (or appropriate HALT/RESET key if you have DPF).

The PTFs are applied to the programs on F1; the procedure is complete when EJ is displayed in the message display unit. You can now copy the maintained programs on F1 to R1.

*Note:* If you are applying a complete module replacement PTF you must use Library Maintenance (\$MAINT). The procedures for applying the PTF are the same as the preceding procedures except that you cannot IPL from the same pack containing \$MAINT. For further information on \$MAINT see *IBM System/3 Model 10 Disk System Operation Control Language and Disk Utilities Reference Manual*, GC21-7512.





## Index

- A light 18
- ACU PWR OFF light 16
- ADDR INCREM switch 12
- ADDRESS COMPARE
  - light 12
  - switch 12
- ADDRESS/DATA switches 11
- Assembler Program 149
  
- B light 18
- Basic Assembler Program
  - object execution 150
  - source execution 149
- Binary Synchronous Communications Adapter panel
  - lights
    - ACU PWR OFF 16
    - BSCA ATTN 15
    - BUSY 16
    - CALL REQUEST 16
    - CHAR PHASE 16
    - CLEAR TO SEND 16
    - CONTROL MODE 16
    - DATA MODE 16
    - DIGIT PRESENT 16
    - DT LINE IN USE 16
    - DT SET READY 15
    - DT TERM READY 15
    - EXT TEST SW 15
    - RECEIVE INITIAL 16
    - RECEIVE MODE 16
    - RECEIVE TRIGGER 16
    - TEST MODE 15
    - TSM MODE 15
    - TSM TRIGGER 16
    - UNIT CHECK 16
  - switch
    - RATE SELECT 16
- BSCA ATTN light 15
- BSCA LOCAL TEST switch 12
- BSCA panel 15
- BSCA statement 121
- BSCA STEP key 12
- building a program pack 201
- BUSY light 16
  
- CALL REQUEST light 16
- CALL statement 121
- CANCEL key 89
- canceling jobs, DPF 117
- card feed path
  - MFCU 19
  - 1442 100
- card jam
  - MFCU
    - clearing 19
    - indicators 19
  - 1442
    - clearing 100
    - indicators 98
- card utilities 133
- carriage clutch 39
- CARRIAGE RESTORE key 33
- CARRIAGE SPACE key 33
- CE control panel 12, 13
- CE KEY switch 12
- CE mode selector 13
- chain cartridge
  - installing 48-character 54
  - installing 60-character 56
  - removal 50
- chain image data cards 212
- chain interlock 33, 111
- CHAR PHASE light 16
- CHECK light
  - printer 33
  - 1442 99
- Checkpoint/Restart programs
  - checkpoint accepted 156
  - removing cards 156
  - restarting a checkpointed program 156
- CHECK RESET key 12
- CHIP BOX light 99
- CHIP light 18
- chip box, emptying 30
- chute interlock 33, 111
- cleaning tape head 67
- CLEAR TO SEND light 16
- clearing
  - cards from MFCU 106
  - I/O ATTENTION 110
  - MFCU card jam 19
  - 1442 card jam 100
- CLOCK lights 11
- compilation procedures 122
- COMPILE statement 121
- completing system generation using MFCU or 1442
  - building a minimal system 199
  - copying tailored system 196.1
  - example printout 200
- completing system generation using printer-keyboard 206
- configuration statements, system generation 172-177
- Console Error Log Sheet 110, 114
- console, processing unit 8
- CONTROL MODE light 16
- controls
  - customer engineer (CE) 12, 13
  - dual program 14
  - emergency power off 10
  - MFCU 18
  - printer 32
  - printer-keyboard 89
  - processing unit 8, 11
  - system 9
  - tape 62
  - 1442 98
  - 5444 disk 13
  - 5445 disk 80

- core storage dump
  - considerations 115
  - procedures 115
  - reasons for taking 115
- corner station, removing cards 22
- customer engineer control panel 12, 13
- CVR light 18
- cycle control display 11
  
- data cards, chain image 212
- DATA MODE light 16
- data switches 11
- Data Recording Program 145
- Data Verifying Program 146
- DATE statement 120
- Device Counter Logout program
  - counters 132
  - operating procedures 131
- diagnostics only run, RPG II 122
- DIGIT PRESENT light 16
- disk
  - panel 13
  - using two 265
- Disk Copy/Dump Program, procedures 152
- Disk Sort Program 146
- Disk Utility Programs
  - description 151
  - procedures 151
- DPF 14
- DT LINE IN USE light 16
- DT SET READY light 15
- DT TERM READY light 15
- dual program control panel 14
- dual program control switch 14
- dual program feature 14
- dual program operation
  - canceling jobs 117
  - loading jobs 116
- dummy tractors 35
  
- emergency power off and meter panel 10
- emergency pull switch 10
- END key 89
- EOT marker 66
- error log sheet 110, 114
- executing I-type programs, RPG II 126
- EXT TEST SW light 15
  
- fabric ribbon cartridge
  - installing 93
  - removing 92
- FEED CLU light 91
- FILE PROTECT light 62
- FILE statement 121
- FILE WRITE switch 12
- FORMS light 33
- forms, printer
  - lateral adjustment 40
  - loading 34
  - print density 38
  - stacker 43
  - vertical adjustment 39

- forms, printer-keyboard
  - loading 95
- FORMS statement 121
  
- halt indicator 9, 14
- HALT/RESET key 14
- HALT statement 121
- handling tapes 68
- hopper station, removing cards
  - MFCU 20
  - 1442 100
- HOPR light 99
- HPR light 18
  
- IMAGE statement 121, 209
- impression selector, adjusting 91
- indicators
  - MFCU 18
  - printer 32
  - printer-keyboard 89
  - processing 8
  - tape 62
  - test 11
  - 1442 98
- initial program load 106
- initiating IPL from MFCU 110
- INT LEV light 11
- INTERLOCK light 33
- interpret 137
- INTERRUPT key/light 15
- IPL 106
- IPL process 106
- I/O ATTENTION
  - light 9
  - not ready 9, 110
- I/O CHECK
  - light 12
  - switch 12
- I/O OVERLAP switch 12
  
- key
  - CANCEL 89
  - CARRIAGE RESTORE 33
  - CARRIAGE SPACE 33
  - CHECK RESET 12
  - END 89
  - HALT/RESET 14
  - INTERRUPT 15
  - LAMP TEST 11, 18
  - LOAD REWIND 62
  - LOCK 89
  - NPRO
    - MFCU 18
    - 1442 98
  - PROGRAM LOAD 9
  - REQ 89
  - RESET 62
  - RETURN 89
  - SHIFT 89
  - SPACE 89

key (continued)

START

MFCU 18  
printer 33  
processing unit 9  
tape 62  
1442 98

STOP

MFCU 18  
printer 33  
processing unit 9  
1442 98

SYSTEM RESET 12

UNLOAD REWIND 62

keyboard 89

lamps

MFCU 18  
printer 33  
printer-keyboard 88  
processing unit 8  
test 11

LAMP TEST key 11, 18

lateral adjustment, printer 40

library maintenance, procedures 153

light

ACU PWR OFF 16  
BCSA ATTN 15  
BUSY 16  
CALL REQUEST 16  
CHAR PHASE 16  
CHECK  
printer 33  
1442 99

CHIP 18

CHIP BOX 99

CLEAR TO SEND 16

CLOCK 11

CONTROL MODE 16

CVR 18

DATA MODE 16

DIGIT PRESENT 16

DT LINE IN USE 16

DT SET READY 15

DT TERM READY 15

EXT TEST SW 15

FEED CLU 99

FILE PROTECT 62

FORMS 33

HOPR 99

HPR 18

INT LEV 11

INTERLOCK 33

INTERRUPT 15

I/O ATTENTION 9

I/O CHECK 12

MACHINE CYCLE 11

NPRO 18

OPEN 13

OVER RUN 99

PARITY CHECK 12

POWER ON 98

PRI 18

PRIMARY READY 18

PROCEED 89

PROCESS 14

PROCESSOR CHECK 9

PUNCH 99

PUNCH STA 99

PWR CHK 11

READ REG 99

READ STA 99

READY

printer 33

tape 62

1442 99

5444 disk 14

5445 disk 80

RECEIVE INITIAL 16

RECEIVE MODE 16

RECEIVE TRIGGER 16

REQUEST PENDING 89

RD 18

SEC 18

SECONDARY READY 18

SELECT 62

SELECT/LOCK 80

STKR 18

TAPE INDICATE 62

TEST MODE 15

TH CHK 11

TRANS 99

TSM MODE 15

TSM TRIGGER 16

UNIT CHECK 16

List Program 134

Load Point Marker 65

LOAD REWIND key 62

LOAD statement 120

LOCK key 89

LOCKOUT statement 121

log sheet 110, 114

LOG statement 120

LSR display selector 13

MACHINE CYCLE lights 11

match operating procedures

general 141

match 144

merge operating procedures

general 141

merge 144

message display unit 9

DPF 14

meter

customer engineer 12, 13

customer usage 10

MFCU

card feed paths 19

controls and indicators 18

panel 18

print ribbon

installing 27

removing 24

MFCU Sort/Collate Program 139  
mounting a disk cartridge  
5444 70  
5445 81  
mounting a reel 62

NOHALT statement 121  
NPRO (non-process run out)  
MFCU  
key 18  
light 18  
operation 106  
1442 98

object program execution, RPG II 124  
OPEN light 14  
operation control language  
considerations 120  
statements 120  
operator's panel  
disk 13  
dual program 14  
MFCU 18  
printer, dual feed 32  
printer, single feed 32  
system 9  
1442 98  
OVER RUN light 99

PARITY CHECK light 12  
PARTITION statement 121  
PAUSE statement 121  
power off procedure 113  
POWER ON light 98  
power on procedure 115  
POWER ON/OFF switch 9  
pressure rollers, forms 37  
PRI light 18  
PRIMARY READY light 18  
print chain cartridge  
installing 48-character 54  
installing 60-character 56  
removal 50  
print quality, printer 41  
print unit (MFCU)  
changing ribbon 24  
removing cards 22  
printer  
controls and indicators 32  
loading forms 34  
printer-keyboard 87, 88  
loading forms 95  
ribbon changing 92, 93  
typeball changing 90  
using 88  
printer panel 32  
printer, ribbon changing  
installation 48  
removal 44  
problem determination 233  
PROCEED light 89  
PROCESS light 14

processing unit  
controls and indicators 8  
display panel 11  
processor check 9  
PROCESSOR CHECK light 9  
program  
Basic Assembler 149  
Checkpoint/Restart 156  
Data Recording 145  
Data Verifying 146  
Device Counter Logout 131  
Disk Copy/Dump 152  
Disk Sort 146  
Disk Utilities 151  
RPG II Telecommunications 129  
Sort/Collate 141  
Tape Sort 149  
Tape Utilities 155  
96 List 134  
96-96 Reproduce and Interpret 135  
program halts 9, 14  
PROGRAM LOAD key 9  
PROGRAM LOAD SELECTOR switch 13  
program operating procedures, summary of 107, 109  
program packs, building 201  
program product generation using the MFCU or 1442  
example printout 194  
procedures 190  
program product generation using the printer-keyboard 205  
program run sheet 4-6  
PTFs  
applying 267  
considerations before applying 277  
PUNCH light 99  
PUNCH STA light 99  
PUNCH statement 121  
punch unit, removing cards 21  
PWR CHK  
light 11  
restart 115  
P1 and P2 switches 12  
  
RATE SELECT switch 16  
READER statement 120  
READ REG light 99  
READ STA light 99  
READY light  
printer 33  
tape 62  
1442 99  
5444 disk 14  
5445 disk 80  
RECEIVE INITIAL light 16  
RECEIVE MODE light 16  
RECEIVE TRIGGER light 16  
reformat data card 137  
register display unit 11  
removing  
cards from MFCU card feed path 19  
cards from 1442 card feed path 100  
disk cartridge  
5444 74  
5445 83  
tape reel 65

replacing tape markers 65  
reproduce 137  
Reproduce and Interpret Program 135  
REQ key 89  
REQUEST PENDING light 89  
RESET key 62  
restoring system power 115  
RETURN key 89  
RD light 18  
ribbon, changing  
    MFCU 24  
    printer 44  
    printer-keyboard 92  
run sheet 4-6  
RUN statement 121  
RPG II  
    compiling 122  
    executing 124  
    interrupting 126  
    I-type 126  
    sample 223  
RPG II Telecommunications Program 129  
    answering a call automatically 131  
    answering a call manually 131  
    compiling 129  
    execution 129  
    initiating a call automatically 130  
    initiating a call manually 130  
    nonswitched networks 130  
    switched networks 130  
  
safety covers 113  
sample program, RPG II 223  
SEC light 18  
SECONDARY READY light 18  
SELECT light 62  
SELECT/LOCK light 80  
select operating procedures  
    general 141  
    select 144  
SHIFT key 89  
Sort/Collate  
    messages 215  
    program 141  
sort operating procedures  
    general 141  
    no omits 141  
    omits 143  
SPACE key 89  
stacker jam 23  
START key  
    MFCU 18  
    printer 33  
    processing unit 9  
    tape 62  
    1442 98  
START/STOP switches 13, 80  
statement  
    BSCA 121  
    CALL 121  
    COMPILE 121  
    DATE 120  
    FILE 121  
    FORMS 121  
    HALT 121

IMAGE 121  
LOAD 120  
LOCKOUT 121  
LOG 120  
NOHALT 121  
PARTITION 121  
PAUSE 121  
PUNCH 121  
READER 120  
RUN 121  
SWITCH 121  
STKR light 18  
STOP light 9  
STOP key  
    MFCU 18  
    printer 33  
    processing unit 9  
    1442 98  
stopping a job 110  
storage dump procedures 106  
storage estimates  
    main 245  
    secondary (disk) 253  
STORAGE TEST switch 12  
switches  
    ADDR INCREM 12  
    ADDRESS COMPARE 12  
    ADDRESS/DATA 11  
    dual program control 14  
    FILE WRITE 12  
    I/O CHECK 12  
    I/O OVERLAP 12  
    POWER ON/OFF 9  
    PROGRAM LOAD SELECTOR 13  
    P1 12  
    P2 12  
    RATE SELECT 16  
    START/STOP 13, 80  
    STORAGE TEST 12  
SWITCH statement 121  
system console, controls 8  
system control panel 9  
system control program generation  
    MFCU or 1442 162  
    printer-keyboard 204  
system controls and indicators 8  
system generation using the MFCU or 1442  
    backing up resident system for 160  
    building a program pack 201  
    completing 196.1  
    example printout 181  
    functions 160  
    options 199  
    preparing for 160  
    program product 190  
    system control program, 162  
    using two system packs 265  
system generation using the printer-keyboard  
    backing up your resident system 204  
    completing 206  
    options 207  
    program product 204  
    system control program 204  
system power  
    restoring 115  
    turning off 113  
SYSTEM RESET key 12

TAPE INDICATE light 62  
 Tape Sort Program 149  
 Tape Utility Programs  
   description 155  
   procedures 155  
 test mode 11, 18  
 TEST MODE light 15  
 TH CHK light 11  
 TRANS light 99  
 TSM MODE light 15  
 TSM TRIGGER light 16  
 typeball 90

UNIT CHECK light 16  
 UNLOAD REWIND key 62  
 usage meter 10  
 using 1442 as only card input device  
   restrictions 106  
   running jobs 106  
 utility programs  
   card 133  
   disk 151

vertical adjustment, printer 39

wait station, removing cards 21

96 List Program 134  
 96-96 Reproduce and Interpret Program 135  
 1403 Printer 32  
 1442 Card Read Punch 97  
   card feed paths 100  
   controls and indicators 98  
   panel 98  
 3410/3411 Magnetic Tape Subsystem 61  
   cleaning tape head 67  
   controls and indicators 62  
   handling 68  
   mounting a reel 62  
   removing a reel 65  
   replacing tape markers 65  
 5203 Printer 31  
 5410 Central Processing Unit 7  
 5424 Multi-Function Card Unit 17  
 5444 Disk Storage Drive 69  
   disk cartridge  
     mounting 70  
     removing 74  
 5445 Disk Storage Drive 79  
   controls and indicators 80  
   disk cartridge  
     mounting 81  
     removing 83  
 5471 Printer-Keyboard 87

## READER'S COMMENT FORM

IBM System/3 Model 10  
Disk System  
Operator's Guide

GC21-7508-3

### YOUR COMMENTS, PLEASE . . .

Your comments assist us in improving the usefulness of our publications; they are an important part of the input used in preparing updates to the publications. All comments and suggestions become the property of IBM.

Please do not use this form for technical questions about the system or for requests for additional publications; this only delays the response. Instead, direct your inquiries or requests to your IBM representative or to the IBM branch office serving your locality.

Corrections or clarifications needed:

*Page*      *Comment*

Please include your name and address in the space below if you wish a reply.

● Thank you for your cooperation. No postage necessary if mailed in the U.S.A.

Along Line

Fold

Fold

FIRST CLASS  
PERMIT NO. 387  
ROCHESTER, MINN.

**BUSINESS REPLY MAIL**  
NO POSTAGE STAMP NECESSARY IF MAILED IN THE UNITED STATES

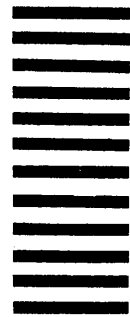

POSTAGE WILL BE PAID BY . . .

IBM Corporation  
General Systems Division  
Development Laboratory  
Rochester, Minnesota 55901

Attention: Publications, Dept 245

Fold

Fold

IBM System/3 Printed in USA GC21-7508-3



International Business Machines Corporation  
Data Processing Division  
1133 Westchester Avenue, White Plains, New York 10604  
(U.S.A. only)

IBM World Trade Corporation  
821 United Nations Plaza, New York, New York 10017  
(International)







International Business Machines Corporation  
Data Processing Division  
1183 Westchester Avenue, White Plains, New York 10604  
(USA only)

IBM World Trade Corporation  
821 United Nations Plaza, New York, New York 10017  
(International)