

Project Whirlwind  
Servomechanisms Laboratory  
Massachusetts Institute of Technology  
Cambridge 39, Massachusetts

SUBJECT: CIRCUITRY, RELAY TIMING, AND OPERATION OF WWI TAPE OUTPUT EQUIPMENT

To: 6345 Engineers

From: J. S. Hanson

Date: April 10, 1951

Abstract: Self-explanatory relay timing diagrams accompanied by a brief description of relay operating cycles and circuitry problems encountered cover essential details of operation of WWI Tape Output Equipment for various output modes. A new type of timing diagram is introduced.

TABLE OF CONTENTS

<u>Section</u>		<u>PAGE</u>
I	Preliminary Cabling of Units and Switch Settings.-- - - - -	3
II	"Words Only" Mode of Operation - - - - -	4
III	Relay Counter Presetting Feature for "Word-Complement" Mode of Operation - - - - -	6
IV	Effect of Multiple "Blank Preset" Signals on Relay Counter Setting - - - - -	7
V	"Word-Complement" Mode of Operation - - - - -	7
VI	Tape Unit "Start-Stop", Punched Tape Feedout, and Delay Control Relay Functions - - - - -	8
VII	Special Circuit Provisions - - - - -	9
VIII	Power Requirements, Recommended Fuse Ratings, and Circuit Conditions for Marginal Operations - - - - -	10
IX	Summary - - - - -	10

## I. Preliminary Cabling of Units and Switch Settings

The relay cabinet is installed in Rack TC-13 in WWI Test Control. A 36-conductor cable connects the various indicator lamp circuits to the gas tube relay register on the relay panel to accomplish data transfer from WWI to the Tape Output Equipment. A 33-conductor cable connects the relay panel with the Remote Control Unit which is located on a table in the Test Control Room along with the tape units.

The reader, printer, punch, and Remote Control Unit are cabled in accordance with attached print A-36835; cabling is relatively simple and fool-proof, since receptacles with corresponding letter and unit designations are merely connected with cables provided.

The various switches contained in the reader, printer, and punch enable the units to be used interchangeably in any of the tape preparation, tape checking, and WWI input systems without wiring changes. In order to operate these units as WWI Tape Output Equipment, switches must be set as follows.

### A. Printer:

1. Keep "On-Off" switch at the left side of the printer keyboard in the "off" position until system is ready to be used.
2. Throw "Insert" switch toward the rear of the machine.
3. Always keep a sheet of paper in machine to protect platen from direct contact with type bar.

### B. Reader:

1. Set "On-Off" switch (above cable receptacles) to "OFF".
2. Set "Marginal Check - Normal" switch to "NORMAL".
3. Set "Normal Stop - Read Complements" switch to "READ COMPLEMENTS".
4. Set "Normal - Clutch Control Jumped" switch to "NORMAL".
5. Place slotted metal shim under tape hold-down clamp so that sprocket teeth clear ends of slot. Be sure tape hold-down clamp is properly secured.

### C. Punch:

1. Set "On-Off" switch to "ON".
2. Set right-hand switch to "NORMAL" if reproduction of feedout holes is not desired.
3. Set "Marginal Check - Normal" switch to "NORMAL".

Preferably, system power should be turned on by means of the on-off switch at the left side of the printer, otherwise the printer keyboard is deprived of the mechanical interlock which prevents the keys from being accidentally depressed while the system is not in use. If this happens, a number of type bars may fly up in a tangle and jam the machine when the

power is turned on at the punch.

Finally, press the "Clear" push button on the Remote Control Panel, and then press the "Start" button on the printer. The former clears the gas tube register of any random "ones" which may have resulted from previous operations, and the latter makes the tape units and printer operative, as described in Section VI, page 8. The system may then be manually stopped at any time by pressing the "stop" button on the printer. To shut down the tape output equipment, operate the power "on-off" switch on the printer.

The rotary control switch (S-1) on the relay panel must be set to correspond to the desired type of WWI data output, as shown in the tabulation "DIGIT CONNECTIONS TO SWITCH" on Dwg. R-35927-2. Table I shows the connections obtained for each of the eight switch positions:

TABLE I

<u>Switch Position</u>	<u>Source of WWI Data Output to Gas Tube Register</u>
A	Accumulator (digits 10 through 15) and Program Register (digit 9)
B	Flip-Flop Storage Register #2 (digits 10 through 15) and Program Register (digit 9)
C	Flip-Flop Storage Register #2 (digits 9 through 15)
D	Program Counter (digits 8 through 14)
E	Control Switch (digits 0 through 4) and Accumulator (digits 0 and 1)
F	Accumulator (digits 2 through 8)
G	Accumulator (digits 9 through 15)

## II. "Words Only" Mode of Operation

A detailed analysis of Tape Output Equipment operation is accomplished with the aid of special timing diagrams developed by the writer and introduced here for the first time. The timing diagrams not only show the timing of every relay, contact, and electromechanical component in the system, but flow paths (cause and effect) as well. To aid in an understanding of these diagrams, a short list of symbols and their interpretations are shown at the bottom of each sheet. Entries in the left hand column include all relay coils, relay contacts, cam driven contacts, and tape unit electro-mechanical components, whether or not they are utilized in a particular mode of operation.

In the "Words Only" tape output mode, the printer records a char-

acter for each and every six-digit "word" placed in the output register by WWI. Switches on the remote control panel are set to "PRINTER ON", "PUNCH ON", "PRINT EVERY CHARACTER", and "LOCK CONTROL, WWI INPUT", and are designated on Drawing R-35927 by S8, S7, S6, and S5 respectively.

Referring now to relay timing diagram D-37308, an operating cycle is immediately initiated by a 0.1-microsecond "Print" pulse from WWI which appears at essentially the same instant that a word read into the output register causes the associated indicator-lamp circuits to drive positive the grids of the corresponding 2D21's in the gas tube register. Both of these effects are indicated on the timing diagram at 0 ms.

The "Print" pulse, stretched to approximately 4 microseconds by the blocking oscillator circuit of V-1, fires "Print" thyatron V-2 and energizes "Print" relay K-1. At 6 ms, "b" contact K-1-2 transfers the "Completion Signal" circuit from +90 volts to -30 volts. As K-1 closes in, "a" contact K-1-13 closes at 9 ms, seals in K-1 via "b" contact K-2-1, and conveniently shorts out and de-ionizes the "Print" thyatron at the same time. As "a" contact K-1-5 closes, plate voltage now applied to the relay register fires only those gas tubes with positive control grids, and energizes the corresponding register relays, (K-12 for example, which in turn closes "a" contacts K-12-5 and K-12-7 at 20 ms). Closing of remaining "a" contact K-1-6 energizes the reader clutch magnet, and after a 32-ms clutch mechanism delay, the reader cam shaft begins its rotation at 41 ms.

Closing of the "D-C Common" contact in the reader at 48 ms energizes the "translator" relays and punch selector magnets through register relay "a" contacts on the Reader Readout and Punch Readout buses respectively, and also energizes "D-C Common" relay K-2 directly. For example, with register relay K-12 closed, translator relay K-102 is energized through "a" contact K-12-5 on the Reader Readout Bus, and punch selector magnet K-202 is energized through "a" contact K-12-7. The tape punch now performs an automatic 74-ms electro-mechanical cycle of rotating the cam-shaft, actuating the selected punch mechanisms to punch the desired holes, de-energizing the clutch magnet, and advancing the tape for the next cycle.

At 55 ms, "b" contact K-2-1 opens and breaks the seal-in circuit of "a" contact K-1-13, de-energizing "Print" relay K-1. At 57 ms, "a" contact K-2-5 closes to maintain plate voltage on the relay register when "a" contact K-1-5 subsequently opens.

At 60 ms, closing of the reader "A-C Common" contact energizes the desired printer solenoid through "a" and "b" contacts on the translator relay bank, and the printer then types the corresponding character.

At 66 ms, as mentioned above, "a" contact K-1-5 opens, (relay register plate voltage is still maintained by "a" contact K-2-10), and "a" contact K-1-6 de-energizes the reader clutch magnet. Closing of "c" contact K-1-2 at 68 ms issues no "Completion" signal at this premature time because "b" contact K-2-8 is still open. Likewise, closing of the reader Feedout contact at 95 ms and its opening at 118 ms has no effect, since this contact is not used for the "Words Only" mode.

At 105 ms, opening of the "A-C Common" contact de-energizes the printer solenoid, and at 106 ms, opening of the "D-C Common" contact de-energizes the translator relays (K-102), the punch selector magnets (K-202), and "D-C Common" relay K-2.

At 137 ms, opening of "a" contact K-2-5 now removes plate voltage from the relay register (de-energizing K-12), closing of "b" contact K-2-6 sets up the "Completion" signal circuit whereupon closing of "b" contact K-12-2 in the relay register at 147

ms places +90 volts on the "Completion" signal line to terminal 12 and impresses a positive 120-volt pulse on the control grid of a 2D21 pulse generator (ref. Drawing R-33486) whose output is a 0.1-microsecond "Completion" pulse. This pulse signals WWI to clear the storage register, read into it the next word, and send a 0.1 microsecond "Print" pulse to the Tape Output Equipment to start the next cycle.

### III. Relay Counter Presetting Feature for "Word-Complement" Mode of Operation

Operation of individual tape units is identical to that of the "Words Only" mode, but in addition a scale-of-two relay counter is needed to permit the printer to type a character corresponding to the particular 6-digit "Word" in the gas tube relay register during punching of the word in paper tape, and then to keep the printer inoperative during the next cycle while the complement is being punched.

In employing a relay counter, it is possible to have the counter in the wrong position at the start of a train of data because of some previous usage, an unexpected switching transient, or some manipulation of tape equipment, so that it is necessary to arrange for some method of presetting this counter immediately before recording "Word-Complement" data. Accordingly, at least one six-"zero" "Blank" signal (meaningless to the printer) must be provided by WWI as the "Blank Preset" signal. Since more than one "Blank" signal may be needed for other WWI functions, the relay counter has been arranged so that it remains in the position preset by the first "Blank" signal regardless of the number of similar "Blank" signals following.

Since operation of the tape units is essentially the same in all modes, a description of timing relations in the relay counter will be considered sufficient for the "Word-Complement" mode. For this mode, switch S6 is set to "Words and Complements".

Referring now to the "Blank" Signal Preset timing diagram (drawing D-37301), all four counter relays (K-4 through K-7) and "Blank Preset" relay K-8 are initially unenergized. As before, the preset cycle is initiated by a WWI "Print" signal which fires "Print" thyatron V-2, and energizes "Print" relay K-1 at  $t = 0$  ms. Closing in of K-1 energizes "D-C Common" relay K-2 and reader clutch magnet K-107, and de-ionizes "Print" thyatron V-2. Again during the reader mechanical cycle, "D-C Common" contact S-102 closes at 42 ms and energizes "D-C Common" relay K-2, which de-energizes "Print" relay K-2 and the reader clutch magnet. Note that in this mode, there is no meaningful data yet present in the relay register because an all-zero "Blank Preset" stored in the WWI output register has kept all seven control grids of the gas tube register (V-3 through V-9) biased to -35 volts, and therefore application of plate voltage to the gas tube register at 50 ms fails to energize any of the register relays (K-11 through K-16). Hence no signal gets through translator relays and selector magnets to actuate the tape punch or printer.

Departure from a regular mode of operation now occurs at 88 ms when closing of reader "Feedout" contact S-101 energizes "Switch" relay K-4 of the relay counter through switch S6-2 which was set in the "Word-Complement" position. At 92 ms, "a" contact K-4-3 closes and energizes "Count" relay K-5 through "b" contact K-6-2, and the relay then seals in through "a" contact K-5-9.

Reopening of "Feedout" contact S-101 at 110 ms de-energizes "Switch" relay K-4, opening "a" contact K-4-3. This now has no effect on "Count" relay K-5 since it is sealed in through its own contact. However, closing of "b" contact K-4-1 energizes "Interlock Pulse" relay K-7 through "a" contact K-5-3 and the preset cycle is completed with the closing of "b" contact K-2-8 and issuance of a "Completion" signal. The equipment is now ready to punch and print the next meaningful character from WWI which

will be a word, punch the following complement only, and then repeat the cycle as long as WWI continues to furnish words and complements. Relay action for this operation will be briefly discussed under Section V, page 7.

#### IV. Effect of Multiple "Blank Preset" Signals on Relay Counter Setting

Consider now that a second "Blank Preset" signal is furnished by WWI instead of a "Word", as shown on timing diagram D-37301. Relays K-1, K-2, and the reader perform the same functions as before, with the exception that "a" contact K-5-6 is now closed at 185 ms and 115 volts a-c is applied to "Blank or Preset" relay K-8. As the reader cycle continues, "Feedout" cam contact S-101 closes at 220 ms and energizes "Switch" relay K-4 as before, except that "b" contact K-4-1 opening at 222 ms now de-energizes "Interlock Pulse" relay K-7.

At this point it is important to note that the purpose of "Interlock Pulse" relay K-7 is to deprive "Count Interlock" relay K-6 of any voltage before "Blank or Preset" relay K-8 can drop out. This is just about accomplished, but because of the fast drop-out time of K-8, an occasional 1-ms pulse does tickle "Count Interlock" relay K-6 at 231 ms. At no time has this critical timing point given rise to operational errors either in extensive tests required for this report or during normal operation with WWI, since marginal variation of voltages only contributes to a faster drop-out of "Interlock Pulse" relay K-7 and complete disappearance of this very short pulse. The pulse would have to be of at least 5 ms duration before a drop-out of "Count" relay K-5 and the resultant tripping of the relay counter to the opposite state would be effected.

To continue with the remainder of this second "Blank" signal cycle, opening of reader "Feedout" cam contact S-101 at 242 ms de-energizes "Switch" relay K-4, closing "b" contact K-4-1 at 248 ms and restoring all relays of the counter to their original preset positions as established by the first "Blank or Preset" signal. Reclosing of "b" contact K-2-8 at 264 ms ("D-C Common" relay K-2 having been previously de-energized at 232 ms by opening of the reader "D-C Common" contact) then initiates the "Completion" signal to WWI, signifying that the Tape Output Equipment has completed a cycle and is awaiting another "Blank" signal or a "Word".

#### V. "Word-Complement" Mode of Operation

Referring now to timing diagram D-37303, which is a continuation of D-37301 in regards to the elapsed time scale, relay and tape unit timing in this mode is identical to that of the "Words Only" mode described in Section II, page 4, as far as 492 ms, except that now the relay counter is now part of the system by reason of the switch settings on the Remote Control unit. Tape punch and printer cycles are initiated in the normal manner at 446 and 457 ms.

At 492 ms, closing of "Feedout" cam contact S-101 now is permitted to energize "Count Interlock" relay K-6 via "a" contact K-7-9 and "b" contact K-8-7, the latter being closed because "Blank" signals needed to energize "Blank or Preset" relay K-8 are now absent.

As a result, "b" contact K-6-2 opens at 497 ms, unseals and de-energizes "Count" relay K-5. Meanwhile "Count Interlock" relay K-6 seals in at 499 ms through "a" contact K-6-10 to keep relay K-5 isolated from energizing voltage present while "a" contact K-4-3 is closed. "Interlock Pulse" relay K-7, which had dropped out at 494 ms,

and "a" contact K-5-3 which opened at 507 ms (as described in Section II) now prevent "b" contact K-4-1 from de-energizing "Interlock Pulse" relay K-7 at 520 ms. All relays in the counter are de-energized, the counter is now in the "Complement" position, and the cycle is completed in the usual manner.

Upon receipt of a "Completion" signal, WWI places the "Complement" in the gas tube register and issues another "Print" signal at 543 ms. The resulting relay and tape unit operations are again the same as before, except that "a" contact K-5-6 is now open and the printer receives no 115-volt A-C signal through the Translator Relays (K-102 for example), hence no character is typed. The tape punch selector magnets are energized at 593 ms in accordance with relay register "a" contacts to punch the "Complement".

The closing of reader "Feedout" cam contact S-101 at 639 ms energizes "Switch" relay K-4, and the closing of "a" contact K-4-3 at 643 ms energizes "Count" relay K-6 via "b" contact K-6-2, and the latter seals in at 650 ms through "a" contact K-5-9. Reclosing of "b" contact K-4-1 after "Feedout" cam contact S-101 opens energizes "Interlock Pulse" relay K-7, the relay counter once again attains the "Word" position, the cycle is completed at 690 ms, and the system is ready for the next "Word".

## VI. Tape Unit "Start-Stop," Punched Tape Feedout, and Delay Control Relay Functions

### A. "Start-Stop"

Pressing of the "Start" button (S-109 on the reader or S-301 on the printer) is necessary in readying the tape output equipment for operation with WWI after turning on the power. Its effect on the delay control circuits are as follows: pressing of the "Start" button first opens a "b" contact to disconnect the reader clutch magnet and then closes an "a" contact which energizes Clutch Control relay K-108. A "b" contact on this relay opens the reader clutch magnet circuit at a second point, and then an "a" contact energizes the pickup coil of Delay Control relay K-109. A "c" contact of K-109 first completes the circuit to the "buck" coil of this same relay, then an "a" contact in the clutch magnet circuit closes, and finally K-109 seals in through a second "a" contact and a 4000-ohm resistor R-106.

At this point (with the "Start" button still held down) both K-108 and K-109 are closed, and there are still two breaks in the reader clutch magnet circuit: one is the "b" contact on K-108 and the other is the "b" contact on the "Start" switch. Release of the "Start" button first opens the "a" contact and de-energizes Clutch Control relay K-108 which in turn closes the "b" contact in the reader clutch magnet circuit. Finally, closing of the "Start" button "b" contact completes the circuit to the clutch magnet. Only then can "a" contact K-1-6 of the "Print" relay energize the clutch magnet, trip the clutch and start the cam contact mechanism of the tape reader, hence the necessity of pressing the "Start" button after turning on the power.

### B. Punched-Tape Feedout

In the tape punch, punched tape must travel from the perforating mechanism a distance of three or four inches to the point at which it emerges from the tear-off guide, so that after completing an output tape, the "Feedout" button on the tape punch is pressed to feed out about six inches of blank tape, after which the tape can be torn off. Obviously, if the "Feedout" button is not used, three or four inches of data bearing tape will be left inside the tape punch when the tape is torn off.



A possibility now arises where someone might press the "Feedout" button assuming that the computer has finished reading out data, and spoil the tape. To avoid this condition, the "Feedout" button is rendered electrically inoperative by means of the "Unlock-Lock Control, WWI Input" switch when the latter is in the "LOCK CONTROL, WWI INPUT" position. The "Clear" pushbutton on the Remote Control box is likewise rendered ineffective by the same switch, since it is also possible to spoil the preparation of an output tape by inadvertently pressing the "Clear" pushbutton.

#### D. Delay Control Relay Function

The printer must frequently execute tabular movements of the carriage, carriage returns, shifts for capitals or symbols, and other functions which would cause it to fall behind control signals from the tape reader, so that obviously some kind of delay must be provided to make the reader pause while the printer completes a function. This is accomplished by contacts in the printer which first de-energize the reader clutch magnet and then energize "Clutch Control" relay K-108 which in turn opens a "b" contact in the clutch magnet circuit. The reader cam shaft rotates to the point at which the clutch automatically disengages and stops. The clutch magnet is not able to trip the clutch until the printer completes its function.

Energizing of "Clutch Control" relay K-108 maintains voltage on the pickup coil of "Delay Control" relay K-109 during the delay period when a-c is flowing through one of the printer machine function solenoids that actuate the keyboard. This current flow creates a voltage drop across the buck coil rectifier SR-100 and its rectified output causes "Delay Control" relay K-109 to drop out and open the reader clutch magnet circuit. By this time K-108 has had time to close and maintain the open circuit.

Completion of a machine function closes the delay contacts, de-energizes "Clutch Control" relay K-108 which then energizes Delay Control relay K-109. An "a" contact on K-109 then completes the clutch magnet circuit, whereupon the clutch is tripped and the reader starts out on the next cycle.

#### VII. Special Circuit Provisions

In preliminary operational tests on the breadboard version of the tape output equipment, considerable difficulty arose from excessive transients put out on both the a-c and d-c power lines with amplitudes in the order of 100 volts or more and of frequencies in the megacycle region. R-F filters provided in the printer for the centrifugally-controlled governor motor were insufficient for WWI standards so additional filtering consisting of L-8 and C-39 was provided in the 115-volt A-C power line at the point of entry into the relay cabinet.

In turning on the power to the tape output equipment, the possibility of originating a spurious "Completion" signal is eliminated by means of an R-C network consisting of R-67, R-68, and C-26 connected in the +90 and -30 volt lines immediately after the single-stage L-C filters. Condenser C-26 limits the rate of rise of voltage on the "Completion" signal line to approximately  $2.4 \times 10^4$  volts per second, which is sufficiently low enough so that the pulse generator sees no more than approximately 0.8 volt at the instant the +90 volts is turned on, and can therefore produce no 0.1-microsecond "Completion" signal to interfere with other WWI operations. Note that this R-C network may be rendered ineffective if power to the Tape Output Equipment is turned on and off by means of the lever switch on the rack power control unit, since it is entirely possible that the +90 may appear before the -30, in which case a spurious "Completion" signal would result.

Large amplitude relay switching transients are eliminated from the +150 line by means of a two-stage filter containing L-4, L-5, and C-29 through C-31. Any remaining transient effects are less than WWI specifications of 1.5 volts permissible maximum.

VIII. Power Requirements, Recommended Fuse Ratings, and Circuit Conditions for Marginal Operation

The following tabulation shows the maximum a-c and d-c current inputs to the Tape Output Equipment during the various indicated modes of operation at rated nominal voltage, the fuse capacities required, and voltages resulting in marginal operation.

TABLE II

<u>Supply Volts</u>	<u>Terminal No.</u>	<u>Max. Milliamps.</u>		<u>Recommended 3AG Fuse Sizes, amperes</u>	<u>Minimum Voltage for Marginal Operation</u>
		<u>One-Hole</u>	<u>Six-Hole</u>		
-150	E2-8	0.2	0.3	1/2	(Note 2)
-30	E2-6	0.1	0.1	1/2	-1 (Note 3)
-15	E2-4	15	15	1/2	-11 (Note 4)
+90	E2-3	0.1	0.1	1/2	+40
+150	E2-7	21	140	1	+115
115 AC	--	(2.3 amperes)		3 (Note 1)	95

Note 1. Littelfuse "Silo-Blo" Cat. No. 313003, 250 volts or equivalent; all others Cat. No. 312500 (1/2 amp.) or Cat. No. 312001 (1 amp.) or equivalent.

Note 2. Margin expressed in terms of minimum voltage on terminals E1-1 through E1-3 necessary to fire relay register gas tubes. These voltages range from +170 to +187 volts.

Note 3. Equipment operates satisfactorily with almost negligible bias at this point, but disconnecting lead stops operation instantly.

Note 4. Reader shaft stops at -10 volts; all relay register gas tubes fire at -3 volts.

IX. Summary

The Tape Output System has operated dependably over a period of several months, except for usual difficulties encountered in the tape units, such as a) stalling and scorching of driving motors in tape punch and reader because of incorrect fusing and insufficient lubrication reaching the shaft bearings, b) bad arcing and burning of reader "D-C Common" cam contact, c) stalling or jamming of carriage return mechanism in printer, or d) printer governor-motor inoperative because of faulty governor contacts.

The possibility of Tape Output System failure as a result of sticking of relay

armatures can be eliminated by a careful check of all plug-in Type J relays for incorrect residual and heel-piece gap settings. For the residual screw setting a gap of  $1.0 \pm 0.5$  mil (measured between the armature and the abutting end of the relay core by means of a feeler gauge) is recommended. For the heel-piece gap (measured by feeler gage between the hinged end of the armature and the abutting end of the heel piece of relay "frame" with the armature held closed) a clearance of  $1.0 \pm 0.5$  mil is also recommended.

Signed by James S. Hanson  
J. S. Hanson

Approved by Es Rich  
E. S. Rich

JSH:js

cc: H. Daggett  
S. Dodd  
R. Hunt  
F. Irish  
E. Rich  
C. Watt

Drawings attached:

R-35927  
A-36835  
D-37308  
D-37309  
D-37305

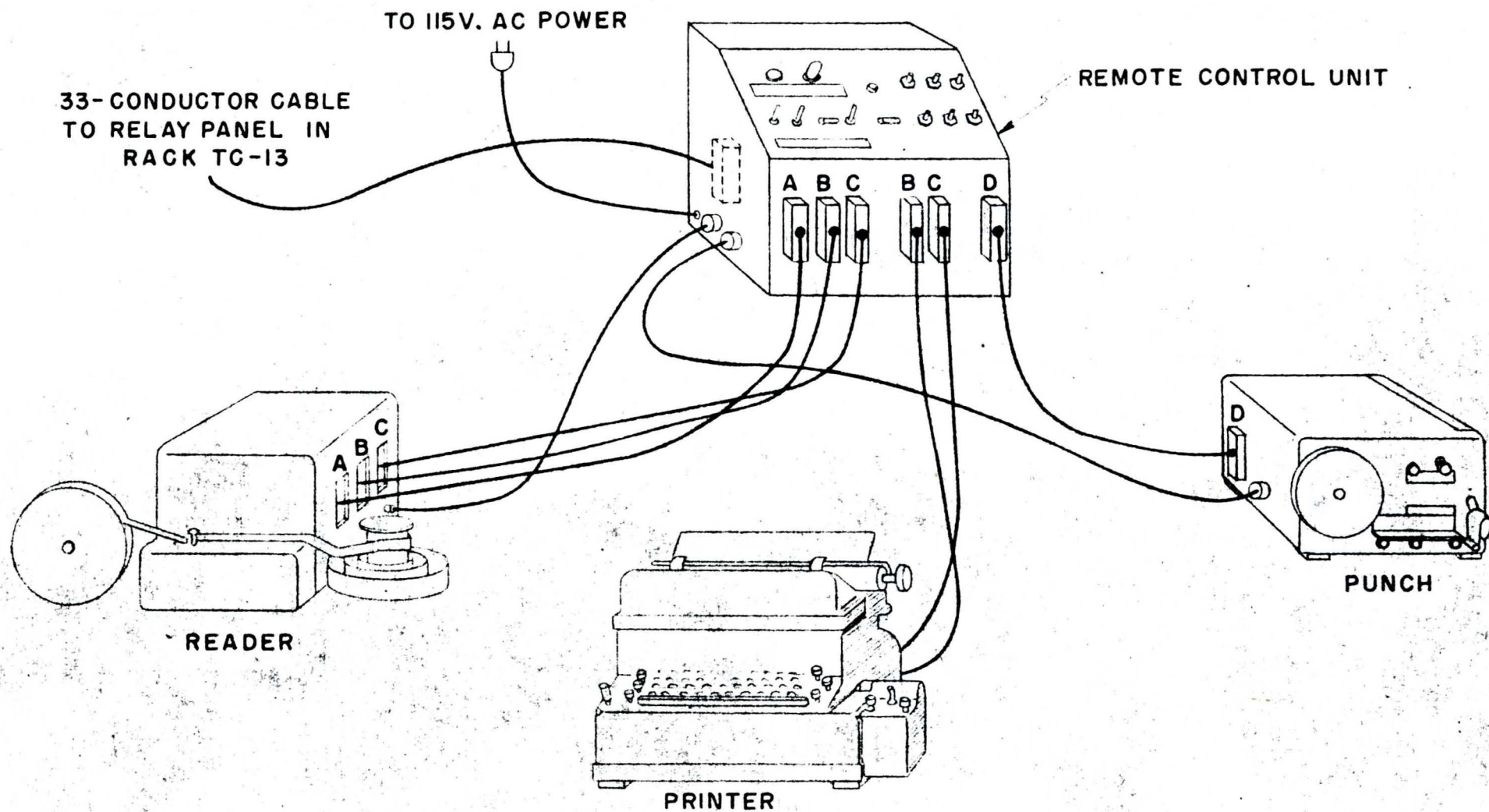

TAPE OUTPUT SYSTEM CABLING BETWEEN READER,  
 PRINTER, PUNCH, AND REMOTE CONTROL UNIT.

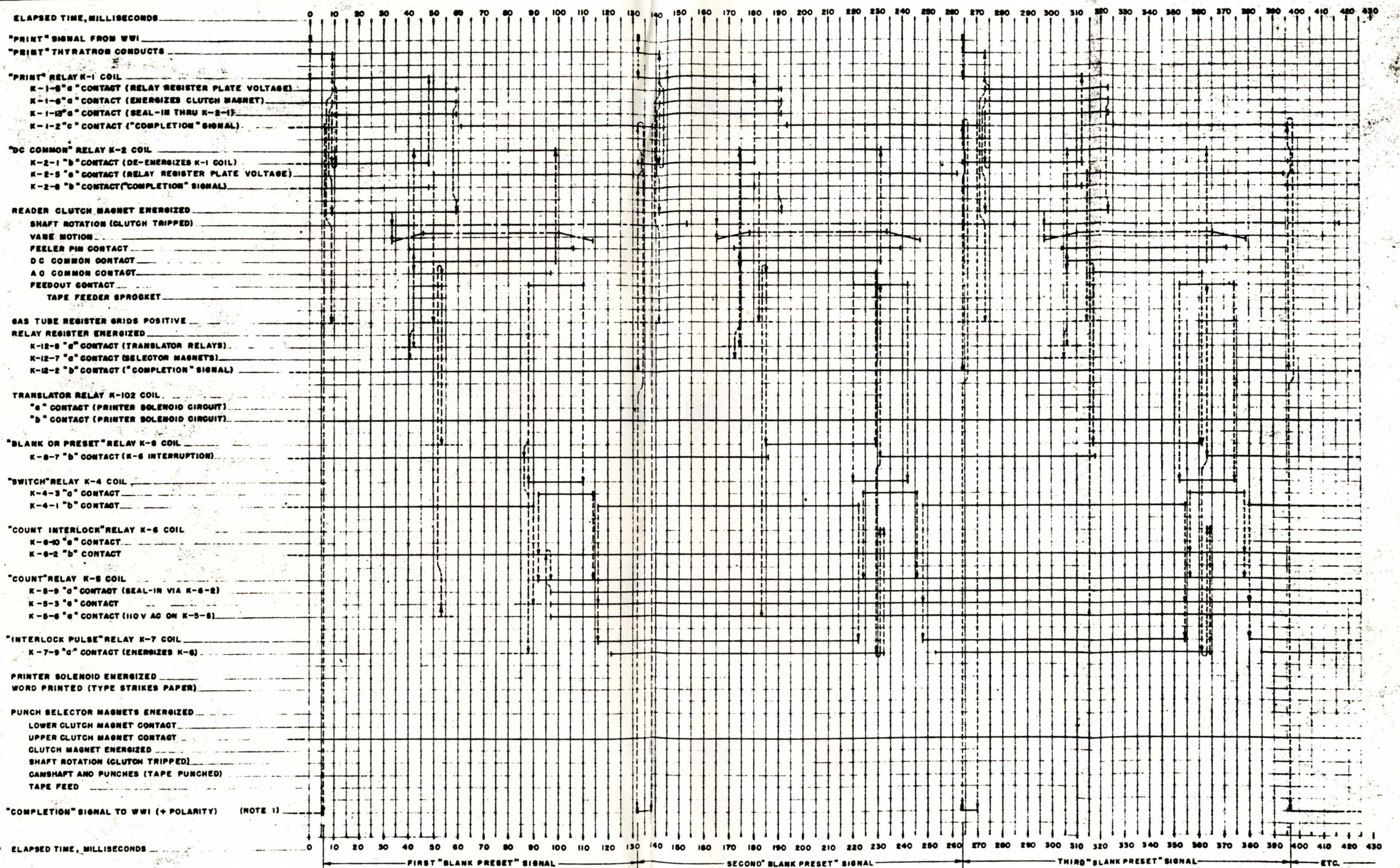

NOTE 1. SYMBOL (L) SIGNIFIES INSTANT AT WHICH "COMPLETION" PULSE IS RETURNED TO WWI FROM PULSE GENERATOR (REF. DWG. R-35189) HORIZONTAL LINE (—) SIGNIFIES DURATION OF +90 VOLTAGE ON THIS CIRCUIT (TERMINAL E-1-12 ON JONES STRIP), 30V. BEING PRESENT AT ALL OTHER TIMES.

**SYMBOLISM:**

- DENOTES PERIOD DURING WHICH A RELAY COIL IS ENERGIZED, OR AN "a" OR "b" CONTACT CLOSED.
- OR — VERTICAL DOTTED LINES INDICATE SIGNAL FLOW PATH OR AN OPERATION OF ONE CIRCUIT COMPONENT AS A RESULT OF OPERATION OF ANOTHER COMPONENT.
- DENOTES BLOCKING OF SIGNAL BY OPEN CONTACT.
- - - DENOTES SIGNAL THAT WOULD HAVE BEEN PRESENT HAD CONTACT BEEN CLOSED.

**COIL** — COMPLETE INDICATION OF RELAY CONTACT OPERATING DELAY TIME WITH RESPECT TO RELAY COIL.

**"a" CONT.** — DENOTES INITIATION OF ONE MECHANICAL FUNCTION AS RESULT OF ANOTHER BY MEANS OF HORIZONTAL DOT-DASH LINES AND VERTICAL SOLID LINES, AND ALSO MECHANICAL OPERATION OF CONTACTS BY EACH FUNCTION.

**K-1-13 "a" CONTACT.** REFERS TO AN "a" CONTACT CONNECTED TO PIN 13 OF "PRINT" RELAY K-1, FOR EXAMPLE, AS SHOWN IN CIRCUIT SCHEMATIC R-35927.

MASSACHUSETTS INSTITUTE OF TECHNOLOGY  
 DIVISION OF INDUSTRIAL COOPERATION PROJECT NO. 6345  
**TIMING DIAGRAM FOR "BLANK" SIGNAL PRESET OF RELAY COUNTER, TAPE OUTPUT EQUIPMENT, WWI**  
 GRADED BY: DATE: GRADED BY: DATE: GRADED BY: DATE: GRADED BY: DATE:  
 HIGHEST GRADE APPROVED: \_\_\_\_\_  
 GRADE I FOR REFERENCE: \_\_\_\_\_  
 GRADE II FOR APPROVAL: \_\_\_\_\_  
 GRADE III FOR DESIGN: \_\_\_\_\_  
 AMG 3-12-51  
**D-37301**  
 8-REDUCTION

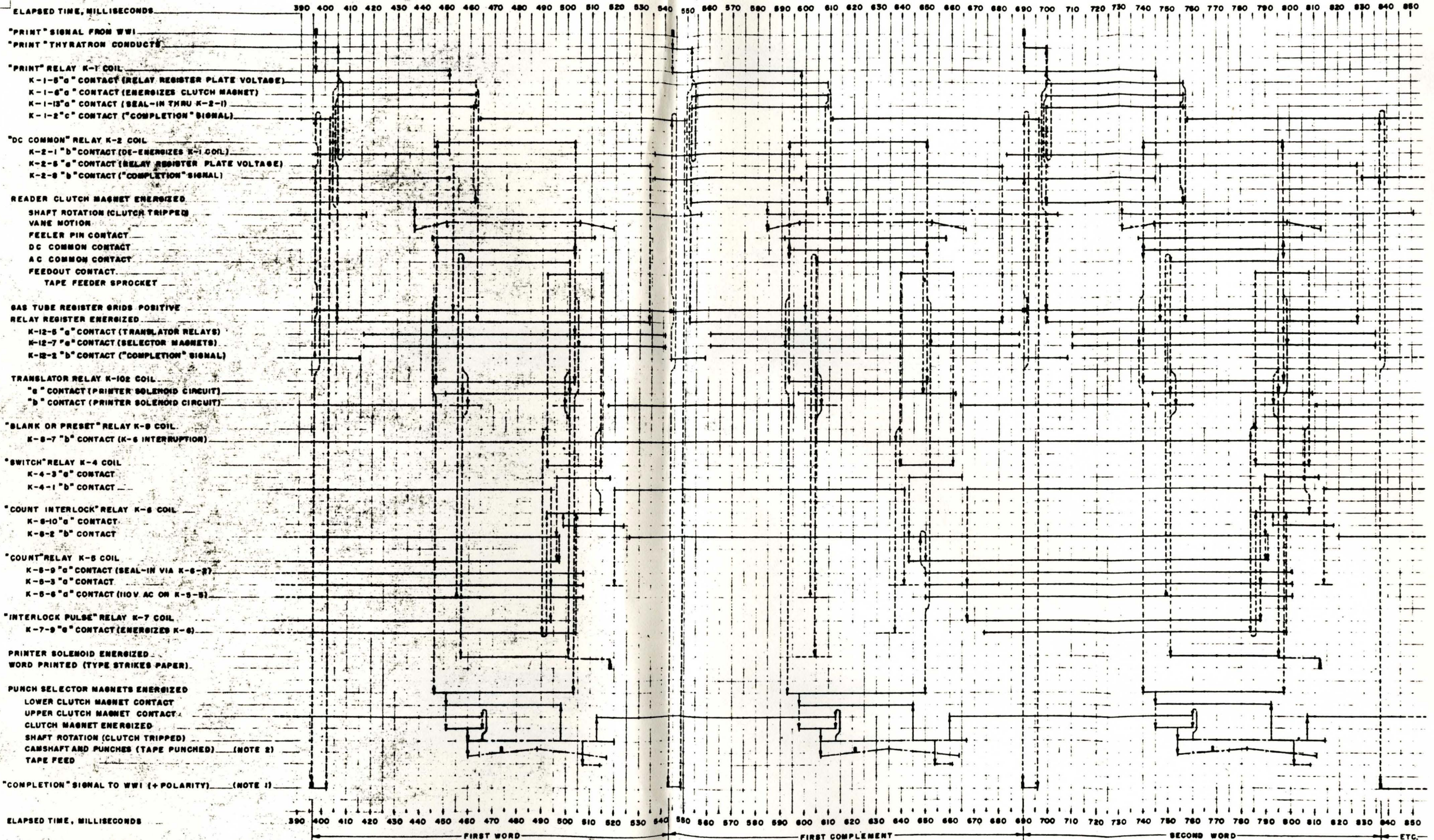

NOTE 1. SYMBOL (L) SIGNIFIES INSTANT AT WHICH "COMPLETION" PULSE IS RETURNED TO WWI FROM PULSE GENERATOR (REF. DWG. R-35189). HORIZONTAL LINE (—) SIGNIFIES DURATION OF +90 VOLTAGE ON THIS CIRCUIT (TERMINAL E-1-12 ON JONES STRIP), -30V. BEING PRESENT AT ALL OTHER TIMES.

NOTE 2. SYMBOL (—) DENOTES INSTANT AT WHICH PUNCH PERFORATES PAPER TAPE.

**SYMBOLISM:**

— DENOTES PERIOD DURING WHICH A RELAY COIL IS ENERGIZED, OR AN "a" OR "b" CONTACT CLOSED.

OR — VERTICAL DOTTED LINES INDICATE SIGNAL FLOW PATH OR AN OPERATION OF ONE CIRCUIT COMPONENT AS A RESULT OF OPERATION OF ANOTHER COMPONENT.

— DENOTES BLOCKING OF SIGNAL BY OPEN CONTACT.

— DENOTES SIGNAL THAT WOULD HAVE BEEN PRESENT HAD CONTACT BEEN CLOSED.

COIL — COMPLETE INDICATION OF RELAY CONTACT OPERATING DELAY TIME WITH RESPECT TO RELAY COIL.

OR — DENOTES INITIATION OF ONE MECHANICAL FUNCTION AS RESULT OF ANOTHER BY MEANS OF HORIZONTAL DOT-DASH LINES AND VERTICAL SOLID LINES, AND ALSO MECHANICAL OPERATION OF CONTACTS BY EACH FUNCTION.

K-1-13 "a" CONTACT. REFERS TO AN "a" CONTACT CONNECTED TO PIN 13 OF "PRINT" RELAY K-1, FOR EXAMPLE, AS SHOWN IN CIRCUIT SCHEMATIC R-35927.

CREATED BY DATE: 11-1-51  
 CHECKED BY: J. J. HANCOCK  
 GRADE: 11  
 SCALE: 1:1

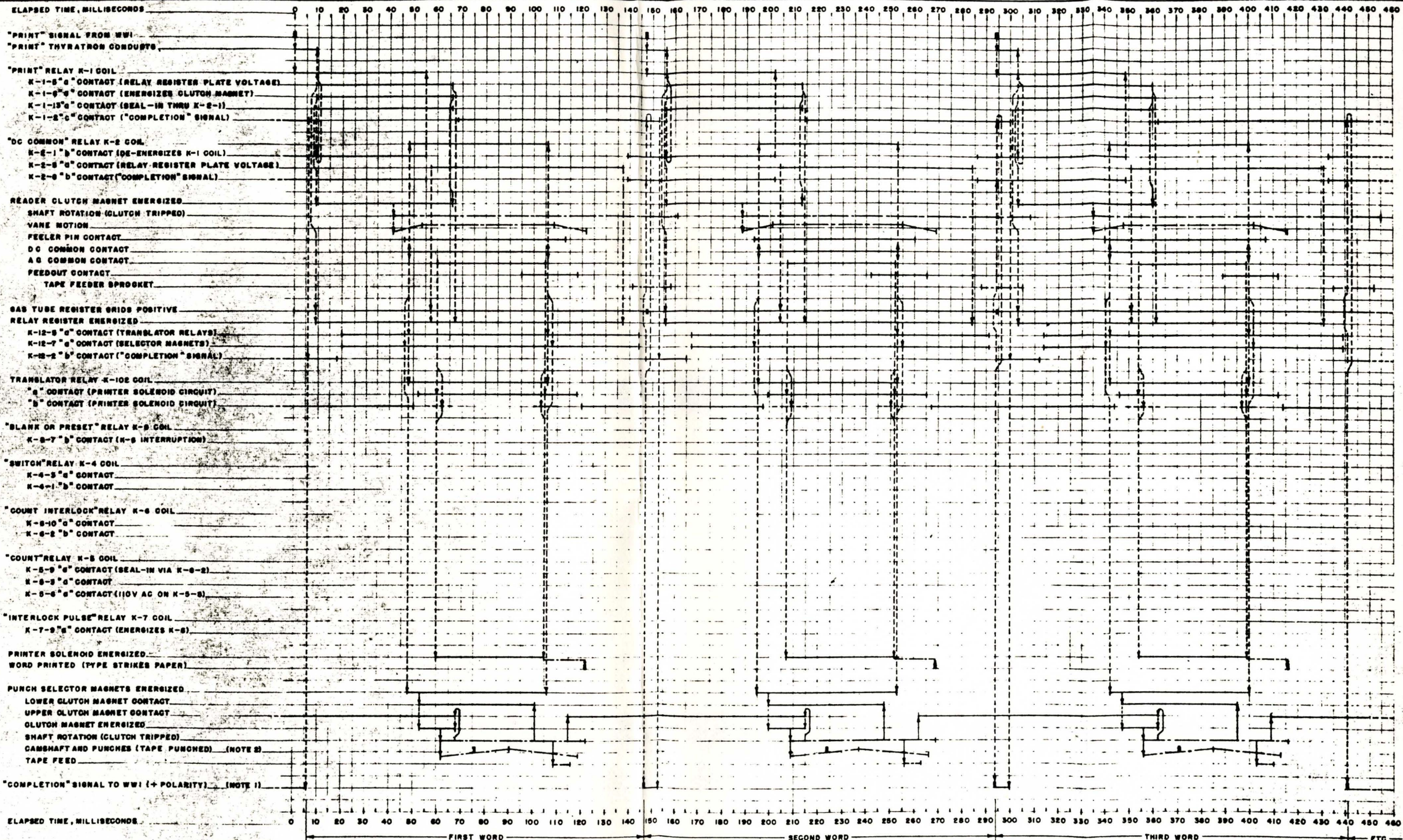

NOTE 1. SYMBOL (E) SIGNIFIES INSTANT AT WHICH "COMPLETION" PULSE IS RETURNED TO WWI FROM PULSE GENERATOR (SEE DWG R-35189). HORIZONTAL LINE (—) SIGNIFIES DURATION OF +90 VOLTAGE ON THIS CIRCUIT (TERMINAL E-1-12 ON JONES STRIP), -30V. BEING PRESENT AT ALL OTHER TIMES.

NOTE 2. SYMBOL (S) DENOTES INSTANT AT WHICH PUNCH PERFORATES PAPER TAPE.

**SYMBOLISM:**

- DENOTES PERIOD DURING WHICH A RELAY COIL IS ENERGIZED, OR AN "a" OR "b" CONTACT CLOSED.
- OR OR — VERTICAL DOTTED LINES INDICATE SIGNAL FLOW PATH OR AN OPERATION OF ONE CIRCUIT COMPONENT AS A RESULT OF OPERATION OF ANOTHER COMPONENT.
- DENOTES BLOCKING OF SIGNAL BY OPEN CONTACT.
- DENOTES SIGNAL THAT WOULD HAVE BEEN PRESENT HAD CONTACT BEEN CLOSED.

COIL  
"a" CONT  
"b" CONT

COMPLETE INDICATION OF RELAY CONTACT OPERATING DELAY TIME WITH RESPECT TO RELAY COIL.

DENOTES INITIATION OF ONE MECHANICAL FUNCTION AS RESULT OF ANOTHER BY MEANS OF HORIZONTAL DOT-DASH LINES AND VERTICAL SOLID LINES, AND ALSO MECHANICAL OPERATION OF CONTACTS BY EACH FUNCTION.

K-1-15 "a" CONTACT. REFERS TO AN "a" CONTACT CONNECTED TO PIN 13 OF "PRINT" RELAY K-1, FOR EXAMPLE, AS SHOWN IN CIRCUIT SCHEMATIC R-55927.

GRADED BY DATE THIS IS A GRADED DRAWING OF HIGHEST GRADE APPROVED BY IN GRADE I FOR REFERENCE ONLY GRADE II PRELIMINARY DESIGN GRADE III FINAL DESIGN

MASSACHUSETTS INSTITUTE OF TECHNOLOGY  
DIVISION OF INDUSTRIAL COOPERATION PROJECT NO. 6345

**TIMING DIAGRAM FOR "WORDS ONLY" MODE, TAPE OUTPUT EQUIPMENT, WWI**

SCALE: 1" = 100 MS  
DATE: 4-9-51  
DRAWN BY: J. H. HANCOCK  
CHECKED BY: J. H. HANCOCK  
A.M.S. 23-51

D-37308  
B-REDUCTION

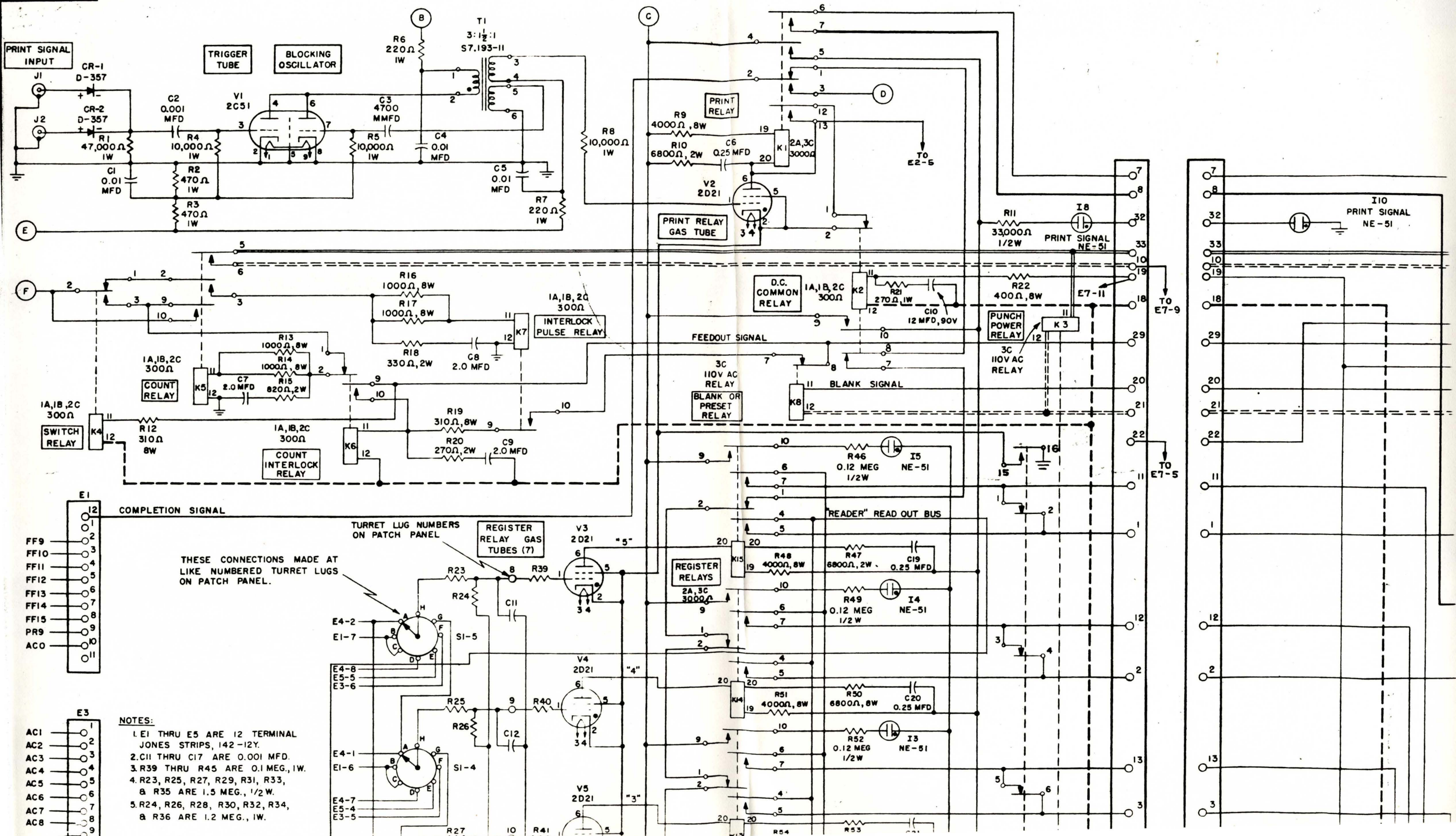

- FF9
- FF10
- FF11
- FF12
- FF13
- FF14
- FF15
- PR9
- ACO

- AC1
- AC2
- AC3
- AC4
- AC5
- AC6
- AC7
- AC8

**NOTES:**

1. E1 THRU E5 ARE 12 TERMINAL JONES STRIPS, 142-12Y.
2. C11 THRU C17 ARE 0.001 MFD.
3. R39 THRU R45 ARE 0.1 MEG., 1W.
4. R23, R25, R27, R29, R31, R33, & R35 ARE 1.5 MEG., 1/2W.
5. R24, R26, R28, R30, R32, R34, & R36 ARE 1.2 MEG., 1W.

THESE CONNECTIONS MADE AT LIKE NUMBERED TURRET LUGS ON PATCH PANEL.

TURRET LUG NUMBERS ON PATCH PANEL

REGISTER RELAY TUBES (7)

"5"

"4"

"3"

TO E7-9

TO E7-5

I10 PRINT SIGNAL NE-51

I8 PRINT SIGNAL NE-51

PRINT RELAY

PRINT RELAY GAS TUBE

D.C. COMMON RELAY

PUNCH POWER RELAY

BLANK OR PRESET RELAY

REGISTER RELAYS

I4 NE-51

I3 NE-51

I5 NE-51

TRIGGER TUBE

BLOCKING OSCILLATOR

PRINT SIGNAL INPUT

PRINT RELAY

PRINT RELAY GAS TUBE

D.C. COMMON RELAY

PUNCH POWER RELAY

BLANK OR PRESET RELAY

REGISTER RELAYS

I4 NE-51

I3 NE-51

I5 NE-51

TRIGGER TUBE

BLOCKING OSCILLATOR

PRINT SIGNAL INPUT



P8, P9  
2-33 PIN FEMALE  
SOCKETS (B&C)

51 WIRES

NO CABLES REQUIRED

3 WIRE CABLES REQUIRED

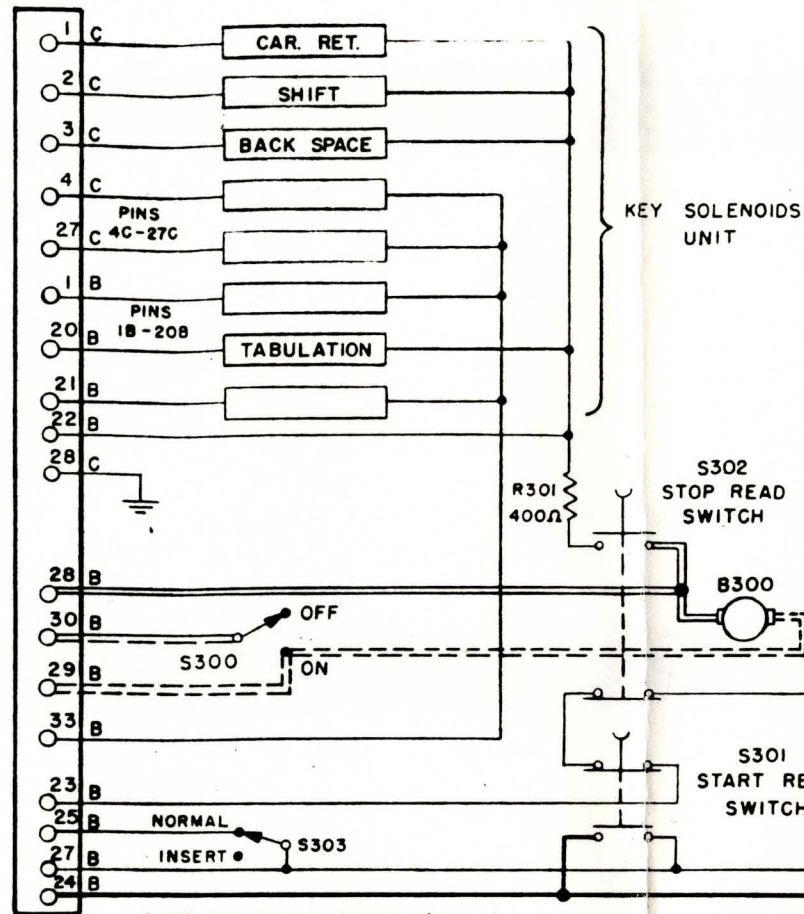

**PRINTER**  
C-36424

MACHINE FUNCTION CONTACTS

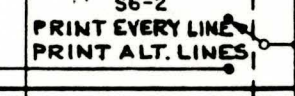
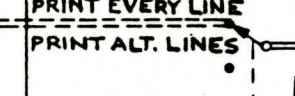
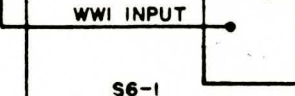
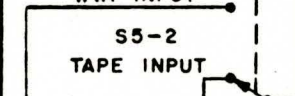
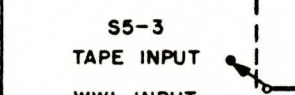
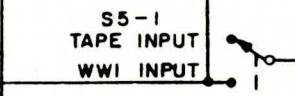
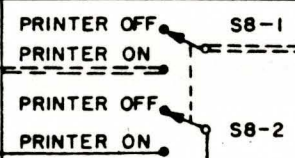
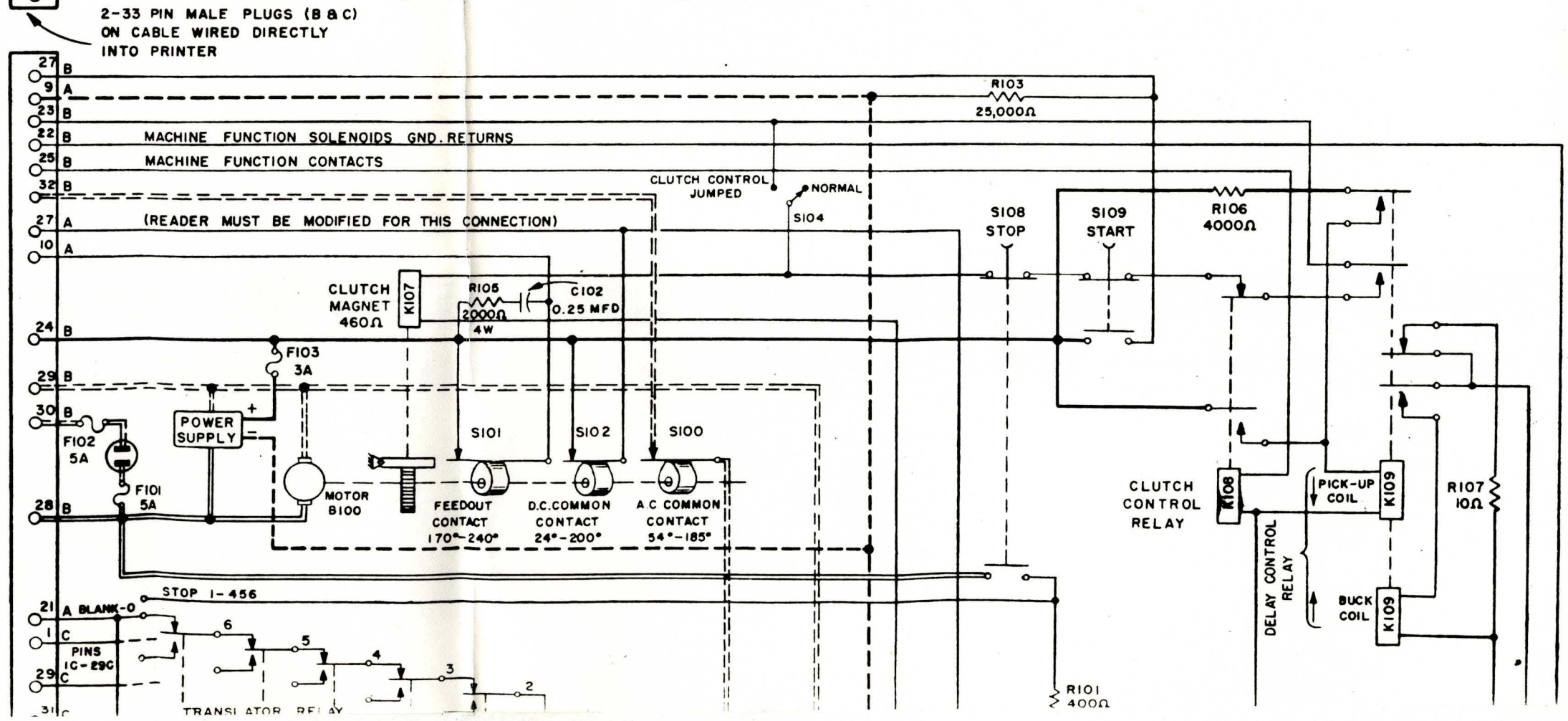

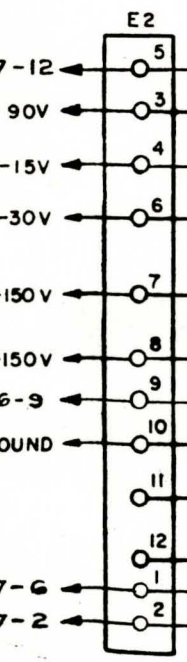
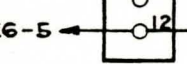
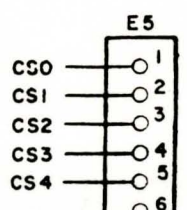
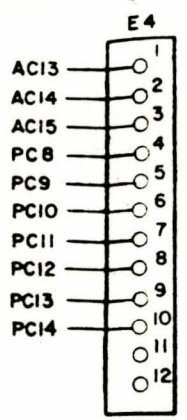
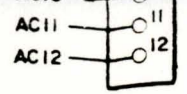

DIGIT CONNECTIONS TO SWITCH							
ROTARY SWITCH POSITIONS							
TAPE HOLE	A	B	C	D	E	F	G
1	AC10	FF2 10	FF2 10	PC8	CS0	AC2	AC9
2	AC11	FF2 11	FF2 11	PC9	CS1	AC3	AC10
3	AC12	FF2 12	FF2 12	PC10	CS2	AC4	AC11
4	AC13	FF2 13	FF2 13	PC11	CS3	AC5	AC12
5	AC14	FF2 14	FF2 14	PC12	CS4	AC6	AC13
6	AC15	FF2 15	FF2 15	PC13	AC0	AC7	AC14
7	PR9	FF2 9	FF2 9	PC14	AC1	AC8	AC15

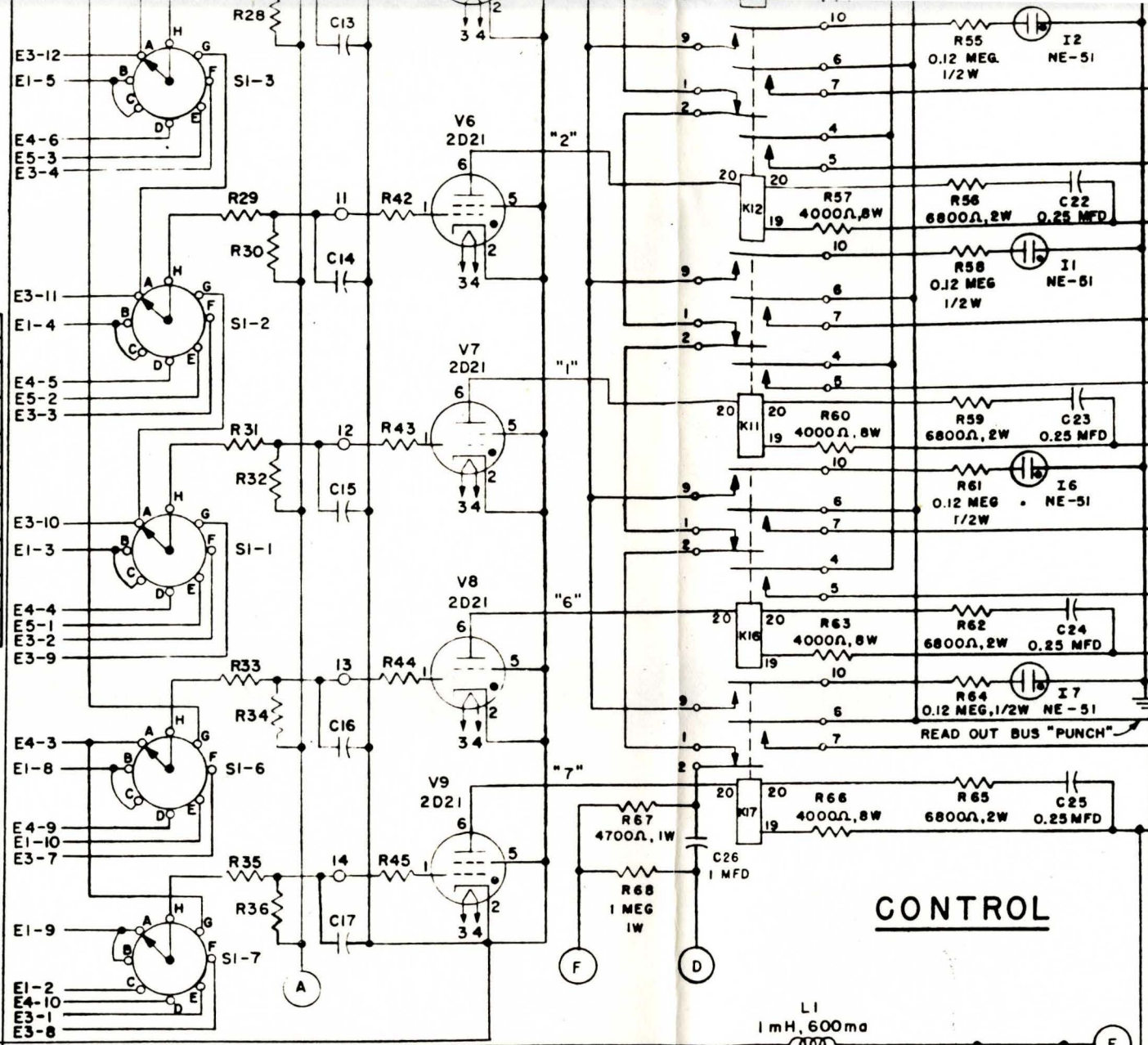

**CONTROL**

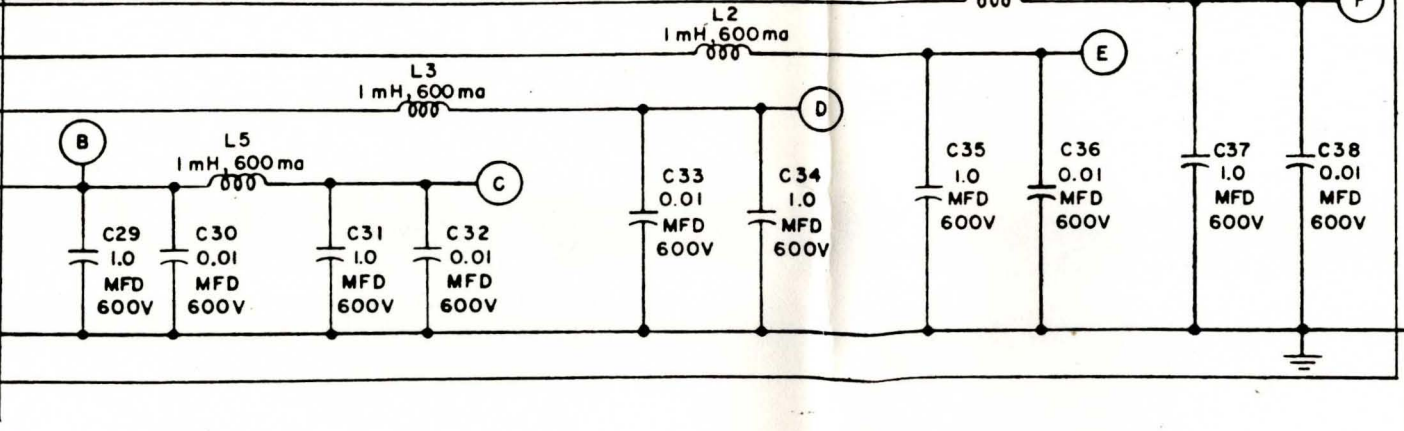

NOTE: ALL BALLOONS WITH SAME LETTER ENCLOSED ARE CONNECTED TOGETHER.  
 (SEE ALSO B-50306 FOR AUXILIARY CIRCUITS)

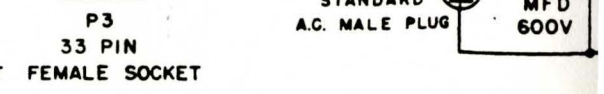
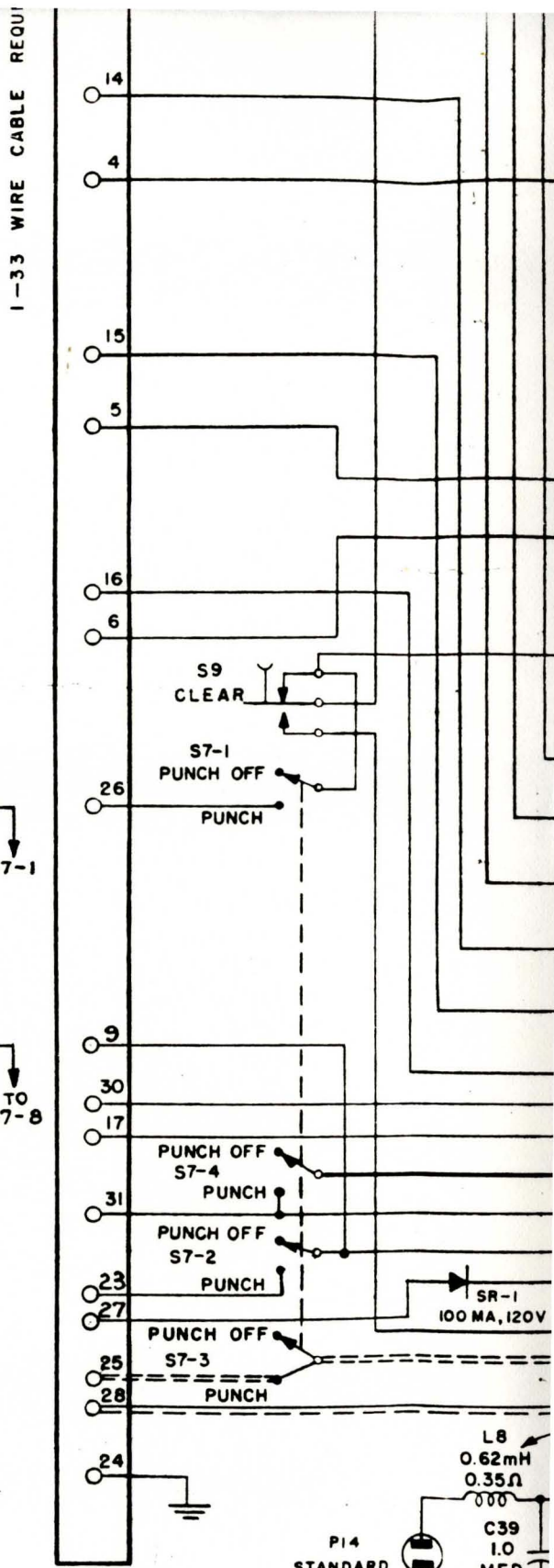
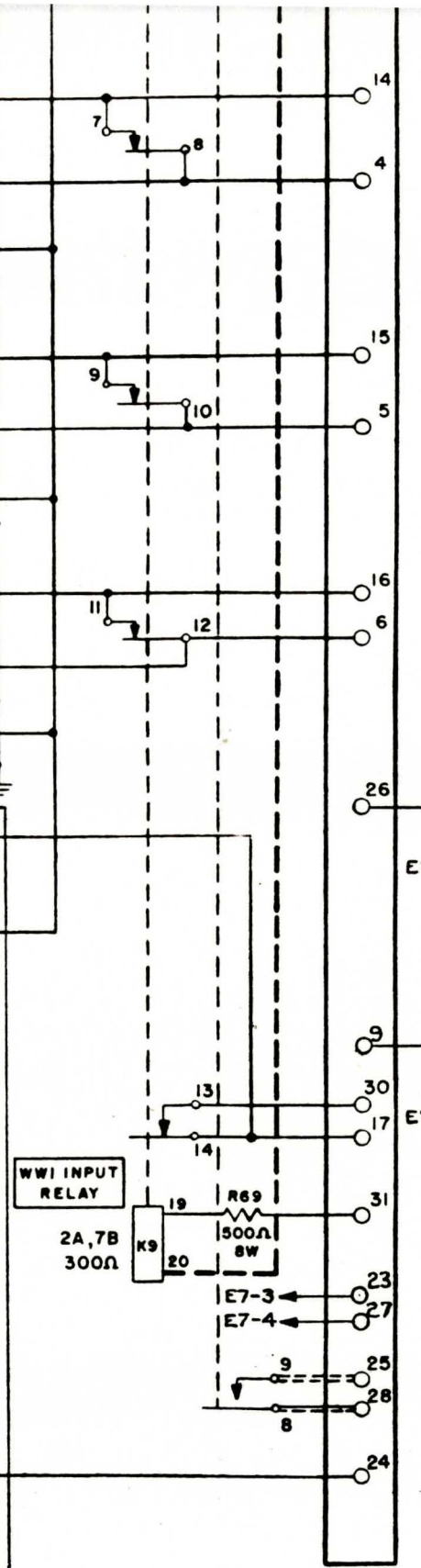

REM

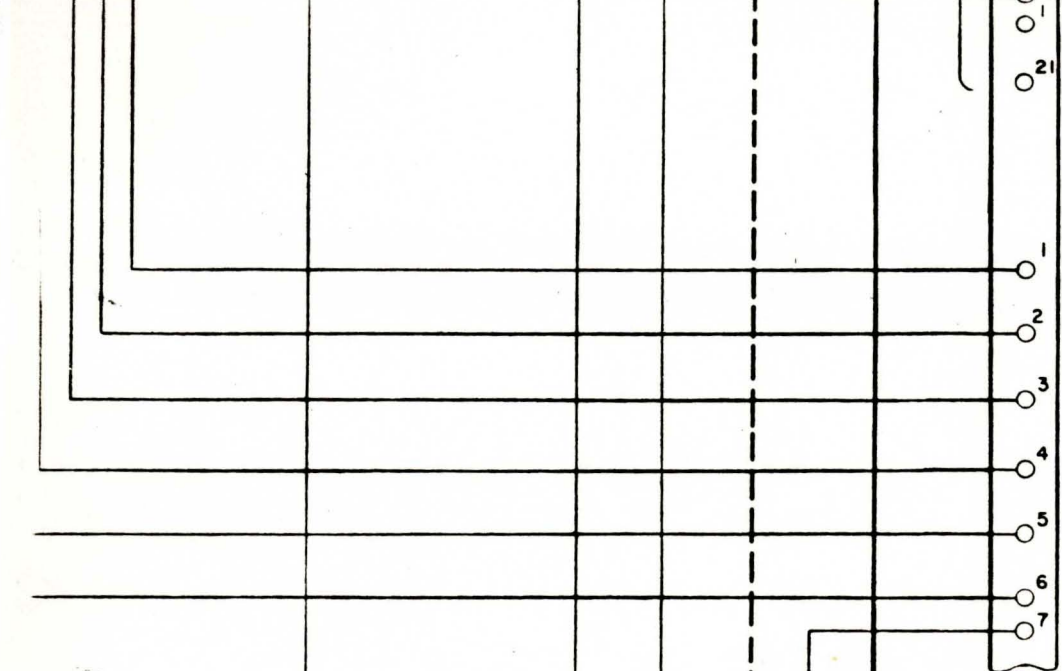

P5, P6, P7  
3-33 PIN  
FEMALE SOCKETS  
(A, B & C)

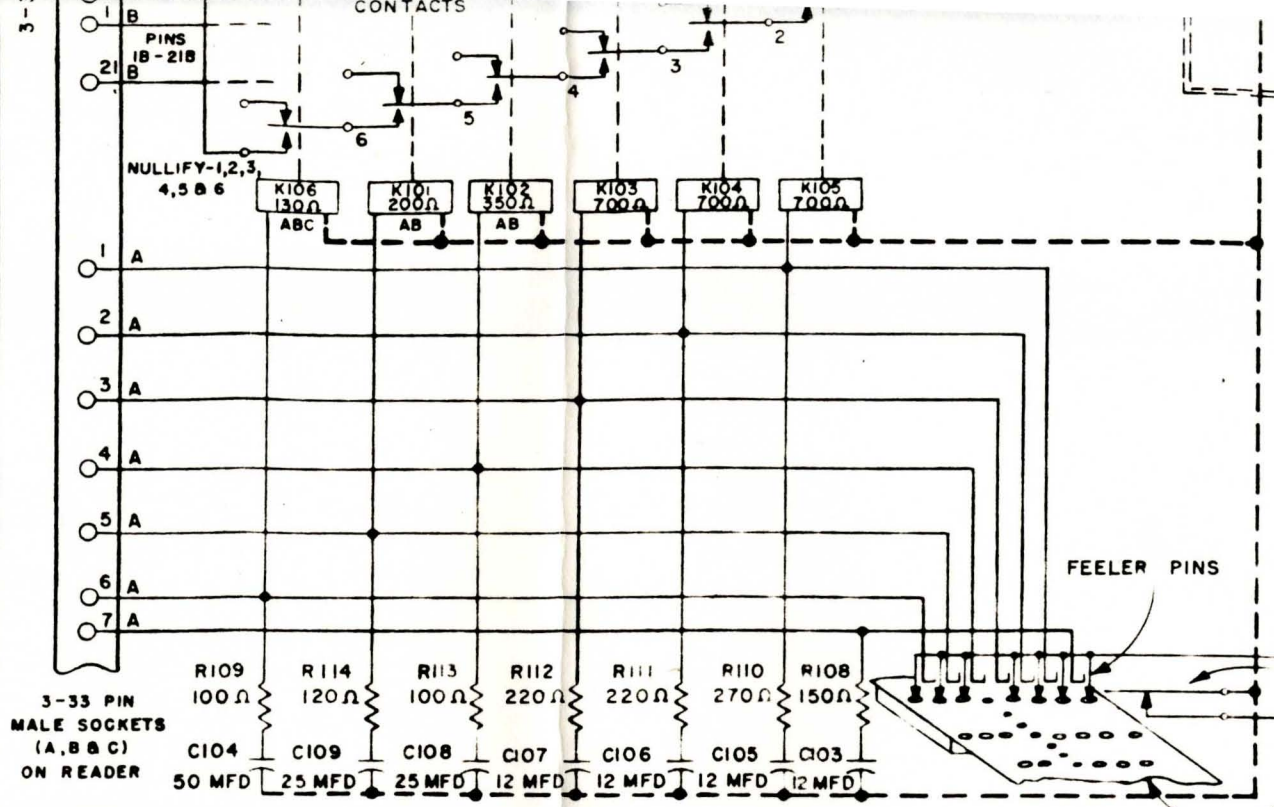

R104  
400Ω

S106  
NO TAPE  
SWITCH

.003" METAL SHIM WITH SLOT FOR  
FEEDOUT HOLES MUST BE INSERTED  
DURING WWI INPUT MODE OF OPERATION.

**READER**  
D-35750

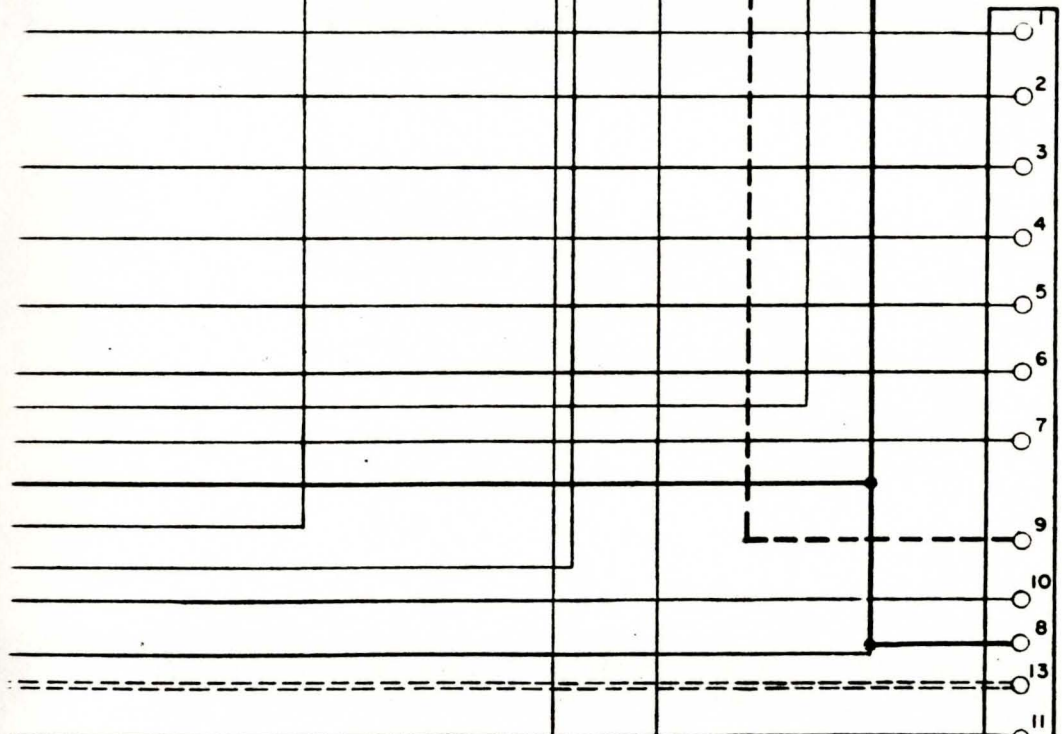

P4  
1-24 WIRE  
FEMALE SOCKET

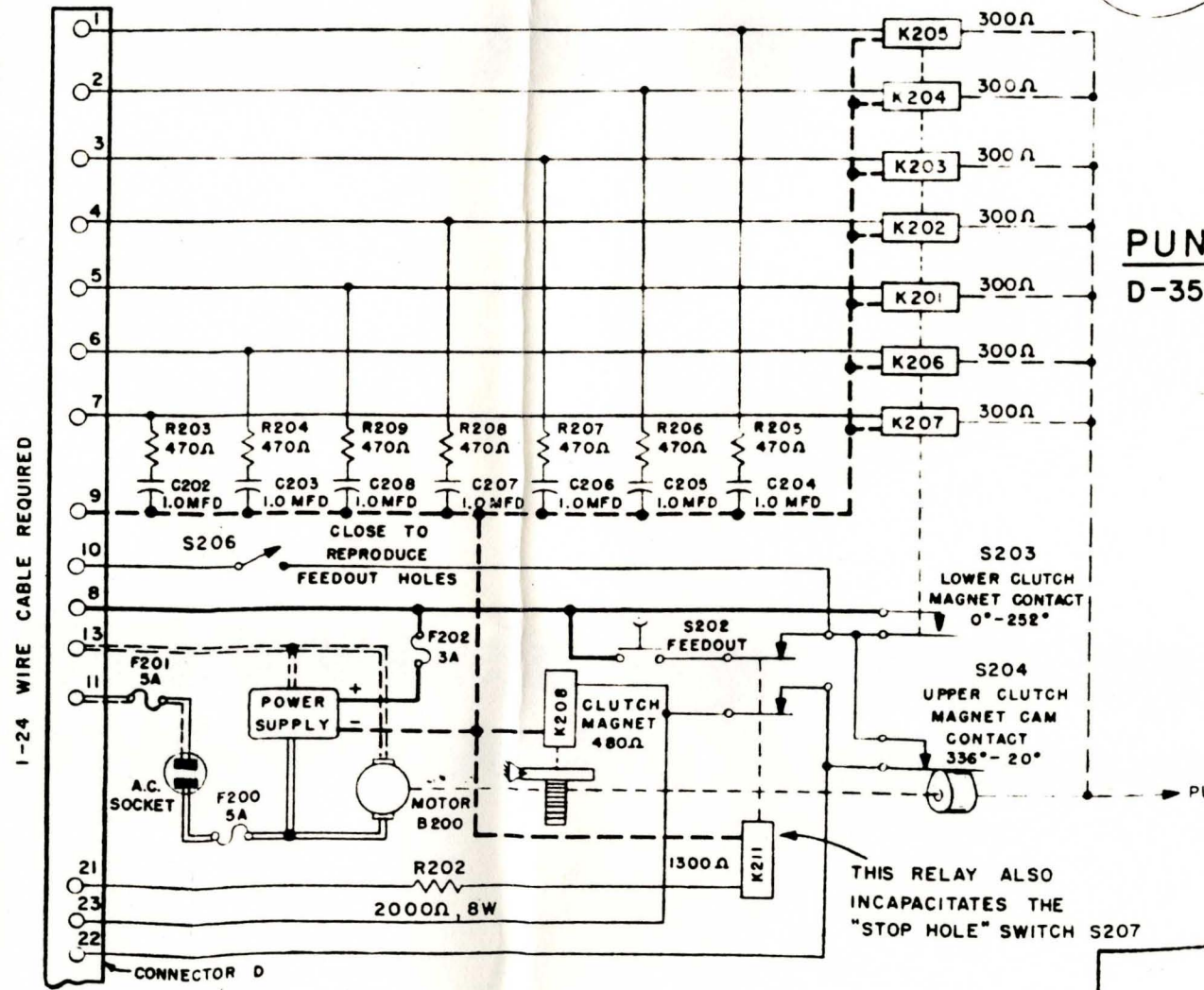

**PUNCH**  
D-35749

**LEGEND**

- ==== A.C. } UNSWITCHED
- ==== A.C. }
- ==== A.C. SWITCHED
- + D.C.
- - - - - D.C.

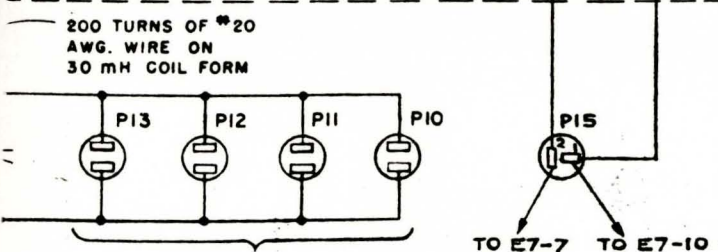
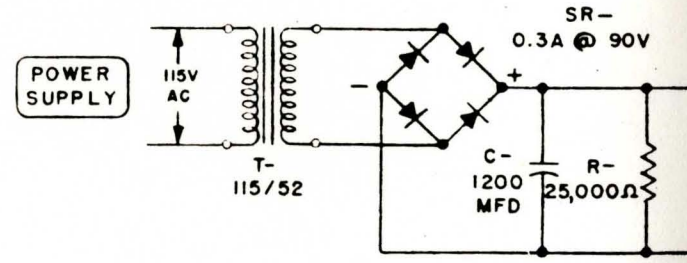

**NOTE CONTROL**

1-24 PIN  
MALE SOCKET  
ON READER

THIS RELAY ALSO  
INCAPACITATES THE  
"STOP HOLE" SWITCH S207

MASSACHUSETTS INSTITUTE OF TECHNOLOGY  
INDUSTRIAL COOPERATION PROJECT NO 63

CIRCUIT SCHEMATIC, TAPE OUTPUT UNIT,	
M.M.	12-11-50
REVISION	1-15-51
<b>R-359</b> D-REDUC	