

# WIND RIVER

## Wind River<sup>®</sup> Probe for Wind River<sup>®</sup> Workbench

HARDWARE REFERENCE

2.6.1

---

Copyright © 2007 Wind River Systems, Inc.

All rights reserved. No part of this publication may be reproduced or transmitted in any form or by any means without the prior written permission of Wind River Systems, Inc.

Wind River, the Wind River logo, Tornado, and VxWorks are registered trademarks of Wind River Systems, Inc. Any third-party trademarks referenced are the property of their respective owners. For further information regarding Wind River trademarks, please see:

<http://www.windriver.com/company/terms/trademark.html>

This product may include software licensed to Wind River by third parties. Relevant notices (if any) are provided in your product installation under the following directory:  
*installDir\product\_name\3rd\_party\_licensor\_notice.pdf*.

---

**Corporate Headquarters**

Wind River Systems, Inc.  
500 Wind River Way  
Alameda, CA 94501-1153  
U.S.A.

toll free (U.S.): (800) 545-WIND  
telephone: (510) 748-4100  
facsimile: (510) 749-2010

For additional contact information, please visit the Wind River URL:

<http://www.windriver.com>

For information on how to contact Customer Support, please visit the following URL:

<http://www.windriver.com/support>

# Contents

<b>1</b>	<b>Introduction .....</b>	<b>1</b>
1.1	Overview .....	1
1.2	System Overview .....	2
1.3	Features .....	3
1.4	Safety Information .....	4
<b>2</b>	<b>Setting Up Hardware .....</b>	<b>7</b>
2.1	Introduction .....	7
2.2	Wind River Probe Components .....	8
2.3	Unpacking Information .....	8
2.4	Wind River Probe Description .....	9
2.4.1	Top of Wind River Probe .....	9
2.4.2	Target-specific adapter .....	10
2.5	Layout Drawings .....	11
2.6	Connecting Wind River Probe to a Host .....	11

2.7	<b>Connecting Wind River Probe to a Target .....</b>	<b>12</b>
2.7.1	Grounding Wind River Probe and the Target .....	13
<b>3</b>	<b>Installing Drivers .....</b>	<b>15</b>
3.1	Introduction .....	15
3.2	Windows Hosts .....	15
3.3	Linux Hosts .....	16
<b>4</b>	<b>Establishing Communications .....</b>	<b>19</b>
4.1	Introduction .....	19
4.2	Connecting to the Wind River Probe .....	20
4.3	Setting up a Project .....	32
4.4	Downloading Code .....	35
4.4.1	Projects to Build Tab .....	36
4.4.2	Reset Tab .....	37
4.4.3	Download Tab .....	38
4.4.4	Instruction Pointer Tab .....	40
4.4.5	Run Options Tab .....	41
4.4.6	Source Tab .....	42
4.4.7	Common Tab .....	42
4.4.8	Executing the Reset and Download .....	43
4.5	Initializing the Target .....	44
4.6	Working with Wind River Probe .....	46
4.6.1	Configuration Options .....	46
	Editing CF Options with Low-level Commands .....	48
4.6.2	Boot Register Initialization .....	48

4.6.3	Setting Chip Selects .....	49
4.7	Moving On .....	50
<b>5</b>	<b>Troubleshooting .....</b>	<b>51</b>
5.1	Introduction .....	51
5.2	Troubleshooting Connection Problems .....	52
5.2.1	Wind River Probe Diagnostic Test -- Windows .....	52
	Connecting .....	53
	Updating Firmware .....	53
	Diagnostic Test .....	55
5.2.2	Wind River Probe Diagnostic Test -- Linux .....	56
	Updating Firmware .....	57
5.3	Troubleshooting Communication Problems .....	58
5.4	Troubleshooting License Key Problems .....	60
5.5	Troubleshooting Performance Problems .....	61
	<b>Index .....</b>	<b>63</b>



# 1

## *Introduction*

- 1.1 Overview 1
- 1.2 System Overview 2
- 1.3 Features 3
- 1.4 Safety Information 4

### 1.1 Overview

This document is designed to help users understand Wind River Probe, the Wind River on-chip debugging tool. The Wind River On-Chip Debug Solution includes Wind River Probe and Wind River Workbench, a software tool for hardware and RTOS bring-up. Together, these products provide a fully integrated hardware and software solution that can be used to bring up a target board, to program flash, and for production and testing.

Use Wind River Probe to perform source-level debug activities, such as watching memory and controlling large numbers of registers. Wind River Probe can shorten development cycles, even for extremely complex applications.

This document outlines information that is specific to Wind River Probe. Some information in this manual explains how to perform functions with Wind River Probe and Wind River Workbench; for detailed information about using the debugger, please see the *Wind River Workbench User's Guide* and the *Wind River Workbench for On-Chip Debugging User Tutorials*.

This document includes the following chapters:

- [1. Introduction](#) — Provides a high level overview of the Wind River Probe product.
- [2. Setting Up Hardware](#) — Describes how to make all of the physical connections between Wind River Probe, the target, and your host computer.
- [3. Installing Drivers](#) -- Describes procedures for installing the Wind River Probe drivers on Windows and Linux hosts.
- [4. Establishing Communications](#)— Describes using Wind River Workbench to connect to Wind River Probe and your target.
- [5. Troubleshooting](#) -- Describes troubleshooting procedures for various problems.

## 1.2 System Overview

Wind River Probe lets you control a target by utilizing the On-Chip Debugging (OCD) services embedded in the microprocessor of that target. A high-speed USB connection from your PC enables you to communicate with the OCD services that are resident in the microcode of the chip.

When you access the OCD services in the chip, you have complete control of the microprocessor, and all interaction between Wind River Probe and the target runs exclusively through the OCD connection. This means that your system is effective for the entire development process, even before board-level peripherals are stable.



Figure 1-1 Wind River Probe

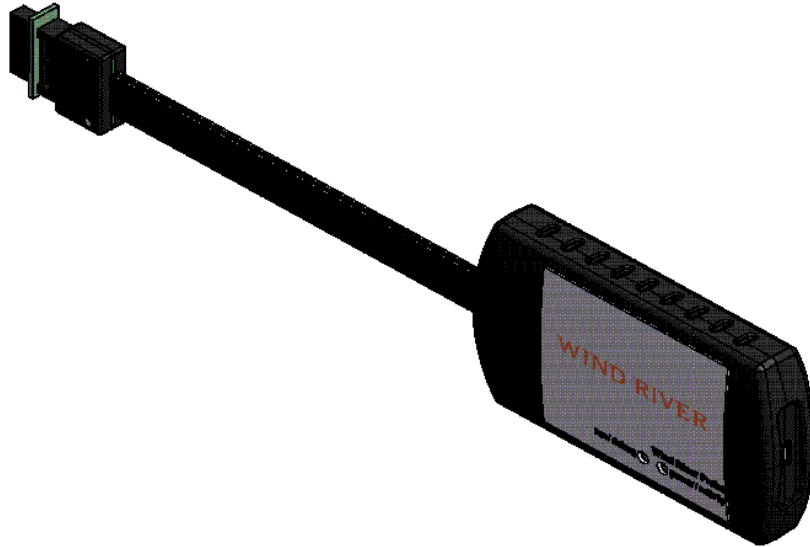

## 1.3 Features

Wind River Probe includes the following features:

- **High Speed USB Download**

Wind River Probe provides a High Speed USB 2.0 connection to your host PC that enables you to download code to your target extremely quickly.

- **On-Chip Debug Target Control**

Wind River Probe lets you start and stop a target, set internal hardware and software breakpoints, take a target snapshot, reset a target, step one statement or instruction, step into function calls, and step over or out of a function.

- **Built in Hardware Diagnostics**

Wind River Probe includes a comprehensive suite of RAM tests, scope loops, and CRC tests.

- **Additional Custom Registers**

Wind River Probe supports 32 custom register groups, which results in a total of 960 custom registers.

- **Target Versatility**

Wind River Probe allows the user to test several target architectures using the same debug hardware.

## 1.4 Safety Information

There are some basic safety precautions that you should observe when using Wind River Probe. Follow these precautions to help avoid injury and prevent damage to Wind River Probe and any products connected to it. To avoid hazardous conditions, use this product only as specified. For the purposes of this document, warning and caution symbols denote the following:



**WARNING:** Warning statements indicate conditions that could result in injury or loss of life, and describe how to avoid them.

---



**CAUTION:** Caution statements indicate conditions that could result in damage to this product or other property and describe how to avoid them.

---

### Precautions to avoid injury



**WARNING:** Do not operate in wet or damp environments or outside the recommended operating conditions. This product is intended for indoor use only.

Do not operate this product in an explosive atmosphere.

Do not operate the product if it is damaged. Have a qualified service person inspect damaged equipment before use.

---

**Precautions to avoid property damage**



---

**CAUTION:** Take precautions against electrostatic discharge as it may damage some components.

Use care in handling, as delicate components can be easily damaged.

Provide proper ventilation to prevent the product from overheating.

---



# 2

## *Setting Up Hardware*

- 2.1 Introduction 7
- 2.2 Wind River Probe Components 8
- 2.3 Unpacking Information 8
- 2.4 Wind River Probe Description 9
- 2.5 Layout Drawings 11
- 2.6 Connecting Wind River Probe to a Host 11
- 2.7 Connecting Wind River Probe to a Target 12

### 2.1 Introduction

This chapter describes all of the hardware that is included with Wind River Probe and explains how to connect it correctly to the target and host.

For Wind River Probe to function correctly, you must:

- Install Wind River Workbench



---

**NOTE:** To install the drivers for the Wind River Probe you must have administrator privileges on your computer.

---

- Connect Wind River Probe to a host

- Connect Wind River Probe to a target

This chapter discusses these steps and provides some general information about the Wind River Probe hardware.



**NOTE:** Wind River Workbench must be installed on your host computer before you connect the Wind River Probe. If you connect the Wind River Probe before you install Workbench, Wind River Probe may not communicate properly with Workbench.

---

## 2.2 Wind River Probe Components

The following list describes all of the components included with the Wind River Probe shipment. If any components are missing, please contact Wind River Customer Support.

- Wind River Probe unit
- 1 High Speed USB cable
- 1 target-specific adapter

## 2.3 Unpacking Information



**CAUTION:** Handle Wind River Probe with caution and take measures to prevent electrostatic discharge.

---

Remove Wind River Probe from its box and place it on the desk or bench so that it is not covered. Remove any packing materials to ensure proper cooling. Wind River Probe operates without requiring additional cooling.

## 2.4 Wind River Probe Description

This section describes all the features that are physically located on the Wind River Probe unit. The descriptions are high-level, and meant to be used strictly as a method of becoming familiar with the unit. To make use of these features, see [4. Establishing Communications](#).

### 2.4.1 Top of Wind River Probe

[Figure 2-1](#) shows a labeled diagram of the top of the Wind River Probe unit. Use this diagram to locate the components described in this section.

Figure 2-1 **Top view of Wind River Probe**

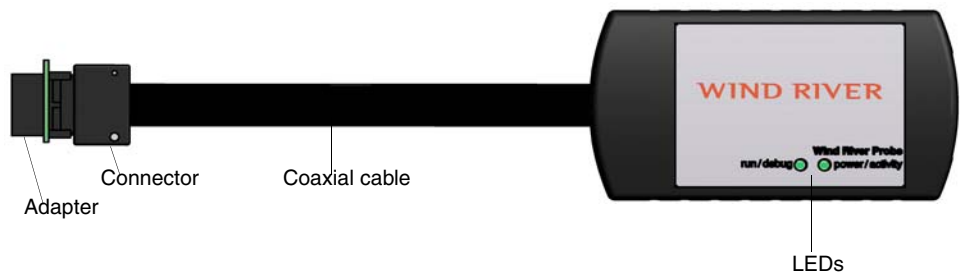

#### Wind River Probe LEDs

There are two **LEDs** located on the top of the Wind River Probe enclosure. [Table 2-1](#) describes the function of each **LED**.

Table 2-1 **Wind River Probe LED Descriptions**

LED	Description
Power/Activity	When steady green, this indicates that power is applied to the Wind River Probe. This means that Wind River Probe is ready for normal operation. When flashing green, it indicates activity.
Run/Debug	When steady green, this <b>LED</b> indicates that Wind River Probe is in Run mode.  When steady yellow, this <b>LED</b> indicates that Wind River Probe is in Debug mode. When flashing yellow, it indicates that Wind River Probe is in Error mode and cannot communicate with the target correctly. Fix this problem before you continue.

## Probe Cable and Connector

Wind River Probe is built with a permanent high-speed coaxial cable with a universal debug connector, which connects ground first and corrects for differences in ground voltage potentials. This allows Wind River Probe to be hot-plugged to a live target.

### 2.4.2 Target-specific adapter

Wind River Probe is shipped with a target-specific adapter ([Figure 2-2](#)) which connects to the OCD port on your target and is necessary for configuring Wind River Probe for specific target architectures. Connecting this adapter to the end of the Wind River Probe cable allows Wind River Probe to be used over several architectures. See [2.7 Connecting Wind River Probe to a Target](#), p.12.

Figure 2-2 Target-specific adapter (16-pin version shown)

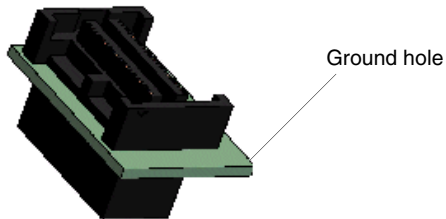



## 2.5 Layout Drawings

Figure 2-3 shows the dimensions of the Wind River Probe unit. All dimensions are in inches unless otherwise noted.

Figure 2-3 **Layout Drawings**

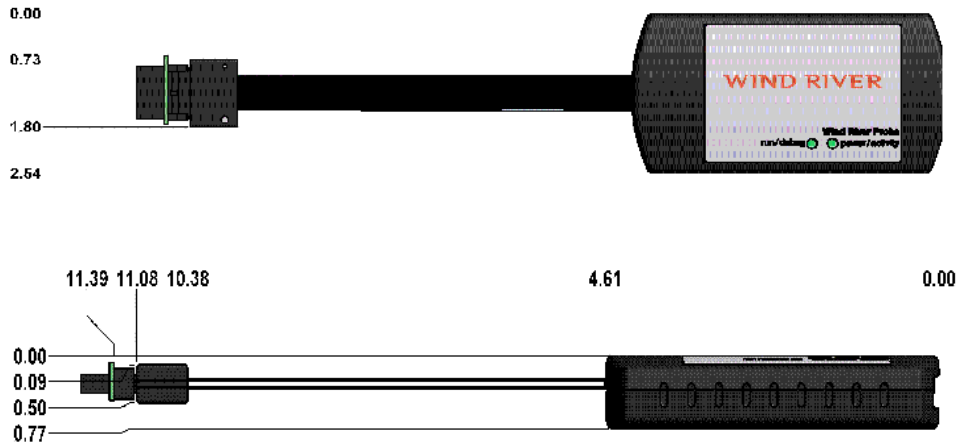

## 2.6 Connecting Wind River Probe to a Host

In order for Wind River Probe to function correctly, it must be properly connected to a host computer. The supplied USB cable connects Wind River Probe to a USB port on your host computer.

The cable is a 6-foot High Speed USB 2.0-compliant cable with one USB type A connector and one five-wire mini-B connector.



**NOTE:** Wind River Probe must be connected to a high-powered USB port. If connected to a low-powered USB port, for example a port on a bus-powered hub, Wind River Probe may not function correctly.

---

➔ **NOTE:** Use only the supplied USB cable to connect Wind River Probe to your host. Substituting a different cable may result in Wind River Probe failing to work correctly.

---

To connect Wind River Probe to your host:

1. Insert the A connector of the USB cable into the USB port on your host computer. Insert the five-wire mini-B connector of the USB cable into the port on the back of the Wind River Probe unit as shown in [Figure 2-4](#).

Figure 2-4 **USB connector**

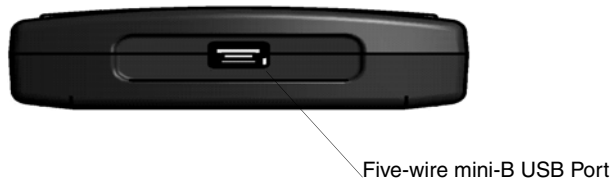

## 2.7 Connecting Wind River Probe to a Target

---

⚠ **CAUTION:** Under no circumstances should the Wind River Probe unit be connected to a target if there is a ground difference capable of supplying high current.

---

First connect the target-specific adapter to your target board, then connect the Wind River Probe coaxial cable to the adapter. Connect to the target in this order. (See [Figure 2-5](#) for proper connection procedure.)

To connect Wind River Probe to a target for hot-swapping capability, complete the following steps.

1. Make sure Wind River Workbench is installed on your host computer.
2. Connect adapter to your target.



---

**CAUTION:** Make sure the pin labeled **1** on your adapter lines up with the pin labeled **1** on the OCD port on your target. Pin 1 on the adapter is on the corner of the adapter marked with a white triangle.

---

3. Connect the Wind River Probe cable to the adapter.

### 2.7.1 **Grounding Wind River Probe and the Target**

If Wind River Probe is used under conditions where the adapter must remain attached to the Wind River Probe cable, a grounding procedure may be needed. The target adapter is equipped with a ground hole for this purpose. To prevent damage to either the Wind River Probe unit or the target board, complete the following steps.

1. Attach a ground wire to the ground hole on the flange of the adapter (See [Figure 2-2.](#))
2. Connect this ground wire to your target.
3. Connect the adapter to your target. Make sure that the ground pin on your target is the first point to make contact.

Figure 2-5 Connection Procedure

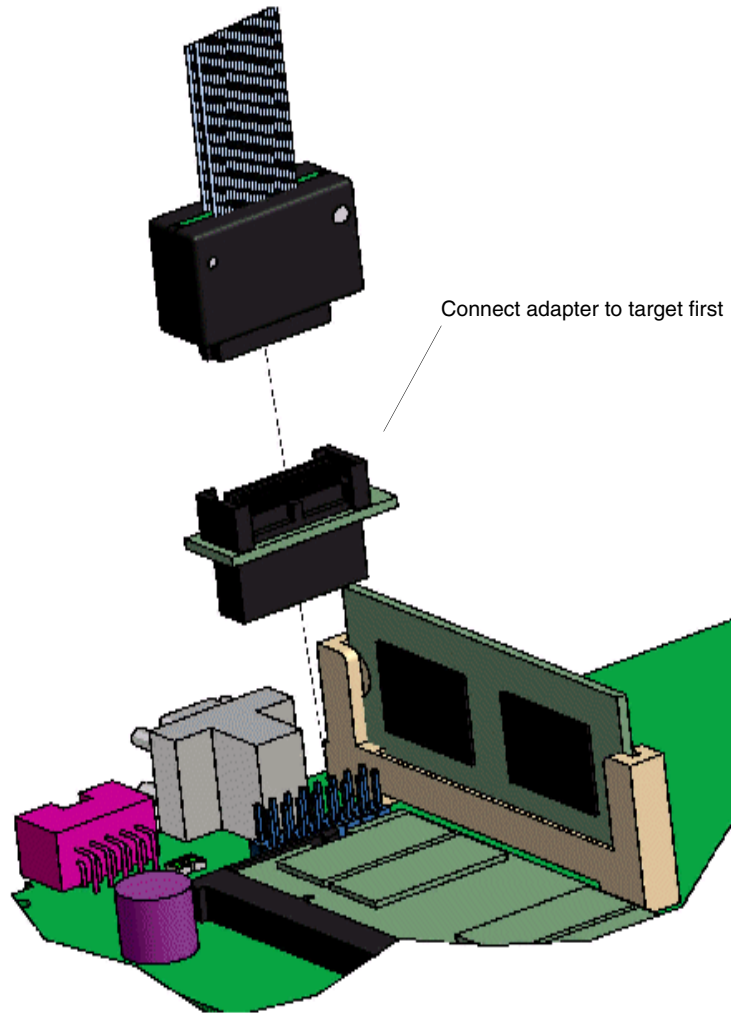

# 3

## *Installing Drivers*

- 3.1 Introduction 15
- 3.2 Windows Hosts 15
- 3.3 Linux Hosts 16

### **3.1 Introduction**

The installation DVD shipped with your Wind River Probe contains drivers for both Windows and Linux hosts.

### **3.2 Windows Hosts**

On Windows systems, Administrator privileges are required to install the drivers for the Wind River Probe.

To install the drivers for the Wind River Probe, insert the Workbench installation DVD into your computer's DVD drive and follow the steps in the installation wizard.

Windows XP users may see a screen prompt that states that the drivers for Wind River Probe are not logo-certified by Microsoft. This will not affect the performance of the Wind River Probe. You should continue when prompted to do so.

### 3.3 Linux Hosts

The Wind River Probe USB driver must be rebuilt for the kernel you are using; therefore the kernel source is required. The name of the kernel source RPM is either **kernel-source-....** or **kernel-devel-....**, depending on the version of Linux you are using. If you do not have your kernel source, you can obtain it from:

<http://rpmfind.net/linux/RPM>

Also, you must have the **rpmbuild** and **gcc** packages installed on your system.

To use the Wind River Probe, you must install both the **WRProbeService** and the Jungo USB driver. This RPM package handles the installation of both these products.

There are two commands required to complete the installation. The first command extracts all the source and rebuilds the driver module (**windrvr6**) for the kernel in use. It then packages these files into a binary RPM for installation. The second command unpacks the binaries and installs them on your system.

The binary RPM package that gets created is put in a directory dependent on the **rpmbuild** installation. The last few lines of output from the **rpmbuild** command display the location of the binary RPM file to use.

If the **WRProbeDriver** package already exists on your system, you should uninstall it before this installation. To see if the package exists on your system, run the following command:

```
rpm -q WRProbeDriver
```

To uninstall, login as root and run the following command:

```
rpm -e WRProbeDriver
```

To install the driver, login as root and run the following commands:

```
rpmbuild --rebuild WRProbeDriver-${SVC_VER}_${DRV_VER}-${REL}.src.rpm
```

```
rpm -ivh ${RPM_OUTPUT_DIRECTORY_FROM_LAST_CMD}/WRProbeDriver-${SVC_VER}_  
${DRV_VER}-${REL}.i386.rpm
```

where the macros are:

<code>\${RPM_OUTPUT_DIRECTORY_FROM_LAST_CMD}</code>	-- Directory where the new RPM file is located
<code>\${SVC_VER}</code>	-- <b>WRProbeSvc</b> version
<code>\${DRV_VER}</code>	-- Version of USB driver
<code>\${REL}</code>	-- RPM release number



---

**NOTE:** Although this installation makes every attempt to use the appropriate source code to build the module, it will fail without a clear error code in one specific circumstance. If the file `/lib/modules/`uname-r`/source/include/linux/version.h` contains a version number that does not match the version of the running kernel, the build process may not work properly. Please be sure to check this if the installation fails.

To recover from this situation, uninstall all kernel source packages, reinstall the correct source package, then reinstall this package.

---





# 4

## *Establishing Communications*

- 4.1 Introduction 19
- 4.2 Connecting to the Wind River Probe 20
- 4.3 Setting up a Project 32
- 4.4 Downloading Code 35
- 4.5 Initializing the Target 44
- 4.6 Working with Wind River Probe 46
- 4.7 Moving On 50

### 4.1 Introduction

After you install the Wind River Workbench software and connect the Wind River Probe hardware, use Workbench to establish communications with your target.



---

**NOTE:** This chapter assumes that the Wind River Workbench software is installed and running on your host computer.

---

Workbench enables you to use both high and low-level commands to work with your target. After you establish communications with your target, you can use the Workbench Graphical User Interface (GUI) to work with your target.

If you are more comfortable using low-level commands, you may do so from the **OCD Command Shell** in Workbench. For details on low-level commands, see the *Wind River Workbench for On-Chip Debugging Command Reference*.

## 4.2 Connecting to the Wind River Probe

Before you attempt to establish communications, please make sure that all hardware is properly connected to the host and the target, and that connections are tight (See [2. Setting Up Hardware](#) for more information).

To establish a connection with the Wind River Probe, use the following steps.

1. Launch Wind River Workbench according to the method for your host.

### Linux/Solaris Hosts

From your installation directory, issue the following command:

```
$ ./startWorkbench.sh
```

### Windows Hosts

Select **Start > Programs > Wind River > Wind River Workbench 2.6.1 > Wind River Workbench 2.6**.

Wind River Workbench launches.

2. Specify a workspace.

For Windows hosts, Workbench displays a dialog where you can specify a location for your workspace. For Linux hosts, the workspace defaults to *installDir/workspace*.

After you specify your workspace, Workbench opens and the **Quick Target Launch** dialog appears.

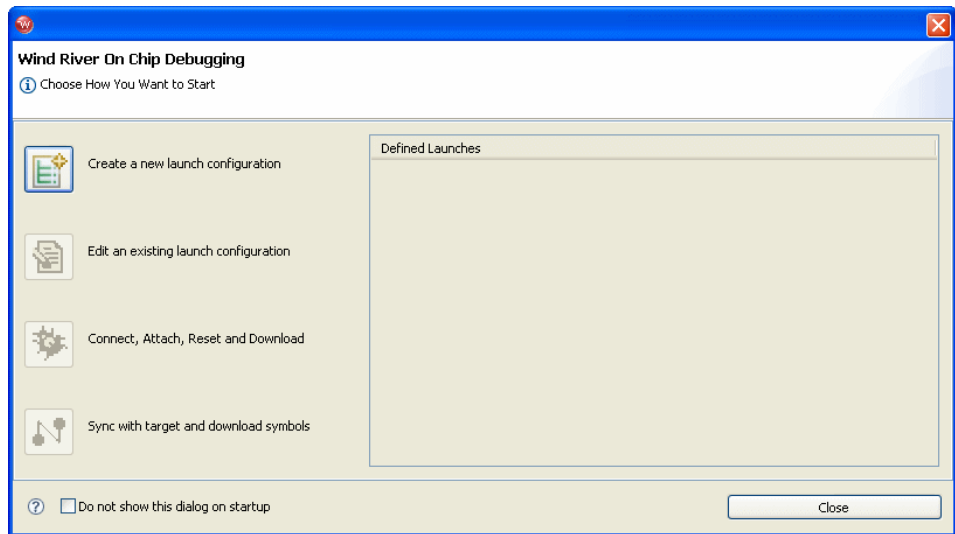

The **Quick Target Launch** dialog allows you to create a launch configuration to initialize your target and download symbols and code. Once created, the launch configuration is persistent, so you can return to it at any time.

If this is the first time you have launched Workbench, the only available option is **Create a new launch configuration**. The next time you open Workbench, the **Quick Target Launch** dialog will give you the option of re-launching the same launch configuration or creating a new one.

3. Select **Create a new launch configuration**.

The **New Connection Wizard** appears.

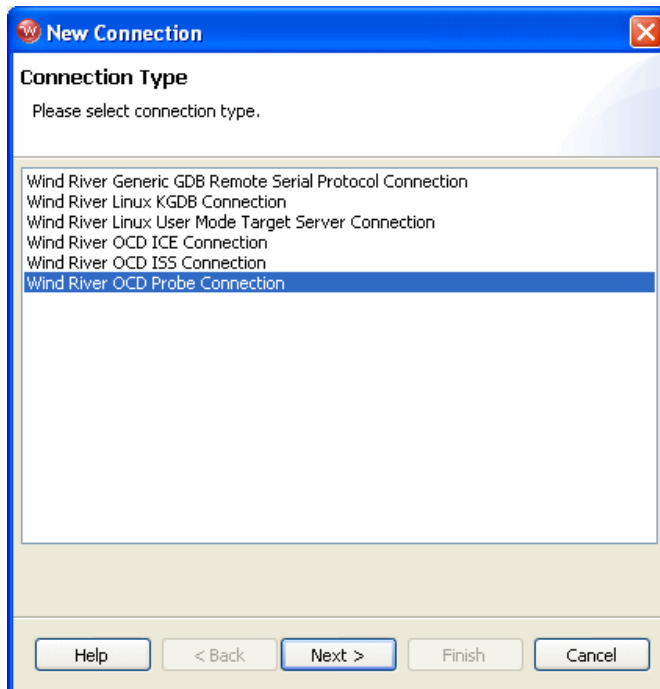

4. Choose **Wind River OCD Probe Connection** from the list of options and click **Next**.

The **Settings** dialog appears.

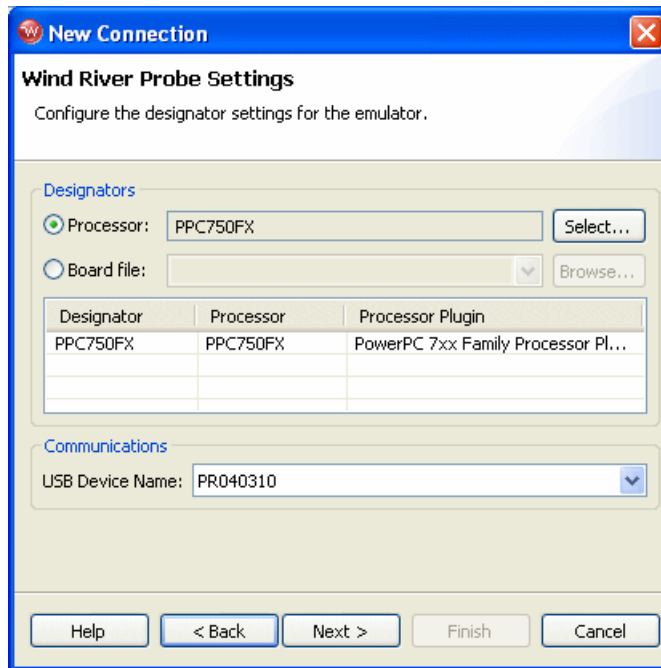

5. Click **Select** to choose from a list of available target processors.
6. If a board file is necessary for your target board, check the **Board File** field and click **Browse** to specify the board file.



**NOTE:** Multi-core debugging is not supported for the Wind River Probe. Unless your target board has more than just the processor on the JTAG scan chain, you do not need to select a board file. (For example, the Wind River SBC405GP board has some FPGAs on the scan chain, so it does require a board file.)

7. The field below the **Board File** field populates with a summary description of your board.

The **USB Device Name** field automatically populates with the serial number of your Wind River Probe unit.



**NOTE:** Because Wind River Probe uses a USB connection, several Wind River Probe units may be connected to your host computer at the same time. Make sure the **USB Device Name** field contains the serial number from the Wind River Probe unit you wish to use.

8. Click **Next**.

The **Target Operating System Settings** dialog appears.

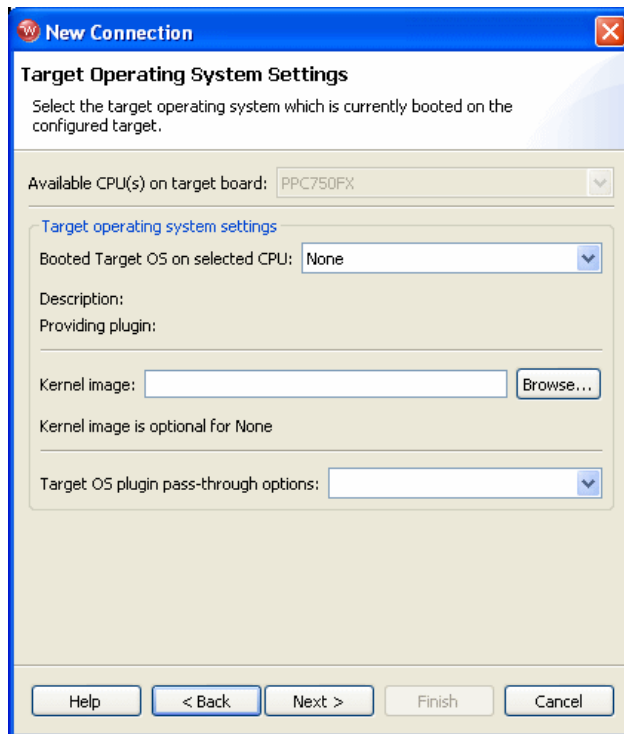

9. In the **Booted Target OS on selected CPU** field, select the operating system that is running on your target processor. The default is **None**.
10. Next to the **Kernel Image** field, click **Browse** to navigate to the kernel image you wish to specify. If you selected **None** in the previous step, you do not need to specify a kernel image.

11. If you are using a Linux plug-in, specify the pass-through options in the **Target OS Pass-Through Options** field. If you are not using a Linux plug-in, skip this step.

Options are passed as pairs in the format *name='value'*. Separate options with a comma. The following options are available:

- **notasklist=1** : Never fetch process list.
- **noautomodules=1** : Do not plant internal breakpoints to do automatic kernel module load/unload detection. When this option is specified, you must manually refresh to see an updated module list.
- **noloadcheck=1** : Do not issue gophers until the hardware breakpoint is used to detect kernel load triggers. This option is for “sensitive” boards that don’t accept access until the kernel loads and sets up memory mapping.
- **loaddetectloc=*symbol* or *address***: Set the hardware breakpoint used to detect kernel load at *symbol* (for example, **loaddetectloc=start\_kernel**) or *address* (for example, **loaddetectloc=0x1000**). If you do not specify a symbol or address, Workbench uses a default. For most architectures the default is **start\_kernel**; for PowerPC targets, the default is **0x0**.

12. Click **Next**.

The **Memory Options** dialog appears.

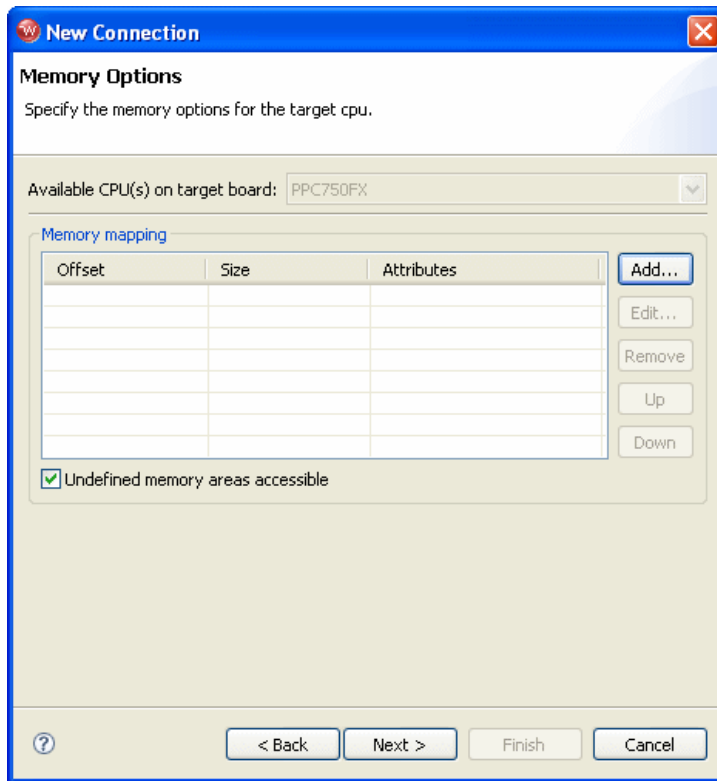

Use the **Memory Options** dialog to specify how memory on the target is partitioned, and what the attributes of the particular memory regions are.

➔ **NOTE:** The **Memory Options** dialog is only necessary for Linux or other non-VxWorks target operating systems.

To specify an area of memory, click **Add**.

The **Set Memory Map** dialog appears.



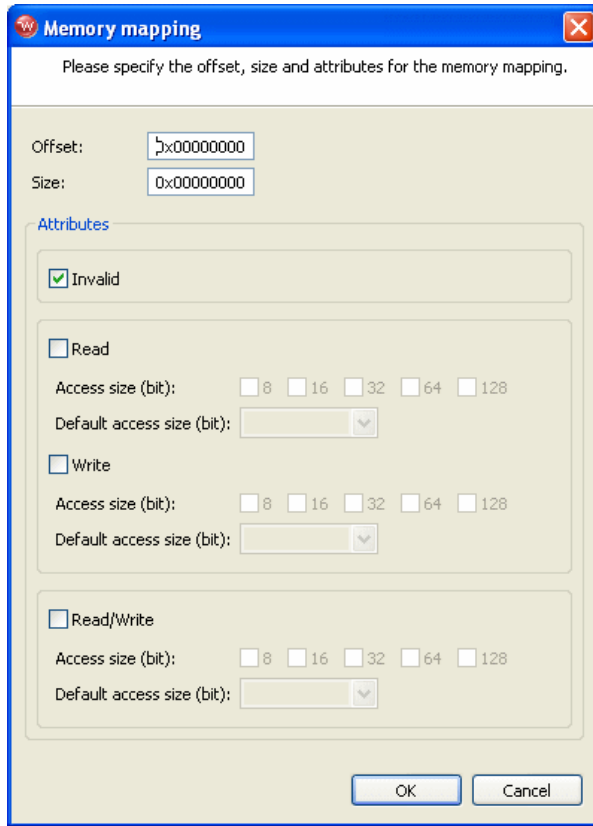

Use the **Set Memory Map** dialog to specify which memory areas are read-only, read-write, or write-only, and to specify the access width Workbench should use to read the data from those regions.

13. Click Next.

The **Object Path Mappings** dialog appears.

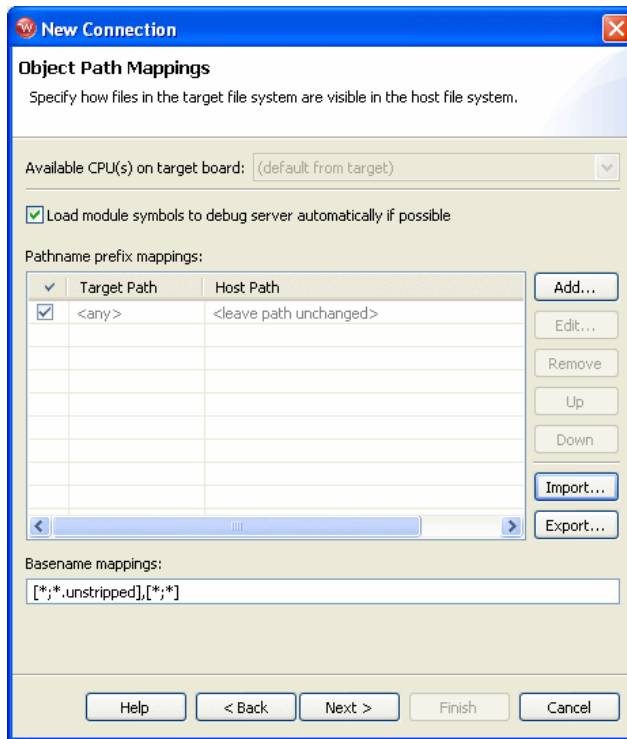

Use the **Object Path Mappings** dialog to specify how files in the target file system are visible in the host file system.

14. To add a host or target path, click **Add...** and type the path in the dialog that appears.
15. Click **Next**.

The **Target State Refresh** dialog appears.

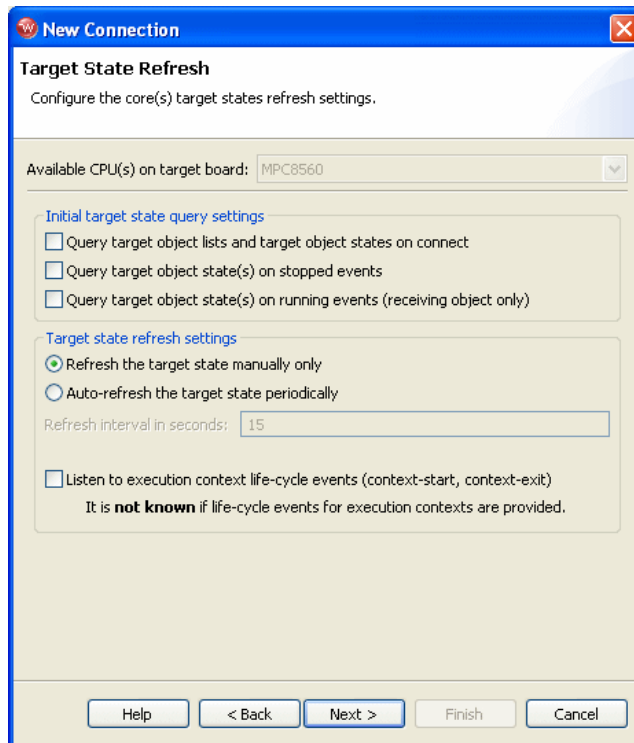

Use the **Target State Refresh** dialog to configure the target state query and target state refresh settings on your target processor.

16. Click **Next**.

The **Default Breakpoint Options** dialog appears.

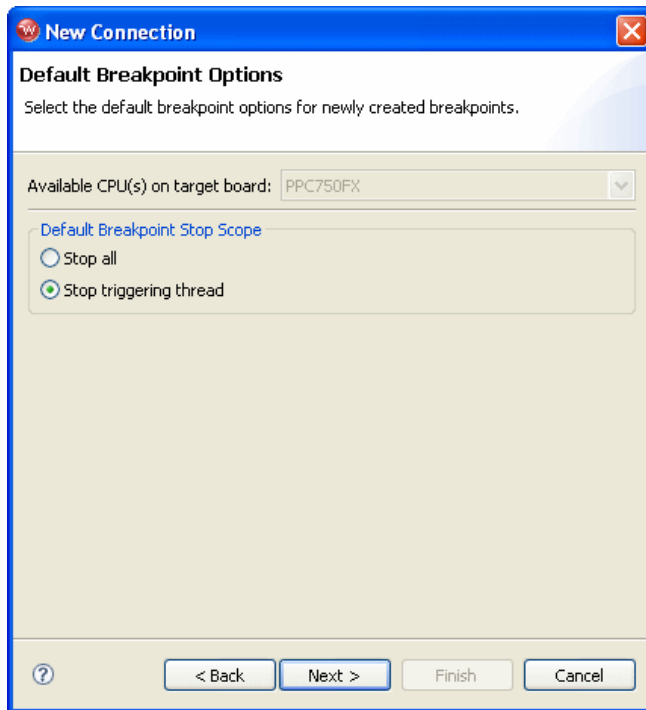

Use this dialog to set default breakpoint options for newly created breakpoints.

17. Click **Next**.

The **Connection Summary** dialog appears. Inspect the displayed values to make sure they are correct.

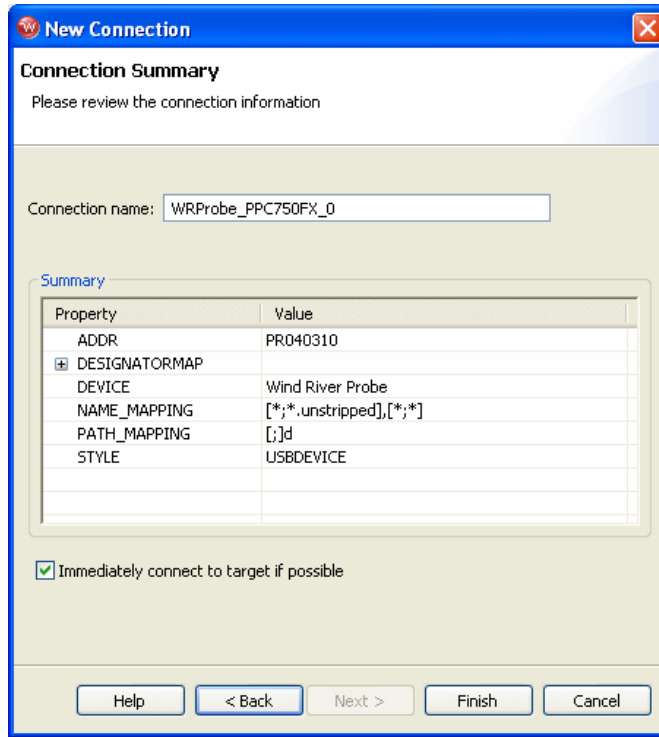

18. If you want to connect to your target now, select **Immediately connect to target if possible**.



---

**NOTE:** If you clear the **Immediately connect to target if possible** box, Workbench will not connect to your target. You can connect at any time by right-clicking on the target name in the **Target Manager** view and selecting **Connect**.

---

19. Click **Finish**.

When you click **Finish**, you will see your target name appear in the **Target Manager** view.

If your connection attempt is successful, a **>BKM>** prompt appears in the **OCD Command Shell**.

If an **>ERR>** prompt appears in the **OCD Command Shell**, or if an error message similar to the one shown in [Figure 4-1](#) appears when you try to connect, it indicates that problems have occurred during your communication attempt.

Figure 4-1 **Connection Error Message**



If you have problems establishing communications with your target, it is either because there is an error between Wind River Probe and the host or Wind River Probe and the target. See [5. Troubleshooting](#) for more information.

Workbench allows you to run and debug code either in combination with the Workbench project management facility, or without using a project. If you want to use a Workbench project to run and debug code, continue to [4.3 Setting up a Project](#), p.32. If you want to run and debug code without using a Workbench project, skip to [4.4 Downloading Code](#), p.35.

## 4.3 Setting up a Project

Several example projects are included in Wind River Workbench for demonstration purposes. To open a new demonstration project, use the following steps:

1. Select **File > New > Example**.

The **New Example** wizard appears.

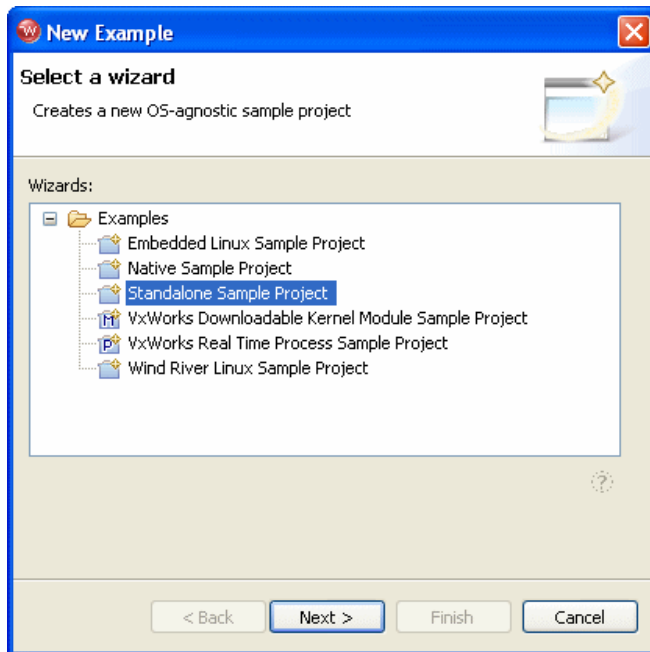

2. Select **Standalone Sample Project** and click **Next**.  
The **Sample Project** template appears.

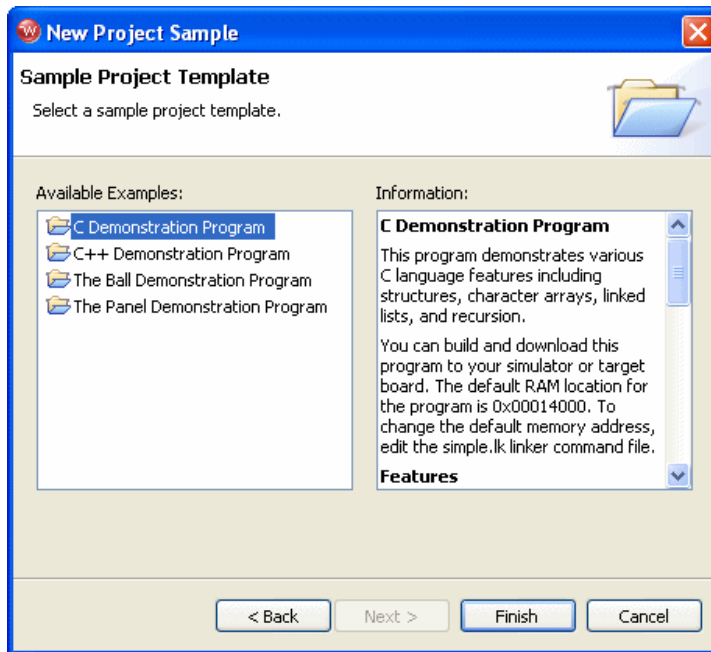

3. Select **C Demonstration Program** and click **Finish**.

The project name `c_demo_sa` appears in the **Project Navigator** view.

4. Click on the "+" next to the project name to expand it.  
A list of available build specs appear.



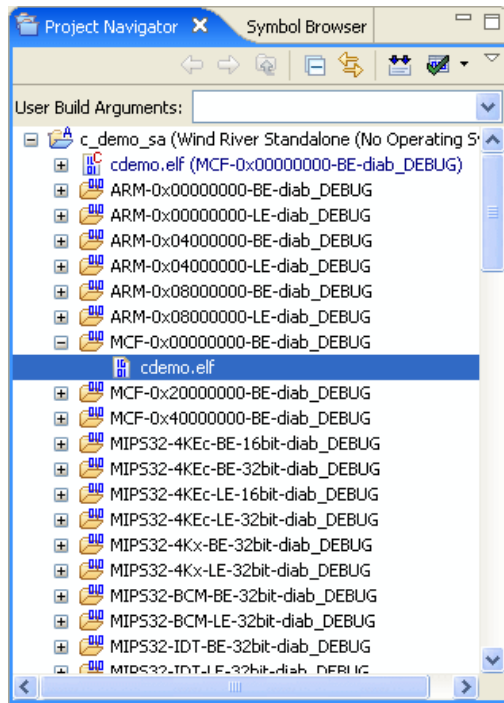

## 4.4 Downloading Code

The **Reset and Download** view initializes your target and downloads an executable file. To perform a reset and download, use the following steps.

1. Highlight your target name in the **Target Manager** view.
2. Click the **OCD Reset and Download** button.

You can also right-click on your selected target name and choose **Reset and Download...** from the context menu.

The **Reset and Download** view opens displaying the **Main** tab.

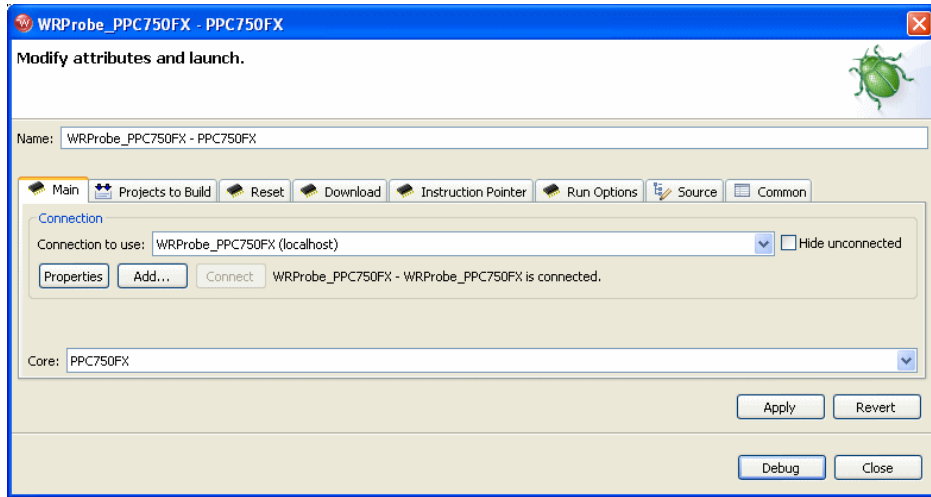

#### 4.4.1 Projects to Build Tab

1. Select the **Projects to Build** tab.

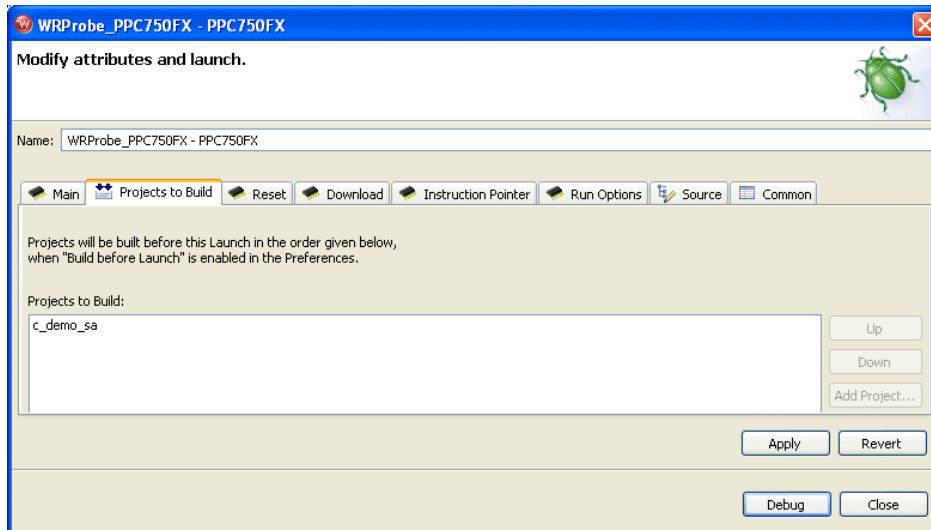

If you want Workbench to build your project before launching the reset and download operation, specify your project here. In the **Projects to Build** tab, select **Add Project**. From the list of available projects that appears, select the project you want to build and click **OK**.



**NOTE:** To enable this operation, make sure your launching preferences are correctly set. In the Workbench toolbar, select **Window > Preferences > Run/Debug > Launching**. In the **General settings for launching** field, make sure the **Build (if required) before launching** checkbox is selected. This checkbox is selected by default.

## 4.4.2 Reset Tab

1. Select the **Reset** tab.

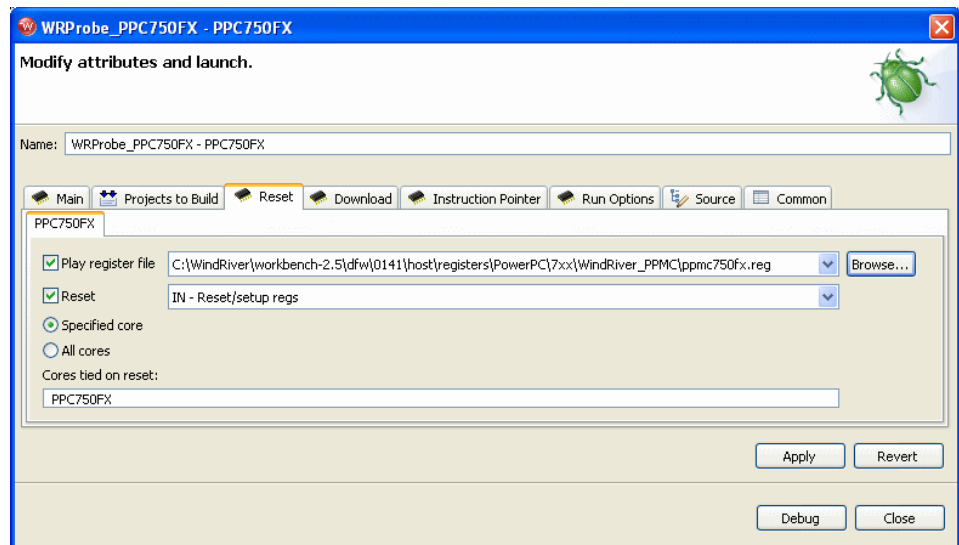

2. If you want to configure the target register values with a register file, select **Play Register File** and browse for the file you want to use.

This example shows a Wind River PPMC750FX target; the Wind River register file for this target is **ppmc750fx.reg**, located in *installDir/workbench-2.x/dfw/build/host/registers*, in the directory **PowerPC/7xx/WindRiver\_PPMC**.

If you do not want to reconfigure your target registers, leave this box unchecked.

3. Choose the type of reset initialization you want to perform.

You can use the **IN** or **INN** initialization commands. For a full discussion of these two commands, see [4.5 Initializing the Target](#), p.44.

You can also choose not to perform an initialization by clearing the **Reset** box.



**CAUTION:** If you are manually changing registers on your target, be aware that issuing an **IN** or **INN** initialization command will overwrite your changes.

4. Choose which core your reset and download will affect.

**Specified Core** is selected by default. Multi-core debugging is not supported for the Wind River Probe, so you do not need to set this option.

### 4.4.3 Download Tab

1. Select the **Download** tab.

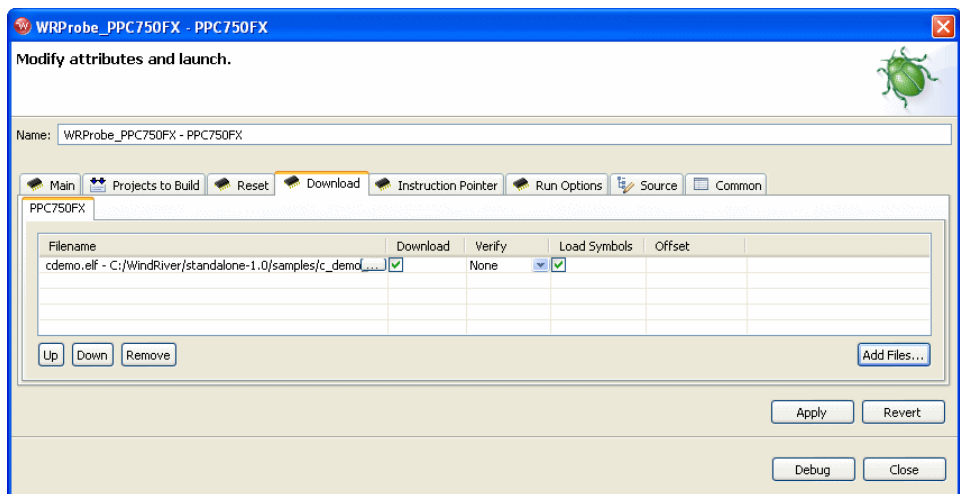

2. Click **Add Files**.

In the browser window that appears, navigate to the executable file you want to run. This example shows the PowerPC version of the executable **cdemo.elf** file from the sample C Demonstration Project.

The file you select appears in the **Filename** field. Repeat this process as many times as necessary.

The file at the top of the list will download to the target first, followed by the others from the top down. You can edit the order of the list by clicking on any filename to highlight it and using the **Up**, **Down**, and **Delete** buttons.

3. Use the other fields to configure the download.

### Download

The **Download** field is checked by default. If you clear it, the file will remain on the list but will not download data to the target. This is useful if, for example, you only want to download symbol information and not data.

### Verify

The **Verify** field configures the extent to which the file you are downloading will be compared to a file that may already be on the target. There are three options: **Full**, **Compare**, and **None**.

When this field is set to **Full**, a write/read verify will occur for every download. Workbench will write to the target and then verify that the write to the target and the read from the target are identical. This is slower than a normal download, but it is a useful security option.

When the field is set to **Compare**, Workbench will verify that the image has been downloaded correctly (that is, that the image on the host is the same as the image on the target.) This is useful for programming flash.



---

**NOTE:** You should only set the **Verify** field to **Compare** if an image already exists on the target. If you set the field to **Compare** when there is no image on the target, Workbench will look for a file to compare and not find one, and the reset and download operation will fail.

---

When the field is set to **None**, Workbench will perform no verification.

The **Verify** field is set to **None** by default.

## Load Symbol

The **Load Symbol** field, which is checked by default, determines whether the file's symbol information is downloaded to the target.

## Offset

In the **Offset** field, you can enter a value in hex to set a memory offset bias for your application file. If you do not enter a value, Workbench uses the default value **0x00000000**.

### 4.4.4 Instruction Pointer Tab

1. Select the **Instruction Pointer** tab.

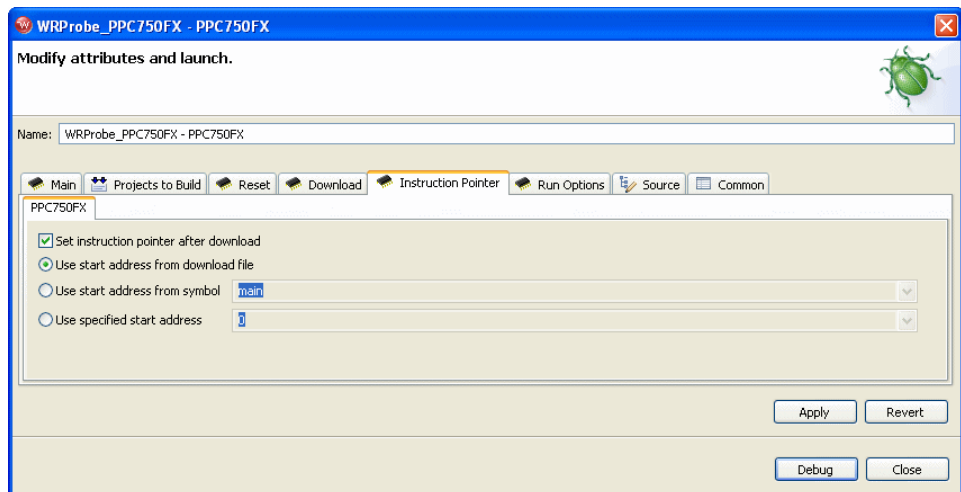

2. Set the starting point for your file.

By default, the instruction pointer is set to use the starting address from the download file.

You can set the instruction pointer to start the file from the first occurrence of a particular symbol (for example, **main**) or you can just specify a starting address by entering the address value in hex in the **Use Specified Start Address** field.

If you do not want to set a starting point, clear the **Set Instruction Pointer After Download** box.

#### 4.4.5 Run Options Tab

1. Select the **Run Options** tab.

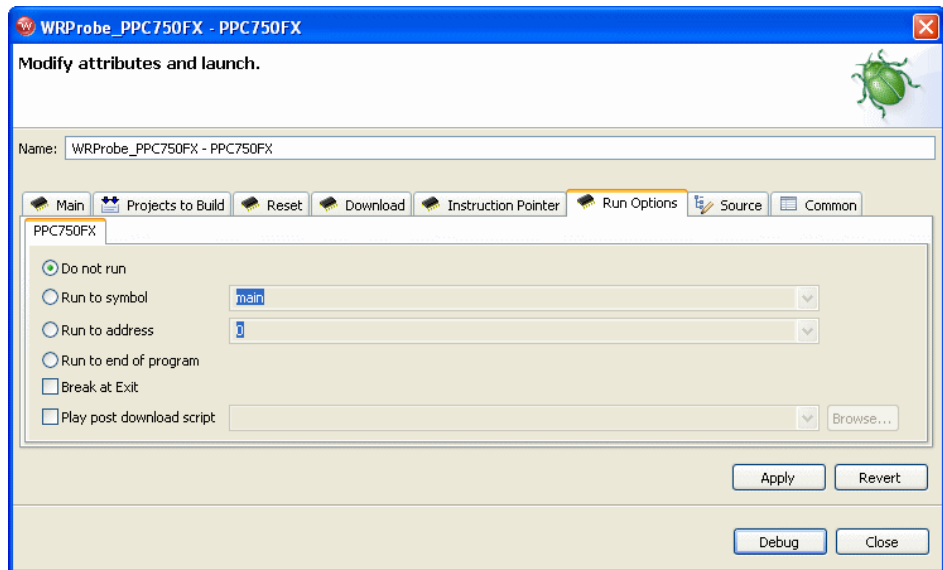

2. Determine how you want your file to run.

By default, the **Reset and Download** view is set not to run the file after downloading. If you want the file to run, you have several options to determine where it should break:

- You can set it to break at the first occurrence of a symbol (for example, **main**) by selecting **Run to Symbol** and entering the symbol in that field.
- You can set it to break at the end of your program by selecting **Run to end of program**.
- You can set it to break at a given memory address by selecting the **Run to Address** box and entering the address in hex in that field.
- You can set it to break at an `_exit` routine by selecting the **Break at Exit** box.

If you need to perform a post-initialization, you can define it here. Select the **Play post download script** box and click **Browse**. In the browser window that appears, navigate to your initialization file.

#### 4.4.6 Source Tab

1. Select the **Source** tab.

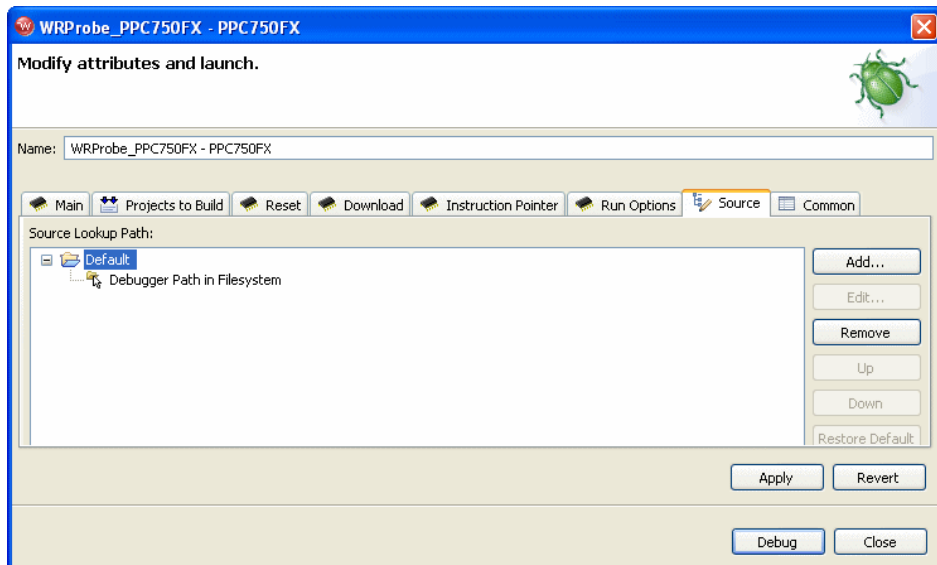

2. Use the **Source** tab to configure the source path of your file.

Workbench uses the input path of the local file system by default. Unless you need to use a different path, you do not need to do anything in the **Source** tab.

If you need to use a different path, click **Add...** and use the **Add Source** dialog to configure the appropriate search path for your project.

#### 4.4.7 Common Tab

1. Select the **Common** tab.



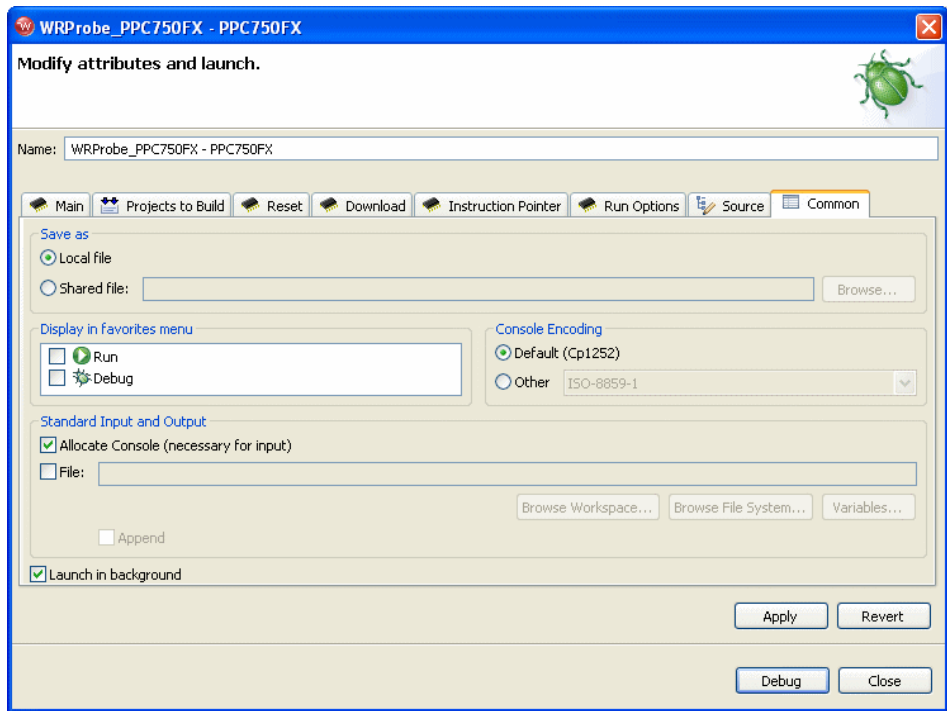

2. Specify whether your launch configuration is local or shared.  
The configuration is local by default. To make it shared, click **Shared file:** and browse to the shared directory where you want the configuration to be located.  
You have now fully defined your reset and download operation.

#### 4.4.8 Executing the Reset and Download

1. Click **Debug**.  
This resets the target and downloads the specified file.  
Workbench will first initialize the target board, then download the file, then run the file.  
The **OCD Console** view opens to show the progress of the reset and download operation.

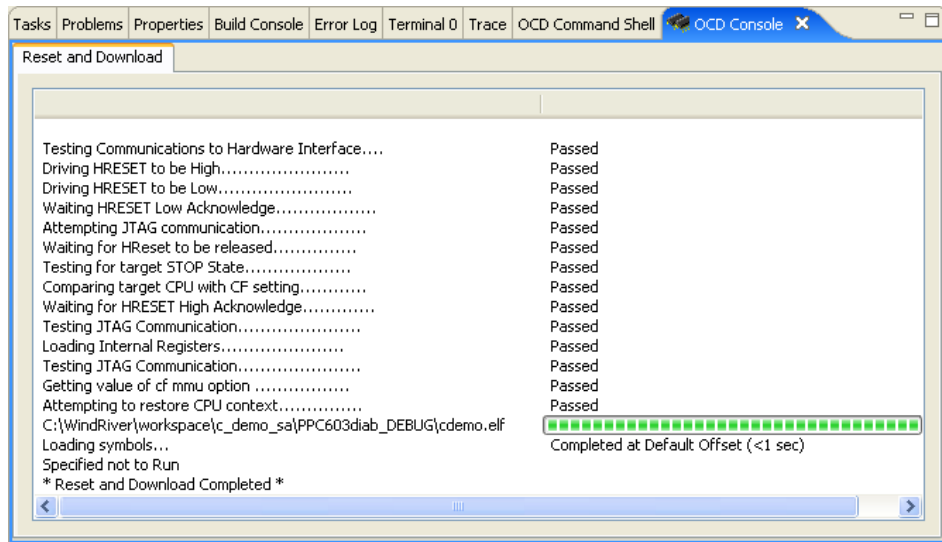

You can now step through instructions and debug code using the **Resume** and **Suspend** buttons in the **Debug** view. For information on debugging, see the *Wind River Workbench User's Guide*.

## 4.5 Initializing the Target

When you make changes to your target using Wind River Probe and Wind River Workbench, you may have to initialize the target for those changes to take effect. You must initialize the target when you first try to establish communications with it. Similarly, if the code you run on your target causes the connection to be lost, then you also need to initialize the target in order to restore that connection. Initialization is also required if you change register settings in Workbench and want the changes to be reflected in the target.

The target is initialized whenever you first establish a connection using Workbench. If you need to initialize the target when you are debugging, use either the **IN** or the **INN** command.

The **IN** and **INN** commands are low level target initialization commands, and they are the easiest way to initialize the target when you work in the **OCD Command Shell**.

The **IN** or **INN** command can be executed at a **>BKM>** or **>ERR>** prompt. If a **>RUN>** prompt is visible, stop the target by typing **CTRL+C**, **CTRL+X**, or by typing **HALT**. The target stops running and a **>BKM>** prompt appears.

The **IN** and **INN** commands differ in that the **IN** command copies the register information that is stored on the host PC down to the target after it is placed in debug mode, whereas the **INN** command places the target in debug mode without overwriting the target registers, leaving them in their default reset state. More information about register settings is available in the *Wind River Workbench for On-Chip Debugging User Tutorials*. The following sections describe the **IN** and **INN** command in greater detail.

### **INN Command**

The **INN** command is a low level command that is used to place the target processor into debug mode. In order to get a processor into debug mode, the reset line of the processor is asserted and then released. As a consequence of entering debug mode, the processor and its peripherals on the target board are forced into their reset state and all of the internal registers are forced to their manufacturer's reset value.

### **IN Command**

The **IN** command does two different things. First, as with the **INN** command, it places the target board into debug mode. Second, it copies all of the register information that is stored on the host PC down to your target.

Wind River Probe writes register values to the target for all of the register groups that are enabled at the time of initialization. Even if code is located on the target to properly configure the registers, Wind River Probe still overwrites the values when it first establishes communications (is initialized). For that reason, it is important to make sure that the register settings that are stored on your PC match any register configuration code on the target. Use the **SCT DIFF** command to display the differences between the registers stored on your host PC and the registers on your target. More information about this command is available in the *Wind River Workbench for On-Chip Debugging Command Reference*, and more information about register configuration is available in the *Wind River Workbench for On-Chip Debugging User Tutorials*.

If you do not want Wind River Probe to configure the registers during initialization, use the **INN** command instead of the **IN** command.

After initialization is completed, output displays in the **OCD Command Shell**:

```
>BKM>in
*****
Wind River Probe Initialization Sequence.
Copyright (c) Wind River systems, Inc. 1999-2005. All Rights Reserved.
*****
Support Expires.....4/20/06
Target Processor.....PPC750FX:U1
Wind River Probe      Group ID#= 0
Wind River Probe      Serial#= U1234567      Firmware= pr3.0a
Type CF For a Menu of Configuration Options
Initializing Background Debug Mode.....Successful
>BKM>
```

The information includes the version number of the hardware, the target processor, and the operation mode.

## 4.6 Working with Wind River Probe

When you are in debug mode and have a **>BKM>** prompt visible in the **OCD Command Shell**, you can verify that Wind River Probe and your target work together correctly, and you can begin to work with your system.

This section provides a brief description of some of the tasks that you can perform with your Wind River Probe unit. Detailed instructions and descriptions for performing most tasks are described in the *Wind River Workbench for On-Chip Debugging User Tutorials*. In addition, a complete command reference of the low-level Wind River Probe commands is included in the *Wind River Workbench for On-Chip Debugging Command Reference*. You can enter any of those commands at the **> BKM >** prompt in the **OCD Command Shell** with the correct syntax as described in the Command Reference.

### 4.6.1 Configuration Options

To see the configuration options available for your target, open the **Device Debug** perspective in Workbench and click on **Window** in the toolbar. From the drop-down list that appears, choose **Show View > CF Options View**.

[Figure 4-2](#) shows an example of the CF options that are available for a PPC750FX target.

Figure 4-2 CF Options

Command Name	Current Setting	Parameters	Description
SB	SB	[SB, THBC]	Set BreakPoint
VECTOR	LOW	[HIGH, LOW, IGNORE]	Vector Table Location
RST	YES	[YES, NO, HALT, RUN]	Monitor Target reset
TAR	750FX	[AUTO, 603E, EC603E, 603P, 603...	Target CPU
SLAVE	NONE	[NONE, 8260]	Target CPU( SLAVE )
SLIMMRVAL	AUTO	[AUTO, VALUE]	Slave IMMR reset value
CLK	16	[0.025, 0.3, 0.5, 1, 3, 6, 12, 16, 20]	JTAG clock rate
RTP	NO	[YES, NO]	Real time Preservation
LENDIAN	NO	[YES, NO]	Little Endian Mode
MODE	64	[32, 64]	Processor Mode
DLD	NORMAL	[NORMAL, 8]	Download Mode
HRESET	ENABLE	[ENABLE, DISABLE]	Emulator HRESET Control
CMDRST	BOTH	[IN, RST, BOTH]	Emulator HRESET Command Control
PAR	NO	[YES, NO]	Data Parity Checking
TRESET	ACTIVE	[OPENC, ACTIVE]	Drive TReset line
TRGIN	OFF	[OFF, LEVELHI, LEVELLO, EDGEHI, ...	External Trigger In
TRGINFILTER	OFF	[OFF, ON]	Trigger In Filter Mode
TRGOUTMODE	OFF	[OFF, ONALLSTOPS, ONBREAKPOI...	Trigger Out Mode
TRGOUT	LEVELHI	[LEVELHI, LEVELLO, PULSEHI, PUL...	External Trigger Out
INVICI	YES	[YES, NO]	Invalidate Instruction Cache on GO
SPOWER	YES	[YES, NO]	Sense Power via HRESET
RESET	HRESET	[HRESET, SRESET, HRESET_UNFIL...	CPU Reset Type
TRPEXP	YES	[YES, NO, SOI, BREAKPOINTONLY]	Trap exception
INCOLD	YES	[YES, NO]	Issue an IN on coldstart
L2WARNING	NO	[YES, NO]	Display L2 Data Cache Warning
LATRACE	NONE	[NONE, AGILENT, TEKTRONIX]	Logic Analyzer Trace
BRKREP	BRKREP	[REONLY, BRKREP]	Trigger In Report Mode
TMD	DISABLE	[ENABLE, DISABLE]	TMD Mode
AIMMRER	OFF	[OFF, START and END]	Application IMMR Exclusion Range
AIMMRVAL	0e000000	[VALUE]	Application IMMR Value
WSPACE	00000000 f98	[BASE and SIZE]	Set Work Space
STACK	OFF	[OFF / LOWER and UPPER]	Set Stack Range
RPL	1	[1..600]	Reset Pulse Length N*1ms
PONR	0	[0..500]	Power On Reset Length N*1ms
RCL	1000	[1000..FFFF]	Runn Counter Length
DRST	25	[0..100]	Delay after Reset Nms



**NOTE:** The CF options listed will not be the same for all targets. This is a PPC750FX example only.

Choose an option and click on it in the **Current Settings** column. A drop-down list appears; scroll down the list to the parameter you want and click on it to reset the option. For example, to disable the Checkstop Interrupt, click on that option in the **Current Settings** column. The list of parameters (in this case YES and NO) appears; click on NO to disable the option.

After you change the CF options, click the **Send All CF Options to Target** button.

A full list of many of the available configuration options and descriptions is available in the *Wind River Workbench for On-Chip Debugging Configuration Options Reference*. Please refer to that document for more information about configuration options.

---

➔ **NOTE:** Most changes to CF options do not take effect until you issue a reset, either through the GUI or by entering the **IN** or **INN** command in the **OCD Command Shell**.

---

### Editing CF Options with Low-level Commands

Alternatively, your target can be configured using the low-level **CF** command, which can be issued at either a **>BKM>** prompt or an **>ERR>** prompt. The configuration options for a target vary depending on the target you are using. Type **CF** at a prompt to see a list of the options that are available for your target. Please note that these options are subject to change with new revisions of the product.

---

➔ **NOTE:** The **CF** command can be entered at either the **>BKM>** prompt or the **>ERR>** prompt. The command cannot be used at a **>RUN>** prompt.

---

To make a change to any of these values, type **CF** and the **CF** command option to be modified, followed by the specific parameter to configure (all on the same command line).

For example, to change the location of the exception vector from **Low** to **High**, you would type:

```
>BKM>CF VECTOR HIGH
```

If you type **CF** again and press **ENTER**, you would see that **HIGH** appears next to the **Vector Table Location** parameter in the list of configuration options.

### 4.6.2 Boot Register Initialization

After communications are established with Wind River Probe and the target, program and configure the registers that are required for initialization, a necessary step prior to downloading code. In order to be able to access a peripheral device using the OCD link on your target, it is necessary for all applicable registers in the interface to be properly configured.

---

➔ **NOTE:** If your target has valid running boot initialization code, you may omit the register initialization process and rely on your own boot code to initialize your board. To reset your target, start your boot code, and stop the target, type **INN**, **GO**, and then **HALT** in the **OCD Command Shell**. To automate the command sequence prior to each load, refer to the *Wind River Workbench User's Guide*.

---

Detailed information about how to work with registers is included in the *Wind River Workbench for On-Chip Debugging User Tutorials*. Please refer to that document for more information about how to program and configure the registers required for initialization.

### 4.6.3 Setting Chip Selects

The CS command provides information about a special set of registers that are used to control the chip selects on a target. Not all targets have programmable chip selects. Refer to your processor documentation for information about chip selects on your target.

If your target does include programmable chip selects, the CS command enables you to view a table that lists the available chip selects with all of their options. Each of the entries in the table can be programmed as described below.

Type CS at the >BKM> prompt with no parameters to display the chip select table for your target, as shown in [Figure 4-3](#).

Figure 4-3 Chip Select Table

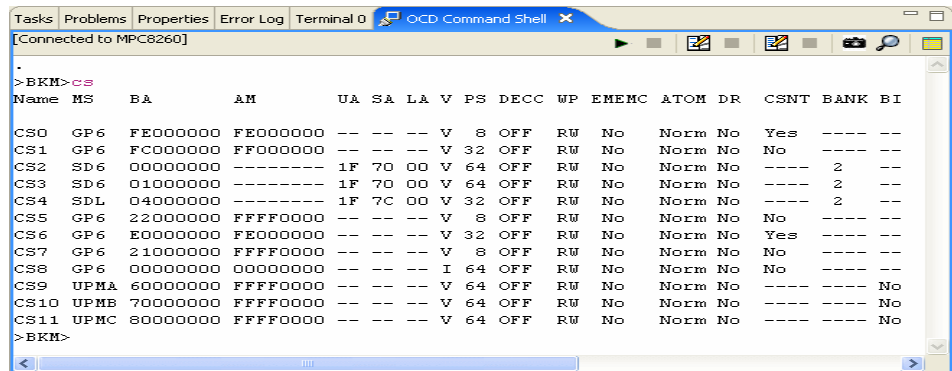

To modify any of the chip selects, type the CS command followed by the name of the chip select you want to modify. The options and the current settings for that chip select display one line at a time, allowing you to make individual changes to the settings. The chip select table is stored on your host PC, and is automatically downloaded after every initialization sequence using the IN command. If you want to initialize the system without writing the chip select table, use the INN command, or disable the chip select group using the CF GRP command, as described in the *Wind River Workbench for On-Chip Debugging User Tutorials*.

Any time you change the chip select table, issue an **IN** command to download your new table to the target so that your changes will take effect.

## **4.7 Moving On**

For information on using your Wind River Probe to download, run, and debug application files in Wind River Workbench, please see the *Wind River Workbench for On-Chip Debugging User Tutorials* and the *Wind River Workbench User's Guide*.



# 5

## *Troubleshooting*

- 5.1 **Introduction** 51
- 5.2 **Troubleshooting Connection Problems** 52
- 5.3 **Troubleshooting Communication Problems** 58
- 5.4 **Troubleshooting License Key Problems** 60
- 5.5 **Troubleshooting Performance Problems** 61

### **5.1 Introduction**

This chapter covers troubleshooting for the Wind River Probe.

Problems with the Wind River Probe generally fall into two types: connection errors (problems between the Wind River Probe and the host computer) or communication errors (problems between the Wind River Probe and the target.) Both are covered in the sections that follow.

If no prompt is visible in the **OCD Command Shell**, or if an error message is visible, it is likely that the connection error is between Wind River Probe and the host computer.

An **>ERR>** prompt in the **OCD Command Shell** indicates that a connection has occurred, so the problem is between the Wind River Probe and the target.

## 5.2 Troubleshooting Connection Problems

On the face of the Wind River Probe there is an LED labelled **power/activity**. This LED should light up when you connect the Probe to your host computer. If the LED does not light up, first check to make sure both ends of the USB cable are tight. Then:

### Windows Hosts:

1. Choose **Start > Control Panel > System**.
2. In the **System Properties** dialog, select the **Hardware** tab.
3. Select **Device Manager**.
4. In the Device Manager, expand the **Universal Serial Bus Controllers** node.

You should see an entry for Wind River Probe (PRxxxxxx).

If the entry is not there, you must reinstall the driver from your installation DVD.

### Linux Hosts:

An entry for **WRProbeSvc** should appear in the **/proc** directory.

Many Linux distributions also have a GUI tool for this purpose. For instance, in Red Hat Linux, select **System Tools > Hardware Browser > System Devices**.

You should see an entry for Wind River Systems/Wind River Probe.

If the entry is not there, you must reinstall the driver from your installation DVD.

### 5.2.1 Wind River Probe Diagnostic Test -- Windows

If the entry does appear, but you cannot connect, you can get some indication of where the problem lies by running the Wind River Probe diagnostic test.

On Windows hosts, the diagnostic test **WRPuTest.exe** is located in the directory *installDir/workbench-2.x/dfw/build/host/x86-win32/bin/visionProducts*, in the folder **Hardware**.

The Wind River Probe diagnostic is mainly intended to give you information to relay to Wind River technical support.

Figure 5-1 Wind River Probe Diagnostic

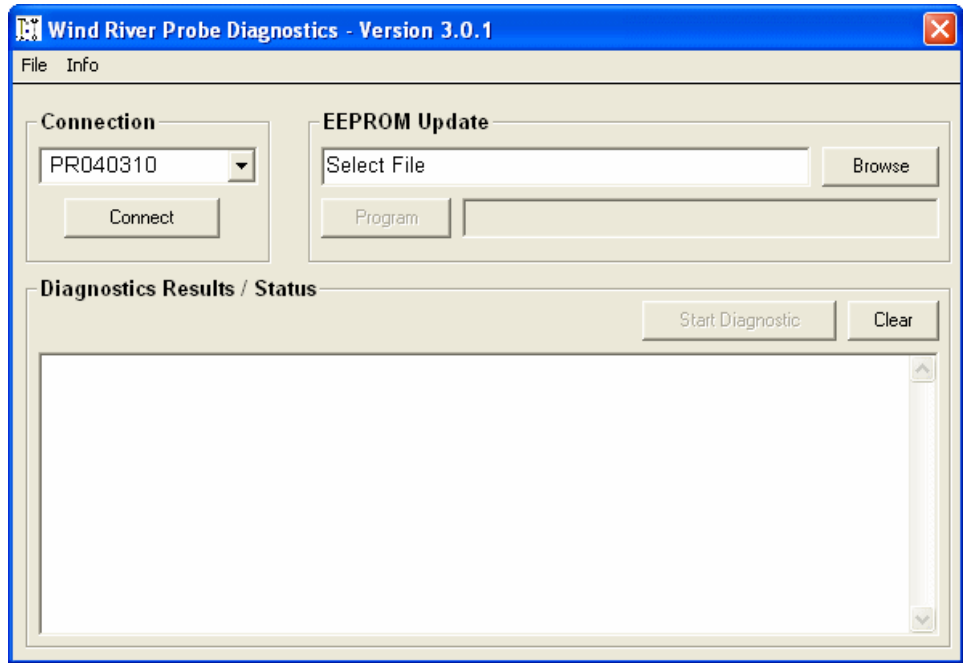

5

### Connecting

If you have more than one Wind River Probe connected to your host computer, select the one you want to test in the **Connection** field.

To test the connection, click **Connect**.

This queries the Wind River Service on the host (installed with the Wind River Workbench DVD) and on the Wind River Probe (through the USB driver.) It also queries the integrity of the packet processing engine (PPE), the 8051 on-board CPU, and the FPGA. If any of these queries fail, the connection fails.

### Updating Firmware

The firmware for the Wind River Probe resides on an EEPROM that maintains the firmware for the on-board CPU and FPGA.

Figure 5-2 Wind River Probe Schematic

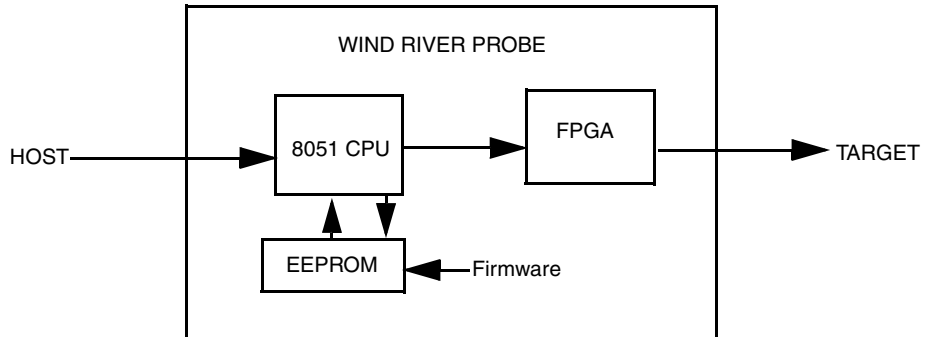

One reason you may not be able to connect is that the firmware file may be out of date or corrupted. To update the Wind River Probe firmware:

1. In the **Connection** field, click **Connect**.
2. In the **EEPROM Update** field, click **Browse**.
3. In the browser window that appears, navigate to the firmware file **wrProbe8051Firmware.iic**. On Windows hosts, this is located in *installDir/workbench-2.x/dfw/build/host/x86-win32/bin*, in the directory **visionProducts/USBDriverFiles**.
4. Click **Program**.

Figure 5-3 Firmware Update

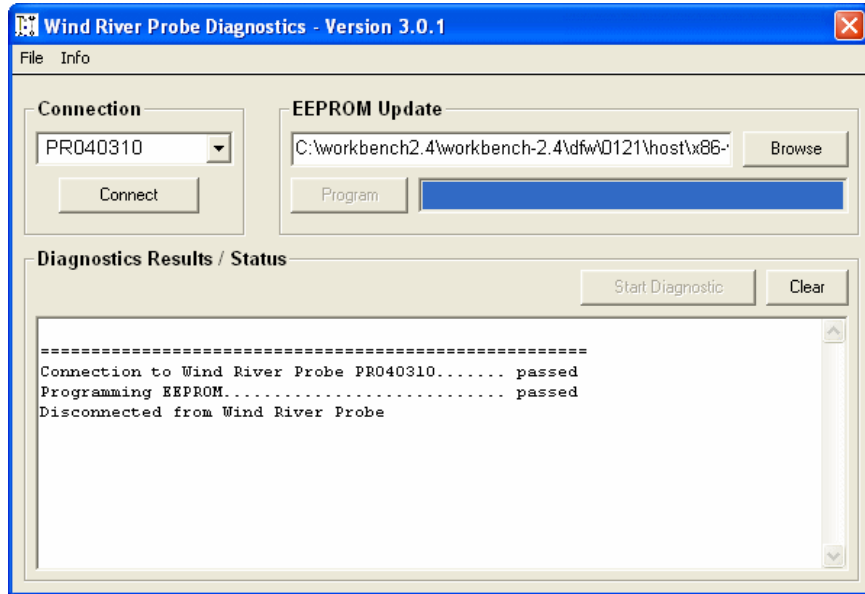

The diagnostic automatically disconnects from the Probe when the update completes. When the update is completed, you must physically disconnect the Probe from your host computer and then reconnect it.

### Diagnostic Test

To run the Wind River Probe diagnostic test:

1. In the **Connection** field, click **Connect**.
2. Click **Start Diagnostic**.

The results are displayed in the **Diagnostics Results/Status** field, as shown in [Figure 5-4](#).

Figure 5-4 Diagnostic Test

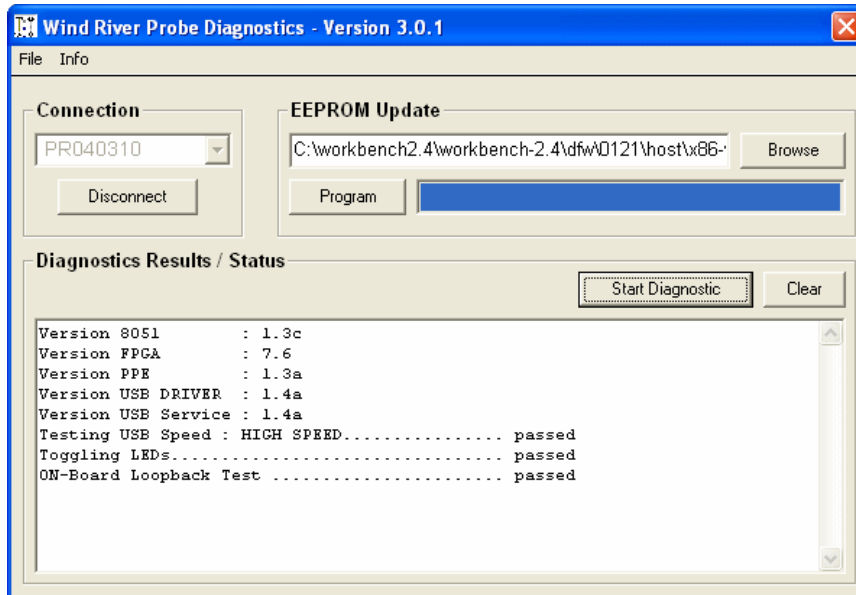

The diagnostic returns the version numbers (driven by the firmware) and then runs three tests.

First it tests the speed of the USB connection, and returns the value--**LOW SPEED** (USB 1.0), **FULL SPEED** (USB 1.1) or **HIGH SPEED** (USB 2.0).

Next it toggles the Wind River Probe LEDs. The LEDs should blink in this order:  
**run/debug** -- off > yellow > green > off.

**power/activity** -- steady green > off > blinking green > steady green.

Finally, the diagnostic performs an on-board loopback test. If this test fails, it indicates that the USB Driver or the packet processing engine (PPE) have failed.

## 5.2.2 Wind River Probe Diagnostic Test -- Linux

On Linux hosts, the Wind River Probe diagnostic test is a command-line utility, invoked by the command **wrpdia**.

The **wrpdia** command takes the following options:

Table 5-1 **wrpdia** Options

Option	Action
-s <i>serial_number</i>	Test a Wind River Probe with the specified serial number.
-a	Apply command to all Wind River Probes connected to your host.
-l	List all Wind River Probes connected to your host.
-u <i>filename</i>	Update specified Wind River Probe(s) with the specified firmware file.
-v	Display version information for specified Wind River Probe(s).
-d	Run diagnostics on specified Wind River Probe(s).

**Example 1**

The following command lists all Wind River Probes connected to your host:

```
$ ./wrpdia -l
```

**Example 2**

The following command runs a diagnostic on all Wind River Probes connected to your host and prints version information, and diagnostic results, for each Wind River Probe:

```
$ ./wrpdia -lavd
```

**Updating Firmware**

The firmware for the Wind River Probe resides on an EEPROM that maintains the firmware for the on-board CPU and FPGA (see [Figure 5-2](#)). One reason you may not be able to connect is that the firmware file may be out of date or corrupted.

On Linux hosts, this file is **WRProbe8051Firmware.iic**, located in *installDir/workbench-2.x/dfw/build/host/x86-linux2/bin*, in the directory **visionProducts/USBLinuxDriverFiles**.

**Example 1**

The following command updates the firmware for Wind River Probe PRO12345:

```
$ ./wrpdia -s PRO12345 -u WRProbe8051Firmware.iic
```

## Example 2

The following command updates the firmware for all Wind River Probes attached to your host:

```
$ ./wrpdiag -a -u WRProbe8051Firmware.iic
```

## 5.3 Troubleshooting Communication Problems

Communication errors between Wind River Probe and the target are typically indicated by an **>ERR>** prompt in the **OCD Command Shell**. The following sections describe three solutions that you can try to correct this error.

### Register Files

If the target board you are using was shipped with the registers uninitialized, you may have to download a register file (**.reg**) to the target (or specify one in your board description file) before you are able to get the processor into debug mode and see a **>BKM>** prompt in the **OCD Command Shell**. The *Wind River Workbench On-Chip Debugging Guide* provides step-by-step instructions about how to download a register file to your target. Refer to the documentation that came with your board to verify how the registers on your target board were shipped. Often, your board includes a register file for the board that you need to download.

If an **INN** command passes, but an **IN** command fails, this indicates a register file issue. See [4.5 Initializing the Target](#), p.44.

### Set Verbose Command

The **SET VERBOSE ON** command puts Wind River Probe into verbose mode, which can be useful when you attempt to diagnose connection problems. Using the **IN** command at an **>ERR>** prompt only shows that the attempt to connect failed. Using verbose mode provides more information about where the communication attempt failed.

The following steps describe how to use verbose mode:

1. Type **SET VERBOSE ON** at the **>ERR>** prompt in the **OCD Command Shell**.
2. Press **ENTER**.

This returns you to an **>ERR>** prompt.



3. Type **IN** at the **>ERR>** prompt and press **ENTER**.

This time, the output in the **OCD Command Shell** lists all of the diagnostic tests that it performs while trying to place the target in debug mode, and states whether the test passes or fails. The following output shows an example of a JTAG target being initialized with verbose mode enabled:

```
>ERR>set verbose on
>ERR>in
*****
Wind River Probe Initialization Sequence.
Copyright (C) Wind River Systems, Inc. 1999-2004. All rights reserved.
*****

      Support Expires.....4/20/06
      Target Processor.....PPC750FX:U1
Wind River Probe      Group ID#= 0
Wind River Probe      Serial#= U1234567      Firmware= pr3.0a
Type CF For a Menu of Configuration Options

Testing Communications to Hardware Interface...Passed
Driving HRESET to be High.....Passed
Driving HRESET to be Low.....Passed
Waiting HRESET Low Acknowledge.....Failed
>ERR>
```

Use verbose mode to help you determine why the target cannot be placed in debug mode. The *Wind River Workbench for On-Chip Debugging Command Reference* describes each of the diagnostic tests that are performed, and provides items that you can check to try to correct the problem.

## Hardware

An **>ERR>** prompt in the **OCD Command Shell** can also signify a problem with the hardware connections between Wind River Probe and the target. Check the following items to determine if the connection problem is hardware related:

- Verify that you correctly made all connections as described in [2. Setting Up Hardware](#).
- Verify that you correctly applied power to both the host computer and the target.

## 5.4 Troubleshooting License Key Problems

If the error message shown in [Figure 5-5](#) appears when you try to connect, your emulator's license key is incorrect or expired.

Figure 5-5 **License Key Error Message**

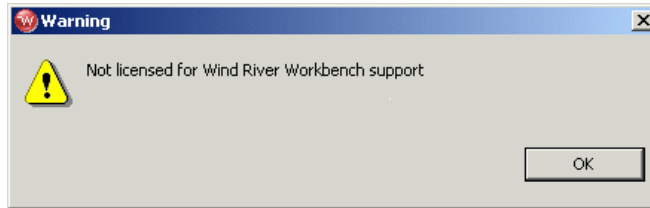

To upgrade your license key, use the following steps:

1. Right-click in the **Target Manager** and select **OCD Utilities > Capture Current Key to File**.

A browser window appears.

2. In the browser's **Look In** field, select **Desktop**.
3. In the browser's **File Name** field, enter your name and append **.txt**.

For example, if your name were John Smith, you would name the file **JohnSmith.txt**.

4. Click **Open**.

Workbench automatically creates the text file and logs your current license key to it.

5. Send an email to [licadmin@windriver.com](mailto:licadmin@windriver.com) and attach the text file you created in the preceding steps.

This file contains the license key that Wind River needs in order to upgrade your Wind River Probe.

When you request a new license key, your email must include the sales order number associated with the upgrade. Within 24 hours you will receive a message with a text file attachment that contains your upgraded license key.

To install your new license key, use the following steps:

1. Open the email message you received from Wind River and save the attached file to your desktop.

2. Connect your Wind River Probe to your host PC and open Wind River Workbench.
3. Right-click in the **Target Manager** and select **OCD Utilities > Install License Key From File**.  
A browser window appears.
4. Navigate to the file you saved on your desktop in Step 1 and Click **Open**.  
This burns your new license key.

## 5.5 Troubleshooting Performance Problems

If you lose connectivity to the Wind River Probe due to noise on the lines, use the **HIC** command in the **OCD Command Shell** to change the properties of the electrical interface.

Entering **HIC** with no arguments returns a list of all user-changeable electrical properties:

```
>BKM>hic
Clock Frequency in KHz          CLKK[25...100000] = 16000
Clock Phase                    CLKPHASE[-180..+900] = 0
Clock External synchronization RTCK[ENABLE,DISABLE] = DISABLE
CLK Drive Strength             CLKSTRENGTH[1..4] = 2
TMS Drive Strength            TMSSTRENGTH[1..2] = 1
TDI Drive Strength            TDISTRENGTH[1..2] = 1
Target Interface voltage Override VOLTAGE[3.3V,2.5V,1.8V,VIO] = VIO
Target Interface termination voltage TERMVOLTAGE[2.5V-3.3V,1.8V-2.5V] =
2.5V-3.3V
CLK Termination                CLKTERM[ACTIVE_HI,ACTIVE_LO,PASSIVE] = ACTIVE_HI
TMS Termination                TMSTERM[ACTIVE_HI,ACTIVE_LO,PASSIVE] = ACTIVE_HI
TDI Termination                TDITERM[ACTIVE_HI,ACTIVE_LO,PASSIVE] = ACTIVE_HI
TDO Termination                TDOTERM[ACTIVE_HI,ACTIVE_LO,PASSIVE] = ACTIVE_HI
GPIO0 Termination              GPIO0TERM[ACTIVE_HI,ACTIVE_LO,PASSIVE] = ACTIVE_HI
GPIO1 Termination              GPIO1TERM[ACTIVE_HI,ACTIVE_LO,PASSIVE] = ACTIVE_HI
GPIO2 Termination              GPIO2TERM[ACTIVE_HI,ACTIVE_LO,PASSIVE] = PASSIVE
GPIO3 Termination              GPIO3TERM[ACTIVE_HI,ACTIVE_LO,PASSIVE] = PASSIVE
GPIO4 Termination              GPIO4TERM[ACTIVE_HI,ACTIVE_LO,PASSIVE] = PASSIVE
GPIO5 Termination              GPIO5TERM[ACTIVE_HI,ACTIVE_LO,PASSIVE] = PASSIVE
GPIO6 Termination              GPIO6TERM[ACTIVE_HI,ACTIVE_LO,PASSIVE] = PASSIVE
GPIO7 Termination              GPIO7TERM[ACTIVE_HI,ACTIVE_LO,PASSIVE] = PASSIVE
GPIO Output Enable Value      (GPIO7..GPIO0) GPIOXOE[VALUE] = 0x01
GPIO Output Value             (GPIO7..GPIO0) GPIOXOV[VALUE] = 0x03
GPIO Input Value              (GPIO7..GPIO0) = 0x27
>BKM>
```

## Example

In this example, set the strength of the TCK signal to 4.

```
>BKM> HIC TCKSTRENGTH 4
```

When all parameters are configured, you can save the configuration in XML format using the command **HIC BRDDUMP**:

```
>BKM>hic brddump
<CLKK>16000</CLKK>
<CLKPHASE>0</CLKPHASE>
<RTCK>DISABLE</RTCK>
<CLKSTRENGTH>2</CLKSTRENGTH>
<TMSSTRENGTH>1</TMSSTRENGTH>
<TDISTRENGTH>1</TDISTRENGTH>
<VOLTAGE>VIO</VOLTAGE>
<TERMVOLTAGE>2.5V-3.3V</TERMVOLTAGE>
<CLKTERM>ACTIVE_HI</CLKTERM>
<TMSTERM>ACTIVE_HI</TMSTERM>
<TDITERM>ACTIVE_HI</TDITERM>
<TDOTERM>ACTIVE_HI</TDOTERM>
<GPIO0TERM>ACTIVE_HI</GPIO0TERM>
<GPIO1TERM>ACTIVE_HI</GPIO1TERM>
<GPIO2TERM>PASSIVE</GPIO2TERM>
<GPIO3TERM>PASSIVE</GPIO3TERM>
<GPIO4TERM>PASSIVE</GPIO4TERM>
<GPIO5TERM>PASSIVE</GPIO5TERM>
<GPIO6TERM>PASSIVE</GPIO6TERM>
<GPIO7TERM>PASSIVE</GPIO7TERM>
<GPIOXOE>0x01</GPIOXOE>
<GPIOXOV>0x03</GPIOXOV>
<GPIOXIV>0x27</GPIOXIV>

>BKM>
```

Copy this output to a board file that you can use for every connection.

# Index

## A

adapter 10

## B

Boot Register Initialization 48

## C

cable

    Wind River Probe 10

CF Command 48

Common Tab 42

components

    Wind River Probe 8

Configuration Options 46

Connecting 53

Connecting to the Wind River Probe 20

Connecting Wind River Probe

    to host 11

    to target 12

Connecting Wind River Probe to a Host 11

Connecting Wind River Probe to a Target 12

connector

    Wind River Probe 10

CS Command 49

## D

Diagnostic Test 55

Download Tab 38

Downloading Code 35

Drivers

    Linux hosts 16

    Windows hosts 15

## E

Editing CF Options with Low-level Commands 48

Establishing Communications 19

Example 62

Executing the Reset and Download 43

## F

Features 3

features

    Wind River Probe 3

## G

grounding Wind River Probe 13  
Grounding Wind River Probe and the Target 13

## H

Hardware 59  
hardware setup 7-13

## I

IN Command 45  
Initializing the Target 44  
INN Command 45  
Installing Drivers 15  
Instruction Pointer Tab 40  
Introduction 1, 7, 15, 19, 51

## L

Launch configuration  
    common tab 42  
    source tab 42  
Layout Drawings 11  
LEDs 9  
    Power/Activity 9  
    Run/Debug 9  
Linux Hosts 16  
    53

## M

Moving On 50

## N

New Connection Wizard 21

## O

On-Chip Debugging 2  
Overview 1  
overview  
    document 1  
    system 2

## P

play a register file 37  
Precautions to avoid injury 4  
Precautions to avoid property damage 5  
Probe Cable and Connector 10  
Projects to Build Tab 36

## R

Register Files 58  
Register files 58  
Reset & Download view  
    download tab 38  
    instruction pointer tab 40  
    reset tab 37  
    run options tab 41  
    status tab 43  
Reset Tab 37  
Run Options Tab 41

## S

Safety Information 4  
    Precautions 5  
Set Verbose Command 58  
Set Verbose On command 58

- Setting Chip Selects 49
- Setting up a Project 32
- Setting Up Hardware 7
- setting up hardware 7–13
- Source Tab 42
- System Overview 2
- system overview 2

## T

- Target-specific adapter 10
- Top of Wind River Probe 9
- Troubleshooting 51
- Troubleshooting Communication Problems 58
- Troubleshooting Connection Problems 52
- Troubleshooting License Key Problems 60
- Troubleshooting Performance Problems 61

## U

- Unpacking Information 8
- unpacking Wind River Probe 8
- Updating Firmware 53, 57
- Updating Probe firmware 53

## V

- verbose mode 58

## W

- What's Next? 50
- Wind River Probe 3, 4
  - adapter 10
  - cable 10
  - components 8
  - connection scheme 14
  - connector 10
  - description 9

- LEDs 9
  - top 9
- dimensions 11
- features 3
  - additional custom registers 4
  - built-in hardware diagnostics 3
  - High Speed USB download 3
  - on-chip debug target control 3
  - target versatility 4
- grounding procedure 13
- unpacking 8
- Updating firmware 53
- Wind River Probe communication problems
  - License key problems 60
- Wind River Probe Components 8
- Wind River Probe Description 9
- Wind River Probe Diagnostic Test -- Linux 56
- Wind River Probe Diagnostic Test -- Windows 52, 56
- Wind River Probe LEDs 9
- Windows Hosts 15
- Working with Wind River Probe 46