

# VP LOCAL LASER PRINTING

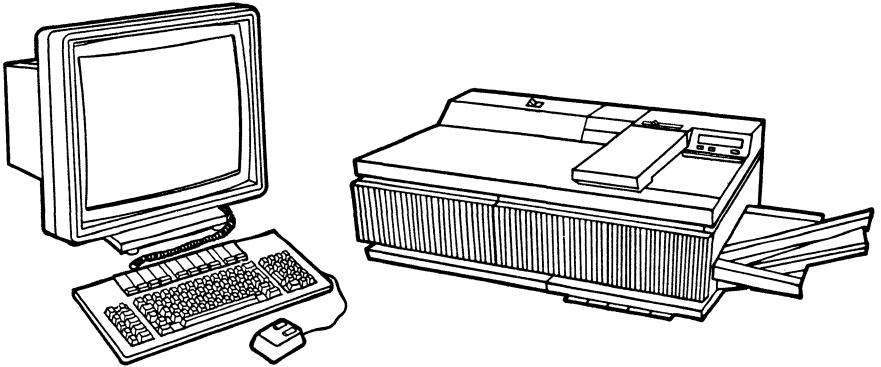

**XEROX**

***VP Series Reference Library  
Version 1.1***

---

*This publication could contain technical inaccuracies or typographical errors. Changes are periodically made to the information herein; these changes will be incorporated in new editions of this publication.*

*This publication was printed in June 1986 and is based on the VP Series 1.1 software.*

*Address comments to:*

Xerox Corporation  
Attn: Product Education (N2-15)  
701 S. Aviation Blvd.  
El Segundo, California 90245

**WARNING:** *This equipment generates, uses, and can radiate radio frequency energy and, if not installed and used in accordance with the instructions manual, may cause interference to radio communications. It has been tested and found to comply with the limits for a Class A computing device pursuant to subpart J of part 15 of the FCC rules, which are designed to provide reasonable protection against such interference when operated in a commercial environment. Operation of this equipment in a residential area is likely to cause interference, in which case the user at his own expense will be required to take whatever measures may be required to correct the interference.*

*Printed in U.S.A. Publication number: 610E02650*

*XEROX<sup>®</sup>, 6085, 8000, 8010, 860, 820-II, 8040, 5700, 8700, 9700, 495-1, ViewPoint, and VP are trademarks of Xerox Corporation.*

*IBM is a registered trademark of International Business Machines.*

*DEC and VAX are trademarks of Digital Equipment Corporation.*

*Wang Professional Computer is a trademark of Wang Laboratories, Inc.*

*Lotus 1-2-3 is a trademark of Lotus Development Corporation.*

*MS-DOS is a trademark of Microsoft Corporation.*

*The Source is a service mark of Source Telecomputing Corporation.*

*VisiCalc is a registered trademark of VisiCorp.*

*WordStar is a registered trademark of MicroPro International Corporation.*

*Teletype is a registered trademark of Teletype Corporation.*

**© 1986, Xerox Corporation. All rights reserved.**

# Table of contents

---

---

<b>1. Introduction</b>	<b>1</b>
Related information	2
4045 Laser CP	2
VP Series reference library	2
VP Series training guides	2
Hardware/software requirements	3
Hardware	3
Software	3
VP Local Laser Printing features	4
ViewPoint and PC emulation documents	4
Background printing	5
Draft mode printing	5
4045 Laser CP specifications	6
Features	6
Paper	7
Physical characteristics	7
Fonts	8
About this guide	10

---

<b>2. Hardware installation</b>	<b>11</b>
Installing the local printer option board	12
6085 without the PC option	12
6085 with the PC option	16
Connecting the Laser CP to the 6085 workstation	22
Configuring the hardware	26
Install the 6085 offline diagnostics	26
Set the configuration	28
Record your configuration on the processor	29
Checking the configuration cartridge setting	31
Checking hardware operation	32
<b>3. Software installation</b>	<b>35</b>
Installing software from floppy disks	37
Enabling software and fonts	37
Installing the application software	38
Installing the local laser printer fonts	40
Installing software from the network	44
Enabling software and fonts	44
Installing the application software	45
Installing the local laser printer fonts	48

---

<b>4. Operation</b>	<b>53</b>
Copying the local laser printer icon	54
Printing a document	55
Canceling the document in progress	57
Local laser printing property and option sheets	60
Local printer window	68
Local printer attention window	72
Printing envelopes	74
Adding paper while printing	74
Copying while printing	75
<b>5. Problem solving</b>	<b>77</b>
Troubleshooting guidelines	78
Local laser printer self-test	80
Online diagnostics	81
Testing the local printer option	81
Printing a test document	85
Error log window	88
Correcting image problems	90
<b>Index</b>	<b>93</b>

---



# List of figures

---

1-1	4045 Laser CP	1
1-2	Free-hand drawing illustration	4
1-3	Data icons	4
1-4	Selected Modern and Classic font examples	9
2-1	6085 processor (rear view)	13
2-2	C5 shield with LPO board and guide strip	14
2-3	6085 processor (rear view)	17
2-4	C5 shield with LPO board and guide strip	18
2-5	C5 shield with LPO and PCO boards	19
2-6	C5 shield (end view) with labels and printer connector	20
2-7	Connecting the Laser CP to the 6085 workstation	23
2-8	4045 Laser CP interface cable connection	24
2-9	6085 interface cable connection	25
2-10	Configuration cartridge switch settings	31

<b>3-1</b>	<b>Software installation steps</b>	<b>36</b>
<b>3-2</b>	<b>Application loader window</b>	<b>41</b>
<b>3-3</b>	<b>Local laser fonts</b>	<b>42</b>
<b>3-4</b>	<b>Application loader window</b>	<b>50</b>
<b>3-5</b>	<b>Local laser printer fonts</b>	<b>51</b>
<b>4-1</b>	<b>Local laser printer icon</b>	<b>54</b>
<b>4-2</b>	<b>Data icons</b>	<b>55</b>
<b>4-3</b>	<b>Desktop auxiliary menu</b>	<b>57</b>
<b>4-4</b>	<b>Local laser printing property sheet</b>	<b>59</b>
<b>4-5</b>	<b>Special control settings</b>	<b>65</b>
<b>4-6</b>	<b>Local printer window</b>	<b>67</b>
<b>4-7</b>	<b>Local printer attention window</b>	<b>71</b>
<b>5-1</b>	<b>Desktop auxiliary menu</b>	<b>82</b>
<b>5-2</b>	<b>4045 online diagnostics menu selection</b>	<b>82</b>
<b>5-3</b>	<b>4045 online diagnostics window</b>	<b>83</b>
<b>5-4</b>	<b>Desktop auxiliary menu</b>	<b>85</b>
<b>5-5</b>	<b>4045 online diagnostics menu selection</b>	<b>85</b>
<b>5-6</b>	<b>4045 online diagnostics window</b>	<b>86</b>
<b>5-7</b>	<b>Test document</b>	<b>87</b>
<b>5-8</b>	<b>Error log folder</b>	<b>88</b>
<b>5-9</b>	<b>Error log window</b>	<b>89</b>
<b>5-10</b>	<b>Special control settings</b>	<b>90</b>

---



# List of tables

---

3-1	Modern Fonts disk page requirements	43
3-2	Modern Fonts disk page requirements	52



VP Local Laser Printing is a software application package which, together with Xerox 4045 Laser Copier/Printer (CP), the 6085 Professional Computer System and Local Printer Option kit, comprises the Documenter system. The Laser CP (Figure 1-1) prints text and graphics with a high quality resolution of 300 by 300 spots per inch. Documents print quietly at a speed of up to 10 pages per minute on a variety of paper sizes and special papers, including transparencies, labels, and envelopes. Printing occurs as a background process, enabling you to continue with other desktop activities. VP Local Laser Printing software can be loaded at a networked, remote, or standalone 6085 Professional Computer System. The Laser CP's compact size and attractive design complement your office. When equipped with the optional copier feature, the Laser CP demonstrates true productivity by providing quick copies.

**Note:** These products are customer installable. Xerox service can be provided for a nominal charge if requested. Contact your local Xerox Support Center as required.

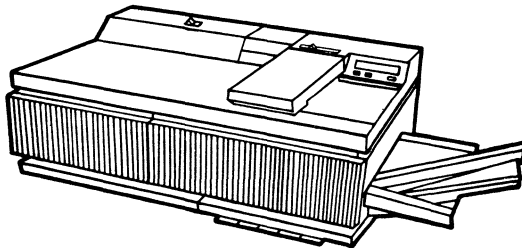

Figure 1-1 4045 Laser CP

---

## Related information

---

The following materials provide information related to VP Local Laser Printing.

### 4045 Laser CP

---

For additional installation, maintenance, and diagnostic instructions, refer to the following materials shipped with the printer:

- *4045 User Manual*
- *4045 Reference Manual*

### VP Series reference library

---

- Xerox ViewPoint
- VP Document Editor
- VP PC Emulation

### VP Series training guides

---

- Xerox ViewPoint
- VP Document Editor

---

## Hardware/software requirements

---

The following are the hardware and software requirements for connecting the Laser CP to a 6085 Professional Computer System.

---

### Hardware

---

- 6085 Professional Computer System
- Local Printer Option (LPO) kit
- 4045 Laser CP with copier (optional), Centronics Interface, Extended Memory (DRAM), and Sequencer (optional)

---

### Software

---

- Xerox ViewPoint software
- VP Document Editor software
- VP Local Laser Printing software

In addition to Xerox ViewPoint software, VP NetCom, VP RemoteCom, or VP StandAlone software must be installed and enabled on the workstation.

VP Document Editor software and all prerequisite software must be installed, enabled, and running on the workstation. Before using the software, open the application loader icon and verify that the appropriate software is loaded and running.

The sub-tab titled "Application Loader" in the VP Series reference library contains additional information on the application loader.

---

## VP Local Laser Printing features

---

Documents containing text and graphics (Figure 1-2) can be printed with the Laser CP, using VP Local Laser Printing software.

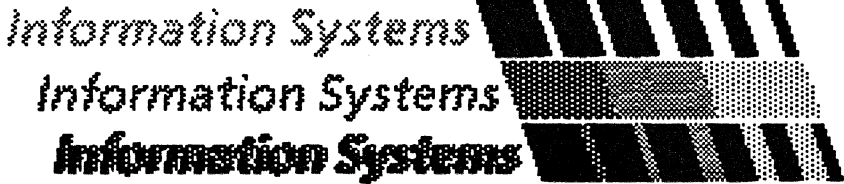

Figure 1-2 Free-Hand Drawing illustration

---

## ViewPoint and PC emulation documents

---

Printing is started by moving or copying the desired document icon (Figure 1-3) to the local printer icon. ViewPoint documents, including folders, mailnotes, spreadsheets, Free-Hand Drawing canvases, and previously created Interpress masters can be printed. In addition, Interpress masters of documents created using VP PC Emulation can be printed. The Laser CP can also be used directly as the print device for PC emulation software.

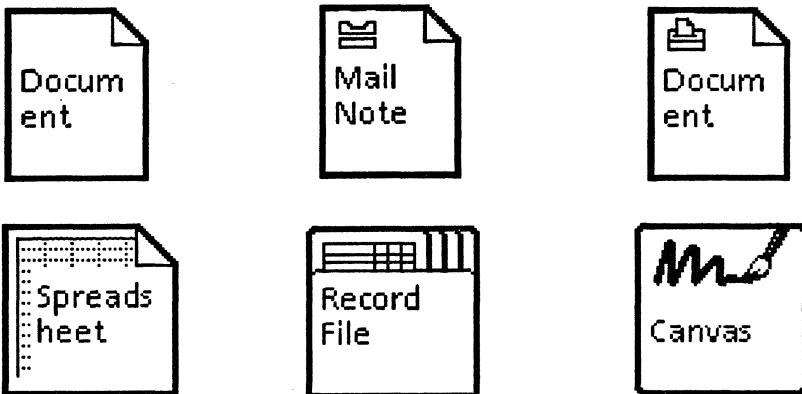

Figure 1-3 Data icons

## **Background printing**

---

Printing on the local laser printer occurs as a background process, enabling additional workstation operations to be performed during printing. Printing priority can be selected and changed as desired, even while printing a document.

## **Draft mode printing**

---

Documents can be printed in draft mode with slightly reduced image quality for maximum printer throughput.

---

## 4045 Laser CP specifications

---

As a local laser printer connected to the 6085 Professional Computer System, the 4045 Laser CP prints ViewPoint documents in Interpress format and IBM PC emulation documents in 630 mode.

### Features

---

The Laser CP provides the following features:

- Prints up to 10 pages per minute (ViewPoint documents print at approximately 5 to 6 pages per minute and PC emulation documents print at up to 10 pages per minute)
- Resolution of 300 by 300 spots per inch
- Paper input cassette
- Chime
- Optional copier function
- Optional sequencer tray



## Paper

---

The Laser CP can print on a variety of paper sizes and weights:

- 8.5- by 11-inch or 8.5- by 14-inch paper
- 16- to 24-pound (60 to 90 gsm) bond paper

The Laser CP paper cassette holds 250 sheets of 20-pound (80 gsm) bond paper. Both portrait and landscape images can be printed on 8.5- by 11-inch and 8.5- by 14-inch paper. In addition, the Laser CP prints special papers, including transparencies, labels, and xerographic envelopes.

## Physical characteristics

---

The Laser CP dimensions are: 27.5 inches (width) by 21.5 inches (depth) by 10.5 inches (height). The Laser CP weighs approximately 145 pounds.

## Fonts

---

The following 300 DPI (dots per inch) fonts are available:

- Xerox Modern Fonts
- Xerox Printwheel Fonts
- Xerox PC Emulation Fonts
- Xerox Math Classic Fonts
- Helvetica fonts (through a special licensing agreement)

Figure 1-4 illustrates selected modern and classic fonts.

**Note:** Xerox Modern Fonts, in point sizes 6 through 18, and the font for printing graphics, Xerox.Graphics.Newvec are required. These fonts are included with VP Local Laser Printing.

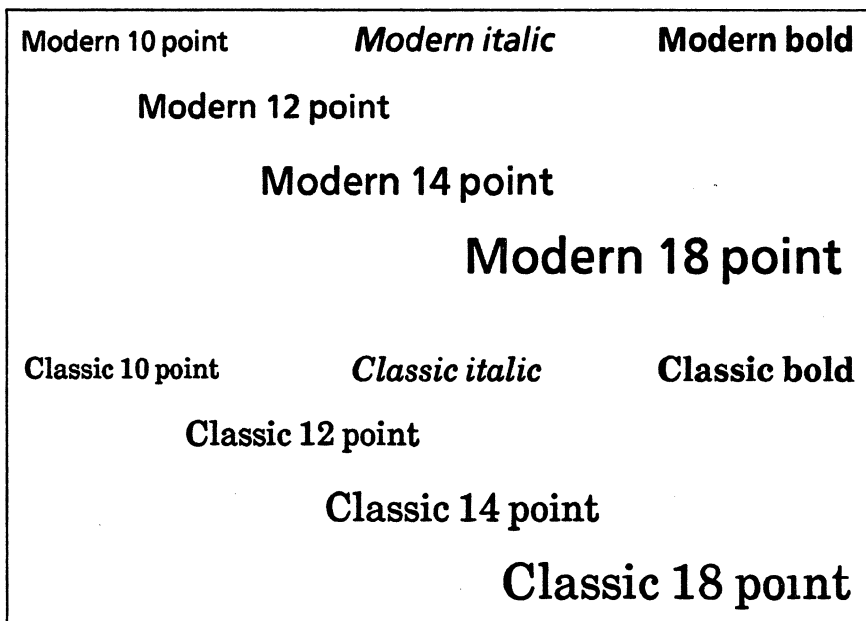

Figure 1-4 Selected Modern and Classic font examples

## About this guide

---

Read this guide before printing documents. This guide describes the following:

- The necessary hardware and software, VP Local Laser Printing features, and 4045 Laser CP specifications (Chapter 1)
- Installing the local printer option board, connecting the Laser CP printer to the 6085 processor, configuring the hardware, and checking printer operation (Chapter 2)
- Installing the local laser printer fonts and installing VP Local Laser Printing software (Chapter 3)
- Copying the local laser printer icon, printing a document, and using the local laser printing property sheet (Chapter 4)
- Isolating problems with 4045 Laser CP (Chapter 5)

This chapter describes the following:

- Installing the Local Printer Option (LPO) board
- Connecting the Laser CP to the 6085 workstation
- Configuring the hardware
- Checking the configuration cartridge setting
- Checking hardware operation

**Note:** For information on unpacking the Laser CP, moving the Laser CP, connecting the Laser CP to a power source, and installing the output tray, refer to the *4045 Laser CP User Manual* shipped with the printer.

---

## Installing the Local Printer Option board

---

The Local Printer Option (LPO) printed circuit board provides the interface that enables documents prepared on the 6085 Professional Computer System to be printed on the attached Laser CP. This section describes the procedure for installing the LPO board in the 6085 processor. Refer to the procedure for your system configuration:

- 6085 without the IBM PC emulation option board
- 6085 with the IBM PC emulation option board

**Tool required:** A small-blade flat-head screwdriver is needed to install the LPO board.

### 6085 without the PC option

---

To install the LPO board in a 6085 workstation without the IBM PC emulation option board:

1. Switch off the system power.
2. Position the 6085 processor cabinet so that the rear of the processor can be easily accessed.
3. Release the cable retaining clamp (Figure 2-1) by loosening the captive finger screw and swinging the cable retaining clamp out to the right.

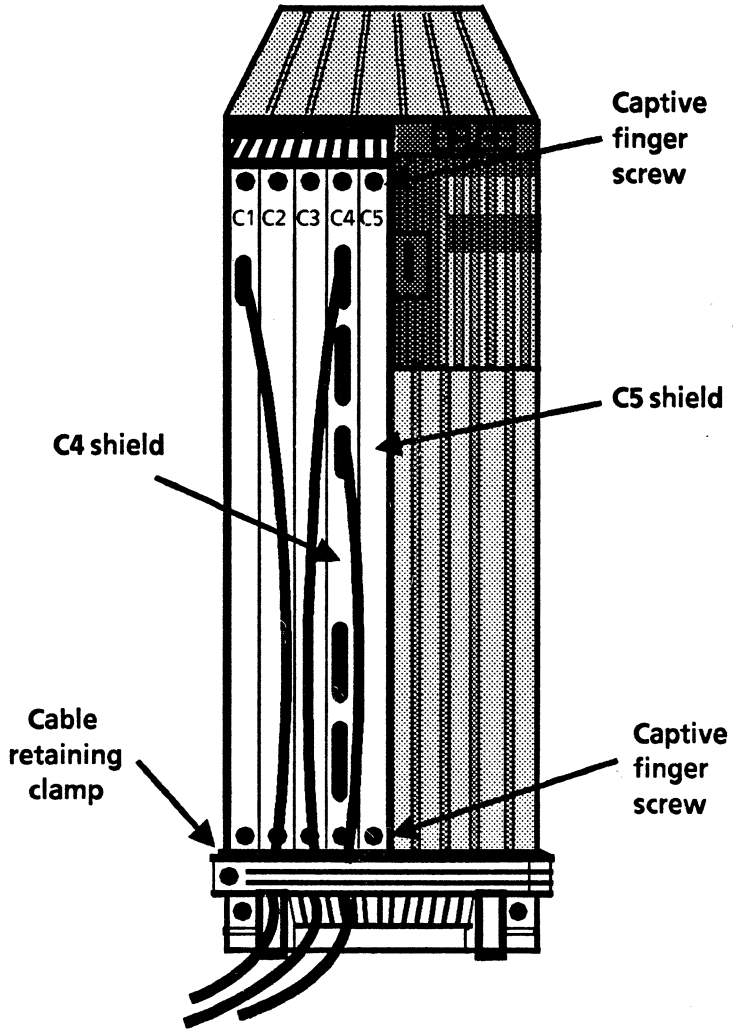

Figure 2-1 6085 processor (rear view)

4. On the C4 shield, remove any connectors that will hinder your access to the C5 shield. Remove the Ethernet network connector (if applicable), the floppy disk drive connector, and the keyboard connector by loosening the captive retaining screws and pulling the connectors.
5. Loosen the two captive finger screws on the C5 shield and, holding onto the screws, gently pull the metal shield from the processor.
6. Install the new C5 shield with the LPO board in the C5 processor slot. Be sure to line up the edges of the LPO printed circuit board and the guide strip (Figure 2-2) with the guide rails in the processor. Push the shield gently into place. Do not force the shield into the processor; forcing the shield could damage the circuit board connector and the backplane. Tighten the two screws finger tight.

**Note:** The edges of the guide strip and the printed circuit board (not the edges of the shield) should align with the guide rails in the processor.

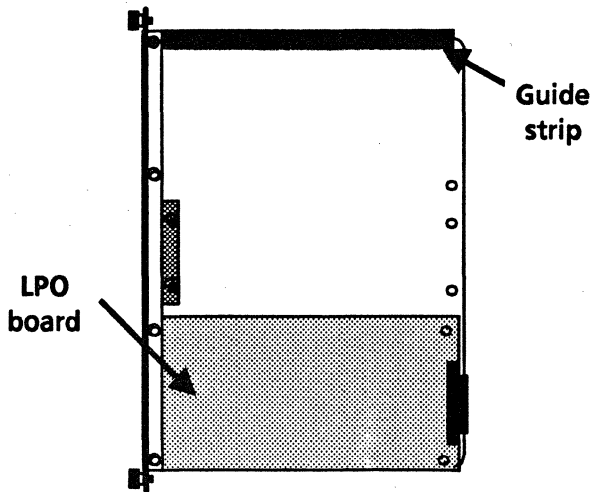

Figure 2-2 C5 shield with LPO board and guide strip



7. Reconnect any cables that were removed from the C4 shield. Reconnect the Ethernet network connector (if applicable), the floppy disk drive connector, and the keyboard connector by aligning and seating the connectors, then tightening the captive retaining screws.
8. Secure the cable retaining clamp by swinging the clamp over the cables and tightening the captive finger screw on the left side of the clamp.
9. Continue with the procedure, "Connecting the Laser CP to the 6085 workstation."

## 6085 with the PC option

---

To install the LPO board in a 6085 with the IBM PC emulation option (PCO) board:

1. Switch off the system power.
2. Position the 6085 processor cabinet so that the rear of the processor can be easily accessed.
3. Release the cable retaining clamp (Figure 2-3) by loosening the captive finger screw and swinging the cable retaining clamp out to the right.
4. On the C4 shield, remove any connectors that will hinder your access to the C5 shield. Remove the Ethernet network connector (if applicable), the floppy disk drive connector, and the keyboard connector by loosening the captive retaining screws and pulling the connectors.

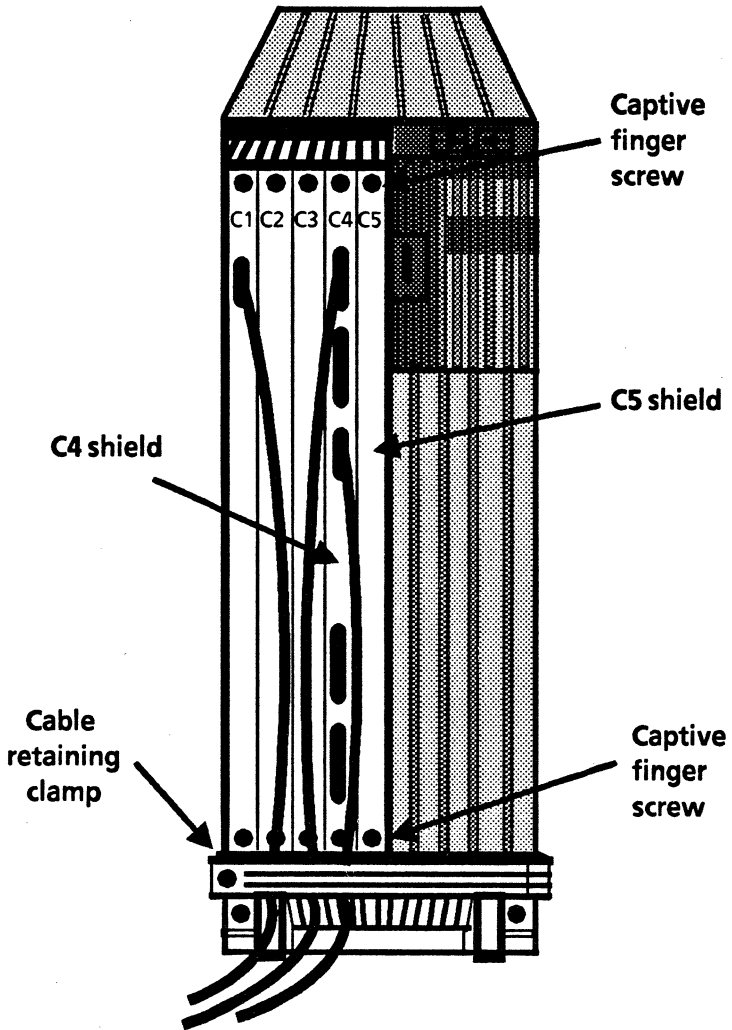

Figure 2-3 6085 processor (rear view)

5. Loosen the two captive finger screws on the C5 shield and, holding onto the screws, gently pull the metal shield from the processor.
6. Using a small blade screwdriver, remove the PCO board from the C5 shield by carefully loosening the four screws that secure the PCO board to the C5 shield. Holding the PCO board gently by the edges, place the board and the screws in a safe spot.
7. Unpack the new C5 shield with the LPO board already mounted. Remove the screws that hold the guide strip (Figure 2-4) in place and discard both the guide strip and the screws.

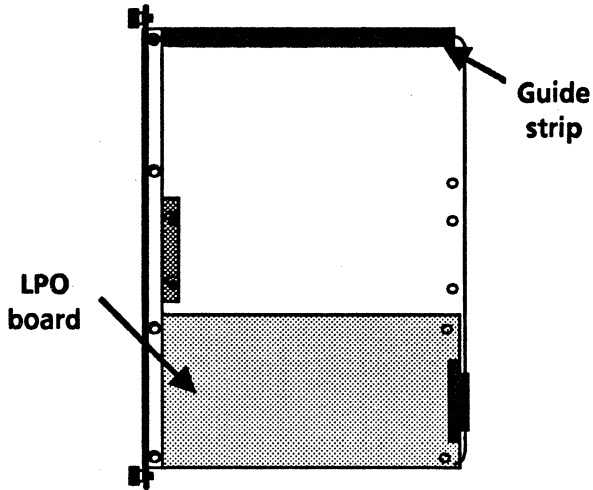

Figure 2-4 C5 shield with LPO board and guide strip

8. Place the PCO board on the upper section of the new C5 shield, making certain that the locating hole in the lower right corner of the PCO board is seated on the locating pin on the shield (Figure 2-5).
9. Insert the four screws in the threaded spacer mounts on the C5 shield and, using a small screwdriver, tighten the screws. Take care not to crosstread the screws.

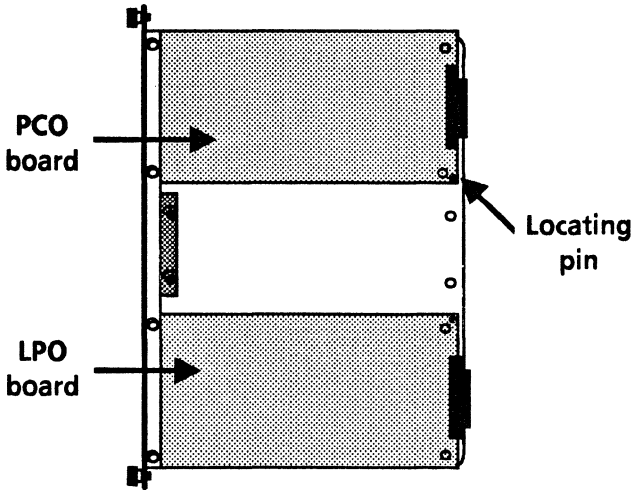

Figure 2-5 C5 shield with LPO and PCO boards

- Two PCO labels are supplied with the LPO kit. Select the PCO label that matches the one on the C5 shield from which you removed the PCO Printed circuit board. Attach this label to the spine of the new C5 shield, just below the "C5" marking (Figure 2-6).

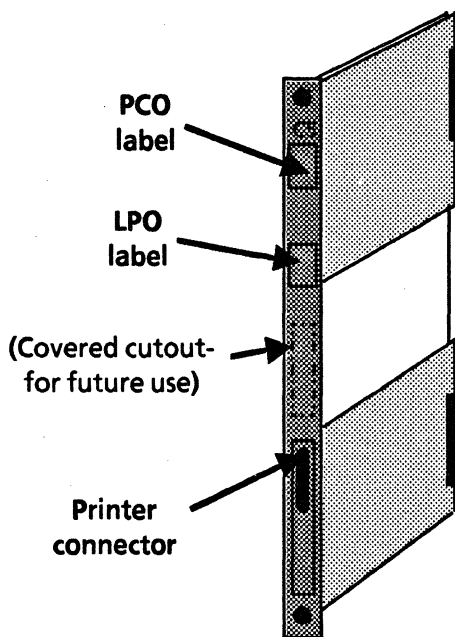

Figure 2-6 C5 shield (end view) with labels and printer connector

- Install the new C5 shield with the PCO and LPO boards in the C5 processor slot. Line up the edges of the printed circuit boards with the guide rails in the processor. Push the C5 shield gently into place until the thumbscrews can be engaged. **Do not** force the C5 shield into the processor; forcing the shield could damage the printed circuit board connectors, the backplane, or the shield. Tighten the two screws finger tight.

**Note:** The edges of the printed circuit boards (not the edges of the shield) align with the guide rails in the processor.

12. Reconnect any cables that were removed from the C4 shield. Reconnect the Ethernet network connector (if applicable), the floppy disk drive connector, and the keyboard connector by aligning and seating the connectors, then tightening the captive retaining screws.
13. Secure the cable retaining clamp by swinging the clamp over the cables and tightening the captive finger screw on the left side of the clamp.
14. Continue with the procedure, "Connecting the Laser CP to the 6085 workstation."

---

## Connecting the Laser CP to the 6085 workstation

---

The 4045 Laser CP is connected to the 6085 Professional Computer System using the processor interface cable supplied with the LPO kit.

**Note:** For information on unpacking the Laser CP, determining Laser CP space requirements, selecting a location for the Laser CP, moving the Laser CP, connecting the Laser CP to a power source, and installing the output tray, refer to the *4045 Laser CP User Manual*.

**WARNING**

Make sure that the power to both the 6085 and the 4045 is switched off before connecting the cables.

To connect the 4045 Laser CP to the 6085 Professional Computer System:

1. Route the interface cable between the 6085 workstation and the 4045 Laser CP, making sure to orient the connectors so that the correct one for each device is nearest that device. Place the cable out of the main traffic area, along the wall, behind desk legs, and the like. Keep the cable away from damp surfaces or heat producing devices (Figure 2-7).



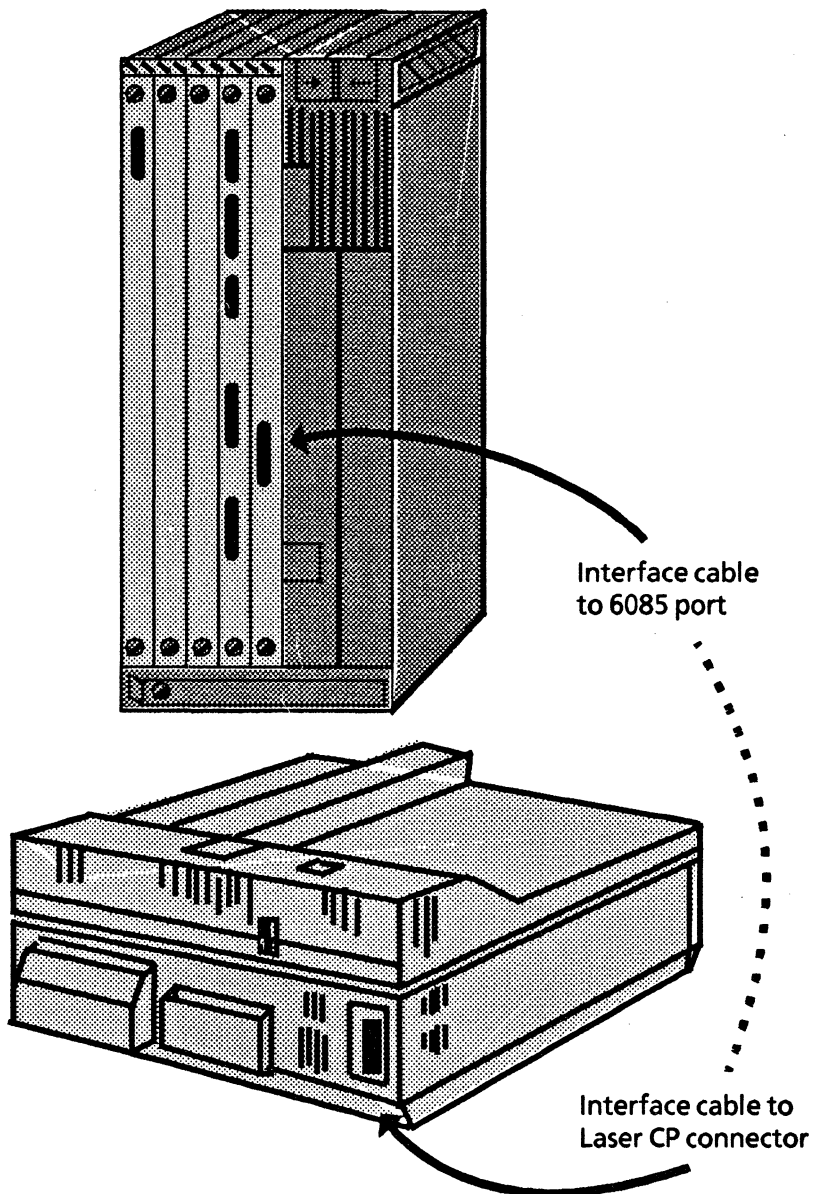
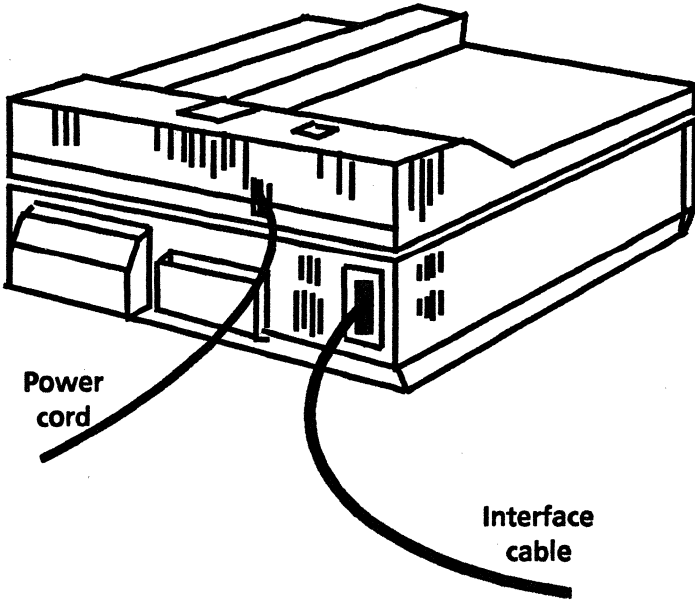

Figure 2-7 Connecting the Laser CP to the 6085

2. Attach the cable connector at the Laser CP (Figure 2-8). Secure the cable with the latches on the connector.



**Figure 2-8 4045 Laser CP interface cable connection**

3. Attach the cable connector to the "Printer" port on the C5 shield (Figure 2-9). Tighten the two screws to secure the connector.

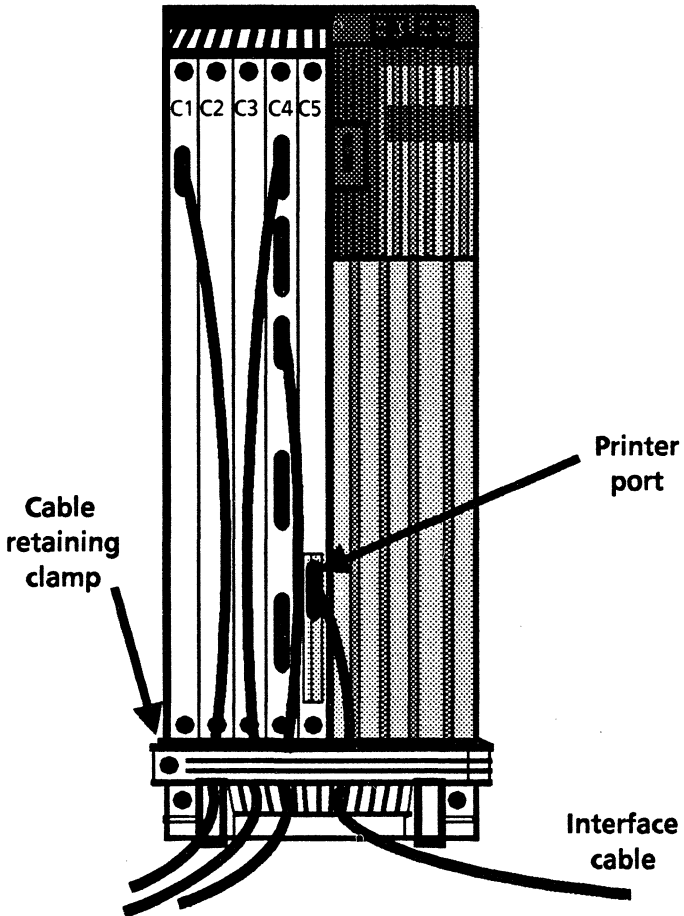

Figure 2-9 6085 interface cable connection

4. Return the 6085 workstation to its original position.
5. Continue with the procedure, "Configuring the hardware."

---

## Configuring the hardware

---

After installing the hardware, you must record a description of your system's configuration on your workstation processor, for use by the software. The 6085 Offline Diagnostics software is used for this purpose.

**Note:** Hardware must be installed and powered-on before using the 6085 Offline Diagnostics software.

Configuring the hardware consists of the following tasks:

- Install the 6085 Offline Diagnostics software.
- Set the configuration to reflect your system.
- Record your configuration on the processor.

The procedures for these tasks are described in following paragraphs.

---

## Install the 6085 offline diagnostics

---

Install the 6085 offline diagnostics using the appropriate procedure for your workstation:

- Floppy disk installation
- Network installation

## Floppy disk installation

---

The 6085 offline diagnostics software is contained on a set of two floppy disks:

- 6085 offline diagnostics disk 1
- 6085 offline diagnostics disk 2

To install the 6085 offline diagnostics:

1. Insert the floppy disk labeled "6085 Offline Diagnostics #1" into your floppy disk drive, turn down the handle, and press the red B RESET button on the front of the processor. The B RESET button is located just below the on/off (1/0) button. After a few moments, a row of icons appears at the bottom of the display.
2. Press <F2> in the top row of function keys. The offline diagnostics software is copied into the main memory of the 6085. While the software is being copied, four small numbers appear in the top left corner of the display. The display then clears; after a few moments, a message appears, requesting that you load 6085 offline diagnostics disk 2. Continue with the procedure, "Set the configuration."

## Network installation

---

To install the 6085 offline diagnostics software from the network:

1. Press the red B RESET button on the front of the processor. The B RESET button is located just below the on/off (1/0) button. After a few moments, a row of icons appears at the bottom of the display.
2. Press the <F3> in the top row of function keys. After a few moments, a list of options appear on the display. Continue with the procedure, "Set the configuration."

3. Type the number corresponding to 6085 offline diagnostics. The 6085 offline diagnostics software is copied into the main memory of the 6085.
4. Continue with the procedure, "Set the configuration."

## Set the configuration

---

To set the configuration:

1. After the offline diagnostics are loaded, the following prompt is displayed:

What class of user do you belong to?

2. Type 1 and press <RETURN> to select the "I Am A Normal User" option. A diagnostic menu is displayed.
3. Type the number corresponding to the System Configuration Utility option and press <RETURN>.
4. Type 1 and press <RETURN> to select the Set Configuration option. The next series of displays present questions about the configuration. As each question is presented, a number is displayed next to the cursor indicating the current configuration option set for that item.
5. Press <RETURN> after each question until the following question is displayed:  

Do you have the LPO option? [Y/N]
6. Type Y. A menu is displayed requesting the number of bits of virtual memory required.
7. Type the number corresponding to twenty three bits of VM (virtual memory). Continue with the procedure, "Record your configuration on the processor."

## Record your configuration on the processor

---

At this point you have indicated the options you would like to have set, but they have not been recorded on your processor. The new configuration answers you have selected, along with the currently set configuration data, are displayed at the bottom of the display.

1. Do you want your workstation reconfigured with the options you have selected? [Y/N].

Type Y if you want to record your new configuration and have it replace the current configuration. Then proceed to step 2.

Type N if you do not want to record your new configuration and have it replace the current configuration.

**Note:** If you type N, the message, "The user has aborted the hardware configuration store process" appears. At this point you may press any key to return to the System Configuration Utility menu. On the menu, you may choose the Show Configuration option, which will display the configuration data you started with, or you may choose the Set Configuration option to reset the configuration of your system. If you choose the Set Configuration option, return to "Set configuration" procedure and follow the instructions before continuing with the following steps.

2. Respond to the prompt, "Please confirm that you want your workstation reconfigured with the options you have selected. [Y/N]."

Type **Y** to confirm and record your configuration.

Type **N** to abort, and then follow the information contained in the note to step 1.

If you typed **Y** to confirm and record your configuration, a message appears indicating that the hardware configuration has been completed. This is followed by a display of the current configuration (which has been replaced), along with the new configuration that you have just recorded on your processor.

3. Press any key to return to the System Configuration Utility menu. Your system configuration data should now reflect the actual system configuration you have. Remove the disk from the floppy disk drive.

**Note:** You can select the Show Configuration option to see that the new configuration data is displayed. If you have to correct any errors, you may select the Set Configuration option again.

4. Press the **B RESET** button on your processor to boot your system. Then proceed with normal operation.

**WARNING**

If you have not answered the configuration questions correctly, your workstation will not know the correct configuration. This may cause your system to work improperly at some later time.



## Checking the configuration cartridge setting

When the 4045 Laser CP power is switched on, the printer performs a self-test and prints a configuration sheet indicating the 4045 Laser CP configuration cartridge switch settings. Figure 2-10 illustrates the setting for the configuration cartridge switches. Check the configuration sheet to ensure that the switches are set correctly. If necessary, set the switches to the proper settings and reset the Laser CP by holding down Reset, then pressing Offline or by switching the Laser CP power off then on again.

**Note:** For information on removing and installing the configuration cartridge, refer the *4045 Laser CP User Manual*.

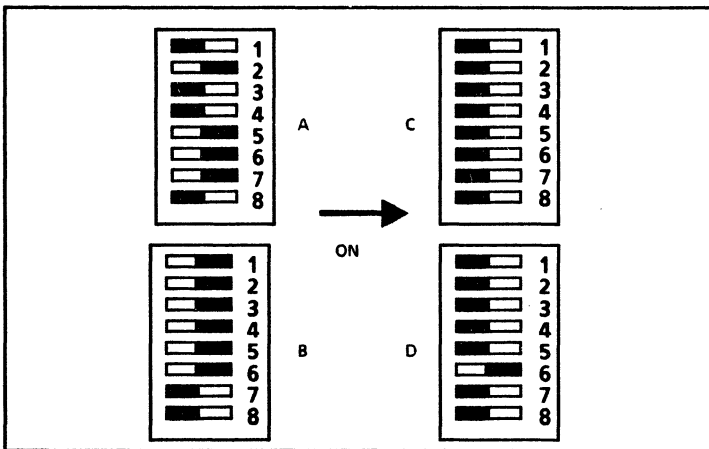



1 =  = ON  
 0 =  = OFF

Figure 2-10 Configuration cartridge switch settings

---

## Checking hardware operation

---

After installing the Local Printer Option board and connecting the 4045 Laser CP, ensure proper hardware operation by performing offline boot diagnostics.

To verify hardware operation:

1. Power up the workstation, if necessary.
2. Press the B RESET button on the processor's front panel
3. Diagnostics can be booted from the workstation rigid disk, from floppy disk, or from the network. Press the desired key in the top row of function keys:
  - Press <F5> to boot diagnostics from the rigid disk
  - Press <F6> to boot diagnostics from floppy disk
  - Press <F7> to boot diagnostics from the network

The screen darkens and displays a maintenance panel (MP) code in the middle of the screen.

4. While the MP code is between A400 and A409, press <STOP>. The MP code displays A499.
5. Press <F>. The MP code will cycle.
6. Press <J>. The MP code displays FFDE and then after a moment displays 1D/99.

7. Type <S> and <0> (numerical zero); then press <RETURN>. The loopback diagnostics begin to verify the LPO board.
  - The MP code should read: 1D00, 1D01 and then 1D99. Upon successful completion, proceed to Chapter 3, Software Installation.
  - If the MP code flashes (alternates between two codes) at any point, an error has occurred. Contact your 6085 Service Representative.
  
8. Type <S> and <4>; then press <RETURN> to print a test pattern (consisting of a partial page alpha-numeric pattern). The MP code should display, 1D00, 1D01, 1D02, 1D03 and 1D99.
  - Upon successful completion, the MP codes all display successfully and two copies of the test pattern are printed.
  - If the MP code flashes (alternates between two codes) at any point, an error has occurred. Contact your Printer Service Representative.



## 3. Software installation

---

VP Local Laser Printing software enables ViewPoint and IBM PC emulation documents created on your 6085 Professional Computer System to be printed on a directly attached local laser printer. VP Local Laser Printing software is an optional ViewPoint application that is separately loaded at a networked, remote, or standalone 6085 Professional Computer System.

This chapter describes:

- Enabling software and fonts
- Installing the application software
- Installing the local laser printer fonts

Figure 3-1 illustrates the general installation steps.

**Notes:**

- VP Local Laser Printing software can be loaded from floppy disks or from a network file service. Refer to the installation procedures for your system.
- The tab titled "6085 Software Installation" contains information on loading ViewPoint software.

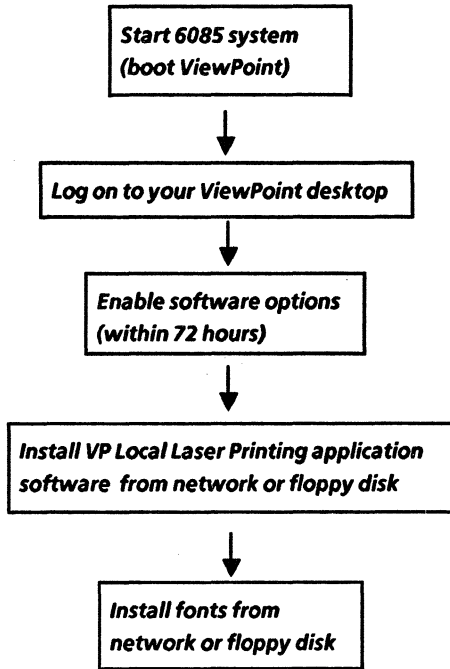

**Figure 3-1 Software installation steps**

---

## Installing software from floppy disk

---

VP Local Laser Printing software can be installed from floppy disks. Software installation consists of the following procedures:

- Enabling software and fonts
- Installing the application software
- Installing the local laser printer fonts

---

### Enabling software and fonts

---

VP Local Laser Printing software and fonts must be enabled using the Software Options Tool. Software installed but not enabled with the software options tool cannot be used after the initial 72-hour grace period. The tab titled "Software Options Tool" contains information on enabling software and fonts.

#### Notes:

- All workstation software is available for use for 72 hours from the time the workstation is initially booted to provide enough time for you to enable software options permanently using the software options tool.
- Enabling software options affects all desktops on a workstation. Therefore, software options need to be enabled only on one desktop.

## Installing the application software

To install VP Local Laser Printing application software from floppy disk:



1. Select the directory icon and press <OPEN>. A window containing a list of available dividers will open on the lefthand side of your screen.

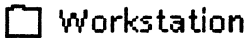

2. Select the workstation divider in the directory window and press <OPEN>.

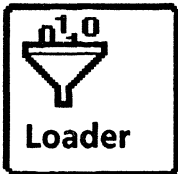

3. Select the loader icon , press <COPY> (located on the lefthand side of the keyboard), and select a destination on the desktop.

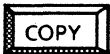

4. Select [CLOSE] to close the workstation divider. (The first level of the directory window should now be displayed.)

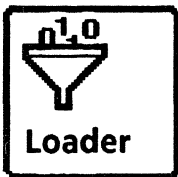

5. Select the application loader icon and press <OPEN>. The application loader window is displayed.



6. Insert the VP Local Laser Printing application software floppy disk in the floppy disk drive.



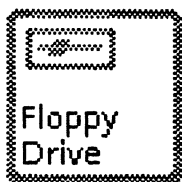

6. Select the floppy disk icon on the desktop, press <OPEN>, select the VP Local Laser Printing application, press <COPY>, and select the application loader window.

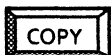

7. Select [Run] to start the application.
8. Select [Close] to close the application loader window.

## Installing the local laser fonts

---

Local laser fonts can be installed from floppy disks. When you select the [Show Printer Fonts] command in the application loader window, the local laser printer font files available to the Laser CP are displayed.

### Notes:

- The VP Local Laser Printing application must be running to display the [Show Printer Fonts] command in the application loader window.
- A local laser printer font must be enabled before the font can be copied into the application loader.
- The printer must be idle while fonts are being installed.

To install fonts from floppy disks:

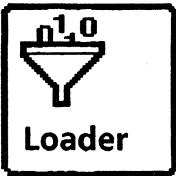

1. Select the application loader icon and press <OPEN>. The application loader window is displayed (Figure 3-3).
2. Select [Show Printer Fonts]. The local laser printer font window commands are displayed (Figure 3-4).

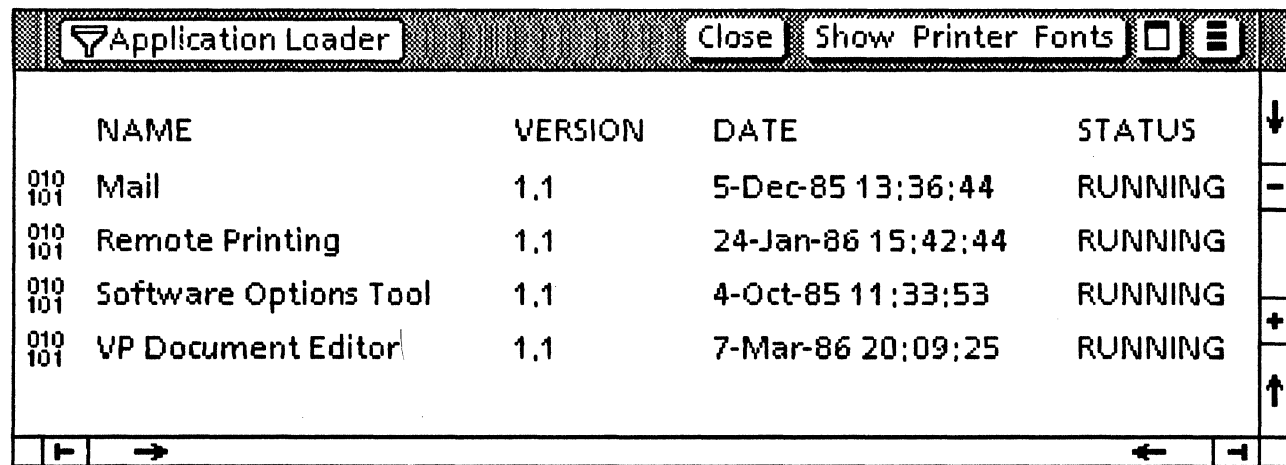

The screenshot shows a window titled "Application Loader" with a standard Mac OS-style title bar. The window contains a table with four columns: NAME, VERSION, DATE, and STATUS. The table lists four applications, all with version 1.1 and status "RUNNING". The first application is "Mail" with a date of "5-Dec-85 13:36:44". The second is "Remote Printing" with a date of "24-Jan-86 15:42:44". The third is "Software Options Tool" with a date of "4-Oct-85 11:33:53". The fourth is "VP Document Editor" with a date of "7-Mar-86 20:09:25". The window has a scrollbar on the right and a status bar at the bottom with navigation arrows.

	NAME	VERSION	DATE	STATUS
010 101	Mail	1.1	5-Dec-85 13:36:44	RUNNING
010 101	Remote Printing	1.1	24-Jan-86 15:42:44	RUNNING
010 101	Software Options Tool	1.1	4-Oct-85 11:33:53	RUNNING
010 101	VP Document Editor	1.1	7-Mar-86 20:09:25	RUNNING

Figure 3-2 Application loader window

Application Loader			Edit Font Directory	Save Font Directory	□	☰
FONT FILE	DATE	SIZE				
ⓐ Xerox,Graphics,Newvec	24-Apr-81 15:29:40	133 Disk Pages	↓			
ⓐ Xerox,XC1-1-1,Modern	17-Dec-85 15:20:14	2035 Disk Pages	-			
ⓐ Xerox,XC1-1-1,Modern,Bold	17-Dec-85 16:31:14	1659 Disk Pages	+			
ⓐ Xerox,XC1-1-1,Modern,Bold,Italic	17-Dec-85 17:21:48	1685 Disk Pages	↑			
ⓐ Xerox,XC1-1-1,Modern,Italic	18-Dec-85 10:10:41	1590 Disk Pages	↑			
← →				←		→

Figure 3-3 Local laser printer fonts

3. Select [Edit Font Directory]. If the printer is in use, a message appear requesting that you wait until the printer is idle before adding new fonts.
4. For each font floppy disk:
  - a. Insert the font floppy disk in the floppy disk drive.
  - b. Select the floppy disk icon on the desktop and press <OPEN> ,
  - c. Select the desired font(s), press <COPY> , and select the application loader window.
5. Select [Save Font Directory]. The new fonts are now available to the printer.
6. Select [Close] to return the application loader window.

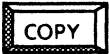

**Notes:**

- Xerox.Graphics.Newvec is a required font. Deleting the Xerox.Graphics.Newvec font will prevent printing.
- Either Xerox Modern Fonts (all point sizes) or Xerox Modern Fonts (point sizes 6-18) may be installed, but not both (Table 3-1). Users with sufficient disk space can replace the abbreviated Modern font set with the full Modern font set.

**Table 3-1 Modern Fonts disk page requirements**

Font	full set	abbreviated set
Xerox.Graphics.Newvec	133	133
Xerox Modern	2035	585
<b>Modern Bold</b>	1659	555
<b>Modern Bold Italic</b>	1685	568
<b>Modern Italic</b>	1590	536

---

## Installing software from the network

---

VP Local Laser Printing software can be installed from a network File Service. Software installation consists of the following procedures:

- Enabling software and fonts
- Installing the application software
- Installing the local laser fonts

---

### Enabling software and fonts

---

VP Local Laser Printing software and fonts must be enabled using the Software Options Tool. Software installed but not enabled with the software options tool cannot be used after the initial 72-hour grace period. The tab titled "Software Options Tool" contains information on enabling software and fonts.

#### Notes:

- All workstation software is available for use for 72 hours from the time the workstation is initially booted to provide enough time for you to enable software options permanently using the software options tool.
- Enabling software options affects all desktops on a workstation. Therefore, software options need to be enabled only on one desktop.

## Installing the application software

---

This section describes how to install VP Local Laser Printing application software from a network File Service.

**Notes:** The installation instructions that follow apply only to workstations attached to the network, directly or via modem.

The software for each VP application or font is stored in the VP Applications Drawer. Ask your System Administrator for the exact location of this drawer before attempting installation of application software.

### Log on and create desktop

---

1. Press any key to display the logon option sheet.
2. Type your fully-qualified name (name:domain:organization), and press <NEXT> (located on the righthand side of the keyboard).
3. Type your password and press <NEXT>.
4. Select [YES] on the logon option sheet if the option "Do you want a new desktop created for you?" is displayed. After a few minutes, the desktop appears with the directory icon in the lower righthand corner of the screen.



5. Select the directory icon and press <OPEN>. A window containing a list of available dividers will open on the lefthand side of your screen.

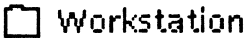

6. Select the workstation divider in the directory window and press <OPEN>.

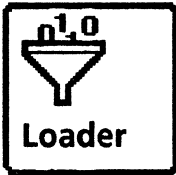

7. Select the loader icon press <COPY> (located on the lefthand side of the keyboard), and select a destination above the directory.

8. Select [CLOSE] to close the workstation divider. (The first level of the directory window should now be displayed.)



9. Select the network divider in the directory window and press <OPEN>.

10. Locate the desired file service, by opening the appropriate organization, domain, and filing divider icons.

11. Select the appropriate file server divider icon and press <OPEN>.

12. Select the file drawer labeled "VP Applications Drawer," press <COPY>, and select a destination on the desktop.

13. Select [CLOSE ALL] to close the directory window.



---

## Install VP Local Laser Printing application software

---

To install the software on the workstation's rigid disk, the application must be copied from the VP Applications Drawer to the loader icon on the desktop.

1. Open the VP Applications Drawer icon.
2. Select VP Local Laser Printing, press <COPY>, and select the loader icon as the destination. A message appears in the desktop message area indicating that the VP application is being loaded.
3. Select [Run] to start the application.
4. Continue with the procedure titled "Enabling software and fonts" for information on enabling software options. Installation procedures are not complete until software is enabled.

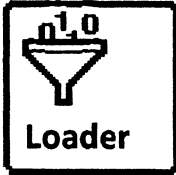

**Note:** The sub-tab titled "Application Loader" in the VP Series reference library contains complete information on the loader icon.

## Installing the local laser fonts

---

Use the following procedures to install fonts from a network File Service. When you select the Show Printer Fonts command in the Application Loader, the local laser printer font files are displayed. This is the list of the fonts available to the Local Laser Printer. Fonts can be installed from a network file service.

This section describes how to install fonts on a workstation from the network. The installation instructions that follow apply only to workstations attached to the network, directly or via modem.

The software for each font is stored in the VP Applications Drawer. Ask your System Administrator for the exact location of this drawer before attempting installation of application software.

### Notes:

- The VP Local Laser Printing application must be running to display the [Show Printer Fonts] command in the application loader window.
- A local laser printer font must be enabled before the font can be copied into the application loader.
- The printer must be idle while fonts are being installed.

## Copy the VP Applications Drawer icon

To copy the VP Applications Drawer icon to the desktop:



1. Select the network divider in the directory window and press <OPEN>.
2. Locate the desired file server, by opening the appropriate organization, domain, and filing divider icons.
3. Select the appropriate file server divider icon and press <OPEN>.
4. Select the file drawer labeled "VP Applications Drawer," press <COPY>, and select a destination on the desktop.
5. Select [CLOSE ALL] to close the directory window.

## Install fonts

To install the software on the workstation's rigid disk, the application or font must be copied from the VP Applications Drawer to the loader icon on the desktop.

1. Open the VP Applications Drawer icon.
2. Select the application loader icon and press <OPEN>. The application loader window is displayed (Figure 3-6).

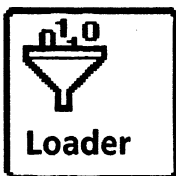

3. Select [Show Printer Fonts]. The local laser printer font window commands are displayed (Figure 3-7).

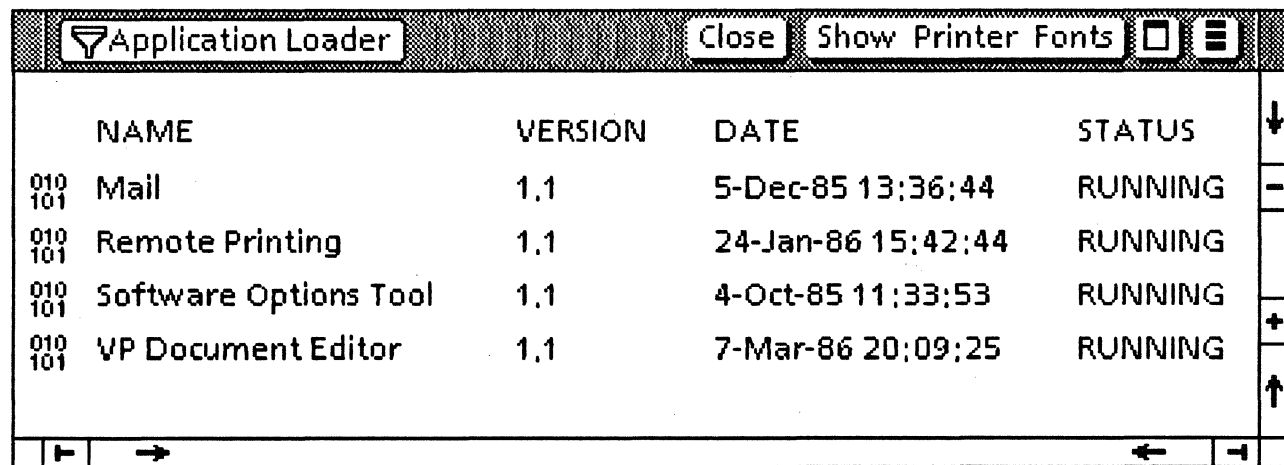

The screenshot shows a window titled "Application Loader" with a menu bar containing "Close" and "Show Printer Fonts". The main area contains a table with columns for NAME, VERSION, DATE, and STATUS. The table lists four applications: Mail, Remote Printing, Software Options Tool, and VP Document Editor, all with version 1.1 and status RUNNING. The table has a vertical scrollbar on the right and a horizontal scrollbar at the bottom.

	NAME	VERSION	DATE	STATUS	
010 101	Mail	1.1	5-Dec-85 13:36:44	RUNNING	↓
010 101	Remote Printing	1.1	24-Jan-86 15:42:44	RUNNING	-
010 101	Software Options Tool	1.1	4-Oct-85 11:33:53	RUNNING	+
010 101	VP Document Editor	1.1	7-Mar-86 20:09:25	RUNNING	↑

Figure3-4 Application loader window

FONT FILE	DATE	SIZE
<input type="checkbox"/> Xerox,Graphics,Newvec	24-Apr-81 15:29:40	133 Disk Pages
<input type="checkbox"/> Xerox,XC1-1-1,Modern	17-Dec-85 15:20:14	2035 Disk Pages
<input type="checkbox"/> Xerox,XC1-1-1,Modern,Bold	17-Dec-85 16:31:14	1659 Disk Pages
<input type="checkbox"/> Xerox,XC1-1-1,Modern,Bold,Italic	17-Dec-85 17:21:48	1685 Disk Pages
<input type="checkbox"/> Xerox,XC1-1-1,Modern,Italic	18-Dec-85 10:10:41	1590 Disk Pages

Figure 3-5 Local laser printer fonts

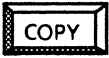

4. Select [Edit Font Directory]. If the printer is in use, a message appears requesting that you wait until the printer is idle before adding new fonts.
5. For each desired font, select the font in the VP Applications Drawer, press <COPY>, and select the loader icon as the destination. A message appears in the desktop message area, indicating that the font is being copied. Repeat this step for each font that is to be installed.
6. Select [Save Font Directory]. The new fonts are now available to the printer.
7. Select [Close] to close the application loader window.

**Notes:**

- The sub-tab titled "Application Loader" in the VP Series reference library contains complete information on the loader icon.
- Xerox.Graphics.Newvec is a required font. Deleting the Xerox.Graphics.Newvec font will prevent printing.
- Either Xerox Modern Fonts (all point sizes) or Xerox Modern Fonts (point sizes 6-18) may be installed, but not both (Table 3-2). Users with sufficient disk space can replace the abbreviated Modern font set with the full Modern font set.

**Table 3-2 Modern Fonts disk page requirements**

Font	full set	abbreviated set
Xerox.Graphics.Newvec	133	133
Xerox Modern	2035	585
<b>Modern Bold</b>	1659	555
<i>Modern Bold Italic</i>	1685	568
<i>Modern Italic</i>	1590	536

This chapter contains procedures for copying the local laser printer icon to the desktop and printing ViewPoint documents in Interpress format. For information on printing PC emulation documents, refer to the tab in the VP Series reference library titled "VP PC Emulation."

This chapter describes the following actions:

- Copying the local laser printer icon
- Printing a document
- Canceling a document in progress

The following property/option sheets are described:

- Local laser printing property and option sheets
- Local printer window
- Local printer attention request window

The following procedures are also described:

- Printing envelopes
- Adding paper while printing
- Copying while printing

## Copying the local laser printer icon

---

The local laser printer icon (Figure 4-1) is copied from the directory to the desktop.



Figure 4-1 Local laser printer icon

To copy the local laser printer icon to the desktop:



1. Select and open the directory icon.

- |  |  |
|--|--|
| <input type="checkbox"/> Workstation   | 2. Select and open the workstation divider icon.   |
| <input type="checkbox"/> Local Devices | 3. Select and open the local devices divider icon.   |
|  | 4. Copy the local laser printer icon to the desktop. The printer is now available for operation. |

**Notes:** Documents can also be printed by copying or moving the document icon to the local laser printer icon in the local devices divider.

The section titled "Local laser printing property and option sheets" contains information on the laser printer property sheet.



---

## Printing a document

---

To print a document on the local laser printer:

1. Select the data icon (Figure 4-2) to print.

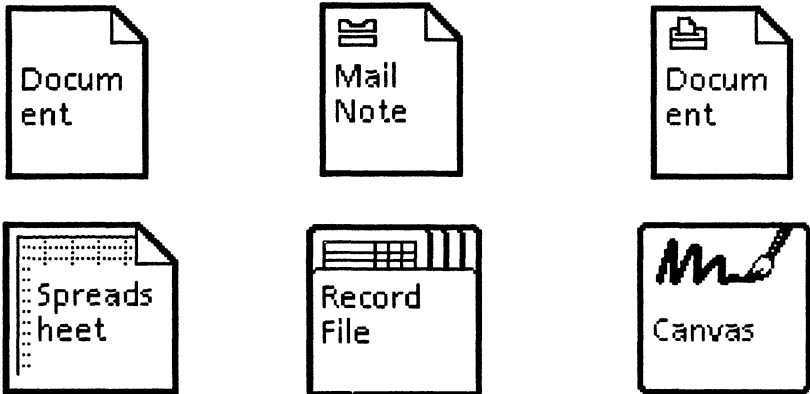
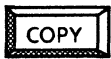

Figure 4-2 Data icons



or



2. Press <COPY> or <MOVE>.

**Note:** Whether you use <MOVE> or <COPY>, the original copy of the document is retained on the desktop.

3. Select the local printer icon. The local laser printing option sheet is displayed.
4. Select the desired printing options on the local laser printing property sheet. The section titled, "Local laser printing property and option sheets" contains information on the option sheet.
5. Select [START].

Printer status information is displayed in the desktop herald window. Upon successful completion, the following message is displayed in the message window:

**<doc> printing completed.**  
The printing is finished.

**Note:** If the workstation beeps after clearing a jam or adding paper, check the subsequent pages to insure that no pages have been omitted, added, or printed out of order. This is not expected to happen.

If an error occurs, one of the following messages is displayed in the message window:

**Local printer option hardware is not installed or not configured.**

The option board required to attach the 4045 Laser CP to the 6085 is not installed or the 6085 hardware has not been configured for the option. Check that the board is seated correctly and that the cable connections are secure. Refer to the procedure, "Configuring the hardware" for information on configuration.

**<doc> printing canceled, no printer connected or power is off.**

The Laser CP power is not switched on or the printer cable is not properly connected. Check that the printer cable is securely connected and ensure that the printer power is on.

**<doc> printing completed with warnings.**

There was a recoverable error in processing the document. If [CREATE STATUS SHEET] is selected on the printing property sheet, more detailed information is available in the error log window. Printed output should be checked.

**Printing canceled due to insufficient memory resources for processing.**

There is not enough memory to print this object.

**Note:** Do not perform two-sided printing. Two-sided printing can cause contamination of the fuser area with toner, requiring Xerox service.

---

## Canceling the document in progress

---

The [Cancel Local Laser Print Job] desktop auxiliary menu command cancels the document currently being printed by the 4045 Laser CP.

1. Select [Cancel Local Laser Print Job] from the desktop auxiliary menu (Figure 4-3). Printing of the document in progress is suspended.

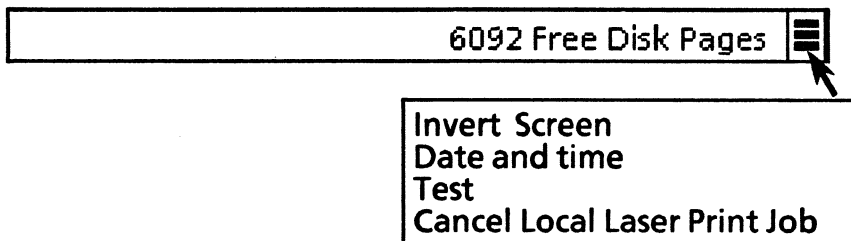

**Figure 4-3 Desktop auxiliary menu**

The following prompt is displayed:

Are you sure you wish to cancel 4045 printing?  
[YES][NO]

2. Select [YES] to cancel printing. If you select [YES], the following message is displayed:

<doc> printing canceled by user.

If you select [NO], the printing will continue.

**Note:** Only the document currently being printed will be canceled.

**Printing Properties** Done Cancel Defaults

Number of copies

Icon Label

Paper Tray With    loaded.

Printer Priority

Output

On the first error

For each object

see next  
page

see  
previous page

Hardware options	SEQUENCER	
Print Order	LAST PAGE	FIRST PAGE out first.
Printed Image	NORMAL	SPECIAL CONTROL
AVOID TINY FLAWS < NORMAL > >> AVOID WHITE BANDS		
After printing	DELETE	DON'T DELETE the print format document.
Print	Collated	+
When printing	DISPLAY OPTIONS	↑
← → ← →		

Figure 4-4 Laser printing property sheet

---

## Local laser printing property and option sheets

---

The local laser printing property (Figure 4-4) and option sheets are used to select options for printing documents.

The local laser printing property sheet is displayed by selecting the local laser printer icon and pressing <PROP'S>.

The local laser printing option sheet is displayed whenever a document is copied to the local printer if [DISPLAY OPTIONS] is selected on the local laser printing property sheet. The option sheet can be used to override properties set on the property sheet for printing specific documents.

---

### Window command

---

The following is a description of the commands located in the gray area at the top of the property sheet window.

**[DONE]**

Closes the property sheet and applies the properties currently set.

**[CANCEL]**

Closes the property sheet without applying any changes to the properties.

**[START]**

Begins printing the document.



Causes the window management commands to appear when the pointer is placed over the auxiliary menu and the left mouse button is held down. The sub-tab titled "Windows" in the VP Series reference library contains detailed information on the window management commands.



Causes the window commands that have been placed into the floating items auxiliary menu to appear when the pointer is placed over the auxiliary menu and the left mouse button is held down. Window commands are placed in the auxiliary menu when the window is not wide enough to accommodate the commands.

## Properties

---

The following is a list of the properties.

### Number of copies

Specifies the desired number of copies of the document to be printed.

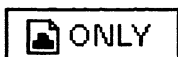

Creates an Interpress master of the document without printing. This option can be helpful for distributing Interpress copies of a document without having to print the document. When selected, the number of copies is set to 0 and [DON'T DELETE] is selected for the [After printing] option.

### Icon label

Optionally specifies a name for the local printer.

### Paper tray with

[LETTER]

Specifies that the paper in the printer is 8.5 inches by 11 inches.

**[LEGAL]**

Specifies that the paper in the printer is 8.5 inches by 14 inches.

**[ENVELOPES]**

Specifies that xerographic envelopes are loaded in the printer.

**Notes:** Make sure that the proper size paper is loaded in the paper tray.

An envelope cassette tray is necessary for printing envelopes.

**Printer priority**

Specifies the priority of the printing process. Though printing always takes place as a background process, printing can reduce the performance of other activities on the desktop (including background pagination and formatting for printing), depending on printer priority. The printer priority can be changed at any time, even while a document is being printed. Changes in the priority take place immediately, will affect whatever document is being processed at the time the change in priority is selected, and will stay in effect until changed again.

**[HIGH]**

Specifies that the printer will have higher priority than other activities performed on the desktop, such as keyboard and mouse operations.

**[LOW]**

Specifies that the printer will have lower priority than other activities performed on the desktop, such as keyboard and mouse operations.

**[VERY LOW]**

Specifies that the printer will run only if you are not performing any action on the desktop, giving the keyboard and mouse all of the processor's power. Printing will resume 10 seconds after other desktop activities are complete.



## **Output**

### **[Draft Mode]**

When this option is selected, documents are printed with increased printing speed and slightly lessened print quality (300 horizontal by 150 vertical DPI resolution). Draft mode can be used for intermediate copies of a document being edited, for example.

## **On the first error**

### **[Stop for Inspection]**

This option provides for notification (via an attention request window) whenever there is a serious decomposition or compression problem with the document being printed. These errors are: a missing character in a font, image printed off the page, specified point size not available, or a page cannot be successfully compressed and will be cut off at the bottom. When this option is not selected, the window will not appear and the printing software will proceed the best it can to print the complex page(s). The default setting for this option is not selected.

## **For each object**

### **[Create Status Sheet]**

This option enables the creation of status sheets for each document printed with errors on the local laser printer. The status sheet lists the page number and type of error (both serious and minor) for each page in the document which had any kind of error in decomposition or compression for printing. The status sheets are filed in a folder which is placed on the desktop and is titled "VP Local 4045 Error Log." The default is to create the status sheets.

**Note:** Status sheets are only created for documents printed with errors.

### Hardware options

#### [Sequencer]

This option indicates whether or not a sequencer is attached to the Laser CP. The page sequencer (inverter) is an optional device which flips the paper on output so the document is stacked in the proper order. If [Sequencer] is not selected, the [Print order] option displays.

### Print order

Specifies the order in which the printed pages are delivered to the print output tray. For both options, pages are delivered to the output tray face up. If the printer has a Sequencer, this option does not display on the property sheet.

#### [LAST PAGE] out first

The document will be printed with page one on top of the stack. This is the default.

#### [FIRST PAGE] out first

The document will be printed with the last page on top of the stack. Page one is output first, for quick viewing and editing.

### Printed Image

In rare cases, a printed page may show either tiny flaws in text character shapes or an image interrupted by white bands across the page. These problems can be corrected with the [SPECIAL CONTROL] selection.

Tiny text flaws, referred to in status sheets as lessened image quality, are caused by extreme text density and are difficult to detect. Text flaws are noted in the status sheet, if [CREATE STATUS SHEET] is selected. If the page is extremely dense, a cut-off page may result, and will be noted in the status sheet, if [CREATE STATUS SHEET] is selected and the attention request window, if [STOP FOR INSPECTION] is selected.

White bands (1/10-inch image gaps) are caused by extreme complexity in the information to be printed (typically graphics). White bands, which occur very rarely, are not detected by the system and must be checked for by examining the printed output.

**[NORMAL]**

This setting prints the image correctly in most cases. This is the default setting.

**[SPECIAL CONTROL]**

If a problem appears on a printed page, selecting [SPECIAL CONTROL] displays the settings illustrated in Figure 4-5.

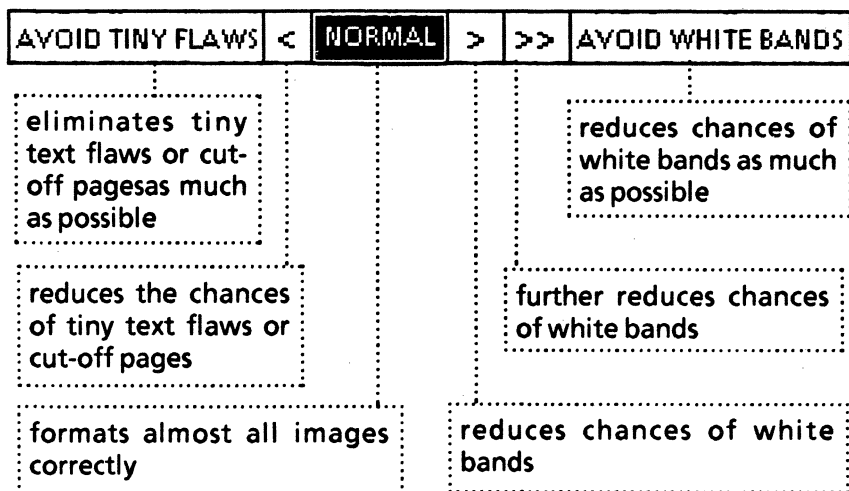

Figure 4-5 Special control settings

**Note:** [SPECIAL CONTROL] settings should generally be used only when a problem appears on a printed page. Deselecting [SPECIAL CONTROL] automatically returns the setting to normal.

**After printing**

**[DELETE]**

The print format document is deleted after printing.



**[DON'T DELETE]**

After printing, a print format document appears on the desktop with the document name.

**Print**

**[Collated]**

Prints, for each copy requested, the entire contents of the folder.

**Note:** Documents contained in the folder print in correct order if [LAST PAGE out first] is selected.

**When printing**

**[DISPLAY OPTIONS]**

When this option is selected, the local laser printer option sheet is displayed when a document is copied or moved to the local laser printer icon. When this option is not selected, printing starts immediately after a document icon is moved to the local laser printer icon.

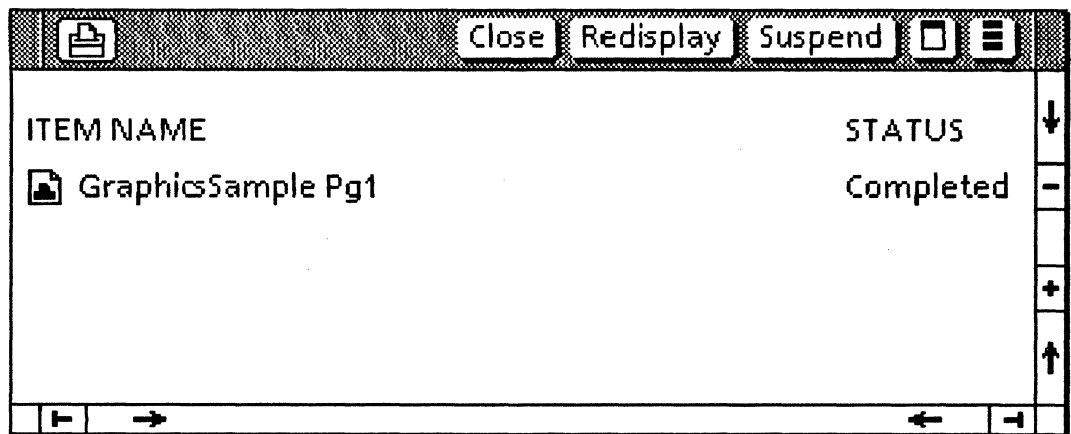

Figure 4-6 Local printer window

---

## Local printer window

---

The local printer window (Figure 4-6) displays the queue of print requests and their current status for the specific printer.

The local printer window is displayed by selecting a local printer icon and pressing <OPEN>.

---

## Window commands

---

The following is a description of the commands located at the top of the window in the gray area.

**[CLOSE]**

Closes the window.

**[REDISPLAY]**

Displays the current status of print requests in the queue.

**[SUSPEND]**

Halts the sending of print requests to the printer upon completion of the current document. To stop the printing of the current document, printing can be canceled, if desired. The procedure "Canceling the document in progress" contains instructions on how to stop the printing of the current document.



Causes the window management commands to appear when the pointer is placed over the auxiliary menu and the left mouse button is held down. The sub-tab titled "Windows" in the VP Series reference library contains detailed information on the window management commands.







Causes the window commands that have been placed in the floating items auxiliary menu to appear when the pointer is placed over the auxiliary menu and the left mouse button is held down. Window commands are placed in the auxiliary menu when the window is not wide enough to accommodate the commands.

## Window items

---

Print requests in the printer window are displayed in the following format:

ITEM NAME	STATUS
 Calendar 1985	Completed
 Accounts Paid	Canceled
 Tax Records	Being Sent
 Phone Lists	Queued for Sending
 Charts	Completed with warnings

**Note:** Print requests displayed in the window that have not been sent to the printer at logoff time will not be printed unless otherwise indicated on the logoff option sheet.

Terms used in the Status column have the following meanings:

<b>Status</b>	<b>Description</b>
<b>Completed</b>	<b>Document has finished printing.</b>
<b>Being Sent</b>	<b>Document is being transmitted to the printer.</b>
<b>Queued for Sending</b>	<b>Document is queued, but not yet sent to the printer.</b>
<b>Canceled</b>	<b>Printing was canceled by the user at the desktop or at the printer.</b>
<b>Completed with warnings</b>	<b>There were recoverable errors in processing. If [CREATE STATUS SHEET] is selected on the printing property sheet, more detailed information is available in the error log window. Printed output should be checked.</b>



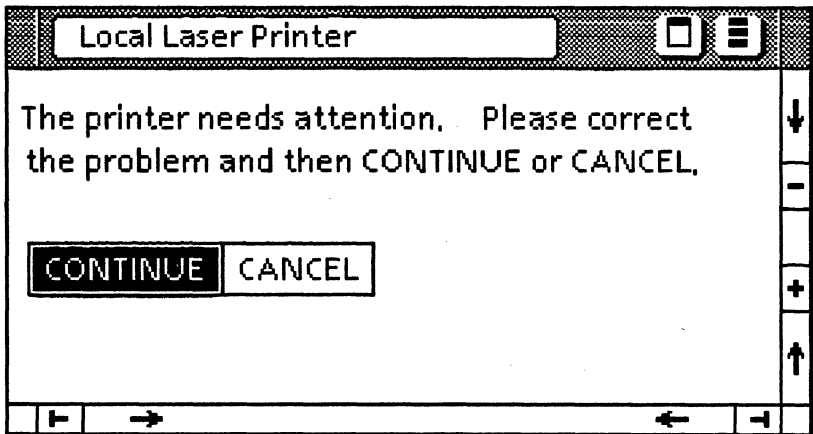

Figure 4-7 Local printer attention window

---

## Local printer attention window

---

The local printer attention window (Figure 4-7) provides additional interface options regarding the printing of a data icon by the local printer.

The local printer attention window is displayed when a local printer is interrupted.

---

## Window commands

---

The following is a description of the commands located at the top of the window in the gray area.

**[DONE]**

Closes the window and applies the option selected.



Causes the window management commands to appear when the pointer is placed over the window management auxiliary menu and the left mouse button is held down. The sub-tab titled "Windows" in the VP Series reference library contains information on the window management commands.



Causes the window commands that have been placed in the floating items auxiliary menu to appear when the pointer is placed over the auxiliary menu and the left mouse button is held down. Window commands are placed in the auxiliary menu when the window is not wide enough to accommodate the commands.

## Options

---

The following is a list of the options that appear in the window.

**[CONTINUE]**

Continues the printing process at the point of interruption.

**[CANCEL]**

Cancels the printing process of the document currently being printed.

## Messages

---

The following is a list of the messages that appear in the window:

**The printer needs attention. Please correct the problem and then CONTINUE or CANCEL.**

The printer requires paper or a paper jam has occurred. Refer to the quick reference pull-out cards on the 4045 Laser CP for corrective action. When a jam occurs, clear the paper path of all sheets not in the output tray and printing will continue with the correct page number.

**Part of page nn will be cut off due to complexity. CONTINUE to print this page as a partial image.**

A page required special reduced quality compression. This message is displayed for very complex pages only, such as pages containing very complex graphic images. The [SPECIAL CONTROL] selection of the Printed Image option can be used to correct the image.

**Not enough printer fonts have been loaded. Please load fonts and CONTINUE or CANCEL.**

The 4045 local printer does not have the proper fonts available.

Page nn has missing characters or image off page.  
**CONTINUE** to complete printing.

Examine the printed output. Select [CONTINUE] to finish printing the document or select [CANCEL], correct the problem, and try printing the document again.

## Printing envelopes

---

To print on xerographic envelopes, load the envelopes into the tray with the opening down and the flap to the back of the tray. Refer to the instructions on the envelope tray.

**Note:** To print on envelopes, an envelope cassette tray is necessary. Information on ordering the envelope tray and xerographic envelopes is contained in the *4045 Laser CP User Manual*.

## Adding paper while printing

---

To add paper before the paper tray is empty while a document is printing:

1. Press the off-line switch on the printer control panel. This will flash until the data currently in the printer is printed, and then will remain steadily indicating off-line.
2. Add paper, close the paper tray, and press the off-line switch to proceed.

**Note:** Removing the paper cassette tray to add paper while a document is printing can cause a paper jam.

## Copying while printing

---

If copier use is attempted during the printing of a document, there is a possibility of losing document pages, either immediately or in a recovery from a subsequent jam or other interrupt. To avoid this, use one of the following methods:

- Select the [Cancel local laser printer] command in the herald menu. While this message is waiting for confirmation, wait until the printer stops printing the document, then use the copier. When the last copy is done, select [NO] for the cancellation confirmation and the printing will continue.
- Press off-line on the printer control panel, wait until the attention window is displayed, press off-line again (placing the printer online), wait until the printing ceases, and make the copies. After copying, select [DONE] in the attention window.
- Select [SUSPEND] in the printer window to suspend the print queue. This will suspend printing indefinitely at the end of the current document. Use the copier.



The information in this chapter can help you diagnose and resolve problems that might occasionally occur. The following topics are described:

- Troubleshooting guidelines
- Local laser printer self-test
- Online diagnostics
- Error log window
- Correcting image problems

**Note:** For information on clearing paper misfeeds, responding to status codes, and cleaning the Laser CP, refer to the *4045 Laser CP User Manual*.

---

## Troubleshooting guidelines

---

If printing problems occur while you are using the Laser CP, try to determine where the problem lies in order to contact the appropriate technical representative:

1. Print a test document using the procedure "Printing a test document."

If the print quality is poor, check the Laser CP control panel. If the Dry Imager indicator is on, add dry imager. To add dry imager, refer to the quick reference pull-out cards on the Laser CP. If the dry imager indicator is not on and the print quality is poor, the printer may need adjustment. Contact the Laser CP service representative.

If the print quality is good, all hardware components are functioning properly. Ensure that the VP Local Laser Printing software has been loaded, enabled, and is running.

If the Laser CP fails to print, proceed to the next step.

2. Perform the Laser CP self-test using the procedure "Local laser printer self-test."

If the self test completes successfully, the READY indicator lights and a configuration sheet is delivered to the output tray. Proceed to step 3.

If this test fails (indicated by a numeric code displayed on the Laser CP control panel), the Laser CP needs repair. Record the status code and contact the Laser CP service representative.



3. Test the local printer option using the procedure "Testing the local printer option."

If the test completes successfully, check the cable connections at the Laser CP and the 6085 processor. Try printing the test document again. If the test document prints, proceed with normal operation. If the test document does not print, contact the 6085 service representative.

If the test fails, contact the 6085 service representative.

**Note:** The tab titled "6085 Online Diagnostics" in the VP Series reference library describes the procedures for performing online diagnostics.

---

## Local laser printer self-test

---

When powered on or reset, the Laser CP performs a series of diagnostic tests that check the printer:

- All the indicators and the display lamps light briefly and then turn off, except for the Offline and Please Wait indicators. These indicators stay on throughout the remainder of the test cycle.
- The LED display indicates the diagnostic tests being performed (d9, d8).
- At the end of the diagnostic tests, the display and Please Wait indicator are turned off and the Ready indicator is turned on.
- The testing cycle lasts approximately 5 seconds.

To perform the local laser printer self-test, reset the Laser CP (while holding down Reset, press Offline) or switch the Laser CP power off then on again. If the test completes successfully, the READY indicator lights and a configuration sheet is printed.

If this test fails, a status code is displayed on the Laser CP control panel LED. Record the status code and contact the Laser CP service representative.

---

## Online diagnostics

---

The 6085 online diagnostics, available in the desktop auxiliary menu, can help locate the source of the problem as being the printer or the laser printing option board. The online diagnostics consist of the following:

- Testing the laser print option
- Printing a test document

The first tests hardware capability without printing, and the second prints a test document.

---

## Testing the local printer option

---

The local printer option (LPO) portion of the online diagnostics consists of the following tests, in order:

- Option available test
- Interrupt tests
- DMA tests
- Internal loopback test
- Printer ready test

The option-available test checks that the 6085 workstation has been configured for the LPO and that the LPO board is installed.

The interrupt tests are run to assure proper operation of the IOP (Input/Output Processor) interrupt extension, DMA (Direct Memory Access) interrupt logic, and printer fault LPO interrupts.

The DMA (Direct Memory Access) tests are run to assure proper operation of the DMA channel, both in byte transfer and word transfer modes.

The internal loopback test places the LPO in maintenance mode (internal loopback). Various patterns are transmitted and tested in the loopback. If any test fails, an error message is displayed. Failure of this test could be caused by any of the following: data received does not match data transmitted, an interrupt did not occur, or an unexpected interrupt occurred.

The printer ready test checks the connection between the 6085 processor and the printer. This test requests the printer status. Successful completion indicates the printer is properly connected.

To test the local laser print option:

1. Select [Test] in the desktop auxiliary menu (Figure 5-1). The Online Diagnostics menu is displayed.

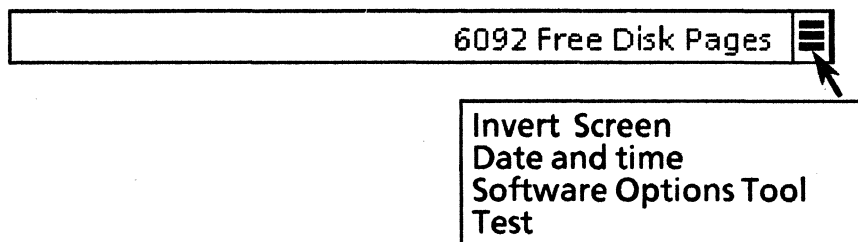

Figure 5-1 Desktop auxiliary menu

2. Select 4045 Online Diagnostics from the list of test items displayed (Figure 5-2).



Figure 5-2 4045 Online diagnostics menu selection

3. Select [Test Local Laser Printer Option] in the 4045 Online Diagnostics window (Figure 5-3).

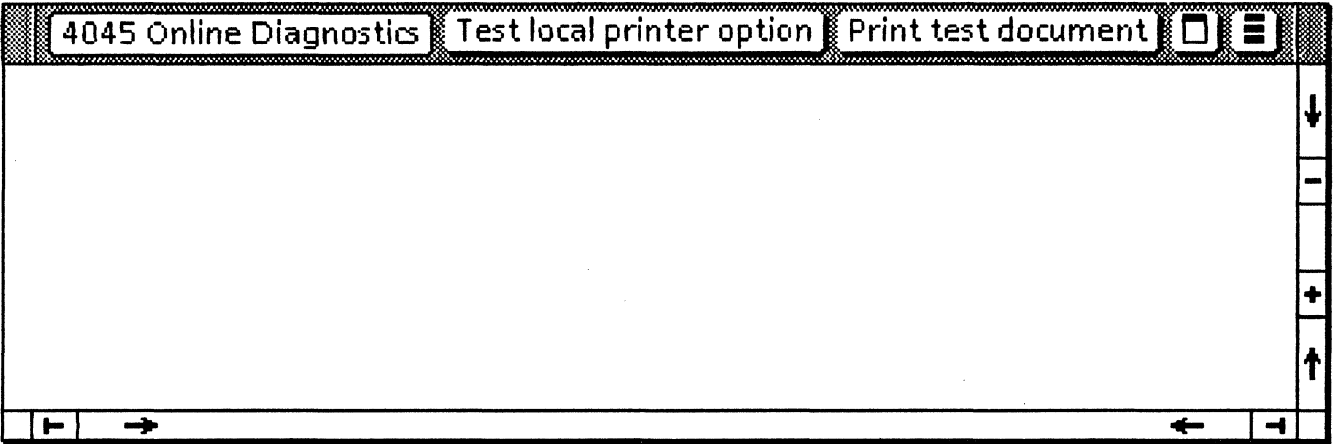

Figure 5-3 4045 Online diagnostics window

The following message is displayed upon successful completion:

**Local printer option diagnostic test passed.**

Failure of any test terminates the test sequence and displays one of the following error messages:

**Local printer option is not configured.**

**Local printer option hardware is not installed.**

**Local printer option is not installed and not configured.**

Ensure that the hardware has been installed and configured. The procedure "Configuring the hardware" describes the procedure for configuring the hardware.

**Local printer option diagnostic test fails intermittently.**

**Local printer option diagnostic test fails for all patterns.**

Contact your 6085 service representative.

---

## Printing a test document

---

This online diagnostics selection sends a test document to the printer.

To print a test document:

1. Select [Test] in the desktop auxiliary menu (Figure 5-4). The online diagnostics menu is displayed.

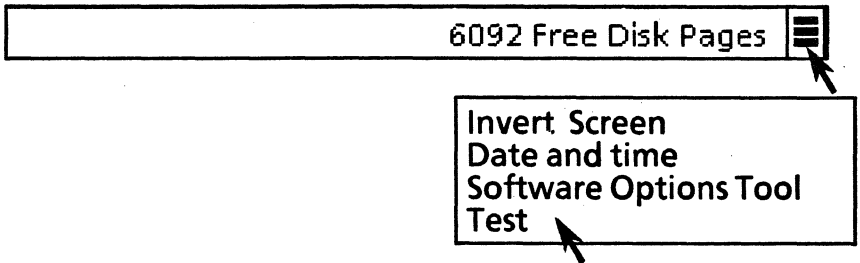

Figure 5-4 Desktop auxiliary menu

2. Select 4045 Online Diagnostics from the list of test items displayed (Figure 5-5).



Figure 5-5 Online diagnostics menu selection

3. Select [Print Test Document] in the 4045 Online Diagnostics window (Figure 5-6). The test document (Figure 5-7) should print.

If this test fails, check the interface cable connection between the 6085 processor and the printer. If the test document still does not print, contact the Laser CP service representative.

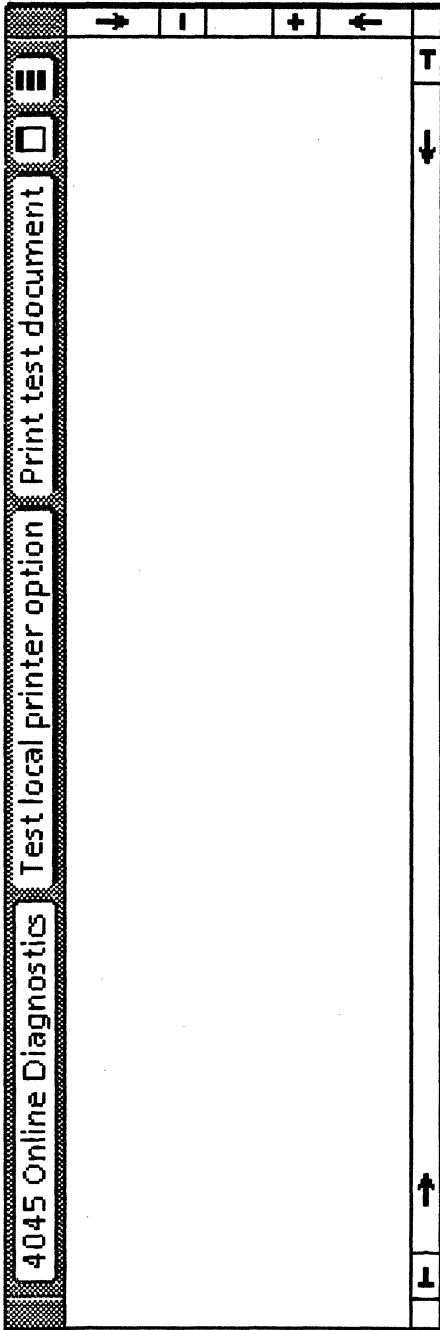

Figure 5-6 4045 Online diagnostics window



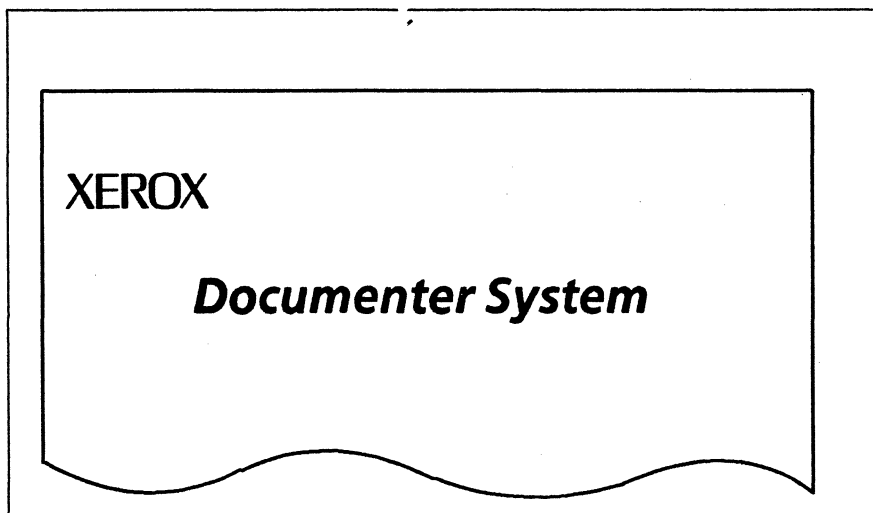

Figure 5-7 Test document

---

## Error log window

---

The [Create Status Sheet] option on the printing property sheet enables the creation of status sheets for each document printed with errors on the local laser printer. The status sheet lists the page number and type of error (both serious and minor) for each page in the document which had any kind of error in decomposition or compression for printing. The status sheets are filed in a folder which is placed on the desktop and is titled "VP Local 4045 Error Log" (Figure 5-8).

Note: Status sheets are only created for documents printed with errors.

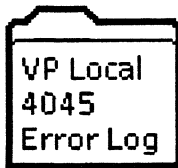

Figure 5-8 Error log folder

To examine errors:

1. Select the Error log folder and press <OPEN>. The error log is displayed (Figure 5-9). Select the document in the error log window and press <OPEN>. Note the description of the error.
2. Check the printed output of the document listed in the log.
3. Proceed to the section titled "Correcting image problems" for suggestions on improving the image quality.

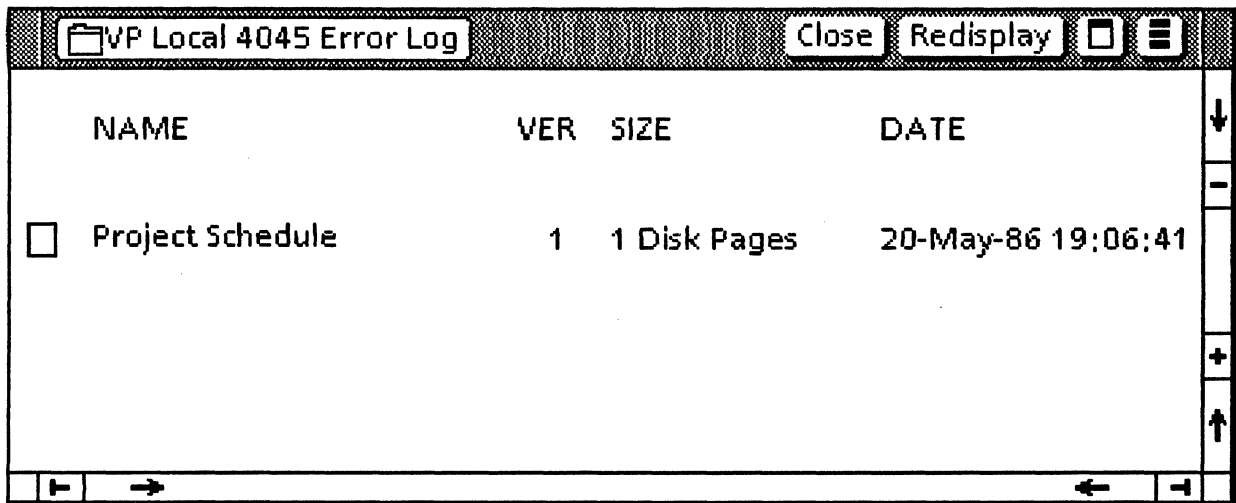

Figure 5-9 Error log window

## Correcting image problems

In rare cases, a printed page may show either tiny flaws in text character shapes or an image interrupted by white bands across the page. If the [CREATE STATUS SHEET] option is selected on the printing property sheet, status sheets are created for each document printed with errors. The status sheets are filed in a folder which is placed on the desktop and is titled "VP Local 4045 Error Log".

Image problems can be corrected with the [SPECIAL CONTROL] selection on the printing property sheet. Selecting [SPECIAL CONTROL] displays the settings illustrated in Figure 5-10.



Figure 5-10 Special control settings

To correct image problems:

1. Examine the error log and the printed output. The section titled "Error log window" contains information on the error log. Note the page(s) with errors and the type of errors (text flaws or image gaps).

**Note:** Image gaps (white bands) are not reported in the error log and can only be detected by examining the printed output.

2. Select one of the following special control settings according to the type of error:

AVOID TINY FLAWS

If the page contains flaws (reported as lessened image quality in status sheets), select [AVOID TINY FLAWS].

AVOID WHITE BANDS

If the page contains image gaps, select [AVOID WHITE BANDS].

3. Try printing the page(s) again. Check the printed output. If the image problem is corrected and you are satisfied with the print quality, continue with normal printing. If you would like to try and fine tune the image, proceed to the next step.
4. Select an intermediate setting of the special control selection and print the page(s) again.



If the page contained text flaws (lessened image quality) and printed correctly upon selecting [AVOID TINY FLAWS], select the intermediate setting(<), and try printing the page again.



If the page contained white bands (image gaps) and printed correctly upon selecting [AVOID WHITE BANDS], select one of the intermediate settings(>> or >), and try printing the page again.



5. Check the printed output. If the image problem is corrected and you are satisfied with the print quality, continue with normal printing.

**Note:** By trying to avoid one rare problem, it is possible to increase the chances of the opposite extreme. In fact, it is possible (though very unlikely) that a single page of a document might exhibit both problems. If repeated attempts with different settings of the [Printed Image] property fail to produce a correct page, densely-packed text and complex graphics should be placed on separate pages. [Printed Image] settings can then be specified for each page in this extremely unusual case.



## A

A400	32
A409	32
A499	32
Aborted	29, 30
After printing	66

## B

Background printing	1, 5, 62
Backplane	14, 20
Booting	32, 37, 44
Byte	81

## C

C1	13, 17, 25
C2	13, 17, 25
C3	13, 17, 25
C4	13 - 17, 21, 25
C5	13 - 14, 16 - 20, 25
[CANCEL]	60, 73
Canceling	53, 57, 68 - 70, 75
Chime	6
[CLOSE]	38, 46, 49, 68
Codes	33, 77
Collated	66
Configuration	
Cartridge	11, 31
Hardware	26 - 30
Record	29 - 30
Set	28
Confirmation	75
Connectors	14 - 16, 20 - 25
Contamination	57

## C (Continued)

[CONTINUE]	73
[Create Status Sheet]	63
Cut-off	64 - 65

## D

D8	80
D9	80
Date, and time	57, 82, 85
Decomposer	56
Decomposition	63
[DELETE]	66
Densely-packed text	65
Depth	8
Deselecting	65
Diagnostics	26 - 27, 32 - 33, 79, 80 - 82, 84 - 85
Directory	38, 43, 45 - 46, 49, 52, 54
[DISPLAY OPTIONS]	66
DMA	81
[DONE]	60, 72, 75
[DON'T DELETE]	66
DPI	8, 63
Draft mode printing	5, 63
[DRAFT MODE]	63
DRAM	3

## E

Editing	43, 52, 63, 64
Enabling	1, 5, 35, 37, 44, 47
[ENVELOPES]	62
Envelopes	1, 7, 53, 62, 74
Ethernet	14 - 16, 21

## F

<F2>	27
<F5>	32
<F6>	32
<F7>	32
Features	4, 6, 10
FFDE	32
Files	40, 48
Filing	46, 49



**F (Continued)**

[FIRST PAGE]	64
Flat-head screwdriver	12
Flaws	64 - 65
Floating items auxiliary menu	61, 69, 72
Floppy disk	14 - 16, 21, 27, 30, 32, 35 - 40, 43
Folder	4, 63, 66, 88
Fonts	8 - 10, 35 - 37, 40, 43 - 44, 45, 47 - 49, 52, 63, 73
For each object	63
Format	6, 53, 56, 65 - 66, 69
Free-hand drawing	4
Fully-qualified name	45
Fuser	57

**G**

Graphics	1, 4, 8, 40, 48, 64 - 65, 73
Gsm	7
Guidelines	78

**H**

Hardware	3, 10 - 11, 25 - 26, 29 - 30, 32, 56, 64, 78, 81, 84
Hardware installation	11 - 33
Hardware options	64
Height	7
Helvetica	8
Herald	56, 75
[HIGH]	62

**I**

Icon label	61
Imager	78
Indicator	78, 80
Installing	10 - 12, 22, 26, 31 - 32, 35, 37 - 38, 40, 44 - 45, 48
Interface	3, 12, 22 - 25, 72, 85
Interpress	4, 6, 53, 56, 61
Introduction	1
Invert	57, 82, 85
Inverter	64
IOP	81
Italic	9

<b>L</b>	
[LAST PAGE]	64
Latches	24
[LEGAL]	61
[LETTER]	61
Licensing	8
Loader	3, 38 - 40, 43, 46 - 49, 52
Local laser printing property/option sheets	58 - 66
Local printer attention window	71 - 73
Local printer window	67 - 70
Logoff	69
Logon	45
Loopback	33, 81 - 82
[LOW]	62
LPO	3, 11 - 12, 14, 16, 18 - 20, 22, 28, 33, 81 - 82

<b>M</b>	
Mailnotes	4
Misfeeds	77
Modem	45, 48
Modern fonts	40
MP	32 - 33

<b>N</b>	
NetCom	3
Networked	35
Newvec	8, 40, 48
Nominal	1
[NORMAL]	65
Number of copies	61

<b>O</b>	
Offline	26 - 27, 31 - 32, 74 - 75, 80
On the first error	63
Online	75, 79, 81 - 82, 85
[OPTIONS]	60, 66
Ordering	74
Output	63
Override	60

- P**
- Paper 1, 6 - 7, 53, 61 - 62, 64, 73 - 74, 77
  - Paper tray with 61
  - Password 45
  - PC Emulation 2, 4, 6, 8, 12, 16, 35, 53
  - PCO 16, 18 - 20
  - Physical characteristics 7
  - Powered-on 26
  - Prerequisite 3
  - Print 66
  - Print order 64
  - Printed image 64
  - Printer priority 62
  - Printing a document 55 - 57
  - Printwheel 8
  - Priority 5, 62
  - <PROP'S> 60
  - Pull-out 73, 78
- Q**
- Queue 68, 69 - 70, 75
- R**
- Reconfigured 29 - 30
  - Reconnect 15, 21
  - Recovery 75
  - [REDISPLAY] 68
  - RemoteCom 3
  - [RESET] 27, 30, 32
  - Resolution 1, 6, 63
- S**
- Screwdriver 12, 18 - 19
  - Seating 15, 21
  - Self-test 31, 78, 80
  - Sequencer 3, 6, 64
  - Server 46, 49
  - Small-blade screwdriver 12
  - Software installation 35 - 52
  - Spacer 19
  - [SPECIAL CONTROL] 65
  - Specifications 6, 10
  - Spreadsheets 4

**S (Continued)**

StandAlone	3
[START]	55, 60
[Stop for Inspection]	63
[SUSPEND]	68, 75

**T**

Throughput	5
Thumbscrews	20
Time, and date	57, 82, 85
Toner	57
Transparencies	1, 7
Troubleshooting	78
Two-sided	57
Typed	30

**U**

Unpacking	11, 18, 22
-----------	------------

**V**

[VERY LOW]	62
VM	28

**W**

Weight	7
When printing	66
Width	7
Window management auxiliary menu	61, 68, 72