

**XEROX**

*Network Administration Library*

---

---

*Changes are periodically made to this document. Changes, technical inaccuracies, and typographic errors will be corrected in subsequent editions.*

*The content of this booklet is based on the Services 10.0 Release.*

*A Customer Comment Form is provided in this Network Administration Library. If this form has been removed, address comments to:*

Xerox Corporation  
Attn: Product Education (N1-12)  
701 Aviation Blvd.  
El Segundo, California 90245

*Warning: As to equipment manufactured prior to October 1, 1983, such equipment generates, uses, and can radiate radio frequency energy and, if not installed and used in accordance with the instructions manual, may cause interference to radio communications. As permitted by regulation, it had not been tested for compliance with the limits for Class A compliance with the limits for Class A computing devices pursuant to Subpart J of part 15 of FCC rules, which are designed to provide reasonable protection against such interference. Operation of this equipment in a residential area is likely to cause interference, in which case the user, at his own expense, will be required to take whatever measures may be required to correct the interference.*

*As to equipment manufactured after October 1, 1983, such equipment complies with the requirements in Part 15 of FCC Rules for Class A computing devices. Such equipment generates, uses, and can radiate radio frequency energy and, if not installed and used in accordance with the instruction manual, may cause interference to radio communications. It has been tested and found to comply with the limits for a Class A computing device pursuant to Subpart J of Part 15 of FCC Rules, which are designed to provide reasonable protection against such interference when operated in a commercial environment. Operation of this equipment in a residential area is likely to cause interference, in which case the user, at his own expense, will be required to take whatever measures may be required to correct the interference.*

© 1986 by Xerox Corporation. All rights reserved.

Printed in the United States of America. Publication number: 610E02810  
Xerox®, 6085, 8000, 8010, 8700, 9700, 495-1, 295, 7000, Model-35, XP-9, and ViewPoint are trademarks of Xerox Corporation.

IBM® and 3270, 3276, 4341, and 6670 are trademarks of IBM Corporation.

Copyright protection claimed includes all forms and matters of copyrightable material and information now allowed by statutory or judicial law or hereinafter granted, including without limitation, material generated from the software programs which are displayed on the screen such as icons, screen displays looks, etc

---

**Purpose** The Print Service booklet describes all you need to know to set up and maintain your Print Service. This booklet explains all the service commands and shows how these commands are used to perform service-related tasks. In addition, this booklet lists all the messages that can be generated while running this service and tells you what to do when a message is displayed.

**Intended audience** This publication is intended for System Administrators who are responsible for starting up and keeping the Print Service running efficiently.

**Before you read this booklet** There is some general information about services that you will need to be familiar with before you can understand this booklet. Read the “Services Executive” section in the *Server Operation and Maintenance* booklet and the *Introduction to Network Administration* booklet. All of these publications can be found in the *Network Basic Services* volume.

**Before you can use this service** As part of the preparation for setting up the Print Service, you need to perform the procedures described in the *Server Software Installation* booklet. This booklet is also part of the *Network Basic Services* volume.

*(This page intentionally blank)*

# Table of contents

---

<b>1. Introduction</b>	<b>1</b>
Overview of Print Service	1
<b>2. Commands</b>	<b>9</b>
<b>3. Setting up your Print Service</b>	<b>15</b>
Initializing your Print Service	16
Loading fonts onto your Print Service	23
Loading extended language fonts onto your Print Service	27
Establishing standard operation of your Print Service	28
<b>4. Maintaining your Print Service</b>	<b>37</b>
Print Service maintenance	38
8040 Series Electronic Printer maintenance	41
NS 8000 Laser CP Electronic Printer maintenance	58
Telecopier 495-1 Printer maintenance	69
Formatting Print Service maintenance	78
Image gap reprinting	81
<b>5. Messages</b>	<b>85</b>
Generic status messages	86
8040 Series Electronic Printer status messages	88
NS 8000 Laser CP Electronic Printer status messages	90
Telecopier 495-1 printer status messages	94
Formatting Print Service status messages	96
Document status messages	99
Job termination summary messages	103
Document identification banner messages	107
Document appearance warning banner messages	108
Document error banner messages	110
<b>Glossary</b>	<b>113</b>
<b>Index</b>	<b>INDEX-1</b>

*(This page intentionally blank)*

<b>1</b>	<b>Xerox Printing Systems</b>	<b>2</b>
<b>2</b>	<b>8040 Series Electronic Printer, server, and workstations on an Ethernet network</b>	<b>3</b>
<b>3</b>	<b>NS 8000 Laser CP Electronic Printer, server, and workstations on an Ethernet network</b>	<b>4</b>
<b>4</b>	<b>Telecopier 495-1 Facsimile Device, server, and workstations on an Ethernet network</b>	<b>5</b>
<b>5</b>	<b>9700 Electronic Printing System, server, and workstation on an Ethernet network</b>	<b>7</b>
<b>6</b>	<b>RS-232C interface setup card parameters</b>	<b>34</b>
<b>7</b>	<b>NS 8000 Laser CP Electronic Printer</b>	<b>59</b>
<b>8</b>	<b>NS 8000 Laser CP maintenance panel</b>	<b>60</b>

*(This page intentionally blank)*



---

**Overview of Print Service**

---

The Print Service operates on an 8000 Series server. If the Print Service is configured to support an attached printing device, the necessary printer hardware must be connected to the 8000 Series server. The Print Service enables network users to obtain paper versions of what they create on their workstations. A Print Service can be configured to support one of the following printing options:

**Attached Printing Devices** (five options are currently supported):

- 8040 Series Electronic Printer - Produces quick turnaround printing. Includes the capability for printing a variety of font styles and graphic illustrations.
- NS 8000 Laser CP Electronic Printer - A desktop electronic printer for quick turnaround printing. Includes the capability for printing a variety of font styles and graphic illustrations. Optionally, the printer can include a CVT copier to provide convenience copying ability.
- Telecopier 495-1 - Referred to as a facsimile (FAX) device, for transmitting a variety of font styles and graphic illustrations to remote facsimile devices through telephone lines, as well as printing locally.
- Fuji Xerox Model-35 Electronic Printer
- Fuji Xerox XP-9 Electronic Printer

**Note:** The Model-35 and XP-9 Electronic Printers are not available in the United States; therefore, instructions are not provided for these printing options.

**Formatting Print Service:**

- Only one Formatting Print Service (FPS) is supported at this time. FPS enables 6085/8010 ViewPoint documents with complex graphics to be printed on the 9700/8700 Electronic Printing Systems.

Each of these printing options is described on the following pages.

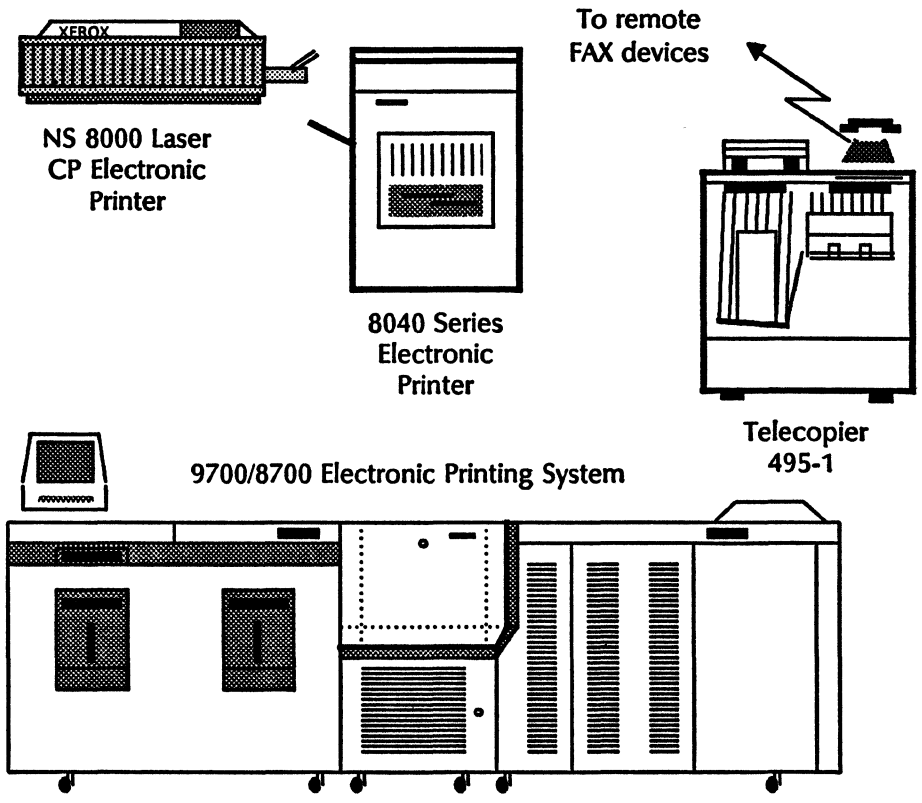

**Figure 1. Xerox Printing Systems**

## 8040 Series Electronic Printer

The 8040 Series Electronic Printer produces quick turnaround printing. The 8040 can print a variety of font styles and graphic illustrations.

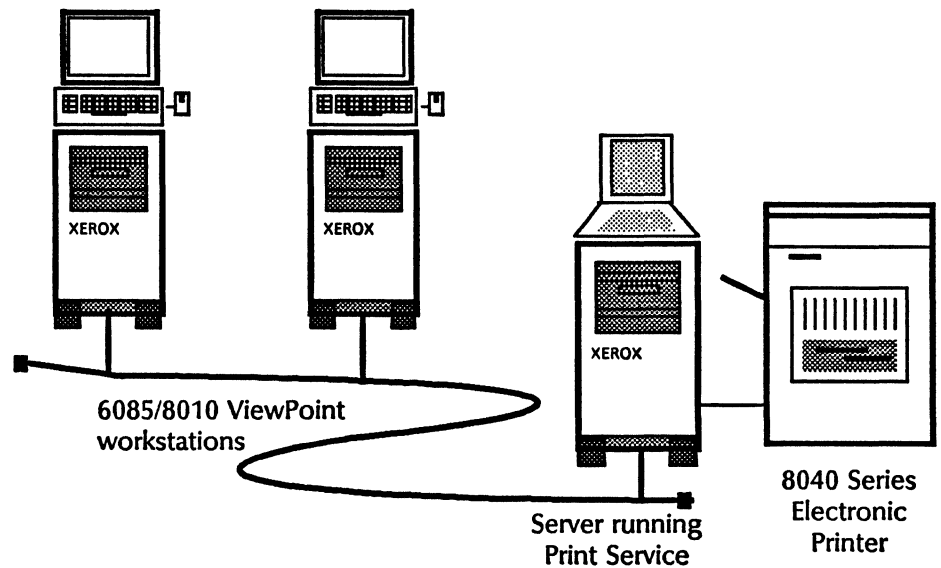

**Figure 2. 8040 Series Electronic Printer, server, and workstations on an Ethernet network**

## NS 8000 Laser CP Electronic Printer

The NS 8000 Laser CP Electronic Printer is a desktop electronic printer designed for quick turnaround printing. The NS 8000 Laser CP Electronic Printer can print a variety of font styles and graphic illustrations. Optionally, the printer can provide copying ability.

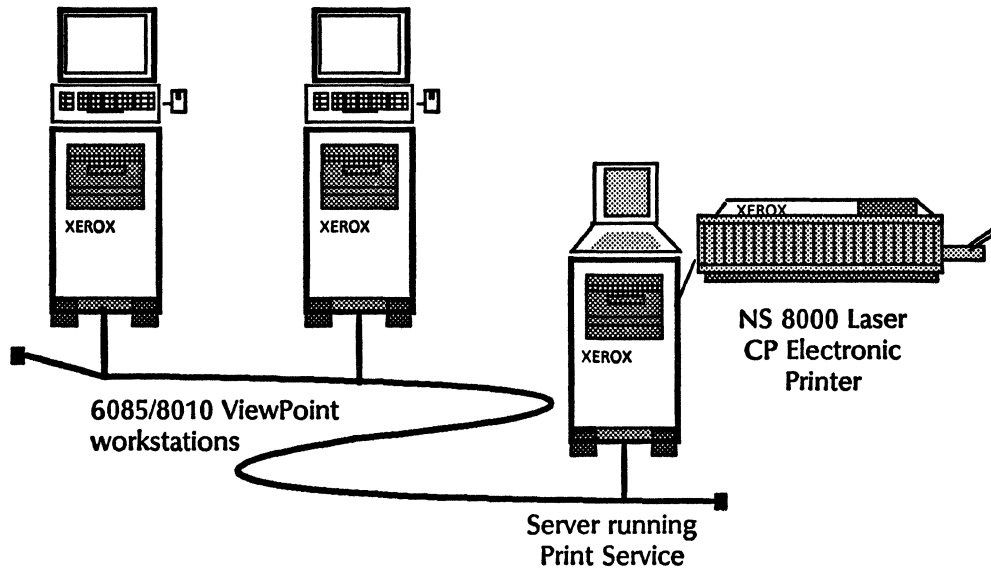

**Figure 3. NS 8000 Laser CP Electronic Printer, server, and workstations on an Ethernet network**

## Telecopier 495-1 facsimile device

The Telecopier 495-1 is a facsimile (FAX) device for printing a variety of font styles and graphic illustrations directly to any group 1, 2, or 3 compatible remote FAX devices through telephone lines. Each document output can be transmitted to as many as ten remote facsimile devices via telephone communications. Documents can also be printed locally.

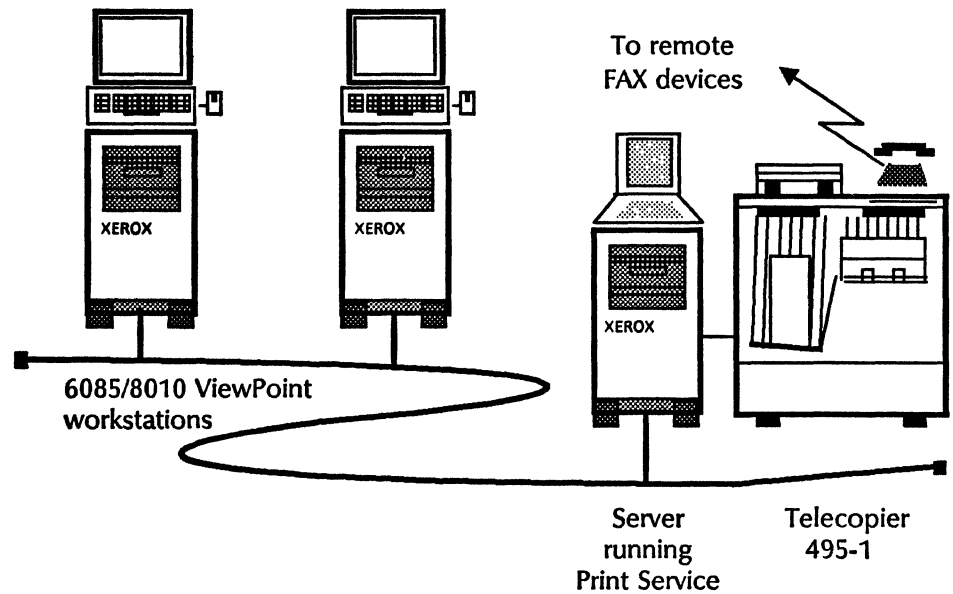

**Figure 4. Telecopier 495-1 Facsimile Device, server, and workstations on an Ethernet network**

## Formatting Print Service

---

The Formatting Print Service (FPS) enables documents with complex graphics (including non-vertical, non-horizontal, and curved lines, shapes, and shadings) from the 6085/8010 ViewPoint workstations to be printed on 9700/8700 Electronic Printing Systems. The FPS forwards documents to a 9700/8700 Electronic Printing System, which is called the Target Print Service.

When a document processed by a Formatting Print Service is printed, all text within text frames will be printed, even text within frames which have been overlaid, regardless of the document's appearance at the workstation. The information specifying which text frame is on top is lost when the document is processed by the FPS. To correct this problem, you must remove the underlying text frames before sending the document to the FPS.

The FPS converts Interpress masters (containing text and graphics) from 6085/8010 ViewPoint workstations into interleaved Interpress masters. Graphics in the original Interpress masters are converted by the FPS into compressed graphic images. One compressed graphic image is produced for each page containing graphics. The FPS then forwards the interleaved Interpress masters to the Target Print Service.

Interpress masters created by an 860 or 820-II should not be sent to the Formatting Print Service for printing at a 9700/8700 Electronic Print Service. The FPS does not currently support Interpress masters generated by 860's with sequence insert file references. If such Interpress masters are sent to the FPS, the corresponding job will be aborted and a job termination summary will be printed.

**Note:** The 9700/8700 Electronic Printing Systems can print documents containing vertical and horizontal line graphics without the use of the FPS.

To process compressed graphic images, the 9700/8700 Electronic Printing System is configured with the Graphics Handling Option (GHO). The GHO has restrictions on the size and the complexity of compressed graphic images. These restrictions affect the printability of a document or the throughput at which a document is printed. The GHO also limits the number of graphic images per page. Each compressed graphic image produced by the Formatting Print Service and each image (IMG) file reference is processed as one graphic image. The *Xerox 9700/8700 Electronic Printing System Reference Manual* describes GHO restrictions.

For information on installing and initializing 9700/8700 Electronic Printing Systems, see the *Electronic Print Service Resources* booklet.

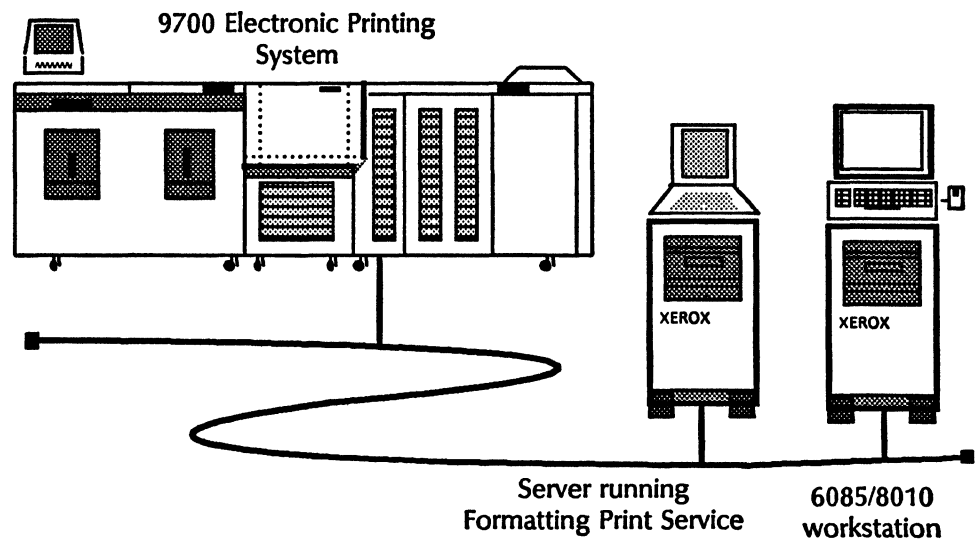

**Figure 5. 9700 Electronic Printing System, server, and workstation on an Ethernet network**

*(This page intentionally blank)*



This chapter lists the Print Service commands you use to set up and maintain your Print Service. The commands are listed in alphabetical order, followed by a brief explanation. To address the Print Service commands, you must be in the Print Service context. The commands are available only when the Print Service is started, unless otherwise noted.

**Cancel Document** Available to the enabled user. Cancels the printing of documents by the Print Service. The documents canceled by this command are listed as the command is executed. The canceled document files are deleted. The operator is given a choice of canceling one of the following:

- The document currently being formatted
- The document currently being printed or forwarded
- All documents being processed: documents being formatted, documents already formatted, and documents being printed or forwarded
- Queued documents: documents awaiting processing
- All documents

**Delete Font** Available to the enabled user. Printing must be stopped to use this command. This command can be used to remove unused fonts in order to increase document queue space.

**Delete Test Pattern** Available to the enabled user. Deletes selected test patterns. This command can be used to remove unused test patterns in order to increase document queue space.

**Install From Floppy** Available to the enabled user. Printing must be stopped to use this command for installing files (fonts and/or test patterns) from a floppy disk. This command is used when initializing the Print Service and whenever new fonts are released or purchased.

**List Documents** Available to any user whether the Print Service is started or stopped. Lists the sender, name, and status of documents received by the Print Service. Typically, documents listed by the Print Service are in one of the following states: queued and awaiting formatting, being formatted, formatted and awaiting printing or forwarding, being printed or forwarded, or completed.

This command can be used to see if a document has been recently received, along with its current position in the queue. Documents are listed in newest to oldest order.

<b>List Fonts</b>	Available to any user when the Print Service is started. Displays the name, file size, and version (date) of all installed fonts. You use this command to see which fonts have been installed.
<b>List Test Patterns</b>	Available to any user when the Print Service is started. Displays the name, file size, and version (date) of all the installed test patterns.
<b>Print Test Pattern</b>	<p>Available to any user. You can print a test pattern any time to test the Print Service. The command provides a choice of test patterns.</p> <p>You are prompted to enter the number of copies to be printed. You can print a test pattern even when printing and/or queuing are stopped. More complete testing can be done by running the diagnostic tests. For information on running diagnostic tests, see the <i>Basic Troubleshooting of Network Services</i> booklet.</p>
<b>Query Target Print Service</b>	<p>Available to any user for the Formatting Print Service option. You can use this command to check the current status of the Target Print Service and obtain the current paper handling parameters.</p> <p>The FPS automatically calls the Target Print Service to update the current paper handling parameters when the Target Print Service is set using the Set Target Print Service command and when the FPS server is rebooted. Paper handling parameters include paper size, stapling, and two-sided copying attributes.</p> <p><b>Note:</b> The FPS paper handling parameters must match the Target Print Service paper handling parameters. If the parameters do not match, print requests may be rejected. Use the <b>Show Status</b> command to display the FPS paper handling parameters without making a call to the Target Print Service. Use the <b>Query Target Print Service</b> command to ensure that the FPS paper handling parameters match the Target Print Service parameters.</p>
<b>Rename Print Service</b>	Available to the enabled user only when the Print Service is stopped (using the <b>Stop Service</b> command). Allows you to rename the Print Service. The current name is deleted at the Clearinghouse Service and the new name is added.
<b>Reset Statistics</b>	Available to the enabled user. Resets to zero all counters that accumulate service statistics. The service statistics are the counts displayed by the <b>Show Status</b> command when an enabled user is logged on (such as number of documents printed).
<b>Set Banner</b>	<p>Available to the enabled user for the NS 8000 Laser CP Electronic Printer option of the Print Service. You can use this command to change the banner page option. Choices include:</p> <ul style="list-style-type: none"> <li>• For every copy of a document</li> <li>• For every set of copies of a document (for every print request or every job)</li> <li>• Suppressed (no banner)</li> </ul>

- Set Parameters** Available to the enabled user for the 8040 Series Electronic Printer and the Telecopier 495-1 printing options. Redisplays the selection menu until you type the number corresponding to "Exit" or press <CTRL> and <C>. For the Print Service supporting the 8040 and the Telecopier 495-1, each parameter is set to a default value when the Print Service is first installed or the printing option is changed. This command allows the System Administrator to modify the parameters, if necessary, for the particular installation.
- For the Print Service supporting the 8040 Series Electronic Printer, this sets the paper handling parameters. Five paper handling options are available: paper size, feed, banner, stacking, and registration.
  - For the Print Service supporting the Telecopier 495-1, this sets the paper handling and transmission parameters. Three options are available: transmission retries, banner, and multiple copies.
- Set Target Print Service** Available to the enabled user for the FPS option of the Print Service. Documents sent to the FPS are formatted and forwarded to the Target Print Service. You use this command to specify a 9700/8700 Electronic Printing System to be the Target Print Service. The Target Print Service can be specified by Clearinghouse Service name or by network address. When specifying a Target Print Service by Clearinghouse Service name, the domain and organization of the FPS are used unless you enter a domain and organization. A network address can be entered in decimal, octal, or hexadecimal format. This command can be used at any time to change the Target Print Service.
- Show Status** Available to any user when the Print Service is started or stopped. Displays current operational status, configuration, and statistics. Additional status information is displayed if the user is enabled.
- Shutdown Printer** Available to the enabled user for the 8040 Series Electronic Printer option of the Print Service. The command is available when a B2 printer is attached, when the printer is in full power mode, and when there is no job being processed. The command is not available if the Print Service is in an L4 status condition.
- Start** Available to the logged on user when printing and queuing are both stopped. Allows both printing and queuing of documents by the Print Service. This command serves the same function as the **Start Queuing** and **Start Printing** commands. Refer to these command descriptions for more specific information.

**Start Diagnostic** Available to any user for the 8040 Series Electronic Printer, the NS 8000 Laser CP Electronic Printer, or the Telecopier 495-1 option of the Print Service. This command starts the diagnostic program that tests the interface between the server and the printer. Normal functions (queuing, printing, etc.) are preempted while running the diagnostic program. This command is used by the System Administrator or the Technical Representative to further diagnose error codes.

The **Start Diagnostic** command is explained in greater detail in the "Maintaining your Print Service" section.

**Note:** The **Start Diagnostic** command must not be invoked when the Xerox Printer Representative has placed the printer in Diagnostic Mode (8040 and NS 8000).

**Start Printing** Available to the logged-on user when printing is stopped. Allows the Print Service to print documents in the document queue. Printing is automatically stopped at system installation and should normally be restarted after installation of fonts. When the Print Service is started, printing starts automatically if there are documents in the queue. This command displays the name of the user who stopped printing and the reason printing was stopped, if known. It requires a confirmation. The name of the user who starts printing is included in the **Show Status** command display.

**Start Queuing** Available to the logged-on user when queuing is stopped. Allows the Print Service to queue documents from the Ethernet network (if any are sent). Queuing is started automatically at system installation. This command displays the name of the user who stopped queuing and the reason queuing was stopped, if known. It requires a confirmation. The name of the user who starts queuing is included in the **Show Status** command display.

**Stop** Available to the enabled user when printing and queuing are both started. Stops printing and queuing by the Print Service. This command serves the same function as the **Stop Queuing** and **Stop Printing** commands. Refer to these command descriptions for more specific information.

**Stop Printing** Available to the enabled user when printing is started. Stops printing by the Print Service. This command causes documents currently in progress to be requeued for retry when printing is restarted. The stopped state is retained across system restarts. Test pattern commands are not affected if printing is stopped. A "reason" prompt allows the user to enter a short explanation of why printing was stopped, but pressing <RETURN> is all that is required. The user's name and reason (if furnished) are shown by the **Start Printing** and **Show Status** command displays.

**Stop Queuing** Available to the enabled user when queuing is started. Stops queuing of documents from the Ethernet network by the Print Service. The stopped state is retained across system restarts. A "reason" prompt allows the user to enter a short explanation of why queuing was stopped, but pressing <RETURN> is all that is required. The user's name and reason (if furnished) are shown by the **Start Queuing** and **Show Status** command displays.

**Wakeup Printer**

Available to the enabled user for the 8040 Electronic Printer option of the Print Service. This command applies only to B2 printers. It is available when a B2 printer is in low power mode. A B2 printer in low power mode is restarted automatically when a print job is initiated. A B2 printer requires about 6 minutes to warm up before becoming operational, during which time an L1 status is displayed.

*(This page intentionally blank)*

## **3. Setting up your Print Service**

This section contains procedures for initializing the Print Service. The steps for initializing include loading the basic fonts and setting the operational parameters appropriate for the selected printing option.

The following procedures described in this section should be performed to set up the Print Service:

- Initializing your Print Service
- Loading fonts onto your Print Service
- Loading extended language fonts onto your Print Service
- Establishing standard operation of your Print Service

---

## Initializing your Print Service

---

You must install the server software before you can initialize the Print Service. For information on server software installation, see the *Server Software Installation* booklet. The first time the Print Service runs, you are prompted to choose which printing option you wish the Print Service to support. The printing options are:

- 8040 Series Electronic Printer
- NS 8000 Laser CP Electronic Printer
- Telecopier 495-1 Printer
- Formatting Print Service (FPS)

Procedures for initializing the Print Service are described in the following sections. Refer to the appropriate procedure for the printing option being initialized.

---

### Initializing the 8040 Series Electronic Printer

---

1. Install and run the Print Service according to the directions in the *Server Software Installation* booklet.
2. When you are prompted to specify the printing option, type the number corresponding to the 8040 Series Electronic Printer and press <RETURN>.
3. Type the number corresponding to the printer version and press <RETURN>. The 8040 Series Electronic Printers come in two versions, Build 1 (B1) or Build 2 (B2).
  - The B1 version has an output tray that holds 250 sheets. It delivers printed sheets face up.
  - The B2 version has a distinctive drum-shaped output stacker and a tray that holds 500 sheets. It delivers printed sheets face down. B2 printers can also offset stack the printed sheets.
4. When you are prompted, type the fully-qualified name for the Print Service and press <RETURN>. The name must be different from other Print Services and all other names in the domain. Refer to the *Introduction to Network Administration* booklet for a description of Clearinghouse naming conventions, and Form SSI 1, Directory of Services on a Specific Server, in the *Server Software Installation* booklet for a description of the service name.



5. Type a description at the "Enter service description" prompt and press <RETURN>.
6. Type Y to the confirmation prompt and press <RETURN>. The Print Service registers itself with the Clearinghouse Service, completes the initialization process, and displays a prompt for entering commands.
7. To install fonts, use the "Loading fonts onto your Print Service" procedure.

Example of the dialogue for initializing the 8040 Series Electronic Printer:

```

Running Print Service
Specify printing option
1 8040 Series Electronic Printer
2 NS 8000 Laser CP Electronic Printer
3 Model-35 Electronic Printer
4 XP-9 Electronic Printer
5 Telecopier 495-1
6 Formatting Print Service
Enter choice number: 1RETURN
Specify printer version:
1 B1
2 B2
Enter choice number: 2RETURN
Service name and description unknown
Enter service name: Daily:Chicago:GemSysCoRETURN
Enter service description: Located on second floor of Building
33RETURN
Confirm (Y/N): YRETURN
Validating Clearinghouse entry for: Daily:Chicago:GemSysCo
A new Clearinghouse entry was created
Done

```

### Initializing the NS 8000 Laser CP Electronic Printer

1. Install and run the Print Service according to the directions in the *Server Software Installation* booklet.
2. When you are prompted to specify the printing option, type the number corresponding to the NS 8000 Laser CP Electronic Printer and press <RETURN>.
3. When you are prompted, type the fully-qualified name for the Print Service and press <RETURN>. The name must be different from other Print Services and all other names in the domain. Refer to the *Introduction to Network Administration* booklet for a description of Clearinghouse naming conventions, and Form SSI 1, Directory of Services on a Specific Server, from the *Server Software Installation* booklet for a description of the service name.

4. Type a description at the "Enter service description" prompt and press <RETURN>.
5. Type Y to the confirmation prompt and press <RETURN>. The Print Service registers itself with the Clearinghouse Service, completes the initialization process, and displays a prompt for entering commands.
6. To install fonts, use the "Loading fonts onto your Print Service" procedure.

Example of the dialogue for initializing the NS 8000 Laser CP Electronic Printer:

```
Running Print Service
Specify printing option
1  8040 Series Electronic Printer
2  NS 8000 Laser CP Electronic Printer
3  Model-35 Electronic Printer
4  XP-9 Electronic Printer
5  Telecopier 495-1
6  Formatting Print Service
Enter choice number: 2RETURN
Service name and description unknown
Enter service name: Daily:Chicago:GemSysCoRETURN
Enter service description: Located on second floor of Building
33RETURN
Confirm (Y/N): YRETURN
Validating Clearinghouse entry for: Daily:Chicago:GemSysCo
A new Clearinghouse entry was created
Done
```

### Initializing the Telecopier 495-1 printer

1. Install and run the Print Service according to the directions in the *Server Software Installation* booklet.
2. When you are prompted to specify the printing option, type the number corresponding to the Telecopier 495-1 device and press <RETURN>.
3. Type the number corresponding to the paper width supported and press <RETURN>.
4. Type the number corresponding to the transmission resolution supported and press <RETURN>.
  - Choose standard resolution if all other remote facsimile devices are group 1 or group 2 machines (not Telecopier 495-1s, 295s, or 7000s) or if the transmission to other Telecopier 495-1s should be handled in faster, coarser resolution mode. (Groups 1, 2, and 3 are standard terms used to describe the general capability and compatibility of a given FAX device. Group 1 is slower than group 2, which, in turn, is slower than group 3.)

- Choose fine resolution if some or all transmissions are to group 3 machines (for example, other Xerox Telecopier 495s, 295s, or 7000s) and when higher resolution is desired.
5. When you are prompted, type the fully-qualified name for the Print Service and press <RETURN>. The name must be different from other Print Services and all other names in the domain. Refer to the *Introduction to Network Administration* booklet for a description of Clearinghouse naming conventions and Form SSI 1, Directory of Services on a Specific Server, from the *Server Software Installation* booklet for a description of the service name.
  6. Type a description at the "Enter service description" prompt and press <RETURN>.
  7. Type Y to the confirmation prompt and press <RETURN>. The Print Service registers itself with the Clearinghouse Service, completes the initialization process, and displays a prompt for entering commands.
  8. To install fonts, use the "Loading fonts onto your Print Service" procedure.

Example of the dialogue for initializing the Telecopier 495-1 printer:

```
Running Print Service
Specify printing option
1 Telecopier 495-1
Enter choice number: 1RETURN
Specify 495-1 paper width supported
1 8.5 inches (216 mm)
2 210 mm (8.3 inches)
Enter choice number: 1RETURN
Specify 495-1 transmission resolution support
1 Standard
2 Fine
Enter choice number: 2RETURN
Service name and description unknown
Enter service name: Daily:Chicago:GemSysCoRETURN
Enter service description: FAX server located 2nd floor of building
3RETURN
Confirm (Y/N): YRETURN
Validating Clearinghouse entry for: Daily:Chicago:GemSysCo
A new Clearinghouse entry was created
Done
```

## Initializing the Formatting Print Service

1. Install and run the Print Service according to the directions in the *Server Software Installation* booklet.
2. When you are prompted to specify the printing option, type the number corresponding to the Formatting Print Service and press <RETURN>.
3. When you are prompted, type the fully-qualified name for the Print Service and press <RETURN>. The name must be different from other Print Services and all other names in the domain. Refer to the *Introduction to Network Administration* booklet for a description of Clearinghouse naming conventions, and Form SSI 1, Directory of Services on a Specific Server, from the *Server Software Installation* booklet for a description of the service name.
4. Type a description at the "Enter service description" prompt and press <RETURN>.
5. Type Y to the confirmation prompt and press <RETURN>. The Print Service registers itself with the Clearinghouse Service, completes the initialization process, and displays a prompt for entering commands.
6. To install fonts, use the "Loading fonts onto your Print Service" procedure.

Example of the dialogue for initializing the Formatting Print Service:

```
Running Print Service
Specify printing option
1 8040 Series Electronic Printer
2 NS 8000 Laser CP Electronic Printer
3 Model-35 Electronic Printer
4 XP-9 Electronic Printer
5 Telecopier 495-1
6 Formatting Print Service
Enter choice number: 6RETURN
Service name and description unknown
Enter service name: Daily:Chicago:GemSysCoRETURN
Enter service description: Server running Formatting Print Service
located 2nd floor of building 3RETURN
Confirm (Y/N): YRETURN
Validating Clearinghouse entry for: Daily:Chicago:GemSysCo
A new Clearinghouse entry was created
Done
```

---

## Changing the printing option

---

You may wish to configure a Print Service for a different printing option than it currently supports. (For example, you may want to attach a different kind of printer to the server.)

To change from one printing option to another, use the following procedure:

1. Reboot the server.
2. Type **N** to the "Normal startup" prompt and press <RETURN>.
3. Type the number corresponding to the "Interrupt before running services" option and press <RETURN>.
4. Log on and enable in the Print Service context.
5. Type **Run Service** and press <RETURN>. A list of services on the server is now displayed.
6. Type the number corresponding to the Print Service and press <RETURN>.
7. Type **N** to the "PS:Normal Startup?" prompt and press <RETURN>.
8. Type the number corresponding to the "Change configuration" prompt and press <RETURN>.
9. Type the number corresponding to the printing option desired and press <RETURN>.

---

## Recovery operations for unsuccessful Print Service initialization

---

The following recovery operations should be performed if the Print Service is crashing before it is successfully initialized (i.e., when the Print Service is restarted and crashes before the message "Print Service run" is displayed). The following steps are given in the recommended sequence if you should face this problem.

1. There is a new option in the Print Service's non-normal startup menu. This option is useful in an infrequently-called-for recovery operation where it is desirable to delete the Print Service's backing files before the Print Service restarts. This recovery operation should be used whenever the Print Service crashes during initialization.

The procedure is as follows:

- a. Boot the server.
- b. Type **N** to the "Normal startup" prompt and press <RETURN>.
- c. Type the number corresponding to the "Interrupt before running services" option and press <RETURN>.

- d. Log on and enable.
- e. Type **Run Service** and press <RETURN>.
- f. Type **N** to the "Normal startup?" prompt and press <RETURN>.
- g. Type the number corresponding to the "Delete backing files" prompt and press <RETURN>. See the following example:

```
PS: Normal Startup? (Y/N): NRETURN
Specify non-normal startup option
1 Change configuration
2 Stop queuing and printing
3 Delete backing files
Enter choice number: 3RETURN
Ready to delete all Print Service backing files,
including print queue data? (Y/N): YRETURN
Deleting files... done.

Specify printing option
1 8040 Series Electronic Printer
2 NS 8000 Laser CP Electronic Printer
3 Telecopier 495-1
4 Formatting Print Service
Enter choice number: 2RETURN
Print Service run.
```

- 2. If the Print Service crashes during initialization and the above recovery is attempted but the crash happens again, it is possible that there are damaged font files. The recommended recovery again involves a non-normal startup.

Follow the steps given in a-f above, then type the number corresponding to the "Stop queuing and printing" prompt and press <RETURN>. If the "Print Service run" message appears before the server crashes, the indicated recovery is to delete and reinstall fonts.

- 3. If, after deleting the reinstalling fonts, the Print Service still crashes before the "Print Service run" message is displayed, it is possible that the problem is a bad font floppy. The only recovery for this is to obtain a replacement set of font floppies.

---

## Loading fonts onto your Print Service

---

After you initialize your Print Service, you must install fonts.

The word "font" refers to the combination of a particular type style and size. The words in this paragraph, for example, are in one font; the heading above is in a different font. The process of storing fonts on a Print Service is called installing fonts.

When installing fonts, the Print Service checks to make sure that the fonts are appropriate for the printing option. The user will not be allowed to install fonts which are not appropriate.

The printer can only print those fonts that are loaded on the server. The minimum set of font files required for the Print Service to operate are found on the Xerox Required Fonts floppy disk.

**Note:** Since the Modern font file found on the Xerox Required Fonts floppy is a minimal set of character fonts, it is recommended that the Modern fonts be installed from the Xerox Modern Fonts floppies. If a requested font is not installed, the Print Service will substitute the Modern font; therefore, it is important that Modern fonts be installed.

Typically, fonts are installed at three times:

- When the Print Service is initialized for the first time
- When you buy new fonts
- When Xerox releases new versions of fonts

**Comment:** To install Extended Language fonts, refer to the "Loading extended language fonts onto your Print Service" procedure.

### Procedure

---

1. Log on and enable in the Print Service context.
2. Proceed to step 3 or 4, depending on the status of your Print Service:
  - When you are installing new fonts on an existing Print Service, continue with step 3.
  - When you are installing fonts on a new Print Service, you will see the message "Check that fonts have been installed" in the status display. Continue with step 4.
3. Type **Stop Printing** and press <RETURN>. Enter the reason for stopping printing (optional) and press <RETURN>.
4. Insert the floppy disk titled "Xerox Required Fonts," type **Install From Floppy**, and press <RETURN>. This disk contains both the required fonts and test patterns.

**Note:** As you install files from the floppy disks, several words appear in the dialogue. Their meanings are as follows:

- **New** - Indicates that the file does not exist on the server.
- **Same Version** - Indicates that the file on the floppy disk has the same creation date as the named file on the server.
- **Newer** - Indicates that the file on the floppy disk has a newer creation date than the named file on the server.
- **Older** - Indicates that the file on the floppy disk has an older creation date than the named file on the server.

5. Press <RETURN> in response to the confirmation prompt that displays the name of the floppy disk.

**Note:** The confirmation prompt defaults to **Y**.

6. Type **Y** or **N** for each file on the floppy disk to confirm whether or not it should be installed on the server, and press <RETURN>.

**Note:** The prompts default to **Y** or **N**, depending on what files have already been installed on the server. If a file on the floppy disk is older than, or the same version as, the named file on the server, the default is **N**. Otherwise, the default is **Y**.

**CAUTION:** Both the Xerox Required Fonts and the Xerox Modern Fonts floppies include a Modern font. When installing Modern fonts, be sure that the Modern font from the Xerox Modern Fonts floppies is installed over the Modern font from the Xerox Required Fonts floppy.

7. When the fonts have been installed, remove the floppy disk.
8. Install the remaining fonts desired, using the relevant floppy disks. Follow steps 4 through 7.
9. Type **Start Printing** and press <RETURN>. Type **Y** to the "Confirm?" prompt and press <RETURN>, if necessary.

**Note:** NS 8000 Laser CP Electronic Printer fonts are rotated at the end of the installation sequence. Font rotation is done automatically when you type the **Start Printing** command. The amount of time required for font rotation varies according to the number of fonts being rotated. Allow approximately 30-35 minutes for a full selection of fonts. See the section "NS 8000 Laser CP Electronic Printer status messages" for a description of the messages displayed during font rotation.

10. Log off.



11. Continue with the appropriate procedure in the "Establishing standard operation of your Print Service" section.

**Note:** Some fonts are contained on more than one floppy disk; in that case, you will be prompted to insert the next floppy disk at the appropriate time. Sometimes the messages prompting you to insert the next floppy may fill up the display, after which the (More) prompt is displayed. This (More) prompt may appear immediately after the message to insert the next floppy disk. Installation will not proceed until you scroll the screen by typing any character. If you changed the floppies before scrolling the screen, the new floppy will not be recognized. To proceed, you must remove and reinsert the new floppy. When the (More) prompt appears, scroll the screen first, THEN insert the new floppy.

**Comment:** You are prompted to choose the style font within each family that you wish to install. For example, when you install Xerox Math Classic fonts, you are asked to respond **Y** or **N** to install a particular style font within that family, such as Math Classic Bold or Math Classic Italic.

If the Print Service is a new installation or has been partitioned for any reason, use the following sequence when installing font floppy disks:

**8040 Series Electronic Printer installation (300 DPI floppy disks):**

- Xerox Required Fonts
- Xerox Basic Classic Fonts

**Note:** This floppy disk is not needed if Math Classic is to be installed. Math Classic overwrites Basic Classic.

- Printwheel Fonts (# 1 and # 2)
- Xerox Math Classic Fonts (# 1, # 2)
- Xerox Modern Fonts (# 1, # 2, # 3, and # 4)

**NS 8000 Laser CP Electronic Printer installation (300 DPI floppy disks):**

Follow the same installation procedure as used above for the 8040 Series Electronic Printer.

**Note:** After fonts are installed, they must be rotated before they can be used by the NS 8000 Laser CP Electronic Printer. Font rotation is done automatically when you type the **Start Printing** command at the end of the installation sequence. See the section "NS 8000 Laser CP Electronic Printer status messages" for a description of the messages displayed during font rotation.

**Telecopier 495-1 Printer installation (200 DPI floppy disks):**

- Xerox Required Fonts

- Xerox Basic Classic Fonts

**Note:** This floppy disk is not needed if Math Classic is to be installed. Math Classic overwrites Basic Classic.

- Printwheel Fonts
- Xerox Math Classic Fonts (# 1 and # 2)
- Xerox Modern Fonts (# 1 and # 2)

**Formatting Print Service installation (300 DPI floppy disk):**

- Xerox Required Fonts

**Note:** The FPS requires that only two fonts be loaded from this floppy:

- 300 DPI Xerox/Graphics/NewVec Font
- Xerox/XC1-1-1/Modern Font

---

## Loading extended language fonts onto your Print Service

---

The procedure for loading extended language fonts onto your Print Service is the same as for loading regular fonts; the difference being the amount of disk storage required. (Refer to the procedure described in "Loading fonts onto your Print Service.")

Extended language fonts are available in Modern and Classic fonts only for Japanese and/or Chinese. In order to load both Modern and Classic extended language fonts, a server with at least 80 Mb of disk storage is required; 42 Mb if you are loading only one of these fonts. The fonts are contained on:

- 14 floppy disks for Modern fonts (Xerox XC1K Modern)
- 14 floppy disks for Classic fonts (Xerox XC1K Classic)

If you load regular fonts and extended language fonts on the same Print Service, you should then delete the corresponding regular fonts (Xerox XC1-1-1 Modern and/or Xerox XC1-1-1 Classic) in order to prevent duplication of fonts on the Print Service.

**Note:** Since a single extended language font requires more than one floppy disk, you are prompted during installation to insert the next floppy disk for the font you are installing.

To set the paper handling options for the printer, use the appropriate procedure in the "Establishing standard operation of your Print Service" section.

---

## Establishing standard operation of your Print Service

---

After you load fonts, you can begin standard operation of your Print Service. This section describes the features you can select for each printing option supported by the Print Service.

For procedures and guidelines to establish standard operation of your Print Service, refer to the appropriate printing option:

- Establishing standard operation of the 8040 Series Electronic Printer
- Establishing standard operation of the NS 8000 Laser CP Electronic Printer
- Establishing standard operation of the Telecopier 495-1 Printer
- Establishing standard operation of the Formatting Print Service

**CAUTION:** The System Administrator should not select a new printing option at startup, while there are uncompleted documents in the queue. The results will be unpredictable when the documents are subsequently processed.

**Note:** Disk space and memory requirements for collated documents are higher than for documents sent to the printer individually.

---

## Establishing standard operation of the 8040 Series Electronic Printer

---

The maximum lengthwise image size for the 8040 Series Electronic Printer output (i.e., 300 spots per inch resolution) is 13.65 inches or 34.67 cm. This is measured from approximately the bottom edge of the paper parallel to the long edge. Characters and graphics which are placed near this upper boundary may not print. This means that a full sized image cannot be printed on a legal size or B4 size page.

**Note:** Some characters contained within text frames near (touching) graphics frames may not print, especially those with the graphics frames to their left on a portrait page. The letter J is a known example of such a character.

The Print Service begins operation with the following default parameter settings:

Paper size in both trays = 8.5 by 11 inches  
Paper feed = From bottom or top  
Paper stacking = Each set of copies offset  
Banner = One per set of copies  
Registration = long: 23; short: 8

You can retain or change this set of options to suit your needs, particularly when special jobs are required. If you wish to change the paper handling options, see the "Maintaining your Print Service" section. The current values of the paper handling options may be seen by typing **Show Status** and pressing **<RETURN>**.

The five paper handling features available as options in the Print Service are:

- **Paper Size** - Available sizes are 8.5 by 11 inches, 8.5 by 14 inches, or 210 by 297 mm (which is a standard European A4 size of 8.27 by 11.69 inches). The size must be specified for both the top and bottom tray for 8040 Series Electronic Printers. Make certain that the trays installed in the printer match the set options.
- **Feed** - Allows paper to be fed from the bottom and/or top feed trays in two different ways: from the bottom tray for documents and the top tray for banner pages, or from either the top or the bottom tray. If the option for either top or bottom is chosen, the printer will switch automatically to the top tray when the bottom tray is empty.

**Comment:** If two different paper sizes are specified (for example, 8.5 by 11 inches in the bottom tray and 8.5 by 14 inches in the top tray), the feed option will automatically be set to "as appropriate."

- **Stacking** - Controls the stacking of print jobs once they are completed and are sent into the output tray. Stacking options are: offset each copy of a document, offset each set of copies of a document, or aligned (no offset stacking).

**Note:** Stacking is applicable only to B2 models of the 8040 Series Electronic Printer.

**Comment:** The term "copy" refers to multiple copies of a document within a single job. The term "set of copies" means a single job, whether or not multiple copies are requested.

- **Banner** - Sets the banner page option so that banner pages can be produced with every copy of a document, with every set of copies of a document, or not at all (suppressed).
- **Registration** - Controls the image alignment on the paper.

**Note:** To insure that the Print Service is operational or to check printer image alignment, you should first print a test pattern, and then, if necessary, adjust the registration. The "Maintaining your Print Service" section contains detailed procedures for printing a test pattern and setting the registration value.

### Printing a test pattern

---

Use the following procedure to ensure that the Print Service is operational:

1. Direct your commands to the Print Service context.
2. Type **Print Test Pattern** and press <RETURN>.
3. Type the number corresponding to the "CAM.interpress" option and press <RETURN>.
4. Type **3** to the "Enter copy count (1-999)" prompt and press <RETURN>.
5. Type the number corresponding to the appropriate paper size option and press <RETURN>. (This option appears only when two paper sizes are loaded.)
6. Observe the test document. If the test pattern did not print successfully, then call the Printer Technical Representative.

**Note:** For additional test procedures, refer to the "Checking printer image alignment" procedure in the "8040 Series Electronic Printer maintenance" section.

### Establishing standard operation of the NS 8000 Laser CP Electronic Printer

---

The NS 8000 Laser CP Electronic Printer option of the Print Service provides the following banner page options through the use of the **Set Banner** command:

- One for each set of copies of a document printed for a user
- One for each copy of a document printed
- Suppressed (no banner)

The Print Service begins operation by printing a banner page for each set of copies; that is, one banner page for each print job. You can retain or change this option to suit your needs. If you wish to change the banner option, see the "NS 8000 Laser CP Electronic Printer maintenance" section. The current values of the banner option can be displayed by typing **Show Status** and pressing <RETURN>. You can use the **Set Banner** command to set the banner option.

The NS 8000 Laser CP Electronic Printer features a single paper input tray and automatically senses the size of paper loaded. For information on adding paper or changing the size of paper loaded, refer to the *NS 8000 Laser CP Operator's Guide*.

The maximum lengthwise image size for the NS 8000 Laser CP Electronic Printer output (i.e., 300 spots per inch resolution) is 13.65 inches or 34.67 cm. This is measured from approximately the bottom edge of the paper parallel to the long edge. Characters and graphics which are placed near this

upper boundary may not print. Note that this means that a full sized image cannot be printed on a legal size or B4 size page.

**Note:** Some characters contained within text frames near (touching) graphics frames may not print, especially those with the graphics frames to their left on a portrait page. The letter J is a known example of such a character.

During printing, the printer maintenance panel displays the page number being printed. If an error code is displayed on the maintenance panel, refer to the flip cards, the *NS 8000 Laser CP Operator's Guide*, or the "Responding to P1, P2, P3, and P4 error codes" procedure in this booklet.

### **Printing a test pattern**

---

Use the following procedure to ensure that the Print Service is operational:

1. Direct your commands to the Print Service context.
2. Type **Print Test Pattern** and press <RETURN>.
3. Type the number corresponding to the "CAM.interpress" option and press <RETURN>.
4. Type **1** to the "Enter copy count (1-999)" prompt and press <RETURN>.
5. Check the copy of the alignment for proper alignment. Fold the pattern in quarters and align the folder line to the cross marks corresponding to the paper size in the center of the page. If the alignment is incorrect, call your Printer Technical Representative
6. If the printed copy has sawtooth edges, the server option board must be upgraded. You should call your Printer Technical Representative.

**Note:** Refer to the "Printing a test pattern" section of the *NS 8000 Laser CP Operator's Guide* for more information.

## **Establishing standard operation of the Telecopier 495-1 Printer**

---

After you have completed the procedures for loading fonts for the Telecopier 495-1 option of the Print Service, you need to be sure that the required hardware is installed and that the Telecopier 495-1 is set up properly.

- **Hardware** - The processor requires an RS-232C kit to provide a local port on the server. The RS-232C cable provided with this kit must be connected from the processor to the Telecopier 495-1. The Telecopier 495-1 itself must be upgraded to the correct version with hardware (RSM upgrade 86S21809 containing RSM PWB, cables, and switches) and firmware (86S21810, called Network Interface) kits installed by Xerox IPD Field Service. The Network Interface kit contains DTIM<SL11, and SL3 PWBs and EPROMs for G2DM PWB (chips GD1E and GD3G).

- **Setting up** - The initial operating conditions for the RS-232C interface between the Telecopier 495-1 and the 8000 server are configured through switch settings on the back of the Telecopier 495-1, along with the RS-232C interface setup card that is provided with the Telecopier 495-1. Once these procedures have been completed, you are ready to set up the Print Service to support facsimile printing.

**Note:** Refer to the "Isolating equipment failures" procedure in the "Telecopier 495-1 Printer maintenance" section for information pertaining to equipment failures between a Telecopier 495-1 and an 8000 processor.

**Comment:** After fonts are loaded on a facsimile printer, the Print Service begins operation with the following default parameter settings:

Transmission retries (no connection) = 6, retry delay (minutes) = 5  
Transmission retries (transmit failure) = 3, retry delay (minutes) = 3  
Local banner = Per set of copies  
Remote banner = Suppressed  
Local duplicate copies = Allowed  
Remote duplicate copies = Suppressed

If you wish to change this set of options to suit your needs, see the "Changing paper handling and transmission options" procedure in the "Telecopier 495-1 Printer maintenance" section. The current values of the parameters may be seen by typing **Show Status** and pressing <RETURN>. The features available as options are briefly described below:

- **Transmission retries** - Sets the options for retrying failed document transmissions.
- **Banner** - Defines when banner pages are printed for both the local and transmitted image.
- **Multiple copies** - Defines handling of multiple copies for both the local and transmitted image.

**Note:** Some characters contained within text frames near (touching) graphics frames may not print, especially those with the graphics frames to their left on a portrait page. The letter J is a known example of such a character.

The following is the procedure to establish standard operation of the Telecopier 495-1 Printer. The shaded squares indicate the active function of the switch, on or off. The switches are set as shown in the example following step 1. The switches are located on the right rear of the Telecopier 495-1 as you face it.

When moving switch positions in the following procedure, use a narrow but relatively blunt object, such as a small screwdriver or ballpoint pen (with the point retracted), to "slide" a single switch contact fully into position. You must be able to get behind the telecopier to change the switches. Do not tilt the telecopier or try to bend over it to change the switches.



1. Set the switch settings on the back of the Telecopier 495-1 to the following:

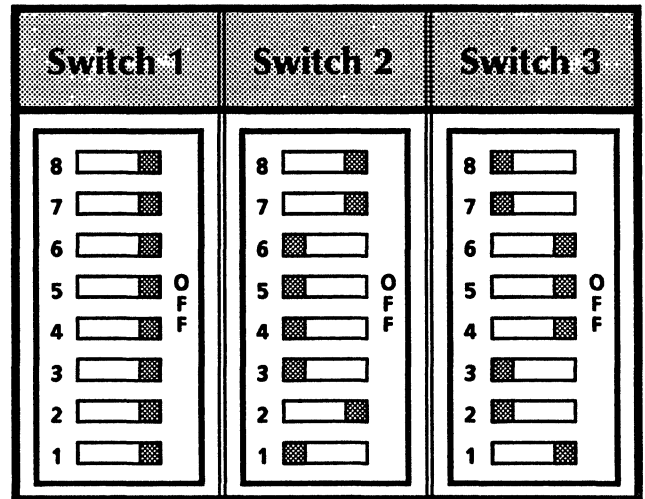

2. Fill in the boxes on the Telecopier 495-1 RS-232C interface setup card as shown on the following page. Use the green side of the card.
3. Insert the card into the telecopier and press <SEND> on the telecopier. Save the card for future reference.
4. To verify that the Print Service is operational, refer to the procedure for printing a test pattern in the "Telecopier 495-1 Printer maintenance" section of "Maintaining your Print Service."
5. You should set the Telecopier 495-1 clock to the current time. This procedure may be found in the "Telecopier 495-1 Printer maintenance" section of "Maintaining your Print Service."
6. The **Start Diagnostic** command is used to further test operation of the Telecopier 495-1. This command allows you to run the RS-232 loopback test, to run the Telecopier 495-1 internal self test, and to set the Telecopier 495-1 clock to the current time. For additional information on use of the **Start Diagnostic** command, refer to the "Maintaining your Print Service" section.



---

## Establishing standard operation of the Formatting Print Service

---

To establish standard operation of the Formatting Print Service, you specify the Target Print Service to receive documents using the **Set Target Print Service** command. When you use this command, the FPS automatically retrieves the current paper handling parameters from the Target Print Service. These parameters include the paper sizes loaded, the availability of stapling, and the availability of double-sided printing. Before the Target Print Service is specified, the paper handling parameters are initially set for letter size (8.5 by 11 inches), no stapling, and single-sided printing only.

**Note:** The FPS must have the current Target Print Service paper-handling parameter information or network print requests may be rejected. For example, the FPS will reject a print request to print on legal size paper if the Target Print Service parameter is set for letter size only.

The Target Print Service must be operational to use the **Set Target Print Service** command. If the Target Print Service is unavailable when the FPS attempts to obtain the paper handling parameters, a warning message appears and the parameters default to letter size paper (8.5 by 11 inches), no stapling, and single-sided printing only. To ensure that the parameters are correct (for instance, if the Target Print Service has been recently restarted), you should use the **Query Target Print Service** command to get the current values when the Target Print Service is available. You can use the **Show Status** command to check the current parameter values being used by the FPS without making a call to the Target Print Service.

**Note:** When the Target Print Service is changed or the server running the FPS is rebooted, the FPS automatically retrieves the paper handling parameters from the Target Print Service.

**Comment:** On the ViewPoint desktop, two printer icons can be created to represent the two possible paths to the Target Print Service: one directly to the Target Print Service for documents that are printable on the Target Print Service without conversion by FPS (this includes documents with only text and horizontal or vertical line graphics) and another via the FPS for documents with complex graphics requiring conversion by FPS. For example, the former could be named "Rover" and the latter named "RoverGraphics."

Refer to the "Changing the Target Print Service" procedure in the "Formatting Print Service maintenance" section for the procedure to specify the 9700/8700 Electronic Printing System to receive documents from the FPS.

*(This page intentionally blank)*

## **4. Maintaining your Print Service**

To keep your Print Service running at optimum level, you may need to perform some routine maintenance tasks, such as checking the level of dry imager and fixing paper jams (misfeeds). Other tasks, such as deleting fonts, correcting printer image alignment, starting or stopping queuing, and starting or stopping printing, are done on an as-needed basis.

The maintenance tasks contained in this section are grouped as follows:

- Print Service maintenance
- 8040 Series Electronic Printer maintenance
- NS 8000 Laser CP Electronic Printer maintenance
- Telecopier 495-1 Printer maintenance
- Formatting Print Service maintenance
- Image Gap reprinting

Call the Network Support Center if you need assistance.

## Print Service maintenance

---

This section contains maintenance procedures that you perform as needed for all options of the Print Service. The following maintenance tasks are included in this section:

- Deleting fonts from your Print Service
- Print Service statistics
- Removing the Print Service from a server

**CAUTION:** If a Print Service crashes after it has successfully restarted (the server is booted and the "Print Service run" message is displayed), it is likely that a particular document in the queue is causing the problem. The problem document might be the one which is being printed at the time of the crash, or it might be one that is receiving some other sort of processing. If the crash is caused by a problem with the document being printed, the recovery is automatic after the Print Service has restarted for the second time following a crash. (It automatically removes the offending document from the queue.)

### Deleting fonts from your Print Service

---

You may find it necessary to remove unused fonts to increase the document queue space on the Print Service. The deletion should be done with caution, since it will affect all users of the Print Service.

1. Check with users to make sure they do not need to use the fonts you wish to delete.
2. Log on and enable in the Print Service context.
3. Type **Stop Printing** and press <RETURN>. Type in the reason for stopping printing (optional) and press <RETURN>. You may wish to allow documents that are currently being formatted or printed to complete prior to stopping printing. Otherwise, they will be requeued and processed again when printing is restarted.
4. Type **Delete Font** and press <RETURN>.
5. The system will issue prompts for the deletion of each font currently installed on the Print Service. You respond **Y** or **N**, depending upon which fonts you wish to delete, and press <RETURN>.

After the system has prompted for each currently installed font, it reports the number of fonts that were deleted. An example of this procedure follows.

```

PS>Delete FontRETURN
Delete Xerox.XC1-1-1.Modern. (Y/N): NRETURN
Delete Xerox.XC1-1-1.Modern.Bold (Y/N): NRETURN
Delete Xerox.XC1-1-1.Modern.Italic (Y/N): YRETURN
Deleting Xerox.XC1-1-1.Modern.Italic. . done
Delete Xerox.XC1-1-1.Classic. (Y/N): NRETURN
1 font(s) deleted.
PS!

```

6. Type **List Fonts** and press <RETURN> to check the names and version dates of the fonts on your Print Service.
7. Type **Start Printing** and press <RETURN>. Confirm Start Printing if necessary.
8. Log off.

**Comment:** For information on loading fonts, see the "Loading fonts onto your Print Service" section.

## Print Service statistics

A number of Print Service statistics are displayed when you are enabled and you type the **Show Status** command.

<b>Documents Printed</b>	The number of documents printed successfully by the Print Service.
<b>Documents Aborted</b>	The number of documents canceled by the System Administrator, plus those aborted by the Print Service because of some error.
<b>Queue Failures</b>	The number of documents that could not be queued because of some problem. (For example, if the user specified a paper size that is not available or if the document was too big to fit on the server disk.)
<b>Test Pattern Requests</b>	The number of test patterns printed.
<b>Recovery Retry Requests</b>	The number of documents retried after a server reboot.
<b>Documents Purged at Recovery</b>	The number of documents aborted after a server reboot. (Documents found in progress at system restart are tried once. If found in progress again at system restart, they are aborted.)

Each statistic displayed includes the count since the server was last rebooted and a cumulative total since the statistics were last reset to zero (or since the Print Service was first installed).

The **Reset Statistics** command resets to zero all counters that accumulate Print Service statistics.

To reset statistics:

1. Log on and enable in the Print Service context.
2. Type **Reset Statistics** and press <RETURN>.

3. Type **Y** to the confirmation prompt and press **<RETURN>**. If **Show Status** is done immediately following the **Reset Statistics**, 0 will appear for any Print Service statistics.

(Only the "Documents printed" statistic displays after the reset.)

4. Log off.

```
PS!Show StatusRETURN
.
Documents printed: 47; Total since reset: 1954
Documents aborted: 0; Total since reset: 2
Queue failures: 0; Total since reset: 1
Test pattern requests: 1; Total since reset: 5
Recovery retry requests: 1; Total since reset: 3
Documents purged at recovery: 0; Total since reset: 1

PS!Reset StatisticsRETURN
Please confirm (Y/N): YRETURN
Done

PS!Show StatusRETURN
.
Documents printed: 0; Total since reset: 0
```

## Removing the Print Service from a server

You can remove any Print Service from a server by using the **Expunge Service** command. This procedure is covered in the *Server Operation and Maintenance* booklet. Expunging the Print Service will recover server disk space.

The Print Service should only be expunged when it is being removed from a server; never as a troubleshooting procedure. All Print Service data is deleted, including the document queue, fonts, and test patterns. The service name is also deleted from the Clearinghouse database.

When the Print Service is expunged, you will be asked to confirm the following prompt:

```
Ready to delete all Print Service data, INCLUDING
font files? (Y/N): YRETURN
```



## **8040 Series Electronic Printer maintenance**

---

Your first source of information for operation and maintenance of the 8040 Series Electronic Printer is the flip cards and labels located on the machine. This section contains additional maintenance procedures that you may perform as needed.

The following maintenance tasks are included in this section:

- Getting to know the 8040 Series Electronic Printer
- 8040 Series Electronic Printer paper
- Checking the dry imager
- Checking printer operation, ensuring print quality, and clearing paper jams
- Changing paper handling options
- Correcting printer image alignment
- Responding to L2 and L4 error codes
- Controlling power consumption on B2 electronic printers (printers with output stacking option)
- Audible alarm option
- Technical Representative repair mode
- Safety notes

### **Getting to know the 8040 Series Electronic Printer**

---

**Terminal keyboard and display** - Provides local Services Executive interface for entering commands.

**Processor** - Runs the software that controls the 8040 Series Electronic Printer.

**Interface cable** - The special signal cable connecting the Processor to the printer.

**Flip cards** - Contain easy reference instructions on machine operation.

**Output tray** - Prints are delivered here.

**Paper cassettes** - Each cassette holds up to 250 sheets of paper.

**Front door** - Opens for access to main power switch, dry imager control, and machine paper path.

### **Printer maintenance panel**

---

**On Line** - Ready to make prints.

**Off Line** - Stops printing. Used for testing and service.

**Test** - Makes a test print (off line only).

**Printer display** - Displays status codes.

**Printer keypad** - The 10-key touch pad is for control of 8040 printer by the Xerox Technical Representative.

### **Printer care**

---

To turn power on:

1. Open front door.
2. Turn on power switch (located in upper left corner) marked by a vertical bar.
3. Close front door.
4. L1 code will be displayed during warm-up (about 6 minutes).

To set up printer:

1. Check that cassettes are full. Place handle in vertical position to run.
2. Check supply of dry imager. Add if needed.
3. Check to see if a status code is displayed.
4. Press <Off Line>.
5. Press <Test> for a test print to verify that printer is working. (The test print should be a series of horizontal stripes (approximately 3/10 inch wide) spaced about 1 inch apart. If not, call your Xerox Technical Representative.)
6. Empty output tray.
7. Press <On Line>. Printer is ready.

During the day as needed:

1. Check and add dry imager (if required).
2. Add paper.
3. Empty output tray.

4. Rotate dry imager control knob.
5. Assist other operators.

**Note:** Call the Network Support Center if there is a printer problem and corrective action failed.

## **8040 Series Electronic Printer paper**

---

The 8040 Series Electronic Printer can make prints on paper ranging from substance 16 (thinnest) to substance 24 (thickest).

For best results, use substance 20 xerographic grade or xerographic dual-purpose paper.

The paper sizes are:

- 8-1/2 by 11 inches
- 8-1/2 by 14 inches (legal size)
- 210 mm by 297 mm (standard European A4 size of 8.27 by 11.69 inches).

Tightly seal opened paper packages. Store all paper on a flat surface, in a closed cabinet (if possible), and in a cool, dry area.

### **Checking the paper cassette**

---

1. Turn selector handle clear of cassette.
2. Pull cassette partially out to check for paper.
3. If the cassette is empty, add paper.

**Note:** If the cassette has paper in it, proceed to step 6.

4. Pull cassette out of printer.
5. Follow instructions on cassette to load paper. The paper should be loaded into the input cassette tray in line with the arrows on the wrapper pointing down (the arrows point in the direction of the paper going into the tray).
6. Insert cassette, making sure you slide it all the way in.
7. Turn selector handle to the vertical position.

### **Loading special paper types**

---

The 8040 Series Electronic Printer can do more than print on plain white paper. It can print on color, pre-drilled, or letterhead paper.

To load pre-drilled or letterhead paper into the 8040 Series printer, set the input paper handling option on the printer server that controls the paper feeding from the input trays.

- Pre-drilled paper** Loading pre-drilled paper into the 8040 Series Electronic Printer:
1. Load pre-drilled paper into paper cassette with holes on RIGHT side of cassette.
  2. Transmit document from workstation.
- Letterhead paper** Loading letterhead paper into the 8040 Series Electronic Printer:
1. Load letterhead paper into the paper cassette, FACE DOWN, with letterhead to the REAR of the 8040 Series Electronic Printer.
  2. Transmit document from workstation.

## Checking the dry imager

---

Dry imager is the black powder that forms the image on copies created by your 8040 Series Electronic Printer. It is important to keep the dry imager supply at the proper level at all times. Copies gradually become lighter if the supply of dry imager runs low.

The B2 model of the 8040 Series Electronic Printer displays a J1 status when the dry imager is low. Newer B2 versions of the 8040 Series are equipped with a system called Automatic Density Control and do not have a dry imager control knob.

However, for other models, you should periodically check the dry imager. If the agitator blades are visible, it is time to add dry imager. For optimum machine performance, maintain dry imager level above agitator.

- Adding dry imager** Use the following procedure to correct dry imager problems.
1. Read the instructions on the label of the 8040 dry imager bottle. Shake the imager well.
  2. Open the access cover on the top of the printer.
  3. Lift the lid of the dry imager dispenser.
  4. Replace the bottle cap with the funnel top.
  5. Carefully add enough dry imager to fill the dispenser to within 1/2 inch of the top, or to the three reference struts inside the dispenser.
- Note:** Avoid spillage outside of the dry imager dispenser.
6. Close the dry imager dispenser lid.
  7. Clean off any spilled dry imager.

**Note:** If any dry imager gets on your hands or clothes, it can be brushed off or washed off with cold water. Do not use warm or hot water or cleaning solvents, as these will set the dry imager and make it difficult to remove.

8. Replace the funnel top with the bottle cap.

**Light prints** If prints are still too light:

1. Open the front door of the printer.
2. Rotate dry imager control knob clockwise until dot points to "Darker." (See Note below.)
3. Close the front door and resume transmitting documents.

**Dark prints** If prints are too dark:

1. Open the access cover on the top of the printer.
2. Rotate the dry imager control knob counterclockwise until the dot points to "Lighter."
3. Close the front door and resume transmitting documents.

**Note:** It will take approximately 20 copies for the dry imager control to take effect.

## **Checking printer operation, ensuring print quality, and clearing paper jams**

---

In addition to the flip cards and labels located on the 8040 Series Electronic Printer, the following procedures provide supplemental directions. If you cannot solve the problem, call the Network Support Center.

1. If the printer does not run, check to see if:
  - The Print Service terminal is on
  - The printer is On Line
  - Any status code is visible
  - The front door is fully closed
  - Printer power is on
  - Insure that the cable between the processor and printer is firmly connected.
2. If you have a paper jam, you will need to clear the paper path as follows:
  - Open the door (the E5 code will be displayed)
  - Follow instructions indicated by arrow
  - Close the door
  - Check that the On Line indicator is ON
3. If you see an excessive number of E2, E3, or E4 status codes, proceed as follows:

- Empty the output tray more often.
  - Turn the paper in the paper tray upside down. The paper should be loaded into the input cassette tray in line with the arrows on the wrapper pointing down (the arrows point in the direction of the paper going into the tray). These arrows point to the crown of the curl of the paper. As the humidity increases, the paper absorbs more moisture and the curl also increases, raising the crown of the curl. If the curl of the paper follows in the same direction as the curvature of the drum, the paper may stick to the drum, causing a jam (misfeed).
4. If there are spots, smears, marks, or lines on prints, check the quality of the paper supply.
  5. If there is slanted or skewed information on prints, check that the paper is loaded properly in the paper tray.
  6. If your printed document does not arrive at the output tray, check to see if any status code is visible. Refer to the flip cards for corrective actions.

**Note:** If you see the status codes L2 or L4, continue with the "Responding to L2 and L4 error codes" procedure.

## Changing paper handling options

---

Use the **Set Parameters** command to change paper handling options for the 8040 Series Electronic Printer. This command redisplay the selection menu until you type the number corresponding to the "Exit" option or press <CTRL> and <C> simultaneously.

For the 8040 Series Electronic Printers, the paper handling options can be changed for special print jobs, such as loading different paper sizes. B2 versions of the 8040 Printer also have stacking drums, which deliver the sheets face down and allow a document to be offset in relation to the next document in the stack. "Stacking" is one of the options if you have this version printer.

1. Log on and enable in the Print Service context.
2. Type **Set Parameters** and press <RETURN>.
3. Type the number corresponding to the option desired from the following list and press <RETURN>.
  - Paper Size - Defines the paper size on a per-tray basis.
  - Feed - Controls which paper tray is used to feed the printer, in conjunction with paper size. If the paper size for both trays is the same, the paper may be fed from the bottom tray for documents and the top tray for banner pages, or from either the bottom tray or the top tray, depending on which one is empty. If the

paper size specification for the upper and lower trays is different, feed selection will default to "as appropriate."

- **Banner Handling** - Controls when banner pages are produced. Banner pages may be produced once for every copy of a document, once for every set of copies of a document, or not at all.

**Comment:** The term "copy" refers to multiple copies of a document within a single job. The term "set of copies" means a complete single job, whether or not multiple copies are requested.

- **Stacking** - Controls the output stacking alignment only on B2 versions of the 8040 Series Electronic Printer. Paper may be stacked aligned, offset with each copy of a document, or offset with each set of copies of a document.

**Note:** This choice is not displayed for B1 electronic printers.

- **Registration** - Allows you to enter the values determined by printing the alignment pattern. (Refer to the "Correcting printer image alignment" procedure for details on how to correct image alignment.)

4. Type the number corresponding to the new option value desired and press <RETURN>.
5. Repeat steps 3 and 4 any number of times. Type the number corresponding to the "Exit" option and press <RETURN> when you have changed all desired options. See the following example:

```

PS!Set ParametersRETURN
1 Exit
2 Paper size
3 Feed
4 Banner
5 Stacking
6 Registration
Enter choice number: 2RETURN
Specify top tray paper size
1 8.5" x 11"
2 8.5" x 14"
Enter choice number: 1RETURN
Specify bottom tray paper size
1 8.5" x 11"
2 8.5" x 14"
Enter choice number: 1RETURN
Paper size in both trays = 8.5" x 11"
Select from
1 Exit

```

6. Typically, a user will have asked you to change these options for his or her print job. Ask the user to print the documents requiring these special options and notify you when the printing is done.
7. Remove any special paper. Refill the paper bins with standard paper.
8. Type **Set Parameters** again and return the printer to standard operation.
9. Log off from the Print Service context.

**Note:** The "Establishing standard operation of your Print Service" procedure contains additional information on the five paper handling options for the electronic printer.

## Checking printer image alignment

---

You may need to readjust the printer image alignment with the "Registration" option of the Set Parameters command for the 8040 Series Electronic Printer. To correct printer image alignment, first print a test pattern, and then adjust the registration. Use the following procedures to correct printer image alignment. If the printer image alignment is not correct, follow the procedure to set the registration value.

### Printing a test pattern

---

1. Direct your commands to the Print Service context.
2. Type **Print Test Pattern** and press <RETURN>.
3. Type the number corresponding to the "AlignmentPattern.interpress" option and press <RETURN>.
4. Type **3** to the "Enter copy count (1-999)" prompt and press <RETURN>.
5. Type the number corresponding to the appropriate paper size option and press <RETURN>. (This option appears only when two paper sizes are loaded.)

**Comment:** Three copies of the alignment pattern are printed. Check them for proper alignment. The 0 marks should align with the left edge and the bottom edge of the paper. If the image is not properly aligned on the paper or an offset value is needed, perform the following steps.

### Setting the registration value

---

1. Log on and enable in the Print Service context.
2. Type **Set Parameters** and press <RETURN>.



3. Type the number corresponding to the "Registration" option and press <RETURN>.
4. The screen displays the "Enter Registration Value for the Long Axis (10-43)" prompt. Type the value for top to bottom registration. (The value 23 is the norm for most printers.) Typing 23 should align the 0 marks with the bottom edge of the paper. Increasing the number will move the image up. Decreasing the number will move the image down. You cannot enter a value less than 10 or greater than 43. Each increment of 1 will move the image approximately 1/16 inch. The correct value is determined by printing the alignment test pattern.
5. The screen displays the "Enter Registration Value for the Short Axis (1-30)" prompt. Type the value for side-to-side registration. (The value 8 is the norm for most printers.) Typing 8 should align the 0 marks with the left edge of the paper. Increasing the number will move the image to the right. Decreasing the number will move the image to the left. You cannot enter a value less than 1 or greater than 30. The correct value is determined by printing the alignment test pattern.
6. Type the number corresponding to the "Exit" option and press <RETURN> when you have changed the registration values.
7. Log off from the Print Service context.

## **Responding to L2 and L4 error codes**

---

You will need to troubleshoot the 8040 Series Electronic Printer if the panel displays the numbers L2 or L4. Use the appropriate procedure to correct L2 or L4 error codes.

### **Correcting an L2 error code**

---

The L2 error code indicates that the server processor is not receiving the video clock or line-sync signals from the printer. This may be due to a printer problem, a cable problem, or a problem within the server processor.

The image test enables the System Administrator or the Technical Representative to diagnose an L2 type failure. The System Administrator should report the results of the test to a field service dispatcher.

1. Check the cable connecting the printer to the server processor.
2. Press <Off Line>, then press <Test> to produce a test print. The test print should be a series of horizontal stripes (approximately 3/10 inch wide) spaced about 1 inch apart. If not, call your Xerox Printer Technical Representative.
3. Press <On Line>.

4. Direct your commands to the Print Service context. Type **Start Diagnostic** and press <RETURN>.
5. Type **Y** to the confirmation prompt and press <RETURN>.
6. Type the number corresponding to the image test and press <RETURN>. This starts the diagnostic program that tests the server and printer imaging components. All other normal functions (queuing, printing, and so forth) are preempted while the diagnostic program runs

An image test example follows:

```
PS> Start DiagnosticRETURN
Please confirm (Y/N): YRETURN
Select From...
1 Exit
2 Command/Status Turnaround Test
3 Image Test
4 Display Tech Rep Log
5 Print Tech Rep Log
6 Reset Tech Rep Log
Enter choice number: 3RETURN
Image Test...Working.

Select From...
1 Exit
2 Command/Status Turnaround Test
3 Image Test
4 Display Tech Rep Log
5 Print Tech Rep Log
6 Reset Tech Rep Log
Enter choice number: 1RETURN
PS>
```

## Example of failure messages:

Image Test...Failing: Code # 1, VideoData: stuck,  
LineSync: N/A, VideoClock: N/A.

Failing: Code # 2, VideoData: stuck, LineSync: N/A,  
VideoClock: N/A.  
Failing: Code # 3, VideoData: ok, LineSync: stuck  
low, VideoClock: ok.  
Failing: Code # 4, VideoData: ok, LineSync: stuck  
low, VideoClock: stuck.  
Failing: Code # 5, VideoData: ok, LineSync: stuck  
high, VideoClock: ok.  
Failing: Code # 6, VideoData: ok, LineSync: stuck  
high, VideoClock: stuck.  
Failing: Code # 7, VideoData: ok, LineSync: ok,  
VideoClock: stuck low.  
Failing: Code # 8, VideoData: ok, LineSync: ok,  
VideoClock: stuck high.  
Aborted: Test Pattern File Problem.  
Aborted: Other error.

If the image test failure code is 0, 1, or 2, call the 8000 Processor Technical Representative. If the return code is 3 thru 8, call the Printer Technical Representative. The message "Aborted: Test Pattern file problem" indicates that the GreyDusting-interpress file loaded from the Required Fonts floppy disk is not present. The message "Aborted: Other Error" indicates that the test was not performed due to an L4 error.

**Note:** The image test produces one grey test print.

### Correcting an L4 error code

The L4 error code indicates that the Print Service is unable to communicate with the printer. The server processor is not detecting correct status signals from the printer in response to commands sent to the printer. This may be due to a printer problem, a cable problem, or a problem within the server processor.

1. Ensure the printer is powered on.
2. Check the cable connecting the printer to the server processor.
3. Reboot the printer by switching off the printer power, waiting 10 seconds, and switching the power on. (The printer power switch is located behind the front cover in the upper left corner.) The message, "\*\*\*Printer Status=L1-Warming, please wait," should now be displayed. If L1 is not displayed, call your printer

Technical Representative. If the L4 error code persists, call the Technical Support Center.

- 4. If an L4 error code is displayed, the Command status turnaround test of the **Start Diagnostic** command enables the Technical Representative to verify the server processor circuitry and the printer cable.

**CAUTION:** This is to be performed only under the direction of a Xerox Technical Representative.

### Display Tech Rep Log

---

The "Display Tech Rep Log" option enables the System Administrator or the Technical Representative to display the log of print engine interface data and jam (misfeed) rates. The data is accumulated since the last time the tech rep log was reset.

```
PS> Start Diagnostic
Please confirm (Y/N): Y
Select From...
1  Exit
2  Command/Status Turnaround Test
3  Image Test
4  Display Tech Rep Log
5  Print Tech Rep Log
6  Reset Tech Rep Log
Enter choice number: 4
```

Given below are examples of the data displayed for the 8040 Series Electronic Printer:

```

XEROX 8040 Tech Rep Log Of February 1, 85 13:32:24
Host # 2-852-126-727
Software Of 24-Oct-85 15:22:51
Last Reset On 13-Sep-85 8:17:43
3287 Total Feeds (Since Last Reset)

++ Jam Counters ++
C4 - Bottom Feeder Fault:..... 42..... 0
C4 - Top Feeder Fault:..... 53..... 0
E2 - Post Registration Jam:..... 6..... 0
E3 - Pre Exit Jam:..... 2..... 0
E4 - Output Tray Full(B0-B1) - Post Exit Jam(B2):..... 3..... 0
E5 - Output Tray Full (B2):..... 1..... 0
* Rate = (Total/Total Feeds)*1000

++ Command Counters ++
Feed Bottom Aligned: 1508
Feed Bottom Offset: 1388
Feed Top Aligned: 102
Feed Top Offset: 141
Solicit Status: 2166
Solicit Paper Size: 0
Display: 61
Doze Off: 1
Wake Up: 172
Beep: 0

++ Status Counters ++
Ready to Feed: 3577
Feeding: 3287
Page Sync: 3301
Page at Output Tray: 3009
Fuser Cold: 192
Toner Low: 2
Door Open: 82
    
```

8040 Tech Rep Log example (page 1)

```
Feed Trays Not Engaged: 118
Acknowledge: 61
About to Doze Off: 170
Paper Small Small: 0
Paper Small Large: 0
Paper Large Small: 0
Paper Large Large: 0
Key 0 to 9: 26
Key Clear: 2
Key Test: 12
Key On Line: 5
Key Off Line: 11
Going Off Line: 3
Off Line: 8
Parity Error: 4
Illegal Character: 1
Illegal Sequence: 0
Status Error: 31
No Status: 6
Status Over Run: 19
Undefined Status: 2

++ Plate Status Counters ++
Band Overrun: 9
Page Sync Miss: 2

++ Status Extras Counters ++
Image fault 1: 1
Image fault 2: 0
Image fault 3: 0
Sequence fault: 0
Command/status communication fault: 11
PS!
```

8040 Tech Rep Log example (page 2)

## Print Tech Rep Log

---

The "Print Tech Rep Log" option enables the System Administrator or the Technical Representative to print a log of print engine interface data and jam (misfeed) rates. The data is accumulated since the last time the tech rep log was reset.

```
PS> Start DiagnosticRETURN
Please confirm (Y/N): YRETURN
Select From...
1  Exit
2  Command/Status Turnaround Test
3  Image Test
4  Display Tech Rep Log
5  Print Tech Rep Log
6  Reset Tech Rep Log
Enter choice number: 5RETURN
PS>
```

## Reset Tech Rep Log

---

The "Reset Tech Rep Log" option enables the System Administrator or the Technical Representative to reset the previously accumulated print engine interface data and jam rates. This should only be done after major printer repairs or printer replacement.

**CAUTION:** Use this command only under the direction of your Xerox Technical Representative.

```
PS> Start DiagnosticRETURN
Please confirm (Y/N): YRETURN
Select From...
1  Exit
2  Command/Status Turnaround Test
3  Image Test
4  Display Tech Rep Log
5  Print Tech Rep Log
6  Reset Tech Rep Log
Enter choice number: 6RETURN
Please confirm (Y/N): YRETURN
PS>
```

## Controlling power consumption on B2 electronic printers (printers with output stacking option)

---

If you have a B2 version of an 8040 Series Electronic Printer (one with an output stacking drum), you can reduce its power consumption during slower periods of use (for example, at the end of the work day). You do this by putting the print engine in low power mode with the **Shutdown Printer** command. The printer also enters this mode automatically when it is unused for over 90 minutes; it resumes operation when needed.

When the printer is in the low power mode, the **Wakeup Printer** command returns the printer to full power mode. The engine requires approximately 6 minutes to warm up before it becomes operational, during which time an L1 status will be displayed. The printer will also enter full power mode automatically when a printing job has been initiated.

Use the procedures to control the use of power on output stacking printers:

Reducing power consumption:

1. Log on and enable in the Print Service context.
2. Type **Shutdown Printer** and press <RETURN>.
3. Type **Y** to the confirmation prompt and press <RETURN>.
4. Log off from the Print Service context.

Returning the printer to full power mode:

1. Log on and enable in the Print Service context.
2. Type **Wakeup Printer** and press <RETURN>.
3. Log off from the Print Service context.

## Audible alarm option

---

The optional audible alarm kit provides an audible signal if the printer needs attention. The volume control for the signal is located behind the front door near the top and is marked by a bell symbol. This "buzzer kit" (98S620) can be installed by your Xerox Sales Representative on B2 versions of the 8040 Series Electronic Printer. Logic upgrades may be required to the printer before this kit can be installed.

## Technical Representative repair mode

---

The Xerox Technical Representative may place the Print Service in repair mode from the printer control panel. The message "PS: \*\* Repair Mode entered." will be displayed. This mode allows the Printer Technical Representative to execute



commands and print test patterns to verify operation of the printer.

**CAUTION:** The Print Service must be started in order to enter the repair mode. The server will crash if the **Stop Service** command is executed before entering the repair mode using the printer keypad. Printing and queuing can be either stopped or started. The **Start Diagnostic** command must not be used when the printer is in repair mode, or the server will crash.

## Safety notes

---

“Warning -- This equipment generates, uses, and can radiate radio frequency energy and if not installed and used in accordance with the instruction manual, may cause interference to radio communications. It has been tested and found to comply with the limits for a Class A computing device pursuant to Subpart J of Part 15 of FCC rules, which are designed to provide reasonable protection against such interference. Operation of this equipment in a residential area is likely to cause interference, in which case the user at his own expense will be required to correct the interference.”

Your 8040 Series Electronic Printer and supplies have been designed and tested to meet strict safety requirements. Attention to the following notes will ensure the continued safe operation of your 8040 Series Electronic Printer.

**WARNING: Improper connection of the 8040 Series Electronic Printer grounding conductor can result in risk of electrical shock.**

- ALWAYS connect the 8040 Series Electronic Printer to a properly grounded power source receptacle. If in doubt, have the receptacle checked by a qualified electrician.
- NEVER use a ground adapter plug to connect the 8040 Series Electronic Printer to a power source receptacle that lacks a ground connection terminal.
- NEVER attempt any maintenance function that is not specifically described in the operator manual.
- NEVER remove any covers or guards that are fastened with screws. There are no operator-serviceable areas within these covers.
- NEVER override or “cheat” electrical or mechanical interlock devices.
- ALWAYS use materials and supplies specifically designated for your Xerox 8040 Series Electronic Printer. Use of non-approved materials may result in poor performance and can possibly create a hazardous situation.
- NEVER use supplies or cleaning materials for purposes other than they were intended. Keep all materials out of the reach of children.

- NEVER operate the 8040 Series Electronic Printer if unusual noises or odors are noticed. Disconnect the power cord from the power source receptacle and call your Xerox Technical Representative to correct problem.
- ALWAYS locate the 8040 Series Electronic Printer on a solid support surface, with adequate strength for the weight of the machine.
- ALWAYS exercise care in moving or relocating the 8040 Series Electronic Printer. Refer to the operator's manual for correct procedures in lifting and moving the unit.

## NS 8000 Laser CP Electronic Printer maintenance

Your first sources of information for operation and maintenance of the NS 8000 Laser CP Electronic Printer are the flip cards, labels located on the machine, and the *NS 8000 Laser CP Operator's Guide*, which are supplied with your printer.

This section contains additional information and maintenance procedures that you perform as needed.

- Getting to know the NS 8000 Laser CP Electronic Printer
- Changing the banner option
- Responding to P1, P2, P3, and P4 error codes
- Checking printer image alignment
- Technical Representative repair mode
- Safety notes

Refer to the flip cards or the *NS 8000 Laser CP Operator's Guide* for detailed instructions on adding dry imager, adding paper, and clearing paper jams.

### Getting to know the NS 8000 Laser CP Electronic Printer

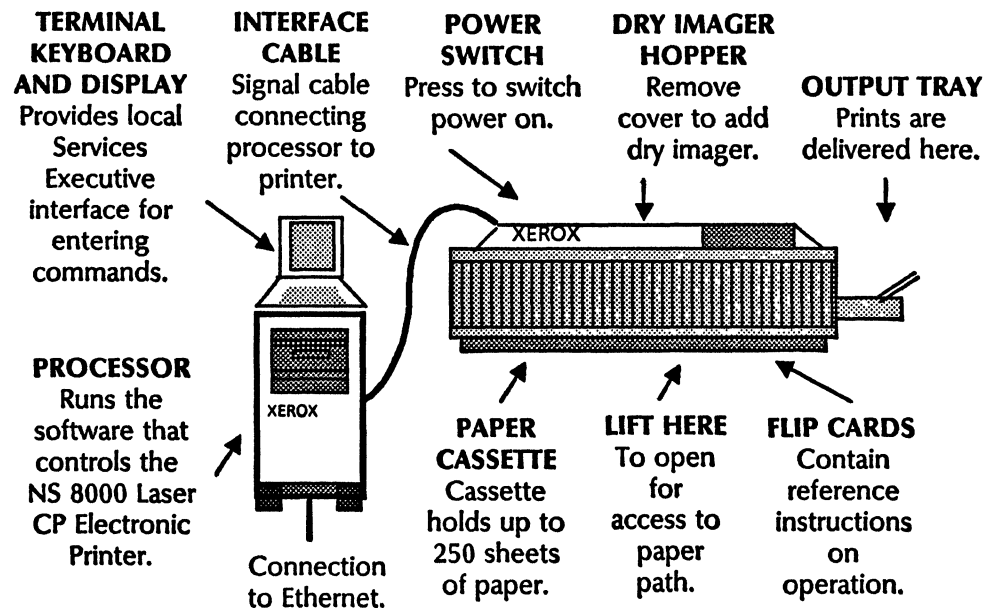

Figure 7. NS 8000 Laser CP Electronic Printer

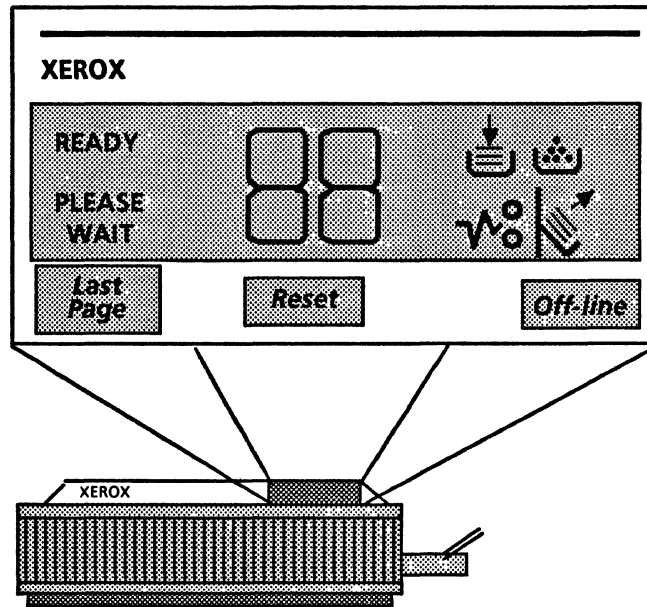

Figure 8. NS 8000 Laser CP maintenance panel

## Changing the banner option

Use the **Set Banner** command to change the banner option for the NS 8000 Laser CP Electronic Printer. The NS 8000 Laser CP Electronic Printer option of the Print Service provides banner page options for:

- Each set of copies of a document printed for a user
- Each copy of a document printed
- Suppressed (no banner)

The Print Service begins operation by printing a banner page for each set of copies; that is, one banner page for each print job. You can retain or change this option to suit your needs. The current values of the banner option can be displayed by typing **Show Status** and pressing <RETURN>. You can use the **Set Banner** command to set the banner option.

1. Log on and enable in the Print Service context.
2. Type **Set Banner** and press <RETURN>.
3. Type the number corresponding to the new option value desired and press <RETURN>. Banner pages may be produced once for every copy of a document, once for every set of copies of a document, or not at all. See the following example:

```

PSISet BannerRETURN
Select banner sheet option
1 Per copy
2 Per set of copies
3 Suppressed
Enter choice number: 2RETURN
Banner=Per set of copies
PSI

```

4. Log off from the Print Service context.

**Comment:** The term “copy” refers to multiple copies of a document within a single job (print request). The term “set of copies” means a complete single job, whether or not multiple copies are requested.

## Responding to P1, P2, P3, and P4 error codes

You may need to troubleshoot the NS 8000 Laser CP Electronic Printer if the printer maintenance panel or server terminal displays a P1, P2, P3, or P4 error code. For an explanation of other codes which might display on the printer maintenance panel or server terminal, refer to the “NS 8000 Laser CP Electronic Printer status messages” section.

Here are the procedures to correct error codes. Use the appropriate procedure for the error code displayed.

### Correcting P1, P2, and P3 error codes

P1, P2, and P3 error codes indicate that the server processor is not receiving the video clock or line-sync signals from the printer. This may be due to a printer problem, a cable problem, or a problem within the server processor.

The image test enables the System Administrator or the Technical Representative to diagnose P1, P2, and P3 type failures. The System Administrator should report the results of the test to a field service dispatcher.

1. Check the cable connecting the printer to the server processor.
2. Direct your commands to the Print Service context.
3. Type **Start Diagnostic** and press <RETURN>.
4. Type **Y** to the confirmation prompt and press <RETURN>.
5. Type the number corresponding to the image test and press <RETURN>. This starts the diagnostic program that tests the server and printer imaging components. All other normal functions (queuing, printing, and so forth) are preempted while the diagnostic program runs.

Image test example:

```

PS> Start Diagnostic RETURN
Please confirm (Y/N): Y RETURN
Select From...
1 Exit
2 Command/Status Turnaround Test
3 Image Test
4 Display Tech Rep Log
5 Print Tech Rep Log
6 Reset Tech Rep Log
Enter choice number: 3 RETURN
Image Test...Working.

Select From...
1 Exit
2 Command/Status Turnaround Test
3 Image Test
4 Display Tech Rep Log
5 Print Tech Rep Log
6 Reset Tech Rep Log
Enter choice number: 1 RETURN
PS>
    
```

Examples of image test failure messages:

```

Image Test..Failing: Code # 1, VideoData: stuck,
LineSync: N/A, VideoClock: N/A.
    
```

```

Failing: Code # 2, VideoData: stuck, LineSync: N/A,
VideoClock: N/A.
Failing: Code # 3, VideoData: ok, LineSync: stuck
low, VideoClock: ok.
Failing: Code # 4, VideoData: ok, LineSync: stuck
low, VideoClock: stuck.
Failing: Code # 5, VideoData: ok, LineSync: stuck
high, VideoClock: ok.
Failing: Code # 6, VideoData: ok, LineSync: stuck
high, VideoClock: stuck.
Failing: Code # 7, VideoData: ok, LineSync: ok,
VideoClock: stuck low.
Failing: Code # 8, VideoData: ok, LineSync: ok,
VideoClock: stuck high.
Aborted: Test Pattern File Problem.
Aborted: Other error
    
```

If the image test failure code is 0, 1, or 2, call the 8000 Processor Technical Representative. If the return code is 3 through 8, call the Printer Technical Representative. The message "Aborted: Test Pattern file problem" indicates that the GreyDusting.interpress file loaded from the Required Fonts floppy disk is not present. The message, "Aborted: Other Error" indicates that the test was not performed due to a P4 error.

**Note:** The image test produces one grey test print.

### Correcting P4 error codes

The P4 error code indicates that the Print Service is unable to communicate with the printer. The server processor is not detecting correct status signals from the printer in response to commands sent to the printer. This may be due to a printer problem, a cable problem, or a problem within the server processor.

The printer must be powered on and the Ready light must be lit.

1. Reboot the printer. (This is done by turning off the printer power switch located on the top left rear of the printer, waiting 5 seconds, and then turning it on again.) If the ready light does not come on, call your Printer Technical Representative.
2. Direct your commands to the Print Service context.
3. Type **Start Diagnostic** and press <RETURN>.
4. Type **Y** to the confirmation prompt and press <RETURN>.
5. Type the number corresponding to the command/status turnaround test and press <RETURN>. This starts the diagnostic program that tests the server, the interface cable, and the printer command status components. All other normal functions (queuing, printing, and so forth) are preempted while the diagnostic program runs. The printer maintenance panel displays Lb while the test is running.

```
PS> Start DiagnosticRETURN
Please confirm (Y/N): YRETURN
Select From...
1 Exit
2 Command/Status Turnaround Test
3 Image Test
4 Display Tech Rep Log
5 Print Tech Rep Log
6 Reset Tech Rep Log
Enter choice number: 2RETURN
Command/Status Turnaround Test.. Working
```

Command/status test example

Command/status test messages:

```
Command/Status Turnaround Test..Working
                                     or
Command/Status Turnaround Test..Failing!
```

If the the test completes successfully but the P4 error code persists, call the Network Support Center.

If the test indicates a failure, call your Printer Technical Representative.

### Display Tech Rep Log

---

The "Display Tech Rep Log" option enables the System Administrator or the technical representative to display the log of print engine interface data and jam (misfeed) rates. The data is accumulated since the last time the tech rep log was reset.

```
PS> Start DiagnosticRETURN
Please confirm (Y/N): YRETURN
Select From..
1  Exit
2  Command/Status Turnaround Test
3  Image Test
4  Display Tech Rep Log
5  Print Tech Rep Log
6  Reset Tech Rep Log
Enter choice number: 4RETURN
```



The following data is displayed:

```
XEROX NS 8000 Laser CP Tech Rep Log Of February 1, 85
13:32:24
Host # 2-852-126-727
Software Of 24-Oct-85 15:22:51
IOT Firmware Revision # 14
Last Reset On 13-Sep-85 8:17:43
11287 Total Feeds (Since Last Reset)
```

```
++ Jam Counters ++          Total      Rate *
C4 - No paper:.....6.....0
E2 - Preregistration Jam:.....6.....0
E3 - Pre Exit Jam:.....2.....0
E4 - Post Exit Jam:.....11.....0
* Rate = (Total/Total Feeds)*1000
```

```
++ Command Counters ++
Feed: 11361
Solicit status: 137166
Beep: 0
Solicit paper size: 77
Enter loopback mode: 1
```

```
++ Status Counters ++
Page sync: 11187
Ready to feed: 11245
Page at output tray: 11228
Feed rejected: 905
No toner: 1
Clam shell open: 32
Feed tray not engaged: 105
Diagnostic mode: 230
Call for service: 0
Copy mode: 1
```

NS 8000 Laser CP Tech Rep Log example (page 1)

```
Paper letter: 237
Paper A4: 0
Paper 215X330: 0
Paper legal: 3
Paper envelope 10: 0
Paper envelope RX: 0
Key off line: 29
Key reset: 2
Key last page: 1
Diagnostic (36-41): 0
Diagnostic 42 Print Alignment Pattern: 11
Diagnostic 43 Print Tech Rep Log: 4
Diagnostic 44 Image Test: 1
Diagnostic 45: 0
Diagnostic 46: 0
Diagnostic 47 LoopbackTest: 2
Stop diagnostic: 16
Soft reset: 0
Parity error: 11
Status error: 11
No status: 2
Status overrun: 0
Undefined status: 0

++ Plate Status Counters ++
Band overrun: 1
Page sync miss: 20

++ Status Extras Counters ++
Image fault 1: 0
Image fault 2: 0
Sequence fault: 0
Command/status communication fault: 11
PSI
```

**NS 8000 Laser CP Tech Rep Log example (page 2)**

---

## Print Tech Rep Log

---

The "Print Tech Rep Log" option enables the System Administrator or the Technical Representative to print the log of print engine interface data and jam (misfeed) rates. The data is accumulated since the last time the tech rep log was reset.

```
PS> Start DiagnosticRETURN
Please confirm (Y/N): YRETURN
Select From...
1 Exit
2 Command/Status Turnaround Test
3 Image Test
4 Display Tech Rep Log
5 Print Tech Rep Log
6 Reset Tech Rep Log
Enter choice number: 5RETURN
PS>
```

---

## Reset Tech Rep Log

---

The "Reset Tech Rep Log" option enables the System Administrator or the Technical Representative to reset the previously accumulated print engine interface data and jam rates. This should only be performed after major printer repairs or printer replacement.

**Note:** Use this command only under the direction of your Xerox Technical Representative.

```
PS> Start DiagnosticRETURN
Please confirm (Y/N): YRETURN
Select From...
1 Exit
2 Command/Status Turnaround Test
3 Image Test
4 Display Tech Rep Log
5 Print Tech Rep Log
6 Reset Tech Rep Log
Enter choice number: 6RETURN
Please confirm (Y/N): YRETURN
PS>
```

## Checking printer image alignment

You can check the NS 8000 Laser CP Electronic Printer image alignment using the **Print Test Pattern** command.

1. Direct your commands to the Print Service context.
2. Type **Print Test Pattern** and press <RETURN>.
3. Type the number corresponding to the "LaserCPAlignmentPattern.interpress" option and press <RETURN>.
4. Type **1** to the "Enter copy count (1-999)" prompt and press <RETURN>.

```

PS> Print Test Pattern
  1 CAM.interpress
  2 GreyDusting.interpress
  3 LaserCPAlignmentPattern.interpress
  4 LightDusting.interpress
Enter choice number: 3RETURN
Enter copy count (1-999): 1RETURN
Test Pattern queued for printing.
PS>

```

5. Check the copy of the alignment pattern for proper alignment. Fold the pattern in quarters and align the folded line to the cross marks corresponding to the paper size in the center of the page. If the alignment is incorrect, call your Printer Technical Representative.
6. If the printed copy has sawtooth edges, the server option board must be upgraded. You should call your Service Representative.

**Note:** For more information on image alignment as well as an illustration of sawtooth edges, refer to the "Printing a test pattern" section of the *NS 8000 Laser CP Operator's Guide*.

## Technical Representative repair mode

The Xerox Technical Representative may place the Print Service in repair mode from the printer control panel. The message "PS: \*\* Repair Mode entered." will be displayed. This mode allows the Printer Technical Representative to execute commands and print test patterns to verify operation of the printer.

**CAUTION:** The Print Service must be started in order to enter the repair mode. The server will crash if the **Stop Service** command is executed before entering the repair mode using the printer keypad. Printing and queuing can be either stopped or started. The **Start Diagnostic** command must not be used when the printer is in repair mode, or the server will crash.

## Safety notes

---

Your NS 8000 Laser CP Electronic Printer and supplies have been designed and tested to meet strict safety requirements. These include safety agency examination and approval, and compliance to established environmental standards. Attention to the following notes will ensure the continued safe operation of your equipment.

**WARNING: Improper connection of the NS 8000 Laser CP Electronic Printer grounding conductor can result in risk of electrical shock.**

- ALWAYS connect the NS 8000 Laser CP Electronic Printer to a properly grounded power source receptacle. If in doubt, have the receptacle checked by a qualified electrician.
- ALWAYS use materials and supplies specifically designated for your Xerox NS 8000 Laser CP Electronic Printer. Use of non-approved materials may result in poor performance and can create a hazardous situation.
- ALWAYS locate the NS 8000 Laser CP Electronic Printer on a solid support surface, with adequate strength for the weight of the machine.
- ALWAYS exercise care in moving or relocating the NS 8000 Laser CP Electronic Printer. Refer to the operator's manual for correct procedures in lifting and moving the unit.
- NEVER use a ground adapter plug to connect the NS 8000 Laser CP Electronic Printer to a power source receptacle that lacks a ground connection terminal.
- NEVER attempt any maintenance function that is not specifically described in the operator manual.
- NEVER remove any covers or guards that are fastened with screws. There are no operator-serviceable areas within these covers.
- NEVER override or "cheat" electrical or mechanical interlock devices.
- NEVER use supplies or cleaning materials for purposes other than intended. Keep all materials out of the reach of children.
- NEVER operate the NS 8000 Laser CP Electronic Printer if unusual noises or odors are noticed. Disconnect the power cord from the power source receptacle and call your Xerox Technical Representative to correct problem.

---

## Telecopier 495-1 Printer maintenance

---

This section contains maintenance procedures that you perform as needed for the Telecopier 495-1 option of the Print Service:

- Changing paper handling and transmission options
- Isolating equipment failures

Additional operation and maintenance procedures are provided in the *Telecopier 495-1 Terminal Operator Manual*.

**Note:** The Telecopier 495-1 Printer status is updated by the Print Service only once per minute.

---

### Changing paper handling and transmission options

---

The **Set Parameters** command is used to change paper handling and transmission options for Telecopier 495-1 facsimile printers. This command redisplay the selection menu until you type the number corresponding to the "Exit" option, or press <CTRL> and <C>.

1. Log on and enable in the Print Service context.
2. Type **Set Parameters** and press <RETURN>.
3. Type the number corresponding to the option desired from the following list and press <RETURN>.

The following options appear:

- **Transmission retries** - Sets the options for retrying failed document transmissions.

There are two categories of transmission failure:

- a. Those in which no phone connection is made (the number is busy or there is no answer).
- b. Those in which a phone connection was made but an error occurred during the transmission (transmit error or local FAX failure).

A specific number of retries and number of minutes between each retry may be chosen for each category of transmission failure.

- **Banner** - Defines when banner pages are printed for both the local and transmitted image. In each case, banner pages may be produced for every copy of a document, for every set of copies of a document, or not at all. The remote banner sheet option is normally suppressed to avoid the overhead phone cost (refer to the comment below).

- Multiple copies - Defines handling of multiple copies for both the local and transmitted image. In each case, multiple copies, when defined in the print request, can either be allowed or suppressed. Remote multiple copies are normally suppressed to avoid the overhead phone cost.
4. Type the number corresponding to the new option value desired or enter the requested information, and press <RETURN>.
  5. Type the number corresponding to the "Exit" option and press <RETURN> when you have changed all the desired options. Alternatively, you can press <CTRL> and <C>.

```

PS!Set ParametersRETURN
 1 Exit
 2 Transmission retries
 3 Banner
 4 Multiple copies
Enter choice number: 2RETURN
Retries in case of no connection (0..100): 5RETURN
Retry interval in minutes (1..100): 5RETURN
Retries in case of transmit error (0..100): 3RETURN
Retry interval in minutes (1..100): 3RETURN
Transmission retries (no connection) = 5, retry delay (minutes) = 5
Transmission retries (transmit error) = 3, retry delay (minutes) = 3
Select from
 1 Exit

```

6. Log off from the Print Service context.

**Comment:** The term "copy" refers to multiple copies of a document within a single job (print request). The term "set of copies" means a complete single job, whether or not multiple copies are requested.

## Isolating equipment failures

If you have an equipment failure, first check the Telecopier 495-1 to see if an error code is displayed. If a code is displayed, refer to the "Fault Code Displayed" section of the *Telecopier 495-1 Terminal Operator Manual*. If an error code is not displayed, execute the Self Test procedure described in the *Telecopier 495-1 Terminal Operator Manual*.

Use the **Start Diagnostic** command of the Print Service to test the RS-232 circuitry, to test communication from the server to the printer, and to set the internal clock for the telecopier 495-1. The following diagnostic tests can be performed:

- RS-232 loopback test
- Telecopier 495-1 internal self test
- Set Telecopier 495-1 clock to current time

## Recording paper jams

---

The major cause of failure in the Telecopier 495-1 printer is paper jams, caused by thermal paper glazing the drive roller. The drive roller is a black rubber roller located under the paper path cover at the front of the telecopier. To access the roller, press the paper path release button and lift up the paper. The roller should be cleaned with Xerox Clean Ups (43P67) on a regular basis, by wiping the roller from side to side, while rotating it with the green knob.

**Note:** Opening the Telecopier 495-1 cabinet may turn off the unit and result in a misleading status display at the Print Service console. The message "Offline. Please call the System Administrator to check power supply and RS-232C cable" is displayed. Typing the **Show Status** command displays the error message "Offline" rather than "Close Door."

## Performing the isolation test

---

The procedure for isolating a fault is designed for a direct connection between a Telecopier 495-1 and a Facsimile Print Service, where the switches (the shaded square indicates the active function of the switch, on or off) are set as shown in the example following step 1. The switches are located on the right rear of the Telecopier 495-1 as you face it.

To run the RS-232 test, use the switches on the back on the Telecopier 495-1. The switch settings simulate the loopback tool used by Xerox field personnel and enable you to perform fault isolation.

When moving switch positions in the following procedure, use a narrow but relatively blunt object, such as a small screwdriver or ballpoint pen (with the point retracted) to "slide" a single switch contact fully into position. The original switch settings, as well as the switch settings for the isolation test, are shown in the example. You must be able to get behind the telecopier to change the switches. Do not tilt the telecopier or try to bend over it to change the switches.

1. Set switches 1-1, 1-3, 1-5, 1-7, and 3-4 to the On position (see the example below for switch identification); and switches 2-3, 2-4, 2-5, 3-2, and 3-8 to the Off position.

**Note:** Only these switches need to be changed. The remaining switches should remain set as they are.



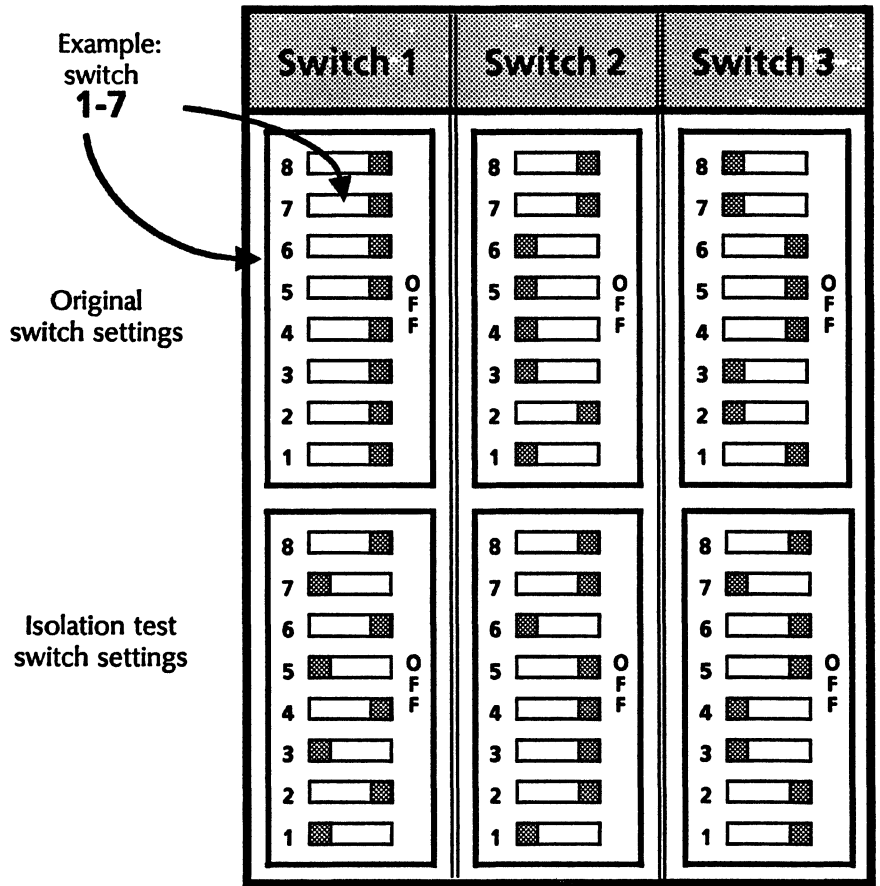

Telecopier 495-1 test switch settings

2. Run the RS-232 loopback test as indicated on the following page. If the test fails, refer to the listing of RS-232 loopback test failures which follows.
3. Observe whether the RS-232 test passes.
  - If the test passes, the problem is in the Telecopier 495-1. Call the Xerox Facsimile Technical Representative.
  - If the test fails, the problem is in the 8000 processor or the connection cable. Call the Xerox 8000 Technical Representative.
4. Reset the switches back to their original positions.

**Comment:** If problems persist after performing these procedures, call the Network Support Center.

```

PS> Start Diagnostic RETURN
Please Confirm (Y/N): Y RETURN
Select From . . .
1 Exit
2 RS232 loopback test
3 Telecopier 495-1 internal self test
4 Set Telecopier 495-1 clock to current time
Enter Choice Number: 2 RETURN
Configure for loopback and Type Y to Continue (Y/N): Y RETURN
RS232 loopback test . . . Passed
Repeat Test (Y/N): N RETURN
Configure for normal operation and type Y to continue (Y/N): Y RETURN
Select From . . .
1 Exit
2 RS232 loopback test
3 Telecopier 495-1 internal self test
4 Set Telecopier 495-1 clock to current time
Enter Choice Number: 1 RETURN
PS>
    
```

Possible RS-232 loopback test failures:

- RS232 loopback test...failed: RS232C DTR/DSR loopback error.  
The DTR/DSR loop was open. Data loopback was not tested.
- RS232 loopback test...failed: RS232C RTS/CTS loopback error.  
The RTS/CTS loop was open. Data loopback was not tested.
- RS232 loopback test...failed: RS232C DTR/DSR and RTS/CTS loopback error.  
Both the DTR/DSR and RTS/CTS loops were open. Data loopback was not tested.
- RS232 loopback test...failed: No data loopback.  
The DTR/DSR and RTS/CTS loops passed, data loopback did not occur.
- RS232 loopback test...failed: Data loopback incomplete.  
The DTR/DSR and RTS/CTS loops passed, some loopback data was not received.
- RS232 loopback test...failed: Data loopback compare error.  
The DTR/DSR and RTS/CTS loops passed, the received loopback data was incorrect.

## Telecopier 495-1 internal self test

This selection of the **Start Diagnostic** command is used to run part of the Telecopier 495-1 internal self test. The entire self test may be run by pressing **<Stop>** and **Light Original/Test** simultaneously on the Telecopier 495-1.

**Note:** Make sure that the machine is not in use before running these tests.

It takes approximately 60 seconds to run this test:

```
PS> Start DiagnosticRETURN
Please confirm (Y/N): YRETURN
Select From. . .
1 Exit
2 RS232C loopback test
3 Telecopier 495-1 internal self test
4 Set Telecopier 495-1 clock to current time
Enter Choice number: 3RETURN
Telecopier 495-1 internal self test. . . passed.
Select From. . .
1 Exit
2 RS232C loopback test
3 Telecopier 495-1 internal self test
4 Set Telecopier 495-1 clock to current time
Enter choice number: 1RETURN
PS>
```

Possible internal self test results are:

Telecopier 495-1 internal self test...passed.

Telecopier 495-1 internal self test...failed: No RS232C hardware.

RS232C hardware is not installed on the server. (Possible internal software problem.)

Telecopier 495-1 internal self test...failed: RS232C line number invalid.

Internal software problem.

Telecopier 495-1 internal self test...failed: RS232C line unavailable.

Another service is using the local RS232C port.

Telecopier 495-1 internal self test...failed: RS232C Communication error.

Telecopier 495-1 internal self test...failed: Telecopier not responding.

The Telecopier 495-1 is disconnected or powered off.

Telecopier 495-1 internal self test...failed: Unexpected Telecopier response.

Data received from the Telecopier 495-1 was inconsistent.

Telecopier 495-1 internal self test...failed: Telecopier retry time limit exceeded.

The time allowed for the command to execute was exceeded.Telecopier 495-1 internal self test...failed:

Telecopier response timeout.

The Telecopier 495-1 did not respond.

Telecopier 495-1 internal self test...failed: Telecopier in-job waiting timeout.

The Telecopier 495-1 is in use.

Telecopier 495-1 internal self test...failed: (Telecopier error) Fault: F421.

The Telecopier 495-1 fault code is displayed. (Look up the fault code in the *Telecopier 495-1 Terminal Operator Manual*.)

Telecopier 495-1 internal self test...failed: (Telecopier error) No paper.

Telecopier 495-1 internal self test...failed: (Telecopier error) Paper jam.

Telecopier 495-1 internal self test...failed: (Telecopier error) Off hook.

The Telecopier 495-1 cannot get a dial tone on the connected phone line.

Telecopier 495-1 internal self test...failed: (Telecopier error) Remote no answer.

This failure is indicative of internal Telecopier 495-1 problems.

Telecopier 495-1 internal self test...failed: (Telecopier error) Remote busy.

This failure is indicative of internal Telecopier 495-1 problems.

Telecopier 495-1 internal self test...failed: (Telecopier error) Tone detected.

The Telecopier 495-1 detected interrupt tones on the phone line. This failure is indicative of internal Telecopier 495-1 problems.

Telecopier 495-1 internal self test...failed: (Telecopier error) Diagnostic fault.

The Telecopier 495-1 detected an internal error. Follow the procedure displayed in the *Telecopier 495-1 Terminal Operator Manual*.

### **Set Telecopier 495-1 clock to current time**

---

This selection of the **Start Diagnostic** command sets the internal clock of the Telecopier 495-1 to the server's current time, displaying the set time. The possible error results of this selection are the same as for the Telecopier 495-1 internal self test.

```

PS> Start Diagnostic RETURN
Please Confirm (Y/N): Y RETURN
Select From...
1 Exit
2 RS232 loopback test
3 Telecopier 495-1 internal self test
4 Set Telecopier 495-1 clock to current time
Enter Choice number: 4 RETURN

Set Telecopier 495-1 clock... done. Time set to 23-Aug-85 15:27.
Select From...
1 Exit
2 RS232 loopback test
3 Telecopier 495-1 internal self test
4 Set Telecopier 495-1 clock to current time
Enter choice number: 1 RETURN
PS>

```

### Printing a print test pattern

You may occasionally wish to print a test pattern to verify that the Print Service and the Telecopier 495-1 are operational.

1. Direct your commands to the Print Service context.
2. Type **Print Test Pattern** and press <RETURN>.
3. Type the number corresponding to the desired test pattern and press <RETURN>.
4. Type **1** (or more) to the "Enter copy count (1-999)" prompt and press <RETURN>.
5. Type the number corresponding to the desired paper size, if prompted, and press <RETURN>.
6. Type **Y** to the "Local print?" prompt, if you want to print a test pattern on the local Telecopier 495-1, and press <RETURN>. Otherwise, type **N** and go to step 7.
7. Type **Y** to the "Remote print?" prompt, if you want to transmit a test pattern to a remote facsimile device, and press <RETURN>. Otherwise, type **N** and go to step 9.
8. Enter the telephone number of the remote facsimile device and press <RETURN>. Generally, you will choose a facsimile device that you know is functional, so you can tell whether the Telecopier 495-1 is able to transmit successfully.

9. Observe the test document.

- If the test pattern printed successfully, recheck for the original problem (if any).
- If the test pattern printed, but was of poor print quality, call the Xerox Facsimile Technical Representative.
- If the test pattern did not print, refer to the *Telecopier 495-1 Terminal Operator Manual* for further instructions on diagnosing equipment failures.

## Formatting Print Service maintenance

---

This section contains the maintenance tasks which should be performed as needed for the Formatting Print Service option of the Print Service:

- Changing the Target Print Service
- Updating paper handling options
- Responding to forwarding errors

### Changing the Target Print Service

---

The association of the FPS with the Target Print Service is retained across system restarts.

You can change the Target Print Service at any time using the **Set Target Print Service** command. After the change, all documents are sent to the new Target Print Service, including those already in progress when the change was made.

To change the Target Print Service:

1. Log on and enable in the Print Service context.
2. Type **Set Target Print Service** and press <RETURN>.
3. Enter the Clearinghouse name or network address of the 9700/8700 Electronic Printing System and press <RETURN>. If you enter the Clearinghouse name, the FPS looks up the network address.
  - a. A Clearinghouse name should contain local, domain, and organization names, separated by colons. If you do not specify the domain and/or organization, the domain and/or organization names of the Formatting Print Service are used.
  - b. The network addresses can be entered in decimal, octal, or hexadecimal notation. Examples of the standard notation (network number).(host address). are as follows:
    - 1-345.64-128-241. in decimal notation. 1-345 is the network number and 64-128-241 is the host address, separated by a period.
    - 2501B.364502361B. in octal notation.
    - 541H.3D284F1H. in hexadecimal notation. The first digit of a hexadecimal number must be a numeral or a leading zero.

4. The message "Done" is displayed when the command completes. If a warning message is also displayed, saying that the Target Print Service is unavailable, use the **Query Target Print Service** command at a later time to get the correct parameter information from the Target Print Service.
5. Log off.

## Updating paper handling options

---

You can use the **Query Target Print Service** command to obtain the current Formatting Print Service paper handling options and operational status. The options include paper size and availability of stapling, and double-sided printing. Use the **Show Status** command to check the FPS option values without making a call to the Target Print Service. Use the **Query Target Print Service** command if the option values have changed from what is displayed for the **Show Status** command.

**Note:** If any paper handling options have been changed on the Target Print Service (9700), then you must go to the Formatting Print Service and perform the **Query Target Print Service** command. If you do not perform this command, the options for the Target Print Service will not be put into the FPS local database and the wrong printer options will be passed to the ViewPoint workstation printer icons.

Here is the procedure to obtain the current Target Print Service paper handling options.

1. Log on and enable in the Print Service context.
2. Type **Query Target Print Service** and press <RETURN> to obtain the paper handling parameters and status information for the 9700/8700 Electronic Printing System.

## Responding to forwarding errors

---

The Formatting Print Service automatically retries forwarding a document to the Target Print Service until the document is either accepted by the Target Print Service or canceled using the **Cancel Document** command. If the FPS fails in an attempt to forward a document, an error message is sent to active executives giving the reason for the failure. The Target Print Service or the communication path may be inoperative.

Occasionally, there may be a problem with a document which prevents it from being forwarded (for example, if the document is very large and will not fit on the disk of the Target Print Service).

**Note:** An FPS can be associated with only one Target Print Service.

Here is the procedure to respond to forwarding errors.

1. Make sure the Target Print Service is operational. Check the communication path between the Target Print Service and the FPS. (For instance, if there is an Internetwork Routing Service link between the Target Print Service and



the FPS, check to see if the link is up.) Use the Echo test available under the **Test** command to check the communication path. For information on the echo test, refer to the "Server on-line diagnostics" section of the *Basic Troubleshooting of Network Services* booklet.

2. Route documents to a different 9700/8700 Electronic Printing System by changing the Target Print Service. To change the Target Print Service, refer to the "Changing the Target Print Service" procedure.
3. The forwarding document may be canceled, especially if the error message indicates that a document problem is preventing forwarding. Here is the procedure to cancel the forwarding document:
  - a. Log on and enable in the Print Service context.
  - b. Type **Cancel Document** and press <RETURN>.
  - c. A menu of cancel options is displayed. Type the number corresponding to the forwarding document option and press <RETURN>.
  - d. Press <RETURN> to confirm the response.
  - e. Log off.

After the forwarding document has been canceled, the FPS attempts to forward the next document in the queue. If the next document will not forward, there may be a problem with the Target Print Service or the communication link.

4. If the Target Print Service will not be available for some time, you may want to stop processing at the FPS. This prevents the acceptance of new documents and stops the FPS from constantly trying to forward the current document.

Here is the procedure to stop processing:

- a. Log on and enable in the Print Service context.
  - b. Type **Stop** and press <RETURN>.
  - c. Enter the reason for stopping processing (for example, Target Print Service is down) and press <RETURN>.
  - d. Log off.
5. Here is the procedure to start processing:
    - a. Log on and enable in the Print Service context.
    - b. Type **Start** and press <RETURN>.
    - c. Press <RETURN> at the confirmation prompt.
    - d. Log off.

---

## Image gap reprinting

---

Occasionally, image gaps may occur in your printed copy from an 8040 Series Electronic Printer or an NS 8000 Laser CP Electronic Printer. Image gaps are blank strips running horizontally across the page on the 8040 Series printer, or vertically across the page on the NS 8000 Laser CP. This happens when image generation is unable to keep up with the speed of the printer while attempting to print extremely complex images/graphics.

If a server with at least 1.5 Mb of memory is used, image gaps can be corrected by enabling the image gap reprinting feature. When you enable this feature, reprint automatically occurs for any page containing image gaps. The reprint takes longer, because the image is created and stored on the server disk prior to printing. When this feature is enabled, the Print Service requires a large amount of memory, as well as a large amount of disk space (approximately 2600 pages), whether or not reprinting is underway. For this reason, you may not want to enable this feature if your Print Service is on a multi-function server or has limited disk space.

Sometimes when the image gap reprinting function is enabled, large or complex documents cannot be processed and the server will stop functioning (although it will not display the 915 maintenance panel code). Since the image gap reprinting feature reserves a large amount of the server's memory, the server may use all remaining memory and quit functioning when a large or complex document is processed.

In order for you to print the document, you must disable the image gap reprinting feature, complete normal initialization of the Print Service, and resend the document.

**Note:** The image gap reprinting feature is always in the disabled mode until it has been enabled by the user.

Use the following procedure for enabling or disabling the image gap reprinting feature:

1. Reboot the server.
2. Type **N** to the "Normal Startup?" prompt and press <RETURN>.
3. Type the number corresponding to the "Interrupt before running Services" option and press <RETURN>.
4. Log on and enable in the Print Service context.
5. Type **Run Service** and press <RETURN>. A list of the services on the server is now displayed.
6. Type the number corresponding to the Print Service and press <RETURN>.
7. Type **N** to the "PS>Normal Startup?" prompt and press <RETURN>.

8. Type the number corresponding to the "Change configuration" prompt and press <RETURN>.
9. Type the number corresponding to the printing option desired and press <RETURN>.
10. Type the number corresponding to the printer version desired (8040 Series only) and press <RETURN>.
11. Type Y and press <RETURN> to enable image gap reprinting, or type N and press <RETURN> to disable it. See the following example:

```

!Run ServiceRETURN
  Select choices
  1 Print Service
  Enter one or more choices: 1RETURN
  PS: Normal Startup? (Y/N): NRETURN
Running Print Service
  Specify non-normal startup options
  1 Change configuration
  2 Stop queuing and printing
  3 Delete backing files
  Enter one or more choices: 1RETURN
  Specify printing option
  1 8040 Series Electronic Printer
  2 NS 8000 Laser CP Electronic Printer
  3 Model-35 Electronic Printer
  4 XP-9 Electronic Printer
  5 Telecopier 495-1
  6 Formatting Printer Service
  Enter choice number: 1RETURN
  Specify printer version
  1 B1
  2 B2
  Enter choice number: 2RETURN
  Enable image gap reprinting: (Y/N): YRETURN

Print Service run.
!

```

*(This page intentionally blank)*

This section contains an alphabetical listing of the messages that might display for the Print Service. Each message is followed by a brief explanation as to the probable cause and the suggested action pertinent to the message.

For the 8040 Series Electronic Printer, the NS 8000 Laser CP Electronic Printer, and the Telecopier 495-1 printing options, messages detailing problems encountered while processing a document are printed on the document's banner sheet.

For the Formatting Print Service (FPS), errors which prevent a document from being printed are reported on a job termination summary. The job termination summary is sent to the Target Print Service.

The messages described in this section are grouped as follows:

- Generic status messages
- 8040 Series Electronic Printer status messages
- NS 8000 Laser CP Electronic Printer status messages
- Telecopier 495-1 Printer status messages
- Formatting Print Service status messages
- Document status messages
- Job termination summary identification messages
- Document identification banner messages
- Document appearance warning banner messages
- Document error banner messages

When you see an error or informational message that you do not understand or want additional information about, write it down. Then, look it up in the Print Service message list. If the listing does not provide the information you are looking for, contact the Network Support Center.

**Note:** Banner messages, such as "Character [357B, 60B] Is Not in Font 'Modern'," can be referenced in the *Xerox Character Encoding Standard*.

---

## Generic status messages

---

### Cannot run Print Service now.

---

**Probable cause:** The Print Service cannot be run for some reason. This message should be followed by another message, indicating the specific problem and the action required.

**Action:** Respond as directed by this message.

### Cannot run Print Service. No Print Service printing option software installed.

---

**Probable cause:** None of the optional printing option software was available on the volume when the Print Service was run. There is a software module (a bcd file) for each printing option the Print Service supports.

**Action:** Software must be installed on the server for at least one printing option or the Print Service cannot run. This error message will not occur if the Print Service floppy is installed properly.

### Cannot run Print Service. No Print Service printing option software installed for the currently enabled software options.

---

**Probable cause:** Even though printing option software was found on the volume, none of the printing options supported by the available software are currently enabled software options.

**Action:** To run the Print Service, enable the printing option(s) supported by the software that is already installed. Or install software for at least one of the printing options which is a currently enabled software option. This error message will not occur if the Print Service floppy is installed properly.

### Cannot run Print Service. No Print Service software options enabled.

---

**Probable cause:** None of the Print Service software options have been enabled. There is a software option corresponding to each Print Service printing option.

**Action:** Software options may be set using the Set Software Options command.

---

**Cannot run Print Service.  
Required memory already allocated to another incompatible function.**

---

**Probable cause:** The Print Service cannot run after the Multiport Option has already reserved memory. The Print Service is incompatible with the Multiport Option. It cannot co-reside on the same server because both options reserve the same special area of memory.

**Action:** Expunge the Print Service and install it on a different server. An alternative is to enter **Delete File** and to specify MultiportSDF.BCD to be deleted. The alternative of deleting the Multiport file only makes sense if the option has been installed accidentally on a server which does not have the Multiport hardware and special System Software for Multiport.

---

**Required memory is not available.  
Please activate Print Service and reboot server.**

---

**Probable cause:** The Print Service could not run because it needs a large amount of real memory which is no longer available. This happens when the Print Service is not activated and the user tries to run it after a normal server startup.

**Action:** Activate the Print Service and reboot the server.

---

## 8040 Series Electronic Printer status messages

---

---

### **\*\*Default Font Missing! 'Install Fonts' and 'Start Printing' to continue.**

---

**Probable cause:** An attempt has been made to format a document which requires the default font, but the default font cannot be found on the disk. Typically, this occurs when a document is sent to the Print Service before any fonts have been installed. Printing has been stopped.

**Action:** The user should install the Modern Font from the Xerox Modern Fonts floppy (or from the Xerox Required Fonts floppy which contains only 12 point fonts). After installing the font file, enter the **Start Printing** command.

---

### **\*\*Print Engine Failure, 'Start Printing' to continue.**

---

**Probable cause:** An image fault has been detected while printing. Printing has been stopped to prevent repeated failures. Preceding this message, L2 error messages will be displayed on the screen and on the printer display. Sometimes the error messages are followed by "\*\*\*Status = Okay." The **Show Status** command may also indicate "Status: Okay." This is because the printer does not remember these errors and the software relies on getting the current status from the printer.

**Action:** The System Administrator or Technical Representative should run an image test using the **Start Diagnostic** command. The results of this test should then be reported to a field service dispatcher. (Refer to the "Maintaining your Print Service" section.)

---

### **\*\*Printer status = C4 - Please check paper cassette.**

---

**Probable cause:** The paper cassette may be empty.

**Action:** Add paper if needed. If paper cassette is not empty, check to see if the rollers need to be cleaned.

- \*\*Printer status = C3 - Please check paper handle.**
  - \*\*Printer status = E2 - Please clear paper path.**
  - \*\*Printer status = E3 - Please clear paper path.**
  - \*\*Printer status = E4 - Please empty output tray.**
  - \*\*Printer status = E5 - Please close door.**
  - \*\*Printer status = F5 - Please empty stacker tray.**
  - \*\*Printer status = J1 - Please add dry imager.**
- 

**Probable cause:** Informative messages.

**Action:** Respond as directed by these messages.



---

**\*\*Printer status = L1 - Warming, please wait.**

---

**Probable cause:** The fuser is warming up.

**Action:** If this message persists longer than 6 minutes, the printer needs repair.

---

**\*\*Printer status = L2 - Please call System Administrator.**

---

**Probable cause:** There has been an image fault. The server processor is not receiving the video clock or line-sync signals from the printer. This may be due to a printer problem, a cable problem, or a problem within the server processor.

**Action:** The System Administrator or Technical Representative should run an image test using the **Start Diagnostic** command. The results of this test should then be reported to a field service dispatcher. (Refer to the "Maintaining your Print Service" section.)

---

**\*\*Printer status = L4 - Please call System Administrator.**

---

**Probable cause:** There has been a command status fault. The Print Service is unable to communicate with the printer. The server processor is not detecting correct status signals from the printer in response to commands sent to the printer. This may be due to a printer problem, a cable problem, or a problem with the server processor.

**Action:** Ensure that the printer is powered on. Check the cable connection between the printer and the server processor. If the problem persists, call the Network Support Center.

---

**\*\*Printer status = Low power mode.**

---

**Probable cause:** Power consumption is being reduced; subsequent printing will require a warm-up (L1) period.

**Action:** The printer will enter into full power mode automatically when a printing job is initiated, or you may execute the **Wakeup Printer** command. (Warm-up time is approximately 6 minutes.)

---

**\*\*Printer status = Off line - Press on line key.**

---

**Probable cause:** Informative messages.

**Action:** Respond as directed by these messages.

---

**\*\*Printer status = Okay.**

---

Informative message. No action is required.

---

**\*\*Repair Mode entered.  
\*\*Repair Mode exited.**

---

Informative messages. No action is required.

---

## NS 8000 Laser CP Electronic Printer status messages

---

---

**\*\*Printer status = A1 - Please clear document feeder.**

---

**Probable cause:** An original was misfed while being copied.

**Action:** Lift the document feeder and remove the original. Then close the document feeder and reinsert the original.

---

**\*\*Printer status = C3 - Please check paper cassette.**

---

**Probable cause:** The paper cassette is not inserted properly.

**Action:** Push the paper cassette in all the way.

---

**\*\*Printer status = C4 - Please add paper.**

---

**Probable cause:** The paper cassette is out of paper.

**Action:** Respond as directed by this message.

**\*\*Printer status = E1 - Please clear paper path.**

**\*\*Printer status = E2 - Please clear paper path.**

**\*\*Printer status = E3 - Please clear paper path.**

**\*\*Printer status = E4 - Please clear paper path.**

---

**Probable cause:** A paper path misfeed has been detected.

**Action:** Open paper path and clear misfed paper.

---

**\*\*Printer status = E5 - Please close paper path.**

---

**Probable cause:** The paper path is open.

**Action:** Push down on the upper front corners of the Laser CP to close the paper path.

---

**\*\*Printer status = Offline - Press offline key again to resume.**

---

**Probable cause:** Informative message.

**Action:** Respond as directed by this message.

---

**\*\*Printer status = Okay.**

---

This is an informative message. No action is required.

---

**\*\*Printer status = P1 - Image fault, please call System Administrator.**

---

**Probable cause:** There has been an image fault. The server processor is not receiving the video clock or line-sync signals from the printer. This may be due to a printer problem, a cable problem, or a problem within the server processor.

**Action:** The **Start Diagnostic** command can be used to further troubleshoot the problem. For information on the **Start Diagnostic** command, refer to the "Maintaining your Print Service" section.

---

**\*\*Printer status = P2 - Image fault, please call System Administrator.**

---

**Probable cause:** There has been an image fault. The server processor is not receiving the video clock or line-sync signals from the printer. This may be due to a printer problem, a cable problem, or a problem within the server processor.

**Action:** The **Start Diagnostic** command can be used to troubleshoot the problem. For information on the **Start Diagnostic** command, refer to the "Maintaining your Print Service" section.

---

**\*\*Printer status = P4 - Communication fault, please call System Administrator.**

---

**Probable cause:** The Print Service is unable to communicate with the printer. The server processor is not detecting correct status signals from the printer in response to commands sent to the printer. This may be due to a printer problem, a cable problem, or a problem with the server processor.

**Action:** Make sure that the printer is powered on. Check the cable connection between the server processor and the printer. Reboot the printer by switching the power off, then on. Start printing. If this status recurs, call your Xerox Printer Technical Representative.

---

**\*\*Printer status = P5 - Sequence fault, please call System Administrator.**

---

**Probable cause:** This message indicates that the Print Service detected an unrecoverable error in the NS 8000 Laser CP Electronic Printer command/status sequence.

**Action:** Reboot the printer by switching the power off, then on. Start printing. If this status recurs, call your Xerox Printer Technical Representative.

---

**\*\*Printer status = Please add dry imager.**

---

**Probable cause:** The level of dry imager is too low.

**Action:** Follow the directions for adding dry imager that are printed on the dry imager hopper cover of the Laser CP. Then, press the Off-line switch to place the printer on line.

**\*\*Printer status = Printer in copy mode, please wait.**

---

**Probable cause:** This message means that the printer is currently being used as a convenience copier.

**Action:** No action is required. Please wait until the printer has completed the copy process.

**\*\*Printer status = Printer in repair mode, queuing and printing have been stopped.**

---

**Probable cause:** Print Service operation is suspended while the printer hardware is being worked on.

**Action:** Repair mode is entered by booting the server with the printer cover removed. Queuing and printing are preempted. Reboot with the printer cover installed to exit repair mode.

**\*\*Printer status = Printer needs service - Please call System Administrator.**

---

**Probable cause:** This message indicates a printer hardware error.

**Action:** The printer display code should be noted to help locate the type of problem. Call your Xerox Printer Technical Representative.

**\*\*Rotating fonts for the NS 8000 Laser CP Electronic Printer...**

---

**Probable cause:** This message is displayed at the beginning of font rotation. After fonts are installed, they must be rotated before they can be used by the NS 8000 Laser CP Electronic Printer.

**Action:** No action is required. Font rotation is done automatically when the Print Service is initialized (if unrotated fonts are found on the volume) and when you enter the **Start Printing** command at the end of the font installation sequence.

**\*\*Rotating (x)...**

---

Informative message appears for each font file rotated. The name of the file currently being rotated (x) is displayed. No action is required.

**\*\*Rotation error: Insufficient volume space.**

---

**Probable cause:** Font rotation could not be performed because the server ran out of disk space.

**Action:** Provide free space equal to twice the size of the font file being rotated. Some fonts may have already been rotated successfully. Any fonts left unrotated because of errors are rotated as needed when referenced by a document. This takes more time than rotating the fonts in advance, but the printed output will be the same.

**\*\*Rotation error: Unknown.**

---

**Probable cause:** An unexpected error occurred during font rotation.

**Action:** Report this error to your Xerox Printer Technical Representative. Some fonts may have already been rotated successfully. Any fonts left unrotated because of errors are rotated as needed when referenced by a document. This takes more time than rotating the fonts in advance, but the printed output will be the same.

**\*\*Rotation of (n) font files completed.**

---

Informative message is displayed at the completion of font rotation. The number of font files rotated (n) is displayed. No action is required.

---

## Telecopier 495-1 Printer status messages

---

**\*\*Printer status = Fax error, please call System Administrator.**

---

**Probable cause:** Some abnormality occurred while the server was communicating with the Telecopier 495-1.

**Action:** Run the Telecopier 495-1 internal self test. If the test fails, run the RS-232 loopback test. (Refer to the "Internal self test" and "Performing the isolation test" procedures in the "Maintaining your Print Service" section of this booklet. If the FAX error persists, contact your service representative.

**\*\*Printer status = Fax in use.**

---

Informative message indicating that the Telecopier 495-1 is busy receiving a transmission from or sending to another facsimile device. No action is required.

**Note:** The status of the Telecopier 495-1 is updated once per minute.

**\*\*Printer status = Off line, please call System Administrator to check power supply and RS232 cable.**

---

**Probable cause:** The Print Service cannot communicate with the Telecopier 495-1.

**Action:** Make sure the paper receptacle is closed. If any part of the Telecopier 495-1 is open, the device automatically shuts off. Check that the device is powered on and make sure there is a proper connection to the RS-232C link.

**\*\*Printer status = Okay.**

---

Informative message. No action is required.

**\*\*Printer status = Please clear paper path.**

**\*\*Printer status = Please place telephone receiver on hook.**

---

**Probable cause:** Informative messages.

**Action:** Respond as indicated by these messages.

**\*\*Printer status = RS232 communication line number provided by clearinghouse server is incorrect, please call System Administrator.**

---

**Probable cause:** Unknown. This status is never expected to occur.

**Action:** Respond as indicated by this message.

---

**\*\*Printer status = RS232 communication line number provided by clearinghouse server is not available, please call System Administrator.**

---

**Probable cause:** The External Communications Service (ECS) or other communications service is attempting to use the local RS-232C port.

**Action:** The Telecopier 495-1 printing option is not compatible with any of the communications services. Remove all communications services from a server running the Print Service Telecopier 495-1 option.

---

**\*\*Printer status = RS232C hardware error, please call System Administrator.**

---

**Probable cause:** The RS-232C communication hardware or software is not working as expected.

**Action:** Contact your service representative.

---

## Formatting Print Service status messages

---

### **\*\*Forwarding status = Connection error.**

---

**Probable cause:** An error occurred while establishing or maintaining a connection with the Target Print Service. FPS will keep trying to forward the document until it is queued at the Target Print Service or canceled at the FPS.

**Action:** Check the status of the Target Print Service.

### **\*\*Forwarding status = Document too large.**

### **\*\*Forwarding status = Insufficient space on Target Print Service.**

---

**Probable cause:** The Target Print Service will not accept the document because it is too large to be stored. FPS will keep trying to forward the document until it is queued at the Target Print Service or canceled at the FPS.

**Action:** If additional space can be freed by deleting font files or documents on the Target Print Service, the document may get forwarded. Otherwise, break the document into smaller pieces and resend them to the FPS.

### **\*\*Forwarding status = No network route to Target Print Service.**

---

**Probable cause:** The communication path between the FPS and the Target Print Service is inoperative. FPS will keep trying to forward the document until it is queued at the Target Print Service or canceled at the FPS.

**Action:** Check the IRS lines and Ethernet connections. If communication lines appear to be up, check that the FPS has the correct network address for the Target Print Service. (This procedure is detailed later in this section under the "Target Print Service unavailable" message.)

### **\*\*Forwarding status = Okay.**

---

Informative message indicating that a previous forwarding problem has been resolved. No action is required.

### **\*\*Forwarding status = Queuing disabled at Target Print Service.**

---

**Probable cause:** The Target Print Service cannot accept the document because queuing is disabled. FPS will keep trying to forward the document until it is queued at the Target Print Service or canceled at the FPS.

**Action:** Enable queuing at the Target Print Service.



---

**\*\*Forwarding status = Requested paper size unavailable.**

---

**Probable cause:** The paper size requested is not available at the Target Print Service. FPS will keep trying to forward the document until it is queued at the Target Print Service or canceled at the FPS.

**Action:** Load the desired paper size on the Target Print Service and then enter the Query Target Print Service at the FPS. If the desired paper size is not available, you must cancel the document and resend it, specifying a paper size which is available at the Target Print Service.

---

**\*\*Forwarding status = Target Print Service busy.**

---

**Probable cause:** The Target Print Service was too busy to receive the document. FPS will keep trying to forward the document until it is queued at the Target Print Service, or canceled at the FPS.

**Action:** No action is required. If the message continues, check the Target Print Service to be sure it is configured correctly.

---

**\*\*Forwarding status = Target Print Service not responding.**

---

**Probable cause:** The Target Print Service did not respond to the forwarding request. The Target Print Service may be inoperative. If the Target Print Service is a 9700/8700 Electronic Print Service, the Target Print Service may just be temporarily busy. (The 9700/ 8700 does not support multiple connections and does not respond to network requests when it is busy.) FPS will keep trying to forward the document until it is queued at the Target Print Service, or canceled at the FPS.

**Action:** If the Target Print Service is a 9700/8700, no action may be required. If it is not a 9700/8700, or if this message continues, check to be sure that the Target Print Service is operative.

---

**\*\*Forwarding status = Target Print Service queue full.**

---

**Probable cause:** The Target Print Service cannot accept the document because its queue is full. FPS will keep trying to forward the document until it is queued at the Target Print Service, or canceled at the FPS.

**Action:** No action is required. The FPS will continue to retry until the queue is no longer full.

**\*\*Forwarding status = Target Print Service unavailable.**

---

**Probable cause:** There is no Print Service available at the network address of the Target Print Service. FPS will keep trying to forward the document until it is queued at the Target Print Service, or canceled at the FPS.

**Action:** Check that the Target Print Service is ready to accept Ethernet traffic. Check the network number. If the Target Print Service appears operational, enter the **Query Target Print Service** command to see if the network address being used for the Target Print Service is correct. If it is not, make sure the correct address is entered in the Clearinghouse Service database.

If you change the address at the Clearinghouse Service, you must again specify the name of the Target Print Service with the **Set Target Print Service** command, so that the FPS looks up the new address. You may also enter the correct network address using the **Set Target Print Service** command. (You may wish to do this even if you change the address at the Clearinghouse Service, since the new address may take a while to propagate to all Clearinghouse Services on your network.) The "Changing the Target Print Service" procedure in the "Maintaining your Print Service" section explains the format for entering network addresses.

**\*\*Forwarding status = Transfer error.**

---

**Probable cause:** An error occurred during transfer of the document. FPS will keep trying to forward the document until it is queued at the Target Print Service, or canceled at the FPS.

**Action:** Check that the Target Print Service is operational and that IRS lines and Ethernet connections are up.

**\*\*Forwarding status = Transmission medium problem.**

---

**Probable cause:** There is a problem with the transmission medium hardware, the transmission medium is not available, or the transmission medium is not ready. FPS will keep trying to forward the document until it is queued at the Target Print Service or canceled at the FPS.

**Action:** Check the Ethernet connections.

**\*\*Forwarding status = Unknown problem.**

---

**Probable cause:** An unexpected error.

**Action:** FPS will keep trying to forward the document until it is queued at the Target Print Service, or canceled at the FPS.

---

## Document status messages

---

This section provides you with a list of normal and abnormal document status messages which might be displayed by the **List Documents** command.

### NORMAL STATUS:

#### **Being Formatted. Formatted.**

---

Informative message indicating that the document is being or has been formatted and is queued for printing. No action is required.

#### **Being forwarded.**

---

The document is being forwarded to the Target Print Service. If the document could not be forwarded on previous tries, the Print Service automatically tries again until the document is either accepted by the Target Print Service, or is canceled using the **Cancel Document** command. (The exact forwarding error is displayed asynchronously to all active Services Executives and as part of the **Show Status** command.) No action is required.

#### **Being printed. Printed.**

---

Informative message indicating that the document is being or has been printed. No action is required.

#### **Being Received.**

---

Informative message indicating that the document is being received and added to the queue. No action is required.

#### **Being transmitted. Transmitted.**

---

Informative message indicating that the document is being or has been transmitted to the remote facsimile device indicated by the phone number. No action is required.

#### **Busy-will retry.**

---

**Probable cause:** The document was not transmitted because the telephone for the remote facsimile device was busy.

**Action:** The transmission will be tried again later. No action is required.

#### **Forwarded.**

---

Informative message indicating that the document has been forwarded. The converted master was deleted from the server disk. No action is required.

**Local fax failure-will retry.**

---

**Probable cause:** The document was not transmitted because of a problem with the local Telecopier 495-1.

**Action:** The transmission will be tried again later. No action is required.

**No answer-will retry.**

---

**Probable cause:** The document was not transmitted because no remote facsimile device answered when the phone number was dialed.

**Action:** The transmission will be tried again later. No action is required.

**Queued.**

---

Informative message indicating that the document is awaiting processing. No action is required.

**Requeued.**

---

Informative message indicating that the document was requeued after being aborted for some reason (for example, the document was in progress when printing was stopped, or the document was in progress at system restart). No action is required.

**Transmit error-will retry.**

---

**Probable cause:** The document was not transmitted because of a communication error.

**Action:** No action is required. The transmission will be tried again later.

**ABNORMAL STATUS:**

**Busy.**

---

**Probable cause:** The document was not transmitted because the telephone for the remote facsimile device was busy.

**Action:** Try to send the document again.

**Canceled at printer.  
Canceled in formatter.  
Canceled in forwarder.  
Canceled in queue.**

---

Informative messages indicating that the document was canceled using the **Cancel Document** command. No action is required.

---

**Format failure.**

---

**Probable cause:** The document could not be converted from the transmission image to a print image. A banner sheet is usually produced.

**Action:** Check the banner sheet for possible cause of failure.

---

**Local fax failure.**

---

**Probable cause:** The document was not transmitted because of a problem with the local Telecopier 495-1.

**Action:** Try to send the document again. If this message continues, contact the Technical Representative.

---

**No answer.**

---

**Probable cause:** The document was not transmitted because no remote facsimile device answered when the phone number was dialed.

**Action:** Check the phone number and try to send the document again.

---

**Print failure.**

---

**Probable cause:** The document was formatted but could not be printed.

**Action:** Check the banner sheet for possible cause of failure.

---

**Purged from formatter.  
Purged from forwarder.  
Purged from printer.  
Purged from queue.  
Purged from receiving queue.**

---

**Probable cause:** The document was found in the queue at system restart and was automatically aborted. A banner sheet or job termination summary is usually produced. (The document is usually retried once before being aborted.)

**Action:** The document might be malformed. Contact your System Administrator or Technical Representative.

### **Queue failure.**

---

**Probable cause:** The document could not be queued for some reason. Typically this indicates that there is not enough free space on the server disk. It could also indicate that the workstation sending the document to the Print Service was interrupted (shut off while sending), or that the user specified a paper size which was not available at the Print Service. Check the workstation for an error message which might help determine the cause of the queue failure.

**Action:** If your document is very large, break it into smaller pieces. Print without the collation feature on ViewPoint. Make sure that the proper paper size is loaded at the Print Service.

### **Transmit error.**

---

**Probable cause:** The document was not transmitted because of a communication error.

**Action:** Try to send the document again.

---

## Job termination summary messages

---

The Formatting Print Service (FPS) printing option generally sends a job termination summary to the Target Print Service when the Print Service is unable to create an interleaved Interpress master. However, if an interleaved Interpress master could not be created due to insufficient space on the user volume, a job termination summary may not be created.

The job termination summary is in Interpress master form and describes the problem that kept the interleaved Interpress master from being created. The job termination summary identifies the document, the sender, the date and time of creation, the date and time of printing, and the Print Service.

The following information appears on every job termination summary.

For <name >

<document name >

Created <time >

Printed <time >

Xerox Print Service 10.0 on <Print Service Name >

Example:

For Jacks:Home Office:CCCB

Important Memo

Created 11-Jan-86 14:03:22

Printed 11-Jan-86 14:09:52

Xerox Print Service 10.0 on Concord

The following is a list of error messages that appear on the job termination summary when the FPS cannot create a converted master. Some errors indicate that limitations of the Print Service have been exceeded, while others indicate that the document is malformed.

**Master Error (page <number>): feature not implemented; <message>.**

---

<Message> is one of the following:

**Erroneous encoding of Interpress master  
Rotation not a multiple of 90 degrees  
Unimplemented operator  
Unimplemented variable type**

**Probable cause:** The document is malformed, beyond the Interpress subset supported, or otherwise unreadable by the formatter.

**Action:** Check the fonts at the Print Service to be sure they are loaded correctly.

**Master Error (page <number>): font problem; <message>.**

---

<Message> is one of the following:

**Malformed installed font  
Missing character  
Missing CS0 (Character Set 0)  
Unreasonable rotation  
Unreasonable translation**

**Probable cause:** The document is malformed, or beyond the Interpress subset supported, or the font file itself is damaged.

**Action:** Check the Print Service to be sure that the fonts were loaded correctly.

**Master Error (page <number>): logic error; <message>.**

---

<Message> is one of the following:

**Arithmetic overflow  
Bad initial data  
Bad raster area calculation  
Unexpected data  
Unexpected data or implementation error**

**Probable cause:** These messages indicate either arithmetic overflow, bad initial data, unexpected data, implementation error, or bad raster calculation.

**Action:** If the message indicates arithmetic overflow, bad initial data, unexpected data, or implementation error; reload the software onto the print service. If the message indicates bad raster area calculation, reload all the fonts.

**Master Error (page <number>): no resources; not enough disk space.**

---

**Probable cause:** The document requires more formatting space than is available.

**Action:** Split the document into smaller sections and try again.



---

**Master Error (page <number>): parse failure; <message>.**

---

<Message> is one of the following:

- Illegal command ordering**
- Malformed master**
- Missing font ID**
- No such command**
- Stack overflow**
- Stack type-error**
- Stack underflow**
- Unreasonable transformation**
- Unsupported file header**
- Unsupported page rotation**
- Unsupported page scale**
- Unsupported page translation**

**Probable cause:** The document is malformed or otherwise unreadable by the formatter.

**Action:** Check the document at your workstation.

---

**Master Error (page <number>): plate too complicated; <message>.**

---

<Message> is one of the following:

- Large image plus many fonts**
- Not enough disk space**
- Too many fonts**
- Too many greys**
- Too many inkwells (dark images)**
- Too much font space**

**Probable cause:** The specified page is too complex to format for printing.

**Action:** The page should be made less complex and tried again, or the document should be sent to a Print Service with more memory.

---

**Master Error (page <number>): too many plates.**

---

**Probable cause:** The document is too long to print.

**Action:** Split the document into smaller sections and try again.

**Summary Only: Document Not Printed because of <error>.**

---

<Error> is one of the following:

- Error**
- Error in processing interpress master**
- Forwarding error**
- Transmit error**

**Probable cause:** The document is malformed, beyond the Interpress subset supported, or could not be transmitted to the Target Print Service.

**Action:** Check the document at your workstation. It could be malformed. If the message is a transmit error, then you should try to send the document through FPS.

**Summary Only: job purged from <queue> at System Restart.**

---

<Queue> is one of the following:

- Communications Queue**
- Formatter**
- Forwarder**
- In-Process Queue**

**Probable cause:** The document was found in the Print Service queue and was not printed. The message may indicate that the document was malformed and caused the restart, because documents are usually retried once.

**Action:** Check the document at your workstation. It could be malformed.

---

## Document identification banner messages

---

The following are the normal messages that appear on the document banner sheet. They identify what the document is and who sent it to the Print Service. Note that the sender name, document name, and created time are supplied by the workstation via the printing protocol. If any of these three print attributes are NOT supplied, they will not appear on the banner sheet.

For <name >

<document name >

Created <time >

Printed <time >

<number > Sheet(s), 1 Copy.

(or)

<number > Sheet(s), <number > Copies.

Xerox Print Service 10.0 on <Printer Name >

Example:

For Jackson:Home Office:CCCB

Important Memo

Created 11-Jan-86 14:03:22

Printed 11-Jan-86 14:09:52

5 Sheet(s), 4 Copies.

Xerox Print Service 10.0 on Concord

---

## Document appearance warning banner messages

---

The following banner warnings indicate that the printed document may differ from the intended appearance. Most banner messages have submessages included in them; the position of the subfields is indicated in angle brackets as follows: **<in this font>**.

**Appearance Warning (page <number>): <message>**.

or

**Appearance Warning: font '<modern>' substituted for '<requested font name>'.**

The message accompanying the appearance warnings will attempt to describe the problem. Only the first appearance warning is printed on the banner sheet. Other warnings are indicated by:

... and <number> more

**Appearance Warning: font '<font name>' substituted for '<requested font name>'.**

or

**Appearance Warning: corresponding 'Modern<type>' substituted For '<requested font name>'.**

---

**Probable cause:** The requested font is not present on the Print Service. A default font (usually Modern) is substituted in the printed output.

**Action:** If the substituted font is acceptable, then no action is required. If the substituted font is not acceptable, then the missing font must be reloaded onto the Print Service.

**Character [<subset number>,<character code>] is not in font '<font name>'.**

---

Informative message indicating that the specified character is not printable. The subset number is the octal number of the character subset, and the character code is the octal character code. These codes can be used to look up the intended graphic in the Xerox character encoding tables. No action is required.

**Font '<font name>' does not contain <size> point characters.**

or

**'<font name>' does not contain <size> point (rotated <number-degrees> degrees) characters.**

---

**Probable cause:** Indicates that the specified character size is not printable. A black box substitution character is usually printed in its place.

**Action:** Check the document at your workstation.

**Note:** If this error message occurs for all point sizes except 12 point Modern, the Modern font from the Xerox Required Font floppy has been installed. If you have purchased Modern Fonts, you must reinstall the Modern Font from the Xerox Modern Fonts floppy (Modern Font floppy # 1).

---

**Image off paper at (x,y) inches, (x,y) cm.**

---

**Probable cause:** Indicates all of the image cannot be printed on the sheet. For all printing options except the Telecopier 495-1, location is measured from the lower left corner with the sheet in portrait position. For the Telecopier 495-1, location is measured from the lower left corner with the sheet in landscape position.

**Action:** Check the document banner sheet for possible error failures.

---

## Document error banner messages

---

One of the following document error messages appears on the banner sheet when the document cannot be printed at all. Some errors indicate that limitations of the Print Service have been exceeded, while others indicate that the document is malformed.

---

### **Banner Only: Document Not Printed because of <error>.**

---

<Error> is one of the following:

**Error**  
**Error in processing Interpress master**  
**Marking error**  
**Transmit error**

**Probable cause:** The document is malformed or otherwise unreadable by the formatter.

**Action:** Check the document at your workstation.

---

### **Banner Only: Job purged from <queue> at System Restart.**

---

<Queue> is one of the following:

**Communications Queue**  
**Formatter**  
**In-Process Queue**  
**Marker** (the word "marker" means "printer")

**Probable cause:** The document was found in the indicated queue on the Print Service when the system was restarted, but the document was not reprinted. The message may indicate that the document itself was malformed and caused the restart, because a document is usually retried once.

**Action:** Check the document at your workstation.

**CAUTION:** With regard to the <Marker> error message, in very unusual cases such as an address fault (in the backstop log), the Print Service might crash while attempting to print complex Interpress masters. Since all documents are retried once, the Print Service will probably crash again at the same place. To avoid further crashes, you must remove the text or graphics from the page being printed when the crash occurred.

---

**Master Error (page <number>): feature not implemented; <message>.**

---

<Message> is one of the following:

**Erroneous encoding of Interpress master  
Rotation not a multiple of 90 degrees  
Unimplemented operator  
Unimplemented variable type**

**Probable cause:** The document is malformed, beyond the Interpress subset supported, or otherwise unreadable by the formatter.

**Action:** Check the fonts at the Print Service to be sure they are loaded correctly.

---

**Master Error (page <number>): font problem; <message>.**

---

<Message> is one of the following:

**Malformed installed font  
Missing character  
Missing CS0 (Character Set 0)  
Unreasonable rotation  
Unreasonable translation**

**Probable cause:** The document is malformed, beyond the Interpress subset supported, or the font file itself is damaged.

**Action:** Check the Print Service to be sure that the fonts are loaded correctly.

---

**Master Error (page <number>): logic error; <message>.**

---

<Message> is one of the following:

**Arithmetic overflow  
Bad initial data  
Bad raster area calculation  
Unexpected data  
Unexpected data or implementation error**

**Probable cause:** These messages indicate either arithmetic overflow, bad initial data, bad raster calculation, unexpected data, or implementation error.

**Action:** If the message indicates arithmetic overflow or bad initial data, reload the software. If the message indicates bad raster calculation, reload all the fonts. If the message indicates unexpected data or implementation errors, the document may be malformed. Reload the software onto the Print Service.

---

**Master Error (page <number>): no resources; not enough disk space.**

---

**Probable cause:** The document requires more formatting space than is available.

**Action:** It may print if it is split into smaller pieces.

**Master Error (page <number>): parse failure; <message>.**

---

<Message> is one of the following:

- Illegal command ordering**
- Malformed master**
- Missing font ID**
- No such command**
- Stack overflow**
- Stack-type error**
- Stack underflow**
- Unreasonable transformation**
- Unsupported file header**
- Unsupported page rotation**
- Unsupported page scale**
- Unsupported page translation**

**Probable cause:** The document is malformed or otherwise unreadable by the formatter.

**Action:** Check the document at your workstation.

**Master Error (page <number>): plate too complicated; <message>.**

---

<Message> is one of the following:

- Too many fonts**
- Too many inkwells**

**Probable cause:** The specified page contains too many dark images.

**Action:** It should be made less complex and tried again.

<Message> is one of the following:

- Large image plus many fonts**
- Not enough disk space**
- Too many greys**
- Too much font space**

**Probable cause:** The specified page is too complex to format for printing.

**Action:** It should be made less complex and tried again.

**Master Error (page <number>): too many plates.**

---

**Probable cause:** The document is too long to print.

**Action:** It may print if it is split into smaller pieces.



- Asynchronous** Transmission of data in which time intervals between transmission are unequal. Transmission is sent a character at a time and is controlled by start and stop elements at the beginning and end of each character.
- Banner page** A page produced by the Print Service containing information about the associated print request. Also referred to as the **Break page**.
- Bit** A unit of data which can have the value of 0 or 1. These units are combined into 8-bit bytes; each byte equals one character.
- Boot** Activate the software on a server or workstation by pressing the hardware "boot button" (B RESET on the processor maintenance panel).
- Clearinghouse** A service that provides the naming facility for the other services and workstations on the internet. The Clearinghouse maintains a system-wide directory function that allows all the system components to locate needed resources and other registered objects.
- Clearinghouse database** The database is organized by domains, which consist of 200-300 users resident in the same geographical location. A domain can reside in multiple Clearinghouses, and each Clearinghouse can hold multiple domains. (See **Domain** for more information.)
- The specialized database held by the Clearinghouse Service that serves as a global directory for the entire internetwork.
- Clearinghouse Service** (**CHS**) A lookup directory service that maintains a database of all users, services, and servers in a network. The Clearinghouse Service cooperates to provide a single unified database system among other Clearinghouse Services.
- Complexity** A qualified measure of the difficulty of printing a single page or entire document as applied to the image defined in an Interpress master. Several factors enter into the determination of complexity, including the number of characters and fonts (families, sizes and orientations) referenced; the number of graphic operations; the levels allowing the overlaying of objects on a page used in producing the image; and the density of the image.
- Database** The permanent stored data.
- Decomposing** Interpreting the information in the Interpress document and referencing the fonts. Sometimes rotation, scaling, or conversion of fonts is done during this phase. Also referred to as **Formatting**.

- Domain** A logical grouping (usually geographical) of registered objects in the Clearinghouse database. Domains serve as units of name, scope, administrative responsibility, and replicated database configuration. The data maintained for a particular domain includes the list of administrators of that domain, plus the names and relevant information about all objects that are registered in the domain.
- Domain Administrator** The System Administrator-assigned access privileges to control the changes to entries within a given domain.
- Electronic printer** A method of transferring a digital image to the printing medium (usually plain paper). Xerographic laser printers produce pulses of light which are cast onto an electrically charged photoreceptor. These pulses are controlled by the digital image of the desired output. Just as in a xerographic copier, wherever the light strikes the photoreceptor, the electrical charge is neutralized. The photoreceptor is then passed through toner which is attached to the electrically charged areas. The resulting image is transferred to and fused onto the medium to produce the output copy. Also referred to as *Laser printer*.
- Ethernet** A high-speed local area network developed by Xerox that carries information to workstations and servers attached to the network.
- Executive** The program that supports interactive, text-based access to server functions. (The software that allows the user to observe the current activity of a server, or change its current configuration.) The "local executive" is provided at the server terminal. ViewPoint Remote System Administration provides users with a remote executive interface.
- Facsimile** (**FAX**) A system of communications in which a document, photograph, map, or other fixed graphic material is scanned. The information is converted into signal waves for transmission by wire or radio to a facsimile receiver at a remote point. Then the image is scanned at the transmitter, reconstructed at the receiving station, and duplicated onto paper.
- Floppy disk** A flexible, removable disk medium used for data storage and loading software onto the workstation and server.
- Font** Typographical design applied to a collection of letters and graphic symbols that share certain characteristics such as style, weight, and stress.
- Font rotation** The rotation of fonts to the required angle for printing a document.
- Font substitution** The use of another font in the place of the specified (and presumably unavailable) font. For the Print Service, the default substitution font is from the Modern family.
- Formatting** Interpreting the information in the Interpress master and referencing the fonts. Sometimes rotation, scaling, or conversion of fonts is done during this phase. It may also indicate special formatting done by the Formatting Print Service. Also referred to as *Decomposing*.

- Formatting Print Service** A service that provides printing of detailed graphics, equations and/or text on Xerox production printers. It converts Interpress masters containing Interpress vector graphics into the proper format for accurate printing on an 8700/9700 printer.
- Forwarder** A term describing the part of the Print Service which causes the transfer of the interleaved Interpress master to the Target Print Service.
- Genesis Mode** A state that a server enters when it cannot authenticate a user to enable System Administrator capabilities and server initialization when stopped at Interrupt 3. In this case, the user is enabled to access the limited set of System Administrator commands, necessary for making a Clearinghouse domain available. Genesis Mode occurs during the installation of the first server on a network, and on single-server networks after a non-normal server startup and interrupt points 2 or 3 have been taken.
- Image gaps** The blank strips running horizontally across a page of an 8040 Series printout, or vertically across a page of an NS 8000 Laser CP printout. This happens when image generation is unable to keep up with the speed of the printer while attempting to print extremely complex images/graphics.
- Initializing** A process completed after a service has been installed on a server for the first time. The initialization procedure includes determining the name of a service, and configuration information specific to that service.
- Interleaved Interpress master** An Interpress master which contains text elements and pixel arrays. It refers to the converted master produced by Print Service when it is configured as a Formatting Print Service.
- Interpress** A Xerox standard which defines the digital representation of files that are printed via the Print Service.
- Master** A file written according to the Xerox Interpress standard. It precisely describes the desired appearance of a page that has been completely composed by some other process. It is the Interpress master which, when executed by an Interpress Print Service, produces a printed image.
- Interpreted** A mode of file transfer used by the Remote Batch Service for interchanging documents. The Remote Batch Service translates documents from a format that it understands (Xerox 860) to a format more commonly understood by non-Xerox systems (EBCDIC DP or EBCDIC WP) before sending a document. It applies the reverse translation upon receiving a document.
- Interrupt points** Allow the user to change a value that the server applies during initialization. They are available after a non-normal server startup. During initialization, the possible interrupt points are:
- Interrupt before opening primary volume
  - Interrupt before processing profile
  - Interrupt before running services
- Refer to the "Non-normal server startup" section in the *Server Operation and Maintenance* booklet for further information.

<b>Laser printer</b>	A method of transferring a digital image to the printing medium (usually plain paper). Xerographic laser printers produce pulses of light which are cast onto an electrically charged photoreceptor. These pulses are controlled by the digital image of the desired output. Just as in a xerographic copier, wherever the light strikes the photoreceptor, the electrical charge is neutralized. The photoreceptor is then passed through toner which is attached to the electrically charged areas. The resulting image is transferred to and fused onto the medium to produce the output copy. Also referred to as <i>Electronic printer</i> .
<b>Logoff</b>	The process of stopping a session on a computer system.
<b>Logon</b>	The process of starting a session on a computer system.
<b>Main memory</b>	Usually the fastest storage device of a computer and the one from which instructions are executed.
<b>Malformed</b>	Structure does not conform to the expected format.
<b>Marker</b>	The part of the Print Service that causes the transfer of the image to the medium, as in placing marks on the paper. It is also referred to as the imaging subsystem.
<b>Medium</b>	The material to which the print engine transfers the image. For the 8040 Series Printer and the NS 8000 Laser CP, the medium is plain paper. For the Telecopier 495-1, the medium is a continuous roll of thermal recording paper.
<b>Multiport option</b>	The multiport option extends the local port to four ports. It can be configured for bit-synchronous communications (IRS, Clusternet, 3270 SNA, External Mail Gateway, and X.25). The multiport option is not compatible with the Print Service (i.e., it cannot run on the same server).
<b>Network</b>	The physical and logical connection of system elements. A network allows information exchange between workstations and servers.
<b>Network architecture</b>	The philosophy and organizational concept for enabling devices at multiple locations to communicate over common carrier transmission facilities. The network architecture specifies the processors, workstations, and terminals, and defines the protocols and software which must be used to accomplish accurate data communications.
<b>Organization</b>	A high-level logical grouping of domains in the Clearinghouse database (usually corresponding to an entire company or equivalent). Most internetworks contain only a single organization.
<b>Paper path</b>	The mechanical route of the paper media through a print engine. A paper path fault indicates a problem in that route, such as a paper jam.
<b>Password</b>	A required code in addition to a user's name or number that allows logon.
<b>Pathnames</b>	The means for specifying the route to objects that are nested within other objects.

- Pica** A unit of measurement equaling 12 points, or approximately 1/6 inch.
- Pitch** As applied to printing, it is a unit of measure applied to fonts which describes the number of characters per inch. A 10 pitch font means 10 characters per inch. Fixed pitch is a font property meaning that all of the similarly-sized characters in that font have the same width.
- Pixel** A small discrete element, a group of which constitutes an image. The 8040 Series Electronic Printer and the NS 8000 Laser CP Electronic Printer print 300 pixels per inch. The Telecopier 495-1 prints 200 pixels per inch.
- Point** As applied to printing, it is a unit of measure. One point is approximately 1/72 inch. Points are most often applied in describing the height or size of a set of characters within a font.
- Print device** The device that transfers the image to the medium. Also known as a **Print Engine**.
- Print Service** (**PS**) Provides the resource for obtaining printed output of documents to clients accessing the network.
- Printing option** Determines how the printed documents are produced by the Print Service. Each instance of the PS is configured to provide one printing option. Printing options are the 8040 Series Electronic Printer, the NS 8000 Laser CP Electronic Printer, the Telecopier 495-1, and the Formatting Print Service.
- Protocol** The formal set of conventions governing the format of data and controlling information exchange between two communicating devices.
- Queuing** The process of accepting and storing documents by the Print Service. Also referred to as **Spooling**.
- Reboot** Restarts the software loaded on the system element by pressing the "boot button" (B RESET on the processor maintenance panel).
- Remote access** Communication with a data processing facility through a data link.
- Resolution** The spots per inch (spi) that a printer is capable of producing when rendering an image. The resolution is 300 spi for the 8040 Series Electronic Printer and the NS 8000 Laser CP Electronic Printer. For the Telecopier 495-1, resolution is 200 spi. In general, the finer the resolution (the more spi), the better the quality of the printed image.
- Rigid disk** A hard disk medium used as the main storage device for software and data on the workstations and servers.
- RS-232C Port** The physical interface between some network citizens and the data communication equipment (usually a modem).
- Scan conversion** A term referring to the complete digitization of the image. A scan converted image consists entirely of binary ones and zeros, with each digit representing a pixel.

<b>Scan direction</b>	The description, in relationship to the medium, of the way the spots which make up the image are transferred to the medium. The fast scan direction is the orientation of the scan lines which are fed directly to the electro-mechanical imaging system. The slow scan direction is the direction that the fast scan lines move across the medium.
<b>Server</b>	A processor on which one or more services can run.
<b>Server profile</b>	The data file used to retain information such as names and assignments after initialization and configuration of servers and services is complete. This way, the user does not have to specify the information each time the server is booted.
<b>Service</b>	Software running on a server that performs a specific function, such as printing or filing.
<b>Services Executive</b>	The software that allows the user to observe the current activity of a server, or change its current configuration. See <i>Executive</i> for more information.
<b>Services System Software</b>	Provides an environment in which one or more of the Xerox 8000 Network System Services can operate.
<b>Spooling</b>	See <i>Queuing</i> .
<b>System Administrator</b>	A user with specific network privileges, responsible for setting up and maintaining the network services.
<b>Target Print Service</b>	The Print Service to which a Formatting Print Service sends the documents.
<b>Test patterns</b>	Interpress masters stored on the Print Service and printed to aid in troubleshooting the service, and judging and adjusting the print quality. Some print engines with noticeable tolerances in their paper path need an alignment pattern to aid in the adjustment of digital timing to coincide with the paper path.
<b>Transmission</b>	The sending of data to one or more locations or recipients.
<b>Virtual memory</b>	A mechanism (hardware and software) that provides the illusion of a large memory by combining a small memory with a large disk. This technique permits the user to treat secondary storage as an extension of main memory, thus giving the virtual appearance of a larger main memory.

**A**

- A4 paper 29, 43
- aborted
  - documents 39
  - failure messages 51, 62
- alignment, image
  - 8040 Series Electronic Printer 48–49
  - NS 8000 Laser CP Electronic Printer 68
  - stacking 47
- Audible alarm option 56
- Automatic Density Control 44

**B**

- B1 electronic printer 16, 47
- B2 electronic printer 16, 29, 46–47
  - audible alarm 56
  - checking dry imager 44
  - controlling power consumption 56
  - paper handling options 46–48
- banner page 29, 30, 32, 47, 70
  - changing option 60–61

**C**

- Cancel Document command 9, 80–81
- Changing paper handling options 46–48
- Changing the banner option 60–61
- Changing the printing option 21
- Changing the Target Print Service 79–80
- Checking paper handling and transmission options 70–71
- Checking printer image alignment
  - 8040 Series Electronic Printer 48–49
  - NS 8000 Laser CP Electronic Printer 68
- Checking printer operations 45–46
- Checking the dry imager 44–45, 59
- Chinese extended language fonts 27
- circuitry
  - RS-232 71
- Clearinghouse 16–19, 79
- Clearinghouse database 40
- codes
  - E2, E3, E4, or E5 status 45
  - J1 status 44
  - L1 status 42, 51, 56
  - L2 error 46, 49–51
  - L4 error 46, 51–52
  - P1, P2, or P3 error 61–63
  - P4 error 60, 63–64
- command/status test 63–64

**COMMANDS**

- Cancel Document 9, 80–81
- Delete Font 9, 38–39
- Delete Test Pattern 9
- Expunge Service 40
- Install From Floppy 9, 23
- List Documents 9
- List Fonts 10, 39
- List Test Patterns 10
- Print Test Pattern 10, 30–31, 48, 68, 77
- Query Target Print Service 10, 35, 80
- Rename Print Service 10
- Reset Statistics 10, 39–40
- Run Service 21–22, 82–83
- Set Banner 10, 30, 60
- Set Parameters 11, 46–48, 70–71
- Set Target Print Service 11, 35, 79
- Show Status 10, 11, 12, 29–30, 32, 35, 39–40, 60, 72, 80
- Shutdown Printer 11, 56
- Start 11, 81
- Start Diagnostic 12, 33, 49–55, 57, 61–67, 68, 71, 74–78
- Start Printing 11, 12, 24, 39
- Start Queuing 11, 12
- Stop 12, 81
- Stop Printing 12, 23, 38
- Stop Queuing 12
- Stop Service 10, 57, 68
- Test 81
- Wakeup Printer 13, 56
- Controlling power consumption on B2 electronic printers 56
- copies
  - prints too dark 45
  - prints too light 45
- CVT 1
- D**
- default, parameter settings 28, 32
- Delete Font command 9, 38–39
- Delete Test Pattern command 9
- Deleting fonts from your Print Service 38–39
- desktop, ViewPoint 35
- diagnostic tests 71, 73–77
- disk
  - floppy 23–26
- Display Tech Rep Log
  - 8040 Series Electronic Printer 52–54
  - NS 8000 Laser CP Electronic Printer 64–66

- Documents Aborted 39
- Documents Printed 39
- Documents Purged at Recovery 39
- domain 16–17, 19–20, 78
- dry imager
  - 8040 Series Electronic Printer 44–45
  - NS 8000 Laser CP Electronic Printer 59
- E**
- E2, E3, E4, and E5 status codes 45–46
- 8040 Series Electronic Printer 1–3
  - Image gap reprinting 82–83
  - initializing 16–17
  - loading fonts 25
  - maintenance 41–57
    - dry imager 44–45
    - L2 and L4 error codes 49–54
    - operation, print quality, paper jams 45–46
    - paper 43–44
    - paper handling options 46–48
    - power consumption on B2 electronic printers 56
    - printer image alignment 48–49
    - standard operation 26–28
- Establishing standard operation of your Print Service 28
- Establishing standard operation of the 8040 Series Electronic Printer 28–30
- Establishing standard operation of the Formatting Print Service 35
- Establishing standard operation of the NS 8000 Laser CP Electronic Printer 30–31
- Establishing standard operation of the Telecopier 495-1 Printer 31–34
- Executive 41
- Expunge Service** command 40
- Extended language fonts 27
- F**
- failures
  - Isolating equipment failures 71
    - internal self test 75–76
    - RS-232 loopback test 72–74
  - P1, P2, and P3 type failures 5, 61
    - image test 62–63
  - P4 type failures 63
    - command/status test 63–64
  - Queue Failures 37
  - transmission failure 70
- floppy disk
  - loading fonts 23–26
  - Xerox Modern Fonts 23–26
  - Xerox Required Fonts 23–26
- font 1, 3–5
  - Delete Font** command 9, 38–39
  - List Fonts** command 10, 39
  - Loading extended language fonts 27
  - Loading fonts onto your Print Service 23–26
  - Xerox Modern Fonts 23–26
  - Xerox Required Fonts 23–26
- font rotation 24, 25
- Formatting Print Service 1, 6–7
  - initializing 20
  - loading fonts 26
  - maintenance 79–81
  - standard operation 35
  - Target Print Service 6, 10, 11, 35, 79–81
- forwarding errors 80–81
- full power mode 56
- G**
- Getting to know the 8040 Series Electronic Printer 41–43
- Graphic Handling Option (GHO) 6
- graphics 1, 3–6
- I**
- image alignment
  - 8040 Series Electronic Printer 48–49
  - NS 8000 Laser CP Electronic Printer 68
- Image gap reprinting 82–83
- image test 61–63
- Initializing the 8040 Series Electronic Printer 16–17
- Initializing the Formatting Print Service 20
- Initializing the NS 8000 Laser CP Electronic Printer 17–18
- Initializing the Telecopier 495-1 Printer 18–19
- Initializing your Print Service 16
- Install From Floppy** command 9, 23
- installing fonts 23–26, 27
- Interface cable 41, 63
- interleaved Interpress masters 6
- internal self-test 75–76
- Interpress masters 6
- Isolating equipment failures 71–76
- isolation test 72–74
- J**
- J1 status code 44
- jams
  - clearing paper jams on the 8040 Series Printer 45
  - clearing paper jams on the NS 8000 Laser CP 59
  - recording paper jams on the Telecopier 495-1 Printer 72
- Japanese extended language fonts 27
- K**
- keyboard 41
- keypad 42
- L**
- L1 status code 42, 51, 56
- L2 error code 46, 49–51
- L4 error code 46, 51–52



- List Documents** command 9
- List Fonts** command 10, 39
- List Test Patterns** command 10
- Loading extended language fonts onto your Print Service 27
- Loading fonts onto your Print Service 23–26
- local banner 32
- local duplicate copies 32
- loopback test 33, 73–74
- low power mode 56
  
- M**
- maintenance**
  - 8040 Series Electronic Printer 41–58
  - Formatting Print Service 79–81
  - NS 8000 Laser CP Electronic Printer 59–69
  - Print Service 37–40
  - Telecopier 495-1 Printer 70–78
- misfeeds**
  - 8040 Series Electronic Printer 45, 52, 55
  - NS 8000 Laser CP Electronic Printer 62, 67
- Model-35 Electronic Printer 1
  
- N**
- 9700/8700 Electronic Printing System 1, 2, 6, 7
- NS 8000 Laser CP Electronic Printer 1, 2, 4, 57
  - Image gap reprinting 82–83
  - initializing 17–18
  - loading fonts 25
  - maintenance 59–69
    - banner option 60–61
    - dry imager 59
    - P1, P2, and P3 error codes 61–63
    - P4 error codes 63–64
    - printer image alignment 68
  - maintenance panel 60
  - standard operation 30–31
  
- O**
- operation**
  - 8040 Series Electronic Printer 28–30
  - Formatting Print Service 35
  - NS 8000 Laser CP Electronic Printer 30–31
  - Telecopier 495-1 Printer 31–34
- overview 1
  
- P**
- P1, P2, and P3 error codes 61–63
- P4 error codes 63–64
- panel**
  - 8040 Series printer maintenance panel 42
  - NS 8000 Laser CP maintenance panel 60
- paper**
  - 8040 Series Electronic Printer 28–29, 43–44
    - changing paper handling options 46–48
    - clearing paper jams 45–46
  - Formatting Print Service 80
  - NS 8000 Laser CP Electronic Printer 30–31
    - clearing paper jams 59
  - Telecopier 495-1 Printer 70
- parameters**
  - 8040 Series Electronic Printer default settings 28
  - Formatting Print Service paper handling parameters 35, 80
  - Telecopier 495-1 printer default settings 32
- Print Service maintenance 38
- Print Service statistics 39–40
- Print Tech Rep Log
  - 8040 Series Electronic Printer 55
  - NS 8000 Laser CP Electronic Printer 67
- Print Test Pattern** command 10, 30–31, 48, 68, 77
- printers 1–7
- PROCEDURES**
  - Changing the printing option 21
  - 8040 Series Electronic Printer maintenance 41
    - Changing paper handling options 46–48
    - Checking printer image alignment 48–49
    - Checking printer operation 45–46
    - Checking the dry imager 44–45
    - Controlling power consumption on B2 electronic printers 56
    - 8040 Series Electronic Printer paper 42–44
    - Getting to know the 8040 Series Electronic Printer 41–43
    - Responding to L2 and L4 error codes 49–50
  - Establishing standard operation of your Print Service 28
    - Establishing standard operation of the 8040 Series Electronic Printer 28–30
    - Establishing standard operation of the Formatting Print Service 35
    - Establishing standard operation of the NS 8000 Laser CP Electronic Printer 30–31
    - Establishing standard operation of the Telecopier 495-1 Printer 31–34
  - Formatting Print Service maintenance 79
    - Changing the Target Print Service 79–80
    - Responding to forwarding errors 80–81
    - Updating paper handling options 80
  - Image gap reprinting 82–83
  - Initializing your Print Service 16
    - Initializing the 8040 Series Electronic Printer 16–17
    - Initializing the Formatting Print Service 20
    - Initializing the NS 8000 Laser CP Electronic Printer 17–18
    - Initializing the Telecopier 495-1 Printer 18–19
  - Recovery operations for unsuccessful Print Service initialization 21–22
  - Loading extended language fonts onto your Print Service 27
  - Loading fonts onto your Print Service 23–26

- NS 8000 Laser CP Printer maintenance
    - Changing the banner option 60–61
    - Checking printer image alignment 68
    - Responding to P1, P2, P3, and P4 error codes 61–67
  - Print Service maintenance 38
    - Deleting fonts from your Print Service 38–39
    - Print Service statistics 39–40
    - Removing the Print Service from a server 40
  - Telecopier 495-1 Printer maintenance 70
    - Changing paper handling and transmission options 70–71
    - Isolating equipment failures 71–76
  - processor 41, 59
- Q**
- Query Target Print Service** command 10, 35, 80
  - Queue failures 39
  - queuing 37
- R**
- reboot 37, 79, 113
    - 8040 Series Electronic Printer 49
    - NS 8000 Laser CP Electronic Printer 60
  - Recovery operations for unsuccessful Print Service initialization 21–22
  - Recovery Retry Requests 39
  - registration 28–29, 48
  - remote 1, 5
  - remote banner 32
  - remote duplicate copies 32
  - Removing the Print Service from a server 40
  - Rename Print Service** command 10
  - reprinting
    - image gap 82
  - Reset Statistics** command 10, 39–40
  - Reset Tech Rep Log
    - 8040 Series Electronic Printer 55
    - NS 8000 Laser CP Electronic Printer 67
  - Responding to forwarding errors 80–83
  - Responding to L2 and L4 error codes 49–54
  - Responding to P1, P2, P3, and P4 error codes 61–66
  - RS-232 interface setup card parameters 34
  - RS-232 test 31, 71
    - loopback test 72–74
    - failures 74
  - RS-232C 31–34, 71, 74
  - Run Service** command 21–22, 82–83
- S**
- Safety notes
    - 8040 Series Electronic Printer 57
    - NS 8000 Laser CP Electronic Printer 69
  - sawtooth edges 31, 68
  - server 1, 3–5
    - Removing the Print Service from a server 40
  - Set Banner** command 10, 30, 60
  - Set Parameters** command 11, 46–48, 70–71
  - Set Target Print Service** command 11, 35, 79
  - Set Telecopier 495-1 clock to current time 76
  - Show Status** command 10, 11, 12, 29, 30, 32, 35, 39–40, 60, 72, 80
  - Shutdown Printer** command 11, 56
    - software 16, 41
  - stacking option 28–29, 46–47, 55
  - Start** command 11, 81
  - Start Diagnostic** command 12, 33, 50–52, 57, 68
    - correcting L2 and L4 error codes 49–52
    - correcting P1, P2, P3, and P4 error codes 61–64
    - Display Tech Rep Log 52–54, 64–66
    - Isolating equipment failures 71, 74–78
    - Print Tech Rep Log 55, 67
    - Reset Tech Rep Log 55, 67
    - Set Telecopier 495-1 clock to current time 76
    - Telecopier 495-1 internal self test 75–76
  - Start Printing** command 11, 12, 24, 39
  - Start Queuing** command 11, 12
  - Stop** command 12, 81
  - Stop Printing** command 12, 23, 38
  - Stop Queuing** command 12
  - Stop Service** command 10, 57, 68
- T**
- Target Print Service 6, 10, 11, 35, 79–80
  - Technical Representative repair mode
    - 8040 Series Electronic Printer 56–57
    - NS 8000 Laser CP Electronic Printer 68
  - Telecopier 495-1 Printer 1–2, 5
    - initializing 18–19
    - loading fonts onto your Print Service 25–26
    - maintenance 70–78
    - standard operation 31–34
  - Test** command 81
  - test patterns 39
    - 8040 Series Electronic Printer 30, 48
    - NS 8000 Laser CP Electronic Printer 31, 68
    - Telecopier 495-1 77–78
  - test print 42
  - transmission options 70–71
  - transmission retries 32
- U**
- Updating paper handling options 80
- V**
- ViewPoint 1, 3–4, 6, 35, 80
- W**
- Wakeup Printer** command 13, 56
  - workstations 3–5
- X**
- Xerox Modern Fonts 23–26
  - Xerox Required Fonts 23–26
  - XP-9 1