User's Guide

**HP B1477B
68040 Debugger/Emulator**

Notice

Hewlett-Packard makes no warranty of any kind with regard to this material, including, but not limited to, the implied warranties of merchantability and fitness for a particular purpose. Hewlett-Packard shall not be liable for errors contained herein or for incidental or consequential damages in connection with the furnishing, performance, or use of this material.

Hewlett-Packard assumes no responsibility for the use or reliability of its software on equipment that is not furnished by Hewlett-Packard.

© Copyright 1989-1993, Hewlett-Packard Company.

This document contains proprietary information, which is protected by copyright. All rights are reserved. No part of this document may be photocopied, reproduced or translated to another language without the prior written consent of Hewlett-Packard Company. The information contained in this document is subject to change without notice.

Microtec is a registered trademark of Microtec Research Inc.

SunOS, SPARCsystem, OpenWindows, and SunView are trademarks of Sun Microsystems, Inc.

UNIX is a registered trademark of UNIX System Laboratories Inc. in the U.S.A. and other countries.

Hewlett-Packard Company
P.O. Box 2197
1900 Garden of the Gods Road
Colorado Springs, CO 80901-2197, U.S.A.

RESTRICTED RIGHTS LEGEND Use, duplication, or disclosure by the U.S. Government is subject to restrictions set forth in subparagraph (C) (1) (ii) of the Rights in Technical Data and Computer Software Clause in DFARS 252.227-7013. Hewlett-Packard Company, 3000 Hanover Street, Palo Alto, CA 94304 U.S.A.

Rights for non-DOD U.S. Government Departments and Agencies are set forth in FAR 52.227-19(c)(1,2).

About this edition

Many product updates and fixes do not require manual changes, and manual corrections may be done without accompanying product changes. Therefore, do not expect a one-to-one correspondence between product updates and manual revisions.

Edition dates and the corresponding HP manual part numbers are as follows:

Edition 1 B1477-97003, March 1993

Certification and Warranty

Certification and warranty information can be found at the end of this manual on the pages before the back cover.

Debugging C Programs for 68040 Microprocessors

The HP B1477B 68040 Debugger/Emulator is a debugging tool for 68040 microprocessor code. The debugger loads and executes C programs or assembly language programs on an HP 64783 emulator. The code is executed in real time unless a specific feature of the debugger or emulator requires halting the processor. The emulator functions as a high-speed execution environment for the debugger.

With the Debugger, You Can ...

- Browse and edit C and C++ source files.
- View C and C++ functions on the stack.
- Monitor variables as the program executes.
- View assembly language code with source lines.
- View registers and stack contents.
- Step through programs by C or C++ source lines or by assembly language instructions.
- Stop programs upon the execution of selected instructions or upon a read or write of selected memory locations.
- Create conditional breakpoints using macros.
- Patch C or C++ code without recompiling.
- Collect microprocessor bus-level data as the program executes. You can specify when data should be collected and which states get saved.
- Simulate input and output devices using your computer's keyboard, display, and file system.
- Save and execute command files.
- Log debugger commands and output.
- Examine the inheritance relationships of C++ classes.
- Use the debugger, the emulator/analyzer, and the Software Performance Analyzer together.

With the Graphical Interface You Can ...

- Use the debugger under an X Window System that supports OSF/Motif interfaces.
- Enter debugger commands using pull-down or pop-up menus.
- Set source-level breakpoints using the mouse.
- Create custom action keys for commonly used debugger commands or command files.
- View source code, monitored data, registers, stack contents, and backtrace information in separate windows on the debugger's main display.
- Access on-line help information.
- Quickly enter commands using the guided syntax of the standard interface.

With the Standard Interface You Can ...

- Use the debugger with a terminal or terminal emulator.
- Quickly enter commands using guided syntax, command recall, and command editing.
- View source code, monitored data, registers, stack contents, and backtrace information in separate windows on the debugger's main display.
- Define your own screens and windows in the debugger's main display.
- Access on-line help information.

In This Book

This book is organized into five parts:

Part 1. Quick Start Guide

An overview of the debugger and a short lesson to get you started.

Part 2. User's Guide

How to use the debugger to solve your problems.

Part 3. Concept Guide

Background information on X resources.

Part 4. Reference

Descriptions of what each debugger command does, details of how the debugger works, and a list of error messages.

Part 5. Installation

How to install the debugger software on your computer.

Contents

Part 1 Quick Start Guide

1 Getting Started with the Graphical Interface

The Graphical Interface at a Glance 5

Pointer and cursor shapes	5
The Debugger Window	6
Graphical Interface Conventions	8
Mouse Buttons	9
Platform Differences	10

The Quick Start Tutorial 11

The Demonstration Program	11
To prepare to run the debugger	12
To start the debugger	13
To activate display area windows	14
To run until main()	15
To scroll the Code window	16
To display a function	17
To run until a line	18
To edit the program	19
To display init_system() again	20
To set a breakpoint	20
To run until the breakpoint	21
To patch code using a macro	22
To delete a single breakpoint	23
To delete all breakpoints	24
To step through a program	25
To run until a stack level	25
To step over functions	26
To step out of a function	26
To display the value of a variable	26
To change the value of a variable	27

Contents

To recall an entry buffer value	28
To display the address of a variable	29
To break on an access to a variable	30
To use the command line	31
To use a C printf command	31
To turn the command line off	32
To trace events following a procedure call	32
To see on-line help	34
To end the debugging session	35

2 Getting Started with the Standard Interface

The Standard Interface At a Glance	38
The Quick Start Tutorial	40
Before You Begin	40
The Demonstration Program	40
To copy the demonstration files	41
To start the debugger	42
To enter commands	43
To activate display area windows	43
To display main()	44
To display a function	44
To set a breakpoint	45
To run the demo program	45
To step through the program	46
To step over functions	46
To delete a breakpoint	46
To display variables in their declared type	47
To display the address of a variable	47
To use a C printf command	48
To break on an access to a variable	48
To display blocks of memory	49
To monitor variables	50
To modify a variable by entering a C expression	50
To end the debugging session	51

Part 2 User's Guide**3 Entering Debugger Commands**

Starting the Debugger	59
Using Menus, the Entry Buffer, and Action Keys	60
To choose a pull-down menu item using the mouse (method 1)	60
To choose a pull-down menu item using the mouse (method 2)	61
To choose a pull-down menu item using the keyboard	62
To choose pop-up menu items	63
To use pop-up menu shortcuts	64
To place values into the entry buffer using the keyboard	64
To copy-and-paste to the entry buffer	64
To recall entry buffer values	66
To edit the entry buffer	67
To use the entry buffer	67
To copy-and-paste from the entry buffer to the command line entry area	67
To use the action keys	68
To use dialog boxes	69
To access help information	73
Using the Command Line with the Mouse	74
To turn the command line on or off	75
To enter a command	76
To edit the command line using the command line pushbuttons	77
To edit the command line using the command line pop-up menu	78
To recall commands	78
To get help about the command line	79
Using the Command Line with the Keyboard	80
To enter debugger commands from the keyboard	80
To edit the command line	82
To recall commands using the command line recall feature	82
To display the help window	83
Viewing Debugger Status	85
Debugger Status	85
Indicator Characters	87

Contents

CPU Emulated	87
Current Module	87
Last Breakpoint	87
Trace Status	87
If pop-up menus don't pop up	88

4 Loading and Executing Programs

Compiling Programs for the Debugger	90
Using a Hewlett-Packard C Cross Compiler	90
Loading Programs and Symbols	93
To specify the location of C source files	93
To load programs	94
To load programs code only	95
To load symbols only	96
To load additional programs	96
To specify demand loading of symbols	97
To prevent demand loading of symbols	98
Stepping Through and Running Programs	99
To step through programs	99
To step over functions	100
To run from the current PC address	101
To run from a start address	101
To run until a stop (break) address	102
Using Breakpoints	104
To set a memory access breakpoint	104
To set an instruction breakpoint	106
To set a breakpoint for a C++ object instance	108
To set a breakpoint for overloaded C++ functions	108
To set a breakpoint for C++ functions in a class	109
To clear selected breakpoints	109
To clear all breakpoints	110
To display breakpoint information	111
To halt program execution on return to a stack level	114

Restarting Programs	115
To reset the processor	115
To reset the program counter to the starting address	115
To reset program variables	116
Loading a Saved CPU State	117
To load a saved CPU state	117
Accessing the UNIX Operating System	119
To fork a UNIX shell	119
To execute a UNIX command	120
Using the Debugger and the Emulator Interface	121
To start the emulation interface from the debugger	121
Using simulator and emulator debugger products together	122
Using the Debugger with the Branch Validator	123
To unload Branch Validator data from program memory	123
5 Viewing Code and Data	
Using Symbols	126
To add a symbol to the symbol table	126
To display symbols	127
To display symbols in all modules	128
To delete a symbol from the symbol table	128
Displaying Screens	130
To display the high-level screen	132
To display the assembly level screen	132
To switch between the high-level and assembly screens	132
To display the standard I/O screen	133
To display the next screen (activate a screen)	133
Displaying Windows	135
To change the active window	137
To select the alternate view of a window	138

Contents

To view information in the active window	139
To view information in the "More" lists mode	140
To copy window contents to a file	141
Displaying C Source Code	142
To display C source code	142
To find first occurrence of a string	143
To find next occurrence of a string	143
Displaying Disassembled Assembly Code	145
To display assembly code	145
Displaying Program Context	146
To set current module and function scope	146
To display current module and function	147
To display debugger status	147
To display register contents	148
To list all registers	149
To display the function calling chain (stack backtrace)	150
To display all local variables of a function at the specified stack (backtrace) level	153
To display the address of the C++ object invoking a member function	154
Using Expressions	155
To calculate the value of a C expression	155
To display the value of an expression or variable	156
To display members of a structure	157
To display the members of a C++ class	158
To display the values of all members of a C++ object	158
To monitor variables	159
To monitor the value of a register	160
To discontinue monitoring specified variables	160
To discontinue monitoring all variables	161
To display C++ inheritance relationships	161
To print formatted output to a window	162
To print formatted output to journal windows	162
Viewing Memory Contents	164
To compare two blocks of memory	164
To search a memory block for a value	164

To examine a memory area for invalid values 165
 To display memory contents 166

Using Simulated I/O 167

How Simulated I/O Works 167
 Simulated I/O Connections 168
 Special Simulated I/O Symbols 169
 To enable simulated I/O 170
 To disable simulated I/O 170
 To set the keyboard I/O mode to cooked 171
 To set the keyboard I/O mode to raw 171
 To control blocking of reads 172
 To redirect I/O 172
 To check resource usage 174
 To increase I/O file resources 174

6 Making Trace Measurements

The Trace Function 178
 To start a trace using the Code pop-up menu 184
 To start a trace using the command line 184
 To stop a trace in progress 185
 To display a trace 186
 To specify trace events 187
 To delete trace events 188
 To specify storage qualifiers 188
 To specify trigger conditions 190
 To halt program execution on the occurrence of a trigger 191
 To remove a storage qualification term 192
 To remove a trigger term 192
 To trace code execution before and after entry into a function 192
 To trace data written to a variable 193
 To trace data written to a variable and who wrote to the variable 194
 To trace events leading up to writing a particular value in a variable 195
 To execute a complex breakpoint using the trace function 196
 To trace entry to and exit from modules 197

7 Editing Code and Data

Editing Files 200
 To edit source code from the Code window 200

Contents

To edit an arbitrary file	201
To edit a file based on an address in the entry buffer	201
To edit a file based on the current program counter	201
Patching Source Code	202
To change a variable using a C expression	202
To patch a line of code using a macro	203
To patch C source code by inserting lines	204
To patch C source code by deleting lines	204
Editing Memory Contents	206
To change the value of one memory location	206
To change the values of a block of memory interactively	206
To copy a block of memory	207
To fill a block of memory with values	208
To compare two blocks of memory	208
To re-initialize all program variables	209
To change the contents of a register	209

8 Using Macros and Command Files

Using Macros	213
To display the Macro Operations dialog box	217
To define a new macro interactively using the graphical interface	217
To use an existing macro as a template for a new macro	218
To define a macro interactively using the command line	219
To define a macro outside the debugger	220
To edit an existing macro	220
To save macros	221
To load macros	221
If macros do not load	221
To call a macro	222
To call a macro from within an expression	223
To call a macro from within a macro	223
To call a macro on execution of a breakpoint	224
To call a macro when stepping through programs	226
To stop a macro	227
To display macro source code	227
To delete a macro	228

Using Command Files	229
To record commands	230
To place comments in a command file	231
To pause the debugger	231
To stop command recording	232
To run a command file	232
To set command file error handling	233
To append commands to an existing command file	234
To record commands and results in a journal file	234
To stop command and result recording to a journal file	235
To open a file or device for read or write access	235
To close the file associated with a window number	236
To use the debugger in batch mode	237

9 Configuring the Debugger

Setting the General Debugger Options	241
To display the Debugger Options dialog box	241
To list the debugger options settings	241
To specify whether command file commands are echoed to the Journal window	242
To set automatic alignment for breakpoints and disassembly	242
To set backtrace display of bad stack frames	243
To specify demand loading of symbols	244
To select the interpretation of numeric literals (decimal/hexadecimal)	244
To specify step speed	245
Setting the Symbolics Options	246
To display symbols in assembly code	246
To display intermixed C source and assembly code	247
To enable parameter checking in commands and macros	247
Setting the Display Options	249
To specify the Breakpoint window display behavior	249
To specify the View window display behavior	250
To specify the standard I/O window display behavior	250
To display half-bright or inverse video highlights	251
To turn display paging on or off (more)	251
To specify scroll amount	252
To store timing information when tracing	252

Contents

To mask fetches while tracing	253
Modifying Display Area Windows	254
To resize or move the active window	254
To move the Status window (standard interface only)	255
To define user screens and windows	256
To display user-defined screens	257
To erase standard I/O and user-defined window contents	258
To remove user-defined screens and windows	258
Saving and Loading the Debugger Configuration	260
To save the current debugger configuration	260
To load a startup file	261
Setting X Resources	263
Where resources are defined	263
To modify the debugger's graphical interface resources	265
To use customized scheme files	269
To set up custom action keys	271
To set initial recall buffer values	272

10 Configuring the Emulator

Using the Configuration Interface	275
To start the configuration interface	276
To modify a configuration section	278
To apply configuration changes to the emulator	280
To store configuration changes to a file	280
To change the configuration directory context	281
To display the configuration context	282
To access help topics	282
To access context sensitive (f1) help	283
To exit the configuration interface	283
To load a configuration	284
Modifying the Monitor Setup	285
To select the monitor type	286
To select the monitor filename	287
To select the monitor address	288

To select the monitor interrupt priority level 289

To select whether or not the emulator will terminate monitor bus cycles 290

To select if there will be a keep-alive function, its address, and function code 291

Mapping Memory 292

To add memory map entries 294

To modify memory map entries 297

To delete memory map entries 299

To characterize unmapped ranges 299

To map memory ranges in which data is not loaded into the caches 300

To map memory in which the emulator will terminate bus cycles 300

To map memory to be stored within the dual-port memory 301

Configuring the Emulator General Items 302

To enable/disable target system interrupts 303

To enable/disable the instruction and data caches 304

To enable/disable the memory management unit (MMU) 305

To specify whether the clock speed of the emulation bus is greater than 25 MHz 306

To restrict the emulator to real-time runs 307

To enable/disable breaks on writes to ROM 308

To specify the memory access size 309

To specify the initial value of the stack pointer 310

To specify the initial value of the program counter 311

Setting the Trace Options 312

To include/exclude background monitor execution in the trace 313

To identify the data rate of your emulation system for the emulation-bus analyzer 313

Modifying the Simulated IO Configuration Items 316

Modifying the Interactive Measurement Specification Configuration Items 317

To select whether the card cage rear panel BNC is connected to the Trig1 and/or Trig2 signals 317

To select whether the coordinated measurement bus is connected to the Trig1 and/or Trig2 signals 319

Contents

To select whether the emulator will allow a signal on Trig2 to initiate a break from target program execution	320
To select whether or not the emulation-bus analyzer will operate with, or ignore, the Trig2 line of the coordinated measurement bus.	321
Providing MMU Address Translation for the Foreground Monitor	322
To modify the MMU address-translation tables to translate the monitor address space 1:1	324
Locating the Foreground Monitor using the MMU Address Translation Tables	327

Part 3 Concept Guide

11 X Resources and the Graphical Interface

An X resource is user-definable data	332
A resource specification is a name and a value	332
Don't worry, there are shortcuts	333
But wait, there is trouble ahead	334
Class and instance apply to applications as well	335
Resource specifications are found in standard places	336
Loading order resolves conflicts between files	337
The app-defaults file documents the resources you can set	338
Scheme files augment other X resource files	338
You can create your own scheme files, if you choose	339
Scheme files continue the load sequence for X resources	340
You can force the debugger's graphical interface to use certain schemes	340
Resource setting - general procedure	342

Part 4 Reference**12 Debugger Commands**

How Pulldown Menus Map to the Command Line	346
How Popup Menus Map to the Command Line	349
Command Summary	351
Breakpoint Commands	351
Session Control Commands	351
Expression Commands	352
File Commands	352
Memory Commands	353
Program Commands	353
Symbol Commands	354
Trace Commands	354
Window Commands	355
Breakpt Access	356
Breakpt Clear_All	358
Breakpt Delete	359
Breakpt Force_HW	360
Breakpt Instr	361
Breakpt Read	363
Breakpt Write	364
Debugger Directory	365
Debugger Execution Display_Status	366
Debugger Execution Environment FwdCmd	367
Debugger Execution Environment Load_Config	368
Debugger Execution Environment Modify_Config	369
Debugger Execution IO_System	370
Debugger Execution Load_State	373
Debugger Execution Reset_Processor	374
Debugger Host_Shell	375
Debugger Help	377
Debugger Level	378
Debugger Macro Add	379
Debugger Macro Call	382
Debugger Macro Display	383
Debugger Option Command_Echo	384

Contents

Debugger Option General	385
Debugger Option List	388
Debugger Option Symbolics	389
Debugger Option Trace	391
Debugger Option View	392
Debugger Pause	395
Debugger Quit	396
Expression C_Expression	398
Expression Display_Value	399
Expression Fprintf	402
Expression Monitor Clear_All	407
Expression Monitor Delete	408
Expression Monitor Value	409
Expression Printf	412
File Command	414
File Error_Command	415
File Journal	416
File Log	417
File Startup	419
File User_Fopen	421
File Window_Close	423
Memory Assign	424
Memory Block_Operation Copy	426
Memory Block_Operation Fill	427
Memory Block_Operation Match	429
Memory Block_Operation Search	431
Memory Block_Operation Test	433
Memory Display	435
Memory MMU	437
Memory Register	438
Memory Unload_BBA	440
Program Context Display	443
Program Context Expand	444
Program Context Set	445
Program Display_Source	446
Program Find_Source Next	447
Program Find_Source Occurrence	448
Program Load	450
Program Pc_Reset	452
Program Run	453
Program Step	456

Program Step Over	458
Program Step With_Macro	460
Symbol Add	461
Symbol Browse	464
Symbol Display	465
Symbol Remove	470
Trace Again	472
Trace deMMUer	473
Trace Display	475
Trace Event Clear_All	481
Trace Event Delete	482
Trace Event List	483
Trace Event Specify	484
Trace Event Used_List	488
Trace Halt	489
Trace StoreQual	490
Trace StoreQual Event	494
Trace StoreQual List	496
Trace StoreQual None	497
Trace Trigger	498
Trace Trigger Event	502
Trace Trigger List	505
Trace Trigger Never	506
Window Active	507
Window Cursor	509
Window Delete	510
Window Erase	511
Window New	512
Window Resize	515
Window Screen_On	516
Window Toggle_View	517

13 Expressions and Symbols in Debugger Commands

Expression Elements	521
Operators	521
Constants	523
Symbols	528
Program Symbols	528

Contents

Debugger Symbols	529
Macro Symbols	529
Reserved Symbols	530
Line Numbers	530
Addresses	531
Code Addresses	531
Data and Assembly Level Code Addresses	531
Address Ranges	531
Keywords	533
Forming Expressions	534
Expression Strings	535
Symbolic Referencing	536
Storage Classes	536
Data Types	537
Special Casting	540
Scoping Rules	541
Referencing Symbols	541
Evaluating Symbols	545
Stack References	546

14 Registers

15 Predefined Macros

break_info	556
byte	558
close	559
cmd_forward	560
dword	562
error	563
fgetc	564
fopen	565
key_get	566
key_stat	567
memchr	568
memclr	569

memcpy	570
memset	571
open	572
pod_command	574
read	576
reg_str	577
showversion	578
strcat	579
strchr	580
strcmp	581
strcpy	582
stricmp	583
strlen	584
strncmp	585
until	586
when	587
word	588
write	589

16 Debugger Error Messages

17 Debugger Versions

Version C.05.10	610
Larger Symbol Table	610
More Global Symbols	610
Radix Option Side Effects	610
New Demand Loading Option	611
Graphical User Interface	611
New Product Number	611
New Reserved Symbols	611
New Predefined Macro	611
Environment Variable Expansion	612
Target Program Function Calls	612
C++ Support	612
Simulated Interrupts Removed	612
Simulated I/O Changes	612

Part 5 Installation Guide

18 Installation

- Installation at a Glance 616
 - Supplied interfaces 616
 - Supplied filesets 617
 - Emulator/Analyzer Compatibility 617
 - C Compiler Installation 617

- To install software on an HP 9000 system 618
 - Required Hardware and Software 618
 - Step 1: Install the software 619

- To install the software on a Sun SPARCsystem™ 622
 - Required Hardware and Software 622
 - Step 1: Install the software 623
 - Step 2: Map your function keys 623

- To install the emulator hardware 625

- To set up your software environment 626
 - To start the X server 626
 - To start HP VUE 627
 - To set environment variables 628
 - To find the logical name of your emulator 630
 - To add an emulator to the 64700tab.net file 631
 - To add an emulator to the /etc/hosts file 631

- To verify the software installation 632
 - To remove software 632

- Configuring Terminals for Use with the Debugger 633
 - To resize a debugger window in an X-Window larger than 24 lines by 80 columns 646
 - To resize a debugger window in a window larger than 24 lines by 80 columns 647

Part 1

Quick Start Guide

Part 1

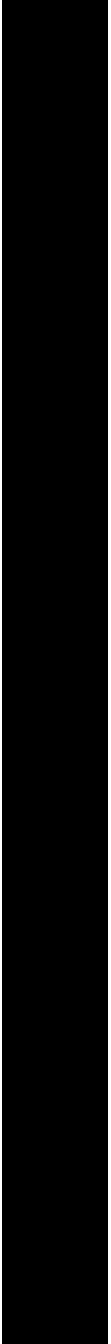

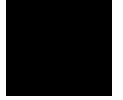

Getting Started with the Graphical Interface

How to get started using the debugger's graphical interface.

Chapter 1: Getting Started with the Graphical Interface



When an X Window System that supports OSF/Motif interfaces is running on the host computer, the debugger has a *graphical interface* that provides features such as pull-down and pop-up menus, point and click setting of breakpoints, cut and paste, on-line help, customizable action keys and pop-up recall buffers.

The debugger also has a *standard interface* for several types of terminals, terminal emulators, and bitmapped displays. When using the standard interface, commands are entered from the keyboard. If you are using the debugger's standard interface, please skip to Chapter 2, "Getting Started with the Standard Interface".

Some advanced commands are not well-suited to menus. Those commands are entered through the *command line*. The command line allows you to enter standard interface commands in the graphical interface.

The Graphical Interface at a Glance



Pointer and cursor shapes



Arrow

The arrow mouse pointer shows where the mouse is pointing.



Hand

The hand mouse pointer indicates that a pop-up menu is available by pressing the right mouse button.



Hourglass

The hourglass mouse pointer means "wait." If the debugger is busy executing a program, you may stop it by pressing < **Ctrl**> -**C**.



Text

The "I-beam" keyboard cursor shows where text entered with the keyboard will appear in the entry buffer or in a dialog box.



Command-line

The "box" keyboard cursor on the command line shows where commands entered with the keyboard will appear.

The Debugger Window

The screenshot shows a debugger window with the following components and content:

- Menu bar:** File, Display, Modify, Execution, Breakpoints, Window, Settings, Help
- Action keys:**
 - Row 1: < Demo >, Disp Src (), C Expr (), Run, Run til (), Step Over
 - Row 2: < Your Key >, Make, Disp Src PC, Monitor (), Step, Run Xfer, Step Out
- Entry buffer:** (): main Recall
- Display area:**
 - Monitor:**

```

1 num_checks 0
2 target_temp 0
3 current_temp 0
4 old_data [00]:temp 0
5 humid 0
6 ave_temp 0.000000E+00
7 ave_humid 0.000000E+00
8 [01]:temp 0
                
```
 - Backtrace:**

```

0. 00000400:crt0\entry
                
```
 - Code:**

```

1 /*****
2 A Hewlett-Packard Software Product
3 Copyright Hewlett-Packard Co. 1992
4
5 All Rights Reserved. Reproduction, adaptation, or translation without pri
6 written permission is prohibited, except as allowed under copyright law
7 *****/
8 #include <stdio.h>
9 #include <string.h>
10 #include "update_sys.h"
11 #include "proc_spec.h"
12 /*****
13 * This typedef is also found in demo.h but since demo.h is not included in
14 * this file, this declaration appears here by itself.
15 *****/
16 #define SHRINKFACTOR 1.3
17 #define LISTLEN NUM_OF_OLD*4+1
                
```
 - Journal:**

```

Note: in startup routine. Press F8 to go to main.
> File Command cmdfiles/debug/Command_dbmac.com
                
```
- Status line:** STATUS: Command 68040 MODULE: crt0 BREAK #: 0 HELP=F5
- Command line:**
 - Input: > File Command cmdfiles/debug/Command_dbmac.com
 - Buttons: Breakpt, Debugger, Expression, Memory, Program, Symbol, Window
 - Options: Command, Error_Command, User_Fopen, Journal, Log, Window_Close, Startup
 - Command: Return, Recall
 - Cursor: Backup, Forward, Clear to end, Clear
 - Help

Menu Bar. Provides pull-down menus from which you select commands. When menu items are not applicable, they appear half-bright and do not respond to mouse clicks.



Action Keys. User-defined pushbuttons. You can label these pushbuttons and define the action to be performed. Action key labels and functions are defined by setting X resources (see the “Configuring the Debugger” chapter).

Entry Buffer. Wherever you see "()" in a pull-down menu, the contents of the entry buffer are used in that command. You can type values into the entry buffer, or you can cut and paste values into the entry buffer from the display area or from the command line entry area. You can also set up action keys to use the contents of the entry buffer.

Display Area. This area of the screen is divided into windows which display information such as high-level code, simulated input and output, and breakpoints. To activate a window, click on its border.

In this manual, the word "window" usually refers to a window inside the debugger display area.

Scroll Bar. Allows you to page or scroll up or down the information in the active window.

Status Line. Displays the debugger and emulator status, the CPU type, the current program module, the trace status, and the number of the last breakpoint.

Command Line. The command line area is similar to the command line in the standard interface; however, the graphical interface lets you use the mouse to enter and edit commands. You can turn off the command line if you only need to use the pull-down menus.



Graphical Interface Conventions

This manual uses a shorthand notation for indicating that you should choose a particular menu item. For example, the following instruction

Choose **File**→**Load**→**Executable...**

means to select the **File** menu, then select **Load** from the File menu, then select the **Executable...** item from the Load menu.

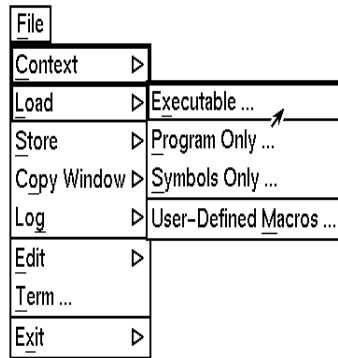

Refer to the “Entering Debugger Commands” for specific information about choosing menu items.

In this manual, the word "window" usually means a window inside the debugger display area, rather than an X window.

Mouse Buttons

Mouse Button Descriptions

Button Name	General Function
left	Selects pushbuttons. Pastes from the display area to the entry buffer.
middle	Pastes from the entry buffer to the command line text area. If you have a two-button mouse, press both buttons together to get the "middle button."
right	Click selects first item in pop-up menus. Click on window border activates windows. Press and hold displays menus.
<i>command select</i>	Displays pull-down menus. May be the left button or right button, depending on the kind of computer you have. <i>See</i> "Platform Differences" on page 10.

Platform Differences

A few mouse buttons and keyboard keys work differently between platforms. This manual refers to those mouse button and keyboard bindings in a general way. Refer to the following tables to find out the button names for the computer you are using to run the debugger.

Mouse Button Bindings

Generic Button Name	HP 9000	Sun SPARCsystem
<i>command select</i>	left	right

Keyboard Key Bindings

Generic Key Name	HP 9000	Sun SPARCsystem
menu select	extend char	extend char (diamond)
left-arrow	left arrow	left arrow ¹
right-arrow	right arrow	right arrow ¹

¹These keys do not work while the cursor is in the main display area.

The Quick Start Tutorial

This tutorial gives you step-by-step instructions on how to perform a few basic tasks using the debugger.

Perform the tasks in the sequence given; otherwise, your results may not be the same as those shown here.

Some values displayed on your screen may vary from the values shown here.

The Demonstration Program

The demonstration program used in this chapter is a simple environmental control system (ECS). The system controls the temperature and humidity of a room requiring accurate environmental control. The program continuously looks at flags which tell it what action to take next.

Note

Some commands are printed on two lines in this chapter. When entering these commands, type the entire command on one line.

To prepare to run the debugger

1 Check that the debugger has been installed on your computer. Installation is described in the "Installation" chapter.

2 Find the logical name of your emulator.

The emulator name *em68040* is used in the examples in this chapter. If you have given your emulator a different logical name in the HP 64700 emulator device table */usr/hp64000/etc/64700tab.net*, use your emulator name or lan address in the examples. See the section "To find the logical name of your emulator" in the "Installation" chapter of this manual. See the *HP 64700A Card Cage Installation/Service Manual* for detailed information on installing your emulator.

3 Find out where the debugger software is installed. If it is not installed under */usr/hp64000* then use *\$HP64000* wherever */usr/hp64000* is printed in this chapter.

4 Check that */usr/hp64000/bin* and *.* are in your *\$PATH* environment variable. (Type *echo \$PATH* to see the value of *\$PATH*.)

5 If the debugger software is installed on a different kind of computer than the computer you are using, edit the *platformScheme* in the *Xdefaults.all* and *Xdefaults.emul* files. These files are located in */usr/hp64000/etc*. For example, if you are sitting at a Sun workstation which is networked to an HP 9000 Series 300 workstation, change the *platformScheme* to *SunOS*.

To start the debugger



- 1 Change to the debugger demo directory:

```
cd /usr/hp64000/demo/debug_env/hp64783
```

- 2 Start the debugger by entering:

```
Startdebug em68040
```

This will set some environment variables, start the debugger, load a configuration file, and load a program for you to look at.

If the logical name of your emulator is not *em68040*, then use the name of your emulator instead of *em68040*. If you do not know the name of your emulator, see “To find the logical name of your emulator” in the “Installation” chapter of this manual.

The Startdebug script will ask you whether it should copy the demo files to another directory. If you have a C compiler available, answer "y". (You cannot modify the files in /usr/hp64000/demo.)

Or, if you have installed the emulator/analyzer and Software Performance Analyzer interfaces, you can use the following command to start all of the interfaces:

```
Startall em68040
```

Note

If you were debugging your own program, you would need to enter a command like:

```
db68k -e em68040 -C Config -c mycmd ecs
```

This command starts the debugger, which executes the command file *mycmd.com* and loads the absolute file *ecs.x*. See the “Loading and Executing Programs” chapter for more details.



To activate display area windows

Notice there are several windows in the main display area of the debugger. The different windows contain different types of information from the debugger. The active window has the thicker border.

- 1 Use the right mouse button to click on the border of the Monitor window.

Be sure to click only once (do not "double-click"). The Monitor window should now have a thick border. Now activate the Code window:

- 2 Use the right mouse button to click on the border of the Code window.

If you click on the border of the active window, it will be expanded. Just click again to show the window in its normal size.

See the "Debugging Programs" chapter for a list of other ways to activate a window.

To run until main()

- 1 Click on the **Run til ()** action key. Run til ()

The Code window now shows the *main ()* routine.

Clicking on the **Run til ()** action key runs the program until the line indicated by the contents of the *entry buffer*.

Locate the **():** symbol. The area to the right of this symbol is the entry buffer. When you started the demonstration program, the debugger loaded the entry buffer with the value “main”.

The screenshot shows a debugger window with a menu bar (File, Display, Modify, Execution, Breakpoints, Window, Settings, Help) and a toolbar with action keys: < Demo >, Disp Src (), C Expr (), Run, Run til (), Step Over, < Your Key >, Make, Disp Src PC, Monitor (), Step, Run Xfer, Step Out. The entry buffer shows **():** main. The Monitor window displays variables: num_checks (0), target_temp (0), current_temp (0), old_data ([00]:temp 0, humid 0, ave_temp 0.000000E+00, ave_humid 0.000000E+00, [01]:temp 0). The Backtrace window shows: 2. 0000203C?crt0\<unknown>, 1. 00002316 startup_startup, 0. 00002954*main\main. The Code window shows the main() function starting at line 96. The Journal window shows: > Program Run Until main (Temp) Break module main line 96. The status bar shows: STATUS: Command 68040 MODULE: main BREAK #: 1 TRC:Idle.

To scroll the Code window

To see more of the program you can:

- Use the mouse to operate the vertical scroll bar:

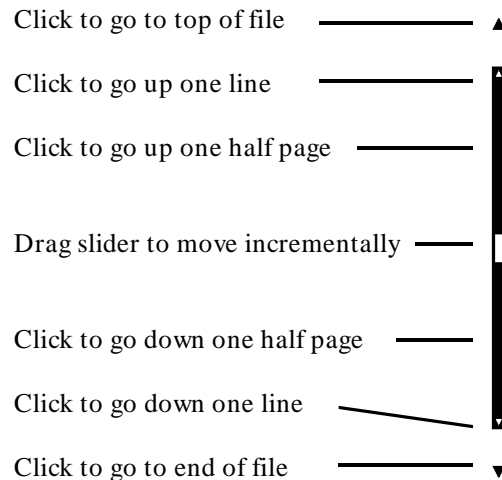

- Use the mouse to operate the horizontal scrolling buttons: 
- Use the < Page Up> and < Page Down> keys on your keyboard.

The scroll bar affects the contents of the active (highlighted) window.

You might notice that the scroll bar has a "sticky" slider which always returns to the center of the scroll bar. This is so that you can always do local navigation even in very large programs. Use the **Disp Src ()** action key or the **Display→Source ()** pull-down menu item to move larger distances.

To display a function

- 1 Position the cursor over the call to *init_system*.
- 2 Click the left mouse button.

This will place the string "init_system" into the entry buffer.

- 3 Click on the **Disp Src ()** action key.
- 4 Scroll up one line to see the "init_system()" line.

You should now see the source code for the *init_system()* routine in the Code window.

The screenshot shows a debugger window with the following components:

- Menu Bar:** File, Display, Modify, Execution, Breakpoints, Window, Settings, Help.
- Action keys:** < Demo >, Disp Src (), C Expr (), Run, Run til (), Step Over, < Your Key >, Make, Disp Src PC, Monitor (), Step, Run Xfer, Step Out.
- Entry Buffer:** (): init_system, Recall.
- Monitor Window (3):**

```

1 num_checks 0
2 target_temp 0
3 current_temp 0
4 old_data [00]:temp 0
5 humid 0
6 ave_temp 0.000000E+00
7 ave_humid 0.000000E+00
8 [01]:temp 0

```
- Backtrace Window (4):**

```

2. 0000203C?crt0\<unknown>
1. 00002316 startup\_startup
0. 00002954*main\main

```
- Code Window (2):**

```

30 init_system()
31 { /* FUNCTION init_system() */
32 /* Initialize the target values for temperature and humidity */
33 target_temp = 73;
34 target_humid = 45;
35
36 /* Intialize the variables indicating the current environment */
37 /* conditions */
38 current_temp = 68;
39 current_humid = 41;
40
41 /* Set starting directions for temp and humid */
42 temp_dir = up;
43 humid_dir = up;
44
45 /* Initialize the variables that depict the current status of the */
46 /* computer room and what hardware needs to be on or off in the room */

```
- Journal Window (1):**

```

> Program Context Set init_system
> Program Display_Source init_system

```
- Status Bar:** STATUS: Command 68040 MODULE: init_system BREAK #: 1 TRC:Idle

To run until a line

- 1 Position the cursor over line 34. The hand-shaped cursor means that a pop-up menu is available.

```
31 { /* FUNCTION init_system() */
32 /* Initialize the target values for temperature and humidity */
33 target_temp = 73;
34 target_humid = 45; 
```

- 2 Hold down the right mouse button to display the Code window pop-up menu. Move the mouse to **Run until**, then release the button.

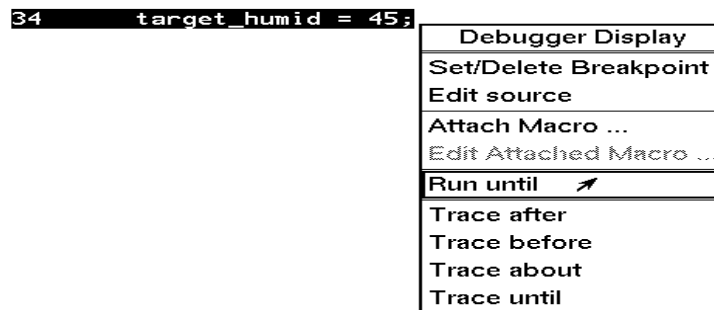

Line 34 should now be highlighted. Notice that "init_system" now appears in the Backtrace window at level 0, which means that the program counter is inside the `init_system()` function.

To edit the program

This step assumes you are using an HP Advanced Cross Language System compiler (HP B1463). If you are using another compiler, skip this step.

Suppose we wanted the initial value of *target_temp* to be 74 instead of 73. The debugger makes it easy to change the source code:

- 1 Place the cursor over the assignment to *target_temp* (line 33).

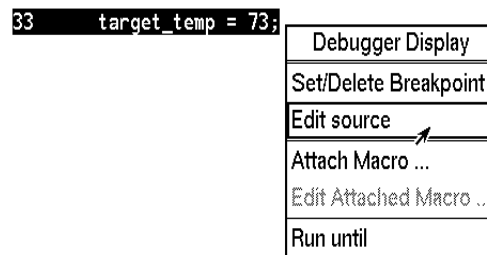

- 2 Hold the right mouse button and select **Edit Source** from the Code window pop-up menu.

An editor will appear in a new X window. The default text editor is **vi**. You can use a different text editor by editing X resources (described in the "Configuring the Debugger" chapter).

- 3 Change the "73" to "74".
- 4 Exit the editor.
- 5 Click on the **Make** action key.

The program will be re-compiled with the new value and reloaded.

To display *init_system()* again

- Click on the **Disp Src()** action key.

Since "init_system" is still in the entry buffer, the *init_system()* routine is displayed.

You have now completed a edit-compile-load programming cycle.

To set a breakpoint

We want to run until just past the line that we changed.

- 1 Position the mouse pointer over line 42.
- 2 Click the right mouse button to set a breakpoint.

The breakpoint window is displayed, showing the breakpoint has been added.

An asterisk (*) appears in the first column of the Code window next to the location of the breakpoint. Dots appear in front of any other lines (such as comments) associated with the breakpoint.

To run until the breakpoint

- Click on the **Run Xfer** action key to run the program from its transfer address.

While the program is executing, the menus and buttons are "grayed out," and an "hourglass" mouse pointer is displayed. You cannot enter debugger commands while the program is executing. If you need to stop an executing program, type **< Ctrl> -C** with the mouse pointer in the debugger X window.

After a few moments, line 42 will be highlighted, showing that program execution stopped there.

The Journal window shows that a break occurred and which breakpoint it was.

The screenshot displays a debugger window with the following components:

- Menu Bar:** File, Display, Modify, Execution, Breakpoints, Window, Settings, Help.
- Action keys:** < Demo >, Disp Src (), C Expr (), Run, Run til (), Step Over.
- Secondary Action keys:** < Your Key >, Make, Disp Src PC, Monitor (), Step, Run Xfer, Step Out.
- Command Line:** (:) init_system Recall
- Monitor Window (3):**

```

1 num_checks 0
2 target_temp 74
3 current_temp 68
4 old_data [00]:temp 0
5 humid 0
6 ave_temp 0.000000E+00
7 ave_humid 0.000000E+00
8 [01]:temp 0

```
- Backtrace Window (4):**

```

3. 0000043C?crt0\<unknown>
2. 00000716 startup\_startup
1. 0000005E main\main
0. 00001264 init_system\init_sy

```
- Code Window (2):**

```

39 current_humid = 41;
40
41 /* Set starting directions for temp and humid */
* 42 temp_dir = up;
43 humid_dir = up;
44
45 /* Initialize the variables that depict the current status of the */
46 /* computer room and what hardware needs to be on or off in the room */
47 func_needed = 0;
48 hdnr_encode = 0;
49
50 /*Initialize the count of calls to update_state_of_system() */
51 num_checks = 0;
52
53 /* Initialize writing location in old_array */
54 curr_loc = 0;
55

```
- Journal Window (1):**

```

> Program Run
Break # 1 on instr module init_system line 42

```
- Status Bar:** STATUS: Command 68040 MODULE: init_system BREAK #: 1 HELP=F5

To patch code using a macro

- 1 Position the cursor over line 38.
- 2 Select **Attach Macro** from the Code window pop-up menu.

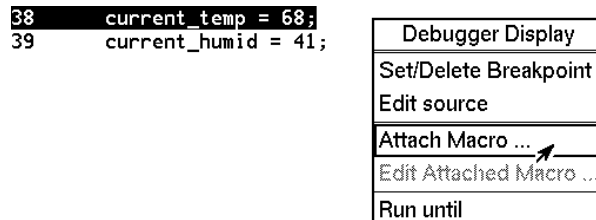

The Macro Operations dialog box appears. The macro "patch_temp" is already selected. Before we attach the macro, let's examine it:

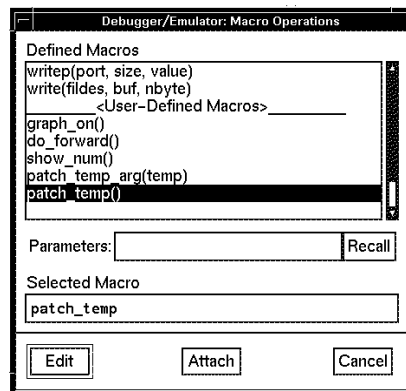

- 3 Click on the **Edit** button in the dialog box.

This macro will set `current_temp` to 71 each time the breakpoint is encountered. The macro skips over the assignment in the program source code by setting the program counter to line 39. The return value of 0 tells the macro to stop program execution after the macro.

```
Debugger Macro Add int patch_temp()  
{  
  /* set the current_temp to be 71 degrees instead of what the code says */  
  current_temp = 71;  
  
  /* Restart execution at line # 39 -- Skips over the code too!! */  
  $Memory Register @PC = #39$;  
  
  /* Return value indicates continuation logic: 1=continue, 0=break */  
  return(0);  
}  
.
```

- 4 Exit the editor.
- 5 Click on the **Attach** button in the dialog box.

The plus sign ("+") in front of line 38 indicates that a macro has been attached to a breakpoint at that line.

- 6 Click on the **Run Xfer** action key to run the program.

Notice that *current_temp*, as shown in the Monitor window, is 71, not 68.

To delete a single breakpoint

Once you set a breakpoint, program execution will break each time the breakpoint is encountered. If you don't want to break on a certain breakpoint again, you must delete the breakpoint. Suppose you want to delete the breakpoint that was previously set at line 42 in *init_system*.

- 1 Position the mouse over line 42.
- 2 Click the right mouse button to delete the breakpoint.

The breakpoint window shows the breakpoint has been deleted. The asterisk in front of line 42 disappears.



To delete all breakpoints

- 1 Position the mouse pointer in the Breakpoint window.
- 2 Hold down the right mouse button to select **Delete All Breakpoints** from the Breakpoint window pop-up menu.

All breakpoints are deleted.

To step through a program

You can execute one source line (high-level mode) or one instruction (assembly-level mode) at a time by stepping through the program.

- Click on the **Step** action key a few times.
- If you want to try using a pull-down menu, select **Execution**→**Step**→**from PC** a few times.

As the debugger steps through the program, you can see the PC progress through the source code, as shown by the inverse video line in the Code window.

To run until a stack level

Now we need to go back to *main()*. You can run the program until it enters *main()* by running to a stack level.

- 1 Position the mouse pointer over the line containing "main\main" in the Backtrace window.
- 2 Select **Run Until Stack Level** from the Backtrace pop-up menu.

The program counter is now back in *main()*, on the call to *proc_spec_init()*.

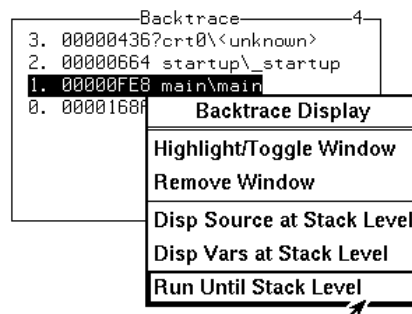

To step over functions

You can either step through functions or step over functions. When you step over a function, it is executed as a single program step.

- Click on the **Step Over** action key.

The next line in *main()* is highlighted. The routine *proc_spec_init()* was executed as a single program step.

To step out of a function

- 1 Click on the **Step** action key until the program counter is in *update_system()*.
- 2 Click on the **Step Out** action key.

The program will execute until it returns from *update_system()*.

To display the value of a variable

- 1 Use the left mouse button to highlight "num_checks" in the Code window.
- 2 Click on the **C Expr ()** action key.

In the Journal window, the current value of the variable is displayed in its declared type (int). Notice that this is the same as the value displayed in the Monitor window.

To change the value of a variable

- 1 In the entry buffer, add "= 10" after "num_checks".
- 2 Click on the **C Expr ()** action key.

The new value is displayed in the Journal window and in the Monitor window.

The screenshot displays a debugger interface with the following components:

- Menu Bar:** File, Display, Modify, Execution, Breakpoints, Window, Settings, Help.
- Action keys:** < Demo >, Disp Src (), C Expr (), Run, Run til (), Step Over.
- Key Bindings:** < Your Key >, Make, Disp Src PC, Monitor (), Step, Run Xfer, Step Out.
- Command Line:** (): num_checks=10 Recall
- Monitor Window (3):**

```
1 num_checks 10
2 target_temp 76
3 current_temp 70
4 old_data [00]:temp 70
5           humid 43
6           ave_temp 0.000000E+00
7           ave_humid 0.000000E+00
8           [01]:temp 65
```
- Backtrace Window (4):**

```
2. 0000203C?crt0\<unknown>
1. 00002316 startup\startup
0. 0000296C main\main
```
- Code Window (2):**

```
100 while (true)
101 {
102     update_system();
103     num_checks++;
104     interrupt_sim(&num_checks);
105     if (graph)
106         graph_data();
107     proc_specific();
108 }
109 }
110
111 /*****
112 * FUNCTION: interrupt_sim
113 * PARMS: counter -- loop counter passed in from main
114 * DESCRIPTION:
115 * create a simulation of a (usually) long interrupt service routine tha
116 * also has a duration profile to use with a SPA duration trigger.
```
- Journal Window (1):**

```
> Expression C_Expression num_checks=10
Result is: 10 0x0A
```
- Status Bar:** STATUS: Command 68040 MODULE: main BREAK #: 1 TRC:Idle

To recall an entry buffer value

- 1 Click on the **Recall** button.
- 2 In the Recall dialog box, click the left mouse button on "num_checks".
- 3 In the Recall dialog box, click the left mouse button on **OK**.

The string "num_checks" is now in the entry buffer.

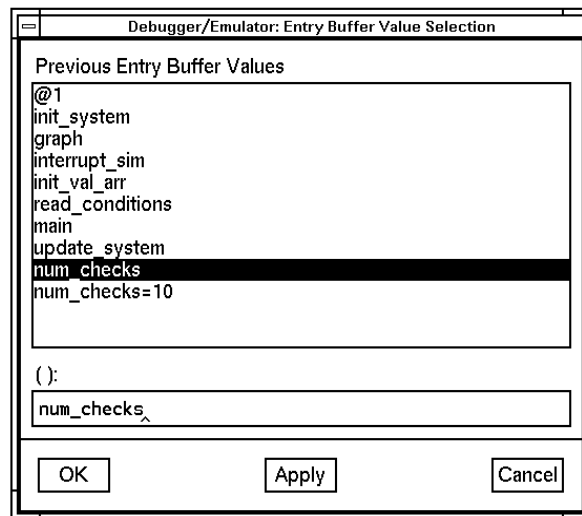

To display the address of a variable

You can use the C address operator (&) to display the address of a program variable.

- 1 Position the mouse pointer in the entry buffer.
- 2 Type "&" in the entry buffer so that it contains "&num_checks".



A screenshot of a graphical user interface element, likely an entry buffer. It consists of a rectangular box with a thin border. On the left side of the box, there is a small icon of a pair of parentheses '()' followed by the text '&num_checks'. On the right side of the box, there is a button labeled 'Recall'.

- 3 Click on the **C Expr ()** action key.

The result is the address of the variable *num_checks*. The address is displayed in hexadecimal format.

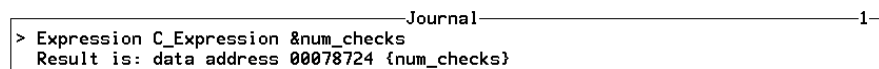

A screenshot of a window titled 'Journal'. The window has a thin border and a small '1' in the top right corner. Inside the window, the text is as follows:
> Expression C_Expression &num_checks
Result is: data address 00078724 {num_checks}

To break on an access to a variable

If you started the debugger using the **Startall** script, skip this section. Access breakpoints are disabled because the analyzer has been configured to use the Trig2 trigger for other purposes.

You can also set breakpoints on a read, a write, or any access of a variable. This helps to locate defects due to multiple functions accessing the same variable. Suppose you want to break on the access of the variable `num_checks`. ("`&num_checks`" should still be in the entry buffer.)

- 1 Set the breakpoint by selecting **Breakpoints**→**Set**→**Read/Write ()**.

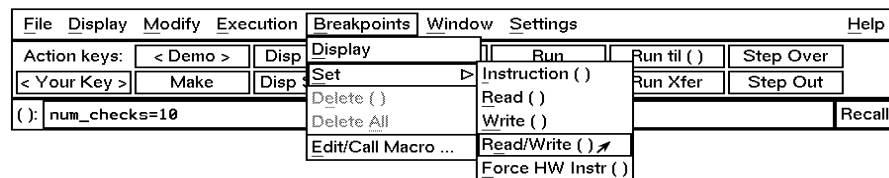

- 2 Run the program by clicking on the **Run** action key.

When the program stops, the code window shows that the program stopped at the next reference to the variable `num_checks`. Due to the latency of the emulation analyzer, the processor may halt up to two instruction cycles after the breakpoint has been detected.

Try running the program a few more times to see where it stops. (Notice that `num_checks` is passed by reference to `interrupt_sim`. Since `counter` points to the same address as `num_checks`, the debugger stops at references to `counter`.)

- 3 Delete the access breakpoint. Select **Window**→**Breakpoints**, place the mouse in the Breakpoint window, press and hold the right mouse button, and choose **Delete All Breakpoints**.

To use the command line

- 1 Select **Settings**→**Command Line** from the menu bar.

The command line area which appears at the bottom of the debugger window can be used to enter complex commands using either the mouse or the keyboard.

- 2 Build a command out of the command tokens which appear beneath the command line entry area.

To use the command line with the mouse, click on the button for each command token.

- 3 When the command has been built, type or select < Return> .

To use a C printf command

The command line's Expression Printf command prints the formatted output of the command to the Journal window using C format parameters. This command permits type conversions, scaling, and positioning of output within the Journal window.

- Using the command line, enter:

```
Expression Printf "%010d", num_checks
```

In this example, the value of *num_checks* is printed as a decimal integer with a field width of 10, padded with zeros.

```
Journal 1
> Expression Printf "%010d", num_checks
0000000011
```

To turn the command line off

- 1 Move the mouse pointer to the Status line.
- 2 Hold down the shift key and click the right mouse button.

The shift-click operation selects the second item from a pop-up menu, which in this case is **Command Line On/Off**.

You can turn the command line on and off from the Settings pull-down menu, the Status pop-up menu, and the command line pop-up menu.

To trace events following a procedure call

- 1 Position the mouse pointer over the call to *update_system()* on line 102.
- 2 Select **Trace after** from the Code window pop-up menu.

102	update_system();	Debugger Display	
103	num_checks++;		
104	interrupt_sim(&num_ch		Set/Delete Breakpoint
105	if (graph)		Edit source
106	graph_data();		Attach Macro ...
107	proc_specific();		Edit Attached Macro ...
108	}		Run until
109	}		Trace after
			Trace before
		Trace about	
		Trace until	

- 3 Run the program by clicking on the **Run** action key.

Notice that the debugger interface is "grayed out" and that the mouse pointer is an hourglass when the mouse is in the debugger X window. This means that the program is executing.

Chapter 1: Getting Started with the Graphical Interface
To trace events following a procedure call

- 4 Wait for the status line to show `TRC: Cmp1 t`, then press `< Ctrl> -C` in the debugger window.
- 5 Select **Window**→**Trace** to see the bus states which occurred after the call to `update_system()`.

The trace listing will be displayed in the Trace Mode debugger window. If an emulator/analyzer X window is active, it will display the trace listing. You can scroll through the trace to see more bus states.

```
Trace Mode 24
In main\main. Line 103
+ Line 103          num_checks++;
  Line 104          interrupt_sim(&num_checks);
8. Enter main\interrupt_sim
  Lines 110..122 {
12. Lines 123..127  limit = (*counter % 10) * (*counter % 10) / 3;
ESC-ESC=Quit mode F2=New Top Line F6=Track Direction(^) F7=Track
```

- 6 Press the `< ESC>` key to exit the trace display.



To see on-line help

- 1 Select **Help**→**General Topic ...**
- 2 Select **To Use Help**, then click on the **OK** button.

Spend a few minutes exploring the help topics, so that you can find them when you need them.

To end the debugging session

- Use the *command select* mouse button to choose **File→Exit→Released (all windows, release emulator)**.

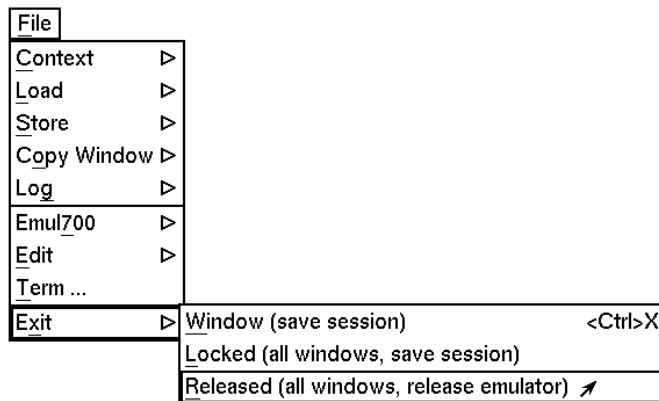

The debug session is ended and your system prompt is displayed. The Released option unlocks the emulator so that other users on your system can use it.

This completes your introduction to the 68040 Debugger/Emulator. You have used many features of the debugger. For additional information on performing tasks with the debugger, refer to the "User's Guide" part of this manual. For more detailed information on debugger commands, error messages, etc., refer to the "Reference" part of this manual.

Chapter 1: Getting Started with the Graphical Interface
To end the debugging session

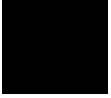



Getting Started with the Standard Interface

How to get started using the debugger's character-based interface.

The Standard Interface At a Glance

The debugger has a *standard interface* for several types of terminals, terminal emulators, and bitmapped displays. When using the standard interface, commands are entered from the keyboard.

This interface will be started if the DISPLAY environment variable is not defined, an X window cannot be opened, or the `-t` command line option is used.

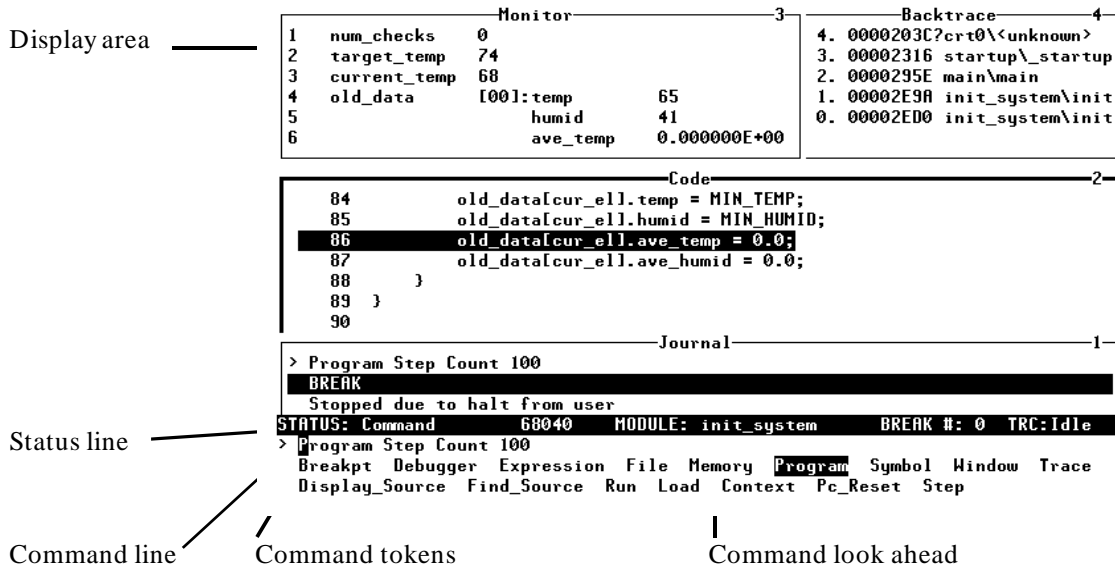

Display area. Can show assembly level screen, high-level screen, simulated I/O screen, or user-defined screens. These screens contain windows that display code, variables, the stack, registers, breakpoints, etc. You can use the UP ARROW, DOWN ARROW, PAGE UP, and PAGE DOWN cursor keys to scroll or page up or down the information in the active window.

Status line. Displays the debugger and emulator status, the CPU, the current program module, the number of the last breakpoint, and the trace status.

Command line. Commands are entered on the command line at the debugger prompt (>) and executed by pressing the <Return> key. Command tokens are placed on the command line by typing the first uppercase letter of the token. The Tab and Shift-Tab keys allow you to move the cursor on the command line forward or backward. The Clear line key clears from the cursor position to the end of the line. The <Ctrl>-U key clears the whole command line.

Command tokens. The second line under the status line shows the tokens that you can enter at the current location in the command line.

Command look ahead. The third line under the status line shows tokens that are available if you select the highlighted command token above.



The Quick Start Tutorial

This tutorial gives you step-by-step instructions on how to perform basic tasks using the debugger.

Perform the tasks in the sequence given; otherwise, your results may not be the same as those shown here.

Some values displayed on your screen may vary from the values shown here.

Before You Begin

This chapter assumes you have already installed the debugger as described in the "Installation" chapter.

The emulator name *em68040* is used in the examples in this chapter. If you have given your emulator a different logical name in the HP 64700 emulator device table */usr/hp64000/etc/64700tab.net*, use your emulator name or lan address in the examples. See the *HP 64700A Card Cage Installation/Service Manual* for detailed information on installing your emulator.

Note

Some commands are printed on two lines in this chapter. When entering these commands, type the entire command on one line.

The Demonstration Program

The demonstration program used in this chapter is a simple environmental control system (ECS). The system controls the temperature and humidity of a room requiring accurate environmental control. The program continuously looks at flags which tell it what action to take next.

To copy the demonstration files

Before you can run the demonstration program, you must copy the debugger demo files to a new subdirectory. Perform the following steps to make the subdirectory and copy the demo files into it.

- 1 Make a subdirectory for the debugger demo files.

Make sure the present working directory is the one in which you wish to create the subdirectory for the debugger demo files. Then, enter the command:

```
mkdir mydirectory
```

where *mydirectory* is the name of your debugger demo subdirectory.

- 2 Change to the debugger demo subdirectory:

```
cd mydirectory
```

- 3 Copy the demo files:

```
cp -r /usr/hp64000/demo/debug_env/hp64783/* .
```

All files that you need to run the demonstration program should now be in the working directory.

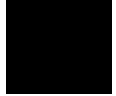

To start the debugger

- Start the debugger by entering:

```
db68k -t -e em68040 -C Config  
      -c cmdfiles/debug/Cmd_dbstart ecs
```

Enter the command as one line.

The **-t** option starts the debugger's standard interface.

The **-e em68040** option tells the debugger which emulator to use.

If the logical name of your emulator is not *em68040*, then use the name of your emulator or the emulator's lan address instead of *em68040*.

The **-C Config** option tells the debugger how to set up memory mapping for the program.

The **-c cmdfiles/debug/Cmd_dbstart** option tells the debugger to execute the *Cmd_dbstart.com* command file.

The **ecs** argument tells the debugger to load the *ecs.x* absolute file. This command starts execution of the debugger, which executes the command file *Cmd_dbstart.com* and loads the absolute file *ecs.x*.

Note

Do not start the standard interface as a background process. Doing this has unpredictable results, especially under SunOS.

In other words, never use both the "-t" option and the "&" symbol when you start the debugger.

To enter commands

- 1 Type the first letter of one of the command tokens listed below the command entry line.
- 2 Type the first letter of the next command token, if any.
- 3 Type any necessary parameters. They are indicated on the command token line in < angle brackets> .
- 4 Press <Return> to enter the command.

You may edit the command you are entering. See the section “To edit the command line” in the “Entering Debugger Commands” chapter for more information on how to enter and edit commands.

Note

If a portion of the previous command is still visible on the command line, press <Ctrl>-E to clear to the end of the command line before pressing <Return>.

To activate display area windows

Notice there are several windows in the main display area of the debugger. The different windows contain different types of information from the debugger. The active window has the thicker border. It is in the active window that the scroll bar and the PAGE UP and PAGE DOWN keys have an effect. There are several ways to activate a window in the display area.

- Press the F1 function key to activate the next higher numbered window or the F2 function key to activate the next lower numbered window.

Or:

Chapter 2: Getting Started with the Standard Interface

To display main()

- Using the command line, enter the Window Active command.

Try changing the active window a few times. Activate the Code window when you are done.

To display main()

- Enter the following command:

```
Program Display_Source main
```

Remember, to enter this command all you need to type is "P" then "D" then "main" then **<Return>**.

The *main()* function is displayed. Use the UP ARROW key to see the "main()" statement.

To display a function

Notice that *main()* calls *update_system()*.

- Enter the following command:

```
Program Display_Source update_system
```

The *update_system()* function is displayed. Use the UP ARROW key to see the "update_system()" statement.

To set a breakpoint

Suppose you want to execute up to the call to *update_system()*. To do this you could set a breakpoint at the statement "update_system()" and run the program.

- Using the command line, enter:

```
Breakpt Instr update_system
```

The breakpoint window is displayed, showing the breakpoint has been added.

An asterisk (*) appears in the first column of the Code window next to the location of the breakpoint. The dot (.) in the first column of the previous lines show the source lines associated with that breakpoint.

To run the demo program

- Using the command line, enter:

```
Program Run
```

The journal window shows that a break occurred and which breakpoint it was.

Notice that the source file line at which the breakpoint was set is now in inverse video. The inverse video line shows the current program counter. You should now be viewing the *update_system()* routine.

To step through the program

You can execute one source line (high-level mode) or one instruction (assembly-level mode) at a time by stepping through the program.

- Using the command line, enter:

```
Program Step
```

You can step again by just pressing **<Return>**.

As the debugger steps through the program, you can see the PC progress through the source code, as shown by the inverse video line in the Code window.

To step over functions

You can either step through functions or step over functions. When you step over a function, it is executed as a single program step.

- Using the command line, enter:

```
Program Step Over
```

To delete a breakpoint

Once you set a breakpoint, program execution will break each time the breakpoint is encountered. If you don't want to break on a certain breakpoint again, you must delete the breakpoint. Suppose you want to delete the breakpoint that was previously set at the statement "update_system()".

- 1 Run the program up to the breakpoint:

Program Run

- 2 Using the command line, enter:

```
Breakpt Delete 1
```

The breakpoint window is displayed, showing the breakpoint has been deleted.

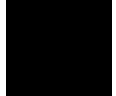

To display variables in their declared type

Whenever you specify a variable name without a C or debugger operator prefix, it is displayed in its declared type.

- Using the command line, enter:

```
Expression Display_Value current_temp
```

In the Journal window, the current value of the variable is displayed in its declared type (int).

To display the address of a variable

You can use the C address operator (&) to display the address of a program variable.

- Using the command line, enter:

```
Expression Display_Value &current_temp
```

The result is the address of the variable *current_temp*. The address is displayed in hexadecimal format.

To use a C printf command

The Expression Printf command prints the formatted output of the command to the Journal window using C format parameters. This command permits type conversions, scaling, and positioning of output within the Journal window.

- Using the command line, enter:

```
Expression Printf "%010d",current_temp
```

In this example, the value of *current_temp* is printed as a decimal integer with a field width of 10, padded with zeros.

The Expression Fprintf command can be used to print formatted output to a file or user-defined window.

To break on an access to a variable

You can also set breakpoints on a read, a write, or any access of a variable. This helps to locate defects due to multiple functions accessing the same variable. Suppose you want to break on the access of the variable *¤t_temp*.

- 1 Set the access breakpoint:

```
Breakpt Access &current_temp
```

- 2 Run the program:

```
Program Run
```

When the program stops (after approximately ten seconds), the code window shows that the program stopped at the next reference to the variable *current_temp*. Due to the latency of the emulation analyzer, the processor may halt up to two instruction cycles after the breakpoint has been detected.

Try running the program (just press **<Return>**) a few more times to see where it stops. If the program had a pointer to the variable, it would stop there, too.

- 3 Delete the access breakpoint.

Using the command line, enter:

```
Breakpt Delete 1
```



To display blocks of memory

You can display structures and arrays in memory as well as ranges of memory locations that encompass several variables.

- Using the command line, enter:

```
Memory Display Byte &current_temp
```

The debugger displays a block of memory starting at the address of the variable *current_temp*.

The C address operator `&` is used because the Memory Display command is an assembly-level command and expects a memory address as its argument.

To monitor variables

The Expression Monitor Value command allows you to monitor a variable's value during execution of your program.

- Using the command line, enter:

```
Expression Monitor Value current_temp
```

The value of *current_temp* is now displayed in the Monitor window.

To modify a variable by entering a C expression

The Expression C_Expression command calculates the value of a C expression or modifies a C variable if the C expression contains the assignment operator (=). This command recognizes variable types and the assignment expression specified behave according to the rules of C.

- Using the command line, enter:

```
Expression C_Expression current_temp = 99
```

Notice that the value of *current_temp* in the Monitor window has changed to the number you entered.

To end the debugging session

- Enter:

`Debugger Quit Released`

The debug session is ended and your system prompt is displayed. The emulator is released so that other people can use it.

The Released option unlocks the emulator so that other users on your system can use it.

This completes your introduction to the debugger. For additional information on performing tasks with the debugger, refer to the "User's Guide" part of this manual. For more detailed information on debugger commands, error messages, and so on, refer to the "Reference" part of this manual.



Chapter 2: Getting Started with the Standard Interface
To end the debugging session

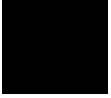

Part 2

User's Guide

Part 2

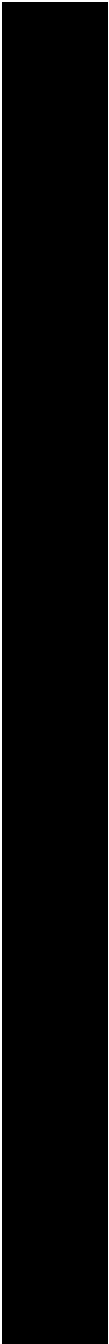



Entering Debugger Commands

How to enter debugger commands using the mouse or the keyboard.

Entering Debugger Commands

This chapter shows you how to enter debugger commands using the graphical interface or the standard interface. The tasks are grouped into the following sections:

- Starting the debugger.
- Using menus, the entry buffer, and action keys.
- Using the command line with the mouse.
- Using the command line with the keyboard.
- Viewing debugger status.

The *graphical interface* provides an easy way to enter commands using a mouse. It lets you use pull-down and pop-up menus, point and click setting of breakpoints, cut and paste, on-line help, customizable action keys and pop-up recall buffers, and other advanced features. To use the graphical interface, your computer must be running an X Window System that supports OSF/Motif interfaces.

The debugger also has a *standard interface* for several types of terminals, terminal emulators, and bitmapped displays. When using the standard interface, commands are entered from the keyboard.

When using the graphical interface, the *command line* portion of the interface gives you the option of entering commands in the same manner as they are entered in the standard interface. If you are using the standard interface, you can only enter commands from the keyboard using the command line.

Function Key Commands

You can enter commonly used commands quickly and easily by pressing the function keys F1 through F8 on your keyboard. Function keys can be used in the graphical interface as well as the standard interface. The following table and figure describe the commands associated with the function keys.

If you are using the debugger on a Sun SPARCsystem, refer to the "Installation" chapter for information on mapping function keys.

Function Key Commands

Function Key	Graphical Equivalent, Command Line Equivalent	Description
F1	Display →Next Window, Window Active Next	Activate the next higher numbered window.
F2	Display →Previous Window, Window Active Previous	Activate the next lower numbered window.
F3	Settings →High Level Debug or Settings →Assembly Level Debug, Debugger Level	Switch between assembly-level and high-level mode.
F4	Right click on active window border, Window Toggle_View	Select the alternate display of the active window.
F5	Help →Command Line..., Debugger ? (Help)	Access on-line help.
F6	Display →Simulated I/O, Window Screen_On Next	Access the standard I/O screen. Also access any existing user-defined screens.
F7	Execution →Step Instruction→from PC, Program Step	Execute one C source line (high-level mode), or execute one microprocessor instruction (assembly-level mode).
F8	Execution →Step Source→from PC, Program Step Over	Execute one C source line, but treat whole functions as a single line (high-level mode); execute one microprocessor instruction, but treat whole subroutines as a single instruction.

Command Line Control Character Functions

Press the control key **<Ctrl>** simultaneously with the **B, C, E,F, G, L, Q, R, S, U,** or **** keys to execute the operations listed in the following table. (The letter keys may be upper- or lower-case.)

Command Line Control Character Functions

Control	Function
<Ctrl> B	Recall command reverse.
<Ctrl> C	Abort the current command and return to debugger command mode.
<Ctrl> E	Clear to end of command line.
<Ctrl> F	Shift contents of active window to right.
<Ctrl> G	Shift contents of active window to left.
<Ctrl> L	Redraw screen.
<Ctrl> Q	Resume output to screen (standard interface only).
<Ctrl> R	Recall previous command.
<Ctrl> S	Suspend output to screen (standard interface only).
<Ctrl> U	Clear command line
<Ctrl> \	End the debug session (same as Debugger Quit Released command)

The Journal Window

The debugger displays debugger commands entered from the keyboard in the Journal window. The Journal window also displays warning and informational messages from the debugger and output generated by commands. This window is available in both the high-level and assembly-level screens.

Starting the Debugger

Use the *db68k* command to start the debugger.

See Also

The “Getting Started with the Graphical Interface” chapter for information about starting the graphical interface.

The “Getting Started with the Standard Interface” chapter for information about starting the standard interface.

The “Loading and Executing Programs” chapter for information about loading programs as you start the debugger.

The “Using Macros and Command Files” chapter for information about loading command files as you start the debugger.

The “Configuring the Debugger” chapter for information about using debugger startup files.

The on-line "manual page" for information about the *db68k* command and its command-line options. To see this information, type the following operating system command:

```
man db68k
```



Using Menus, the Entry Buffer, and Action Keys

This section describes the tasks you perform when using the debugger's graphical interface to enter commands. This section describes how to:

- Choose a pull-down menu item using the mouse.
- Choose a pull-down menu item using the keyboard.
- Use the pop-up menus.
- Use action keys.
- Use the entry buffer.
- Copy and paste to the entry buffer.
- Use dialog boxes.
- Access help information.

To choose a pull-down menu item using the mouse (method 1)

- 1 Position the mouse pointer over the name of the menu on the menu bar.
- 2 Press and hold the *command select* mouse button to display the menu.
- 3 While continuing to hold down the mouse button, move the mouse pointer to the desired menu item. If the menu item has a cascade menu (identified by an arrow on the right edge of the menu button), then continue to hold the mouse button down and move the mouse pointer toward the arrow on the right edge of the menu. The cascade menu will display. Repeat this step for the cascade menu until you find the desired menu item.
- 4 Release the mouse button to select the menu choice.

Chapter 3: Entering Debugger Commands Using Menus, the Entry Buffer, and Action Keys

If you decide not to select a menu item, simply continue to hold the mouse button down, move the mouse pointer off of the menu, and release the mouse button.

Some menu items have an ellipsis (“...”) as part of the menu label. An ellipsis indicates that the menu item will display a dialog or message box when the menu item is chosen.

Note

The *command select* button can be either the left or right button, depending on the computer you are using. The “Getting Started with the Graphical Interface” chapter has a table which explains which button to use.

To choose a pull-down menu item using the mouse (method 2)

- 1 Position the mouse pointer over the menu name on the menu bar.
- 2 Click the *command select* mouse button to display the menu.
- 3 Move the mouse pointer to the desired menu item. If the menu item has a cascade menu (identified by an arrow on the right edge of the menu button), then repeat the previous step and then this step until you find the desired item.
- 4 Click the mouse button to select the item.

If you decide not to select a menu item, simply move the mouse pointer off of the menu and click the mouse button.

Some menu items have an ellipsis (“...”) as part of the menu label. An ellipsis indicates that the menu item will display a dialog or other box when the menu item is chosen.

To choose a pull-down menu item using the keyboard

- To initially display a pull-down menu, press and hold the *menu select* key (for example, the “Extend char” key on a HP 9000 keyboard) and then type the underlined character in the menu label on the menu bar. (For example, “f” for “File”. Type the character in lower case.)
- To move right to another pull-down menu after having initially displayed a menu, press the **right-arrow** key.
- To move left to another pull-down menu after having initially displayed a menu, press the **left-arrow** key.
- To move down one menu item within a menu, press the **down-arrow** key.
- To move up one menu item within a menu, press the **up-arrow** key.
- To choose a menu item, type the character in the menu item label that is underlined. Or, move to the menu item using the arrow keys and then press the < **RETURN** > key on the keyboard.
- To cancel a displayed menu, press the **Escape** key.

The interface supports keyboard mnemonics and the use of the arrow keys to move within or between menus. For each menu or menu item, the underlined character in the menu or menu item label is the keyboard mnemonic character. Notice the keyboard mnemonic is not always the first character of the label. If a menu item has a cascade menu attached to it, then typing the keyboard mnemonic displays the cascade menu.

Some menu items have an ellipsis (“...”) as part of the menu label. An ellipsis indicates that the menu item will display a dialog or other box when the menu item is chosen.

Dialog boxes support the use of the keyboard as well. To direct keyboard input to a dialog box, you must position the mouse pointer somewhere inside the boundaries of the dialog box. That is because the interface *keyboard focus*

policy is set to *pointer*. That just means that the window containing the mouse pointer receives the keyboard input.

In addition to keyboard mnemonics, you can also specify keyboard accelerators which are keyboard shortcuts for selected menu items. Refer to the “Setting X Resources” chapter and the “Debug.Input” scheme file for more information about setting the X resources that control defining keyboard accelerators.



To choose pop-up menu items

- 1 Move the mouse pointer to the area whose pop-up menu you wish to access. (If a pop-up menu is available, the mouse pointer changes from an arrow to a hand.)
- 2 Press and hold the right mouse button.
- 3 After the pop-up menu appears (while continuing to hold down the mouse button), move the mouse pointer to the desired menu item.
- 4 Release the mouse button to select the menu choice.

If you decide not to select a menu item, simply continue to hold the mouse button down, move the mouse pointer off of the menu, and release the mouse button.

Some pop-up menus which are available include:

- Display-area Windows.
- Status Line.
- Command Line.

To use pop-up menu shortcuts

- To choose the first item in a pop-up menu, click the right mouse button.
- To choose the second item in a pop-up menu, hold down the < **Shift** > key and click the right mouse button.

To place values into the entry buffer using the keyboard

- 1 Position the mouse pointer within the text entry area. (An “I-beam” cursor will appear.)
- 2 Enter the text using the keyboard.

To clear the entry buffer text area from beginning until end, press the < **Ctrl** > **U** key combination.

To copy-and-paste to the entry buffer

- To copy and paste a "word" of text, position the mouse pointer over the word and click the left mouse button.
- To specify the exact text to copy to the entry buffer, position the mouse pointer over the first character to copy, then hold the left mouse button while dragging the mouse pointer over the text. When you release the mouse button, the highlighted text will appear in the entry buffer.

You can copy-and-paste from the display area, the status line, and from the command line entry area.

Chapter 3: Entering Debugger Commands Using Menus, the Entry Buffer, and Action Keys

Note

If you have several graphical interface windows connected to the emulator, then a copy-and-paste action in any window causes the text to appear in all entry buffers in all windows. That is because although there are several entry buffers being displayed, there is actually only one entry buffer, which is shared by all windows. You can use this to copy a symbol or an address from one window to another window.

On a memory or trace display, you may need to scroll the display to show more characters of a symbol.

The interface displays absolute addresses as hex values. If you copy and paste an address from the display to the entry buffer, you must add a trailing “h” to make the interface interpret it as a hex value when you use the entry buffer contents with a command.

Text pasted into the entry buffer replaces that which is currently there. You cannot use paste to append text to text already in the entry buffer. You can retrieve previous entry buffer values by using the **Recall** button.

See “To copy-and-paste from the entry buffer to the command line entry area” for information about pasting the contents of the entry buffer into the command line entry area.

Example

To paste the symbol “init_system” into the entry buffer from the interface display area, position the mouse pointer over the symbol and then click the left mouse button.

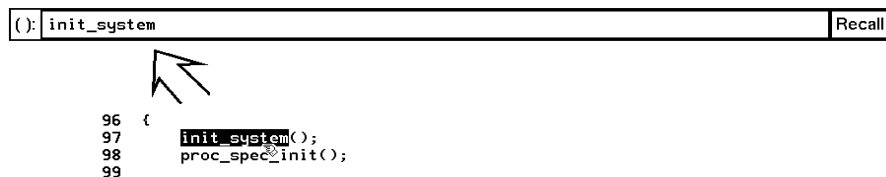

The screenshot shows a debugger interface. At the top, there is an entry buffer containing the text “(): init_system” and a “Recall” button on the right. Below the entry buffer, a code window displays the following code:

```
96 {  
97     init_system();  
98     proc_spec_init();  
99 }
```

A mouse cursor is positioned over the “init_system” symbol in the code window.

To recall entry buffer values

- 1 Position the mouse pointer over the **Recall** button just to the right of the entry buffer text area, and click the mouse button to bring up the Entry Buffer Value Selection dialog box.
- 2 In the dialog box, click on the string you want.
- 3 In the dialog box, click on the "OK" button.

The Entry Buffer Value Selection dialog box contains a list of previous values from the entry buffer. You can also predefine entries for the Entry Buffer Value Selection dialog box and define the maximum number of entries by setting X resources (refer to the “Setting X Resources” chapter).

If you decide not to change the contents of the entry buffer, click on the "Cancel" button in the dialog box.

If you want the Entry Buffer Value Selection dialog box to remain visible after you make a selection, press "Apply" instead of "OK". You may drag the dialog box to another location on your display so that it does not cover the debugger window.

See the following “To use dialog boxes” section for information about using dialog boxes.

To edit the entry buffer

- To position the keyboard cursor, click the left mouse button or use the arrow keys.
- To clear the entry buffer, type < **Ctrl**> -U.
- To delete characters, press the < **Backspace**> or < **Delete char**> keys.
- To delete several characters, highlight the characters to be deleted using the left mouse button, then press the < **Backspace**> or < **Delete char**> keys.

To use the entry buffer

- 1 Place information into the entry buffer (see the previous “To place values into the entry buffer using the keyboard”, “To copy-and-paste to the entry buffer”, or “To recall entry buffer values” task descriptions).
- 2 Choose the menu item, or click the action key, that uses the contents of the entry buffer.

The contents of the entry buffer will be used wherever the "()" symbol appears in a menu item or action key.

To copy-and-paste from the entry buffer to the command line entry area

- 1 Position the mouse pointer within the command line text entry area.

Chapter 3: Entering Debugger Commands

Using Menus, the Entry Buffer, and Action Keys

- 2 If necessary, reposition the keyboard cursor to the location where you want to paste the text.
- 3 If necessary, choose the insert or replace mode for the command entry area.
- 4 Click the middle mouse button to paste the text into the command line entry area at the current cursor position.

Note

You should paste to the command line *only* when the command line is expecting an address or a string. The characters from the entry buffer will be treated as if they were typed from the keyboard. If the command line is expecting keyword tokens, pasting can have unexpected results. For example, pasting "delta" into an empty command line will generate a "Debugger Execution Load_State ta" command!

Although a paste from the display area to the entry buffer affects all displayed entry buffers in all open windows, a paste from the entry buffer to the command line *only* affects the command line of the window in which you are currently working.

See “To copy-and-paste to the entry buffer” for information about pasting information from the display into the entry buffer.

To use the action keys

- 1 If the action key uses the contents of the entry buffer, place the desired information in the entry buffer.
- 2 Position the mouse pointer over the action key and click the action key.

Action keys are user-definable pushbuttons that perform interface or system functions. Action keys can use information from the entry buffer — this makes it possible to create action keys that are more general and flexible.

Several action keys are predefined when you first start the debugger’s graphical interface. You can use the predefined action keys to make, load,

run, and step through the demo program. You'll really appreciate action keys when you define and use your own.

Action keys are defined by setting an X resource. Refer to the chapter "Setting X Resources" for more information about creating action keys.

To use dialog boxes

- 1 Click on an item in the dialog box list to copy the item to the text entry area.
- 2 Edit the item in the text entry area (if desired).
- 3 Click on the "OK" pushbutton to make the selection and close the dialog box, click on the "Apply" pushbutton to make the selection and leave the dialog box open, or click on the "Cancel" pushbutton to cancel the selection and close the dialog box.

The graphical interface uses a number of dialog boxes for selection and recall:

Directory Selection	Selects the working directory. You can change to a previously accessed directory, a predefined directory, or specify a new directory.
File Selection	From the working directory, you can select an existing file name or specify a new file name.
Entry Buffer Recall	You can recall a previously used entry buffer text string, a predefined entry buffer text string, or a newly entered entry buffer string, to the entry buffer text area.
Command Recall	You can recall a previously executed command, a predefined command, or a newly entered command, to the command line.

The dialog boxes share some common properties:

- Most dialog boxes can be left on the screen between uses.

Chapter 3: Entering Debugger Commands

Using Menus, the Entry Buffer, and Action Keys

- Dialog boxes can be moved around the screen and do not have to be positioned over the graphical interface window.
- If you iconify the interface window, all dialog boxes are iconified along with the main window.

Except for the File Selection dialog box, predefined entries for each dialog box (and the maximum number of entries) are set via X resources (refer to the “Setting X Resources” chapter).

In file names, you may use a tilde as shorthand for your home directory.

Examples

To use the File Selection dialog box:

The file filter selects specific files.

A list of filter-matching files from the current directory.

A list of files previously accessed during the debugger session.

A single click on a file name from either list highlights the file name and copies it to the text area. A double click chooses the file and closes the dialog box.

Label informs you what kind of file selection you are performing.

Text entry area. Text is either copied here from the recall list, or entered directly.

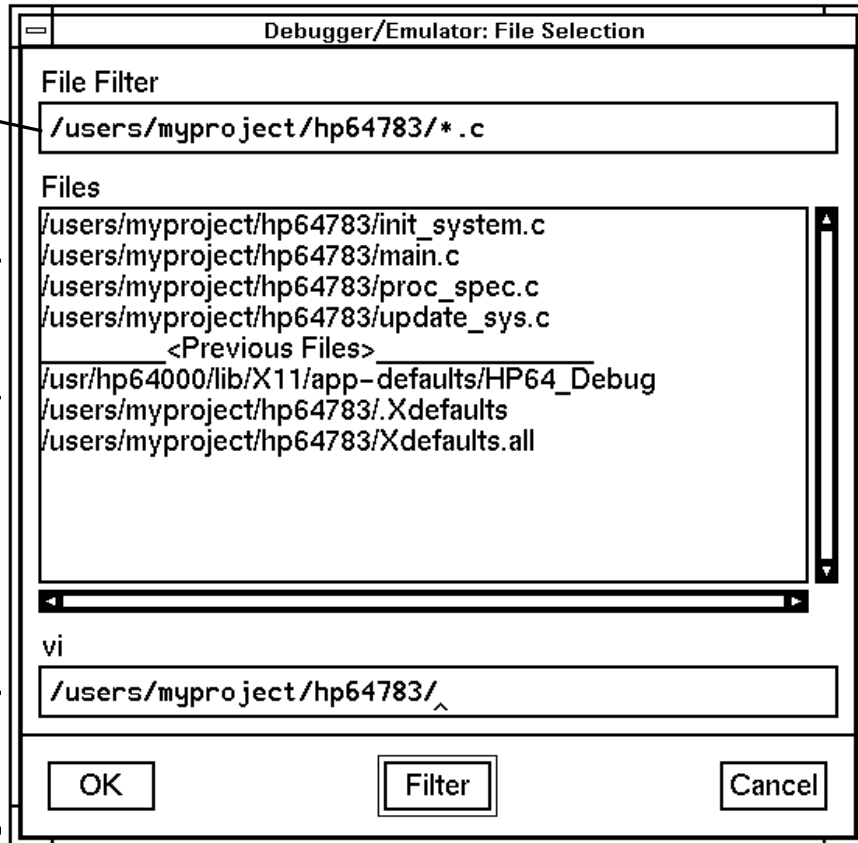

Clicking this button chooses the file name displayed in the text entry area and closes the dialog box.

Entering a new file filter and clicking this button causes a list of files matching the new filter to be read from the directory.

Clicking this button cancels the file selection operation and closes the dialog box.

Chapter 3: Entering Debugger Commands Using Menus, the Entry Buffer, and Action Keys

To use the Directory Selection dialog box:

Label informs you of the type of list displayed.

A single click on a directory name from the list highlights the name and copies it to the text area. A double click chooses the directory and closes the dialog box.

A list of predefined or previously accessed directories.

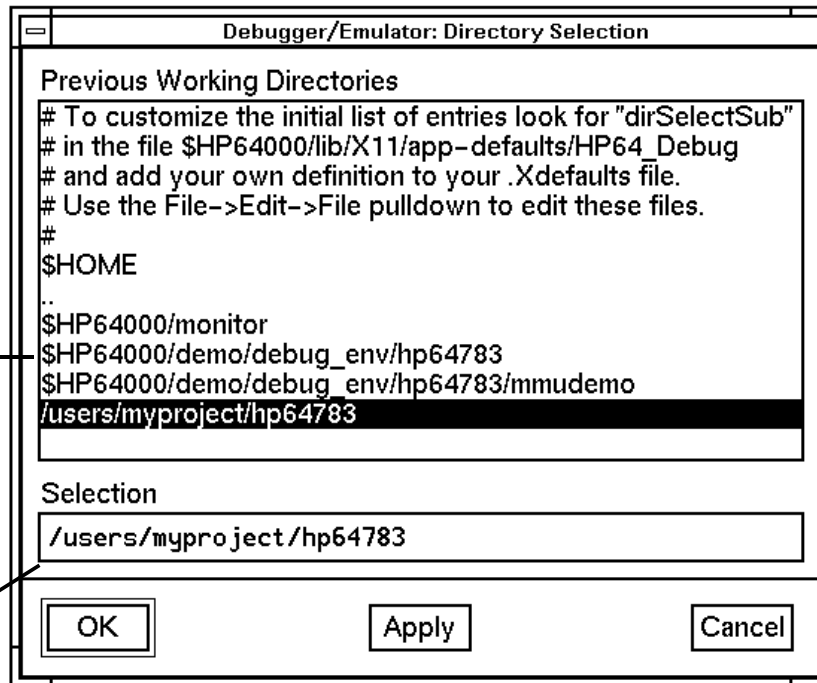

Text entry area. Directory name is either copied here from the recall list, or entered directly.

Clicking this button chooses the directory displayed in the text entry area and closes the dialog box.

Clicking this button chooses the directory displayed in the text entry area, but keeps the dialog box on the screen instead of closing it.

Clicking this button cancels the directory selection operation and closes the dialog box.

To access help information

- 1 Display the Help Index by choosing **Help**→**General Topic ...** or **Help**→**Command Line ...**
- 2 Choose a topic of interest from the Help Index.

The Help Index lists topics covering operation of the interface as well other information about the interface. When you choose a topic from the Help Index, the interface displays a window containing the help information. You may leave the window on the screen while you continue using the interface.

Examples

To see more information on how to use the on-line help, click on **Help**, then click on **General Topics ...**, then click on "To Use Help", then click on the "OK" button.

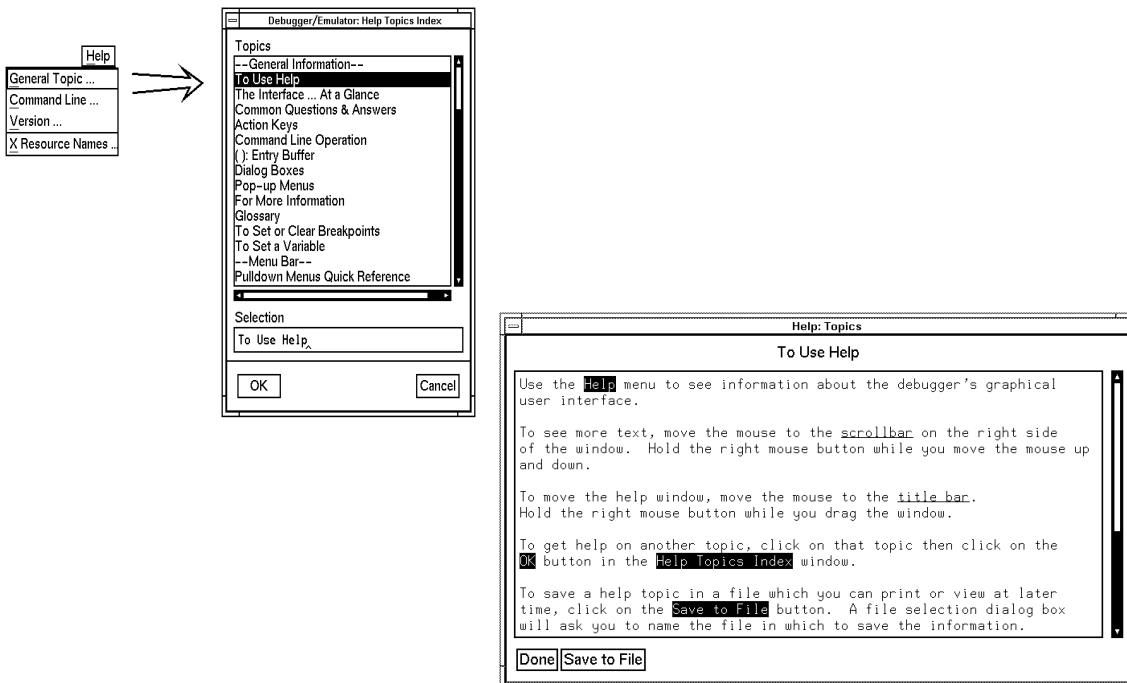

Using the Command Line with the Mouse

When using the graphical interface, the *command line* portion of the interface gives you the option of entering commands in the same manner as they are entered in the standard interface. Additionally, the graphical interface makes the command tokens pushbuttons so commands may be entered using the mouse.

If you are using the standard interface, the command line is the only way to enter commands.

This section describes how to:

- Turn the command line off/on.
- Enter commands.
- Edit commands.
- Recall commands.
- Display the help window.

To turn the command line on or off

- To turn the command line on or off using the pull-down menu, choose **Settings**→**Command Line**.
- To turn the command line on or off using the status line pop-up menu: position the mouse pointer within the status line area, press and hold the right mouse button, and choose **Command Line On/Off** from the menu.
- To turn the command line on or off with a single mouse click, hold the **< Shift >** key and click on the status line.
- To turn the command line off using the command line entry area pop-up menu: position the mouse pointer within the entry area, press and hold the right mouse button, and choose **Command Line On/Off** from the menu.
- To turn the command line on with the keyboard: place the mouse pointer in the display area and press any alphanumeric key.

"On" means that the command line is displayed and you can use the command token pushbuttons, the command return and recall pushbuttons, and the cursor pushbuttons for command line editing. "Off" means the command line is not displayed and you can use only the pull-down and pop-up menus and the action keys to control the interface.

The command line area begins just below the status line and continues to the bottom of the debugger window. The status line is not part of the command line and continues to be displayed whether the command line is on or off.

Choosing certain pull-down menu items while the command line is off causes the command line to be turned on. That is because the menu item chosen requires some input at the command line that cannot be supplied another way.



To enter a command

- 1 Build a command using the command token pushbuttons by successively positioning the mouse pointer on a pushbutton and clicking the left mouse button until a complete command is formed.
- 2 Execute the completed command by clicking the **Return** pushbutton (found near the bottom of the command line in the “Command” group).

Or:

Execute the completed command using the Command Line entry area pop-up menu: Position the mouse pointer in the command line entry area; press and hold the right mouse button until the Command Line pop-up menu appears; then, choose the **Execute Command** menu item.

You may need to combine pushbutton and keyboard entry to form a complete command.

A complete command is a string of partial commands or command tokens. You know a command is complete when “< return> ” appears on one of the command token pushbuttons. The interface does not check or act on a command, however, until the command is executed. (In contrast, commands resulting from menu choices and action keys are supplied with the needed carriage return as part of the command.)

To edit the command line using the command line pushbuttons

- To clear the command line, click the **Clear** pushbutton.
- To clear the command line from the cursor position to the end of the line, click the **Clear to end** pushbutton.
- To move to the right one command word or token, click the **Forward** pushbutton.
- To move to the left one command word or token, click the **Backup** pushbutton.
- To insert characters at the cursor position, press the **Insert char** key to change to insertion mode, and then type the characters to be inserted.
- To delete characters to the left of the cursor position, press the < **Backspace**> key.

When the cursor arrives at the beginning of a command word or token, the softkey labels change to display the possible choices at that level of the command.

When moving by words left or right, the **Backup** pushbutton is grayed out and unresponsive when the cursor reaches the beginning of the command string.

See “To edit the command line using the mouse and the command line pop-up menu” and “To edit the command line using the keyboard” for information about additional editing operations you can perform.



To edit the command line using the command line pop-up menu

- To clear the command line: position the mouse pointer within the Command Line entry area; press and hold the right mouse button until the Command Line pop-up menu appears; choose **Clear Entire Line** from the menu.
- To clear the command line from the cursor position to the end of the line: position the mouse pointer at the place where you want the clear-to-end to start; press and hold the right mouse button until the Command Line pop-up menu appears; choose **Clear to End of Line** from the menu.
- To position the cursor at the next token or the previous token: press and hold the right mouse button until the Command Line pop-up menu appears; choose **Forward Tab** or **Backward Tab** from the menu.

When the cursor arrives at the beginning of a command word or token, the softkey labels change to display the possible choices at that level of the command.

See “To edit the command line using the mouse and the command line pushbuttons” and “To edit the command line using the keyboard” for information about additional editing operations you can perform.

To recall commands

- 1 Click the pushbutton labeled **Recall** in the Command Line to display the dialog box.
- 2 Choose a command from the buffer list. (You can also enter a command directly into the text entry area of the dialog box.)

Because all command entry methods in the interface — menus, action keys, and command line entries — are echoed to the command line entry area, the

Chapter 3: Entering Debugger Commands Using the Command Line with the Mouse

contents of the Command Recall dialog box is not restricted to commands entered directly into the command line entry area.

The Command Recall dialog box contains a list of interface commands executed during the debugger session as well as any predefined commands present at interface startup.

You can predefine entries for the Command Recall dialog box and define the maximum number of entries by setting X resources (refer to the “Setting X Resources” chapter).

See “To use dialog boxes” for information about using dialog boxes.

To get help about the command line

- To display the help topic explaining the operation of the command line, select **Help**→**General Topic ...**→**Command Line Operation**.
- To display the command line help menu, select **Help**→**Command Line ...**

Using the Command Line with the Keyboard

Commands are entered on the command line at the debugger prompt (>) and executed by pressing the < **Return**> key. Command tokens are entered by typing a single letter, typically the first uppercase letter of the token.

The third and fourth lines of the status window display command tokens. The third line shows the tokens that you can enter at the current location in the command line. The fourth line shows tokens that are available if you select the highlighted command token on the third line. The command token lines provide you with a look ahead feature, showing you the debugger commands available to you at any time.

This section describes how to:

- Enter commands.
- Edit commands.
- Recall commands.
- Access on-line help information.

To enter debugger commands from the keyboard

- 1 Build a command using direct keyboard entry by successively typing letters corresponding to command tokens until a complete command is formed.
- 2 Execute a completed command using the keyboard, press the < **Return**> key on the keyboard.

You can enter commands any time the cursor is displayed on the command line. You can enter only one debugger command at a time.

Debugger commands have the following syntax:

```
command [qualifier...] [parameter...]
```

Chapter 3: Entering Debugger Commands Using the Command Line with the Keyboard

To enter a command keyword, type the first letter of the keyword. For example, to enter the command *Debugger Level Assembly*, type the letters D, L, and A. The following command will appear on the command line:

```
Debugger Level Assembly
```

Press < **Return**> to enter (execute) the command.

In command examples, the letter you must type is highlighted in bold type.

Note

In cases where you can select from more than one keyword beginning with the same letter, type the first uppercase letter of the desired keyword. For example, type **O** to select **On** and **F** to select **oFF**.

Enter qualifier keywords in the same way as command keywords. Qualifiers provide the debugger with information on how to execute the command. Qualifiers are normally single words that immediately follow the command name. For example, in the command:

```
Program Find_Source Next Backward
```

the qualifier *Backward* causes the debugger to search the file from the current position in the file towards the beginning of the file for a specified string.

Type parameters in their entirety from the keyboard. Parameters must be separated from the command or qualifier keyword by at least one space. Parameters describe the object of the command and are typically C expressions that represent values or addresses used by the command. For example, in the command:

```
Expression Display_Value &system_is_running
```

the parameter *&system_is_running* specifies the address of the variable *system_is_running*.

To edit the command line

- To clear the command line, press < **Ctrl**> **U**.
- To clear the command line from the cursor position to the end of the line, press < **Ctrl**> **E**.
- To move to the right one command word, press < **Tab**> .
- To move left or right character-by-character, press the ← and → keys.
- To delete characters to the left of the cursor position, press the < **BACKSPACE**> key.

When the cursor arrives at the beginning of a command word or token, the softkey labels change to display the possible choices at that level of the command.

To recall commands using the command line recall feature

- To recall commands from the command line, press the < **Ctrl**> **R** key combination. Continue to press < **Ctrl**> **R** to move from the most recently executed commands backward to earlier commands.
- To move forward in the recall list, press < **Ctrl**> **B**.

The command line recall feature is available to you, but it is not as easy to use or as flexible as the Command Recall dialog box in the graphical interface. You must search through commands in a linear fashion instead of going directly to the command you want in the dialog box. The depth of the recall list is predefined and cannot be controlled by you. The recall list may contain duplicate entries that you must scroll past and that take up room in the recall

list. Finally, you cannot predefine entries for the recall list — the list only contains the most recent commands executed during the debugger session.

To display the help window

- Press the function key **F5**.

Or:

- Enter the command

`Debugger ?`

This command displays a menu of debugger commands, command parameters, function keys, and other debugger features. Descriptions for each topic may be obtained by positioning the cursor on the first letter of any topic in the help menu and pressing the **< Return >** key.

The debugger's help window is context sensitive. When you display the help window, the cursor is located on the last command you entered before displaying the help window. The debugger assumes you need help with this command. Press **< Return >** to display information about the command.

Pressing **< Return >** or **< Down >** displays information on the next item in the help menu. Pressing **< Up >** displays information about the previous item in the help menu.

You can move the cursor to the first command of a command type (Breakpoint, Debugger, etc.) by entering the first letter of the command type. For example, to move the cursor to the entry for the first window command, enter:

W

Chapter 3: Entering Debugger Commands

Using the Command Line with the Keyboard

The cursor will be positioned at the **Window Active** command entry. Then you can use the cursor keys to select the window command you need help with and press < **Return**> to display information on that command.

Press the **F5** function key one time or press the escape (< **Esc**>) key twice to exit the help window. (Note that you cannot exit the graphical interface help window this way.)



Viewing Debugger Status

The status line shows you what the debugger is doing. The status line:

- Contains information about the operation being performed by the debugger.
- Contains indicators to warn you about special conditions.
- Shows the microprocessor being emulated.
- Shows the program module associated with the current program counter.
- Shows the number of the last breakpoint that occurred.
- Shows the trace measurement status.

The status line is always present in both the graphical interface and the standard interface.

The debugger displays the status line in the following format:

```
STATUS:<Status> [J][L][W] CPU MODULE: <module> BREAK #: <#> TRC:<Trc_status>
[R]
```

Debugger Status

The Status field on the status line shows the current state of the debugger. The possible values for this field are:

Command	The debugger is ready to accept a command or a macro definition.
Execute	The debugger is executing target environment instructions. The debugger displays <i>Execute</i> on the status line when you enter the Program Run command or the Program Step command.
ComFile	The debugger is reading commands from a command file.
Macro	The debugger is executing a macro.
Paused	The debugger is in the paused state after execution of the Debugger Pause command.

Chapter 3: Entering Debugger Commands

Viewing Debugger Status

Reading The debugger is reading an executable file or a C source file into the debugger's memory.

Working The debugger is executing internal debugger operations.

The status field may also display emulator status. See the emulator manual for detailed descriptions of the following states:

InMon The emulator is running in the monitor; the debugger will accept commands.

BusGrnt The emulated processor has granted its bus to another device.

Halted The emulated processor has entered a halted state.

uP Idle The emulator processor is idle.

Reset The emulated processor is being held in a reset state.

AwtRst The emulator is awaiting a target system reset.

Asleep The emulated processor is Asleep.

SlowBus The emulated processor's bus is responding slowly or not at all. This is probably the result of many wait states or a handshake at an unimplemented address.

SlowClk The emulated processor's clock is running slowly or not at all.

NotRdy The emulated processor's bus is being held in a "not ready" state. This is probably due to extended wait states or unimplemented memory.

Unknown The emulator has entered an unknown state. If this occurs, you should attempt to reset the processor into the monitor.

CMBWait The emulator is awaiting some action on its Coordinated Measurement Bus.

TargRst The emulated processor is being held in a reset state by the target system.

Indicator Characters

The Warning indicator (W) indicates that the program counter is not on a C source line boundary. The debugger displays a warning when it detects a breakpoint, an instruction halt, or an instruction error between lines.

The Log indicator (L) indicates that commands are being logged to a log file.

The Journal indicator (J) indicates that everything appearing in the Journal window is being written to a journal file.

The Register indicator (R) indicates that a register variable is being used, but its lifetime is not known by the debugger. The debugger displays an R when the variable is referenced, indicating that the values being used for this variable may not be valid.

CPU Emulated

The CPU entry indicates which microprocessor is being emulated.

Current Module

The MODULE: entry names the current module (< module>). The current module is the module pointed to by the program counter. If the program counter points outside of the known code area associated with the program, this entry displays ???????.

Last Breakpoint

The BREAK # entry indicates the number of the last breakpoint that occurred, or (0) zero if execution was not terminated with a breakpoint.

Trace Status

The TRC:< Trc_status> entry indicates the status of the trace measurement function. The possible values for <Trc_status> are listed on page 180 in the “Making Trace Measurements” chapter.



If pop-up menus don't pop up

When you hold the right mouse button down, a pop-up menu does not appear. Here are some things to check:

- Check that the mouse pointer is hand-shaped.

Some areas of the screen do not have pop-up menus.

- Check that your mouse buttons are not being redefined by your window manager.

If you are using **mwm** to redefine your mouse buttons, delete the redefinition from your `.mwmrc` file.

- If you are using an older window manager such as **mwm**, look in

```
/usr/hp64000/lib/X11/HP64_schemes/HP-UX/Debug.Input
```

Copy the line

```
HP64_Debug*whichButton: Button5
```

to your `.Xdefaults` file. Change the 5 to a 3.

4

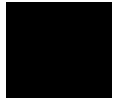

Loading and Executing Programs

How to load a program into the debugger and control its execution.

Compiling Programs for the Debugger

Using a Hewlett-Packard C Cross Compiler

Use the default compile mode when compiling your target programs for use with the debugger. The default settings generate executable files (.x file extension) in the HP-MRI IEEE-695 file format required by the debugger. The default option settings force a stack frame to be built for every function call, which is required for stack backtracing.

The "Getting Started" chapter of the *68030/040 C Cross Compiler User's Guide* gives an example of how to compile a simple program and execute it in the HP 64783 environment.

Note

Do not use the `-h` option when compiling and linking your program for the debugger. The `-h` option causes the compiler to generate HP 64000 file formats. Use the default settings which generate executable files in the HP-MRI IEEE-695 file format required by the debugger. The debugger extracts all symbolic information from the executable (.x) file.

Using Environment Dependent Files

The HP B1463 68040 C Cross Compiler provides environment dependent files that support the HP 64783 emulation environment. The debugger has the same simulated I/O capabilities as the HP 64000 Series emulators. The same environment dependent files are used for both the debugger and emulator environments. These environment dependent routines affect the following areas of C programming:

- program setup
- dynamic memory allocation
- program input and output

The "Environment Dependent Routines" chapter of the *68030/040 C Cross Compiler Reference* describes the environment dependent routines supplied with the compiler.

Using Optimizing Modes

If you use the optimizing modes (`-O` or `-OT`), function calls that do not have automatic variables may not have stack frames. As a result, the stack backtrace window will not contain entries for such functions. Additionally, the optimizing modes will cause the compiler to generate code which is not easily debugged.

Note

When initially compiling a program for the debugger, you should turn off all optimizations to avoid confusion when using the debugger. After program flow and all basic algorithms have been debugged, you can recompile the program with all optimizations turned on.

When you compile with all optimizations on, one or more of the following problems may occur while using the debugger:

- Target program execution in the debugger may not appear to correctly reflect the logical flow of the program.
- The debugger may not stop execution at a high-level breakpoint or may stop execution at the wrong location in the program.
- The debugger may not be able to display local variables.

Forcing Variables to be Placed in Memory

The default compiler settings automatically create register variables for statics and frequently used variables. Some debugger functions such as access breakpoints will not work with register variables. The compiler option `-Wc`, `-F` turns off the compiler's automatic creation of register variables, forcing the compiler to assign these variables to memory. This enables greater functionality of some debugger commands. After debugging your code, you can then recompile your code without these options for greater efficiency.

Using Math Libraries

Although FPU instructions can be executed in the target system, the debugger/simulator cannot execute these instructions. To generate code that will run interchangeably in both the debugger/emulator and debugger/simulator, use the C compiler's floating point library routines.

Chapter 4: Loading and Executing Programs

Compiling Programs for the Debugger

These libraries contain routines that do not use FPU instructions, thereby allowing them to execute properly in both debugging environments.

References

The “Getting Started” chapter of the *68030/040 C Cross Compiler User’s Guide* gives an example of how to compile a simple program and execute it in the debugger environment.

The “Command Syntax” chapter of the *68030/040 C Cross Compiler User’s Guide* gives detailed descriptions of compiler options.

The “Environment Dependent Routines” chapter of the *68030/040 C Cross Compiler Reference* describes the environment dependent routines supplied with the compiler.

Loading Programs and Symbols

This section shows you how to:

- Specify the location of C source files.
- Load programs.
- Load programs only (without symbols).
- Load symbols only (without the program).
- Load additional programs.
- Specify demand loading of symbols.

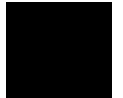

To specify the location of C source files

- Before you start the debugger, set the `HP64_DEBUG_PATH` environment variable.

The location of C source files can be defined to the debugger with the UNIX shell variable `HP64_DEBUG_PATH`. If `HP64_DEBUG_PATH` is defined, the debugger only searches for the files in the path(s) specified in `HP64_DEBUG_PATH`, in the order in which they are listed.

The `%` character can be included in the path to cause the debugger to search the location of the source files recorded in the absolute file.

If `HP64_DEBUG_PATH` is not defined, the debugger searches for source files in the following sequence:

- 1 their location at compile time (this information is recorded in the absolute file)
- 2 the current directory (if the required source files are not found in their compile location)

Example

The shell variable definition:

Chapter 4: Loading and Executing Programs

Loading Programs and Symbols

```
HP64_DEBUG_PATH=/users/proj/src:/users/proj/mysrc:%  
export HP64_DEBUG_PATH
```

causes the debugger to search paths for C source files in the following order:

- 1 /users/proj/src
- 2 /users/proj/mysrc
- 3 the paths specified in the absolute file at compile time

If you use the csh shell (most Sun systems), use **setenv** instead of **export** to set the variable.

To load programs

- When starting the debugger, enter the executable file name as the last term in the db68k command line.

```
$ db68k -e em68040 <abs_file>
```

Or:

- Select **File**→**Load**→**Executable**, then use the File Selection dialog box to select the executable file.

Or:

- Using the command line, enter:

```
Program Load Default <file_name>
```

When you load an absolute file using these commands, the debugger:

- 1 Removes all previous program symbols.
- 2 Removes all previously set breakpoints.
- 3 Resets the program counter (PC).
- 4 Loads the full symbol set.

5 Loads the new executable module.

Absolute files contain executable object code. They must have a file name extension of `.x`. You do not need to specify the `.x` file extension when entering the absolute file name.

The **Program Load Default** command is equivalent to the **Program Load New All Pc_Set** command.

Examples

To load the executable file `ecs.x`:

```
$ db68k -e em68040 ecs
```

Or:

```
Program Load Default ecs
```

To load programs code only

- Select **File→Load→Program Only ...**, then use the File Selection dialog box to select the absolute file.

Or:

- Using the command line, enter:

```
Program Load New Code_only No_Pc_Set <absolute_name>
```

Enter the name of the absolute file whose code is to be loaded, and press the **< Return >** key.

The code image will be loaded without loading symbols or resetting the PC.

If you are re-loading a program, you may need to re-specify variables for the Monitor window. To re-load a program without clearing the Monitor window, enter:

```
Program Load Append Code_only No_Pc_Set <absolute_name>
```

To load symbols only

- Use the `-I` option to the `db68k` command when starting the debugger.

```
$ db68k -e em68040 -I <absolute_file> <RETURN>
```

Or:

- Select **File→Load→Symbols Only ...**, then use the File Selection dialog box to select the absolute file.

Or:

- Using the command line, enter:

```
Program Load New Symbols_only No_Pc_Set <absolute_file>
```

Enter the name of the absolute file whose symbols are to be loaded, and press the **< Return >** key.

Only symbolic information is loaded from the absolute file.

When joining an emulation session already in progress, or when continuing a previously locked session, the debugger will attempt to load the symbols from the last executable loaded, if you do not specify the name of an executable on the command line,

To load additional programs

- Using the command line, enter:

```
Program Load Append
```

Select either `All`, `Code_Only`, or `Symbols_Only`. Then, select either `Pc_Set` or `No_Pc_Set`. Finally, enter the name of the absolute file to be appended, and press the < **Return** > key.

<code>All</code>	both code and symbols are loaded.
<code>Code_Only</code>	only code from the absolute file is loaded.
<code>Symbols_Only</code>	only symbols from the absolute file are loaded.
<code>Pc_Set</code>	the program counter (PC) is set to the transfer address found in the absolute file.
<code>No_Pc_Set</code>	the program counter (PC) is not changed.

When you append a program, it is loaded without deleting the existing program. The new symbols will be added in a tree with the executable file name as the root.

Examples

To append the program “module2.x” to the current program without setting the program counter:

```
Program Load Append All No_Pc_Set module2
```

To specify demand loading of symbols

- Use the `-d` option when starting the debugger.

The `-d` option turns on demand loading of symbols, loading some symbol information on an as-needed, demand basis rather than during the initial load of the `.x` file.

Symbol information for global symbols, local symbols in the source module containing `main`, and local symbols in assembly modules are loaded during the initial load of the `.x` file. Local symbols in C source modules other than that module which contains `main` are loaded either when the user explicitly references the module or when the program is stopped with the program

Chapter 4: Loading and Executing Programs

Loading Programs and Symbols

counter in the module. The primary advantage of demand load is that it lets you load and debug programs that otherwise would not be loadable because of very large amounts of symbol information.

There are several side effects of demand loading. The debugger command Memory Unload_BBA is disabled. Type mismatch errors may not be detected during the initial load of the .x file. Global symbols may have leading underscores stripped depending on whether they were defined/referenced in a C or assembly source module.

Examples

To specify demand loading of symbols when starting the debugger:

```
$ db68k -e em68040 -d <RETURN>
```

To prevent demand loading of symbols

- Use the -doff option when starting the debugger.

The -doff option turns off demand loading of symbols. This option will override the option in the startup file.

Stepping Through and Running Programs

The various Program Run command options can be combined to make complex run-time control commands for your program.

This section shows you how to:

- Step through programs.
- Step over functions.
- Run from the current PC address.
- Run from a start address.
- Run until a stop address.

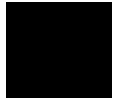

To step through programs

- Click on the **Step** action key.

Or:

- Select **Execution**→~~Step~~→**from PC**.

Or:

- Using the command line, enter:

```
Program Step
```

And press the < **Return** > key.

Your program executes one C source line (high-level mode) or one machine instruction (assembly-level mode) at a time from the address contained in the program counter (PC). When the program calls a function, stepping continues in the called function.

Chapter 4: Loading and Executing Programs

Stepping Through and Running Programs

You can specify a starting address with the Program Step command. You can also specify a step count to cause the debugger to step multiple lines or instructions in your program.

The debugger updates the screen after each instruction or line is executed. The highlighted line in the Code window (which indicates the value of the program counter) is the location of the next line to be executed. If a breakpoint is encountered, single-stepping is halted.

You can also use function key *F7* to single-step.

If the debugger steps into an HP library routine, run until the stack level above the level of the library routine. Use the Program Run Until command or the Backtrace window pop-up menu.

To step over functions

- Click on the **Step Over** action key.

Or:

- Select **Execution**→**Step Over**→**from PC**.

Or:

- Using the command line, enter:

```
Program Step Over
```

And press the < **Return** > key.

The debugger steps through the program one line or one instruction at a time. However, if the debugger encounters a C function or assembly-level JSR or CALL instruction, it stops stepping, executes the JSR or CALL instruction, and then continues stepping when the called subroutine returns.

You can also use function key *F8* to step over functions.

To run from the current PC address

- Click on the **Run** action key.

Or:

- Select **Execution**→~~Run~~→**from PC**.

Or:

- Using the command line, enter:

Program Run

And press the < **Return** > key.

The program runs until:

- The program encounters a permanent or temporary breakpoint.
- An error occurs.
- A STOP instruction is encountered.
- You press < **Ctrl** > -**C**.
- The program terminates normally.

You can run from the current program counter address to resume program execution after the program has been stopped.

To run from a start address

- 1 Enter the start address into the entry buffer.

- 2 Select **Execution**→~~Run~~→**from ()**.

Or:

- Using the command line, enter:

```
Program Run From <start_addr>
```

Type in the start address, and press the **< Return>** key.

The program runs until:

- The program encounters a permanent or temporary breakpoint.
- An error occurs.
- A STOP instruction is encountered.
- You press **< Ctrl> -C**.
- The program terminates normally.

Running from a start address in high-level mode may cause unpredictable results if the compiler startup routine is bypassed.

To run until a stop (break) address

- 1 Enter the stop address into the entry buffer.
- 2 Select **Execution** → **Run** → **until ()** or click on the **Run til ()** action key.

Or:

- Using the command line, enter:

```
Program Run Until <break_addr>
```

Type in the stop address and, optionally, a pass count, and press the **< Return>** key.

The break address (**< break_address>**) acts as a temporary instruction breakpoint. It is automatically cleared when program execution is halted.

The pass count (**< pass_count>**) parameter specifies the number of times the break address is executed before the program is halted. For example, a pass

Chapter 4: Loading and Executing Programs Stepping Through and Running Programs

count of three will cause the program to break on the fourth execution of the break address.

Multiple break addresses are OR'ed. In other words, if you specify more than one break address, the program runs until either address is encountered.

The 68040 debugger/emulator allows you to set instruction breaks in *any* type of memory, including target ROM. A maximum of 8 breakpoints may be set in target ROM.

Examples

To run the program until either line 20 or line 90 is encountered, whichever occurs first.

```
Program Run Until #20,#90
```

To run from the current program counter address until the break address *update_state_of_system* is encountered twice:

```
Program Run Until update_state_of_system %%2
```

The Until option in the command sets a temporary breakpoint at address *update_state_of_system*. The pass count parameter %%2 specifies that the debugger is to stop program execution on the second access to address *update_state_of_system*.

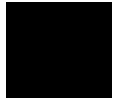

Using Breakpoints

The debugger implements access, read, and write breakpoints using analyzer hardware .

The debugger implements instruction breakpoints using software breakpoints.

This section shows you how to:

- Set a memory access breakpoint (read, write, or either).
- Set an instruction breakpoint.
- Clear selected breakpoints.
- Clear all breakpoints.
- Display breakpoint information.

To set a memory access breakpoint

- Enter the address (which may be a symbol) in the entry buffer. Select **Breakpoints**→**Set** and select **Read**, **Write**, or **Read/Write**.

Or:

- Using the command line, enter **Breakpt** select the type of access to break on (Read, Write, or Access), enter the address of the memory location, and press the < **Return**> key.

The access types have the following meanings:

Read break on read accesses.

Write break on write accesses.

Access break on either read or write accesses.

Access breakpoints cause the debugger to halt program execution each time the target program reads from or writes to the specified memory location(s). Memory locations can contain code or data.

The debugger uses the emulation analyzer to implement access breakpoints. The analysis hardware has eight single break resources and one range break resource. Each breakpoint command uses one or more of the analysis resources.

The following commands each use one analysis break resource:

- Breakpt Access < addr>
- Breakpt Read < addr>
- Breakpt Write < addr>

The command *Breakpt Access <addr>..<addr>* uses the one range break resource.

The commands *Breakpt Read <addr>..<addr>* or *Breakpt Write <addr>..<addr>* use the analysis range resource and four analysis break resources.

If you request more access breakpoints than there are available in the analysis hardware, the message *Breakpoint limit exceeded* will be displayed on your screen. If this happens, you must delete an existing analysis breakpoint before you can enter a new one.

Due to the latency of the emulation analyzer, the processor will halt from 0 to 2 instruction cycles after the breakpoint is detected. Due to the processor's prefetch feature, it is possible for hardware breaks to occur on addresses of instructions that are not executed.

An address can be accessed without the address appearing on the bus. In this case, a break will not occur. Be sure to read the "Limitations to the Trace Function" section in the introduction to the "Making Trace Measurements" chapter.

Note

The emulator user interface may specify a trace that overrides a debugger access breakpoint. The debugger interface will set up the access breakpoint trace when a run or step command is issued only if the analyzer is not currently in use. Using both access breakpoints in the debugger and trace features in the emulator is not recommended.

Examples

To cause execution to halt each time the program reads from or writes to the variable `current_temp`:

```
Breakpt Access &current_temp
```

To cause execution to halt each time the program reads from the variable `current_temp`:

```
Breakpt Read &current_temp
```

To cause execution to halt each time the program writes to the variable `current_temp`:

```
Breakpt Write &current_temp
```

To set an instruction breakpoint

- Position the mouse pointer in the code window over the line at which you wish to set a breakpoint. Either click the right mouse button, or press and hold the right mouse button to display the Debugger Display pop-up menu and choose **Set/Clear Breakpoint** from the menu.

Or:

- Enter the instruction address into the entry buffer, then select **Breakpoints**→**Set**→**Instruction** ().

Or:

- Using the command line, enter:

```
Breakpt Instr <addr>
```

Enter the address of the instruction location, and press the **< Return >** key.

The instruction breakpoint causes the debugger to halt program execution each time the target program attempts to execute an instruction at the

specified memory location(s). The debugger halts program execution before the program executes the instruction at the breakpoint address.

If you specify a range, the debugger sets breakpoints on the first byte of each instruction within the specified range.

Set breakpoints are marked with asterisks "*" in the code window. In the high-level mode, dots "." show the source lines associated with a breakpoint.

Instruction breakpoints are implemented using the emulator's software breakpoint capability. These breakpoints are implemented by replacing the program opcode with a BKPT instruction. Executing the BKPT instruction causes program control to be transferred to the emulation monitor, stopping the program.

Because a BKPT instruction must replace the instruction at a memory location, software breakpoints can only be set in:

- Emulation RAM.
- Emulation ROM.
- Target system RAM.

Software breakpoints cannot be set in target ROM. Software breakpoints cannot be used to detect data accesses.

Note

The default setting of the debugger option *Align_Bp* (align breakpoint) is *oFF*. Setting the option to *On* causes breakpoints to be aligned based on the assembly language instructions found in memory at the time the breakpoints are set. If multiple breakpoints exist in the same program area, their alignment may be incorrect. Make sure the *Align_Bp* option is set to *oFF* to prevent breakpoint alignment problems. See the "Configuring the Debugger" chapter for more information.

BKPT instruction cannot be written to memory. Therefore, the breakpoint will never be executed.

If you answer *yes* to the configuration question *Break processor on write to ROM?*, you are not permitted to set breakpoints in areas mapped as target ROM.

Examples

To set an instruction breakpoint at line 82 of the current module:

Breakpt Instr #82

To set a breakpoint for a C++ object instance

- Use the dot or arrow operator to specify the object and the member function.

This allows you to set a breakpoint for a member function only when it is invoked for a given object or instance.

Example

To break when function *cfunc* is invoked by object instance *cobj1*, enter:

```
Breakpoint Instr cobj1.cfunc
```

To do this the hard way, you could enter:

```
Breakpoint Instr C::cfunc\@entry;when (C::cfunc\this==  
&cobj1)
```

To set a breakpoint for overloaded C++ functions

- To set a breakpoint at one of the functions when you know the argument type, supply the argument type following the function name.
- To set a breakpoint at one of the functions when you don't know which argument type you want, just use the name of the function. The debugger will list the choices with a menu in the Journal window.

Example

To set a breakpoint for the function *print* (which is not in a class) for **float** arguments, enter **print (float)** in the entry buffer and select **Breakpoints→Set ()**.

Another way to set a breakpoint for the function *print* is to enter `print` in the entry buffer, select **Breakpoints**→**Set ()**, then type the number of "print (float);" from the menu in the Journal window.

To set a breakpoint for C++ functions in a class

- Set a breakpoint for the C++ class.

Examples

To set breakpoints for all member functions of the class *classname*, enter "classname::" in the entry buffer, then select **Breakpoints**→**Set ()** from the menu bar.

Or, using the command line, enter:

```
Breakpoint Instr classname::
```

To clear selected breakpoints

- Position the mouse pointer in the Code window over the line at which you wish to clear a breakpoint. Click the right mouse button.

Or:

- Position the mouse pointer in the Code window over the line at which you wish to clear a breakpoint. Hold the right mouse button and select **Set/Clear Breakpoint**.

Or:

Chapter 4: Loading and Executing Programs Using Breakpoints

- Position the mouse pointer in the Breakpoint window over the breakpoint you wish to clear. Hold the right mouse button and select **Delete Breakpoint**.

Or:

- Enter the breakpoint number into the entry buffer, then select **Breakpoints→Delete ()**.

Or:

- Using the command line, enter:

```
Breakpt Delete <brkpt_nmbr>
```

Enter the breakpoint number, and press the **< Return >** key.

The debugger assigns a breakpoint number to each breakpoint. The debugger uses this number to remove the breakpoint.

The **< brkpt_nmbr >** is the number of the breakpoint displayed in the debugger breakpoint window. Enter a range of breakpoint numbers (**< brkpt_nmbr > ..< brkpt_nmbr >**) to remove more than one breakpoint at a time. When you delete a breakpoint, all following breakpoints are renumbered.

Examples

To delete breakpoint number 1:

```
Breakpt Delete 1
```

To clear all breakpoints

- Select **Breakpoints→Delete All**.

Or:

- Select **Delete All Breakpoints** from the Breakpoints window pop-up menu.

Or:

- Using the command line, enter:

```
Breakpt Clear_All
```

And press the < **Return** > key.

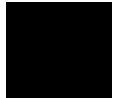

To display breakpoint information

- Select **Window→Breakpoints**.

Or:

- Using the command line, enter:

```
Window Active Breakpoint
```

And press the < **Return** > key.

The debugger displays the breakpoint window when:

- You enter a breakpoint command.
- You execute the Window Active Breakpoint command.
- You use function keys F1/F2 to activate next/previous windows.

The Breakpoint window temporarily overlays the top portion of the screen.

When made active, this window displays breakpoint information including:

- Breakpoint number.
- Breakpoint address.

Chapter 4: Loading and Executing Programs Using Breakpoints

- Name of the module or function containing the breakpoint (in high-level mode).
- Module line number (in high-level mode).
- Breakpoint type.
- Command arguments entered with the breakpoint command.

The following paragraphs describe each field in the breakpoint window.

Breakpoint number

The debugger assigns a breakpoint number (#) when you execute a breakpoint command. The debugger uses this number as a label to reference or clear each breakpoint.

Breakpoint address

The breakpoint address (ADDRESS) shows the memory location of the breakpoint. The debugger displays the address as a hexadecimal value.

Module/function

The module/function field (MOD/FNCT) displays either the name of the module containing the breakpoint or the name of a function if you qualified the breakpoint with a function name. If you specify a module name with a breakpoint command, the name must be followed by a line number (for example: *main\#80*). The field width is eight characters. The debugger truncates field entries greater than eight characters in length to eight characters.

Line number

The line number entry (LINE) displays a module line number if you set a breakpoint in a high-level module. If the compiler did not generate executable code for the C statement at the line number specified, the debugger examines the source code and sets a breakpoint on the next line number for which the compiler generated executable code.

In the code window, the debugger places asterisks beside all line numbers that are associated with breakpoints. The debugger places period symbols (.) beside line numbers that are specified as breakpoints, but have no code associated with them.

Breakpoint type

The breakpoint type (TYPE) describes what type of breakpoint is set: instruction, read, write, or access. In assembly-level mode, the debugger sets instruction breakpoints on microprocessor instruction addresses. In high-level mode, the debugger sets instruction breakpoints on source line numbers. The debugger flags instruction breakpoints with */A* (assembly-level) or */H* (high-level). When switching between modes, these flags are useful for differentiating between the different types of breakpoints.

Command argument

The debugger records arguments (COMMAND ARGUMENT) in the breakpoint window as you entered them on the command line. Line numbers, addresses, symbol names, and macro names all appear in this field. For more information about breakpoints, see the specific breakpoint command descriptions in the “Debugger Commands” chapter.

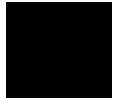

To halt program execution on return to a stack level

- Select **Run Until Stack Level** from the Backtrace window pop-up menu.

Or:

- 1 Set a stack level breakpoint.
- 2 Run the program.
- 3 If desired, delete the breakpoint that was just encountered.

Example

Assume that you want to run the program until it returns to the *main()* function. You can determine where to set a breakpoint on return to main by using the stack level information in the backtrace window (you may have to activate this window in order to see the information in it).

There is a number next to the function *main()* in the backtrace window. This is the current stack level of *main()*. This is the address of the machine level instruction immediately following the call to *initialize_system*.

Place the mouse pointer over the line in the backtrace window that lists "main." Hold the right button and select **Run Until Stack Level**.

Or, using the command line and assuming *main()* is at stack level 1, enter:

```
Breakpoint Instr @1
```

This command will cause program execution to stop when the program returns to the function *main*. The at sign (@) is a debugger operator that causes the debugger to interpret the number 1 as a stack level.

Executing the Breakpt Instr command causes the debugger to update and display the Breakpoint window. The breakpoint you just entered is shown in the Breakpoint window. Now use the appropriate commands to run the program and delete the breakpoint.

Restarting Programs

This section shows you how to:

- Reset the processor.
- Reset the program counter to the starting address.
- Reset program variables.

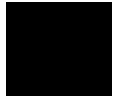

To reset the processor

- Select **Execution**→**Reset to Monitor**.

Or:

- Using the command line, enter:

```
Debugger Execution Reset_Processor
```

And press the < **Return**> key.

Resetting the processor resets the microprocessor to its initial state and leaves the microprocessor running in the monitor.

To reset the program counter to the starting address

- Select **Execution**→**Set PC to Transfer**.

Or:

- Using the command line, enter:

```
Program Pc_Reset
```

And press the < **Return** > key.

The program counter is reset to the transfer address of your absolute file. The next Program Run or Program Step command entered without a *from* address will restart program execution at the beginning of the program.

To reset program variables

- Reload your program.

Memory is not reinitialized when you reset the processor or reset the program counter. Therefore, program variables are not reset to their original values. To reset program variables after resetting the processor or program counter, reload your program.

For faster loading, you can load only the program code. The debugger retains symbol information. You do not have to reload symbol information if symbol addresses have not changed.

For information on loading programs, refer to the previous “Loading Programs and Symbols” section.

Loading a Saved CPU State

State files are used to save the current CPU state (memory image and register values) of a debug session. Though state files can only be created from within a debugger/simulator session, you can use them to restore a CPU state in either a debugger/simulator or debugger/emulator session.

This section shows you how to:

- Load a saved CPU state.

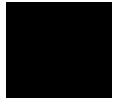

To load a saved CPU state

- 1 Ensure that the emulator is configured correctly for the code you are restoring and that debugger parameters that affect the emulator (such as breakpoints) are set to appropriate values.
- 2 Load symbolic information from same absolute file that was in the simulator when the CPU state was saved. (The debugger/simulator does not save symbolic information.)
- 3 Load the state file. Using the command line, enter:

```
Debugger Execution Load_State
```

Enter the name of the file from which the CPU state should be loaded, and press the < **Return** > key.

The memory contents and register values saved with the debugger/simulator Debugger Execution Save_State command are restored from the specified state file. If you do not specify a file name, the debugger uses the default file *db68k.sav*.

The Debugger Execution Load_State command does not restore breakpoints, macros, or pseudoregister values. After redefining any breakpoints, macros, and pseudoregisters, you are ready to continue your debugging session.

Chapter 4: Loading and Executing Programs

Loading a Saved CPU State

If your program uses simulated I/O, it may not function properly on entering the debugger/emulator because the simulated I/O initialization may not have occurred.

Examples

To restore memory contents and register values saved in state file "session1.sav":

```
Debugger Execution Load_State session1
```

Accessing the UNIX Operating System

This section shows you how to:

- Fork a UNIX shell.
- Execute a UNIX command.

To fork a UNIX shell

- Select **File**→**Term**.

A terminal emulation window will be created.

Or:

- Using the command line, enter:

```
Debugger Host_Shell
```

And press the < **Return** > key.

The *Debugger Host_Shell* command lets you temporarily leave the debugging environment by forking a UNIX shell. The shell created is whatever the shell variable *SHELL* is expanded to. In this mode, you may enter operating system commands.

The *Debugger Host_Shell* command does not end the debugger session; it suspends program operation. To return to the debugger, enter < **Ctrl** > **-D** or type **exit** at the UNIX prompt, and press the < **Return** > key.

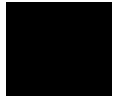

To execute a UNIX command

- Using the command line, enter:

```
Debugger Host_Shell
```

Type in the UNIX command, and press the < **Return** > key.

When using the graphical interface, a terminal emulation window will be opened and the UNIX command will be executed in that window (as specified by the “shellCommand” X resource).

When using the standard interface, *stdout* from the command is written to the journal window. *stderr* is not captured. Commands writing to *stderr* will corrupt the display. Interactive UNIX commands **cannot** be used in this mode.

Examples

To display the current working directory, enter:

```
Debugger Host_Shell pwd
```

Using the Debugger and the Emulator Interface

The debugger and the emulator interface can use the emulator hardware at the same time.

You should be aware of a few inconsistencies between the emulator and the debugger interfaces:

- Modifying registers in one interface will not affect the register display in the other interface. For example, modifying register D0 in the emulator does not change the contents of D0 in the debugger interface. The PC register is an exception to this rule.
- Loading an executable file in the debugger interface will set the program counter to the transfer address by default. Loading an executable in the emulator interface does not set the program counter.

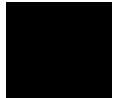

To start the emulation interface from the debugger

Proceed with your debugging session until you get to the point where you need to use an emulator analysis feature.

- If you are using the graphical interface, choose **File**→~~Emul700~~→**Emulator/Analyzer**.
- If you are using the standard interface, enter

```
Debugger Host_Shell
```

Then, at the operating system prompt, type:

```
emul700 <emulator_name>
```

When you are done using the emulator, enter **end** then **exit** to return to the debugger's standard interface.

Using simulator and emulator debugger products together

You can continue a debugging session started in the debugger/simulator in the debugger/emulator by following the steps listed below:

- 1 In the debugger/simulator, use the **Debugger Execution Save_State** command to save the current memory contents and register values.
- 2 Quit the simulator session using the **Debugger Quit** command.
- 3 Start the debugger/emulator.
- 4 Load the state file created with the **Debugger Execution Save_State** command using the **Debugger Execution Load_State** command. This will restore memory and processor registers to the state you saved in the debugger/simulator.

Using the Debugger with the Branch Validator

The Hewlett-Packard Branch Validator (BBA) is an interactive tool that helps you rapidly determine which branches of a program have not been taken. With the missed branches identified, you can modify your regression tests to ensure software reliability.

The branch analysis information is collected by C programs that have been compiled using the **bbacpp** preprocessor.

To unload Branch Validator data from program memory

- Select **File**→**Store**→**BBA Data ...**. Then choose a file name from the File Selection dialog box.

Or:

- Using the command line, enter:

```
Memory Unload_BBA All
```

And press the < **Return** > key.

This command unloads branch analysis information associated with all absolute files loaded.

The default file name is *bbadump.data*.

The BBA preprocessor (-b option) must be used at compile time in order for this information to exist in program memory.

Once this information has been unloaded, it can be formatted with the BBA report generator, *bbarep* (see the *HP Branch Validator for AxLS C User's Guide*).

Chapter 4: Loading and Executing Programs

Using the Debugger with the Branch Validator

Note

The `Unload_BBA` command is disabled when the debugger option `Demand_Load` is *On*. If `Demand_Load` is *off* but the program was loaded with `Demand_Load On`, the `Memory Unload_BBA` command will generate a BBA file with incomplete information. See the `Debugger Option General` command description in this manual for more information on the `Demand_Load` option.

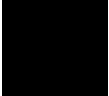

5

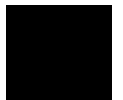

Viewing Code and Data

How to find and display source code and memory contents.

Using Symbols

This section shows you how to:

- Add a symbol to the symbol table.
- Display symbols.
- Delete a symbol from the symbol table.

To add a symbol to the symbol table

- Using the command line, enter:

```
Symbol Add
```

Enter the symbol data type, the symbol name, and optionally the base address and the initial value; then, press the < **Return** > key.

Two types of symbols can be added:

- Program symbols, which are identical to variables defined in a C or assembly program. These symbols must be given base addresses.
- Debugger symbols, which may be used to aid and control the flow of the debugger. These symbols are specified without a base address, and only debugger commands and C expressions in macros can refer to them. They cannot be referenced by the program in target memory.

Example

To add a program symbol named EOF of type int (default) at target memory address 9ff0h and set the memory location to value -1:

```
Symbol Add EOF Address 9ff0h Fill_Mem -1
```

To display symbols

- Select **Display**→**Symbols**→to display information about the symbol in the entry buffer.

Or:

- Using the command line, enter:

```
Symbol Display Default
```

Enter the symbol, module, or function name; then, press the < **Return** > key.

Symbols and associated information are displayed in the journal window.

When displaying a symbol in the current module, the debugger looks for the symbol in the current module. If there is no module qualifier, all symbols with the specified name will be displayed, including global symbols and symbols local to the module.

The wildcard character * may be placed at the end of a symbol name to represent zero or more characters. If used with no symbol name, * is treated the same as \, that is, all symbols are displayed.

Examples

To display the symbol 'updateSys' in the current module:

```
Symbol Display Default updateSys
```

```
Symbol Display Default updateSys
@ecs\\updateSys    : Type is High level module.
                   Code section = 00001436 thru 00001C21
```

To display all symbols in module 'updateSys':

```
Symbol Display Default updateSys\
```

```
> Symbol Display Default updateSys\
Root is: updateSys

@ecs\\updateSys    : Type is High level module.
                   Code section = 00001436 thru 00001C21
updateSys\update_state_of_system
                   : Type is Global Function returning void.
```

Chapter 5: Viewing Code and Data

To display symbols in all modules

```
update_state_of\refresh      Address = 00001436 thru 00001513
                             : Type is Local int.
                             Address = Frame + 8
update_state_of\interval_complete
                             : Type is Local int.
                             Address = Frame + 12
:
```

To display symbols in all modules

- With "\ " in the entry buffer, select **Display**→**All Symbols** ().

Or:

- Using the command line, enter:

```
Symbol Display Default \
```

To delete a symbol from the symbol table

- Using the command line, enter:

```
Symbol Remove <symb_name>
```

Enter the symbol, module, or function name; then, press the < **Return** > key.

The specified symbols are removed from the symbol table. Only program symbols and user-defined debugger symbols can be deleted from the symbol table.

Examples

To delete symbol 'current_targets' in function 'alter_settings':

```
Symbol Remove alter_settings\current_targets
```



Chapter 5: Viewing Code and Data
To delete a symbol from the symbol table

To delete all symbols in module 'updateSys':

```
Symbol Remove updateSys\
```

To delete all symbols in all modules:

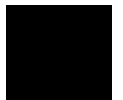
```
Symbol Remove \
```



Displaying Screens

A debugger screen is what you see in the display area. Each debugger screen may contain one or more debugger windows. A debugger window is a predefined physical area on the screen containing specific debugger information.

The debugger has three predefined screens. Each predefined screen has a corresponding name and number. The predefined screens and their associated names and numbers are listed below:

Screen Name	Screen Number
High-level screen	1
Assembly-level screen	2
Standard I/O screen	3

This section shows you how to:

- Display the high-level screen.
- Display the assembly level screen.
- Switch between the high-level and assembly screens.
- Display the standard I/O screen.
- Display the next screen (activate a screen).

High-Level Screen

The debugger automatically displays the high-level screen when an executable (.x) file containing the C function main() is loaded from the UNIX command line with the db68k command. This screen has nine windows:

- journal
- code
- monitor
- backtrace
- status
- breakpoint
- error
- help

- view

The high-level screen displays high-level source code and stack backtrace information including the calling sequence of functions and function nesting levels.

Assembly-Level Screen

The debugger automatically displays the assembly-level screen when an executable (.x) file is loaded from within the debugger or the executable file does not contain the C source function main(). This screen has ten windows:

- journal
- code
- monitor
- register
- stack
- status
- breakpoint
- error
- help
- view

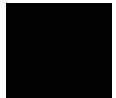

The assembly-level window displays assembly-level code and processor register and stack information.

Standard I/O Screen

The debugger displays the standard I/O screen when your program requests interactive input from the standard input device (stdin), or directs output to the standard output device (stdout). It may also be displayed using the *F6* function key. This screen has five windows:

- status
- breakpoint
- error
- help
- view

You can also access the standard I/O screen as a window (window No. 20).

The standard I/O window emulates a dumb terminal. It can be moved about the display, but it can be no larger than 24 rows by 80 columns.

To display the high-level screen

- Select **Settings**→**High Level Debug**.

Or:

- Using the command line, enter:

```
Window Screen_On High_Level
```

To display the assembly level screen

- Select **Settings**→**Assembly Level Debug**.

Or:

- Using the command line, enter:

```
Window Screen_On Assembly_Level
```

To switch between the high-level and assembly screens

- Press the **F3** function key.

Or:

- Using the command line, enter:

```
Debugger Level
```

You can also use the Window New and the Window Active commands to display a different screen.

To display the standard I/O screen

- Press the **F6** function key.

Or:

- Select **Window→Simio**.

Or:

- Using the command line, enter:

```
Window Screen_On Stdio
```

The standard I/O screen is displayed when your program requests interactive input from the standard input device (keyboard) or when your program writes information to the standard output device.

To display the next screen (activate a screen)

- Press the **F6** function key.

Or:

Chapter 5: Viewing Code and Data
To display the next screen (activate a screen)

- Using the command line, enter:

```
Window Screen_On Next
```

The next higher-numbered screen will be displayed. Either the high-level or the assembly-level screen will be displayed, not both.

The debugger screens are numbered as follows:

Screen Name	Screen Number
High-level screen	1
Assembly-level screen	2
Standard I/O screen	3
User-defined screens	4-256

Displaying Windows

This section shows you how to:

- Change the active window.
- Select the alternate view of a window.
- Set the cursor position for a window.

A debugger window is a predefined physical area on the screen. The debugger has 18 predefined windows. Each window displays information specific to its associated name (for example, the breakpoint window displays breakpoint information).

Each of the 18 predefined windows has a corresponding name and number. All windows (except the log file and journal file windows, which are files) also have an associated screen number. The following table lists the predefined windows and their associated names and numbers.

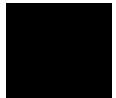

Chapter 5: Viewing Code and Data
To display the next screen (activate a screen)

Window Name	Window Number	Screen Number
journal (high-level)	1	1
code (high-level)	2	1
monitor (high-level)	3	1
backtrace	4	1
status (high-level)	5	1
journal (assembly-level)	10	2
code (assembly-level)	11	2
monitor (assembly-level)	12	2
register (assembly-level)	13	2
stack	14	2
status (assembly-level)	15	2
standard I/O	20	3
view	24	1, 2, 3
breakpoint	25	1, 2, 3
error	26	1, 2, 3
help	27	1, 2, 3
log file	28	none
journal file	29	none

The code window displays C source code in high-level mode. The code window displays disassembled machine code in assembly-level mode. The C source code that generated the assembly code can be interleaved with the assembly-level code.

When disassembled code is displayed, the address and machine code of a disassembled instruction are displayed on the left side of the window as hexadecimal values. For instructions over 6 bytes in length, bytes 7 through n are replaced by ellipsis (...).

The stack window displays the stack beginning at the memory location pointed to by the debugger stack pointer @SP. This window is available only within the assembly-level screen.

To change the active window

- Use the *command select* mouse button to click on the border of the window you wish to activate.

Or:

- Select the window you want to make active from the **Window**→menu.

Or:

- Use the command line to select a window:

```
Window Active <window>
```

where <window> is the name of the window to be made active, and press the <Return> key.

The debugger uses a highlighted or thick border for the active window. The cursor keys, scroll bar, and function key *F4* (select the alternate display) only operate in the active window.

If you are using a terminal without graphics capabilities, the active window is indicated by single dashes around the border (other windows all have borders of equals signs).

The window number is displayed in the upper right border of the window.

Examples

To make the high-level backtrace window active:

```
Window→Backtrace
```

Or:

```
Window Active High_Level Backtrace
```

To make the breakpoint window active:

```
Window Active Breakpoint
```

To select the alternate view of a window

To make user window 57 active:

```
Window Active User_Window 57
```

To select the alternate view of a window

- Click on the border of the active window with the *command select* mouse button.

Or:

- Press the **F4** function key.

Or:

- Using the command line, enter:

```
Window Toggle_View
```

Or:

- Using the command line, enter:

```
Window Toggle_View <Window>
```

where < *Window* > is the name of the window whose alternate view is to be displayed, and press the < **Return** > key.

The typical default alternate view of a window is an enlarged view of the window, letting you view more information. Repeating the command switches between the normal view and the alternate view of the active window.

Example

To display the alternate view of the assembly level code window:

```
Window Toggle_View Assembly Code
```

To view information in the active window

- Use the scroll bar.

Or:

- Use the cursor control keys.

Press the < **Up**> or < **Down**> cursor key to move up or down in the window one line at a time.

Press the < **Page Down**> (< **Next**>) or < **Page Up**> (< **Prev**>) key to move the window one-half of the window length at a time.

Press the < **Home**> or < **End**> (< **Shift**> < **Home**>) key to position the window at the beginning or end of the information displayed in the window.

Type < **Ctrl**> -**F** or < **Ctrl**> -**G** to shift the contents of the active window to the right or left.

The following table describes the functions of the cursor control keys in the active window and the command line window.

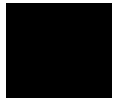

Chapter 5: Viewing Code and Data
To view information in the "More" lists mode

Key	Description
→	Move to right in data field of command. Highlight token to the right in status line window.
←	Move to left in data field of command. Highlight token to the left in status line window.
↑	Move up one line in window.
↓	Move down one line in window.
Prev	Move up one half window.
Next	Move down one half window.
Home	Move to the top of the active window (except stack window).
End (Shift Home)	Move to bottom of window (except for stack window).
Insert char	Put keyboard in insert mode for editing data field of command.
Delete char	Delete character within data field of command.

The Home and End (Shift-Home) keys have additional functions when used with the code and stack windows. The following table describes how the Home and End (Shift-Home) keys work in these active windows.

Active Window	Home Key	End Key
Code	Move to top of module	Move to bottom of module
Stack	Move to current stack pointer (SP)	Move to current frame pointer (FP)

To view information in the "More" lists mode

If the "--More--" prompt is printed at the bottom of a window, the debugger is waiting to display more than one screen of information.

- Press the space bar to display the next screen of information.
- Press the < **Return**> key to display the next line.
- Press "Q" to end the "More" display.

If you try to enter a command while the debugger is displaying the "--More--" prompt, the command will not be executed until the "More" display has ended.

You can turn the "More" list mode off or on with the **Settings**→**Debugger Options** dialog box.

For more information, see your operating system documentation on the **more** command.

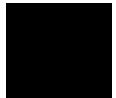

To copy window contents to a file

- Select **File**→**Copy Window**→

Or:

- From the command line, enter the following commands:

```
File User_Fopen Append 99 File <file_name>  
Expression Fprintf 99, "%w", <window_number>  
File Window_Close 99
```

Displaying C Source Code

This section shows you how to:

- Display the C source code.
- Find first occurrence of a string.
- Find next occurrence of a string.

To display C source code

- 1 Display the high-level screen (see the instructions in the previous “Displaying Screens” section).
- 2 Display source code at the location in the entry buffer by selecting **Display→Source ()**. Or click on the **Disp Src ()** action key.

Or, using the command line, enter:

```
Program Display_Source
```

Enter the line number or function name of the code you wish to display, and press the < **Return** > key.

Examples

To display the C source code at line number 1 (in the current module):

```
Program Display_Source #1
```

To display the C source code at function *main*:

```
Program Display_Source main
```

To display C++ source code at overloaded C++ function *cfunc*, you can either give the name of the function and select the definition from a menu, or you can specify the definition by entering the argument type:

```
Program Display_Source cfunc (float)
```

To find first occurrence of a string

- 1 Display the high-level screen (see the instructions in the previous “Displaying Screens” section).
- 2 Enter the string in the entry buffer.
- 3 Select **Display→Source Find Fwd ()** or **Display→Source Find Back ()**.

Or, using the command line, enter:

```
Program Find_Source Occurrence <Direction>
```

Select either Forward or Backward as the direction, enter the line number or string you wish to find, and press the < **Return** > key.

Example

To find the first occurrence of the string “main”:

```
Program Find_Source Occurrence Forward main
```

To find next occurrence of a string

- Select **Display→Source Find Again**.

Or:

- Using the command line, enter:

```
Program Find_Source Next <Direction>
```

Chapter 5: Viewing Code and Data
To find next occurrence of a string

Select either Forward or Backward as the direction, and press the < **Return**> key.

Example

To find the next occurrence of a string:

Program **F**ind_**S**ource **N**ext **F**orward

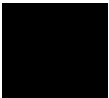

Displaying Disassembled Assembly Code

Coprocessor Support

External devices must be supported by your target system. No support is provided by the debugger/emulator.

To display assembly code

- Select **Settings**→**Assembly Level Debug**.

Or:

- Using the command line, enter:

```
Window Screen_On Assembly_Level
```

The Code window will show disassembled instructions.

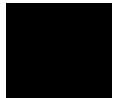

Displaying Program Context

This section shows you how to:

- Set current module and function scope.
- Display current module and function.
- Display debugger status.
- Display register contents.
- List all debugger registers.
- Display the function calling chain (stack backtrace).
- Display all local variables of a function at the specified stack (backtrace) level.

To set current module and function scope

- Select **File**→**Context**→**Symbols ...**, enter the module or function name in the dialog box, and click on the OK pushbutton.

Or:

- Using the command line, enter:

```
Program Context Set
```

Enter the module or function name, and press the < **Return**> key.

The module and function scope is used by the debugger to uniquely identify symbols. For example, several functions may have local variables with the same names. When you use that variable name without naming the function, the debugger assumes you mean the variable in the current module or function scope.

Examples

To select module “updateSys” as the current module:

```
Program Context Set updateSys
```

To select function “updateSys\paint_display” as the current function:

```
Program Context Set updateSys\paint_display
```

To set the program context to the module at which the program counter is pointing:

```
Program Context Set
```

To display current module and function

- Select **Display→Context**. Click on the Done pushbutton when you wish to stop displaying the information.

Or:

- Using the command line, enter:

```
Program Context Display
```

The current module, function, and line number are displayed in the journal window.

To display debugger status

- Select **Window→Status**.

Or:

Chapter 5: Viewing Code and Data
To display register contents

- Using the command line, enter:

```
Debugger Execution Display_Status
```

The following information is displayed in the view window (which temporarily overlays the top portion of the screen):

- Product version.
- Current working directory.
- Current log file in use.
- Current journal file in use.
- Startup file used.

The view window is also used to display trace data and information about trace command or event status. When trace data is displayed, a trace status character may be displayed in front of the trace line. The following table defines the trace status characters.

Trace List Status Characters

Character	Description
*	The indicated trace line is the trigger condition.
+	The indicated trace line is in the middle of a C statement, that is, not the first assembly language statement in the C source statement.
!	The data in the trace buffer line does not match the data in memory.
?	The trace line may be a prefetch.

To display register contents

- Select **Window→Registers**.

Or:

- Select **Modify**→**Registers**.

Or:

- Using the command line, enter:

```
Window Active Assembly Registers
```

The register window shows the current values of the microprocessor's registers and several debugger variables. The microprocessor register values are labeled with their standard names. The debugger displays all values in hexadecimal format unless otherwise noted.

If you are running just the debugger the Registers window is available only within the assembly-level screen. If the emulator/analyzer graphical interface is active, **Window**→**Registers** will display registers in the emulator window.

The information displayed in the register window varies with different microprocessors. See the "Registers" chapter and page 148 for information about the registers and pseudoregisters which you can display using expression commands.

To list all registers

- Using the command line, enter:

```
Symbol Display Reserved_Symbols
```

A list of all the registers and pseudoregisters supported by the debugger will be displayed in the Journal window.

This command is useful if you want to know what registers are supported by the debugger, or if you need to find the sizes of various registers.

See Also

Many of the registers are described in the "Registers" chapter.

To display the function calling chain (stack backtrace)

- Select **Window**→**Backtrace**.

Or:

- Using the command line, enter:

```
Window Active High_Level Backtrace
```

The backtrace window displays the function calling chain, from the compiler startup routine to the current function in high-level mode.

This window displays (from left to right):

- Function nesting level.
- Return address to the calling function.
- Frame status character.
- Module containing the function.
- Function name.

Function Nesting Level. The nesting level of the current function is always 0, the calling function always 1, etc.

You may reference the nesting level when setting a breakpoint. For example, to cause the program to execute until it returns to the second nested function, enter the command:

```
Program Run Until @2
```

Another way to execute until a stack level is reached is to choose **Run Until Stack Level** in the Backtrace window pop-up menu.

Return Address. The return address field displays the return address of the calling function.

Frame Status Character. One of several characters immediately precedes a function name in the backtrace window. These frame status characters and their descriptions are listed in the table below.

Chapter 5: Viewing Code and Data
To display the function calling chain (stack backtrace)

Character	Description
Space	The debugger is executing within a function.
:	The program counter is at a label. Typically, this is an assembly language function point.
*	The function has been entered, but the function prolog has not been executed. The debugger cannot locate local symbols in the function until the prolog has been executed.
?	The frame is questionable. For example, this is displayed when a function has been stripped of debug information.
!	The frame is not valid.
	The debugger is at the start of an interrupt routine.
+	The debugger is executing an interrupt routine.

Module Name. If the function is in a known module, the backtrace window displays the module name. If the program counter is pointing to an address that is not contained in a module known to the debugger, the module field in the backtrace window displays a string of question marks (??????).

Function Name. If the return address of a function is inside a known function, the debugger displays the function name. If the address is outside of all known functions, the function field in the backtrace window will display *<unknown>*. This is the case with the compiler startup module *crt0*, because it is assembly code and contains no debug information.

Backtrace Information. Whenever a break occurs in program execution, the backtrace window is updated. When updating the window, the debugger generates backtrace information as described in the following paragraphs. The backtrace window is displayed only in the high-level screen.

Nesting level 0. Nesting level 0 information is based solely on the current value of the processor's program counter (PC). The address shown at this level is the value of the PC. The module and function shown at this level are selected because the value of the PC falls within their code spaces.

Chapter 5: Viewing Code and Data
To display the function calling chain (stack backtrace)

Nesting level 1. When program execution breaks on an address that has an associated public label (for example, a function entry point), nesting level 1 information is based on the processor SP. The debugger assumes that the SP is pointing to the return address because the label is assumed to be a function entry point and no stack frame has yet been established. With no stack frame available, the return address of the calling function is at the top of the stack. This return address is the address at level 1. The module and function shown are based on this address, that is, the address falls within their code spaces.

When program execution breaks on an address that has no associated public label, nesting level 1 is based on the processor's frame pointer (register A6). In this case, the stack location four bytes above the location pointed to by register A6 contains the return address of the calling function. This address is the address shown at level 1; the module and function shown are based on this address.

Nesting levels 2 through n. Nesting levels 2 through n are always based on existing stack frames. A stack frame is generated for each frame on the stack, based on saved frame pointers. Nesting levels are generated until backtracing of the stack encounters a zero frame pointer. This occurs when the stack frame associated with the compiler startup routines crt0/crt1 is encountered.

Functions with no stack frame. If a function has no stack frame (due to compiling with the -O option), the function that called it does not appear in the backtrace window at any stack level other than levels 0 or 1.

Assembly language functions. Assembly language functions that set up stack frames appear in the backtrace window, but the information shown is incomplete. Since high level debug information is not present in such handwritten functions, the stack frame appears as a questionable

To display all local variables of a function at the specified stack (backtrace) level

frame. Additionally, there is no function name associated with the frame, i.e., it is displayed as *<unknown>*.

To display all local variables of a function at the specified stack (backtrace) level

- Select **Disp Vars at Stack Level** from the Backtrace window pop-up menu.

Or:

- Using the command line, enter:

```
Program Context Expand <@stack_level>
```

Enter the stack level preceded by an *at* sign (@), and press the **< Return >** key.

The values of the parameters passed to the function and the function's local variables are displayed in the Journal window.

Example

To display local variables at stack level 1, position the cursor over "1." in the Backtrace window, and hold the right mouse button. Move the mouse to **Disp Vars at Stack Level** and release the button.

Or, use the command line to enter:

```
Program Context Expand @1
```

To display the address of the C++ object invoking a member function

- Display the value of the function's **this** pointer.

If the program has stopped at a function, you can find out the address of the object which invoked the function.

The program counter must be *inside* the function; otherwise you may see a "Local variable not alive" error message.



Example

To see the address of the object that invoked the *cfunc* function in class *C*, enter the following string in the entry buffer:

```
C::cfunc\this
```

then select **Display→Var/Expression ()**.

Using Expressions

This section shows you how to:

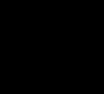
- Calculate the value of a C expression.
 - Display the value of an expression or variable.
 - Monitor variables.
 - Discontinue monitoring specified variables.
 - Discontinue monitoring all variables.
 - Print formatted output to a window.
 - Print formatted output to journal windows.
- 

To calculate the value of a C expression

- Enter the expression in the entry buffer, then select **Display→C Expression ()**.

Or:

- Using the command line, enter:

```
Expression C_Expression
```

Enter the C expression to be calculated, and press the < **Return** > key.

The value of the C expression is displayed in the journal window.

If the C expression is an assignment statement, the Expression C_Expression command sets the value of the C variable.

Examples

To calculate the value of 'time':

To display the value of an expression or variable

```
Expression C_Expression time
Result is: data address 000091DC {time_struct}
```

To calculate the value of member 'hours' of structure 'time':

```
Expression C_Expression time->hours
Result is: 4 0x04
```

To assign the value 1 to 'system_is_running':

```
Expression C_Expression system_is_running = 1
Result is: 1 0x01
```

To display the value of an expression or variable

- Use the mouse to copy the expression or variable into the entry buffer, then select **Display→Var/Expression ()**.

Or:

- Using the command line, enter:

```
Expression Display_Value
```

Enter the expression or variable whose value is to be displayed, and press the **< Return >** key.

The value of the expression or variable is displayed in the journal window.

The contents of an item, such as an array, are displayed instead of the C value of the item which is its address.

Examples

To display the value of the variable 'system_is_running':

```
Expression Display_Value system_is_running
01h
```

To display the address of the variable 'system_is_running':

```
Expression Display_Value &system_is_running  
000091F0
```

To display the address of the C structure 'time':

```
Expression Display_Value time  
000091DC
```

To display the values of the members of structure 'time':

```
Expression Display_Value *time  
hours      4  
minutes    0  
seconds    20
```

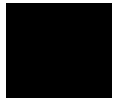

To display the name of the current program module:

```
Expression Display_Value @module
```

To display the name of the current program function:

```
Expression Display_Value @function
```

To display members of a structure

- 1 Copy the name of the structure into the entry buffer.
- 2 Add an asterisk (*) in front of the name of the structure.
- 3 Select **Display→Var/Expression ()**.

If you are using the command line, use the **Expression Display_Value** command.

Chapter 5: Viewing Code and Data
To display the members of a C++ class

Example

To display the names of the members of structure *astruct*, use the following expression in the entry buffer:

```
*astruct
```

The * operator tells the debugger to display the members of the structure, rather than the address of the structure.

To display the members of a C++ class

- Using the command line, enter

```
Symbol Display Options Search_all End_Options  
<class_name>\
```

This will display the type, size, protection, and overloading of each member of *class_name*.

Example

To display the members of class *C*, enter:

```
Symbol Display Options Search_all End_Options C\
```

To display the values of all members of a C++ object

- Enter the name of the C++ object in the entry buffer and select **Display→Var/Expression ()**.

Or:

- Using the command line, enter:

```
Expression Display_Value <object>
```

Remember, you are displaying the values in an *object*, so you need to run the program to the point where the object is created. To display the members of a class, see "To display the members of a C++ class."

Example

To display the members of object *cobj* in class *C*, enter "cobj" in the entry buffer and select **Display→Var/Expression ()**.

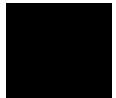

To monitor variables

- Enter the variable to be monitored in the entry buffer and click on the **Monitor ()** action key.

Or:

- Enter the variable to be monitored in the entry buffer and select **Display→Monitor ()**.

Or:

- Using the command line, enter:

```
Expression Monitor Value
```

Enter the variable to be monitored, and press the **< Return >** key.

The monitor window displays monitored variable expressions. This window can be displayed in both the high-level and assembly-level screens.

Chapter 5: Viewing Code and Data

To monitor the value of a register

Variables in the monitor window are updated each time the debugger stops executing the program. (The program is not considered to be "stopped" when a breakpoint with an attached macro is encountered.)

Example

To monitor the value of variable 'current_temp':

```
Expression Monitor Value current_temp
```

To monitor the value of a register

- Monitor a register just as you would a variable.

Example

To monitor the value of register D2, enter "@D2" in the entry buffer and select **Display**→**Monitor** ().

Or, using the command line, enter

```
Expression Monitor Value @D2.
```

To discontinue monitoring specified variables

- Select **Delete Variable** in the Monitor window pop-up menu.

Or:

- Using the command line, enter:

```
Expression Monitor Delete
```

Enter the number of the variable (shown in the monitor window) that should no longer be monitored, and press the < **Return**> key.

The variable is removed from the monitor window.

Example

To stop monitoring variable 2 in the monitor window:

```
Expression Monitor Delete 2
```

To discontinue monitoring all variables

- Select **Delete All Variables** in the Monitor window pop-up menu.

Or:

- Using the command line, enter:

```
Expression Monitor Clear_All
```

All variables are removed from the monitor window.

To display C++ inheritance relationships

- Enter the name of a C++ class in the entry buffer, then select **Display→Symbols→Browse C++ Class ()**.

Or:

- Using the command line, enter:

```
Symbol Browse
```

Enter the name of the C++ class to be displayed, and press the < **Return** > key.

To print formatted output to a window

- Using the command line, enter:

```
Expression Fprintf
```

Enter the number of the user-defined window, the format string (enclosed in quotes), and the arguments; then, press the < **Return** > key.

The formatted output is written to the user-defined window. This command is similar to the C `fprintf` function.

The debugger associates the log file window (window no. 28) with a log (.com) file so that you can write output to that window using the Expression `Fprintf` command. This window is not displayed. It is used only for writing to a command file.

The debugger associates the journal file window (window no. 29) with a journal file so that it can write journal window output to the journal (.jou) file. Additional output may be written to the journal file by writing to window 29.

Examples

To print the value of `var` to user window 57 as a single character:

```
Expression Fprintf 57, "%c", var
```

To print the string in double quotes to user window 57 followed by the floating point value of 'temperature' with a precision of 2:

```
Expression Fprintf 57, "The value of 'temperature' is:  
%.2f \n", temperature
```

To print formatted output to journal windows

- Using the command line, enter:

```
Expression Printf
```

Chapter 5: Viewing Code and Data
To print formatted output to journal windows

Enter the format string (enclosed in quotes) and the arguments; then, press the < **Return** > key.

The formatted output is written to the journal window. This command is similar to the C printf function.

Examples

To print the value of *var* to the journal window as a single character:

```
Expression Printf "%c",var
```

To print the string in double quotes to the journal window followed by the floating point value of 'temperature' with a precision of 2:

```
Expression Printf "The value of 'temperature' is: %.2f\n",temperature
```



Viewing Memory Contents

This sections explains how to to view, compare, and search blocks of memory.

To compare two blocks of memory

- Using the command line, enter:

```
Memory Block_Operation Match <Mismatch_Operation>
```

Select either Repeat_On_Mismatch or Stop_On_Mismatch to specify what happens when a mismatch is found, enter the address range to be compared and the starting address of the range that it is compared to; then, press the <Return> key.

Example

To compare the block of memory starting at address 1000h and ending at address 10ffh with a block of the same size beginning at address 5000h and stop when a difference is found:

```
Memory Block_Operation Match Stop_On_Mismatch  
1000h..10ffh,5000h
```

To search a memory block for a value

- Using the command line, enter:

```
Memory Block_Operation Search <Size> <Until>
```

Select either Byte, Word, or Long as the size of the memory locations, select either Once or Repeatedly to specify when the search should stop, enter the

Chapter 5: Viewing Code and Data
To examine a memory area for invalid values

address range and the value that is to be searched for, and press the **< Return >** key.

Example

To search for the expression 'gh' in the memory range from address 1000h through address 10ffh and stop when the expression is found or address 10ffh is reached:

```
Memory Block_Operation Search Word Once  
1000h..+0xff = 'gh'
```

To examine a memory area for invalid values

- Using the command line, enter:

```
Memory Block_Operation Test <Size> <Until>
```

Select either Byte, Word, or Long as the size of the memory locations, select either Once or Repeatedly to specify when the search should stop, enter the address range and the value that should be found in the range, and press the **< Return >** key.

Example

To test for the expression 'gh' in the memory range from address 1000h through address 10ffh and stop when a word not matching the expression is found:

```
Memory Block_Operation Test Word Once 1000h..+0xff =  
'gh'
```

To display memory contents

- Select **Display**→**Memory**→.

Or:

- Using the command line, enter:

```
Memory Display <Format>
```

Select either Mnemonic, Byte, Word, or Long as the format in which memory contents are to be displayed.

If you are using the command line, enter the starting address or the address range of the memory whose contents are to be displayed, and press the **< Return >** key.

Examples

To display disassembled memory in the code window starting at the symbol `'_emeg_shutdown'` (this command works only in assembly-level mode):

```
Memory Display Mnemonic _emeg_shutdown
```

To display memory in byte format in the journal window starting at the symbol `'current_humid'`:

```
Memory Display Byte current_humid
```

Using Simulated I/O

Simulated I/O (SIMIO) lets programs use the UNIX file system, run UNIX commands, and use the keyboard and display for input and output.

Your programs can use SIMIO by means of the I/O libraries and environment dependent routines provided with the HP B1463 C Cross Compiler. Your programs use the library functions when they open, close, read, or write to files, etc. These simulated I/O functions are identical in both the debugger/emulator and debugger/simulator to let you write programs that will function correctly in both environments. Refer to the "Environment Dependent Routines" chapter of your compiler manual for information on using the C SIMIO libraries.

Your programs can also use SIMIO by means of user-written assembly code. If you are developing programs that use SIMIO from assembly code, refer to the *Simulated I/O User's Guide* for a complete description of SIMIO protocol.

This chapter shows you how to:

- Enable simulated I/O.
- Disable simulated I/O.
- Set the keyboard I/O mode.
- Redirect I/O.
- Check resource usage.
- Increase file resources.
- Display the simulated I/O system report.

How Simulated I/O Works

Communication between your program running in the emulation system and the SIMIO process takes place through contiguous single-byte length memory locations. The first memory location is called the Control Address (CA). The Control Address and the memory locations that follow it are called the CA buffer.

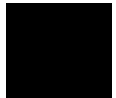

Chapter 5: Viewing Code and Data

To display memory contents

Control Address buffers are less than or equal to 260 bytes in size. A maximum of 256 bytes of information can be transferred between the debugger and the host system at one time. Some simulated I/O commands require four additional bytes for command parameters.

The debugger supports only one Control Address (CA) for doing SIMIO operations. This buffer is named *systemio_buf* in the HP B1463 C I/O libraries. Assembly code users who want to use SIMIO with the debugger must label their Control Address as *_systemio_buf* (the compiler prefixes symbols with an underscore).

Communication between a program and the simulated I/O process is a series of requests by the program and responses by the SIMIO process:

The program places a SIMIO command in the CA buffer and then waits for a return code to be placed in the first byte of the CA.

The SIMIO process polls the CA buffer memory. When it finds a command, the SIMIO process executes the command. When the SIMIO process completes the command, the first byte of the CA buffer is changed to the command return code.

Simulated I/O Connections

The SIMIO system supports three types of I/O connections. These are:

- Keyboard and display.
- UNIX files.
- UNIX processes.

Display and Keyboard

The debugger provides a window named *stdio* which functions as the normal display output for target programs. The screen can be opened for output from target programs via SIMIO with the special name */dev/simio/display*. This name appears to be an UNIX file name. However, it is really a name reserved by the debugger to indicate the internal screen. The keyboard is accessed by the special name */dev/simio/keyboard*.

UNIX Files

UNIX files are accessed by their names from the target program running in the debugger in the same way they are accessed by host software. The file operations of open, close, read, write, and seek are supported by the SIMIO

protocol. When opening a stream on an UNIX file, SIMIO supports the same control parameters for file creation and blocking I/O that are available to host programs.

UNIX Processes

UNIX processes can be run as subprocesses to the debugger with their input and output directed to the user program. Subprocesses are controlled from the user program by a Process Identification number (PID). This lets the user program check specific subprocesses, send them signals, or stop them. This subprocess facility allows user programs to take advantage of the powerful software and execution environment of the host UNIX system. Host programs can be used to process data for a debugger user program or to simulate portions of the software that are not available in the user program.

Because simulated I/O lets the debugger execute UNIX commands, the debugger can communicate with other host system I/O devices, such as printers, plotters, modems, etc.

For more information on using UNIX processes, refer to the description of the *exec_cmd()* function in the "Environment Dependent Routines" chapter of the *68030/040 C Cross Compiler Reference* manual.

Special Simulated I/O Symbols

User Program Symbols

The following symbols are user program symbols that are used by the SIMIO system to process the simulated I/O protocol:

systemio_buf This symbol indicates the start of the Control Address buffer.

Simulated I/O Reserved Symbols

The following names are reserved by the SIMIO system and cannot be used for your file names. The SIMIO system recognizes these names and uses special processing to direct the I/O to the proper location:

stdin This name will be replaced by the name stored in the *stdin_name*. This name is set via the *Stdio_Redirect* command.

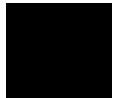

To enable simulated I/O

stdout This name will be replaced by the name stored in the `stdout_name`. This name is set via the `Stdio_Redirect` command.

stderr This name will be replaced by the name stored in the `stderr_name`. This name is set via the `Stdio_Redirect` command.

/dev/simio/keyboard This name refers to the keyboard while the product is running interactively.

/dev/simio/display This name refers to the stdio display window while the product is running interactively.

To enable simulated I/O

- Using the command line, enter:

```
Debugger Execution IO_System Enable
```

When SIMIO is enabled, polling for simio command begins. In the debugger/emulator, the host computer periodically reads the memory in the emulator or target system to detect simio commands issued by the user code. SIMIO behavior in the debugger is identical to that described in the *Simulated I/O User's Guide*.

SIMIO is also enabled if the "Enable polling for simulated I/O?" emulator configuration question was answered yes.

To disable simulated I/O

- Using the command line, enter:

```
Debugger Execution IO_System Disable
```

To set the keyboard I/O mode to cooked

- Using the command line, enter:

```
Debugger Execution IO_System Mode Cooked
```

In the Cooked mode, the keyboard input is processed. This lets you type and then edit the line to correct errors. When the final line is composed, press the **< Return >** key to enter the line. Once the line is entered, it is read by the target program. Only the characters from the final line and the carriage return character are passed as input. If program execution is interrupted by entering **< Ctrl > -C** before the line is entered, the characters on the input line are lost.

See also

"To set the keyboard I/O mode to raw"

To set the keyboard I/O mode to raw

- Using the command line, enter:

```
Debugger Execution IO_System Mode Raw
```

In the Raw mode, each character you type is sent directly to the target program that is reading from the keyboard. Characters are not echoed as they are typed. Any input editing, such as backspace, must be handled by the target program. The only special character that cannot be sent to the target program is **< Ctrl > -C** which is used to interrupt the debugger's execution of the program.

See also

"To set the keyboard I/O mode to cooked"

To control blocking of reads

- Set the `O_NDELAY` flag in the `startup()` routine.

The flag `O_NDELAY` is passed to the function `open()` to control whether or not reads from the keyboard will block *waiting for characters*. This flag can only be set when opening the stream; it may not be changed after the file stream is open. This flag can be set in the compiler-supplied routine `startup()`. This routine opens streams `stdin`, `stdout`, and `stderr`.

See also

The chapter titled "Environment Dependent Routines" in the *68030/040 C Cross Compiler Reference* manual.

To redirect I/O

To redirect the three I/O streams and to reset your program to the startup address, perform the following steps.

- 1 Redirect the three I/O streams by changing the translation names for the stdio streams. Using the command line, enter:

```
Debugger Execution IO_System Stdio_Redirect  
<"stdin_name", "stdout_name", "stderr_name">
```

Enter the new names for standard input, standard output, and standard error; then, press the < **Return** > key.

- 2 Reset the program counter to the startup address. Select **Execution**→**Set PC to Transfer**. Or, using the command line, enter:

```
Program Pc_Reset
```

When the target program starts execution from the normal compiler startup address, the standard C startup libraries open the following three I/O streams:

- `stdin`
- `stdout`
- `stderr`

The debugger uses an internal table to determine where the streams should be opened. Each of the names (`stdin`, `stdout`, and `stderr`) has an associated translation name:

- `stdin_name`
- `stdout_name`
- `stderr_name`

The translation name contains the name of a file to use when the target requests opening of any of these stdio streams. By default, `stdin_name` contains `/dev/simio/keyboard` (the keyboard), and translations `stdout_name` and `stderr_name` contain `/dev/simio/display` (the standard I/O (stdio) screen).

These translations are used only when opening the streams. They cannot be used to redirect the streams after they have been opened. The target program must be rerun from the startup address to allow the stdio streams to be reopened if the translations have been changed.

Examples

To redirect the standard input file to the keyboard, the standard output file to the display, and the standard error file to file `'/users/project/errorfile'`:

```
Debugger Execution IO_System Stdio_Redirect
"/dev/simio/keyboard", "/dev/simio/display",
"/users/project/errorfile"
```

```
Program Pc_Reset
```

To redirect the standard input file to `'temp.dat'`, the standard output file to `'cmdout.dat'`, and the standard error file to file `'errorlog.err'`:

```
Debugger Execution IO_System Stdio_Redirect
"temp.dat", "cmdout.dat", "errorlog.err"
```

```
Program Pc_Reset
```

To check resource usage

- Using the command line, enter:

```
Debugger Execution IO_System Report
```

The command displays the simulated I/O status, keyboard mode, and the translation names used for stdin, stdout, and stderr.

The SIMIO system has the following default resource limitations:

- 40 open files
- 4 subprocesses

To increase I/O file resources

- 1 Change to directory *68040* in path */usr/hp64000/include* using the **cd** command.
- 2 Change the value of macro *FOPEN_MAX* from 12 to the new maximum number of open files (the limit is 40) in file *stdio.h* using an editor on your system.
- 3 Change to the appropriate environment directory under */usr/hp64000/env/*, then change to the *src* subdirectory.
- 4 Recompile file *startup.c*. Type:

```
cc68040 -Ouc startup.c
```
- 5 Add *startup.o* to the environment library using the command:

```
ar68040 -r startup ../env.a
```

You can increase the simulated I/O file limit by modifying the startup code for your compiler. The code must be modified from the UNIX shell. The maximum number of open SIMIO files descriptors can be increased to 40.

Caution

Compiler startup files compiled with the modified *stdio.h* header file will run only in the debugger environment. Emulators which do not have the debugger interface do not support the increased number of open SIMIO file descriptors. Calls to the SIMIO function `open()` will fail in this environment if 12 file descriptors have already been allocated.



Chapter 5: Viewing Code and Data
To increase I/O file resources



6

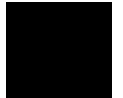

Making Trace Measurements

How to use the debugger to trace the execution of a program in the emulator.

Chapter 6: Making Trace Measurements

This chapter shows you how to:

- Start traces.
- Stop traces.
- Display traces.
- Specify trace events.
- Delete trace events.
- Specify storage qualifiers.
- Specify trigger conditions.
- Halt program execution on the occurrence of a trigger.
- Remove a storage qualification term.
- Remove a trigger term.

The Trace Function

The trace function uses the emulation analyzer in your emulator to capture processor bus cycle information synchronously with the processor's clock signal. A trace is a collection of these captured states.

You can make simple trace measurements using the Code window pop-up menu. Using this menu, you can trace states before and after a line of code is executed.

If you need to make a simple trace measurement, skip the details which follow and turn to "To start a trace using the Code pop-up menu."

You can make complex trace measurements using the command line Trace command. You can tell the debugger exactly which states to store by defining trigger events (a series of events which will start the trace) and storage qualifications (which kinds of states to store).

If you will be making many detailed trace measurements, you may find it easier to use the emulator/analyzer user interface.

Default Trace Specification

The default trigger condition is "never". You can make a default trace measurement by entering the *Trace Again* command. When you use the default trace condition, qualified bus cycles are collected continuously until you halt the measurement. The trace buffer will then contain the bus states prior to the halt.

Trace Events

Trace measurement parameters are specified as events. An event is a bus state consisting of a combination of address, data, and status values.

Address and Data Values. Address and data values may be specified as 32-bit values or a range of 32-bit values. You can specify a mask to mark valid bits in addresses or data to define "don't care" values. You can also specify the logical "NOT" of an address or data value.

Status Values. Status values are the types of bus activities, such as:

- Read or write operations.
- Memory access size.
- Function codes.
- Cycle types.

You can also specify the logical "NOT" of a status value.

Trace Trigger

A *trigger* specifies the bus events that cause the debugger to make a trace measurement. The debugger lets you trigger on the detection of a single event, an OR'ed combination of events, or after a sequence of events are detected. You can specify a sequence of events, the last of which is the triggering event. You can also trigger on the Nth occurrence of an event, where N is a number you specify with the *count* parameter in the *Trace Trigger Event* command.

You can position the trigger event at the start of the trace buffer, centered in the trace buffer, or at the end of the trace buffer.



Storage Qualification

A storage qualifier defines which bus cycles will be stored when you make a trace measurement. You can specify that only cycles corresponding to certain values be stored in the trace buffer. These values can be addresses, a range of addresses, data values, status values (the type of bus activity), or an OR'ed combination of values. You can also specify the logical NOT of the specified value to be the storage qualifier, that is, any condition that does not match the specification. You can specify that the trace function store up to two instruction fetch cycles preceding the qualified state (prestore).

Trace Resources

The trace function uses the emulation analyzer to implement its measurements. The analyzer puts the following limitations on resources available for trace specifications:

- One range resource.
- Eight event resources.
- Seven sequence terms.

If you enter a range value that can be expressed as a "don't care" value (for example, *address 0x100 to 0x1ff*), the debugger uses one of the eight event resources, rather than the range resource. Complex event specifications, such as combinations of *Is* and *Not* terms, can use multiple event resources. Up to seven sequential events can be specified in a trigger specification.

Trace Status

The status of the trace measurement is indicated on the debugger status line by the *TRC:<Trc_status>* field. The possible values for *<Trc_status>* are:

AwtTrg	A trace measurement is in progress, but the trigger condition has not been detected.
BrkRWA	An access breakpoint has been set and will be used as the trigger in the next trace measurement.
Cmplt	A trace measurement has completed.

DataOK	The trace buffer contains valid data.
Halted	The <i>Trace Halt</i> command was used to halt the trace.
Idle	No trace measurement has been executed during the current debug session.
Setup	A trace measurement has been set up (specified), and will start on the next program run or program step command. This status message appears only before the first trace measurement in a debug session.
Trgrd	A trace measurement is in progress, and the trigger has been detected.

Trace status characters

When trace data is displayed, a trace status character may be displayed in front of the trace line. The following table defines the trace status characters.

Trace List Status Characters

Character	Description
*	The indicated trace line is the trigger condition.
+	The indicated trace line is in the middle of a C statement, that is, not the first assembly language statement in the C source statement.
!	The data in the trace buffer line does not match the data in memory.
?	The trace line may be a prefetch.

Access Breakpoints

If you have set access breakpoints with the Breakpt Access, Breakpt Read, or Breakpt Write commands, the trace function will interpret the breakpoints as trace trigger terms. When you step or run your program after setting an access breakpoint, the trace measurement is started automatically. You cannot

define a trace trigger while an access breakpoint is active. This will cause an error condition.

Note

The emulator user interface may specify a trace that overrides a debugger access breakpoint. The debugger interface will set up the access breakpoint trace when a run or step command is issued only if the analyzer is not currently in use. Using both access breakpoints in the debugger and trace features in the emulator is not recommended.

Limitations to the Trace Function

There are limitations to the trace function imposed on the debugger by the use of a foreground monitor and when triggering on C variables and instruction fetches.

Limitations when Using a Foreground Monitor. When you use a foreground monitor, the trace function may capture monitor activity as well as your target program activity.

Limitations when Triggering on C Variables. The emulator's analysis hardware watches bus cycles, and triggers on specified bus values. However, bus cycles do not always map directly to C variables. This limitation takes two forms:

The first form occurs when an access to a C variable requires multiple bus cycles. In addition to requiring multiple bus cycles, the number of cycles and the contents of the data bus on each cycle varies with the memory bus width, data size, and data address alignment.

To illustrate this problem, consider a 32-bit variable `foo` at the odd word address `0x1002`. A write of value `0x01023fff` to `foo` will take multiple bus cycles. The following table shows the number of cycles and the contents of the data bus on each cycle for the three possible memory bus widths.

Bus Cycle	Memory Bus Width		
	8 Bits	16 Bits	32 Bits
	addr (data)	addr (data)	addr (data)
1	10020102102)	10020102102))	10020102102))
2	10030202f02)	1003f3ffff)	1003f3ffff)
3	1003f3ffff)		
4	1005ffffffffff)		

The number of cycles and the data bus values will vary depending on memory bus width, data size, and data address alignment. You must consider these factors when specifying triggers containing both address and data values.

The second form of problem occurs when a C variable is written, but the address never appears on the bus. To demonstrate this problem, consider a 32-bit C variable *foo* at address *0x1002* and a "wild pointer" pointing to address *0x1000*. A 32-bit write indirect through the pointer will overwrite part of variable *foo*, but if the memory bus width is 32 bits, the address of *foo* (*0x1002*) will never appear on the address bus. Similarly, a write indirect through a wild pointer pointing to address *0x1004* will overwrite part of *foo* without the address of *foo* appearing on the bus. This limitation can be overcome by specifying an address range when triggering on a symbol that you suspect is being modified by a wild pointer.

Limitations when Triggering on Instruction Fetches. Instructions located on odd word address boundaries can be traced by specifying address values with the mask operator. For example, if *foo* is located on an odd word address boundary, the command:

```
Trace Trigger Address Is foo &= 0xffffffffc
```

will let the trace function trigger on variable *foo*. The mask operator can also be specified as shown in the following command:

```
Trace Trigger Address Is foo &=~3
```

The tilde operator (*~*) performs the one's complement operation in a C expression.

The debugger will apply the appropriate mask for all instruction fetches if you use the Debugger Option `Trace Fetch_Align` command.

To start a trace using the Code pop-up menu

- 1 Position the mouse pointer over the line of code which should trigger the trace.
- 2 Hold down the right mouse button and select one of the **Trace** items from the Code window pop-up menu.
- 3 When "TRC:Cmplt" appears on the status line, stop execution of the program if it is not already halted.
- 4 Select **Window**→**Trace** to see the trace information.
- 5 Use the keyboard arrow keys or the scroll bar to scroll through the trace information. Press <ESC> <ESC> to exit trace mode.

This will trace the execution of code near the line you selected.

You can choose any one of the following:

- **Trace after** will trace what happens after the selected line is executed.
- **Trace before** will trace what happens before the selected line is executed.
- **Trace about** will trace what happens before and after the selected line is executed.
- **Trace until** will trace what happens before the selected line is executed. When the selected line is reached, execution is stopped automatically.

To start a trace using the command line

A trace measurement is started on the first *Program Step* or *Program Run* command following the specification of a trigger or storage qualifier, or after a *Trace Again* command.

The *Trace Again* command starts the trace using the last trace specification you set up or the default trace specification if you have not set up a trace in the current debug session. The default specification is:

```
Trace StoreQual None
```

```
Trace Trigger Never
```

The default specification causes the trace to execute continuously, storing all bus states in the trace buffer, until you stop the trace by entering the command:

```
Trace Halt
```

If you have set up a trace specification, the trace function behavior is determined by your specification.

The debugger must be in command mode (your target program is halted and the word *Command* is displayed on the status line) in order for you to enter a trace command.

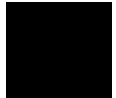

To stop a trace in progress

- Using the command line, enter:

```
Trace Halt
```

And press the < **Return** > key.

If the trace trigger specification is defined to be *Trace Trigger Never*, the trace function will run continuously until you halt the trace.

If you have defined a trace trigger specification, the trace function stops automatically when the trace trigger specification is detected and the trace buffer is full.

To display a trace

- Select **Window**→**Trace**.
- Or:
- In the emulator/analyzer window, select **Display**→**Trace**.
- Or:
- Using the command line, enter:

`Trace Display`

And press the **<Return>** key.

The default trace display shows the high-level program source lines corresponding to the trace states and entries and exits from modules.

Display options allow you to display entry to and exit from modules, assembly language instructions, data read and write cycles, and the raw uninterpreted data collected by the trace function.

The *Line(s)* option allows you to specify a range of lines in the trace buffer to be copied to a specified debugger window or the first state to be displayed in the trace window.

Examples

To view source lines, their corresponding assembly language instructions, and data read and write cycles:

`Trace Display Modules Source Assembly Data`

To copy the raw data in lines -20 through +20 of the trace buffer to a log file you have opened:

`Trace Display Lines -20..20 <Tab> Raw OutputTo 28`

28 is the window number for the log file.

To display the raw data starting with the trigger state in the trace window and cause the debugger to enter trace mode:

```
Trace Display Lines 0 <Tab> Raw
```

To exit trace mode, press the < Esc> key twice. This action returns the debugger to command mode where you can enter commands from the keyboard.

To specify trace events

- Using the command line, enter:

```
Trace Event Specify <event_nmbr> <Tab>  
<event_definition>
```

And press the < Return> key.

You use trace events as terms in the trace trigger specification and in the storage qualification specification. The event definition can be address values, data values, status values, or a logically AND'ed combination of the above.

Examples

Address event. To define event 1 to be the address of function `update_state_of_system`:

```
Trace Event Specify 1 <Tab> Address Is  
update_state_of_system
```

Status event. To define event 2 to be any bus cycle corresponding to an instruction fetch from supervisor memory space:

```
Trace Event Specify 2 <Tab> Status Is FnCde Supr CycTyp  
Fetch
```

Combined address and status event. To define event 3 to be a write access of variable `current_humid`:

Chapter 6: Making Trace Measurements
To delete trace events

```
Trace Event Specify 3 <Tab> Address Is  
&current_humid <Tab> Status Is Write
```

To delete trace events

- Using the command line, enter:

```
Trace Event Delete <event_nmbr>
```

Enter the number of the event you wish to delete, and press the < **Return**> key.

If you attempt to delete an event that is assigned to a storage qualification term or trigger term, the debugger will display an error message on your screen. You cannot delete events that are assigned as storage qualifiers or trigger terms. You can, however, modify these events by entering a new specification.

Examples

To delete event 2:

```
Trace Event Delete 2
```

To specify storage qualifiers

- Using the command line, enter:

```
Trace StoreQual Event <event_nmbr>
```

Enter the number of the event previously defined with the Trace Event Specify command, and press the < **Return**> key.

You can specify a single event or an OR'ed combination of events in the trace storage qualification specification.

If you specify the Prestore function, the trace function stores the two instruction fetch bus cycles immediately preceding the qualified states being stored.

Examples

To store either of two events:

```
Trace Event Specify 1 <Tab> Address Is  
update_state_of_system
```

```
Trace Event Specify 3 <Tab> Address Is  
&current_humid <Tab> Status Is Write
```

```
Trace StoreQual Event 1 <Tab> Or 3
```

The debugger will then store calls to function *update_state_of_system* or write accesses to variable *current_humid*.

To store accesses to *update_state_of_system* along with the two bus cycles immediately preceding the accesses:

```
Trace StoreQual Address Is update_state_of_system <Tab>  
Prestore
```

The prestore operation helps you determine what instructions caused an access to a variable or function.

Note that in the preceding example, we defined the qualifying event in the Trace StoreQual command rather than using an event defined previously with the Trace Event Specify command. When you define the qualifying event in the Trace StoreQual command, you can specify only a single event. You cannot use an OR'ed combination of events as the storage qualification condition.



To specify trigger conditions

- Using the command line, enter:

```
Trace Trigger Event <event_nmbr>
```

Enter the number of the event previously defined with the Trace Event Specify command, and press the <Return> key.

You can specify a single event, an OR'ed combination of events, a specified number of occurrences of a single event or an OR'ed combination of events, or a sequence of events (maximum of seven) in the trace trigger specification. If you specify a sequence of more than seven events, the debugger will respond with an error message indicating that the specification is too complex.

You can define the trigger event in the Trace Trigger command rather than using an event defined previously with the Trace Event Specify command. When you define the qualifying event in the Trace Trigger command, you can specify only a single event. You cannot use an OR'ed combination of events, a sequence of events, or multiple occurrences of an event as the trigger condition.

Examples

Trigger on a single event. To trigger on the occurrence of a call to function *update_state_of_system*:

```
Trace Event Specify 1 <Tab> Address Is  
update_state_of_system
```

```
Trace Trigger Event 1
```

Trigger on a sequence of events. To trigger on a call to function *update_state_of_system* followed by a write access to variable *current_humid*:

```
Trace Event Specify 1 <Tab> Address Is  
update_state_of_system
```

```
Trace Event Specify 3 <Tab> Address Is  
&current_humid <Tab> Status Is Write
```

Chapter 6: Making Trace Measurements
To halt program execution on the occurrence of a trigger

```
Trace Trigger Event 1 <Tab> Then 3
```

Trigger on an OR'ed combination of events. To trigger on a call to function *update_state_of_system* or a write access to variable *current_humid*:

```
Trace Event Specify 1 <Tab> Address Is  
update_state_of_system
```

```
Trace Event Specify 3 <Tab> Address Is  
&current_humid <Tab> Status Is Write
```

```
Trace Trigger Event 1 <Tab> Or 3
```

Trigger on the nth occurrence of an event. To trigger on the fifth call to function *update_state_of_system*:

```
Trace Trigger Event 1 <Tab> Count 5
```

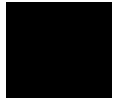

To halt program execution on the occurrence of a trigger

- Enter the keyword *BrkOnTrg* in your trace trigger specification to halt program execution on occurrence of the trigger condition.

Examples

To break on a write to memory location *current_humid*:

```
Trace Trigger Event 3 <Tab> BrkOnTrg PosnTrig End
```

When you start your program, the debugger will execute the program until the trigger condition is detected. Then the debugger will halt the program. The keywords *PosnTrig End* cause the trigger to be stored at the end of the trace buffer, allowing you to view events leading up to the trigger.

To remove a storage qualification term

- Using the command line, enter:

```
Trace StoreQual None
```

And press the < **Return** > key.

This command restores the storage qualification to its default value, that is, all bus cycles will be stored in the trace buffer. If you specified events defined with the Trace Event Specify command, the events are removed from the storage qualification specification, but remain defined.

To remove a trigger term

- Using the command line, enter:

```
Trace Trigger Never
```

And press the < **Return** > key.

This command restores the trace trigger to its default value. Events in trigger terms defined with the Trace Event Specify command are disabled as trigger terms, but are not removed as events. The Trace Trigger Never command causes the trace function to never trigger. The trace will run continuously until you stop the trace using the Trace Halt command.

To trace code execution before and after entry into a function

- 1 Specify the trigger condition.

Chapter 6: Making Trace Measurements
To trace data written to a variable

```
Trace Trigger Address Is function_name <Tab> Status Is  
FnCde Prog PosnTrig Center
```

- 2 Run the program.
- 3 When the trace is completed (the command line will contain the message *TRC:Cmplt*), press **CTRL C** to halt program execution and enter command mode.
- 4 Display the trace data.

To trace data written to a variable

- 1 Define trace event 1 to be a write access to the range of addresses corresponding to the variable.

```
Trace Event Specify 1 <Tab> Address Is  
&variable..+sizeof(variable)-1 <Tab> Status Is Write
```

By using the **sizeof** operator, we can specify an address range the size of the variable to ensure that we capture all bytes of *variable*.

- 2 Assign *variable* as the trigger and storage qualification terms.

```
Trace Trigger Event 1
```

```
Trace StoreQual Event 1
```

- 3 Start program execution.
- 4 Complete the trace.

The the TRC status on the status line will change to *TRC:Trgrd* to indicate that the first write has taken place.

To trace data written to a variable and who wrote to the variable

You may do one of two things to complete the trace:

- To see a full buffer of writes, wait until the status changes to `TRC:Cmplt.`
- To see the trace without waiting, press `<Ctrl> -C` to return to command mode, then halt the trace by entering:

```
Trace Halt
```

- 5 Display the trace information.

To trace data written to a variable and who wrote to the variable

- 1 Define trace event 1 to be a write access to the range of addresses corresponding to the variable.

```
Trace Event Specify 1 <Tab> Address Is  
&variable..+sizeof(variable)-1 <Tab> Status Is Write
```

- 2 Assign the variable as the trigger and storage qualification terms.

```
Trace Trigger Event 1
```

```
Trace StoreQual Event 1 <Tab> Prestore
```

Note that we added the *Prestore* keyword to the `Trace StoreQual` command. The *Prestore* keyword in the storage qualification definition will cause the trace function to capture the last two fetch cycles before the write to *current_humid*, enabling you to see which routine is writing to the variable.

- 3 Start program execution.
- 4 Complete the trace.

To trace events leading up to writing a particular value in a variable

The the TRC status on the status line will change to `TRC:Trgrd` to indicate that the first write has taken place.

You may do one of two things to complete the trace:

- To see a full buffer of writes, wait until the status changes to `TRC:Cmplt`.
- To see the trace without waiting, press `<Ctrl> -C` to return to command mode, then halt the trace by entering:

```
Trace Halt
```

- 5 Halt the trace measurement.
- 6 Display the trace information.

To trace events leading up to writing a particular value in a variable

To trace events leading up to writing the value 0 (zero) to the element *seconds* in a structure pointed to by *time*, perform the following steps.

- 1 Define event 1 to be the write of a data value of 0 to the least-significant word of the integer value *seconds*.

```
Trace Event Specify 1 <Tab> Address Is
&time_struct.seconds <Tab> Data Is 0 <Tab> Status Is
Write
```

- 2 Assign event 1 to be the trace trigger, and position the trigger at the end of the trace buffer so that states leading up to the trigger will be captured.

```
Trace Trigger Event 1 <Tab> PosnTrig End
```

- 3 Disable any storage qualification terms to cause the trace function to store all states.

To execute a complex breakpoint using the trace function

```
Trace StoreQual None
```

- 4 Start program execution and the trace.

```
Program Run
```

- 5 When the trace is completed (the command line will contain the message *TRC: Cmp1t*), press **CTRL C** to halt program execution and enter command mode.
- 6 Display the trace information.

To execute a complex breakpoint using the trace function

The trace function can be used to execute a complex breakpoint in your target program.

Example

- 1 Define event 6 to be a write of value 0x3c (60 decimal) to the least-significant word of the integer value *seconds*.

```
Trace Event Specify 6 <Tab> Address Is  
&time_struct.seconds <Tab> Data Is 0x3c Status Is Write
```

- 2 Define event 7 to be a write to the least-significant word of the integer value *minutes*.

```
Trace Event Specify 7 <Tab> Address Is  
&time_struct.minutes <Tab> Status Is Write
```

- 3 Define the trace trigger as event 6 followed by event 7, and position the trigger at the center of the trace buffer so that states leading up to the trigger and following the trigger will be captured.

Chapter 6: Making Trace Measurements To trace entry to and exit from modules

```
Trace Trigger Event 6 <Tab> Then 7 <Tab> BrkOnTrg  
PosnTrig Center
```

The keyword *BrkOnTrg* causes the debugger to halt program execution when the trigger condition is detected.

- 4 Start the trace measurement.

```
Program Run
```

The program will run until the trigger condition is detected and then halt.

- 5 Display the trace buffer.

```
Trace Display Line(s) 0 <Tab> Source Assembly Data
```

Note that the minutes count is updated at line 0 in the trace display. The trigger specification has allowed us to see the program activity leading up to this event. Press the **Return** key or **F7** function key to scroll through the data source line by source line. Note that the highlighted line in the code window tracks the first line displayed in the trace display. Press the **F6** function key to change the direction of tracking in the trace display.

To trace entry to and exit from modules

- 1 Define event 5 to be any instruction fetch with an opcode value of *4e5x* where *x* is a don't care value.

```
Trace Event Specify 5 <Tab> Data Is 0x4e50 &= 0xffff0  
<Tab> Status Is CycTyp Fetch
```

The don't care condition is specified by specifying a mask in the data specification. **&=** is the mask operator. This value corresponds to the **LINK** and **UNLK** instructions.

- 2 Define event 5 as the trace storage qualifier.

Chapter 6: Making Trace Measurements
To trace entry to and exit from modules

Trace StoreQual Event 5

- 3 Restore the trace trigger to its default value.

Trace Trigger Never

- 4 Start the program and trace.

Program Run

- 5 Let the program run for a moment, then press **CTRL C** to halt program execution and enter command mode.

- 6 Stop the trace measurement.

Trace Halt

- 7 Display the trace information.

Trace Display Modules Assembly

The display should show entries and exits of modules and the assembly code that was captured in the trace buffer. The code should consist of only LINK and UNLK instructions.

Note

This method of viewing entries and exits of modules may not work for all code. It will depend on how your compiler generates code and which compiler options you choose.

7



Editing Code and Data

How to use the debugger to make permanent or temporary changes to source code, memory contents, and registers.

Editing Files

The graphical interface gives you a number of context-dependent and context-independent editing commands. From several screens, you can bring up the source file that contains the source line or symbol you are viewing in the display.

The interface will choose the “vi” editor as its default editor, unless you specify another editor by setting an X resource. Refer to the chapter “Configuring the Debugger” for more information about setting this resource.

Remember to re-compile

When you use the editor to change a source code file, you will need to re-compile the source file. You can recompile with a click of the mouse if you define the **Make** action key to compile the target program.



To edit source code from the Code window

- Place the mouse pointer over the line you want to edit. Select **Edit source** from the Code window pop-up menu.

The debugger will start the editor in a new X window. The cursor in the editor window will be on the same line of code as the mouse pointer in the Code window.

After editing the file, you quit the edit session by the standard method for the editor used.

You will need to re-compile the source file. You can recompile with a click of the mouse if you define the **Make** action key to compile the target program.

To edit an arbitrary file

- 1 Select **File**→**Edit**→**File**.
- 2 Using the file selection dialog box, enter the name of the file you wish to edit; then, click on the OK pushbutton.

After editing the file, you quit the edit session by the standard method for the editor used.

To edit a file based on an address in the entry buffer

- 1 Place an address reference (either absolute or symbolic) in the entry buffer.
- 2 Select **File**→**Edit**→**At () Location**.

The interface determines which source file contains the code generated for the address in the entry buffer and opens an edit session on the file.

To edit a file based on the current program counter

- Select **File**→**Edit**→**At PC Location**.

The interface determines which source file generated the address currently in the program counter and opens an edit session on that source file. The interface will issue an error if it cannot find a source file for the address in the PC.

Patching Source Code

When you change source code by editing the C source file, you need to re-compile.

The debugger provides several ways to patch your program without re-compiling:

- Change a variable's value using a C expression.
- Apply a patch using a breakpoint macro.

To change a variable using a C expression

- 1 Enter a C expression in the entry buffer.

A good way to do this is to highlight an expression from your source code using the left mouse button. When you release the button, the expression will appear in the entry buffer. Now edit the expression to have the desired value.

- 2 Click on the **C Expr ()** action key. Or select **Display→C Expression** from the menu bar.

The value of the variable will be changed until the program modifies it. You can continuously monitor the variable's value if you display it in the Monitor window (use the **Monitor ()** action key or the **Expression Monitor Value** command).

Or:

- Using the command line enter:

```
Expression C_Expression <expression>
```

To patch a line of code using a macro

- 1 Set a breakpoint at the line you wish to patch.

An easy way to set the breakpoint is to click the right mouse button on the line in the Code window.

- 2 Attach a macro to the breakpoint.

Choose **Attach Macro ...** from the Code window pop-up menu.

- 3 Write a macro to patch the code.

In the Macro Operations dialog box, enter the name of a new macro and click on the **Edit** button.

The macro may contain any number of C expressions and debugger commands.

The last two lines of the macro should be:

```
$Modify Register @PC = #next_line$;  
return(1)
```

where *next_line* is the number of the line after the breakpoint. Return 0 instead of 1 if you want the debugger to stop after the macro is executed.

Exit the editor as usual, then click on the **Attach** button in the Macro Operations dialog box.

Now whenever the breakpoint line is encountered, the debugger will execute the macro before the patched line is executed. The macro will execute your patch code, then skip to the next line.

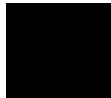

To patch C source code by inserting lines

- 1 Define a macro containing the inserted statements. The macro must provide a return value of 1 (true) in order for the program to continue after the macro is executed.
- 2 Set a breakpoint on the C line following the point where the insertion should occur and attach the macro to the breakpoint.
- 3 Start your program.

The program will run until the breakpoint is encountered. The debugger will then interpret and execute the C statements in the macro, and continue executing the program.



To patch C source code by deleting lines

- 1 Write a macro that sets the program counter to point to the first line of code beyond the lines of code that you want to delete. The macro must provide a return value of 1 (true) in order for the program to continue after the macro is executed.
- 2 Set a breakpoint on the first line to be deleted and specify the macro with that breakpoint.
- 3 Start your program.

The program will run until the breakpoint is encountered. The macro will then set the program counter to the line specified in the macro. Program execution will then continue, skipping the program lines between the breakpoint and line specified in the macro.

Example

Consider the following code:

Chapter 7: Editing Code and Data
To patch C source code by deleting lines

```
25     count = 5;
26     for (i=0; i < MAXNUM; i++)
27     {
28         array[i]=1;
29         count=count+2;
30         k=count*i;
31     }
```

To delete lines 29 and 30, and insert a new line incrementing *count* by one, you could write the following macro:

```
Debugger Macro Add patch_29()
{
    count++;
    $Expression C_Expression @PC = #31$;
    return(1);
}
.
```

To execute the code patch, enter the command:

```
Breakpt Instr #29;patch_29()
```

and run your program.

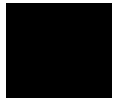

Editing Memory Contents

This section shows you how to:

- Change memory location values.
- Copy a block of memory.
- Fill a block of memory with values.
- Compare two blocks of memory.
- Change the contents of a register.
- Unload BBA data from program memory.

To change the value of one memory location

- 1 Select **Modify**→**Memory**.

Or, using the command line, enter:

```
Memory Assign <Size>
```

- 2 Using the command line, select either Byte, Word, or Long as the size of the memory location, and enter the expression that assigns a value to an address, and press the < **Return** > key.

To change the values of a block of memory interactively

- 1 Select **Modify**→**Memory**.

Or, using the command line, enter:

```
Memory Assign <Size>
```

- 2 Using the command line, select either Byte, Word, or Long as the size of the memory location, enter the address of the beginning of the block, and press the < **Return** > key.

This starts the interactive memory modification mode.

- 3 Enter the value for the location displayed in the Journal window and press the < **Return** > key.
- 4 To exit this mode, press the < **Return** > key without entering a value.

Example

To display the contents of memory location 1000h and allow interactive modification of memory contents:

```
Memory Assign Byte 1000h  
00001000 = 0x48 72:
```

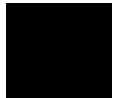

To copy a block of memory

- 1 Using the command line, enter:

```
Memory Block_Operation Copy
```
- 2 Enter the address range of the memory to be copied, followed by a comma.
- 3 Enter the starting address of the destination and press the < **Return** > key.

Example

To copy the block of memory starting at address 1000h and ending at address 10ffh to a block of the same size starting at address 5000h:

```
Memory Block_Operation Copy 1000h..10ffh,5000h
```

To fill a block of memory with values

- Using the command line, enter:

```
Memory Block_Operation Fill <Size>
```

Select either Byte, Word, or Long as the size of the memory locations, enter the expression that assigns a value to locations in a range of addresses, and press the < **Return** > key.

Example

To fill memory locations 1000h through 1007h with the long pattern 61626364, 65666768:

```
Memory Block_Operation Fill Long 0x1000..+7='abcdefgh'
```

To compare two blocks of memory

- Using the command line, enter:

```
Memory Block_Operation Match <Mismatch_Operation>
```

Select either Repeat_On_Mismatch or Stop_On_Mismatch to specify what happens when a mismatch is found, enter the address range to be compared and the starting address of the range that it is compared to; then, press the < **Return** > key.

Example

To compare the block of memory starting at address 1000h and ending at address 10ffh with a block of the same size beginning at address 5000h and stop when a difference is found:

```
Memory Block_Operation Match Stop_On_Mismatch  
1000h..10ffh,5000h
```

To re-initialize all program variables

- Select **File**→**Load**→**Program Only ...**, then use the File Selection dialog box to select the absolute file.

Or:

- Using the command line, enter:

```
Program Load New Code_only No_Pc_Set <absolute_name>
```

Enter the name of the absolute file whose code is to be loaded, and press the **< Return >** key.

The code will be loaded without loading symbols or resetting the PC.

The debugger does not save the initial values of variables. The only way to restore the initial values is to re-load the program. After re-loading the program, you may need to restore some debugger settings; for example, you might need to re-specify variables for the Monitor window.

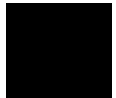

To change the contents of a register

- Select **Modify**→**Register**. This will display the Modify Register dialog box.

Or:

- Using the command line, enter:

```
Memory Register
```

On the command line, enter the name of the register and the value to which the register's contents should be changed, and press the **< Return >** key.

Registers may also be modified by using "@register" in a C_expression.

Chapter 7: Editing Code and Data

To change the contents of a register

Example

To modify register values interactively:

```
Memory Register
```

The program counter (PC) is displayed in the journal window. You can modify the PC by entering a value (10a4h in this example) at the cursor prompt and pressing < **Return**> . The PC will be modified, and the next register will be displayed:

```
@pc      = 0x000010B8      4280: 10a4h
@sp      = 0x00015DB4      89524:
```

Press < **Return**> without entering a value to exit this mode.

To set the value of register @d1 to 44h:

```
Memory Register @d1=0x44
```

To interactively change the value of register @d1:

```
Memory Register @d1
```



Using Macros and Command Files

How to use macros and command files to make debugging easier.

Chapter 8: Using Macros and Command Files

The debugger provides several ways for you to simplify tasks that you do often.

- **Macros** are C-like functions. You can call macros individually, attach them to breakpoints, or automatically execute them with each program step. Macros are especially useful for temporarily patching C code.
- **Command files** contain series of debugger commands. The debugger can read a command file and execute the commands found there as if they were entered directly into the interface command line. Command files are useful for setting up the debugger, for executing a program to a certain point, and for automated testing.
- **Action keys** are shortcut definitions or "hotkeys" which allow you to add new commands to the graphical interface. Action keys are useful for simplifying frequently-used commands, for making the debugger easier to use for co-workers who do not frequently use a debugger, and for making the debugger into a framework for demos and tutorials.



Using Macros

A macro is a C-like function consisting of debugger commands and C statements and expressions.

Macros are most often used to:

- Patch C source code.
Often, bugs found with the debugger can be temporarily patched with C source statements in macros. You do not have to exit the debugger, edit the source code, recompile and link, and then reenter the debugger. Instead, you can make a temporary patch by using breakpoint macros.
- Return values to expressions.
- Create conditional breakpoints.
- Execute commands after each program step command.
- Execute a set of commands.

Macros can:

- Have input parameters (macro arguments).
- Define macro local variables.
- Contain C statements and expressions.
- Refer to target variables and registers.
- Refer to user-defined variables.
- Have return values.
- Call other macros.
- Can be used in expressions (if they return values).
- Execute most debugger commands.

Macros cannot:

- Define global variables.
- Define static variables.
- Be recursive.
- Define other macros.
- Contain the conditional operator (expression ? expression : expression).

Macros can be called:

- By specifying the macro name in an expression.
- By calling the macro from within another macro.
- With the Debugger Macro Call command.
- With the Breakpt command.
- With the Program Step With_Macro command.

Chapter 8: Using Macros and Command Files

Using Macros

This section shows you how to:

- Define a macro.
- Call a macro.
- Stop a macro.
- Display macro source code.
- Patch C source code by using macros.
- Delete a macro.

Saving and re-using macros

You can define and save macros interactively during a debugger session.

Macro limits

The maximum number of characters that can be entered on a line in a macro definition is 255. When entering macro interactively, the debugger does not respond to more than 78 characters on a line. When reading a command file, the debugger stops recognizing characters after 255 characters have been read on a line.

The maximum number of lines allowed in a macro depends on the complexity of the lines. Macros with too many lines (too complex) will fail. Error 92 "*Not enough memory for expression*" will be displayed.

A maximum of 40 parameters may be specified in a macro definition.

Once you have defined a macro, you can use it any time during the debugging session, whenever that set of commands or statements is needed.

Caution

The pseudoregister `@cycles` is not implemented in the emulation environment. Macros written for execution in both the simulation and emulation environments must not refer to `@cycles`.

Macro comments

Macros support C comments (introduced by the characters `/*` and terminated with the characters `*/`).

Macro arguments

You can use formal macro arguments throughout the macro definition. They are replaced at execution time by the actual parameters present in the macro call. The actual parameter is coerced to the corresponding formal parameter type. If coercion is not possible, an error occurs.

You must list the macro's arguments (if any), along with their associated types, when you define the macro. For example, the following listing defines arguments for the built-in macro `strcpy()`:

```
Debugger Macro Add int strcpy(target, source)
char *target;
char *source;
```

Macro variables

Variables that are local to the macro may be created within the macro. The definition of local variables follows the rules of C, with the exception that you cannot define variables with initializers. Variables may be defined to have a simple type, or they may be of type array or pointer. Derived types (such as structures and unions), enumerated types, and typedefs are not legal within macros.

The macro processor does not recognize the C keywords `extern`, `auto`, `static`, and `register`. The macro processor reports an error if these C keywords are used. Static variables are not scoped within a macro. However, symbols created with the Symbol Add command (debugger symbols) are globally scoped, and can be accessed from within a macro. Register variables (such as `@PC`) may also be accessed from within a macro.

Target program symbols can also be accessed from within a macro. Variables which are globally scoped within the target program can be accessed directly. File static, function static, and automatic variables can be accessed directly only if the current context of the debugger is the module or function in which they are scoped. Otherwise, they require a module or function name as a qualifier before they can be accessed. For example, assume the following definition exists in your target program, in a file called `init.c`:

```
...
static int i;          /* file static */
...
foo(int parm)
{
    static int j;      /* function static */
    auto int k;        /* function local */
...
}
```

```
}  
...
```

If a macro is executed while the PC is pointing into the function `foo()`, variables `i`, `j`, and `k` can be directly accessed. If this is not the case, `i` must be accessed with a module qualifier, such as `init|i`. The function static `j` must be accessed as `init|foo|j`. The automatic `k` can be accessed as `init|foo|k` if the stack frame for `foo()` is alive.

Macro control flow statements

Macros support the following C control flow statements:

- If-else
- While and For
- Do-while
- Break and Continue in While, For, and Do statements.

However, macros cannot contain conditional expressions of the form:

```
<expression>?<expression>:<expression>
```

Macro return values

Macros support the C “return” statement for returning values.

If a breakpoint macro returns a nonzero value, program execution continues. If it returns a zero value, program execution is halted. If a macro does not return a value, it should be declared as void when it is defined.

Macros containing debugger commands

You can create macros that contain only a sequence of debugger commands. Macros containing only debugger commands are similar to command files. You can use these macros to set up complex initialization conditions.

You cannot use the following commands in macros:

- Program Run
- Program Step
- Program Step Over
- Debugger Host_Shell
- Debugger Macro Add
- Symbol Add
- Symbol Remove

- File Command
- Debugger Quit

To display the Macro Operations dialog box

- Select **Breakpoints**→**Edit/Call Macro** from the menu bar.

Or:

- Select **Attach Macro** from the Code window pop-up menu.

The Macro Operations dialog box allows you to call predefined macros, edit or call existing user-defined macros, and create new macros.

To define a new macro interactively using the graphical interface



- 1 Display the Macro Operations dialog box.
- 2 Move the mouse pointer to the Selected Macro entry area.
- 3 Type < **Ctrl**> **-U** to clear the Selected Macro entry area, then type the name of the macro you wish to create.

When you press < **Return**> or click on the **Edit** button, the debugger will display an editor window.

A "skeleton" macro will appear in the editor window.

- 4 Edit the macro definition.

Chapter 8: Using Macros and Command Files

Using Macros

When you exit the editor, save the macro under the default name. If you save it under a different name, the macro may be lost.

See Also

See "To use an existing macro as a template for a new macro" if you want to use an existing macro as the basis for a new macro.

Example

To create an macro called "test_macro", select **Breakpoints**→**Edit/Call Macro** and enter "test_macro" in the Selected Macro area. Now press < **Return**> or click on the **Edit** button. Edit the macro in the editor window. If you are using the **vi** editor, exit using the "ZZ" command. The new macro should now appear at the end of the Defined Macros list.

To use an existing macro as a template for a new macro

- 1 Display the Macro Operations dialog box.
- 2 In the dialog box, select the macro you wish to use as a template.
- 3 Click on the **Edit** button.
- 4 In the editor, change the name of the macro.

Now you may edit the parameters and body of the macro.

When you exit the editor, the macro will be saved under the new name. The original macro will not be changed.

To define a macro interactively using the command line

- 1 Enter the Debugger Macro Add command followed by an optional return type, and then a macro name. The macro name must be followed by parentheses; the parentheses can optionally enclose macro arguments separated by commas.

```
Debugger Macro Add [<type>] <name> ([parm,parm,...])  
[<parm_types>;]
```

- 2 Enter the text of the macro body.

```
{  
  [[<C_expr>|<C_stmt>|<debugger_cmd>];...]  
}
```

- 3 End the macro definition with a period as the first and only character on a line. The macro is checked for syntax errors as soon as the period is encountered. If an error is found within a macro, the macro definition is not saved. The macro must be completely reentered.

Your completed macro definition should have the following syntax:

```
Debugger Macro Add [<type>] <name> ([parm,parm,...])  
[<parm_types>;]  
{  
  [[<C_expr>|<C_stmt>|<debugger_cmd>];...]  
}  
.
```

Debugger commands can be embedded in the macro by enclosing the commands between \$ characters. For example,

```
$Expression C_Expression @PC = #31$;
```

No standard C library functions are available from within a macro. However, there are built-in macros available in the debugger that perform similar functions (refer to the "Predefined Macros" chapter).

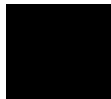

To define a macro outside the debugger

- 1 Using a text editor on your host system, define the macro.
- 2 Save the macro definition in a command file (< filename> .com).
- 3 Start the debugger.
- 4 Load the command file into the debugger using the File Command command.

As the macro is loaded into the debugger, the macro processor parses the macro, looking for syntax errors. If the macro definition contains no errors, it is loaded into the debugger's symbol table.

If an error is detected, the macro processor reports the error and quits loading the command file. The macro remains undefined.

The number of macros that you can define is limited only by the available memory on your host computer system.

To edit an existing macro

- If you want to edit a macro attached to a breakpoint, select **Edit Attached Macro** from the Code window pop-up menu.

Or:

- 1 Display the Macro Operations dialog box.
- 2 Select the macro you want to edit.
- 3 Click on the Edit button.

Remember to save the macro under the default file name when you leave the editor (use the "ZZ" or ":wq!" command in **vi**).

To save macros

- Select **File→Store→User-Defined Macros...**

The File Selection dialog box will be displayed so that you can choose a file in which to save the macros. The debugger will automatically add a *.com* extension to the file name.

The debugger will save all of the your user-defined macros to a file.

The debugger does not provide a way to save only selected macros. If you want to save macros in separate files, you can create the macros using a text editor.

To load macros

- Select **File→Load→User-Defined Macros...**

Choose the macro file to load from the File Selection dialog box.

If macros do not load

- Check that the macros do not directly access local program variables.

When the debugger loads macros which access local program variables, the debugger does not know which local scope to use to define the macro.

If you need to access local program variables in a macro, pass them to the macro as parameters.

To call a macro

- Select **Breakpoints**→**Edit/Call Macro ...**→**Call**.

Or:

- Using the command line, enter:

```
Debugger Macro Call
```

Enter the name of the macro to be called, and press the < **Return** > key.

When a macro is called with the Debugger Macro Call command, its return value is ignored. Macros are typically called in this manner for the side effects they generate.

Example

If you have the following macro definition:

```
Debugger Macro Add void stackchk()  
{  
  /* The symbols 'stack' and 'TopOfStack' exist in the compiler's */  
  /* environment library, and are addresses which indicate the   */  
  /* bottom and the top of the system stack. The symbol @sp is a */  
  /* debugger reserved symbol which contains the current value of */  
  /* the processor's stack pointer.                               */  
  $Expression Printf "%d bytes of stack used", TopOfStack - @sp$;  
  $Expression Printf "%d bytes of stack available", @sp - stack$;  
}  
.
```

the command:

```
Debugger Macro Call stackchk()
```

displays, in the journal window, the amount of stack used and the amount of stack left.

To call a macro from within an expression

- Enter a macro call as part of any expression entered on the command line of the debugger.

The debugger will evaluate the macro and use its return value when evaluating the rest of the expression.

Example

If you have the following macro definition:

```
Debugger Macro Add int power(x,y)
int      x;
int      y;
{
    int      i;          /* Loop counter */
    int multiplier;     /* Value x is multiplied by */

    /* Multiply x by itself y -1 times */
    for (i = 1, multiplier = x; i < y;i++)
        x *= multiplier;

    /* Return x ^y */
    return x;
}
.
```

The command:

```
Expression Display_Value 33.3 + power(2,3)
```

will call and evaluate the macro, displaying the value 41.3 in the debugger's journal window.

To call a macro from within a macro

- You can call a macro from within a macro when they are part of an expression.

The following restrictions apply to calling macros from within a macro:

- The macro called must have been previously defined.

Chapter 8: Using Macros and Command Files

Using Macros

- The macro cannot call itself.

Example

If you have the following macro definition:

```
Debugger Macro Add int ten_to_the(y)
int    y;
{
    return power(10,y); }
.
```

the macro will compute $10^{**}y$ by calling the previously defined macro *power()*.

To call a macro on execution of a breakpoint

- Select **Attach Macro** from the Code window pop-up menu.

Or:

- When using the command line to set a breakpoint, add a semicolon (;) and the name of the macro to the command.

When setting breakpoints, you can attach a macro to the breakpoint. Whenever the breakpoint is encountered, the macro is executed. Depending on the return value of the macro, program execution will either stop or continue.

- If the macro returns zero, program execution stops at the breakpoint.
- If the macro returns a nonzero value, program execution continues at the breakpoint.

Macros attached to breakpoints can test program or user-defined variables before determining whether execution should break or not (by returning zero or nonzero values, respectively).

Macro control flow statements within a breakpoint macro can alter execution flow in the target environment based on target or debugger variable values. You can also include C expressions in macros. By using control flow statements and C expressions in macros, you can patch your C programs.

Example

The following example shows how return values can be used to conditionally control a breakpoint. The example uses the Debugger Macro Add and Breakpt Write commands to define a breakpoint that occurs only when the target variable `days` becomes greater than 31.

```
Debugger Macro Add int daycheck()
{
    if (days > 31)
        return 0;
    else
        return 1;
}
.
```

When the break occurs, the macro is executed. If `days` is less than or equal to 31, program execution continues. If `days` is greater than 31, program execution stops.

If you have the following macro definition:

```
Debugger Macro Add int break_when(stopfunction, min, max)
char    *stopfunction;
int     min;
int     max;
{
    /* Debugger symbol @function is a char pointer to the name */
    /* of the current function. Compare the current function */
    /* with the function name passed, using the built-in macro */
    /* memcmp(). */
    if (!strcmp(@function, stopfunction))
    if ((global_var > min) && (global_var < max))
    {
        $Expression Printf "global_var: %d\n", global_var$;
        return 0;
    }
    /* Not in specified function, return 1 so that program will */
    /* continue executing. */
    return 1;
}
.
```

the command:

```
Breakpt Write &global_var; break_when("foo", 256, 512)
```

will set a write breakpoint on the global variable `global_var`. Whenever the program writes to `global_var`, the macro `break_when()` is executed with the parameters `"foo"`, `256`, and `512`. The macro returns the value 1 until the value of `global_var` falls between 256 and 512 because of a write to `global_var` in the function `foo()`. The macro then returns 0, causing the program to halt.

To call a macro when stepping through programs

- Select **Execution**→**Step**→**with Macro ...**

Or:

- Using the command line, enter:

```
Program Step With_Macro
```

Enter the name of the macro to be called, and press the < **Return**> key.

You can use the Program Step With_Macro command to execute a macro after the step occurs. Calling a macro in this manner is useful in tracking down subtle bugs.

Example

If the function *foo()* was corrupting automatic variables *index* and *ch* on the stack, the following macro and commands could be used to identify the line where the corruption was occurring:

```
Debugger Macro Add void auto_check()
{
    if ((index < 0 || index > 80) || (ch < 32 || ch > 126))
    {
        $Window Screen_On High_Level$;
        $Expression Printf "Autos corrupted!!!\n"$;
        $Expression Printf "index: %d ch: %c\n", index, ch$;
    }
}
.
```

```
Program Run Until foo
```

```
Program Step With_Macro auto_check()
```

To stop a macro

- Press **< Ctrl> -C**.

Macros can be halted during execution by pressing **< Ctrl> -C**.

Caution

< Ctrl> -C will stop execution of a macro. Pressing **< Ctrl> -C** may interrupt a code-patching macro before it completes execution. If this occurs, you cannot restart program execution within the macro where it stopped.

To display macro source code

- Choose **Edit** in the Macro Operations dialog box.

Or:

- Using the command line, enter:

```
Debugger Macro Display <macro_name>
```

Enter the name of the macro you want to display, and press the **< Return>** key.

This command will write the macro source to the journal window. If you want to write the macro source to a user-defined window or to a file, you can specify an optional user window number as the destination.

Example

To write the source for macro `auto_check()` to user window 51:

```
Debugger Macro Display auto_check() ,51
```

To delete a macro

- Using the command line, enter:

```
Symbol Remove <macro_name>
```

Enter the name of the macro you want to delete, and press the < **Return** > key.

Use the Breakpt Delete command to remove the breakpoint that called the macro.

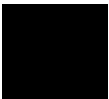

Using Command Files

A command file is an ASCII file containing debugger commands.

You can create command files from within the interface by logging commands to a command file as you execute the commands, or you can create or modify command files outside the interface with an ASCII text editor.

The debugger can read a command file and execute the commands found there as if they were entered directly into the interface command line.

Command files can also call other command files and the interface will execute the called file like a subroutine of the calling file.

This section shows you how to:

- Record commands.
- Place comments in a command file.
- Pause the debugger.
- Stop command recording.
- Run a command file.
- Set command file error handling.
- Append commands to a command file.
- Record commands and results to a journal file.
- Stop recording commands and results to a journal file.
- Open a file or device for read or write access.
- Close the file associated with a window number.
- Use the debugger in batch mode.



To record commands

- Use the `-l command_file` option to the `db68k` command when starting the debugger. (The debugger appends the file extension `.com` to *command_file*.)

```
$ db68k -e <emulator_id> -l <command_file> <RETURN>
```

Or:

- Select **File**→**Log**→**Record Commands**. Using the file selection dialog box, enter the name of the file to which the commands will be saved, and click on the OK pushbutton.

Or:

- Using the command line, enter:

```
File Log On
```

Enter the name of the file to which commands will be saved, and press the **< Return >** key.

All commands, whether they are entered from the menus or the command line, are recorded to the *log file*. If a command causes an error, both the command and the error code are recorded as comments.

Example

To start logging commands to file “cmdfile1.com”:

```
File Log On cmdfile1
```

To place comments in a command file

- Using the command line, enter:

```
File Log Comment
```

Enter the comment that should be placed in the command file, and press the **< Return >** key.

In the command file, the comment is prefixed with a semicolon (;).

When editing command files, you can also use C-style comments (introduced by the characters `/*` and terminated with the characters `*/`).

Example

To place the comment “Place this comment in a command file.” in the command file:

```
File Log Comment Place this comment in the command file.
```

To pause the debugger

- Using the command line, enter:

```
Debugger Pause
```

And press the **< Return >** key.

The debugger is paused until you enter the spacebar.

You can also specify that the debugger pause for a number of seconds by using the Debugger Pause Time command.

The Debugger Pause commands are useful when executing command files.

To stop command recording

- Select **File**→**Log**→**Stop Command Recording**.

Or:

- Using the command line, enter:

```
File Log oFF
```

And press the < **Return** > key.

The command file is closed.

To run a command file

- Use the `-c command_file` option to the `db68k` command when starting the debugger. (The *command_file* must end with the `.com` extension.)

```
$ db68k -e <emulator_id> -c <command_file> <RETURN>
```

Or:

- Select **File**→**Log**→**Playback**. Using the file selection dialog box, enter the name of the command file, and click on the OK pushbutton.

Or:

- Using the command line, enter:

```
File Command
```

Enter the name of the command file from which debugger commands will be executed, and press the < **Return** > key.

The debugger will begin executing commands found in the command file as if those commands were entered directly into the interface. The debugger will continue to execute commands until it reaches the end of the file or, perhaps, until an error occurs, depending on the command file error handling mode (see “To set command file error handling”).

To interrupt playback of a command file, press the < **Ctrl** > **-c** key combination. (If the graphical interface is being used, the mouse pointer must be within the interface window.)

Example

To start executing command from the file “cmdfile1.com”:

```
File Command cmdfile1
```

See Also

File Startup in the "Debugger Commands" chapter

To set command file error handling

- Using the command line, enter:

```
File Error_Command <Handling_Mode>
```

Select either Abort_Read, Continue_Read, or Quit_Debugger error handling mode, and press the < **Return** > key.

When an error occurs while executing a command file:

Abort_Read causes the debugger to stop reading the command file.

Continue_Read causes the debugger to continue executing the command file with the next command.

Quit_Debugger causes the debugger session to end.

To append commands to an existing command file

- Using the command line, enter:

```
File Log Append
```

Enter the name of the file to which commands will be appended, and press the < **Return** > key.

Example

To append command to the file “cmdfile1.com”:

```
File Log Append cmdfile1
```

To record commands and results in a journal file

- Use the `-j journal_file` option to the `db68k` command when starting the debugger. (The debugger appends the file extension `.jou` to `journal_file`.)

```
$ db68k -e <emulator_id> -j <journal_file> <RETURN>
```

Or:

- Select **File**→**Log**→**Record Journal**. Enter the name of the file to which the commands and results will be saved, and click on the OK pushbutton.

Or:

- Using the command line, enter:

```
File Journal On
```

Enter the name of the file to which commands and results will be saved, and press the < **Return** > key.

Journal files are similar to command files. They contain debugger commands entered during a debug session. Journal files also contain any output generated by debugger commands. Journal files contain everything that is written to the journal window during a debug session.

Example

To start recording commands and results to file “journal1.jou”:

```
File Journal On journal1
```

To stop command and result recording to a journal file

- Select **File**→**Log**→**Stop Journal Recording**.

Or:

- Using the command line, enter:

```
File Journal oFF
```

And press the < **Return** > key.

To open a file or device for read or write access

- Using the command line, enter:

```
File User_Fopen
```

Select the open option, window number, and file name; then, press the < **Return** > key.

Chapter 8: Using Macros and Command Files

Using Command Files

After opening a file using the File User_Fopen Append or File User_Fopen Create command, you can use the Expression Fprintf command to write information to the file. Files opened for reading may be read from the built-in macro fgetc(). See the "Predefined Macros" chapter of this manual for a complete description of this macro.

The window number must be between 50 and 256 inclusive.

Use the Window Delete or the File Window_Close command to close the file.

Example

To open user window 57 and redirect any data written to window 57 to the file 'varTrace.out':

```
File User_Fopen Create 57 File varTrace.out
```

To close the file associated with a window number

- Using the command line, enter:

```
File Window_Close
```

Enter the window number associated with the file when it was opened, and press the < **Return** > key.

Example

To close the file associated with user window number 57:

```
File Window_Close 57
```

To use the debugger in batch mode

- Use the `-b` and `-c command_file` options to the `db68k` command when starting the debugger.

When using the debugger in batch mode, `stdin`, `stdout`, and `stderr` are disabled. The `-b` option must be accompanied by the `-c` option and a debugger command file. All commands are read from the command file. No user interaction with the debugger is allowed. In batch mode, the debugger can be executed as a background process. This mode is commonly used for automatic testing.

Example

```
$ db68k -b -e <emulator> -c <command_file>
```



Chapter 8: Using Macros and Command Files
Using Command Files

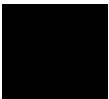

9



Configuring the Debugger

How to change the appearance and behavior of the debugger.

Configuring the debugger

These tasks are grouped into the following sections:

- Setting the general debugger options.
- Setting the symbolics options.
- Setting the display options.
- Modifying display area windows.
- Saving and loading the debugger configuration.
- Setting X resources.

Some options can be set using either the Debugger Options dialog box or the command line. Other options can be set only using the command line.



Setting the General Debugger Options

This section describes how to:

- Display the Debugger Options dialog box.
- List the debugger options settings.
- Change debugger options settings.

To display the Debugger Options dialog box

- Select **Settings**→**Debugger Options** from the menu bar.

You can change settings in the Debugger Options dialog box by clicking on the appropriate buttons.

To list the debugger options settings

- Select **Settings**→**Debugger Options ...**

Or:

- Using the command line, enter:

```
Debugger Option List
```

And press the < **Return** > key.

The following information is displayed:

```
> Debugger Option List
Processor      = 68040
Intermixed    = On
Assem_Symbols = On
```

Chapter 9: Configuring the Debugger

Setting the General Debugger Options

```
Step_Speed      = 0
Radix           = Decimal_Input, Decimal_Output
Stdio_Window    = Swap
Check_Args      = oFF
Align_Bp        = oFF
Breakpt_Window  = Swap
More            = On
Highlight       = Inverse
Frame_Stop      = oFF
Command_Echo    = oFF
View_Window     = Swap
Demand_Load     = oFF
Amt_Scroll      = 1
```

To specify whether command file commands are echoed to the Journal window

- Using the command line, enter:

```
Debugger Option Command_Echo
```

Select On or oFF, and press the < **Return**> key.

On	Command file commands are echoed to the Journal window.
oFF	Command file commands are not echoed to the Journal window.

To set automatic alignment for breakpoints and disassembly

- In the Debugger Options dialog box, click on the Align Breakpoints button to toggle alignment.

Or:

- Using the command line, enter:

```
Debugger Option General Align_Bp
```

Select On or oFF, and press the < **Return**> key.

On Debugger automatically aligns breakpoints or locations to be displayed in mnemonic format to the beginning of instructions.

oFF Breakpoints are not automatically aligned.

oFF is the recommended setting because of software break instruction replacement.

To set backtrace display of bad stack frames

- In the Debugger Options dialog box, click on the Frame Stop button to toggle display of bad stack frames.

Or:

- Using the command line, enter:

```
Debugger Option General Frame_Stop
```

Select On or oFF, and press the < **Return**> key.

On Only consecutive valid stack frames are displayed.

oFF All stack frames, including bad frames, are displayed.

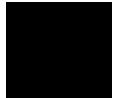

To specify demand loading of symbols

- Using the command line, enter:

```
Debugger Option General Demand_Load
```

Select On or oFF, and press the < **Return** > key.

On Symbol information is loaded on an as-needed basis.

oFF All symbol information is loaded.

The **-doff** command-line option overrides the On setting when the settings are saved in a startup file.

To select the interpretation of numeric literals (decimal/hexadecimal)

- In the Debugger Options dialog box, hold the *command select* mouse button down on the button for "Input Radix" or "Output Radix". Release the button to select "Decimal" or "Hex".

Or:

- Using the command line, enter:

```
Debugger Option General Radix
```

Select Decimal or Hex, and press the < **Return** > key.

If you select Hex, input and output values are interpreted as hexadecimal for assembly-level references. Any assembly-level number you want interpreted as decimal must be terminated with a *T* (for example, specify 32 as 32T).

Even if you select Hex, the following inputs will *not* be interpreted as hexadecimal:

- Line numbers starting with "#".
- Variables in high-level expressions, including **C_Expression** and macro expressions. To cast a high-level expression as hexadecimal, use a leading "0x" or a trailing "h".
- Debugger variables including:
 - breakpoint numbers,
 - viewport numbers, and
 - data viewport line numbers.

Binary numbers are not available when you select Hex.

Floating point and enumeration type values are not affected.

To specify step speed

- Using the command line, enter:

```
Debugger Option General Step_Speed <numb 0..100>
```

Enter the step speed number (from 0 to 100), and press the < **Return** > key.

Higher numbers represent slower speeds.



Setting the Symbolics Options

This section shows you how to:

- Display symbols in assembly code.
- Display intermixed C source and assembly code.
- Enable parameter checking in commands and macros.

To display symbols in assembly code

- In the Debugger Options dialog box, click on the Assembly Symbols button to toggle assembly symbol display.

Or:

- Using the command line, enter:

```
Debugger Option Symbolics Assem_symbols
```

Select On or oFF, and press the < **Return**> key.

On Symbols are displayed instead of addresses wherever possible.

oFF Addresses are displayed.

To display intermixed C source and assembly code

- In the Debugger Options dialog box, click on the Intermixed Source/Assembly button to toggle source display.

Or:

- Using the command line, enter:

```
Debugger Option Symbolics Intermixed
```

Select On or oFF, and press the < **Return** > key.

On Assembly code is intermixed with C source code.

oFF Only C source code is displayed.

To enable parameter checking in commands and macros

- In the Debugger Options dialog box, click on the Check Parameters button to toggle parameter checking.

Or:

- Using the command line, enter:

```
Debugger Option Symbolics Check_Args
```

Select On or oFF, and press the < **Return** > key.

Chapter 9: Configuring the Debugger
Setting the Symbolics Options

- On When an assignment is made, the debugger warns you if the assignment contains a C type mismatch.

- oFF The debugger does not perform any argument checking.



Setting the Display Options

This section shows you how to:

- Specify the Breakpoint window display behavior.
- Specify the View window display behavior.
- Display half-bright or inverse video highlights.
- Display information a screen at a time (more).
- Specify the standard I/O window display behavior.
- Specify scroll amount.

To specify the Breakpoint window display behavior

- In the Debugger Options dialog box, hold the *command select* mouse button down on the Breakpoint Window button. Release the button to select On or Swap.

Or:

- Using the command line, enter:

```
Debugger Option View Breakpt_Window
```

Select On or Swap, and press the < **Return**> key.

On The Breakpoint window is displayed at all times.

Swap The Breakpoint window is only displayed when you set or delete a breakpoint or when you display breakpoints.

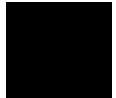

To specify the View window display behavior

- In the Debugger Options dialog box, hold the *command select* mouse button down on the View Window button. Release the button to select On or Swap.

Or:

- Using the command line, enter:

```
Debugger Option View View_Window
```

Select On or Swap, and press the < **Return**> key.

On The View window is displayed at all times.

Swap The View window is only displayed when you activate the View window or when you enter the Debugger Execution Display_Status command breakpoints.

To specify the standard I/O window display behavior

- In the Debugger Options dialog box, hold the *command select* mouse button down on the Stdio Window button. Release the button to select On or Swap.

Or:

- Using the command line, enter:

```
Debugger Option View Stdio_Window
```

Select On, oFF, or Swap; then, press the < **Return**> key.

On The Stdio window is displayed at all times.

oFF	The Stdio window is only displayed when function key F6 is pressed or when the Window Screen_On Stdio command is entered.
Swap	The Stdio window is displayed when a program writes to it and removed when the program returns to the command mode.

To display half-bright or inverse video highlights

- Using the command line, enter:

`Debugger Option View Highlight`

Select Half_Bright or Inverse, and press the < **Return**> key.

This setting does not affect the graphical user interface.

To turn display paging on or off (more)

- In the Debugger Options dialog box, hold the *command select* mouse button down on the More List Mode button. Release the button to select On or Off.

Or:

- Using the command line, enter:

`Debugger Option View More`

Select On or oFF, and press the < **Return**> key.

On Information is listed one screen at a time.



oFF Information is listed all at once.

To specify scroll amount

- Using the command line, enter:

```
Debugger Option View Amt_Scroll <numb 0..50>
```

Enter the number of lines for information to be scrolled (from 0 to 50), and press the < **Return**> key.

To store timing information when tracing

- In the Debugger Options dialog box, select a Trace Counts option.

Or:

- Using the command line, enter:

```
Debugger Option Trace Count
```

Select Time or Nothing and press < **Return**> .

Time Use half of trace memory to store timing information.

Nothing Use all of trace memory to store bus states.

The debugger trace display does not display timing information, but it may be viewed in the emulator/analyzer interface.

To mask fetches while tracing

- In the Debugger Options dialog box, select a Fetch Mask option.

Or:

- Using the command line, enter:

```
Debugger Option Trace Fetch_Align
```

Select Byte, Word, or Long and press < **Return** > .

Fetch addresses will be masked to the selected boundary size.

This feature is useful when a processor has a larger data bus size than its instruction fetch size. For instance, the 68020 has a 32-bit data bus, but instructions may be located at 16-bit boundaries. In this case, set the alignment to Long. For example, an instruction starting at address 0x402 will be fetched by a bus access at 0x400. Unless fetch addresses are masked to Long, the fetch of the instruction at 0x402 would not be seen.

This mask only applies to trace triggers specified with a status cycle type of fetch such as those specified by the pop-up menu in the Code window.



Modifying Display Area Windows

You can reformat display-area screens by modifying their windows. For example, you can reformat the high-level screen by resizing and moving the high-level Code, Monitor, Backtrace, Journal, and Breakpoint windows. You can also resize and move the alternate view of these windows.

This section shows you how to:

- Resize or move the active window.
- Move the Status window (standard interface only).
- Define user screens and windows.
- Display user-defined screens.
- Erase standard I/O and user-defined window contents.
- Remove user-defined screens and windows.

To resize or move the active window

- 1 Using the command line, enter:

```
Window Resize
```

And press the < **Return** > key.

- 2 Type **T** to position the top-left corner, **B** to position the lower-right corner, or **M** to move the window without resizing it; then, use the cursor keys to move the window or window border. When the window is at the desired location, press the < **Return** > key to save the new coordinates.

If you make a mistake while resizing the window, press **CTRL C** or press **Esc** twice to restore the previous coordinates.

The Window Resize command is used to move or alter the size of any existing window, except for the Status window. Use the Window New command to move the Status window in the standard interface.

When you use the Window Resize command on the normal view of a window, the normal dimensions are modified. When you use the command on the alternate view of a window, the alternate dimensions are modified.

You can enter resize commands when any screen is displayed. However, the debugger does not display commands on the standard I/O screen or on any user-defined screen.

To move the Status window (standard interface only)

The Status window cannot be moved in the graphical interface.

- 1 Using the command line in the standard interface, enter:

Window New

Specify window number 5 to move the high-level Status window (or window number 15 to move the assembly level Status window), select Tab followed by High_Level (or Assembly), enter the new coordinates for the Status window, and press the <Return> key.

The Status window cannot be resized. The difference between the bottom row coordinate and top row coordinate must be 3.

A high-level program must be loaded in order to move the high-level status screen.

Be sure to move any windows that occupy the screen area to which you are moving the Status window. Otherwise, the Status window will be hidden behind these windows.

Examples

To move the high-level Status window to the top of the display (upper left corner at 0,0 and lower right corner at 3,78):

```
Window New 5 <tab> High_Level 0,0,3,78
```

To move the assembly-level Status window to the bottom of the display:

```
Window New 15 <tab> Assembly 19,0,22,78
```

To define user screens and windows

- Using the command line, enter:

```
Window New
```

Enter the window and screen parameters, and press the < **Return** > key.

The debugger lets you define your own screens and windows so that you have flexibility in displaying debugger information.

User-defined windows must be assigned a number greater than or equal to 50, and less than or equal to 256. Numbers below 50 are reserved for predefined debugger screens and windows.

When you make a new window with the Window New command, the normal view and alternate view dimensions are set identically. The debugger allocates a buffer with enough memory to contain the entire window. Therefore, the window with the largest dimensions (normally the alternate view) should be defined first to allocate sufficient memory.

To display a user-defined screen, use the **Window Screen_On** command or press function key **F6**.

Caution

When making a new window on the high-level or assembly-level screens, be careful not to enter coordinates that will result in a window that covers the status line and command line. On a standard 80-column terminal display, a row coordinate may be between 0 and 23. Creating a window with a bottom row coordinate greater than 18 will cause part or all of the status and command lines to be covered.

Examples

To make a user window numbered 57 in user screen 4 with the upper-left corner of the window at coordinates 5,5 and the lower-right corner of the window at coordinates 18,78:

```
Window New 57 <tab> User_Screen 4 <tab> Bounds 5,5,18,78
```

If user screen 4 does not exist, the debugger automatically creates it.

To display user-defined screens

- Using the command line, enter:

```
Window Screen_On User_Screen <screen_nmbr>
```

Enter the user screen number, and press the **<Return>** key.

Examples

To display user screen 4:

```
Window Screen_On User_Screen 4
```

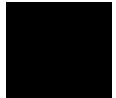

To erase standard I/O and user-defined window contents

- Using the command line, enter:

```
Window Erase <user_window_nmbr>
```

Enter the user window number (the standard I/O window number is 20) whose contents you wish to clear, and press the < **Return** > key.

If you do not specify a window number or if you specify 0, the active user-defined window is cleared. This command is useful in macros.

Examples

To erase the contents of user window 57:

```
Window Erase 57
```

To remove user-defined screens and windows

- Using the command line, enter:

```
Window Delete <user_window_nmbr>
```

Enter the number of the window to be removed, and press the < **Return** > key.

To remove a user-defined screen, remove all windows associated with that screen.

You cannot remove predefined debugger windows and screens.

Examples

To remove a user-defined screen that has three windows (numbers 50, 55, and 73):

```
Window Delete 50
```

Window Delete 55

Window Delete 73



Saving and Loading the Debugger Configuration

Information regarding debugger options and screen configurations can be saved in a *startup file*. Startup files can be created only from within the debugger.

This section shows you how to:

- Save the current debugger configuration.
- Load a startup file.

To save the current debugger configuration

- Use the menu select mouse button to choose **File→Store→Startup (.rc) file (as default)**. The information is saved in file “db68k.rc” in the current directory.

Or:

- Use the menu select mouse button to choose **File→Store→Startup (.rc) file**. Using the file selection dialog box, enter the name of the file to which startup information should be saved; then, click on the OK pushbutton.

Or:

- Using the command line, enter:

```
File Startup <startup_file>
```

Enter the name of the file in which the startup information should be saved, and press the < **Return** > key. If you do not specify the name of the startup file, the default value will be used.

This command also saves the window and screen settings.

When saving window and screen settings that have been customized for a particular type of terminal, name the startup file the same as the TERM environment variable setting. If no startup file is loaded when starting the debugger, the debugger will automatically search for startup files named “./\$TERM.rc” (in the current directory) or “\$HOME/\$TERM.rc” (in the home directory). files.

Examples

To save the current debugger state in a file called “my_state.rc”:

```
File Startup my_state
```

To save, in you home directory, window and screen settings that have been customized for the 2392, 2392a, 2392A, hp2392, hp2392a, or hp2392A terminal types:

```
File Startup ~/.2392
```

To load a startup file

- Use the `-s startup_file` option to the `db68k` command when starting the debugger.

```
$ db68k -e <emulator_id> -s <startup_file> <RETURN>
```

The debugger’s startup options and window specifications are configured as described in *startup_file*.

The *startup_file* must end with the `.rc` extension and can be created only from within the debugger.

If no startup file is named, the following files are searched for in order. The first one that exists will be used (`$HOME` and `$TERM` are UNIX environment variables).

```
db68k.rc in the current directory  
./$TERM.rc in the current directory  
$HOME/.$TERM.rc
```

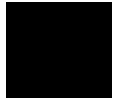

Chapter 9: Configuring the Debugger

Saving and Loading the Debugger Configuration

If no startup file is found, reasonable defaults will be used.

Examples

To start the debugger and load the state saved in the startup file “my_state.rc”:

```
$ db68k -e em68040 -s my_state.rc <RETURN>
```

Setting X Resources

The debugger's graphical interface is an X Window System application which means it is a *client* in the X Window System client-server model.

The X server is a program that controls all access to input devices (typically a mouse and a keyboard) and all output devices (typically a display screen). It is an interface between application programs you run on your system and the system input and output devices.

An *X resource* controls an element of appearance or behavior in an X application. For example, one resource controls the text in action key pushbuttons as well as the action performed when the pushbutton is clicked.

By modifying resource settings, you can change the appearance or behavior of certain elements in the graphical interface.

Where resources are defined

When the graphical interface starts up, it reads resource specifications from a set of configuration files. Resources specifications in later files override those in earlier files. Files are read in the following order:

- 1 The application defaults file. For example, `/usr/lib/X11/app-defaults/HP64_Debug` in HP-UX or `/usr/openwin/lib/X11/app-defaults/HP64_Debug` in SunOS.
- 2 The `$XAPPLRESDIR/HP64_Debug` file. (The `XAPPLRESDIR` environment variable defines a directory containing system-wide custom application defaults.)
- 3 The server's `RESOURCE_MANAGER` property. (The `xrdb` command loads user-defined resource specifications into the `RESOURCE_MANAGER` property.)

If no `RESOURCE_MANAGER` property exists, user defined resource settings are read from the `$HOME/.Xdefaults` file.

- 4 The file named by the `XENVIRONMENT` environment variable.

If the `XENVIRONMENT` variable is not set, the `$HOME/.Xdefaults-host` file (typically containing resource specifications for a specific remote host) is read.

Chapter 9: Configuring the Debugger

Setting X Resources

- 5 Resource specifications included in the command line with the **-xrm** option.
- 6 System scheme files in directory `/usr/hp64000/lib/X11/HP64_schemes`.
- 7 System-wide custom scheme files located in directory `$XAPPLRESDIR/HP64_schemes`.
- 8 User-defined scheme files located in directory `$HOME/.HP64_schemes` (note the dot in the directory name).

Scheme files group resource specifications for different displays, computing environments, and languages.

The `HP64_Debug` application defaults file is re-created each time debugger's graphical interface software is installed or updated. You can use the UNIX **diff** command to check for differences between the new `HP64_Debug` application defaults file and the old application defaults file that is saved as `/usr/hp64000/lib/X11/HP64_schemes/old/HP64_Debug`.

Refer to the "X Resources and the Graphical Interface" chapter for more detailed information about X resources.

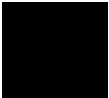

To modify the debugger's graphical interface resources

You can customize the appearance of an X Windows application by modifying its X resources. The following tables describe some of the commonly modified application resources.

Application Resources for Schemes		
Resource	Values	Description
HP64_Debug.platformScheme	HP-UX SunOS (custom)	Names the subdirectory for platform specific schemes. This resource should be set to the platform on which the X server is running (and displaying the debugger's graphical interface) if it is different than the platform where the application is running.
HP64_Debug.colorScheme	BW Color (custom)	Names the color scheme file.
HP64_Debug.sizeScheme	Small Large (custom)	Names the size scheme file which defines the fonts and the spacing used.
HP64_Debug.labelScheme	Label \$LANG (custom)	Names to use for labels and button text. The default uses the \$LANG environment variable if it is set and if a scheme file named Debug.\$LANG exists in one of the directories searched for scheme files; otherwise, the default is Label.
HP64_Debug.inputScheme	Input (custom)	Specifies mouse and keyboard operation.

Chapter 9: Configuring the Debugger
Setting X Resources

Commonly Modified Application Resources		
Resource	Values	Description
HP64_Debug.enableCmdline	True False	Specifies whether the command line area is displayed when you initially enter the debugger's graphical interface.
*editFile	(example) vi % s	Specifies the command used to edit files.
*editFileLine	(example) vi + % d % s	Specifies the command used to edit a file at a certain line number.
*m68040*actionKeysSub.keyDefs	(paired list of strings)	Specifies the text that should appear on the action key pushbuttons and the commands that should be executed in the command line area when the action key is pushed. Refer to the "To set up custom action keys" section for more information.
*m68040*dirSelectSub.entries	(list of strings)	Specifies the initial values that are placed in the File → Context → Directory pop-up recall buffer. Refer to the "To set initial recall buffer values" section for more information.
*m68040*recallEntrySub.entries	(list of strings)	Specifies the initial values that are placed in the entry buffer (labeled "():"). Refer to the "To set initial recall buffer values" section for more information.

The following steps show you how to modify the debugger's graphical interface's X resources.

- 1 Copy part or all of the HP64_Debug application defaults file to a temporary file.

If you are using an HP-UX computer, type:

```
cp /usr/lib/X11/app-defaults/HP64_Debug HP64_Debug.tmp
```

If you are using SunOS, type:

```
cp /usr/openwin/lib/X11/app-defaults/HP64_Debug HP64_Debug.tmp
```

- 2 Make the temporary file writable:

```
chmod +w HP64_Debug.tmp
```

- 3 Modify the temporary file.

Modify the resource that defines the behavior or appearance that you wish to change.

For example, to change the number of lines in the main display area to 36, search for the string "HP64_Debug.lines". You should see lines similar to the following.

```
!-----  
! The lines and columns set the vertical and horizontal dimensions of the  
! main display area in characters, respectively. Minimum values are 18 lines  
! and 80 columns. These minimums are silently enforced.  
!  
! Note: The application cannot be resized by using the window manager.  
  
!HP64_Debug.lines:      24  
!HP64_Debug.columns:   85
```

Edit the line containing "HP64_Debug.lines" so that it is uncommented and is set to the new value:

```
!-----  
! The lines and columns set the vertical and horizontal dimensions of the  
! main display area in characters, respectively. Minimum values are 18 lines  
! and 80 columns. These minimums are silently enforced.  
!  
! Note: The application cannot be resized by using the window manager.  
  
HP64_Debug.lines:      36  
!HP64_Debug.columns:   85
```



Chapter 9: Configuring the Debugger

Setting X Resources

If you wish, you may delete any lines which you will not be modifying; any resources you delete will use the default values.

Save your changes and exit the editor.

- 4 If the `RESOURCE_MANAGER` property exists (as is the case with HP VUE — if you're not sure, you can check by entering the `xrdb -query` command), use the `xrdb` command to add the resources to the `RESOURCE_MANAGER` property. For example:

```
xrdb -merge -nocpp HP64_Debug.tmp
```

- 5 Save the changes where they can be found by the debugger.

One way to do this is to append the temporary file to your `$HOME/.Xdefaults` file. For example:

```
cat HP64_Debug.tmp >> $HOME/.Xdefaults
```

You can also save the changes in a scheme file (see "To use customized scheme files").

- 6 Remove the temporary file.
- 7 Start or restart the debugger's graphical interface.

To use customized scheme files

Scheme files are used to set platform specific resources that deal with color, fonts and sizes, mouse and keyboard operation, and labels and titles. You can create and use customized scheme files by following these steps.

- 1 Create the `$HOME/.HP64_schemes/< platform>` directory.

For example:

```
mkdir $HOME/.HP64_schemes
mkdir $HOME/.HP64_schemes/HP-UX
```

- 2 Copy the scheme file to be modified to the `$HOME/.HP64_schemes/< platform>` directory.

Label scheme files are not platform specific; therefore, they should be placed in the `$HOME/.HP64_schemes` directory. All other scheme files should be placed in the `$HOME/.HP64_schemes/< platform>` directory.

For example:

```
cp /usr/hp64000/lib/X11/HP64_schemes/HP-UX/Debug.Color
   $HOME/.HP64_schemes/HP-UX/Debug.MyColor
```

Note that if your custom scheme file has the same name as the default scheme file, the load order requires resources in the custom file to explicitly override resources in the default file.

- 3 Modify the `$HOME/.HP64_schemes/< platform> /Debug.< scheme>` file.

For example, you could modify the “`$HOME/.HP64_schemes/HP-UX/Debug.MyColor`” file to change the defined foreground and background colors. Also, since the scheme file name is different than the default, you could comment out various resource settings to cause general foreground and background color definitions to apply to the debugger’s graphical interface. At least one resource must be defined in your color scheme file for it to be recognized.

Chapter 9: Configuring the Debugger

Setting X Resources

- 4 If your custom scheme file has a different name than the default, modify the scheme resource definitions.

The debugger's graphical interface application defaults file contains resources that specify which scheme files are used. If your custom scheme files are named differently than the default scheme files, you must modify these resource settings so that your customized scheme files are used instead of the default scheme files.

For example, to use the “\$HOME/.HP64_schemes/HP-UX/Debug.MyColor” color scheme file you would set the “HP64_Debug.colorScheme” resource to “MyColor”:

```
HP64_Debug.colorScheme: MyColor
```

To set up custom action keys

- Modify the “actionKeysSub.keyDefs” resource.

To modify this resource, follow the procedure in “To modify the debugger’s graphical interface resources.”

The “actionKeysSub.keyDefs” resource defines a list of paired strings. The first string defines the text that should appear on the action key pushbutton. The second string defines the command that should be sent to the command line area and executed when the action key is pushed.

A pair of parentheses (with no spaces, that is “()”) can be used in the command definition to indicate that text from the entry buffer should replace the parentheses when the command is executed.

Action keys that use the entry buffer should always include the entry buffer symbol, “()”, in the action key label as a visual cue to remind you to place information in the entry buffer before clicking the action key.

Shell commands can be executed by using the Debugger Host_Shell command.

Also, command files can be executed by using the File Command command.

Finally, an empty action (“”) means to repeat the previous operation, whether it came from a pull-down, a dialog, a pop-up, or another action key.

Example

To set up custom action keys, modify the “debug*actionKeysSub.keyDefs” resource:

```
*m68040*actionKeysSub.keyDefs: \  
"Make"           "D H make      I" \  
"Disp Src ()"    "P C S () ;; P D ()" \  
"Run Until ( )"  "P R U ()" \  
"Step"           "P S"
```

See Also

“To modify debugger’s graphical interface resources” in this chapter.

To set initial recall buffer values

- Modify the “entries” resource for the particular recall buffer.

Some of the resources for the pop-up recall buffers are listed in the following table:

Pop-up Recall Buffer Resources	
Recall Pop-up	Resources
Entry Buffer ():	*recallEntrySub.entries
File → Context → Directory ...	*dirSelectSub.entries
Modify → Register; Recall Value	*modRegDB*recallSub.entries
Command Line command recall	*recallCmdSub.entries
Macro Operations dialog box; Recall Value	*macroDB_popup*recallSub.entries

Other X resources for the recall buffers are described in the supplied application defaults file.

The window manager resource “*transientDecoration” controls the borders around dialog box windows. The most natural setting for this resource is “title.”

Example

To set the initial values for the directory selection dialog box, modify the “debug*dirSelectSub.entries” resource:

```
*m68040*dirSelectSub.entries: \  
  "$HOME" \  
  "." \  
  "/users/project1" \  
  "/users/project2/code"
```

Refer to the previous “To modify the debugger’s graphical interface resources” section in this chapter for more detailed information on modifying resources.

10

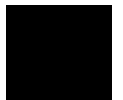

Configuring the Emulator

How to configure the emulator for your target system.

This chapter describes how to configure the emulator. You must map memory whenever you use the emulator. When you plug the emulator into a target system, you must configure the emulator so that it operates correctly in the target system. The configuration tasks are grouped into the following sections:

- Using the configuration interface.
- Setting up the emulation monitor.
- Mapping memory.
- Modifying the general configuration items.
- Selecting analyzer trace options.
- Configuring simulated I/O.
- Specifying connections for interactive measurements.

The simulated I/O feature and configuration questions are described in the *Simulated I/O User's Guide*.

The interactive measurement configuration options are described in this chapter, and additional information is given in the "Making Coordinated Measurements" chapter.

Using the Configuration Interface

This section shows you how to set up, modify, and store emulation configurations using the emulator configuration interface.

This section shows you how to:

- Start the configuration interface.
- Modify a configuration section.
- Apply configuration changes to the emulator.
- Store configuration changes to a file.
- Change the configuration directory context.
- Display the configuration context.
- Access help topics.
- Access context sensitive (f1) help.
- Exit the configuration interface.

This section describes the emulator configuration in general. The remaining sections in this chapter describe the specific configuration options for your emulator.

When you have developed an emulation configuration, saved it to a file, and closed the configuration interface, you can use the **File→Load→Emulator Config...** command and associated dialog box in the debugger interface to load the configuration file into your emulator.

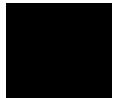

To start the configuration interface

- Choose **Modify→Emulator Config...** from the debugger interface pulldown menu.
- Using the command line, enter the **modify configuration** command.

The configuration interface top-level dialog box (see the following example) is displayed.

The configuration sections that are presented depend on the hardware and the features of your particular emulator.

The configuration interface may be left running while you are using the debugger and emulator/analyzer interfaces.

If you're using the standard interface from a terminal or terminal emulation window, you don't get a dialog box from which to choose configuration sections; however, you have access to the same configuration options through a series of configuration questions.

Examples

The 68040 emulator configuration interface top-level dialog box is shown below.

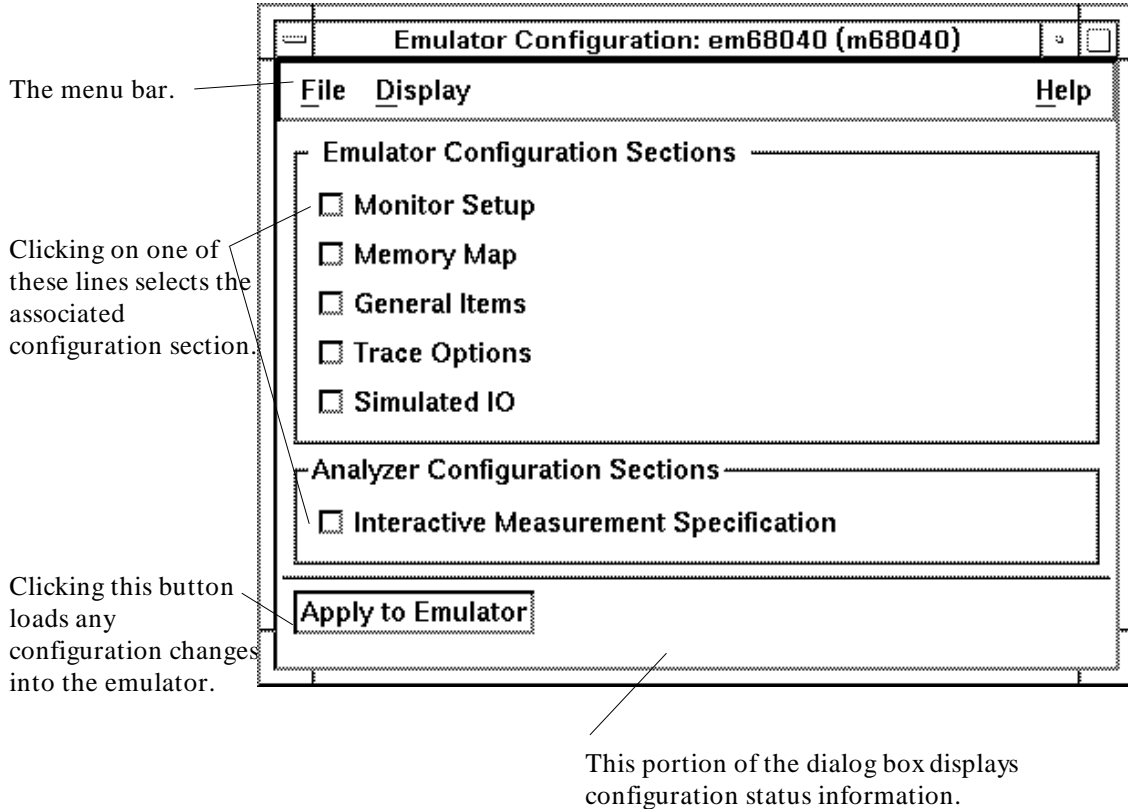

To modify a configuration section

- 1 Start the emulator configuration interface.
- 2 Click on a section name in the configuration interface top-level dialog box.
- 3 Use the section dialog box to make changes to the configuration.

If you are using the standard interface:

The configuration questions in the "Monitor Setup" section are the first to be asked.

To access the memory map and define, modify, or delete map entries in the "Memory Map" section, answer "yes" to the "Modify memory configuration?" question.

To access the questions in the "General Items" section, answer "yes" to the "Modify emulator pod configuration?" question.

To access the questions in the "Trace Options" section, answer "yes" to the "Modify debug/trace options?" question.

To access the questions in the "Simulated IO" section, answer "yes" to the "Modify simulated I/O configuration?" question.

To access the questions in the "Interactive Measurement Specification" under the "Analyzer Configuration" section, answer "yes" to the "Modify interactive measurement specification?" question.

Most configuration sections provide dialog boxes similar to the following.

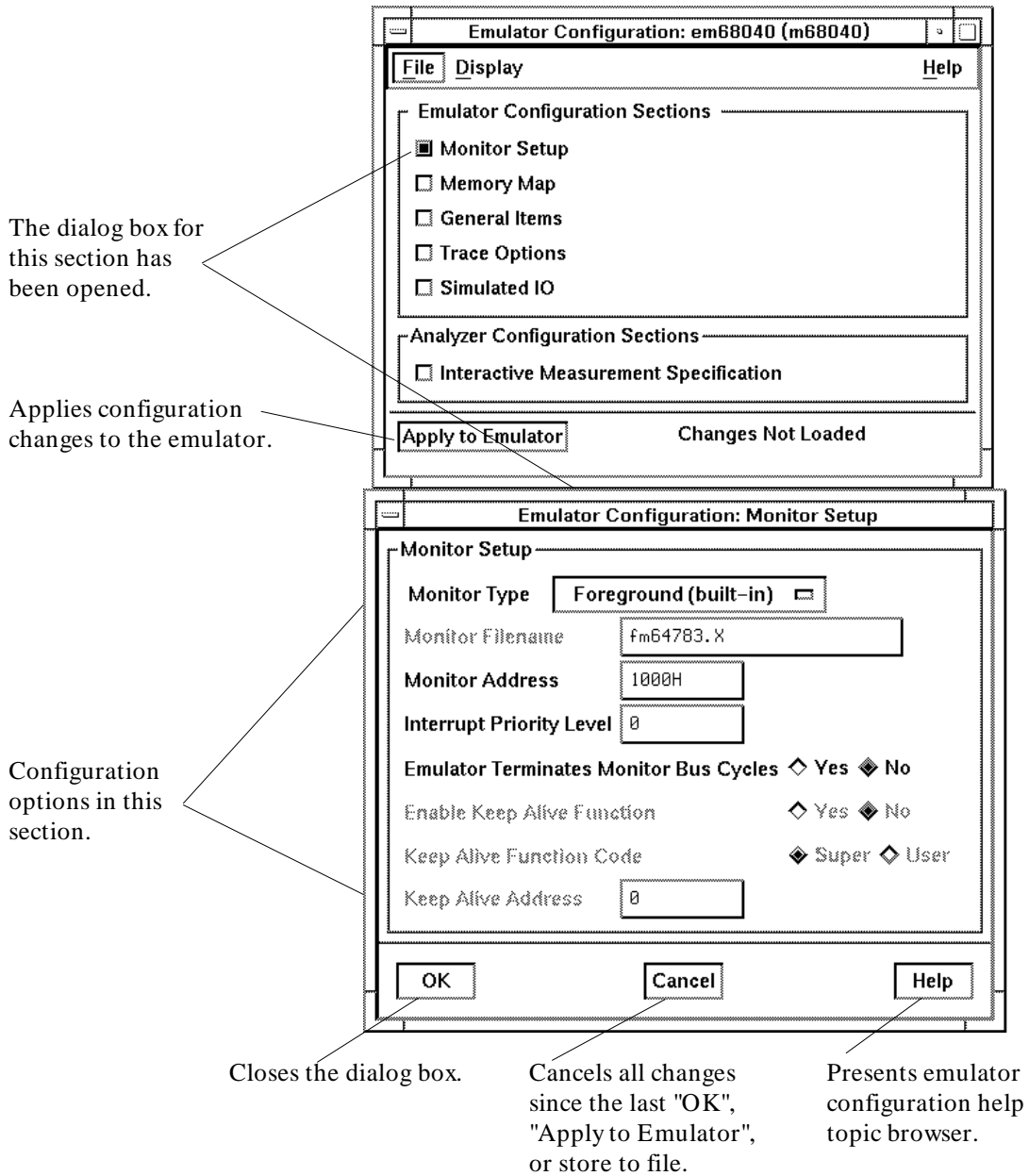

As soon as you change a configuration option, the change is recorded (as seen by the "Changes Not Loaded" message in the top level dialog box).

To apply configuration changes to the emulator

- Click the "Apply to Emulator" button in the top-level dialog box.

This loads the configuration changes into the emulator. Status text to the right shows whether or not the load was successful.

You can apply configuration changes to the emulator at any time (even while several of the configuration dialog boxes are open). This lets you verify changes without closing dialog boxes for the configuration sections.

The "Apply to Emulator" button does not create a file to store configuration changes. To do that, choose the **File→Store...** pulldown in the top level interface window, described later.

If you exit the configuration interface with configuration changes that have not been stored, you will be asked whether you want to store the changes, exit without storing, or cancel the exit.

To store configuration changes to a file

- Choose **File→Store...** from the pulldown menu in the top-level configuration interface window, and use the file selection dialog box to name the configuration file.
- If you're using the standard interface, the last configuration question, "Configuration file name?", lets you name the file to which configuration information is stored. If you don't enter a name, configuration information is saved to a temporary file (which is deleted when you exit the interface and release the emulation system).

When modifying a configuration using the graphical user interface, you can store your answers at any time.

Configuration information is saved in a file with an extension of ".EA". The debugger will compile the ".EA" file into a binary ".EB" file.

When using the Graphical User Interface, do not try to modify the ".EA" file. It may not load correctly after modification. Instead, start the configuration interface, make desired modifications, and store the configuration file.

To change the configuration directory context

- Choose **File→Directory...** from the pulldown menu in the top-level configuration interface window, and use the directory selection dialog box to specify the new directory.

The directory context specifies the directory to which configuration files are stored and from which they are loaded.

To display the configuration context

- Choose **Display**→**Context...** from the pulldown menu in the top-level configuration interface window.

The current directory context and the current configuration files are displayed in a window. Click the "Done" pushbutton when you wish to close the window.

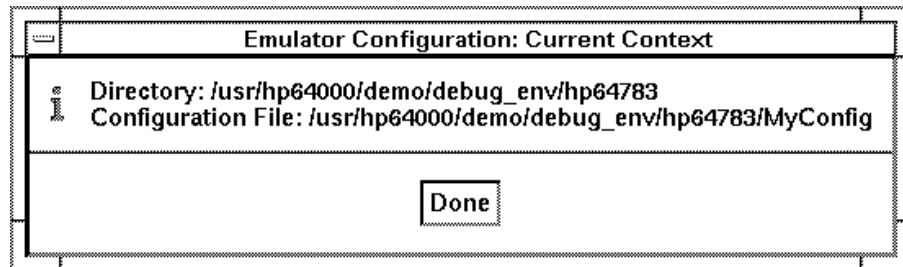

To access help topics

- Choose **Help**→**General Topic...** from the pulldown menu in the top-level configuration interface window, click on a topic in the selection dialog box, and click the "OK" button.

To access context sensitive (f1) help

- Place the mouse pointer over the item for which you want help, and press the f1 keyboard key.
- Choose **Help→On Item...** from the pulldown menu in the top-level configuration interface window. Notice that the mouse pointer changes to a question mark. Move the question mark over the item for which you want help in the top-level configuration interface window, and click the *select* mouse button.

If you are having trouble using the f1 key to obtain help, you may be able to use the question mark obtained by the **Help→On Item...** pulldown. If the **Help→On Item...** pulldown does not obtain the desired result, try the f1 key. The operation of these two selections differs on different platforms.

In some dialog boxes, the question mark obtained by the **Help→On Item...** pulldown may not obtain a help screen when you place it on a command name, but the help screen may be obtained when you place the question mark over an input field or button associated with the command name.

To exit the configuration interface

- Choose **File→Exit** from the pulldown menu in the top-level configuration interface window (or type < CTRL> x).

This will close the top-level configuration interface window together with all of the children of the top-level configuration interface window.

If configuration changes have not been stored to a file, a confirmation dialog box appears, giving you the options of: storing, exiting without storing, or canceling the exit.

To load a configuration

- In the debugger interface, choose **File**→**Load**→**Emulator Config...** from the pulldown menu, and use the file selection dialog box to specify the configuration file to be loaded.
- Using the command line, enter the **load configuration < FILE>** command.

This command loads previously created and stored configuration files. You cannot load a configuration while the configuration interface is running.

Modifying the Monitor Setup

In order to modify the monitor setup, you must obtain the top-level Emulator Configuration dialog box. Simply click on the Monitor Setup button. The Monitor setup dialog box will appear.

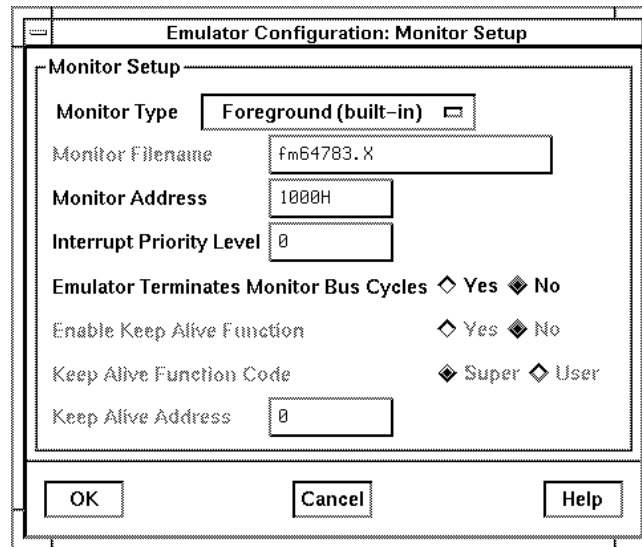

This section shows you how to:

- Select the monitor type.
- Select the monitor filename.
- Select the monitor address.
- Select the monitor interrupt priority level.
- Select whether or not the emulator will terminate monitor bus cycles without regard to the state of the target system.
- Select whether or not there will be a keep-alive function, and if there will be a keep-alive function, select its address and function code, if desired.

To select the monitor type

- Choose "Background", "Foreground (built-in)", "Foreground (customized)", or "None" for the "Monitor Type" configuration option.

Choosing "Background" specifies that the background monitor will be used with the emulator. The background monitor is useful when you are first plugging into a target system. It occupies no address space that might be used by your target program. You cannot enable the MMU, use the processor caches, or perform dma cycles when the background monitor is in use, or when your system is arbitrating the bus. Also, when one of the routines of the background monitor is executing, the emulator cannot service any target system interrupts, even NMI interrupts.

Choosing "Foreground (built-in)" specifies that the foreground monitor shipped with your emulator will be used. A foreground monitor must be used when the memory management unit and/or the caches of the MC68040 are enabled or bus arbitration is performed. Also, the emulator can be configured to service target system interrupts of any desired level during execution of foreground monitor routines.

Choosing "Foreground (customized)" specifies that a custom foreground monitor will be used. With this selection, you will need to specify the Monitor Filename in this dialog box.

Choosing "None" specifies that no monitor will be used. This option is useful when you are first connecting the emulator to a target system. Sometimes the task of connecting an emulator to a target system can be complicated by characteristics of the emulation monitor. For example, foreground monitor bus cycles are visible to the target system. By selecting "None", you eliminate the question "am I having trouble connecting to my target system because of something the monitor is doing?"

When you choose "None", you will be able to run the emulator from reset, and you will be able to take a trace with the analyzer to see what activity is being executed by your emulator. You will not be able to use any of the other emulator capabilities and features. When your system is running successfully with the "None" selection, then select one of the other monitor options to see if your target system will operate with the emulation monitor.

To select the monitor filename

- Type in the name of the custom foreground monitor in the text entry area beside "Monitor Filename".

The custom foreground monitor absolute file will be automatically loaded after configuration is complete. The monitor must already be linked to the desired location and should not be linked with any of your target programs.

The location for the monitor source file is: **/usr/hp64000/monitor/fm64783.s**.

The file format for the monitor **MUST** be HP64000 absolute format (file.X).

If using the HP 68030/68040 assembler/linker (B1465), use the -h option.

If using Microtec Research, Inc. assembler/linkers, use the -h option.

For other language systems, use the "HP 64000 Hosted Development System Absolute File Translator" program.

No symbols are required for loading the custom foreground monitor.

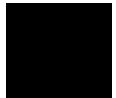

To select the monitor address

- Type the base address of the foreground monitor in the text entry field beside "Monitor Address" in the dialog box.

Enter a hexadecimal address on a 4-Kbyte boundary (XXXXX000h).

If you are using a foreground monitor (either the built-in foreground monitor or a custom foreground monitor), you must set the base address where the monitor will be loaded.

The emulator loads the foreground monitor into the 4-Kbyte block of dual-port emulation memory. It resets the memory map, and creates a map term at the address you enter in this dialog box. You cannot delete or alter this map term by using the map configuration commands. Instead, you must change the monitor configuration using this Monitor Setup dialog box.

If the memory management feature of the MC68040 emulator is enabled, be sure the foreground monitor is mapped 1:1, and it is not write protected. Refer to the end of this chapter for instructions on how to map the foreground monitor to 1:1 address space.

To select the monitor interrupt priority level

- Type in the desired interrupt priority level for your foreground monitor in the text entry area beside "Interrupt Priority Level".

Enter a number from 0 to 7 in the text entry area. This is the interrupt priority level that will be held off by the emulation monitor during monitor execution. Interrupts having values higher than the number you enter here will be recognized by the processor.

Set the interrupt priority level low enough to allow your target system to function correctly, but high enough to avoid excessive interrupt processing. The default value of 0 allows all target system interrupts to be recognized by the foreground monitor.

The emulator uses a level 7, non-maskable interrupt to interrupt the target system and break into the monitor. When the foreground monitor is not executing critical code (such as monitor entry and exit), the foreground monitor will set the interrupt priority mask to the value you enter beside "Interrupt Priority Level", or to the interrupt level that was in effect before monitor entry, whichever is greater.

Example

Suppose your target system has a disk device driver that uses interrupt level 5, and the service routine must be run to prevent target system damage. To allow interrupts of higher priority than level 4 to be serviced during foreground monitor execution, enter 4 beside "Interrupt Priority Level". In this case, all interrupts with values of 4 or less will be ignored when the foreground monitor is executing.

To select whether or not the emulator will terminate monitor bus cycles

- Choose "Yes" or "No" for the "Emulator Terminates Monitor Bus Cycles" configuration option.

Choosing "Yes" specifies that the emulator will terminate foreground monitor cycles using emulator-generated cycle termination signals. Cycle termination signals generated by the target system during access to the foreground monitor, including TEA, will be ignored.

Choosing "No" specifies that foreground monitor cycles will be terminated when the target system TA and/or TEA signals are asserted.

This configuration item only applies to the map term assigned to the foreground emulation monitor. If you choose "No", and the emulation monitor is in an address range where the target system does not return TA or TEA, the emulator will stop. If this happens, reset the emulation processor, and then choose "Yes" for this configuration option.

Foreground monitor bus cycles are visible to the target system. If you choose "Yes", your target system may operate erratically if it is not prepared for the emulation monitor bus cycles.

To select if there will be a keep-alive function, its address, and function code

- Choose "Yes" or "No" for the "Enable Keep Alive Function" configuration option (available for use with the background monitor).

Choosing "Yes" specifies that a selected address will be read by the background monitor periodically. You must also specify the address to be read, and the function code used when reading that address, as follows:

- Choose "Super" or "User" for the "Keep Alive Function Code" configuration option. This determines whether the supervisor function code or the user function code will be used when the emulator reads the keep-alive address.
- Type in the keep-alive address in the text entry area beside "Keep Alive Address". This address in target memory will be read periodically during background monitor execution. The read accesses to the target memory address can be used to avoid a timeout of a target system bus or a watchdog timer during background monitor execution.

Choosing "No" specifies that there will be no keep-alive memory read cycles in target memory during background monitor operation.

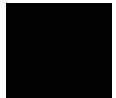

Mapping Memory

Because the emulator can use target system memory or emulation memory (or both), you must map the available ranges of memory so that the emulator knows where to direct its accesses.

All memory ranges used by your programs must be specified in the memory map before you load programs into memory.

Up to eight ranges of memory can be mapped, and the resolution of mapped ranges is 256 bytes, that is, the memory ranges must begin on 256-byte boundaries (numbers ending in 00h) and must end on 256-byte boundaries (numbers ending in FFh).

Emulation memory is made available to the mapper in 256-byte blocks. When you map an address range to emulation memory, at least one 256-byte block is assigned to the range. When a block of emulation memory is assigned to a range, it is no longer available, even though part of the block may be unused.

In order to map memory, you must first start the configuration interface and access the "Memory Map" configuration section (refer to the previous "Using the Configuration Interface" section).

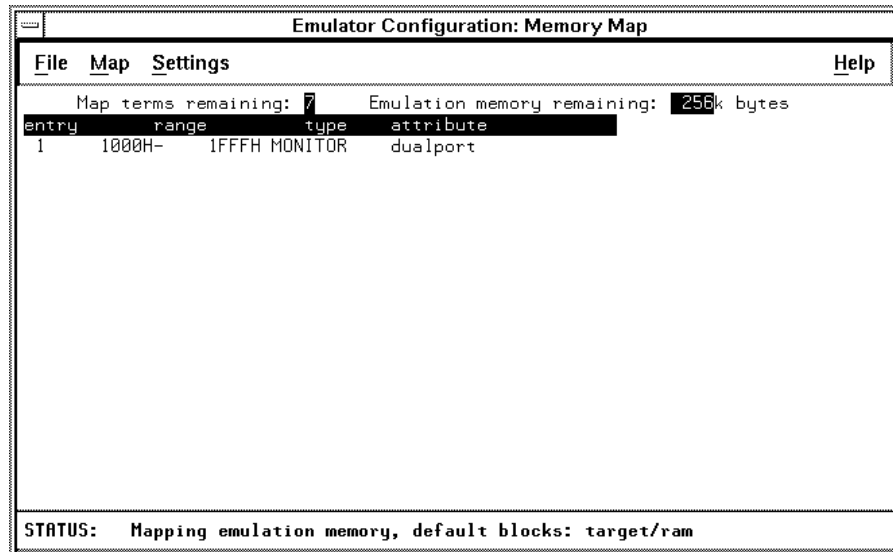

This section shows you how to:

- Add memory map entries.
- Modify memory map entries.
- Delete memory map entries.
- Characterize mapped and unmapped ranges.
- Specify whether or not read data will be inhibited from being loaded into the caches during transactions in the associated memory range.
- Map memory ranges in which the emulator will terminate bus cycles without regard to the state of the target system.
- Map memory ranges to be stored within the dual port memory.

To add memory map entries

- Choose **Map**→**Add New Entry** from the pulldown menu in the memory map window.
- Press and hold the *select* mouse button and choose **Add New Entry** from the popup menu.
- Using the command line, enter the address range, memory type, and possibly an **emulator_terminates_bus_cycles** and/or **transfer_cache_inhibit** attribute for each emulation memory range.

You can characterize memory ranges as emulation RAM, emulation ROM, target system RAM, target system ROM, or as guarded memory.

Guarded memory accesses will cause emulator execution to break into the monitor program.

Writes to locations characterized as ROM will cause emulator execution to break into the monitor program if you choose "Yes" for the "Break processor on Write to ROM" option in the "Emulator Configuration: General Items" dialog box.

RAM memory in the emulation or target system will be changed by processor writes, even if that memory has been characterized as ROM.

You can include the transfer cache inhibit attribute with any memory range. If included, no data will be loaded into either the instruction cache or data cache during any transactions occurring in the associated memory range. This ensures that all activity will appear on the emulation bus and be available for tracing with the emulation-bus analyzer.

You can include the "Emulator Terminates Bus Cycles" attribute with any memory range. If included, the emulator will terminate bus cycles without regard to the state of the target system. This is useful in ranges where the \overline{TA} and/or \overline{TEA} signals are not available from the target system. The danger of this option is that the emulator may become out of sync with the target system if the target system supplies these signals.

You can specify that a particular address range be loaded into the dual-port memory if using of a background monitor in the Monitor Setup dialog box.

The first two methods of mapping memory ranges give you the following dialog box.

The starting address of the range to be added.

The ending address of the range to be added.

Specifies the increment value for the "+" and "-" buttons of the start and end address fields.

Specifies type of memory occupied by this range.

Specify if read data is inhibited from being loaded into the caches in this range.

Specify if the emulator terminates bus cycles in this range without waiting for the target system.

Only available when the background monitor is in use.

Adds the defined range to the memory map.

Inactive in the "Add" mode of map entry.

Closes the dialog box.

Subtract or add the address increment value. The end address is changed by the same amount, moving the block of memory.

Change only the end address, thereby changing the size of the block of memory.

Multiply or divide the increment value by 2.

These buttons may be held down to repeat the action.

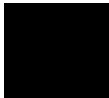

Chapter 10: Configuring the Emulator

Mapping Memory

Examples

Example 1: Suppose you're using the emulator in-circuit, and there is a 12-byte I/O port at 1c000 hex in your target system. You have ROM in your target system from 0 through ffff hex. Also, you want to use the dual-port emulation memory at 20000 hex. You could use the Memory Map dialog box to create the following three map entries:

Start Address **1c000h**, End Address **1c0ffh**, Memory Type **Target RAM**
Start Address **0h**, End Address **0ffffh**, Memory Type **Target ROM**
Start Address **20000h**, End Address **20fffh**, Memory Type **Emul RAM**, Dual Port Memory = **Yes**

Using the command line, you would enter:

```
1c000h thru 1c0ffh target ram
0 thru 0ffffh target rom
20000h thru 20fffh emulation ram dualport
```

Remember that the only way to make the dual-port emulation memory available for your target program is to use the background monitor. When a foreground monitor is in use, it occupies the dual-port emulation memory, by default.

Example 2: This second example shows the relationship between memory ranges and the block sizes of memory. Suppose you have installed 256-Kbyte SRAM memory modules in Memory slots 0 and 1 (called BANK 0 and BANK 1) on the emulation probe. This makes four 64-Kbyte blocks and two 128-Kbyte blocks available to the memory mapper. Then you enter the following map commands:

Start Address **0h**, End Address **7fffh**, Memory Type **Emul RAM**
Start Address **20000h**, End Address **3f000h**, Memory Type **Emul RAM**
Start Address **40000h**, End Address **4ffffh**, Memory Type **Emul RAM**
Start Address **50000h**, End Address **500ffh**, Memory Type **Emul RAM**
Map→Default Memory Type→Target RAM→Transfer Cache Inhibit ON

Using the command line, you would enter:

```
0 thru 7fffh emulation ram
20000h thru 3f000h emulation ram
40000h thru 4ffffh emulation ram
50000h thru 500ffh emulation ram
default target ram transfer_cache_inhibit
```

If you haven't used the dual-port emulation RAM, the first map term that is small enough to fit is assigned to that memory. In this example, that is the last term you defined (the range from 50000..500ff). The entire 4-Kbyte block is reserved though you specified only a 256-byte range. Two 64-Kbyte blocks and one 128-Kbyte block are used from the SRAM emulation memory on the probe, leaving two 64-Kbyte blocks and one 128-Kbyte block. One of the 64-Kbyte blocks is used for the first map term, but 32 Kbytes of that block are unused and unavailable. The third term uses the other 64-Kbyte block. The second term uses part of the 128-Kbyte block, leaving the rest unavailable.

Mapper resolution is independent of block allocation. In the above example, if you had **default guarded** and your program accessed 8000h, the emulator would do a guarded memory break.

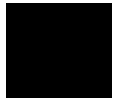

To modify memory map entries

- Choose **Map**→**Modify Entry** from the pulldown menu in the memory map window and select the entry number from the cascade menu.
- Position the mouse pointer over the entry you wish to modify. Press and hold the *select* mouse button, and choose **Modify Entry** from the popup menu.

These commands open the same dialog box that is used for adding memory map entries, except it lets you modify the current settings for the entry.

In order to modify an entry when using the command line, you must delete the entry and add a new entry.

Chapter 10: Configuring the Emulator Mapping Memory

Examples To modify a memory map entry using the popup menu:

Bring up the menu and choose this item to modify the highlighted memory map entry.

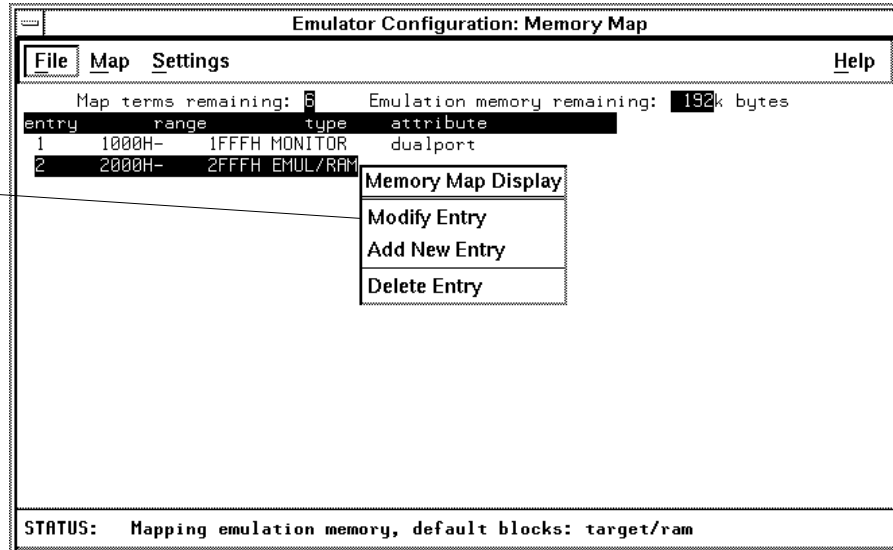

Use the Modify Map Entry dialog box (same as the Add New Map Entry dialog box) to modify the entry. Click the "Modify" button to modify the selected range in the memory map according to changes you make in the Modify Map Entry dialog box.

To delete memory map entries

- Choose **Map**→**Delete Entry** from the pulldown menu in the memory map window and select the entry number from the cascade menu.
- Position the mouse pointer over the entry you wish to delete. Press and hold the *select* mouse button and choose **Delete Entry** from the popup menu.
- Using the command line, enter the **delete < ENTRY# >** command.

Note that programs should be reloaded after deleting map terms. The memory mapper may re-assign blocks of emulation memory after the insertion or deletion of map terms.

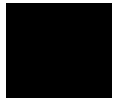

To characterize unmapped ranges

- Choose **Map**→**Default Memory Type** from the pulldown menu in the memory map window and select the memory type from the cascade menu. If you choose **Target RAM** or **Target ROM**, you must also choose **Transfer Cache Inhibit OFF** or **Transfer Cache Inhibit ON**.
 - If you choose **Transfer Cache Inhibit OFF**, transactions that are sent to unmapped memory may also be loaded into the instruction and/or data caches.
 - If you choose **Transfer Cache Inhibit ON**, no data that is sent to unmapped memory will be written into the caches.
- Using the command line, enter the **default < memory_type >** command.

Unmapped memory ranges are treated as target system RAM by default. Unmapped memory ranges cannot be characterized as emulation memory.

To map memory ranges in which data is not loaded into the caches

- Choose "Yes" or "No" for the "Transfer Cache Inhibit" configuration option in the "Modify Map Entry" or "Add New Entry" dialog box.

Choosing "Yes" specifies that no data will be loaded into either the instruction cache or data cache during any transactions occurring in the associated memory range. This choice is useful when you need to have all transactions appear on the external buses to allow the emulation-bus analyzer to capture complete traces of processor activity.

Choosing "No" specifies that data will be loaded into either the instruction cache or data cache, as applicable, during transactions occurring in the associated memory range. This choice is useful when you need to have transactions completed in the fastest and most efficient manner. Use of processor caches increases the processor speed of execution.

To map memory in which the emulator will terminate bus cycles

- Choose "Yes" or "No" for the "Emulator Terminates Bus Cycles" configuration option in the "Modify Map Entry" or "Add New Entry" dialog box.

Choosing "Yes" causes the emulator to terminate bus cycles without regard to the state of the target system. This is useful in ranges where the TA and/or TEA signals from the target system are not available. The danger of including this option is that the emulator may become out of sync with the target system if the target system provides these signals.

Choosing "No" ensures that the timing of cycle termination signals will not cause the emulator and target system to become out of sync. No emulation bus cycle will be terminated until the TA or TEA signal is received from the target system.

To map memory to be stored within the dual-port memory

- Choose "Yes" or "No" for the "Dual Port Memory" configuration option in the "Modify Map Entry" or "Add New Entry" dialog box (available only when using the background monitor).

Choosing "Yes" specifies that the map term must be stored in the 4-Kbyte dual-port emulation memory.

Choosing "No" specifies that the map term must be stored in either emulation memory or target system memory, according to specifications made for its address range in the memory map.

This block can also be mapped by specifying the **dualport** attribute after the map address and memory type specification on the command line.

There is one 4-Kbyte block of dual-port emulation memory on the emulator probe. (Dual-port means the emulation controller can access memory locations without interfering with program execution). If you use a foreground monitor, the monitor will be loaded into this space and you won't be able to map this memory for any other purpose.

If you specify an address range less than 4 Kbytes to be placed in the dual-port memory, all 4 Kbytes of the dual-port memory will be allocated because that is the minimum block size for that memory. If you specify a block size less than 4 Kbytes and the dual-port memory is unmapped, the emulator will use that memory to more closely match the requested address range to the block size.

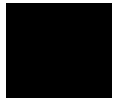

Configuring the Emulator General Items

In order to configure the emulator pod, you must first start the configuration interface and access the "General Items" configuration section (refer to the previous "Using the Configuration Interface" section).

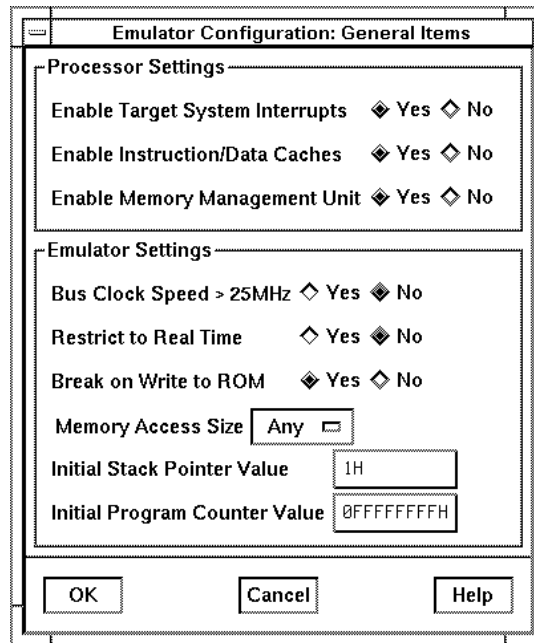

This section shows you how to:

- Configure items that affect operation of the emulation processor, such as:
 - Enable/disable target system interrupts.
 - Enable/disable the instruction and data caches.
 - Enable/disable the memory management unit (MMU).
- Configure items that affect operation of the emulator, such as:
 - Specify whether or not the bus clock speed is greater than 25 MHz.
 - Restrict the emulator to real time runs.

- Break from target program to monitor execution when a write to a ROM address is detected.
- Set the memory access size.
- Set the initial value of the stack pointer.
- Set the initial value of the program counter.

To enable/disable target system interrupts

- Choose "Yes" or "No" for the "Enable Target System Interrupts" configuration option.

Choosing "Yes" allows target system interrupts to be received by the emulation processor. This is useful to test whether your target system interrupt logic works correctly after the interrupt service routines have been designed and the interrupt vectors have been assigned.

Choosing "No" causes all target system interrupts to be ignored by the emulation processor. You may want to disable target system interrupts if your target system interrupt logic doesn't work correctly or isn't finished. Target system interrupts are always ignored during execution of certain critical routines of the foreground monitor, such as monitor entry and monitor exit, and are always ignored in the background monitor.

To enable/disable the instruction and data caches

- Choose "Yes" or "No" for the "Enable Instruction/Data Caches" configuration option.

Choosing "Yes" allows the instruction and data caches to be enabled. With this choice, the caches can still be disabled in selected memory ranges as specified when mapping memory.

Choosing "No" causes the emulator to assert the $\overline{\text{CDIS}}$ signal to prevent instructions and data from being loaded into the respective caches during target program execution. This overrides any specifications you may make for individual entries on the memory map.

When you disable the instruction and data caches, all activity appears on the emulation processor buses where it can be monitored and captured by the emulation-bus analyzer. When you allow the caches to be enabled, program execution is faster, but only partial information is available to be traced by the emulation-bus analyzer. This may cause confusing trace displays or failure to trigger, especially if the code being analyzed is a small loop where all the instructions and operands fit into cache and registers.

When you are more concerned about measuring processor performance, you should enable the caches. If you are making analyzer measurements at the same time, you may need to experiment to find suitable trigger combinations.

If you need to disable caching only for accesses to a specific memory block, enter that as part of your specification when defining the corresponding memory map term. This allows you to capture analysis information for specific memory ranges without dramatically affecting overall system performance.

To enable/disable the memory management unit (MMU)

- Choose "Yes" or "No" for the "Enable Memory Management Unit" configuration option.

Choosing "Yes" allows the MMU of the emulation processor to control placement of the target program in physical memory. The target system will be able to enable and disable the MMU during program execution by using the MDIS signal.

Choosing "No" causes the emulator to disable the MMU of the emulation processor by asserting the MDIS signal.

The MC68040 MMU can manage a program that occupies a large space in logical (virtual) memory while running it from a much smaller space in physical memory. When you operate the emulation processor with the MMU enabled, you must ensure that the foreground monitor is contained in memory space that:

- is not write protected.
- is mapped 1:1 (logical address = physical address). The reason that this mapping is important is that the MMU may be enabled or disabled at any time during program execution; whether or not the MMU is enabled, the emulator must be able to enter the foreground monitor to provide emulation features. Refer to the section titled "Mapping The Foreground Monitor For Use With The MC68040 MMUs" later in this chapter.

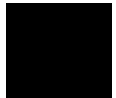

To specify whether the clock speed of the emulation bus is greater than 25 MHz

- Choose "Yes" or "No" for the "Bus Clock Speed > 25MHz" configuration option.

Choosing "Yes" causes the emulator to add one wait state to each synchronous and burst memory access.

Choosing "No" allows all synchronous and burst accesses to be completed at full processor speed with no wait states.

When the external bus clock (BCLK) is operating at a frequency above 25 MHz, this question must be answered "Yes".

To restrict the emulator to real-time runs

- Choose "Yes" or "No" for the "Restrict to Real Time" configuration option.

Choosing "Yes" causes the emulator to offer only a limited set of emulation features: reset, break, run, and step.

Choosing "No" allows the emulator to offer its complete emulation feature set at any time during execution of your target program.

CAUTION

If your target system could be damaged because the emulator is interrupted while running critical routines, choose "Yes" for this configuration option.

The emulator uses the emulation monitor program to implement some features, such as displaying processor registers. When the emulation processor executes a monitor routine, it is not executing your target program. This may cause problems in target systems that need real-time program execution (uninterrupted execution of the target program).

When you choose "Yes" for this configuration item, you must do an execution break in order to display registers or display target memory, and you will not be able to use simulated IO.

While this configuration item affects which commands will be accepted, it does not affect access breakpoints, such as break on write to ROM, break on analyzer trigger, or break on access to guarded memory. It also doesn't affect the emulator's response to execution breakpoints.

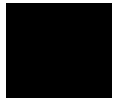

To enable/disable breaks on writes to ROM

- Choose "Yes" or "No" for the "Break on write to ROM" configuration option.

Choosing "Yes" enables breaks on writes to ROM with the following results:

- The emulator will stop executing the target program and begin execution in the emulation monitor whenever the target program attempts to write to a memory region mapped as ROM.
- The emulator will modify the content of RAM memory that is mapped as ROM, even when write to ROM break is enabled.

Choosing "No" disables breaks on writes to ROM. The emulator will continue to execute the target program even when it detects an attempt to write to an address mapped as ROM. Emulation writes will modify the content of RAM memory that has been mapped as ROM.

To specify the memory access size

- Choose "Any", "Bytes", "Words", or "Longs" for the "Memory Access Size" configuration option.

Choose "Any" if you want the emulator to select the optimum access size for the transaction to be completed.

Choose "Bytes" if the emulator should make only 8-bit accesses to memory.

Choose "Words" if the emulator should make only 16-bit accesses to memory.

Choose "Longs" if the emulator should make only 32-bit accesses to memory.

When accessing memory locations, the access mode specifies the type of microprocessor cycles that are used to read or write the value(s). By default, "Any" is selected. In the "Any" mode, long-word accesses are made to memory, except when accessing an address not on a long-word boundary, or when only one byte or one word remains to be accessed. In these cases, the appropriate memory access mode ("Bytes" or "Words") will be used.

If you choose the "Bytes" access mode, and a target system location is modified to contain the value 12345678H, byte instructions will be used to write the byte values 12H, 34H, 56H, and 78H to target system memory.

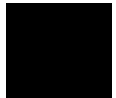

To specify the initial value of the stack pointer

- Type in the address that is the initial value for the interrupt stack pointer in the text entry area beside "Interrupt Stack Pointer Value".

Enter a 32-bit hexadecimal address for the initial value of the ISP. Normally, this value is the same as the value at memory address 0. The default value is 1H. This is an invalid value. It is given as the default to remind you to enter the correct hexadecimal address for the ISP before using the emulator.

Normally, if you run the emulator from reset, the processor fetches the value at offset 0 from the vector table, and loads it into the interrupt stack pointer. There are cases where the interrupt stack pointer cannot be fetched from the reset vector table. For example, if you reset the emulator, break to the emulation monitor, and then run the emulator from the monitor, the stack pointer value will not be read from the normal location. In these cases, the stack pointer value will be read from the value you enter here.

To specify the initial value of the program counter

- Type in the address that is the initial value for the program counter in the text entry area beside "Initial Program Counter Value".

Enter a 32-bit hexadecimal address for the initial value of the program counter. Normally, this value is the same as the value at memory address 4. The default value is 0FFFFFFFH. This is an invalid value. It is given as the default to remind you to enter the correct hexadecimal address for the program counter before using the emulator.

Normally, if you run the emulator from reset, the processor fetches the value at offset 4 from the vector table, and loads it into the program counter. There are cases where the program counter value cannot be fetched from the reset vector table. For example, if you reset the emulator, break to the emulation monitor, and then run the emulator from the monitor, the program counter value will not be read from the normal location. In these cases, the program counter value will be read from the value you enter here.

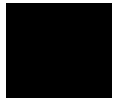

Setting the Trace Options

In order to set the trace options, you must first start the configuration interface and access the "Trace Options" configuration section (refer to the previous "Using the Configuration Interface" section).

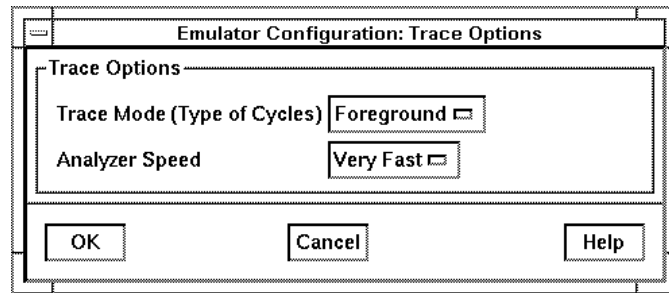

This section shows you how to:

- Enable tracing emulation-bus activity in foreground address space, background address space (tracing execution of the background monitor), or both address spaces. This lets you select whether to include background monitor execution in analyzer traces when using the background monitor.
- Identify the data rate of your emulation system for the emulation-bus analyzer. The capabilities of the analyzer differ with different data rates.

To include/exclude background monitor execution in the trace

- Choose "Foreground", "Background", or "Both" for the "Trace Mode (Type of Cycles)" configuration item.

Choosing "Foreground" specifies that the analyzer trace only foreground cycles, including execution of your target program and of the foreground monitor, if you are using a foreground monitor. In this mode, the analyzer will not trace execution of a background monitor.

Choosing "Background" specifies that the analyzer will trace only background cycles. This is rarely useful because it excludes target program execution.

Choosing "Both" specifies that the analyzer trace both foreground and background cycles. This option allows all emulation processor cycles to be viewed in the trace display when you are using a background monitor.

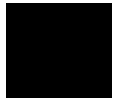

To identify the data rate of your emulation system for the emulation-bus analyzer

- Choose "Slow", "Fast", or "Very Fast" for the "Analyzer Speed" configuration item.

Choosing "Slow" specifies that the burst data rate of the traced activity is not more than 16.67 MHz. The analyzer can perform counts of selected states or counts of time between states when the traced data rate is "Slow".

Choosing "Fast" specifies that the burst data rate of the traced activity is between 16.67 and 20.00 MHz. The analyzer can perform counts of selected states when the traced data rate is "Fast". It cannot perform counts of time between the traced states.

Chapter 10: Configuring the Emulator
Setting the Trace Options

Choosing "Very Fast" specifies that the burst data rate of the traced activity is greater than 20.00 MHz. The analyzer cannot perform any counts when the traced data rate is "Very Fast".

If burst cycles are not being used, set the "Analyzer Speed" to "Slow".

The MC68040 analyzer clock is set to "Very Fast" by default. The analyzer can capture all types of bus cycles correctly up to the maximum clock rate of 40

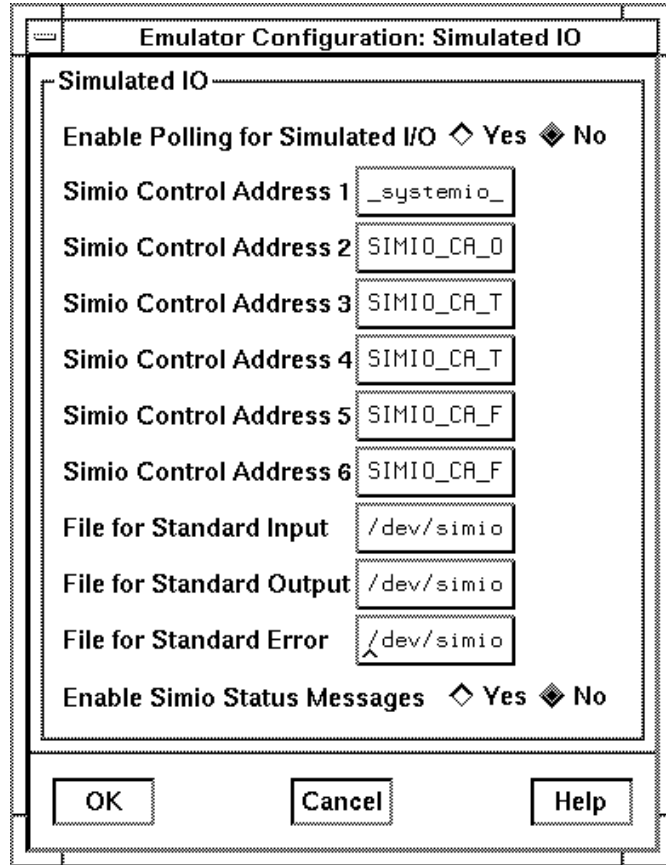

MHz, but cannot correctly count states or time at higher speeds for certain bus cycle types.

The worst-case situation is one where a zero-wait state burst cycle is performed. The analyzer clock rate for burst cycles is given by the equation:

$$\text{Analyzer Clock Rate} = \frac{\text{Processor Clock Rate (BCLK)}}{(1 + \text{number of wait states})}$$

To determine the correct selection, calculate the maximum data rate by using the above equation. Remember that the emulator requires one wait state for all accesses when the external clock is greater than or equal to 25 MHz. Then choose the data rate option according to the data rate.

If no burst cycles are performed, the analyzer clock speed can be set "Slow".

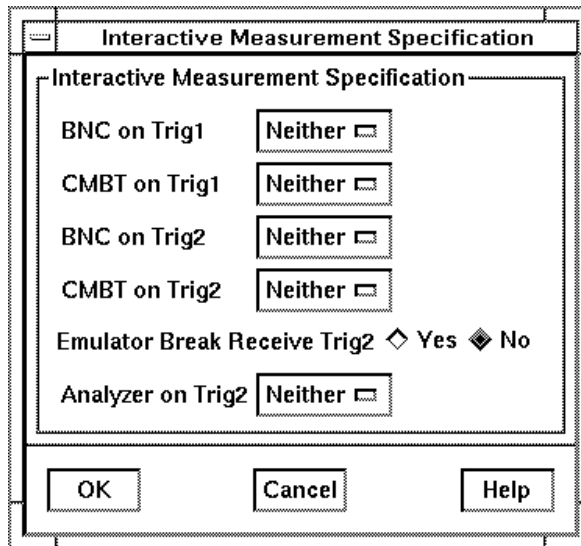

Modifying the Simulated IO Configuration Items

In order to modify the simulated I/O configuration items, you must first start the top-level configuration interface and select the Simulated IO button in the dialog box. The Simulated IO dialog box will appear on screen. Refer to the *Simulated I/O User's Guide* for details on configuring and using simulated I/O.



Modifying the Interactive Measurement Specification Configuration Items

In order to modify the interactive measurement configuration items, you must first start the configuration interface and in the top-level configuration interface dialog box, choose "Interactive Measurement Specification" under "Analyzer Configuration Sections".

This section shows you how to:

- Select whether or not the card cage rear panel BNC is connected to the Trig1 and/or Trig2 signals of the emulation-bus analyzer.
- Select whether or not the coordinated measurement bus connection on the card cage rear panel is connected to the Trig1 and/or Trig2 signals of the emulation-bus analyzer.
- Select whether or not the emulator will allow a signal on Trig2 to initiate an emulation break.
- Select whether or not the emulation-bus analyzer will ignore the Trig2 line of the coordinated measurement bus.

Refer to the chapter titled Making Coordinated Measurements in this manual for further details on the use of signals shown in the Interactive Measurement Specification dialog box.

To select whether the card cage rear panel BNC is connected to the Trig1 and/or Trig2 signals

- Choose "Drive", "Receive", "Neither", or "Both" for the "BNC on Trig1" and/or "BNC on Trig2" configuration items.

Choosing "Drive" specifies that the signal connected to the BNC will be driven onto the Trig1 and/or Trig2 lines of the emulation-bus analyzer.

Modifying the Interactive Measurement Specification Configuration Items

Choosing "Receive" specifies that the Trig1 and/or Trig2 signals from the emulation-bus analyzer will be available to be received by any connection to the BNC.

Choosing "Neither" specifies that the BNC is isolated from the Trig1 and/or Trig2 lines of the emulation-bus analyzer.

Choosing "Both" specifies that the BNC can both "Drive" and "Receive" the Trig1 and/or Trig2 signals of the emulation-bus analyzer.

Refer to the Specifications and Characteristics chapter in this manual for the electrical specifications of the Trig1 and Trig2 trigger signals.

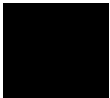

To select whether the coordinated measurement bus is connected to the Trig1 and/or Trig2 signals

- Choose "Drive", "Receive", "Neither", or "Both" for the "CMBT on Trig1" and/or "CMBT on Trig2" configuration items.

Choosing "Drive" specifies that the signal connected to the coordinated measurement bus connection will be driven onto the Trig1 and/or Trig2 lines of the emulation-bus analyzer.

Choosing "Receive" specifies that the Trig1 and/or Trig2 signals from the emulation-bus analyzer will be available to be received by any connection to the coordinated measurement bus.

Choosing "Neither" specifies that the coordinated measurement bus is isolated from the Trig1 and/or Trig2 lines of the emulation-bus analyzer.

Choosing "Both" specifies that the coordinated measurement bus can both "Drive" and "Receive" the Trig1 and/or Trig2 signals of the emulation-bus analyzer.

Refer to the Specifications and Characteristics chapter in this manual for the electrical specifications of the Trig1 and Trig2 trigger signals.

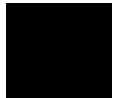

To select whether the emulator will allow a signal on Trig2 to initiate a break from target program execution

- Choose "Yes" or "No" for the "Enable Break Receive Trig2" specification.

Choosing "Yes" specifies that a trigger signal supplied on the Trig2 line will be supplied to the emulator where it can be used to initiate an emulation break from execution of the target program and begin execution in the emulation monitor.

Choosing "No" specifies that no emulation break will occur in response to any trigger signal on Trig2.

Use this selection if you intend to cause an emulation break in response to an event found by a device connected to the card cage rear panel BNC. The emulator always receives Trig1 from the emulation-bus analyzer; Trig1 can be used to cause a break from execution of the target program to the monitor when the emulation-bus analyzer detects a trigger condition during a trace.

Refer to the Specifications and Characteristics chapter in this manual for the electrical specifications of the Trig1 and Trig2 trigger signals.

To select whether or not the emulation-bus analyzer will operate with, or ignore, the Trig2 line of the coordinated measurement bus.

- Choose "Drive", "Receive", or "Neither" for the "Analyzer on Trig2" specification.

Choosing "Drive" specifies that the emulation-bus analyzer will drive a trigger signal on the Trig2 line of the coordinated measurement bus when it recognizes its trigger condition during a trace.

Choosing "Receive" specifies that the emulation-bus analyzer will receive the signal on the Trig2 line of the coordinated measurement bus when it is supplied, and it will mark the state that it is capturing as the trigger state at the instant when the Trig2 signal is detected.

Choosing "Neither" specifies that the emulation-bus analyzer will ignore the Trig2 line of the coordinated measurement bus.

Refer to the Specifications and Characteristics chapter in this manual for the electrical specifications of the Trig1 and Trig2 trigger signals.

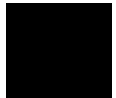

Providing MMU Address Translation for the Foreground Monitor

When using the memory management unit (MMU) of the MC68040, the target system must provide the proper address translation for the foreground monitor. To be able to do this, you will need to understand your target system's physical memory map and MMU address translation structure. You may need to modify your mapping scheme or some of its mapping protections.

In order for the monitor to operate after the MMU is turned on, the target system must provide 1:1 address translation for the block of memory occupied by the monitor (logical address = physical address). The foreground monitor will reside in a 4-Kbyte block of emulation memory corresponding to a single page in the MMU. This memory can be mapped to begin on any 4-Kbyte address boundary. Simply specify an address ending in 000h when you answer the monitor address question when you set up the emulation configuration.

For example, if the monitor is located at logical address 0fff1000h, then the MMU must translate that address to physical address 0fff1000h, logical address 0fff1004h to physical address 0fff1004h, etc.

Do not write protect the address range occupied by the foreground monitor.

There are two ways to provide the proper address translation for the memory space occupied by the foreground monitor:

- Locate the foreground monitor in a block of memory that is transparently translated via ITTx and DTTx transparent translation registers (TTRs). The monitor contains both code and data so two TTRs are needed to provide translations: one for instructions, and the other for data. When the MMU processes translations, it first compares the logical address with the parameters of the TTRs. If it finds a match, the MMU uses the logical address as the physical address for the access (obtaining the needed 1:1 translation).

The minimum block size that can be transparently translated by the TTRs is 16 Mbytes. If your target system already sets one or both data and instruction TTRs for supervisor access and no write protection, then you may be able to find an unused 4-Kbyte block within this 16-Mbyte range where the monitor can reside.

Chapter 10: Configuring the Emulator Providing MMU Address Translation for the Foreground Monitor

If your target system does not use the TTRs, then you may want to modify your MMU boot code to configure an instruction and data TTR specifically for the monitor.

Example

This example shows how to modify boot code to use a pair of TTRs. Assume your target system does not access any physical addresses in the 16-Mbyte range 02000000..02ffffffh, and DTT0/ITT0 are unused. By locating the monitor at address 02000000 and adding the following code fragment to your boot code, you should be able to break into the monitor while the MMU is turned on:

```
* configure ITT0/DTT0 for emulation monitor
MOVE.L   #$0200C000,D0
MOVEC    D0,ITT0
MOVEC    D0,DTT0
```

Without these transparent translations for the monitor, the MMU will probably generate an access fault when you attempt to break into the monitor. The access fault would occur because addresses in the 02000000 range would have no valid translations (they would be on a non-resident page).

If you cannot modify your boot code, you may be able to use an execution breakpoint to break into the monitor before the MMU is enabled and use the monitor to configure the TTRs. Do this only as a last resort because the MC68040 processor automatically disables all TTRs whenever an emulation or target reset occurs (and they must be reinitialized each time).

- The second way to provide proper address translation for the foreground monitor is to locate the monitor within a page that is controlled by the MMU address translation tables; one that is always resident, writeable, supervisor accessible, and translated 1:1. The monitor occupies one 4-Kbyte page of emulation memory. It will be stored in the 4-Kbyte range of the dual-port memory.

To modify the MMU address-translation tables to translate the monitor address space 1:1

- If the MMU address translation tables are already loaded into emulation or target memory, you can add or modify existing descriptors in the tables to define the appropriate translations for the monitor. Note that this must be done before setting the TC register to enable the MMU.
- If the MMU address translation tables are loaded into memory along with your target program, you may want to modify your source code so that when the translation tables are loaded into memory, they will already define the correct mappings for the monitor.
- This last method is the most difficult method. Use it only if you cannot use one of the above two methods and you cannot use either of the sets of transparent translation registers. If you are not sure how the MMU address translation tables are set up, but you can run your program long enough to turn on the MMU, then you should be able to use emulator commands to query and modify address translations in memory. After the MMU has been turned on, reset the emulator and then break directly into the monitor. Reset will clear the enable bit in all MMU registers, but leave the other bit fields intact. Now you can use the emulator's MMU mappings command to obtain detailed information about previous address translations, including table addresses and descriptor values.

When you modify the content of any MMU mapping table, remember that the tables are located in physical address space. You must enter your modification commands by using physical addresses.

Select an address space to contain your foreground monitor that is higher than the address space used for your target program and I/O. This will optimize deMMUer resources by using them first to reverse-translate the address space of your target program.

Examples

Display the memory that contains your address translation tables. Modify the memory space to allocate a single page, either 4K or 8K page, to contain the foreground monitor. Ensure that the page is supervisor protected, and that it is not write protected.

The remaining portion of this example shows you how to proceed if you must use the most difficult method for controlling address space for your foreground monitor.

To map the foreground monitor to address space that is translated 1:1 by the MMU, assuming you configured the monitor to reside at 24000H, and you ran your target program long enough to turn on the MMU, use the debugger interface pulldown menu to do the following:

- Choose **Execution**→**Reset**
- Choose **Execution**→**Break**
- Choose **Display**→**MMU Translations...**, and in the dialog box, select MMU Mappings, Start Address 24000h, and End Address 24ffffh. Now enter a value to enable the MMU by selecting Override Processor Register Values, and enter either 8000H or 0C000H in the entry field beside TC Value (16 bit), depending on your page size. Finally, select OK.

Using the command line, enter the following commands:

```
reset  
break  
display mmu_translations 24000..24ffffh use_value TC  
8000h
```

The above commands cause the emulator to show the present logical-to-physical mapping of the address range occupied by the monitor. Note that the monitor's base address (24000h in this example) must be on a 4-Kbyte boundary (hexadecimal number ending in 000H).

- Choose **Display**→**MMU Translations...**, and in the dialog box, select MMU Tables, Address 24000h, and an override value for the TC register that will enable MMU. Finally, select OK.

Using the command line, enter the following command:

```
display mmu_translations tables 24000h use_value TC  
8000h
```

Providing MMU Address Translation for the Foreground Monitor

The final command in this example shows the details of the path address 24000h takes through the MMU mapping tables to reach its corresponding physical address. Place appropriate values in the path through the mapping tables to ensure that the page containing logical address 24000h is mapped to physical space beginning at address 24000h.

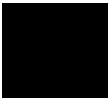

Locating the Foreground Monitor using the MMU Address Translation Tables

Locate the foreground monitor at a specific page address and add the proper address translation for this page in your supervisor address translation tables. The minimum page size is 4 Kbytes so the monitor only requires a single translation. The page that contains the foreground monitor must always be resident, translated 1:1 (logical address = physical address), and never be write protected.

The most direct way to do this is to modify the address translation tables in your source code, rebuild your executable file, and download the executable into RAM, or reprogram the executable into ROM. For systems that use an operating system to manage dynamic translation tables in RAM, the page allocated to the monitor must not be allowed to be swapped out by the operating system. This may require that the page selected for the monitor reside in unused space within the operating system (assuming the operating system is translated 1:1). The easiest way to create unused space is to globally define an 8-Kbyte array of data that is never referenced by your software. After rebuilding your operating system software, refer to the linker symbol map file to determine the address range of this array. Use the lowest address that resides on a 4-Kbyte boundary within this range as the starting address for the monitor.

As a last resort, if your target system software cannot be rebuilt, you can use the emulator to modify your translation tables directly.

The emulator provides a command to display individual address translations in detail, including address, value, and mnemonic information about each descriptor from the translation tables. You may be able to provide the proper address translation for the monitor by simply modifying a single descriptor (long word) to convert an invalid page into a resident page.

If the translation tables are located in ROM, you will need to copy them into emulation memory before you attempt to modify them. This is done by storing all or part of your ROM to a file, and then mapping emulation memory over the ROM address range and reloading the file.



Chapter 10: Configuring the Emulator
Providing MMU Address Translation for the Foreground Monitor



Part 3

Concept Guide

Part 3

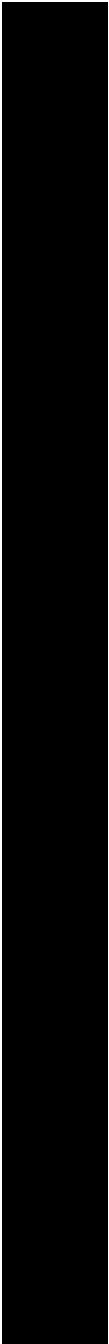

X Resources and the Graphical Interface

An introduction to X resources.

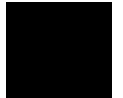

X Resources and the Graphical Interface

This chapter helps you to understand how to set the X resources that control the appearance and operation of the debugger's graphical interface. This chapter:

- Explains the X Window concepts surrounding resource specification.
- Explains the scheme files used by the debugger's graphical interface.

The debugger's graphical interface is an X Window System application which means it is a *client* in the X Window System client-server model.

The *X server* is a program that controls all access to input devices (typically a mouse and a keyboard) and all output devices (typically a display screen). It is an interface between application programs you run on your system and the system input and output devices.

An X resource is user-definable data

A *resource* is a user-definable piece of data that controls the operation or appearance of an X Windows application. A resource may apply to an application (application-specific resources) or it may apply to the objects called *widgets* from which the application is constructed. That is particularly true of standard widget resources that control the appearance of an application. For example, most widgets have a standard resource that allows the user to specify the font used to display text on objects like buttons, menus, and labels.

An *application-specific resource* is defined by the application developer and may control such things as the mode of operation of an application. For example, you can use an application-specific resource for the debugger's graphical interface to control whether to start the interface with the command line on or the command line off.

A resource specification is a name and a value

Each resource in an application has a name and a value. Because an X Window System application is constructed from widgets, a resource name is closely associated with the names of the widgets that make up the application. Each application begins with a top-level widget that is the parent of all other

widgets in the application. The name of the top-level widget is usually the same as that of the application. This top-level widget may have a number of widgets “beneath” it that are called children of the top-level widget. The names for these widgets are most often chosen for their mnemonic value. These children can also in turn have child widgets. A resource name, then, is simply a name of a piece of data for the lowest-level widget coupled with a string of widget names picked up from each of the widgets along the path starting with the top-level widget and going down to the lowest-level widget.

The data name and widget names within a resource name are separated from each other by dots. The resource name itself is terminated by a colon. A resource value is simply the data value itself. Ignoring the widget names and data name for the moment, a common resource for most widgets is `color`. A data value for `color` might be “blue.”

To put this all together, a resource string for the foreground color for the “quit” pushbutton displayed on an application called “tracker” might look like the following:

```
tracker.panel.control.quit.foreground: white
```

Don't worry, there are shortcuts

As you might guess, specifying resources for applications with many levels of widgets can be difficult and error-prone. For that reason, you can use a shortened notation. To fully understand how the notation works, however, you must first understand about *instance names* and *class names*.

An *instance name* is a name given to a particular widget by an application developer. You have already seen instance names used. The name “quit” is an instance name for a pushbutton widget used by the developer of the “tracker” application from the last example. An instance name makes the pushbutton widget named “quit” unique from other pushbutton widgets in the “tracker” application.

A *class name* is a general name for all widgets of a particular type. For example, the class name for the OSF/Motif pushbutton widget is `XmPushButton`. When you refer to a widget in an application by its class name, you are referring to all widgets of that class in the application, and not to just a particular widget.

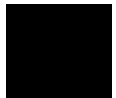

Instead of specifying the foreground color for the tracker quit button by using a resource name made up of instance names as in the last example, you could instead use a class name, as follows:

```
tracker.panel.control.XmPushButton.foreground: white
```

Using class names in this way makes it easier to specify resources because it relieves you from having to discover the names of particular widgets in an application. A long string of instance names or class names is still a long string of names, however. Fortunately, a wildcard helps to make the shortcut a true shortcut. The wildcard is an asterisk ("*"). It can be used to replace any number of class or instance names in a resource name. The last example could now be shortened to either of the following:

```
tracker*XmPushButton.foreground: white
```

```
tracker*quit.foreground: white
```

But wait, there is trouble ahead

An X Window System application maintains a complete list of resources, and the application knows the complete instance and class names for each resource. Because you can specify resource values using shortened notation, the application, when starting up, must match specified values to individual resources. Some general rules apply:

- Either a class name or instance name from the request must match each class or instance name in the application's list of resources.
- Entries prefixed by a dot are more specific and therefore have precedence over entries prefixed by an asterisk.
- Instance names are more specific and therefore have precedence over class names.
- Matching is done from left to right. Instance or class names appearing at the beginning of the specification have precedence over those later in the specification.

As you can quickly see, resource matching favors specific resource names over general resource names. General resource names, especially those involving class names, can have unexpected and unintended effects. Consider the last example again. The resource specification

```
tracker*XmPushButton.foreground: white
```

may not only set the foreground color of the quit button on the control panel of the application to white — it could also set the foreground colors for any pushbutton anywhere in the application. That is because the combination of the wildcard and the use of the class name make this resource specification match a resource request for any pushbutton in the application.

The second of the two specifications in the example does not completely solve the problem either. Suppose there was another button elsewhere in the application with the instance name of “quit.” (Duplicating instance names is correct as long as the widget paths to two different widgets of the same name are different.) The second specification of

```
tracker*quit.foreground: white
```

could match a resource request for that button as well because the wildcard allows the specification to match a number of different widget paths through the application.

Resource specification is usually a matter of trial and error. The following resource is probably specific enough to set just the foreground color for the quit button on the control panel:

```
tracker*control*quit.foreground: white
```

To view the resources in the debugger’s graphical interface, you can choose **Help**→**X Resource Names** and click on the “All names” button.

Class and instance apply to applications as well

Just as there are classes and instances of widgets, there are classes and instances of X Window applications. Resource specifications can be constructed in such a way that they apply to a whole class of applications, or just to an instance of those applications.

The class name for the debugger graphical interface products is *HP64_Debug*. The instance of the class that this debugger graphical interface falls under is called *debug*. A few examples are in order.

- For a given resource (called < resource >), the following specification applies to all debugger interface products for all processors:

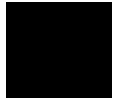

```
HP64_Debug*<resource>: <value>
```

- The following specifications apply to all m68040 debugger interfaces:

```
HP64_Debug.m68040*<resource>: <value>
```

```
debug.m68040*<resource>: <value>
```

According to the precedence rules for resource matching, the first specification is the most general and would be overridden by either of the following two.

Resource specifications are found in standard places

X resources are defined in standard places so that applications can find them and use them when starting up.

The app-defaults file

The app-defaults file contains only resources for a specific application. The system directory for application default files is:

```
HP-UX          /usr/lib/X11/app-defaults
```

```
SunOS          /usr/openwin/lib/X11/app-defaults
```

The name of the default file is the same as the class name for the application and is also called the *app-defaults file* (for example, HP64_Debug is the name of the debugger's graphical interface's application defaults file).

These defaults should not be changed by individual users because doing so affects the appearance and behavior of the application for all users of the application.

The .Xdefaults file

The .Xdefaults file in your \$HOME directory usually contains user-defined resources for several applications.

Scheme files

X resource specifications can point to *scheme files* in which other X resources are specified.

Loading order resolves conflicts between files

If there are two files, then which resource specification from which file controls the resource in the application? That problem is solved by adhering to a loading order for files. The following is a list of the standard places, in order, that an application looks to find resources:

- 1 The application default file.

The application default file for the graphical interface is called *HP64_Debug*. This file is created at software installation time and placed in the system application defaults directory.

- 2 \$XAPPLRESDIR/< class>

This environment variable defines an alternative directory path leading to customized class files. Useful for directing the application to system-wide custom files.

- 3 RESOURCE_MANAGER property. Some X servers have a resource property associated with the root window for the server. Resources are added to the resource property database by using *xrdb*. (HP VUE is an example.) The server can use this property to access those resources.

If no RESOURCE_MANAGER property exists, then \$HOME/.Xdefaults is read. The primary and probably best method for creating or adding to this file is by copying part or all of the app-defaults file into the .Xdefaults file.

- 4 \$XENVIRONMENT file. This environment variable defines a file that contains resource specifications.

If the XENVIRONMENT variable is not set, then \$HOME/.Xdefaults-host is read.

- 5 Command line options

Resources can be specified on the command line by using the **-xrm** command line option. The application strips these arguments out and

sets these resources before passing the rest of the command line on to the application.

Remember, load order specifies the precedence for resource overrides. A resource found later in the load order overrides a resource found earlier in the load order if the resource specifications match each other.

The app-defaults file documents the resources you can set

The *HP64_Debug* file is complete, well-commented, and a good source of reference for graphical interface resources. The *HP64_Debug* file should be your primary source of information about setting graphical interface resources. This file can be easily viewed from the help topic menu by choosing **Help**→**General Topic** and selecting the “X Resources: Setting” topic.

To further assist you with setting X resources, there is also another topic on the help menu pull-down that you should use. Choose **Help**→**X Resource Names** to display the class and instance name for the graphical interface in a dialog box. From the dialog box, you can also display all widget class and instance names for all widgets that make up the debugger’s graphical interface. In most cases, you will not need to delve that far into the widget tree, but it is there if you need it.

In addition to the app-defaults file, the graphical interface uses *scheme files*. Resources are not duplicated between scheme files and the *HP64_Debug* file. You may wish to set resources found in the scheme files as well, so you need to understand how scheme files relate to the interface and to the other X resource files.

Scheme files augment other X resource files

Hewlett-Packard realizes that the debugger’s graphical interface will be run in environments made up of workstations with different display capabilities and even in environments with different types of computers (platforms) running the X Window System. The debugger’s graphical interface, unlike many other X applications, makes determinations about display hardware as to the platform type, the resolution of the display, and whether the display is color or monochrome. The interface then loads the appropriate scheme files to allow the interface to come up in a reasonable way based on the hardware.

There are six scheme files. Their names and a brief description of the resources they contain follows:

Debug.Label	Defines the labels for the fixed text in the interface. Such things as menu item labels and similar text are in this file. If the \$LANG environment variable is set, the scheme file “Debug.\$LANG” is loaded if it exists; otherwise, the file “Debug.Label” is loaded.
Debug.BW	Defines the color scheme for black and white displays. This file is chosen if the display cannot produce at least 16 colors.
Debug.Color	Defines the color scheme for color displays. This file is chosen if the display can produce 16 or more colors.
Debug.Input	Defines the button and key bindings for the mouse and keyboard.
Debug.Large	Defines the window dimensions and fonts for high resolution display (1000 pixels or more vertically).
Debug.Small	Defines the window dimensions and fonts for low resolution displays (less than 1000 pixels vertically).

Debug.Label (or Debug.\$LANG) resides in the directory */usr/hp64000/lib/X11/HP64_schemes*. This directory is the upper level directory for scheme files. The other five files are in subdirectories below this one named by platform (or operating system). For example, the HP 9000 scheme files are in the subdirectory */usr/hp64000/lib/X11/HP64_schemes/HP-UX*.

Like the app-defaults file, these scheme files are system files and should not be modified directly.

You can create your own scheme files, if you choose

The debugger’s graphical interface supports user-defined scheme files. The interface searches two places for user-defined scheme files and loads any it finds after loading the system scheme files. Refer to any of the scheme files mentioned for information about where to place your own scheme files.

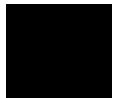

Scheme files continue the load sequence for X resources

Scheme files extend the load order for finding X resources. System scheme file resources override all other resources gathered so far, and user-defined scheme files, in turn, override the system scheme files. Continuing from the load order list previously, the scheme files follow, in the order

- 1 /usr/hp64000/lib/X11/HP64_schemes/Debug.Label
/usr/hp64000/lib/X11/HP64_schemes/< platform> /Debug.< scheme>
- 2 \$XAPPLRESDIR/HP64_schemes/Debug.Label
\$XAPPLRESDIR/HP64_schemes/< platform> /Debug.< scheme>

Just as \$XAPPLRESDIR can point to a system-wide app-defaults file, so can it point to a set of system-wide scheme files.

- 3 \$HOME/.HP64_schemes/Debug.Label
\$HOME/.HP64_schemes/< platform> /Debug.< scheme>

Please note the dot (.) in the “.HP64_schemes” directory name.

You can force the debugger’s graphical interface to use certain schemes

Five application-specific resources allow you to force the interface to use certain schemes. The resources and what they control are as follows:

HP64_Debug.platformScheme:

Controls the platform scheme chosen by the interface. This resource is particularly useful in mixed-platform environments where you might be executing the interface remotely on an HP 9000 computer, but displaying the interface on a Sun SPARCsystem computer. In this situation, you may wish to set the resource to use the SunOS scheme so that you can use the same key and mouse button bindings as other Sun OpenWindows applications.

The value of this resource is actually the name of a subdirectory under /usr/hp64000/lib/X11/HP64_schemes or one of the alternative directories for scheme files. You can create your own file and subdirectory under /usr/hp64000/lib/X11/HP64_schemes (or alternative) and then set this resource to choose that subdirectory instead of the standard platform subdirectory.

Values can be: HP-UX, SunOS, or the name of a sub-directory containing custom scheme files.

HP64_Debug.colorScheme:

Chooses the black and white or color scheme.

Values can be: Color, BW, or the name of a custom scheme file.

HP64_Debug.inputScheme:

Chooses the keyboard and mouse bindings.

Values can be: Input or the name of a custom scheme file.

HP64_Debug.sizeScheme:

Chooses the large or small scheme for fonts and sizes.

Values can be: Large, Small, or the name of a custom scheme file.

HP64_Debug.labelScheme:

Chooses a different label scheme for fixed text. Again, this resource is affected by the \$LANG variable.

Values can be: Label, \$LANG (if this environment variable is set and there is a Debug.\$LANG scheme file), or the name of a custom scheme file.

These resources are in the app-defaults file. To override these resources, set them in your *.Xdefaults* file.

Again, setting X resources is a trial and error process. The scheme files used by the debugger's graphical interface simplify the process by collecting related resources in specific files.

To review the organization:

- The app-defaults file contains resources that control the operation of the interface. To override a resource in this file, copy the resource to your *.Xdefaults* file and change it there.
- Resources that control the appearance of the display and keyboard and mouse button bindings for your platform are in the scheme files. Copy the scheme files to an appropriate place and modify the resources found in them to change the look of the interface.

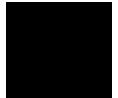

If you would rather place these resources in your `.Xdefaults` file, remember the load order. Make the resource name in the `.Xdefaults` file more specific or it will be overridden by the one in the scheme file.

The `app-defaults` file and the scheme files are your best sources of reference for help with modifying individual resources.

Resource setting - general procedure

Application specific resources

If you plan to modify an application-specific resource, you should look in the `HP64_Debug` file for information about that resource.

If the `RESOURCE_MANAGER` property exists (as is the case with `HP VUE`), copy the complete `HP64_Debug` file, or just the part you are interested in, to a temporary file. Modify the resource in your temporary file and save the file. Then, merge the temporary file into the `RESOURCE_MANAGER` property with the `xrdb -merge < filename >` command.

If the `RESOURCE_MANAGER` property does not exist, copy the complete `HP64_Debug` file, or just the part you are interested in, to your `.Xdefaults` file. Modify the resource in your `.Xdefaults` file and save the file.

Finally, if the debugger's graphical interface is currently executing, you must exit and restart the interface for the change to have any effect.

General resources

If you plan to modify a general resource that could not be found in the `HP64_Debug` file, look to the scheme files for information about that resource. A general discussion of the kinds of information found in the scheme files can be found in the previous "Scheme files augment other resources" section.

Copy the appropriate scheme file to one of the alternative directories and make the modifications there. (If you are using `$XAPPLRESDIR`, make sure the variable is set and exported.) Save the file. If the debugger's graphical interface is currently executing, you must exit the application and restart it to see the results of your change.

Part 4

Reference

Part 4



12

Debugger Commands

Detailed descriptions of command line commands.



How Pulldown Menus Map to the Command Line

Pulldown	Command Line
File→Context→Directory	Debugger Directory Change_Working
File→Context→Symbols	Program Context Set
File→Load→Emulator Config	Debugger Execution Environment Load_Config
File→Load→Executable	Program Load Default
File→Load→Program Only	Program Load New Code_Only No_Pc_Set
File→Load→Symbols Only	Program Load New Symbols_Only No_Pc_Set
File→Load→User-Defined Macros	File Command < filename>
File→Load→DeMMUer	Trace deMMUer Load fromFile
File→Store→Startup (.rc) file (as default)	File Startup
File→Store→Startup (.rc) file	File Startup < filename>
File→Store→User-Defined Macros	N/A
File→Store→BBA Data	Memory Unload_BBA < filename>
File→Store→DeMMUer (From MMU tables)	Trace deMMUer Store < filename>
File→Copy Window→	File User_Fopen Append < win> File < filename>
File→Log→Playback	File Command
File→Log→Record Commands	File Log On < filename>
File→Log→Stop Command Recording	File Log oFF
File→Log→Record Journal	File Journal On
File→Log→Stop Journal Recording	File Journal oFF
File→Emul700→Emulator/Analyzer (Graphic)	N/A
File→Emul700→Emulator/Analyzer (Term)	N/A
File→Edit→File	Debugger Host_Shell < editor>
File→Edit→At () Location	Debugger Host_Shell < editor_at_line>
File→Edit→At PC Location	Debugger Host_Shell < editor_at_line>
File→Term	Debugger Host_Shell
File→Exit→Window	Debugger Quit Yes
File→Exit→Locked	Debugger Quit Locked
File→Exit→Released	Debugger Quit Released
Display→Context	N/A
Display→Memory→Mnemonic ()	Memory Display Mnemonic
Display→Memory→byte	Memory Display Byte

Pulldown

Display→Memory→word
Display→Memory→long
Display→MMU Translations
Display→Source ()
Display→Source at PC
Display→Source Find Fwd ()
Display→Source Find Back ()
Display→Source Find Again
Display→C Expression ()
Display→Var/Expression ()
Display→Monitor Variable
Display→All symbols ()
Display→Symbols→Data & Macros ()

Display→Symbols→Functions & Labels ()

Display→Symbols→Modules ()
Display→Symbols→Browse C+ + Class ()
Display→Error Log

Modify→Emulator Config
Modify→C Expression ()
Modify→Memory
Modify→Memory at ()
Modify→Register
Execution→Run→from PC
Execution→Run→from ()
Execution→Run→from Transfer Address
Execution→Run→from Reset

Execution→Run→until ()
Execution→Step Over→
Execution→Step→
Execution→Reset to Monitor
Execution→Set PC to Transfer

Command Line

Memory Display Word
Memory Display Long
Memory MMU
Program Display_Source
Program Context Set
Program Find_Source Occurrence Forward
Program Find_Source Occurrence Backward
Program Find_Source Next
Expression C_Expression
Expression Display_Value
Expression Monitor Value
Symbol Display Default
Symbol Display Options Data¯os
End_Options
Symbol Display Options Functions&labels
End_Options
Symbol Display Options Modules End_Options
Symbol Browse
N/A

Debugger Execution Environment Modify_Config
Expression C_Expression < variable> =
Memory Assign
Memory Assign Long
Expression C_Expression @reg
Program Run
Program Run From
Program PC_Reset - Program Run
Debugger Execution Reset_Processor Program
Run
Program Run Until
Program Step Over
Program Step
Debugger Execution Reset_Processor
Program Pc_Reset

Chapter 12: Debugger Commands

Pulldown

Breakpoints→**Set**→**Instruction** ()

Breakpoints→**Set**→**Read** ()

Breakpoints→**Set**→**Write** ()

Breakpoints→**Set**→**Read/Write** ()

Breakpoints→**Delete** ()

Breakpoints→**Delete All**

Breakpoints→**Edit/Call Macro**

Window→

Settings→**High Level Debug**

Settings→**Assembly Level Debug**

Settings→**Debugger Options**

Settings→**DeMMUer**

Settings→**Command Line**

Command Line

Breakpt Instr

Breakpt Read

Breakpt Write

Breakpt Access

Breakpt Delete

Breakpt Clear_All

N/A

Window Active < window name>

Debugger Level High_Level

Debugger Level Assembly

N/A

Trace deMMUer Load

N/A

How Popup Menus Map to the Command Line

Code window pop-pup	Command Line
Set/Delete Breakpoint	Breakpt Instr or Breakpt Delete
Attach Macro	N/A
Edit Attached Macro	N/A
Edit source	N/A
Run until	Program Run Until # < line_number>
Trace After	Trace Trigger Address Is # < line_number> Status Is CycTyp Fetch PosnTrig Start
Trace Before	Trace Trigger Address Is # < line_number> Status Is CycTyp Fetch PosnTrig End
Trace About	Trace Trigger Address Is # < line_number> Status Is CycTyp Fetch PosnTrig Center
Trace Until	Trace Trigger Address Is # < line_number> Status Is CycTyp Fetch BrkOnTrg PosnTrig End

Default window pop-up	Command Line
Highlight/Toggle Window	Window Active/ < window_name> Window Toggle_View
Remove Window	N/A

Breakpoint window pop-up	Command Line
Delete Breakpoint	Breakpt Delete < brkpt_nmbr>
Delete All Breakpoints	Breakpt Clear_All

Monitor window pop-pup	Command Line
Delete Variable	Expression Monitor Delete < number>
Delete All Variables	Expression Monitor Clear_All

Backtrace window pop-up	Command Line
Disp Source at Stack Level	Program Context Set @< level>
Disp Vars at Stack Level	Program Context Expand @< level>
Run Until Stack Level	Program Run Until @< level>

Status Line Popup	Command Line
Command Line On/Off	N/A
Remove Temporary Message	N/A

Command Line Popup	Command Line
Forward Tab	< Tab>
Backward Tab	< Shift> -< Tab>
Execute Command	< Return>
Clear to End of Line	< Ctrl> -E
Clear Entire Line	< Ctrl> -U
Command Line On/Off	N/A

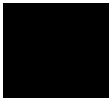

Command Summary

Breakpoint Commands

Breakpoint commands control execution of a program.

Command	Definition
Breakpt Access	Set a breakpoint on access (read/write) of an address
Breakpt Clear_All	Clear all breakpoints
Breakpt Delete	Delete specified breakpoints
Breakpt Force_HW	Set a hardware-assisted instruction breakpoint
Breakpt Instr	Set an instruction breakpoint
Breakpt Read	Set a breakpoint on a read from an address
Breakpt Write	Set a breakpoint on a write to an address

Session Control Commands

The session control commands select debugger operating modes, set debugger session options, define and display macros, allow access to the host operating system, and end debugger sessions.

Command	Definition
Debugger ?	Access debugger on-line help
Debugger Directory	Display or change present working directory
Debugger Execution Display_Status	Display current directory and files in use
Debugger Execution Environment	Configure and control emulation environment
Debugger Execution IO_System	Control debugger simulated I/O
Debugger Execution Load_State	Restore previously saved debugger session
Debugger Execution Reset_Processor	Simulate microprocessor reset
Debugger Host_Shell	Enter HP-UX operating system environment
Debugger Level	Select debugger mode (high-level or assembly)
Debugger Macro Add	Create a macro
Debugger Macro Call	Call a macro
Debugger Macro Display	Display macro source code
Debugger Option	Set or list debugger options for this session
Debugger Pause	Pause debugger session
Debugger Quit	Terminate a debugging session

Expression Commands

Expression commands calculate expression values, print formatted output to a window, and monitor variables.

Command	Definition
Expression C_Expression	Calculate the value of a C expression
Expression Display_Value	Display the value of an expression or variable
Expression Fprintf	Print formatted output to a window
Expression Monitor Clear_All	Discontinue monitoring all variables
Expression Monitor Delete	Discontinue monitoring specified variables
Expression Monitor Value	Monitor variables
Expression Printf	Print formatted output to Journal window

File Commands

File commands read and process command files, open files or devices for writing, log debugger commands to a file, and save debugger startup parameters.

Command	Definition
File Command	Read in and process a command file
File Error_Command	Set command file error handling
File Journal	Copy Journal window output to a journal file
File Log	Record debugger commands/errors in a file
File Startup	Save the default startup options
File User_Fopen	Open a file or device for read or write access
File Window_Close	Close the file associated with a window number

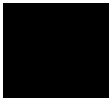

Memory Commands

Memory commands do operations on the target microprocessor's memory.

Command	Definition
Memory Assign	Change the values of memory locations
Memory Block_Operation Copy	Copy a memory block
Memory Block_Operation Fill	Fill a memory block with values
Memory Block_Operation Match	Compare two blocks of memory
Memory Block_Operation Search	Search a memory block for a value
Memory Block_Operation Test	Examine memory area for invalid values
Memory Display	Display memory contents
Memory MMU MapAddresses	Show logical-to-physical address mapping
Memory MMU TableDisplay	Show table walk for a logical address
Memory Register	Change the contents of a register
Memory Unload_BBA	Unload BBA data from program memory

Program Commands

Program commands load and execute programs, control program execution, display source code and program variables, and set or cancel program interrupts.

Command	Definition
Program Context Set	Specify current module and function scope
Program Context Display	Display all local variables of a function
Program Context Expand	Display all local variables of a function at the specified stack (backtrace) level
Program Display_Source	Display C source code
Program Find_Source Occurrence	Find first occurrence of a string
Program Find_Source Next	Find next occurrence of a string
Program Interrupt Add	Simulate an interrupt
Program Interrupt Remove	Cancel all pending interrupts
Program Load	Load an absolute file for debugging
Program Pc_Reset	Reset the program starting address
Program Run	Start or continue program execution
Program Step	Execute a number of instructions or lines
Program Step With_Macro	Execute macro after each instruction step

Symbol Commands

Symbol commands add, remove, and display symbols.

Command	Definition
Symbol Add	Add a symbol to the symbol table
Symbol Browse	Browse C++ class
Symbol Display	Display symbol, type, and address
Symbol Remove	Delete a symbol from the symbol table

Trace Commands

Trace commands let you do bus level tracing of your program activity with bus cycle store qualification of data.

Command	Definition
Trace Again	Start a trace using the last defined trigger and qualification terms
Trace DeMMUer Load	Load physical-to-logical deMMUer hardware from MMU tables or file
Trace DeMMUer Store	Save physical-to-logical deMMUer hardware parameters to file
Trace DeMMUer Enable	Turn on physical-to-logical deMMUer hardware
Trace DeMMUer Disable	Turn off physical-to-logical deMMUer hardware
Trace Display	Display trace information in the View window
Trace Event Clear_All	Clear (remove) all defined events
Trace Event Delete	Delete specified events
Trace Event List	List terms (conditions) of specified event
Trace Event Specify	Define an event (combination of bus conditions)
Trace Event Used_List	List summary of trace events in the View window
Trace Halt	Stop the current trace
Trace StoreQual	Specify the bus conditions to be stored (captured)
Trace StoreQual Event	Specify a previously defined event to be stored (captured)
Trace StoreQual List	List the current storage qualification terms
Trace StoreQual None	Disable current storage qualification terms (store everything)
Trace Trigger	Specify the bus conditions to be used to trigger (start) a trace
Trace Trigger Event	Specify a previously defined event to be used as the trigger
Trace Trigger List	List the current trigger terms in the View window
Trace Trigger Never	Disable current trigger terms (start trace on any bus state)

Window Commands

Window commands do operations on the debugger windows.

Command	Definition
Window Active	Activate a window
Window Cursor	Set the cursor position for a window
Window Delete	Remove a user-defined window or screen
Window Erase	Clear data from a window
Window New	Make a new screen or window
Window Resize	Change the size of a window
Window Screen_On	Activate a screen
Window Toggle_View	Select the alternate display of a window

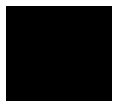

Breakpt Access

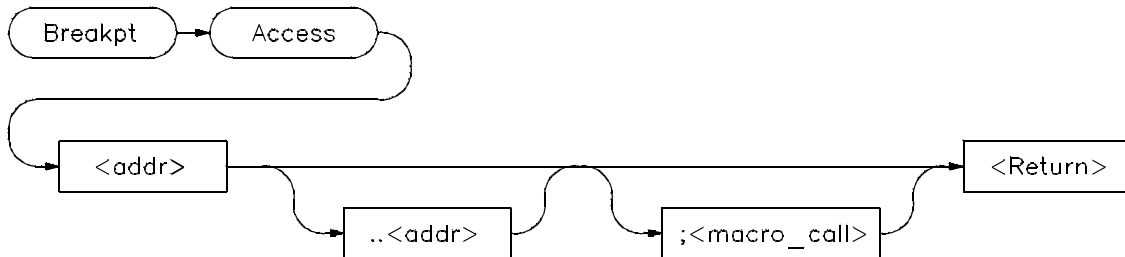

The Breakpt Access command sets an access breakpoint at the specified memory location (< addr>) or range (< addr> ..< addr>). The access breakpoint halts program execution each time the target program attempts to read from or write to the specified memory location or range. Memory locations may contain code or data.

You can attach a macro to a breakpoint using the optional < macro_call> parameter. See the chapter titled “Using Macros and Command files”.

Each time the debugger detects an access of the address or range, it does the following:

- 1 Suspends program execution.

Sometimes execution may stop a few instructions past the instruction causing the access. This is called "skid."

- 2 Executes a macro (if you attached one to the breakpoint). Depending on the macro return value, the debugger does one of the following actions:
 - If the macro return value is true (nonzero), the debugger resumes execution with the next instruction after the instruction that caused the read or write to the memory location. No breakpoint information is displayed.
 - If the macro return value is false (zero), the debugger returns to command mode and displays breakpoint information.
- 3 Returns to command mode if no macro was attached and displays breakpoint information.

Interaction with trace commands

The Breakpt Access and Trace Trigger commands both use emulation analyzer resources. If access breakpoints are active (indicated by *TRC: BrkRWA* on the status line), then a Trace Trigger command may not be entered. If a trace trigger is active, a Breakpt Access command may not be entered.

Note

If a trace is started using the emulator interface, debugger read/write/access breakpoints will be disabled until the trace has been completed. Do not use the debugger read/write/access breakpoints and the emulator interface trace specification feature at the same time.

The Breakpt Access command sets up a trace with the trigger at the end of the trace buffer, using the current storage qualification. You can display the trace after the break occurs to see the cycles leading up to the break.

See Also

Breakpt Clear_All	Breakpt Write
Breakpt Delete	Program Run
Breakpt Instr	Program Step
Breakpt Read	

Examples

To set a breakpoint on accesses of addresses 'assign_vectors' through 'assign_vectors' + 16:

```
Breakpt Access &assign_vectors..+16
```

To set a breakpoint on access of the address of the variable 'current_temp':

```
Breakpt Access &current_temp
```

To stop program execution when the value of variable `system_running` is set or read as TRUE:

```
Breakpt Access &system_running; when (system_running==1)
```

The predefined macro 'when' is executed when the breakpoint is encountered.

Breakpt Clear_All



The Breakpt Clear_All command clears (removes) all defined breakpoints.

See Also

Breakpt Access	Breakpt Write
Breakpt Delete	Program Run
Breakpt Instr	Program Step
Breakpt Read	

Examples

To remove all defined breakpoints:

```
Breakpt Clear_all
```

Breakpt Delete

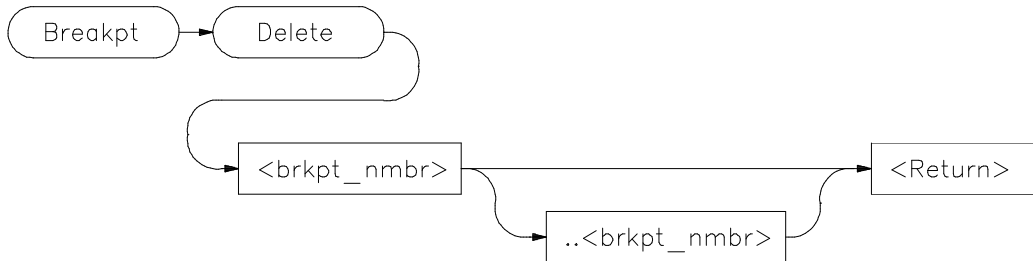

The Breakpt Delete command deletes (removes) one or more previously set breakpoints. When you set a breakpoint, the debugger assigns it a breakpoint number. Use this breakpoint number (<brkpt_nmbr>) to remove a specific breakpoint. You can delete a group of breakpoints by specifying a range of breakpoint numbers (<brkpt_nmbr> ..<brkpt_nmbr>). The debugger displays the breakpoint numbers in the Breakpoint window.

When you remove a breakpoint, the Breakpoint window displays the remaining breakpoints. Any breakpoints following the one removed are renumbered.

See Also

Breakpt Access	Breakpt Write
Breakpt Clear_All	Program Run
Breakpt Instr	Program Step
Breakpt Read	

Examples

To delete breakpoint number 2:

```
Breakpt Delete 2
```

To delete breakpoint numbers 3 through 5:

```
Breakpt Delete 3..5
```

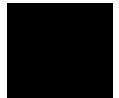

Breakpt Force_HW

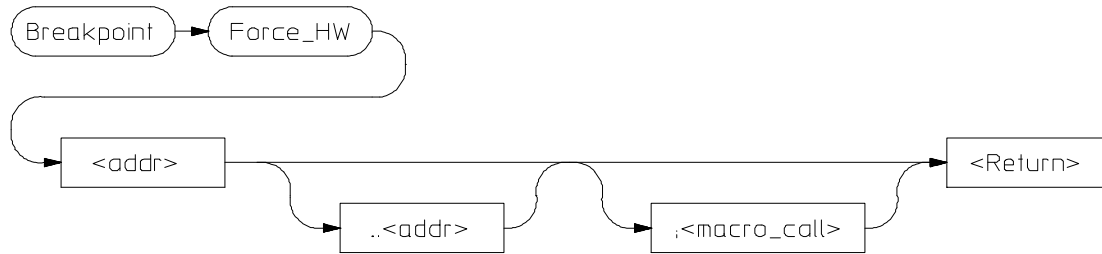

64783523

The Breakpt Force_HW command sets a hardware-assisted breakpoint at a specified memory location (< addr>) or range (< addr> ..< addr>).

Use this command if you need to *force* the use of a hardware-assisted breakpoint. The Breakpt Instr command automatically sets hardware-assisted breakpoints for target ROM.

You can attach a macro to a breakpoint using the optional < macro_call> parameter. See the “Using Macros and Command Files” chapter.

See Also

Breakpt Instr

Breakpt Instr

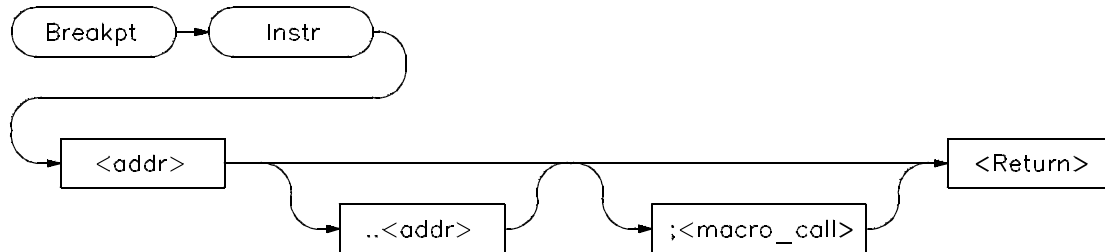

The Breakpt Instr command sets an instruction breakpoint at a specified memory location (< addr>) or range (< addr> ..< addr>). The instruction breakpoint halts program execution each time the target program attempts to execute an instruction at the specified memory location(s). If you specify a range, the debugger sets breakpoints on the first byte of each instruction within the specified range or (in high-level mode) the first instruction of each line within the range.

If you set a breakpoint for an overloaded C++ function, the debugger will ask you to choose which definition of the function to use. You can also specify the argument type of the function definition in parentheses after the function name in the Breakpt Instr command.

The debugger will set a hardware-assisted breakpoint on address locations in target ROM.

You can attach a macro to a breakpoint using the optional < macro_call> parameter. See the “Using Macros and Command Files” chapter.

The debugger performs the following actions when it encounters an instruction breakpoint:

- 1 Suspends program execution before the program executes the instruction at the breakpoint address.
- 2 Executes a macro (if you attached one when you set the breakpoint). Depending on the macro return value, the debugger does one of the following actions:

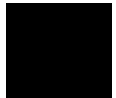

Chapter 12: Debugger Commands

Breakpt Instr

- If the macro return value is true (nonzero), the debugger resumes execution starting at the instruction where the break occurred. No breakpoint information is displayed.
 - If the macro return value is false (zero), the debugger returns to command mode without executing the instruction where the break occurred and displays breakpoint information.
- 3 Returns to command mode without executing the instruction where the break occurred if no macro was attached and displays breakpoint information.

See Also

Breakpt Access	Breakpt Write
Breakpt Clear_All	Program Run
Breakpt Delete	Program Step
Breakpt Read	

Examples

To set an instruction breakpoint at line 82 of the current module:

```
Breakpt Instr #82
```

To set an instruction breakpoint at line 83 of the current module only when the system is running (using the predefined macro 'when'):

```
Breakpt Instr #83; when (system_running)
```

To set an instruction breakpoint starting at address 10deh and ending at address 10e4h:

```
Breakpt Instr 10deh..10e4h
```

To set instruction breakpoints beginning on lines 15 through 25 of module 'initSystem':

```
Breakpt Instr initSystem\#15..#25
```

Breakpt Read

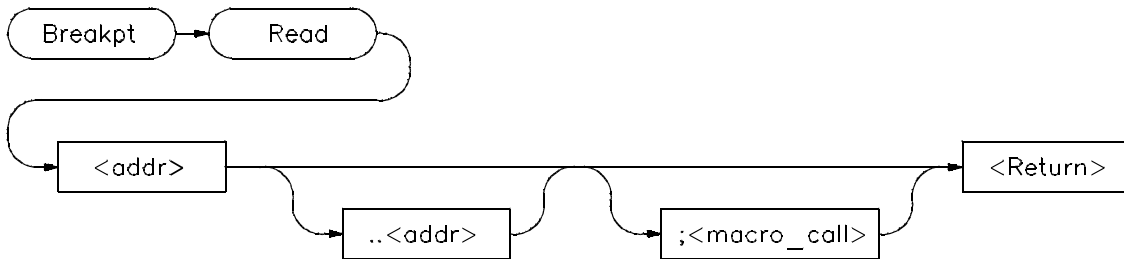

The Breakpt Read command sets a read breakpoint. The read breakpoint halts program execution each time the target program attempts to read data from the specified memory location (< addr>) or range (< addr> ..< addr>).

The Breakpt Read command behaves just like the Breakpt Access command.

See Also

Breakpt Access

Examples

To set a breakpoint on reads from variable 'system_running':

```
Breakpt Read &system_running
```

To set a read breakpoint starting at the address of variable 'current_temp' and ending 8 bytes after the address of 'current_temp':

```
Breakpt Read &current_temp..+8
```

To stop program execution when the value of variable system_running is read as TRUE:

```
Breakpt Read &system_running; when (system_running==1)
```

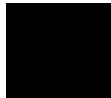

Breakpt Write

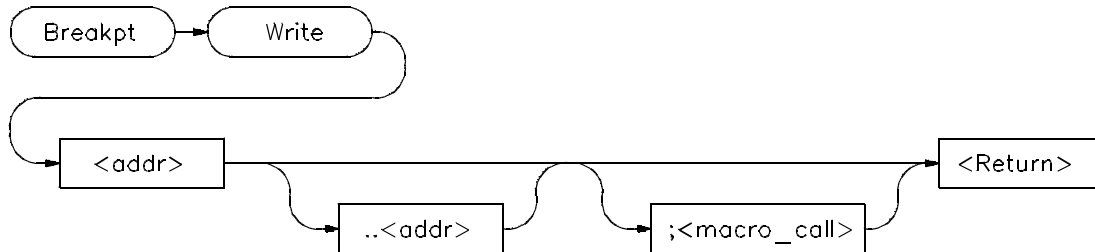

The Breakpt Write command sets a write breakpoint. The write breakpoint halts program execution each time the target memory attempts to write data to the specified memory location (< addr>) or range (< addr> ..< addr>).

The Breakpt Read command behaves just like the Breakpt Access command.

See Also

Breakpt Access

Examples

To set a breakpoint to occur when the program writes a false value to variable 'system_is_running':

```
Breakpt Write &system_running; when (system_running==00)
```

To set a write breakpoint starting at the address of global variable 'current_temp' and ending 8 bytes after the address of 'current_temp':

```
Breakpt Write &current_temp..+8
```

Debugger Directory

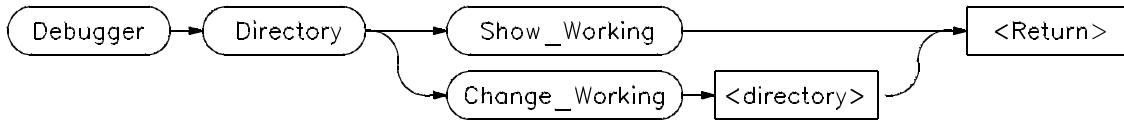

The Debugger Directory command displays or changes the current working directory. When you specify the *Show_Working* parameter, the debugger displays the current working directory in the journal window. When you specify the *Change_Working* parameter with a directory name, the debugger makes that directory the current working directory.

Changing the working directory will change the current working directory in all interfaces connected to the emulator.

Examples

To display the current working directory:

```
Debugger Directory Show_Working
```

To change the current working directory to /users/project/sources:

```
Debugger Directory Change_Working /users/project/sources
```

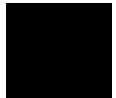

Debugger Execution Display_Status

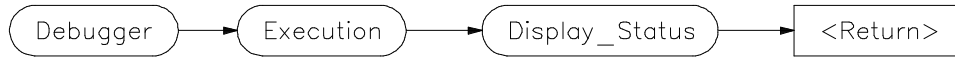

The Debugger Execution Display_Status command activates the debugger View window and displays the following status information:

- Version of debugger
- Current working directory
- Current log file
- Current journal file
- Startup file used in current debug session
- Loaded absolute files

If no files have been loaded, the absolute file will be missing from the display. If multiple executable files have been loaded using the Program Load Append command, they will be displayed in the View window. You may need to toggle the window (click on the window border) to see all of the files.

Example

To display product version, current working directory, and current log, journal, startup, and absolute files in the View window:

```
Debugger Execution Display_Status
```

Debugger Execution Environment FwdCmd

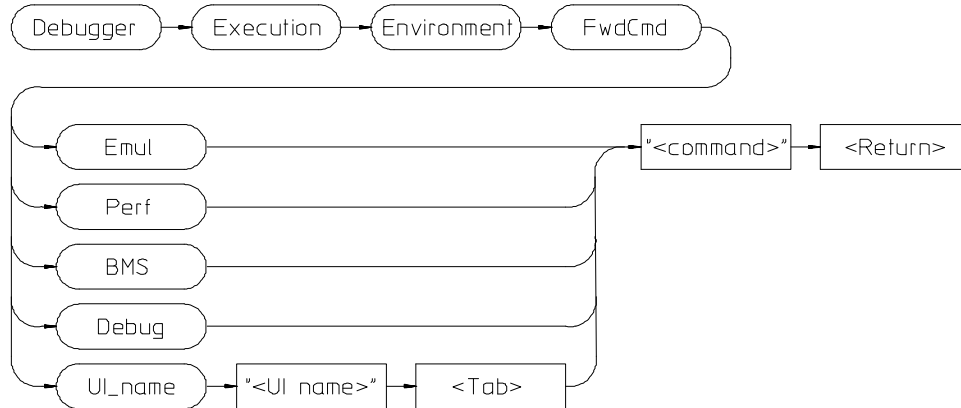

The Debugger Execution Environment FwdCmd command enables you to forward commands to other interfaces which are using the same emulator.

The other interfaces are:

Emul	Emulator/analyzer interface. If several emulator interfaces are sharing the emulator, the command will be forwarded to the most recently started interface.
Perf	Software Performance Analyzer.
BMS	Broadcast Message Server (the Softbench Gateway).
Debug	Debugger. This sends a command back to the debugger you are using.
UI_name	An interface described by a string. The command will be forwarded to an interface specified by a debugger or target string array (char *).

If an interface of the type specified is currently running, the < command> will be executed there and any errors will be displayed in that interface.

See Also Predefined macro "cmd_forward".

Debugger Execution Environment Load_Config

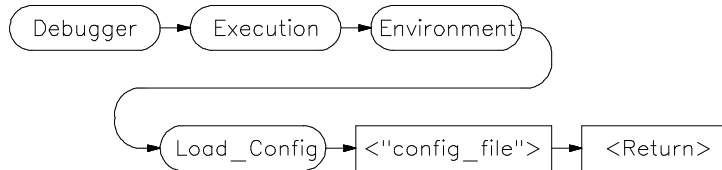

The Debugger Execution Environment Load_Config command loads an emulation configuration file for the emulator. The emulation configuration file contains configuration information for the emulator. The debugger/emulator accepts files generated by the emulation software or by an editor.

Note

You cannot use tilde expansion when specifying emulator configuration files with the *Debugger Execution Environment Load_Config <"config_file">* command because the configuration file name must be enclosed in quotation marks. However, you may use shell environment variables.

See Also

The "Configuring the Emulator" chapter for detailed information on the modify configuration command.

Example

To load the emulation configuration file "mycnfig" (from within the debugger):

```
Debugger Execution Environment Load_Config "mycnfig"
```

Or, if "mycnfig" is in another directory:

```
Debugger Execution Environment Load_Config  
"$HOME/project/mycnfig"
```



Debugger Execution Environment Modify_Config



The Debugger Execution Environment Modify_Config command starts a process which allows you to modify the current emulator configuration.

See Also

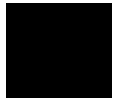
The “Configuring the Emulator” chapter in this manual.



Debugger Execution IO_System

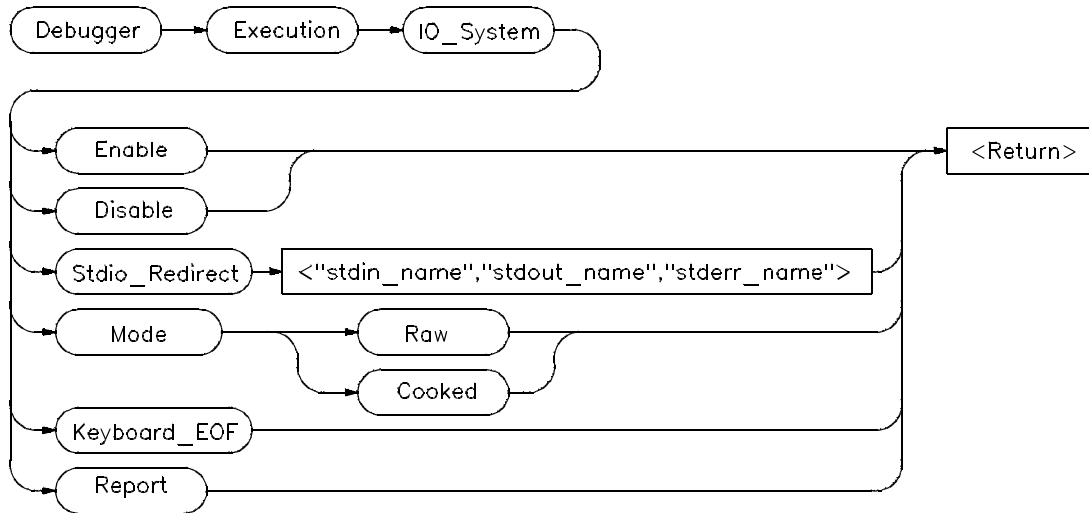

The Debugger Execution IO_System command enables you to configure the simulated I/O system to use the host system keyboard, display, and file system to simulate I/O devices for your target program.

Debugger Execution IO_System Enable

The Debugger Execution IO_System Enable command enables the debugger simulated I/O system. Remember, you also need to configure the emulator for simulated I/O polling and addresses.

Debugger Execution IO_System Disable

The Debugger Execution IO_System Disable command disables the debugger simulated I/O system.

Debugger Execution IO_System Stdio_Redirect

The Debugger Execution IO_System Stdio_Redirect command allows you to define the standard I/O input (< stdin_name >), output (< stdout_name >), and error (< stderr_name >) files/devices. These are file/device names in the

host computer file system. Two special filenames allow you to access the system keyboard (/dev/simio/keyboard) and the system display (/dev/simio/display).

Debugger Execution IO_System Mode

The Debugger Execution IO_System Mode command selects how keyboard I/O input is processed. Keyboard I/O may be either cooked or raw.

Cooked Mode. In cooked mode, the target program gets input from the keyboard in the form of lines. Editing operations, such as backspace, line kill, etc., on input is done by the debugger. When **Return** or **CTRL D** is entered, the line is passed to the target program by the simulated I/O system. The keyboard input is echoed to the screen during the editing operation. If program execution is interrupted by entering **< Ctrl> -C** before the line is entered, the characters on the input line are lost.

Raw Mode. In raw mode, each keystroke is passed from the keyboard to the simulated I/O system with no processing. No carriage return is needed to enter characters and no editing operations are available. In the raw mode any character is valid, including *CTRL D*. No characters are echoed to the screen upon entry. The only special character that cannot be sent to the target program is **< Ctrl> -C** which is used to interrupt the debugger's execution of the program.

Debugger Execution IO_System Keyboard_EOF

The Debugger Execution IO_System Keyboard_EOF command causes the keyboard to return EOF (end of file). The keyboard stream is marked as being at EOF. Further reads from the keyboard return EOF.

Debugger Execution IO_System Report

The Debugger Execution IO_System Report command displays the status of the simulated I/O system.

See Also

The "Using Simulated I/O" section in the "Viewing Code and Data" chapter. The "Environment-Dependent Routines" chapter in the *68030/040 C Cross Compiler Reference* manual.

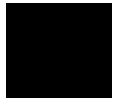

Chapter 12: Debugger Commands

Debugger Execution IO_System

Examples

To enable simulated I/O:

```
Debugger Execution IO_System Enable
```

To disable simulated I/O:

```
Debugger Execution IO_System Disable
```

To redirect the standard input file to the keyboard, the standard output file to the display, and the standard error file to file '/users/project/errorfile':

```
Debugger Execution IO_System Stdio_Redirect  
"/dev/simio/keyboard", "/dev/simio/display",  
"/users/project/errorfile"
```

To redirect the standard input file to 'temp.dat', the standard output file to 'cmdout.dat', and the standard error file to file 'errorlog.err':

```
Debugger Execution IO_System Stdio_Redirect  
"temp.dat", "cmdout.dat", "errorlog.err"
```

To set data input mode to cooked:

```
Debugger Execution IO_System Mode Cooked
```

Debugger Execution Load_State

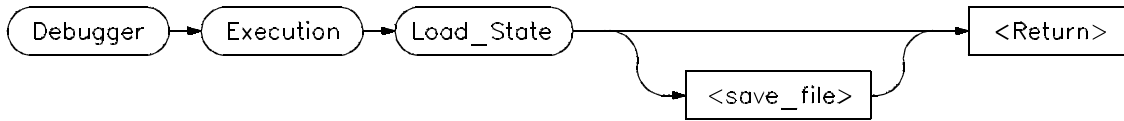

The Debugger Execution Load_State command restores the memory contents and register values saved with the debugger/simulator Debugger Execution Save_State command. If you do not specify a file name (< save_file>), the debugger uses the default file *db68k.sav*.

Example

To restore memory contents and register values saved in save file "session1":
Debugger **E**xecution **L**oad_State session1

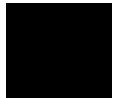

Debugger Execution Reset_Processor

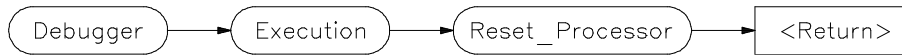

This command resets the microprocessor to its initial state. It does the following:

- 1 The program counter is loaded from exception vector 1 at location 4 in memory.
- 2 The interrupt stack pointer is loaded from exception vector 0 at location 0 in memory.
- 3 The status register is reset as follows;
 - the trace bits are cleared,
 - the supervisor bit is set to 1,
 - the master bit is set to 0,
 - the interrupt priority mask is set to level 7.
- 4 All other bits in the status register are set to 0.
- 5 The vector base register is set to 0.
- 6 The cache control register is set to 0.
- 7 Any pending interrupt or exception is cleared.
- 8 Registers A0-A6 and D0-D7 are set to 0.
- 9 The emulator breaks into the emulation monitor.

Note This command does not re-initialize memory. Use the **Program Load New Code_Only** command to reset C variables.

See Also Program Pc_Reset

Example To reset the microprocessor:
`Debugger Execution Reset_Processor`

Debugger Host_Shell

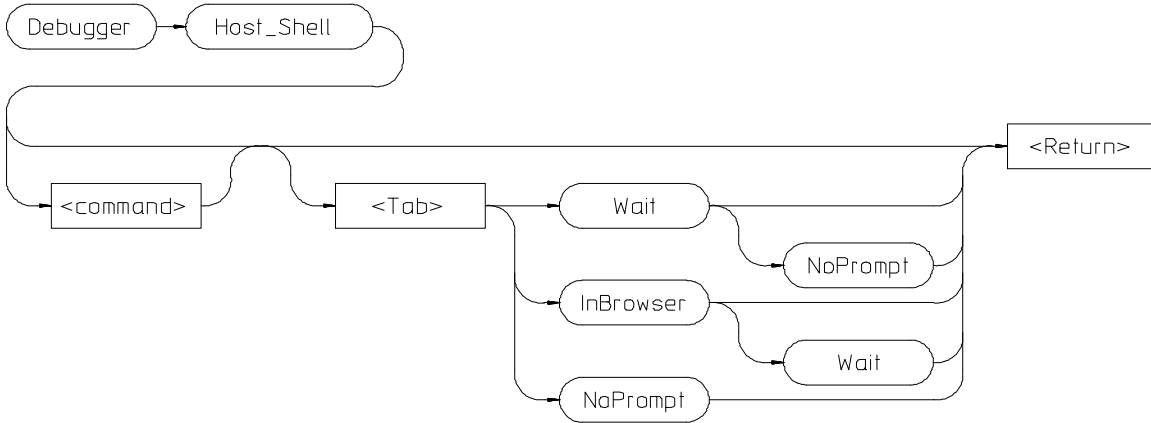

The Debugger `Host_Shell` command enables you to temporarily leave the debugging environment by forking an operating system shell or to execute a single UNIX operating system command from within the debugger. The type of shell forked is based on the shell variable `SHELL`. In this mode, you may enter operating-system commands. To return to the debugger, enter **CTRL D** or type **exit** and press the **Return** key.

You can execute operating system commands from within the debugger by entering a single operating system command with the debugger `Debugger Host_Shell` command. If you are using the graphical interface, the operating system command is executed in a "cmdscript" window. Press **< Return >** to close the window. If you are using the standard interface, `stdout` from the command is written to the Journal window and `stderr` is not captured. Commands writing to `stderr` will corrupt the display. Interactive commands **cannot** be used in this mode.

The following options are available only in the graphical user interface:

InBrowser

Directs `stderr` and `stdout` of the command into text browser windows.

Chapter 12: Debugger Commands
Debugger Host_Shell

Wait

Suspends the interface until the command completes.

NoPrompt

When the command completes, the "cmdscript" window is closed immediately.

See Also

Debugger Quit

Examples

To temporarily exit the debugger to the UNIX operating system command mode:

```
Debugger Host_Shell
```

To write the current working directory to the journal window:

```
Debugger Host_Shell pwd
```

Debugger Help



This command displays the on-line help screen. The debugger provides on-line help for all debugger commands, debugger command arguments, and debugger function keys. You can access on-line help by entering the command **Debugger ?** or by pressing the **F5** function key.

If you are using the graphical interface, a Help dialog box will be displayed. If you are using the standard interface, a menu will appear in the display area.

If you enter the command *Debugger ?* in the standard interface, the debugger puts the cursor at the top of the topic list in the help menu. If you press the **F5** function key, the debugger puts the cursor at the entry for the command displayed on the command line (if one is displayed). Otherwise, the cursor is positioned at the top of the topic list. You can select topics from the help menu in two ways:

- Use the cursor keys to move to the desired topic and press the **Return** key.
- Type the first letter of the desired topic. This positions the cursor at that topic. Then press the **Return** key.

Use the **Return** key to see more topics in alphabetical order.

To exit help in the standard interface, press the **Esc** (escape) key twice or press function key **F5**.

Example

To display the debugger help screen:

`Debugger ?`

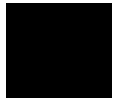

Debugger Level

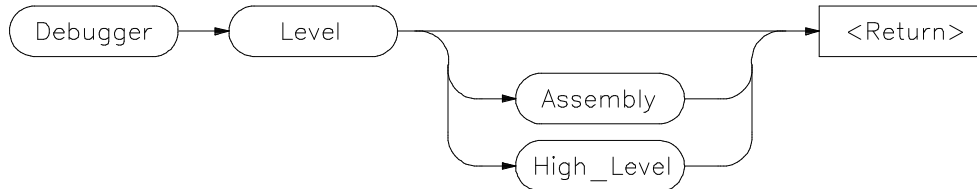

The `Debugger Level` command selects either high-level mode or assembly-level mode for debugging. When debugging programs containing C modules, you can switch back and forth between the two modes. If the program contains no high-level modules accessible to the debugger, the debugger displays an error message if you attempt to select high-level mode.

If no parameters are specified with this command, the mode is switched back and forth between the two modes, performing the same function as the `F3` function key.

Examples

To select the assembly-level debug mode:

```
Debugger Level Assembly
```

To select the high-level debug mode:

```
Debugger Level High_Level
```

To switch to the alternate debug mode:

```
Debugger Level
```

Debugger Macro Add

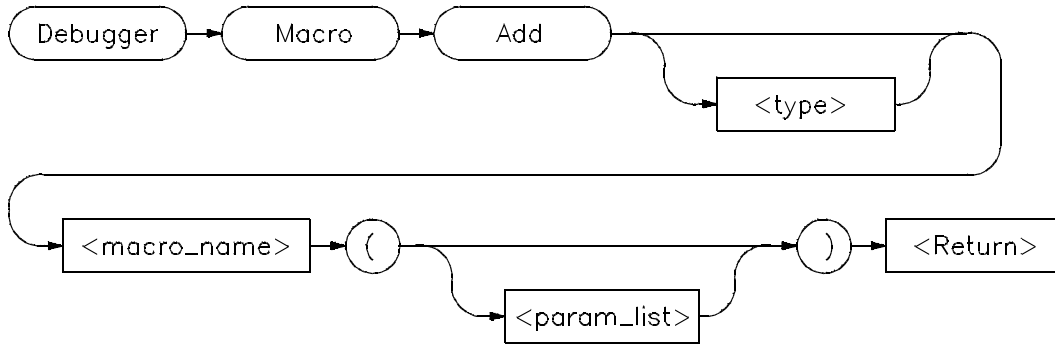

The Debugger Macro Add command defines a macro.

The name of the macro is specified by *<macro_name>*. The result type of the macro is specified by *<type>*. If a type is not specified, it defaults to type `int`. A parenthesized list of parameters (*<param_list>*) may optionally follow the macro name. Parameter names must be composed of alphanumeric characters. A maximum of 40 parameters is allowed.

When you enter the Debugger Macro Add command, the Journal window is automatically enlarged, and the debugger displays the macro text prompt character (`>`) indicating that you can enter the macro body.

Note

If the `stdio` screen or a user-defined screen is active when the Debugger Macro Add command is issued, the Journal window will not become active. Keyboard input at this point will be interpreted by the debugger as the macro definition.

To terminate the macro definition, a period (`.`) must be entered as the first and only character on a line.

The macro definition consists of all lines entered after the macro name and before the terminating period. The macro definition consists of the source lines of the macro (the macro body) and optional formal arguments. The syntax for the macro body is:

```
{macro_statement; [macro_statement;]...}
```

Chapter 12: Debugger Commands

Debugger Macro Add

The curly braces ({ }) are required punctuation. Formal arguments can be used throughout the macro definition, and are later replaced by the actual arguments in the macro call.

The maximum number of characters that can be entered on a line in a macro definition is 255. When entering macros interactively, the debugger does not respond to more than 78 characters on a line. When reading a command file, the debugger stops recognizing characters after 255 characters have been read on a line.

The maximum number of lines allowed in a macro depends on the complexity of the lines. Macros with too many lines (too complex) will fail. Error 92 "*Not enough memory for expression*" will be displayed.

A macro is similar to a C function. The body can contain any legal C statement (except the SWITCH and GOTO statements). The statements IF, ELSE, DO, WHILE, FOR, RETURN, BREAK, and CONTINUE can be used to control program flow within a macro, just as in C. Macros have return types and can be used in expressions.

Note

Debugger commands may be used in macro definitions; they are indicated by placing a dollar sign (\$) at the beginning and the end of a command sequence. For example, the following command sequences are legal in macro definitions:

```
$Program Find_Source Occurrence Forward system$;
    or
$
Memory Assign Long &time=12
Program Find_Source Occurrence Forward system
$;
```

Macros can be executed by specifying the macro name on the command line in a Debugger Macro Call command, in an expression, or with a breakpoint command.

Macros can be removed using the command:

```
Symbol Remove <macro_name>
```

See Also

Breakpt Access
Breakpt Instr
Breakpt Read
Breakpt Write

Debugger Macro Call
Debugger Macro Display
Program Run
Symbol Remove
The “Using Macros and Command Files” chapter
The “Predefined Macros” chapter in this manual.

Example

```
Debugger Macro Add int power(x, y)
int    x;
int    y;
{
    int    i;                /* Loop counter */
    int    multiplier;       /* Value x is multiplied by */

    /* Multiply x by itself y -1 times */
    for (i = 1, multiplier = x; i < y; i++)
        x *= multiplier;

    /* Return x ^y */
    return x;
}
.
```

```
Debugger Macro Add void stackchk()
{
    /* The symbols 'stack' and 'TopOfStack' exist in the compiler's */
    /* environment library, and are addresses which indicate the    */
    /* bottom and the top of the system stack. The symbol @sp is a  */
    /* debugger reserved symbol which contains the current value of */
    /* the processor's stack pointer.                                */
    /*                                                              */

    $Expression Printf "%d bytes of stack used", TopOfStack - @sp$;
    $Expression Printf "%d bytes of stack available", @sp - stack$;
}
.
```

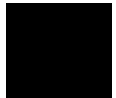

Debugger Macro Call



The Debugger Macro Call command calls a macro previously defined by the Debugger Macro Add command or a macro built into the debugger.

See Also

Debugger Macro Add
Debugger Macro Display
Symbol Remove

Example

To call the previously defined macro 'stackchk()':

```
Debugger Macro Call stackchk()
```



Debugger Macro Display

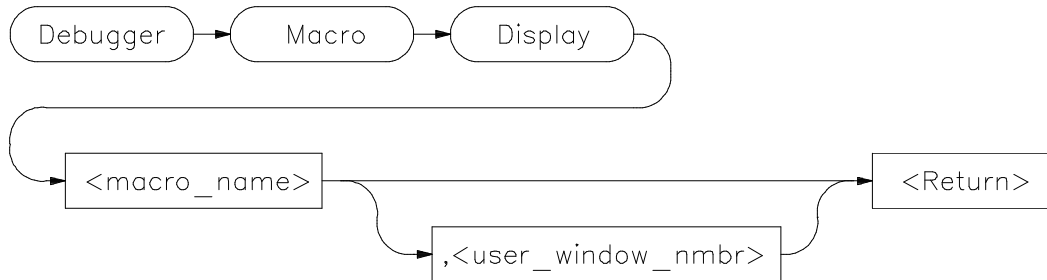

The Debugger Macro Display command displays the source code for the named macro. If a window number is specified (< user_window_nmbr >), the macro source is written to the file or user-defined window associated with the number. If you do not specify a window number, the macro source is written to the Journal window.

Macro source for built-in macros cannot be displayed.

See Also

Debugger Macro Add
File Command
Symbol Display

Examples

To display the source for macro 'stackchk' in user-defined window 57:

```
Debugger Macro Display stackchk,57
```

To display the source for macro 'stackchk' in the Journal window:

```
Debugger Macro Display stackchk
```

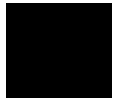

Debugger Option Command_Echo

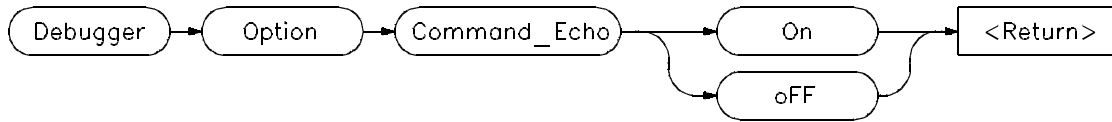

The Debugger Option Command_Echo command controls whether or not commands executed from a command file are echoed (copied) to the Journal window. If the *oFF* parameter is specified, only the results (if any) of a command are copied to the Journal window. If the *On* parameter is specified, both the command and its results (if any) are echoed to the Journal window. The default setting is *On*.

Examples

To turn OFF echo to the Journal window of commands executed from a command file:

```
Debugger Option Command_Echo oFF
```

To turn ON echo to the Journal window of commands executed from a command file:

```
Debugger Option Command_Echo On
```

Debugger Option General

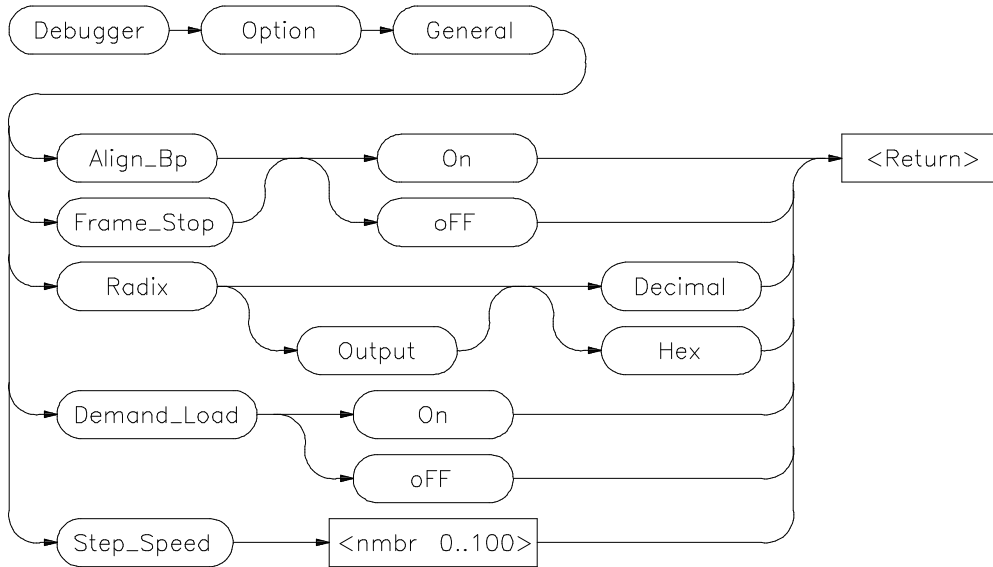

The Debugger Option General command changes the default values for the following debugger startup options for the current debugging session:

Align_Bp	Aligns breakpoints with processor instruction start
Frame_Stop	Controls stack walking
Demand_Load	Enables/disables demand loading of symbols
Radix	Interprets assembly-level numbers as decimal or hex
Step_Speed	Specifies the stepping speed

Use the Debugger Option List command to display the current option values.

To permanently change any option default values, first use the Debugger Option command to change the value(s) and then use the File Startup command to save the new default values in a startup file. See the File Startup command for more information.

Align_Bp

The `Align_Bp` option controls automatic alignment of low-level breakpoints and automatic alignment of disassembly. If the `Align_Bp` option is set to `On`, the debugger locates what it interprets as the starting address of all instructions in a module (by disassembling code from the beginning of the module). If you try to set the breakpoint at an address other than the start of an instruction, the debugger moves the breakpoint to the beginning of the next instruction and displays a warning. If you try to display memory mnemonically from an address other than the start of an instruction, the debugger moves the disassembly address to the beginning of an instruction. No Warning is displayed. If the `Align_Bp` option is set to `OFF`, the debugger lets you set the breakpoint at any address. The default setting is `OFF`.

Note

If multiple breakpoints exist in the same program area and `Align_Bp` is set to `On`, their alignment may be incorrect. Make sure the `Align_Bp` option is set to `OFF` to prevent breakpoint alignment problems.

Frame_Stop

When you set the `Frame_Stop` option to `On`, if the debugger encounters a bad stack frame, it displays only the valid stack frames below the bad frame in the Backtrace window. When you set the `Frame_Stop` option to `OFF`, the debugger displays all frames, including the bad frame. The default setting is `OFF`.

Demand_Load

When the `Demand_Load` option is set to `On`, the debugger loads some symbol information on an as-needed, demand basis rather than during the initial loading of the executable (.x) file. Symbol information for global symbols, local symbols in the source module containing main, and local symbols in assembly modules are loaded during the initial load of the executable file. Local symbols in C source modules other than that module which contains main are loaded when the debugger explicitly references the module or when the program is stopped with the program counter set to an address in the module. Demand loading lets you load and debug programs that you could not otherwise load because of very large amounts of symbol information. The default setting for `Demand_Load` is `OFF`.

There are several side effects of demand loading. The debugger command `Memory Unload_BBA` is disabled. Type mismatch errors may not be detected

during the initial load of the executable (.x) file. Global symbols may have leading underscores stripped, depending on whether they were defined or referenced in a C or assembly source module.

Radix

The radix option causes the debugger to interpret numeric literals, including integers and addresses, as either decimal or hexadecimal values. By default, numeric literals are interpreted as decimal values.

If you set *Radix* to hexadecimal, any number you want interpreted as decimal must be terminated with a *T* (for example, specify 32 as 32T).

Even if you select Hex, the following inputs will *not* be interpreted as hexadecimal: line numbers starting with "# ", variables in high-level expressions, and debugger variables including breakpoint numbers, viewport numbers, and data viewport line numbers. To cast a high-level expression as hexadecimal, use a leading "0x" or a trailing "h".

Binary numbers are not available when *Radix* is set to hexadecimal. Floating point and enumeration type values are not affected by the radix option.

The *Output* parameter lets you specify whether the output of the Expression Display_Value, Expression Monitor Value, and Program Context Expand command is displayed in decimal or hexadecimal format.

Step Speed

The Step_Speed option specifies the stepping speed. The stepping speed can be in the range of 0 to 100 units. Higher numbers represent slower speeds. This option affects the Program Step command. The default value is 0.

See Also

File Startup
Debugger Option List

Example

To align assembly-level breakpoints at the beginning of an instruction:

```
Debugger Option General Align_Bp On
```

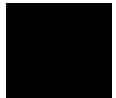

Debugger Option List



The Debugger Option List command lists the current debugger option values in the Journal window. The list will be similar to the sample list shown in the example.

See Also

Page 241 for an example of the list
Debugger Option Command_Echo
Debugger Option General
Debugger Option Symbolics
Debugger Option View
Settings→Debugger Options ...

Examples

To list the current debugger option settings in the Journal window:
`Debugger Option List`

Debugger Option Symbolics

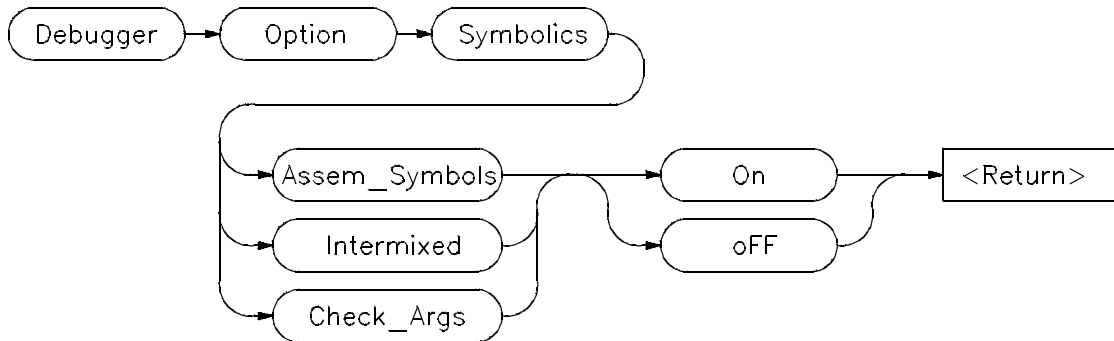

The Debugger Option Symbolics command changes the default values for the following debugger symbol options and C source line display options for the current debugging session:

- | | |
|---------------|---|
| Assem_Symbols | Displays symbols in assembly code |
| Intermixed | Intermixes C source with assembly code |
| Check_Args | Enables parameter checking in commands and macros |

Use the Debugger Option List command to display the current option values.

To permanently change any option default values, first use the Debugger Option command to change the value(s) and then use the File Startup command to save the new default values in a startup file. See the File Startup command for more information.

Assem_Symbols

The Assem_Symbols option causes symbols instead of memory addresses to be displayed in the disassembled code whenever possible. Symbol names are placed to the right of the disassembled code for immediate values. This is done because there is no sure way of telling if the immediate value was represented by the symbol at assembly time. This option is set to *On* by default.

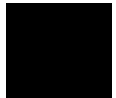

Chapter 12: Debugger Commands

Debugger Option Symbolics

Intermixed

The Intermixed option intermixes C source code with the assembly code generated for each respective C statement. This option is off by default.

Check_Args

The Check_Args option controls parameter checking in commands and macros. If *OFF* is selected, the debugger does not do any argument checking. If *On* is selected, the debugger warns you when an assignment is made which contains a C type mismatch. This option is off by default.

See Also

File Startup

Examples

To display symbol names instead of address values in disassembled code:

```
Debugger Option Symbolics Assem_Symbolics On
```

To turn OFF display of C source lines in assembly-level Code window:

```
Debugger Option Symbolics Intermixed OFF
```

To enable debugger expression parameter checking:

```
Debugger Option Symbolics Check_Args On
```

Debugger Option Trace

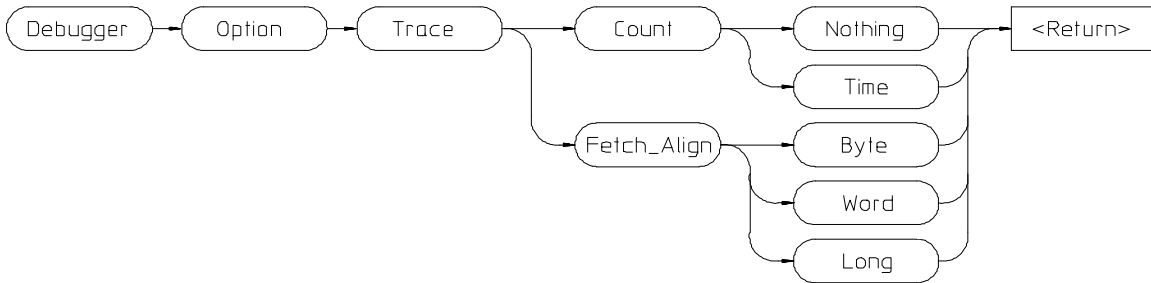

The Debugger Option Trace command changes the default behavior of bus-level tracing.

Count

If *Count* is *Nothing*, all of the trace memory will be used to store bus states.

If *Count* is *Time*, half of the trace memory will be used to store timing information.

The debugger interface does not display timing information. Use the emulator/analyzer interface to display timing.

Fetch_Align

The *Fetch_Align* option allows you to trigger a trace on an instruction's address which never appears on the bus. For example, this might happen when an instruction for a processor with a 32-bit bus lies between longword boundaries. The *Fetch_Align* operation masks address values so that they appear to occur on the boundaries appropriate for the processor's bus width.

See Also

Information about "equivalent addresses" in your analyzer manual.

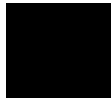

Debugger Option View

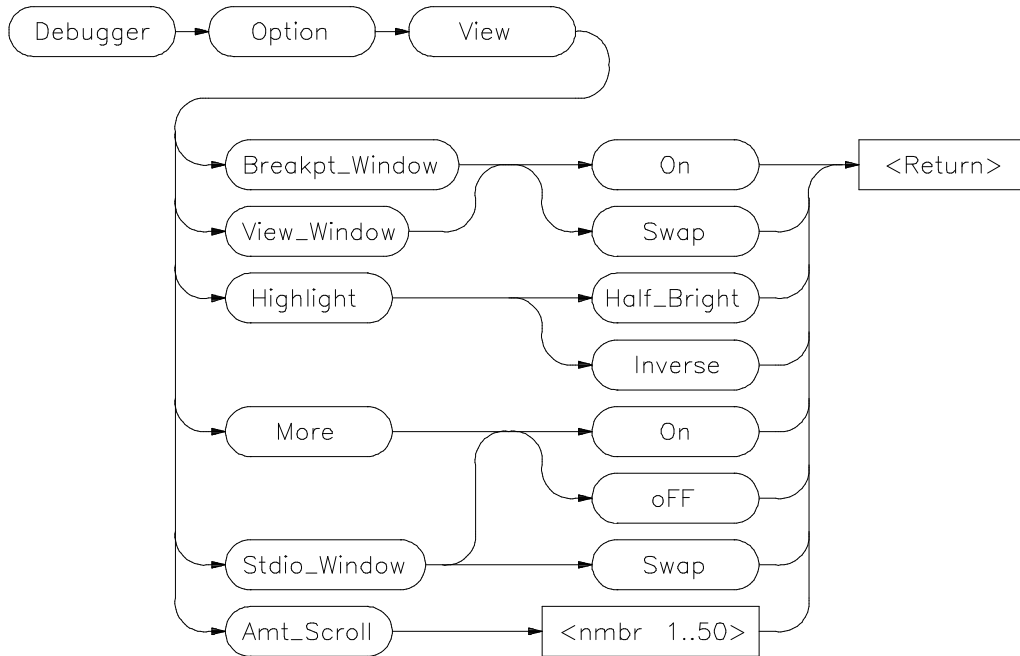

The Debugger Option View command changes the default values for the following debugger display options for the current debugging session:

- Breakpt_Window
- View_Window
- Highlight
- More
- Stdio_Window
- Amt_Scroll

Use the Debugger Option List command to display the current option values.

To permanently change any of the default values, first use the appropriate Debugger Option command to change the value(s) and then use the File Startup command to save the new default values in a startup file. See the File Startup command for more information.

Breakpt_Window

The `Breakpt_Window` option controls the display of the breakpoint window.

The `On` setting causes the Breakpoint window to be displayed at all times. The window may be hidden by other windows but will be displayed whenever a breakpoint is set or deleted.

If you specify the `Swap` setting, the window is not automatically displayed. You must set or delete a breakpoint or enter the Window Active Breakpoint command to display the window. The default setting is `Swap`.

View_Window

The `View_Window` option controls the display of the view window.

The `On` setting causes the View window to be displayed at all times. The window may be hidden by other windows but will be displayed whenever a Debugger Execution Display_Status command is executed.

If you specify the `Swap` setting, the window is not automatically displayed. You must enter the Debugger Execution Display_Status command or the Window Active View command to display the window. The default setting is `Swap`.

Highlight

The Highlight option determines whether highlighted information in debugger windows is displayed in half-bright video or inverse video. The default is Inverse.

More

The More option controls how information resulting from a debugger command is listed to the Journal window.

If the More option is `On`, information is listed one screen at a time in the Journal window, in the same way as the more command in the Unix operating system works.

If the More option is `OFF`, all information resulting from a debugger command is written to the display at once, making it difficult to view information greater than the number of lines available in the Journal window. The default setting is `On`.

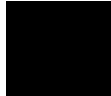

Stdio_Window

The Stdio_Window option controls the display of the Stdio window.

The *Swap* setting causes the Stdio window to be displayed when a program writes to it and to be removed when the program returns to the command mode.

The *On* setting causes the Stdio window to be displayed at all times. The window may be hidden by other windows but will be displayed when a program is writing to it.

If the *OFF* setting is selected, the window is not automatically displayed. You must press function key **F6** or enter the command **Window Screen_On Stdio** to display the window.

The default setting is *Swap*.

Amt_Scroll

The Amt_Scroll option controls the amount that the Journal and Stdio windows are scrolled when written to. When the output reaches the bottom of the window, the data scrolls up one line by default. You can specify a number of lines from one to 50.

Examples

To set the Swap option so that the Breakpoint window is displayed only when the Window Active Breakpoint command is executed:

```
Debugger Option View Breakpt_Window Swap
```

To set the View_Window option so that the view window is always displayed:

```
Debugger Option View View_Window On
```

Debugger Pause

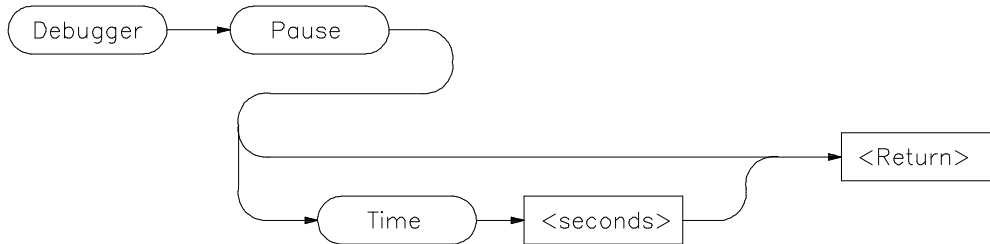

The Debugger Pause Time command pauses the debugger for the specified number of seconds or (if you enter the Debugger Pause command without the Time parameter) pauses the debugger until you press the space bar, **CTRL C**, or the escape key (**Esc**) twice. The Debugger Pause command is useful when executing command files.

See Also File Command

Examples To pause the debugger for ten seconds:

```
Debugger Pause Time 10
```

To pause the debugger until the space bar, CTRL C, or Esc-Esc is pressed:

```
Debugger Pause
```

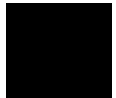

Debugger Quit

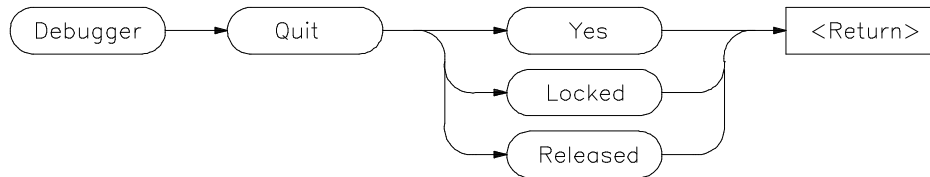

The Debugger Quit command ends a debugging session without saving the session. If you enter the command *Debugger Quit Yes*, the debugging session is immediately ended.

The Debugger Quit command does not save the debugging session. Use the File Startup command to save the current set of debugger startup options and window parameters in a startup file.

Yes Option

The Yes option terminates only this interface to the emulator. If this is the only interface using the emulator, the emulator will be left locked.

Locked Option

The Locked option lets you lock the emulation hardware (and a connected target system) so that other users cannot access the hardware until it is explicitly released.

This option will cause all interfaces connected to the emulator to disconnect.

Released Option

The Released option releases the emulation hardware to other users on the host computer system.

This option will cause all interfaces connected to the emulator to disconnect.

See Also

Debugger Host_Shell

Examples

To terminate the debugging session immediately:

`Debugger Quit Yes`

To terminate the debugging session and release the emulator hardware so that other users can access it:

`Debugger Quit Released`

To terminate the debugging session and lock the emulator hardware so that other users cannot access it:

`Debugger Quit Locked`



Expression C_Expression

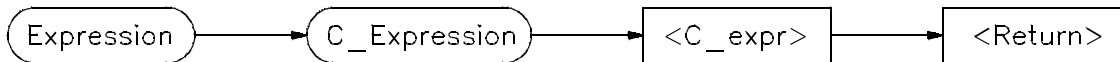

The Expression C_Expression command calculates the value of most valid C expressions or assigns a value to a variable. The result is displayed in floating point or in decimal, hexadecimal, and ASCII formats.

The Expression C_Expression command can be used to set C variables by specifying a C assignment statement. This command recognizes variable types, and the assignment expressions specified behave according to the rules of C.

Note

The Expression C_Expression command cannot evaluate conditionals of the form:

```
<expression>?<expression>:<expression>
```

Examples

To calculate the value of 'time' and display the result "data address 000091DC {time_struct}":

```
Expression C_Expression time
```

To calculate the value of member 'hours' of structure 'time' and display the result "4 0x04":

```
Expression C_Expression time->hours
```

To assign the value 1 to 'system_is_running' and display the result "1 0x01":

```
Expression C_Expression system_is_running = 1
```

Expression Display_Value

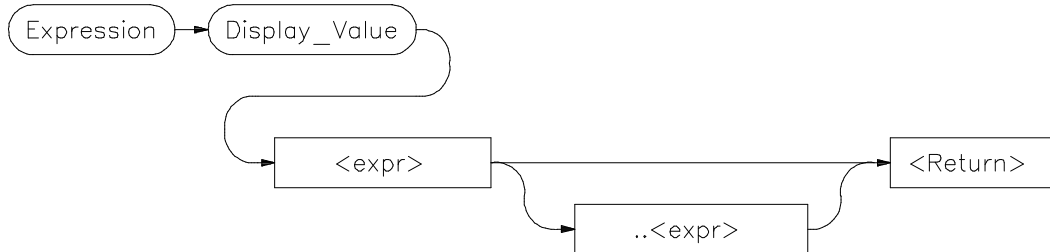

The Expression Display_Value command displays expressions and their values in the Journal window. All expressions displayed with this command are displayed according to their type as shown in the following list:

Type	Display Format
Ints	32-bit signed decimal numbers
Longs	32-bit signed decimal numbers
Shorts	16-bit signed decimal numbers
Chars	8-bit characters (unsigned hexadecimal numbers if not printable)
Pointers	32-bit unsigned numbers
Enums	Name of Enumerator constant (enumerator value if name not defined)
Arrays	All elements
Structures	All members
Quoted String	All characters as typed, in by double quotes (" ")
Hex Byte	8-bit hexadecimal
Hex Word	16-bit hexadecimal
Hex Double Word	32-bit hexadecimal
Float	32-bit floating point
Double	64-bit floating point

Note The contents of an item such as an array is displayed instead of the C value of the item, which is its address.

Chapter 12: Debugger Commands

Expression Display_Value

If an expression range is displayed, each value within the range is displayed according to the base type (if one exists). For example, if the variable *flags* is a character array, the following command results in elements *flags[10]* through *flags[30]* being displayed:

```
Expression Display_Value flags+10..+30
```

Note that the command first evaluates *flags[10]* to a character, and uses this as the base of the address range. *Flags[30]* is also evaluated to a character. It is used as the end of the address range.

Any expression can be type cast to display it in a different format. All values that make up a complex type are printed. For example, if the variable *count* is a long, the following statement displays it as a four-character array:

```
Expression Display_Value (char[4])&count
```

To display the contents of a character array as a string, cast the variable using the quoted string cast, as shown in the following example:

```
Expression Display_Value (Q S)buf
```

If the type of the expression is unknown, it defaults to type byte. See the “Expressions and Symbols in Debugger Commands” chapter for more information about type casting.

See Also

Expression Fprintf
Expression Monitor Value
Expression Printf
Memory Display

Examples

To display the value of the variable 'system_is_running': 01h

```
Expression Display_Value system_is_running
```

To display the address of the variable 'system_is_running': 000091F0

```
Expression Display_Value &system_is_running
```

To display the address of the C structure 'time': 000091DC

Expression Display_Value time

To display the values of the members of structure 'time':

hours 4
minutes 0
seconds 20

Expression Display_Value *time

To display the name of the current program module:

Expression Display_Value @module

To display the name of the current program function:

Expression Display_Value @function



Expression Fprintf

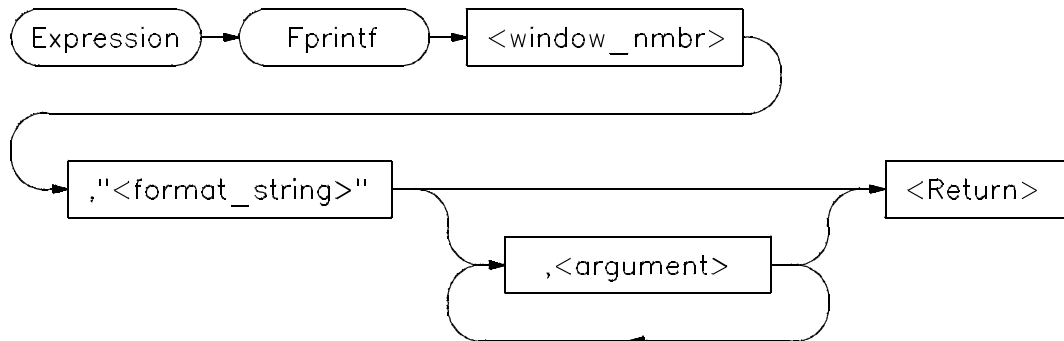

The Expression Fprintf command prints formatted output to the specified user-defined window. Formatted output may be written to a file that has been opened by the File User_Fopen command. The Expression Fprintf command is similar to the C fprintf function.

This command allows type conversions, scaling, and positioning of output in a file or in a window. The window number must have been previously assigned by a File User_Fopen or Window New command or the window number must be the log file number (28) or journal file number (29), if opened.

The command requires a format string as the second parameter. The format string may contain both text and argument conversion specifications. Whenever a conversion specification is encountered, the next argument is converted according to the specification, and the result is copied to the output window.

The conversion specifiers are similar to those in C and have the following format:

```
%[-] [digits] [.[digits]] [l] conversion_char
```

where:

% indicates the start of a conversion specification.

- indicates that the result of conversion is to be left-justified within the field.
- digits is a string of one or more decimal characters. The first *digits* is a minimum field width. The field will be at least this many characters wide, padded if necessary. The padding is normally on the left. When '-' is used, padding is on the right. The field is padded with blanks unless the first digit in *digits* is a 0; then the field is padded with zeros.
- separates two digit strings and must be specified if a second digit string is used.
- digits (second occurrence) is the maximum field width. For strings, it is the maximum number of characters to print; for f and e notations, it is the maximum number of fractional decimal places to print. For g notation, it is the number of significant digits to be printed.
- l indicates that a conversion character (d, x, or u) corresponds to a long argument.

Conversion Characters

Conversion characters are listed in the following table with a detailed description of each character.

Char	Description
c	The argument is converted to character format.
d	The argument is converted to decimal format.
e, E	The float or double argument is converted to the format $[-]d.ddde+dd$, where the number of digits after the decimal point is equal to the precision. If precision is zero, no decimal point is printed. The default precision is 6. The E conversion character produces a number with E instead of e introducing the exponent. The exponent always contains at least two digits.

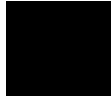

Chapter 12: Debugger Commands

Expression Fprintf

- f** The double argument is converted to decimal notation in the format `[-]ddd . ddd`, where the number of digits after the decimal point is equal to the precision specification. If the precision is not specified, it is 6 by default; if the precision is explicitly zero, no decimal point appears. If there is a decimal point, at least one digit appears before it.
- g, G** The double argument is printed in `f` or `e` notation, or in `F` or `E` notation when `G` is used. The precision specifies the number of significant digits. The notation used depends on the value converted; `e` or `E` notation will be used only if the exponent resulting from the conversion is less than `-3` or greater than or equal to the precision. Trailing zeros are removed from the result; a decimal point appears only if it is followed by a digit.
- h** The argument is either the debugger internal variable `@HLPC`, or a high level line number preceded by the `#` character. Source lines are formatted as strings according to `%s` rules. (Note: See `@HLPC` in the "Registers" chapter of this manual.)
- m** The argument is an instruction address. The disassembled instruction is treated as a string.
- s** The argument is a string. The characters from the string are copied to the output until a `NULL` character is encountered or the maximum number of characters specified have been printed.
- u** The argument is converted to unsigned decimal format.
- v** The argument is displayed according to its type.
- w** The argument is is a window number. The current contents of the window are written to the specified window.
- X** The argument is converted to hexadecimal. Letters are displayed in upper case. `0x` is not printed before the value.

- x The argument is converted to hexadecimal. Letters are displayed in lower case.

- % The character % is substituted for the field. Any other non-conversion character following a % is printed. %% is used to generate % in the output as a literal character.

Conversion characters are case-sensitive. Values printed in E notation have the following format:

`[-] d . d . . E { + | - } d d`

Each *d* represents a decimal digit. The number is first scaled so that one digit appears to the left of the decimal point. The number of digits in the fractional part is six by default, or the maximum field width if specified. The sign of the mantissa is printed only if the number is negative. The sign of the exponent is always printed.

Values printed in F notation have the following format:

`[-] d d . . .`

Each *d* represents a decimal digit. The number of digits in the fractional part is six by default or the maximum field width if specified. The number of digits printed depends on the number of significant digits in the number.

Because floating point values are passed as parameters, they are converted to double precision. Parameters must be promoted to double precision values as a requirement of the C language. Other values passed as parameters may also be converted.

The Expression Fprintf command uses the format string to decide how many arguments to print. The number of conversion specifications must equal the number of arguments. If there are too many arguments, some of them will not be printed. If there are too few arguments, the value printed cannot be determined.

If the argument type does not correspond to its conversion field specification, arguments may be converted incorrectly.

See the Expression Printf command for details about conversion specifiers.

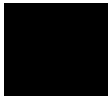

Chapter 12: Debugger Commands

Expression Fprintf

See Also

- Expression Printf
- File Journal
- File Log
- File User_Fopen
- Window New

Examples

To print value of 'var' to user window 57 as a single character:

```
Expression Fprintf 57,"%c",var
```

To print the string in double quotes to user window 57 followed by the floating point value of 'temperature' with a precision of 2:

```
Expression Fprintf 57,"The value of 'temperature' is:
%.2f \n",temperature
```

To print source line 24 to user window 55:

```
Expression Fprintf 55,"%h",#24
```

To print the contents of the assembly-level stack window to user window 256:

```
Expression Fprintf 256,"%w",14
```

Expression Monitor Clear_All

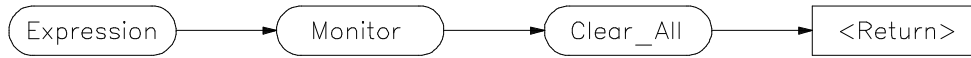

The Expression Monitor Clear_All command stops monitoring of all expressions being monitored with the Expression Monitor Value command and removes all expressions from the Monitor window.

See Also

Expression Fprintf
Expression Monitor Delete
Expression Monitor Value
Expression Printf
Memory Display

Examples

To stop monitoring all expressions:

```
Expression Monitor Clear_All
```

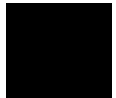

Expression Monitor Delete

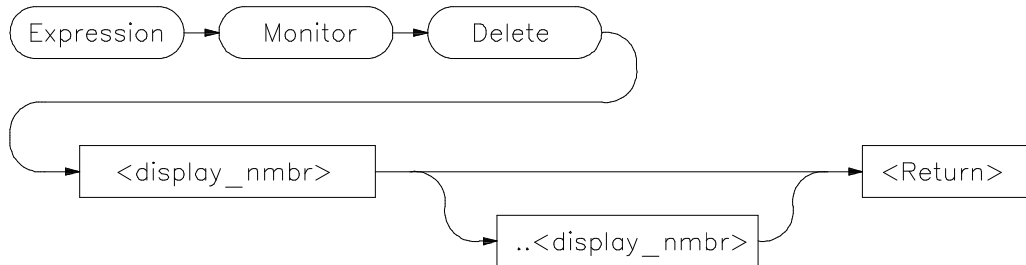

The Expression Monitor Delete command stops monitoring of specified expressions being monitored with the Expression Monitor Value command and removes those expressions from the Monitor window.

When an expression is monitored using the Expression Monitor Value command, it is assigned a line number, which is displayed in the Monitor window. These assigned line numbers are used to specify the expression or group of expressions to be deleted (removed). All monitored expressions can be deleted with the Expression Monitor Clear_All command.

See Also

Expression Fprintf
Expression Monitor Clear_All
Expression Monitor Value
Expression Printf
Memory Display

Examples

To stop monitoring expression 2 in the Monitor window:

```
Expression Monitor Delete 2
```

To stop monitoring expressions 3 through 6 in the Monitor window:

```
Expression Monitor Delete 3..6
```

Expression Monitor Value

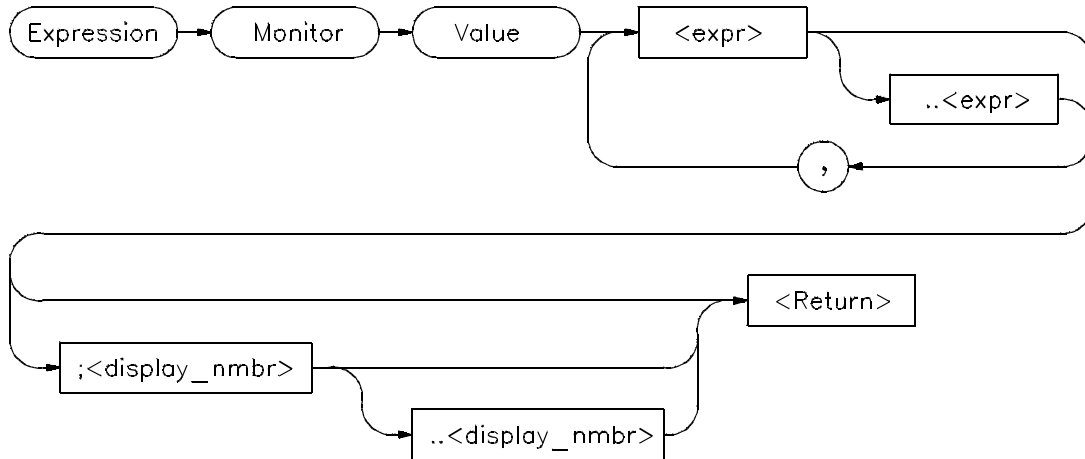

The Expression Monitor Value command monitors the specified expressions as the target program is executing. Expressions are updated and displayed in the Monitor window each time the debugger stops executing the program.

Up to seventeen lines, selected by the display line range parameter (`;< display_nmbr> ..< display_nmbr>`), can be displayed in the Monitor window.

Variables located in registers are shown with a ? between their names and values.

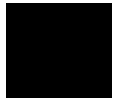

Chapter 12: Debugger Commands

Expression Monitor Value

All expressions monitored with this command are displayed according to their type as follows:

Type	Display Format
Ints	32-bit signed decimal numbers
Longs	32-bit signed decimal numbers
Shorts	16-bit signed decimal numbers
Chars	8 bit characters (unsigned hexadecimal numbers if not printable)
Pointers	32-bit unsigned numbers
Enums	Name of Enumerator constant (enumerator value if name not defined)
Arrays	All elements if enough lines, else first element
Structures	All members if enough lines, else first element
Quoted String	Characters surrounded by double quotes (" ")
Hex Byte	8-bit hexadecimal
Hex Word	16-bit hexadecimal
Hex Double Word	32-bit hexadecimal
Float	32-bit floating point
Double	64-bit floating point

If an expression range is displayed, each value within the range is displayed according to the base type (if one exists). For example, if the variable *flags* is a character array, the following command displays 20 characters.

```
Expression Monitor Value flags+10..+29
```

Any expression can be type cast to display its value in a different format. For example, if the variable *count* is a long value, the following statement causes *count* to be displayed as a four character array:

```
Expression Monitor Value (char[4])&count
```

If the type of the expression is unknown, it defaults to type byte.

Only 17 lines can be displayed in the data window. By default, a single line is used to display monitored expressions. If an array is monitored, only the elements that will fit on one line will be displayed. If a structure is monitored, only the first member will be displayed. To display an entire array or structure, a display line range may have to be specified. If all lines in the data window are

filled, you must use the Expression Monitor Delete command to delete an expression before monitoring another one.

If you do not specify a display line range, the next available line in the data window is selected to display the monitored variable. If you specify one line, the expression is displayed on that line. If you specify a range of lines, the amount of data that will fit on those lines is displayed.

See Also

Expression Monitor Clear_All
Expression Monitor Delete
Symbol Display

Examples

To monitor the value of variable 'current_temp':

```
Expression Monitor Value current_temp
```

To monitor the value of the three members in structure 'time' and display them on Monitor window lines 4 through 6:

```
Expression Monitor Value *time;4..6
```

To monitor the contents of string buf:

```
Expression Monitor Value (Q S)buf
```

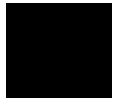

Expression Printf

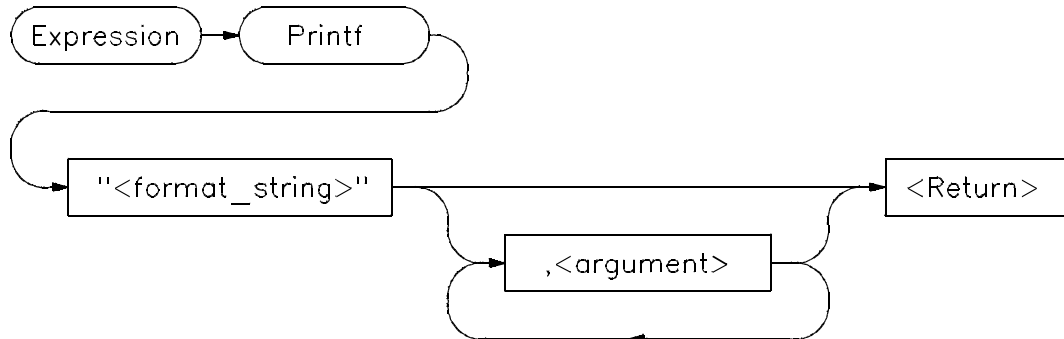

The Expression Printf command prints formatted output to the Journal window.

See the Expression Fprintf command for a detailed description.

See Also

Expression Fprintf
File User_Fopen

Examples

To print the string in double quotes to the journal window followed by the floating point value of 'temperature' with a precision of 2:

```
Expression Printf "The value of 'temperature' is: %.2f\n",temperature
```

To print source line 24 to the Journal window:

```
Expression Printf "%h",#24
```

To print the name of the current module to the Journal window:

```
Expression Printf "%s",@module
```

To print the disassembled instruction at address 2030h to the Journal window as a string:

```
Expression Printf "%m", 2030h
```

```
00002030 2040          MOVEA.L D0,A0
```

To print the contents of the assembly-level stack window to the Journal window:

```
Expression Printf "%w",14
```

```
> Expression Printf "%w",14  
    00043FC8=00000690  
FP->00043FC4=00043FF0  
    00043FC0=000604AC  
    00043FBC=00000001  
SP->00043FB8=00000001
```

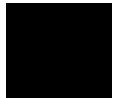

File Command

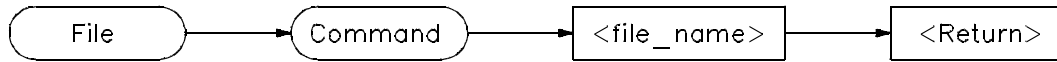

The File Command command reads the file specified by < file_name> and executes the commands contained in the file as though they were entered from the keyboard. Commands in the file are executed until the end of the file is reached. Input then continues from the previous source. The previous source can be the keyboard or another command file.

This command is commonly used to read macro definitions from a file, to set up I/O ports, or to change window displays.

File Command commands may be nested up to 16 levels deep.

If the filename consists of alphanumeric characters, a period, or a backslash, double quotation marks are optional. Otherwise, quotation marks must enclose the file name. If a filename extension is not specified, the debugger automatically appends a default extension, *.com*.

Command files can be executed at debugger startup using the *-c* option, from the command line during a debugging session, or from a startup file.

See the File Startup command description for information about how to automatically execute a command file when the debugger is started.

See Also

File Log
File Startup
The “Using Macros and Command Files” chapter.

Example

To execute command file 'varTrace.com':

```
File Command varTrace
```

File Error_Command

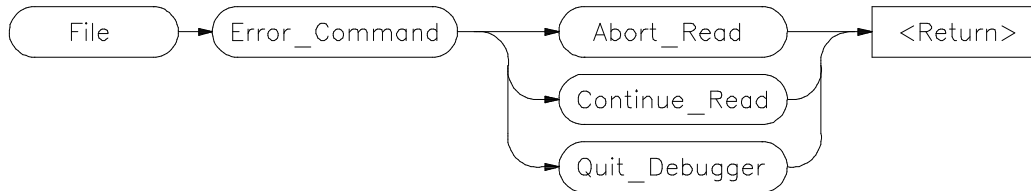

The `File Error_Command` command sets the command file error handling mode. The command specifies what action the debugger takes when an error occurs while reading a command file. *Abort_Read* causes the debugger to return to the command line after an error and wait for keyboard input. This is the default action. *Continue_Read* causes the debugger to continue to the next command in the command file after an error. *Quit_Debugger* causes the debugger to end the debugging session when an error occurs (as if you typed `Debugger Quit Yes`).

See Also `File Command`
 `File Log`

Examples To return to the command line after an error and wait for keyboard input:

`File Error_Command Abort_Read`

To continue to the next command in the command file after an error:

`File Error_Command Continue_Read`

To exit the debugger when an error occurs:

`File Error_Command Quit_Debugger`

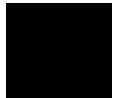

File Journal

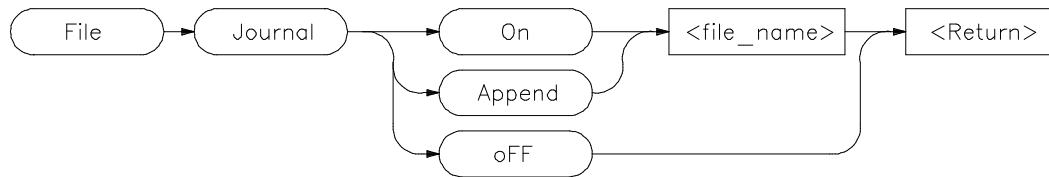

The **File Journal** command copies the information written to the Journal window output into a journal file specified by `< file_name >` . The default journal filename extension `.jou` will be appended to `< filename >` . The journal file provides a history of your debugging session.

File Journal On opens a journal file for writing. If a file already exists with the specified file name, new information is appended to the end of the existing file.

File Journal Append opens an existing file. New information is appended to the end of the existing file.

File Journal oFF closes the journal file.

A window number (29) is assigned to the journal file so that output can be written to that file using the Expression `Fprintf` command.

See Also Expression `Fprintf`

Examples To make and open journal file 'debug1.jou' for writing:

```
File Journal On debug1
```

To close the currently open journal file:

```
File Journal oFF
```

To open existing journal file 'debug1.jou' for writing and append new information at the end of the file:

```
File Journal Append debug1
```

File Log

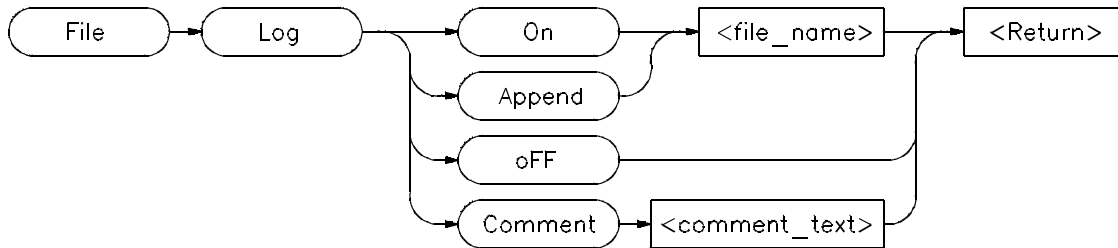

The File Log command records user input in a command file, specified by < file_name> . The default filename extension .com will be appended to < filename> . The File Log command allows an interactive debugger session to be logged as a command file which can be rerun at a later time.

File Log On opens a file for writing. If the specified file already exists, the file is overwritten by the new data.

File Log Append reopens a logging file to allow new information to be added to the end of the file.

File Log oFF terminates logging to the file.

File Log Comment places a string of text in the file as a comment. If a log file is not open, File Log Comment commands are ignored by the debugger.

All successful commands are written to the log file so the file can later be used as a command file.

Commands which are entered but not successfully completed, are written to the .com file as comments along with their error codes.

User input is recorded in the log file until the Log oFF command is executed.

A window number (28) is assigned to the log file so that output can be written to that file using the Expression Fprintf command.

See Also

Expression Fprintf
File Error_Command

Chapter 12: Debugger Commands

File Log

Examples

To make and open log file 'log1.com' for writing:

```
File Log On log1
```

To close the currently open log file:

```
File Log oFF
```

To open existing log file 'log1.com' for writing and append new information at the end of the file:

```
File Log Append log1
```

To place the comment 'This is a comment string' in the log file:

```
File Log Comment This is a comment string.
```

If a log file is not open, this command is ignored.

File Startup

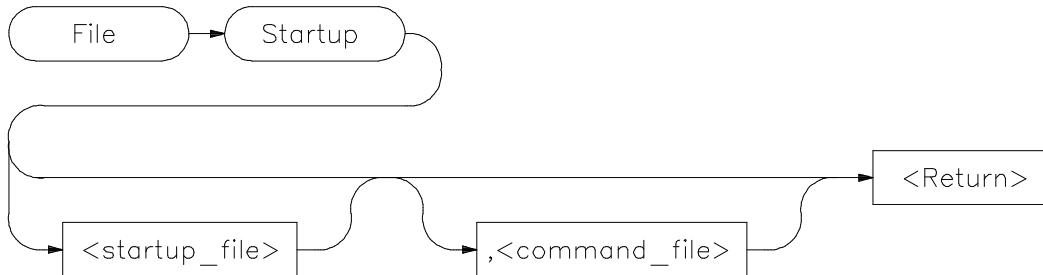

The File Startup command saves the current debugger option settings and window parameters in a startup file specified by < startup_file> . When you start a debugging session and specify the startup file with the -s option of the db68k command, the startup options and window parameters you saved will be the default parameters in that debugging session.

A startup file has an extension of .rc appended to the end of it. If you do not specify a startup file name, the startup options are saved in a file named *db68k.rc*.

You can modify default debugger startup option values with the Debugger Option command and window parameters with the Window commands.

Remember that you can also specify a command file to be executed when the debugger starts.

See Also

Debugger Option
File Command
Window New
Window Resize
the "Using Macros and Command Files" chapter

Examples

To save the current set of debugger startup options and window parameters in startup file 'my_start_file.rc':

```
File Startup my_start_file
```

Chapter 12: Debugger Commands

File Startup

To save the current set of debugger startup options and window parameters in startup file 'my_start_file.rc' and execute the command file 'initDemo.com' whenever the debugger is started using 'my_start_file.rc':

```
File Startup my_start_file , initDemo
```

File User_Fopen

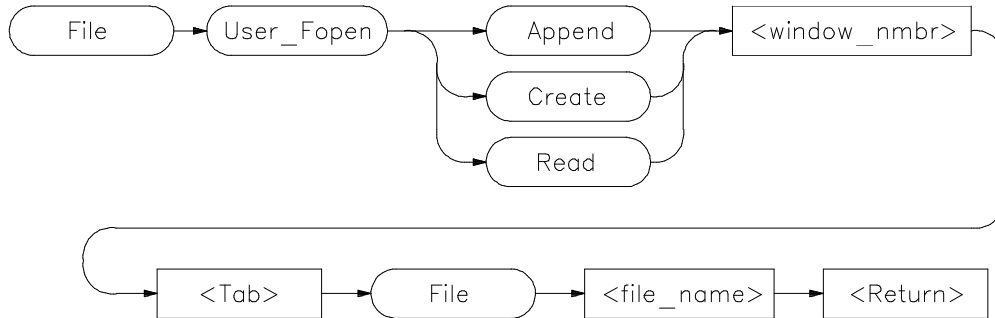

The File User_Fopen command opens the file specified by < file_name> for reading or writing and assigns a window number to it.

The *File User_Fopen Append* command opens an existing file for writing, adding new information at the end of the file.

The *File User_Fopen Create* command creates a new file for writing.

The *File User_Fopen Read* command opens an existing file for reading.

After opening a file using the File User_Fopen Append or File User_Fopen Create command, you can use the Expression Fprintf command to write information to the file. Files opened for reading may be read from the built-in macro fgetc(). See the "Predefined Macros" chapter of this manual for a complete description of this macro.

The window number must be between 50 and 256 inclusive.

Use the Window Delete or the File Window_Close command to close the file.

See Also

Expression Fprintf
File Window_Close
Window Delete
Window New

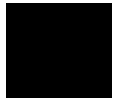

Chapter 12: Debugger Commands

File User_Fopen

Examples

To open user window 57 and redirect any data written to window 57 to the file 'varTrace.out':

```
File User_Fopen Create 57 File varTrace.out
```

To open user window 57 and append any data written to window 57 to the existing file 'varTrace.out':

```
File User_Fopen Append 57 File varTrace.out
```

To open file 'temp.dat' for reading, accessing the file as user window 52:

```
File User_Fopen Read 52 File temp.dat
```

File Window_Close

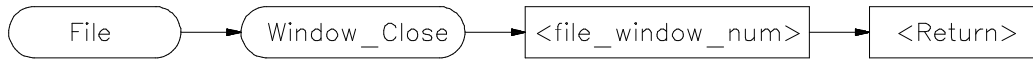

The File Window_Close command closes a device or file which was previously opened with the File User_Fopen command. The Window Delete command may also be used for this purpose.

See Also File User_Fopen
Window Delete

Example To close file associated with user window number 57:
File Window_Close 57

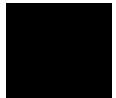

Memory Assign

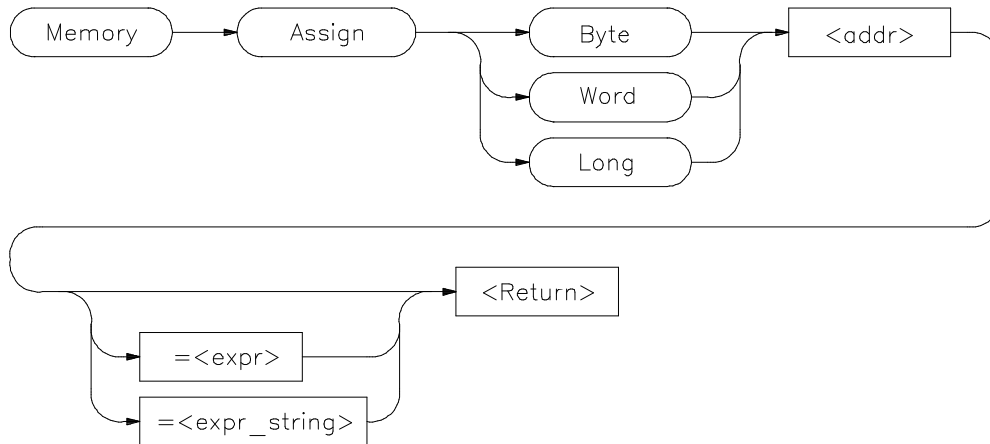

Note Debugger/emulators cannot modify memory locations in target ROM

The Memory Assign command changes the contents of the memory location specified by *<addr>* to the value or values defined by the expression *<expr>* or expression string *<expr_string>*. The size of the memory elements to be modified is specified by one of the size qualifiers (Byte, Word, or Long).

Expression strings are specified as ASCII characters enclosed in quotation marks and/or as a list of values separated by commas. Expressions and expression string elements will be truncated or padded as required, based on the size qualifier.

Memory values can be entered interactively if you do not define a value on the command line. When a value is not specified, the contents of the specified memory locations are displayed in hexadecimal and decimal. You can change the existing value by entering any legal expression followed by a carriage return. The next memory location and its contents are then displayed. The return key entered without a value will cause the command to terminate.

The Memory Assign command does not recognize variable typing. It is intended to be used as an assembly-level memory setting routine. For example,

assume that the variable *count* is a long integer. If you want to set the value of count equal to 5, the command

```
Memory Assign Long count=5
```

will not work. The command will set the memory location referenced by the value of count equal to 5, not the contents of the variable. To set the value of count equal to 5, use the following command:

```
Memory Assign Long &count=5
```

The Expression C_Expression command should be used to set C variables. This command recognizes variable types and the specified expressions behave according to the rules of C. The command:

```
Expression C_Expression count=5
```

will set count equal to 5.

See Also

Expression C_Expression
Memory Register

Examples

To display the contents of memory location 1000h and allow interactive modification of memory contents:

```
00001000 = 0x48 72:
```

```
Memory Assign Byte 1000h
```

To change the contents of memory locations 2000h through 2005h to 00, 41, 00, 42, 00, 43, and change the contents of locations 2006h/2007h to the value of 'system_is_running':

```
Memory Assign Word 2000h=41h,42h,43h,system_is_running
```

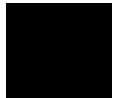

Memory Block_Operation Copy

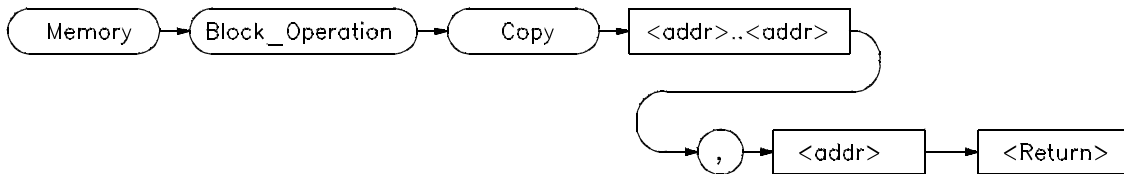

Note Debugger/emulators cannot copy to memory locations in target ROM.

The Memory Block_Operation Copy command copies the contents of the memory range specified by *<addr>..<addr>* to a block of the same size starting at the memory location specified by *<addr>*.

See Also

- Memory Assign
- Memory Block_Operation Fill
- Memory Block_Operation Match
- Memory Block_Operation Search
- Memory Block_Operation Test

Examples To copy the block of memory starting at address 1000h and ending at address 10ffh to a block of the same size starting at address 5000h:

```
Memory Block_Operation Copy 1000h..10ffh,5000h
```

To copy the block of memory starting at the address of the structure 'current_targets' and ending 15 bytes after this address to a block of memory starting at the address of the structure 'default_targets':

```
Memory Block_Operation Copy &current_targets..+0xf,  
&default_targets
```

Memory Block_Operation Fill

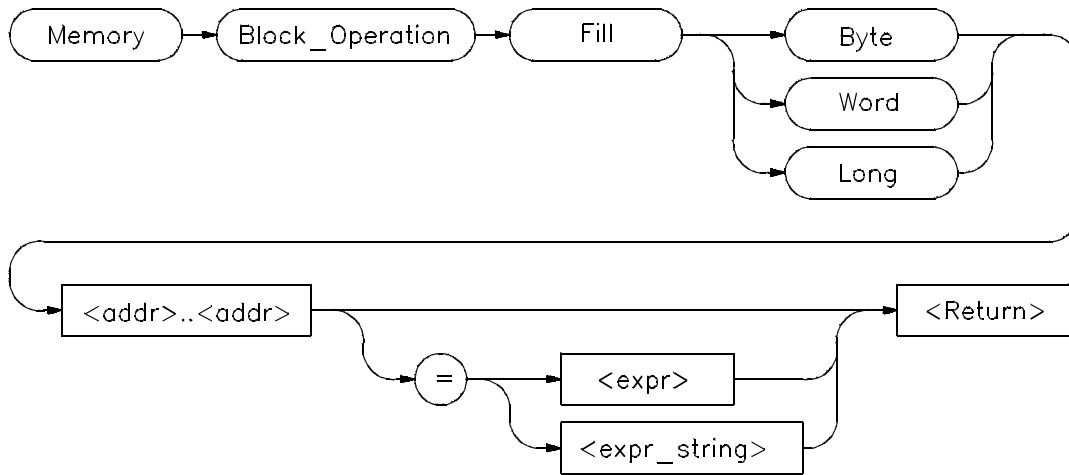

Note

Debugger/emulators cannot fill memory locations in target ROM.

The Memory Block_Operation Fill command fills the range of memory locations specified by the address range *<addr>..*addr*>* with the value or values specified by an expression *<expr>* or an expression string *<expr_string>*. If no expression is given, the debugger fills the specified memory locations with zeros. The specified size qualifier (Byte, Word, or Long) determines the size of the value.

If you specify a single expression value, the debugger fills the memory area with that value. If you enter an expression string, the debugger fills the memory area with the specified string pattern.

An expression string is a list of values separated by commas and can include ASCII characters enclosed in quotation marks. All expressions in an expression string are padded or truncated to the size specified by the size qualifiers if they do not fit the specified size evenly.

If the number of values in an expression string is less than the number of bytes in the specified address range, the debugger repeatedly places the list of values

Chapter 12: Debugger Commands

Memory Block_Operation Fill

in memory until all designated memory locations are filled. If you specify more values than can be contained in the specified address range, the debugger ignores the excess values.

See Also

Memory Assign
Memory Block_Operation Copy
Memory Block_Operation Match
Memory Block_Operation Search
Memory Block_Operation Test
Memory Register

Examples

To fill memory locations 1000h through 1007h with the long pattern 61626364, 65666768:

```
Memory Block_Operation Fill Long 0x1000..+7='abcdefgh'
```

To fill the memory area starting at location 1000h and ending at location 10ffh with zeros:

```
Memory Block_Operation Fill Byte 0x1000..0x10ff
```

Memory Block_Operation Match

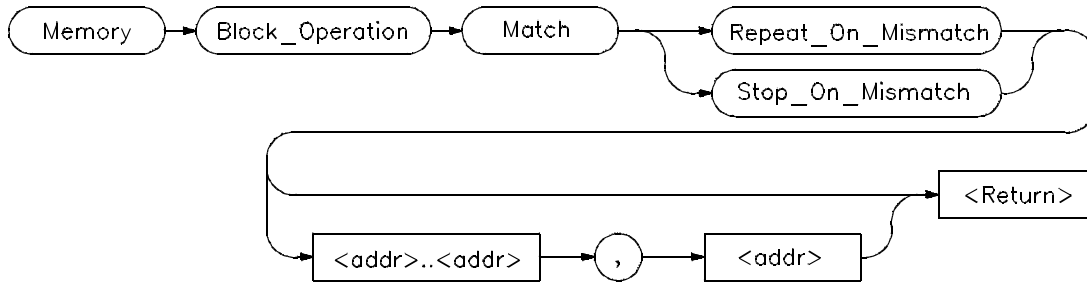

The Memory Block_Operation Match command compares the contents of two blocks of memory to determine their similarities or differences. The command compares the block of memory specified by the address range `<addr>..<addr>` with the same size block starting at `<addr>`.

The debugger displays differences between the two blocks of memory, mismatched values and addresses, in the Journal window. If the contents of the two blocks of memory are the same, the debugger displays the message *Memory blocks are the same.*

The Memory Block_Operation Match Stop_On_Mismatch command halts when a mismatch is found. If the Memory Block_Operation Match Repeat_On_Mismatch command is selected, the comparison continues until the end of the block.

When you execute the Memory Block_Operation Match Stop_On_Mismatch/Repeat_On_Mismatch command without specifying an address range, the debugger continues comparing the address range specified in the previous Memory Block_Operation Match Stop_On_Mismatch command starting from where it found the last mismatch.

See Also

- Memory Block_Operation Copy
- Memory Block_Operation Fill
- Memory Block_Operation Search
- Memory Block_Operation Test

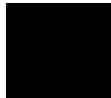

Chapter 12: Debugger Commands

Memory Block_Operation Match

Examples

To compare the block of memory starting at address 1000h and ending at address 10ffh with a block of the same size beginning at address 5000h and stop when a difference is found:

```
Memory Block_Operation Match Stop_On_Mismatch  
1000h..10ffh,5000h
```

To execute the previous Memory Block_Operation Match Stop_On_Mismatch command starting from where it found the last mismatch:

```
Memory Block_Operation Match Stop_On_Mismatch
```

To compare the block of memory starting at address 1000h and ending at address 10ffh with a block of the same size beginning at address 5000h and stop at the end of the memory block:

```
Memory Block_Operation Match Repeat_On_Mismatch  
1000h..10ffh,5000h
```

Memory Block_Operation Search

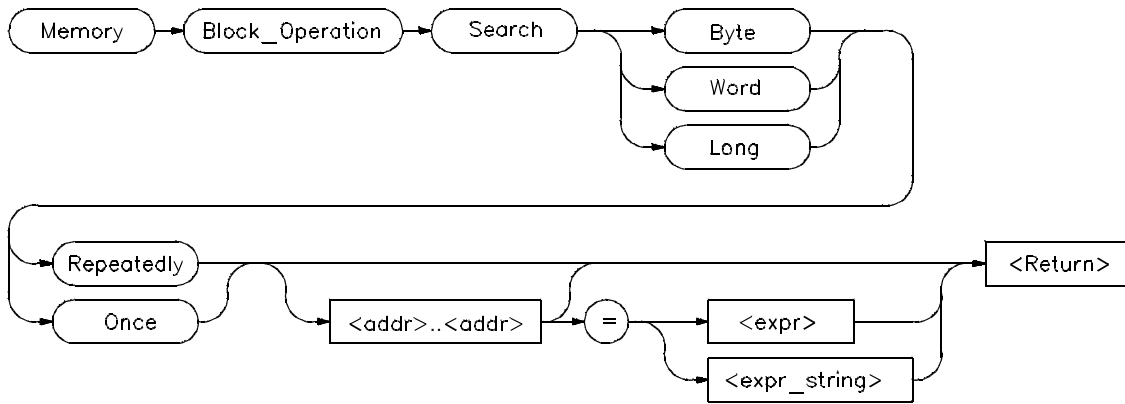

The Memory Block_Operation Search command searches the block of memory specified by *< addr> ..< addr>* for the specified expression *< expr>* or expression string *< expr_string>*. The size qualifier (Byte, Word, or Long) specifies the size of an expression or each expression in an expression string. A Memory Block_Operation Search command given without parameters continues the search of a previous Memory Search command given with the Once qualifier. The Repeatedly qualifier causes the search to repeat.

You can specify expression strings as ASCII characters enclosed in quotation marks and/or as a list of values separated by commas. If the strings do not fit the specified size evenly, all expressions in an expression string will be padded or truncated to the size specified by the size qualifiers.

If you specify the Once qualifier, the search stops when the expression is found. If you specify the Repeatedly qualifier, the debugger repeatedly searches for the specified expression, displaying each match until it reaches the end of the block or until you press **CTRL C**.

When you execute the Memory Block_Operation Search command with the Once qualifier, subsequent Memory Block_Operation Search commands that are executed without expression parameters cause the debugger to continue searching through the originally specified address range starting from where it found the last match. If the expression or expression string is not found in the specified block, the debugger displays the message *Not found*.

Chapter 12: Debugger Commands

Memory Block_Operation Search

See Also

- Memory Display
- Memory Block_Operation Copy
- Memory Block_Operation Fill
- Memory Block_Operation Match
- Memory Block_Operation Test
- Program Find First
- Program Find Next

Examples

To search for the expression 'gh' in the memory range from address 1000h through address 10ffh and stop when the expression is found or address 10ffh is reached:

```
Memory Block_Operation Search Word Once  
1000h..+0xff = 'gh'
```

To execute the previous Memory Block_Operation Search command starting from where it found the last match:

```
Memory Block_Operation Search Word Once
```

To search for the hexadecimal value '65666768' in long format in the address range 1000h through 10ffh and stop at the end of the address range:

```
Memory Block_Operation Search Long Repeatedly  
0x1000..0x10ff=0x65666768
```

Memory Block_Operation Test

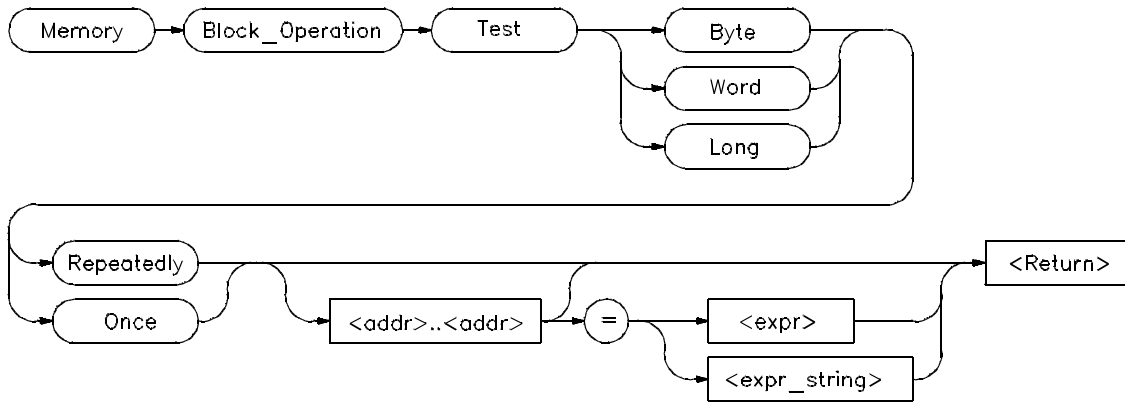

The Memory Block_Operation Test command examines the specified memory locations specified by *<addr..addr>* to verify that the value(s) defined by *<expr>* or *<expr_string>* exist throughout the specified memory area. When the debugger finds a mismatch, it displays the mismatched address and value. The size qualifier (Byte, Word, or Long) specifies the size of an expression or expression in a string.

If you enter a single expression value, the debugger tests the memory area for that value. If you specify an expression string, the debugger tests the memory area to verify that it is filled with the values found in the expression string.

You can specify expression strings either as ASCII characters enclosed in quotation marks or as a list of values separated by commas. If they do not evenly fit the specified size, all expressions in an expression string will be padded with zero-valued bytes to the size specified by the size qualifier.

Once Qualifier

If you specify the Once qualifier, the test stops when a mismatch is found. If you execute the Memory Block_Operation Test command with the Once qualifier specified, subsequent *Memory Block_Operation Test . . . Once* commands that are specified without parameters will continue testing through the address range originally specified, beginning with the last address tested. A Memory Block_Operation Test command given without parameters continues

Chapter 12: Debugger Commands

Memory Block_Operation Test

the test of a previous Memory Block_Operation test command given with the Once qualifier, beginning with the last address tested.

Repeatedly Qualifier

If you specify the Repeatedly qualifier, the debugger continues testing the specified value(s) for mismatches until the end of the block is reached, or until you enter **CTRL C**.

Examples

To test for the expression 'gh' in the memory range from address 1000h through address 10ffh and stop when a word not matching the expression is found:

```
Memory Block_Operation Test Word Once 1000h..+0xff =  
'gh'
```

To execute the previous Memory Block_Operation Test command starting from where it found the last mismatch:

```
Memory Block_Operation Test Word Once
```

To test for the hexadecimal value '65666768' in long format in the address range 1000h through 10ffh and stop at the end of the address range:

```
Memory Block_Operation Test Long Repeatedly  
0x1000..0x10ff=0x65666768
```

Mismatched values are displayed in the Journal window.

Memory Display

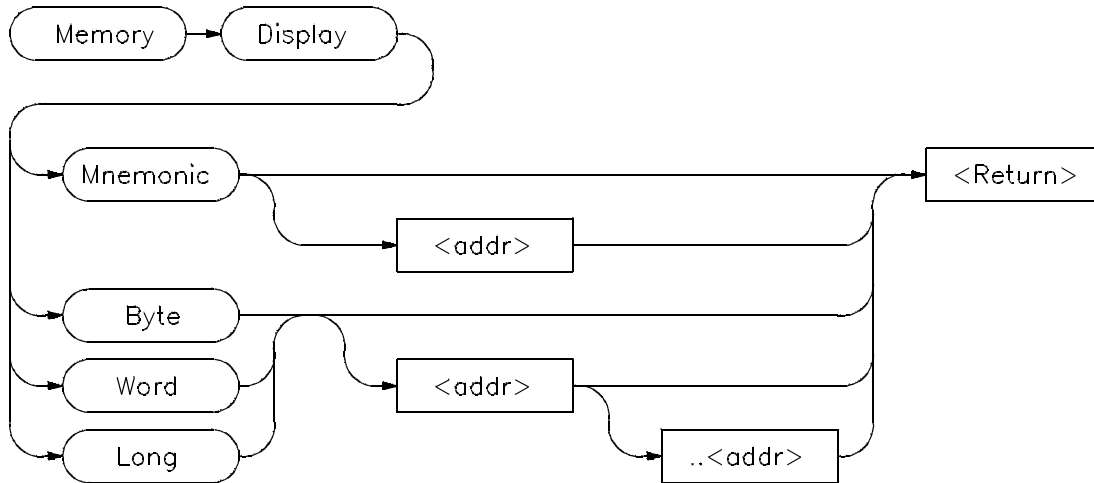

The Memory Display displays the contents of the specified memory locations.

Mnemonic Option

The *Mnemonic* option displays memory in assembly language mnemonics starting at the memory location specified by *<addr>*. If you do not specify an address, the debugger displays memory beginning with the address pointed to by the program counter. This command functions only in the assembly-level mode.

If you have executed the Debugger Options Symbolics Intermixed On command, C source code lines will be intermixed with the assembly language code (when applicable). If you have executed the Debugger Options Symbolics Assem_Symbols On command, symbol references will be displayed with the assembly language code.

The *Prev*, *Next*, *Up*, and *Down* keys may be used when the Code window is active to display instructions with higher or lower addresses. Note that the *Prev* and *Up* keys do not function when disassembling addresses outside of the target program.

Chapter 12: Debugger Commands

Memory Display

Note

If the `Align_bp` option is set to *On*, the address of the first instruction in the assembly Code window may be incorrect after executing the Memory Display Mnemonic command.

Byte, Word, and Long Options

The byte, word, or long qualifier option displays the contents of memory locations specified by `<addr> ..<addr>` in the Journal window in both hexadecimal and ASCII formats. The debugger represents nonprintable ASCII characters by a period (.). The debugger displays memory contents in the size specified by the size qualifier (Byte, Word, or Long).

If you specify an address range, the debugger displays all memory locations in that range.

If you specify a single address, the debugger displays two lines of data.

If you do not specify any parameters, the debugger displays the next 80 bytes (five lines) of data after the previously displayed address range.

The memory contents are displayed in the Journal window.

See Also

Expression Display_Value
Symbol Display

Examples

To display disassembled memory in the Code window starting at the symbol `'_emeg_shutdown'` (this command works only in assembly-level mode):

```
Memory Display Mnemonic _emeg_shutdown
```

To display memory in word format in the Journal window starting at the symbol `'time'` and ending 15 bytes after `'time'`:

```
Memory Display Word time..+0xf
```

Memory MMU

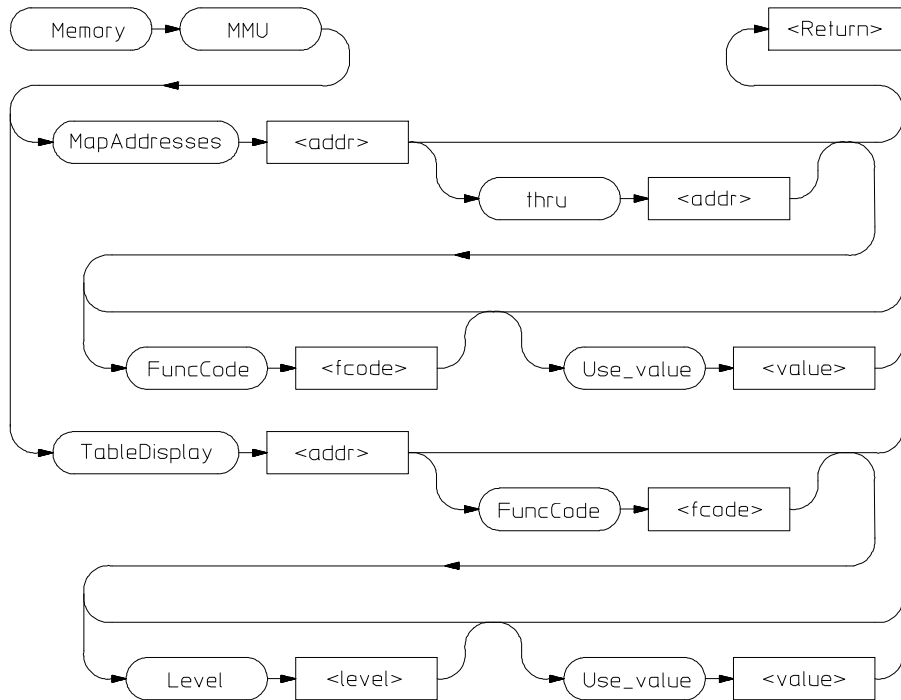

B1477S05

The Memory MMU MapAddresses command shows the logical-to-physical address mapping for an address or range of addresses. The command shows the mapping which is currently set up in the MMU tables.

The Memory MMU TableDisplay command shows how the MMU will translate a specific logical address into a physical address. This translation process is also called the *table walk* process. If you specify a level (Level < level>), the command will show how that level in the MMU tables will translate a logical address into a physical address.

The mapping information will be displayed in the Journal window.

The function code of the addresses can be specified using FuncCode. The MMU registers may be specified using Use_Value.

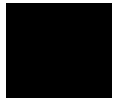

Memory Register

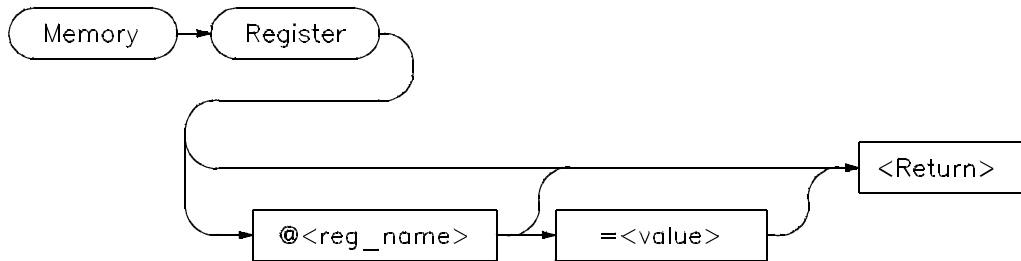

The Memory Register command changes the contents of a register, status flag, or other processor variables such as pc or sp. The new contents are defined by `< value>` .

The PC (program counter) is displayed or changed if you do not specify a register name.

If you do not specify a value in the command, values are entered interactively. You can enter multiple register values interactively. The debugger displays contents of the specified register in binary, hexadecimal, or decimal, as appropriate for the register. You can change the existing value by entering any legal expression and pressing the **Return** key.

Pressing the **Return** key without specifying a register value terminates the command.

All register names are preceded with an @ sign.

See Also

Memory Assign

Examples

To modify register values interactively:

Memory Register

The program counter (PC) is displayed in the Journal window. You can modify the PC by entering a value (10a4h in this example) at the cursor

prompt and pressing Return. The PC will be modified, and the next register will be displayed:

```
@pc      = 0x000010B8      4280: 10a4h  
@sp      = 0x00015DB4      89524:
```

To set the value of register @d1 to 44h:

```
Memory Register @d1=0x44
```

To interactively change the value of register @d1:

```
Memory Register @d1
```

To set the value of the lower 32-bits of the CPU root pointer to 0x000174B4:

```
Memory Register @CRP_L = 0x000174B4
```

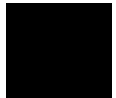

Memory Unload_BBA

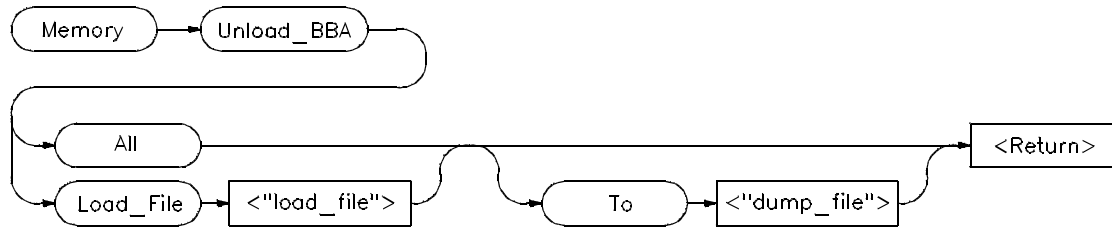

Note

You must have the HP Branch Validator installed on your system in order to use this command. If you do not have the HP Branch Validator for your processor, the debugger will display the following error message when you attempt to execute this command:

```
error code = 141  
No valid BBA spec file for <processor> processor
```

The Memory Unload_BBA command unloads basis branch analysis (BBA) information from program memory. The BBA preprocessor (-b option) must be used at compile time in order for this information to exist in program memory. The file name *bbadump.data* is the default dump file name.

Once this information has been unloaded, it can be formatted with the BBA report generator, *bbarep* (see the *HP Branch Validator for AxLS C User's Guide*).

Note

The Unload_BBA command is disabled when the debugger option Demand_Load is *On*. If Demand_Load is *OFF* but the program was loaded with Demand_Load *On*, the Memory Unload_BBA command will generate a BBA file with incomplete information. See the Debugger Option General command description in this manual for more information on the Demand_Load option.

Memory Unload_BBA All

The Memory Unload_BBA All command unloads branch analysis information associated with all absolute files loaded into the file *bbadump.data*.

This command lets you run *bbarep* without specifying a file name. The file name *bbadump.data* is used as the default name of all dump files.

Memory Unload_BBA All To < "dump_file">

The Memory Unload_BBA All To < "dump_file"> command unloads branch analysis information associated with all absolute files loaded into < "dump_file"> .

Memory Unload_BBA Load_File < "load_file">

The Memory Unload_BBA Load_File command unloads only basis branch information associated with the specified absolute file (< "load_file">) into the file *bbadump.data*.

This command lets you run *bbarep* without specifying a file name. The file name *bbadump.data* is used as the default name of all dump files.

Memory Unload_BBA Load_File < "load_file"> To < "dump_file">

The Memory Unload_BBA Load_File < "load_file"> To < "dump_file"> command unloads only basis branch information associated with the specified absolute file (< "load_file">) into the file < "dump_file"> .

Examples

To unload all branch analysis information into file "mydata":

```
Memory Unload_BBA All To "mydata"
```

To unload branch analysis information associated with absolute file a.out.x into file "bbadump.data":

```
Memory Unload_BBA Load_file "a.out"
```

To unload branch analysis information associated with absolute file a.out.x into file "mydata":

```
Memory Unload_BBA Load_file "a.out" To "mydata"
```

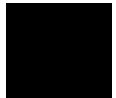

Program Context Display

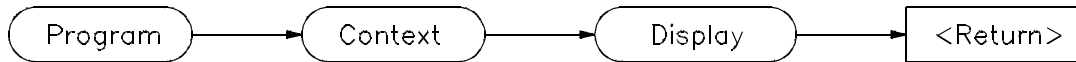

The Program Context Display command displays the current module, function, and line number in the Journal window. The current module is the one pointed to by the program counter.

This command will display both the view context, as set by a Program Context Set command, and the context of the current program counter, if the two are different.

Example

To display the current module, function, and line number:

```
Program Context Display
```

```
Current context is: @ecs\\main\main On line 81
```

See “Expression Elements” section of the “Expressions and Symbols in Debugger Commands” chapter for a description of debugger operators.

Note

If the PC does not point to a valid module, an alternate context is displayed. The alternate context is the name of the executable file that has been loaded into the debugger.

Program Context Expand

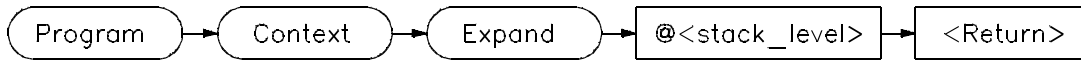

The Program Context Expand command displays values of the parameters passed to a function, and the local variables in a function. The values are displayed in the Journal window.

To display a function's calling parameters and local variables, specify the function's stack level preceded by an at sign (@). The Backtrace window in high-level mode displays the function calling chain from the main program to the current function. The debugger displays the function stack (nesting) level beside each function name. The current function is level 0, the caller is always 1, etc.

You can use the Program Context Expand command to display the local variables and parameters of any function shown in the backtrace window. The calling parameters and local variables are accessible on the C run-time stack for functions in a directly-called chain from the main program to the current function.

See Also

Expression Display_Value
Expression Monitor
Symbol Display

Example

To display local variables and calling parameters of the function at stack level 2:

```
Program Context Expand @2
```

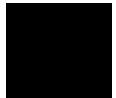

Program Context Set

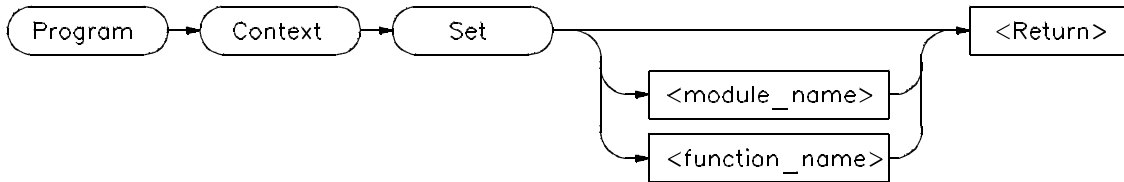

The Program Context Set command changes the default module and function (context). The current module (the one to which the program counter is pointing) is the default when functions are referenced without a module or function qualifier.

The default module reverts to the current module when you invoke any command that causes program execution, or if you execute the Program Context Set command without a parameter.

Example

To select module 'updateSys' as the current module:

```
Program Context Set updateSys
```

Program Display_Source

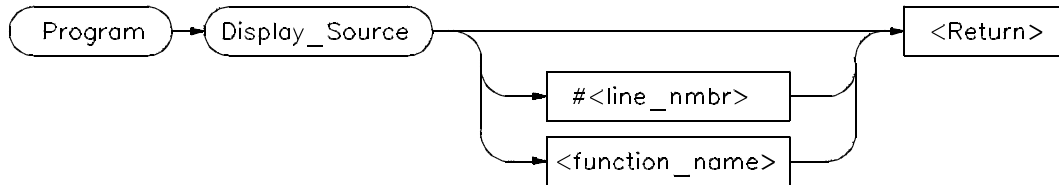

The Program Display_Source command displays C source code in the Code window beginning at the specified line or function. This command works in high-level mode only. If you do not specify a line number or function name, the debugger displays the line pointed to by the program counter.

You can display lines or functions in other modules by preceding them with a module name. The *Next Page*, *Prev Page*, *Up* arrow, and *Down* arrow keys may be used when the Code window is active to display code at higher or lower line numbers.

This command does not change the current program context.

See Also

Memory Display Mnemonic
Program Context Set
Program Find_Source

Examples

To display line 82 of the current module in the Code window:

```
Program Display_Source #82
```

To display the source code for function 'update_state_of_system' in the Code window:

```
Program Display_Source update_state_of_system
```

To display line 25 of module updateSys:

```
Program Display_Source updateSys\#25
```

Program Find_Source Next

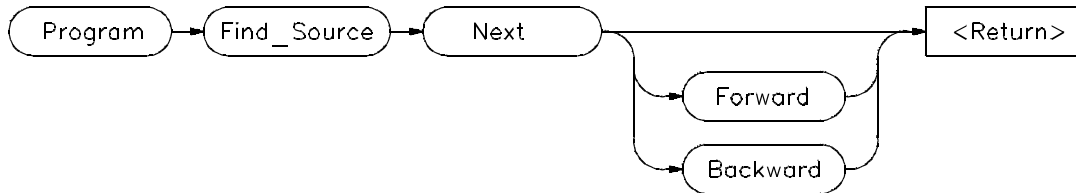

The Program `Find_Source Next` command searches a high-level source program for the next occurrence of the string specified in the last Program `Find_Source Occurrence` command. When the debugger finds the string, it displays the line containing the string at the top of the Code window.

If you specify *Forward*, the debugger searches forward through the file for the string.

If you specify *Backward*, the debugger searches backward through the file for the string.

If neither *Forward* nor *Backward* is specified, the debugger searches forward through the file for the string.

If the debugger cannot find the specified string, it displays the message "*string not found*". The screen remains unchanged.

See Also

Program `Find_Source Occurrence`

Example

To find the next forward occurrence of the string specified in the last Program `Find_Source Occurrence` command:

Program `Find_Source Next`

Program Find_Source Occurrence

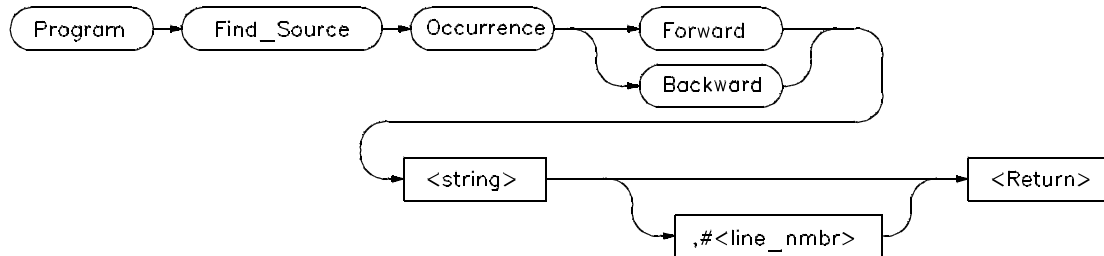

The Program Find_Source Occurrence command searches a high-level source file for the first occurrence of the specified string. If you provide a line number, the debugger searches for the string starting at the given line number. If you do not specify a line number, the string search starts at the top of the Code window.

If you specify *Forward*, the debugger searches forward through the file for the string.

If you specify *Backward*, the debugger searches backward through the file for the string.

You must enclose strings containing nonalphanumeric characters in quotation marks. Quotation marks are not required if the string consists of only alphanumeric characters.

If the debugger finds an occurrence of the string, it displays the line containing the string at the top of the Code window. If the string does not exist or the debugger cannot find it, the debugger displays the message "*string not found*". The screen remains unchanged.

You can use the Program Find_Source Next command to search for the next occurrence of the specified string.

If you specify a line number with a module reference, the debugger displays the source code for that module in the Code window.

See Also

Program Display_Source
Program Find_Source Next

Chapter 12: Debugger Commands

Program Find_Source Occurrence

Examples

To search forward through the current module for the string 'time':

```
Program Find_Source Occurrence Forward 'time'
```

To search backward through the current module for the string 'time', starting at line 237:

```
Program Find_Source Occurrence Backward 'time',#237
```

To search forward through the module 'main', for the string system_is_running, beginning at line 1:

```
Program Find_Source Occurrence Forward  
"system_is_running", main\#1
```

Program Load

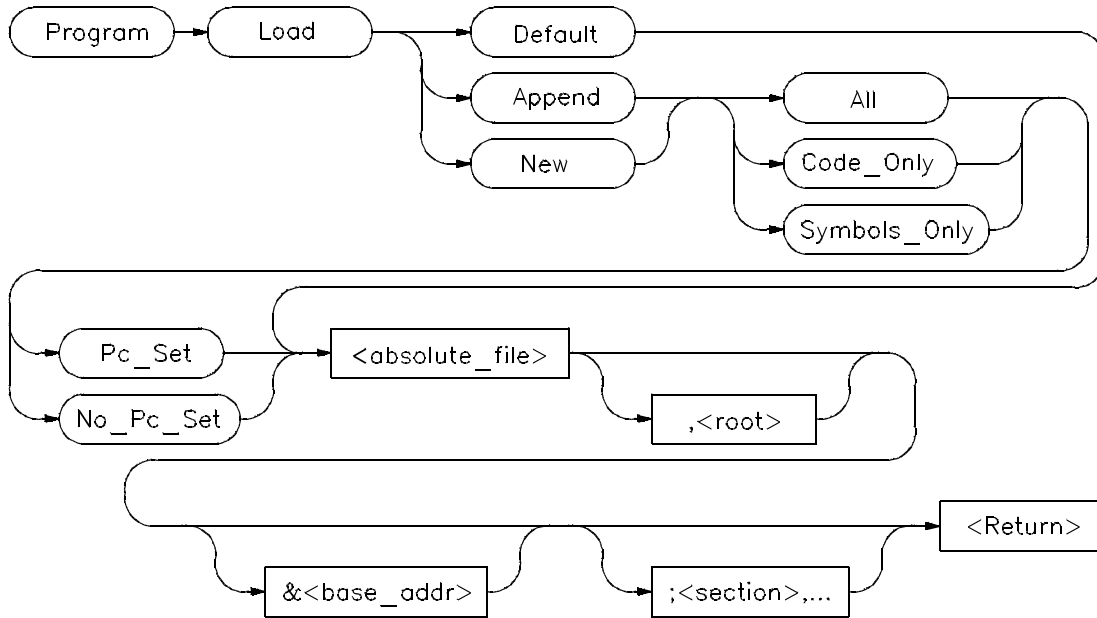

The Program Load command loads the specified executable module into the debugger.

Default Parameter

When you specify the Default parameter, the debugger:

- removes all previous program symbols
- removes all previously set breakpoints
- resets the program counter (PC)
- loads the full symbol set
- loads the executable module

New/Append Parameters

The *New* parameter loads a new program, removing any old program that may have been loaded. The *New* parameter optionally allows you to load the

Chapter 12: Debugger Commands

Program Load

program image, the program symbols, or both. The program counter can be set from the transfer address in the load file or ignored.

The *Append* parameter loads another program without deleting the existing program.

If you enter the Program Load command with the *New* or *Append* parameter, the following qualifiers are available:

All	Both the program image and program symbols to be loaded.
Code_Only	Only the program image is loaded.
Symbols_Only	Only the program symbols are loaded.
Pc_Set	The program counter is set from the transfer address in the load file.
No_Pc_Set	The program counter is not reset.

Using the All or Symbols_Only qualifiers along with the Pc_Set qualifier resets static variables for a complete restart.

The optional root parameter (< root>) allows you to specify an alternate name for the root of the symbol tree.

The base address (&< base_addr>) allows PC relative code to be shifted upon loading.

The section list (< section>) enables partial loading of absolute file sections, i.e., prog, data, const, etc. The symbols for all sections will be reloaded.

Resetting Program Variables

To reset static and global program variables after entering a Debugger Execution Reset_Processor or Program Pc_Reset command, you must reload your program by using the Program Load command. For faster loading, specify Program Load New Code_Only. The debugger retains symbol information. You do not have to reload symbol information if symbol addresses have not changed.

The address where the object module will be loaded is specified at link time. However, the address can be changed by specifying a new base address.

See Also

Debugger Execution `Reset_Processor`
Program `Pc_Reset`
Debugger Option `General_Demand_Load`

Examples

To load absolute file 'ecs', remove all existing program symbols, reset the program counter, and load the full symbol set:

```
Program Load Default ecs
```

To load only the program image of the prog section of absolute file 'ecs' without resetting the program counter:

```
Program Load New Code_Only No_Pc_Set ecs;prog
```

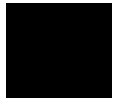

Program Pc_Reset

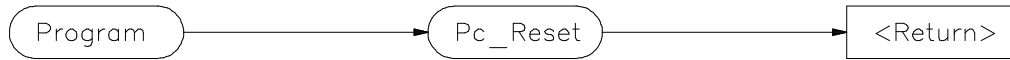

The Program Pc_Reset command resets the program counter to the transfer address from the absolute file. This causes the next Program Run or Program Step command to restart execution at the beginning of the program. The command does not clear breakpoints.

See Also Debugger Execution Reset_Processor
 Program Load
 Program Run

Example To reset the program counter to the transfer address from the absolute file:
`Program Pc_Reset`

Program Run

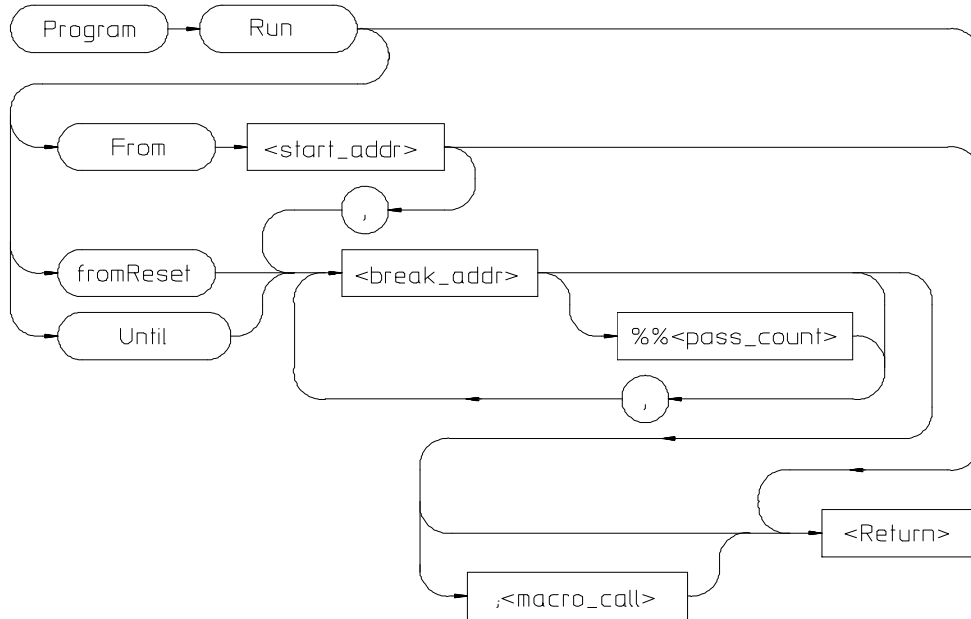

The Program Run command starts or continues target program execution. The program runs until it encounters a permanent or temporary breakpoint, an error, or a stop instruction, or until you press **CTRL C**.

The Program Run command may be used to resume execution after program execution has been suspended.

Program Run From

The Program Run From command begins program execution at the specified start address `< start_addr >` .

Using the Program Run From command to specify a starting address in high-level mode may cause unpredictable results if the compiler startup module is bypassed.

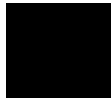

Program Run fromReset

Resets processor and then starts execution as the processor does when reset.

Program Run Until

The Program Run Until command begins program execution at the current program counter address and breaks at the specified address.

Break Address

The break address (< break_addr>) acts as a temporary instruction breakpoint. It is automatically cleared when program execution is halted. Multiple break addresses are ORed. For example, the command

```
Program Run Until #20,#90 Return
```

causes the program to run until either line 20 or line 90 is encountered, whichever occurs first.

Note

The debugger/emulator implements instruction breaks using software breakpoints. Therefore, break addresses cannot be specified for addresses in target ROM.

Pass Count

The pass count (< pass_count>) specifies the number of times the break address is executed before the program is halted. For example, a pass count of three will cause the program to break on the fourth execution of the break address.

Macro Calls

If specified, a macro (< macro_name>) is invoked when the temporary break occurs.

See Also

Breakpt Access
Breakpt Clear_All
Breakpt Delete

Breakpt Instr
Breakpt Read
Breakpt Write
Program Pc_Set
Program Step

Examples

To execute the target program starting at address 'main':

Program Run From main

To begin program execution at the current program counter address and run until line 110 of the current module:

Program Run Until #110

To begin program execution at the current program counter address, run until the program returns to the calling function of the current function, and then execute the macro 'read_val':

Program Run Until @1;read_val()

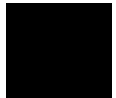

Program Step

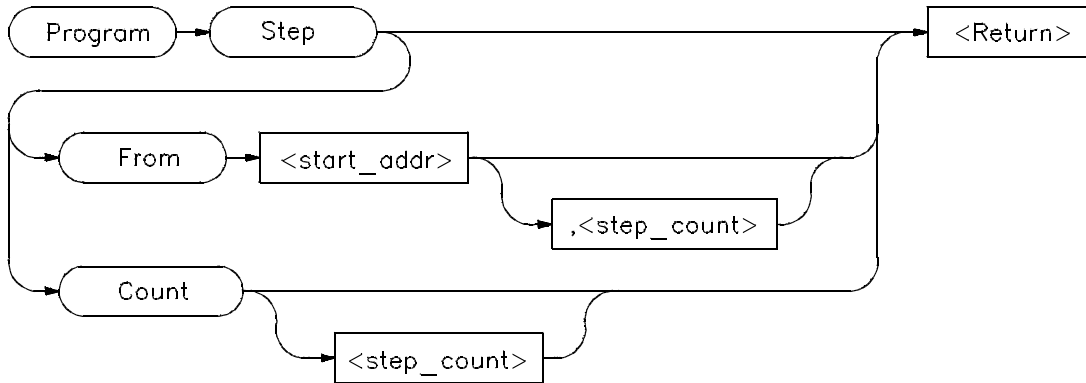

The Program Step command executes the specified number of instructions or lines, beginning with the location identified with `< start_addr >` . In high-level mode, single-stepping is done one C source line at a time. In assembly-level mode, single-stepping is done one machine instruction at a time. When the program calls a function, stepping continues in the called function.

If you do not specify a starting address, single-stepping begins at the address contained in the program counter.

If you do not specify a step count (`< step_count >`), the debugger will either step one C source line or one machine instruction.

Note

If the debugger steps into an HP library routine, you can then use the Program Run Until @ 1 (stack level 1) command to run to the end of the library routine.

Program Step From

The Program Step From command executes one instruction or line, beginning with the location specified by `< start_addr >` . If you do not specify the optional step count (`< step_count >`), the debugger executes one line or one instruction.

Program Step Count

The Program Step Count command executes the specified number of either instructions or lines, starting at the location pointed to by the program counter.

The debugger updates the screen after each instruction or line is executed. If a breakpoint is encountered, single-stepping is halted.

You can also use function key *F7* to single-step.

See Also

Breakpt Instr
Program Run
Program Step Over
Program Step With_Macro

Examples

To step four source lines, starting at line 39:

```
Program Step From #39,4
```

To step ten source lines (high-level mode) or ten processor instructions (assembly-level mode), starting at the program counter address:

```
Program Step Count 10
```

To step one source line (high-level mode) or one processor instruction (assembly-level mode), starting at the program counter address:

```
Program Step
```

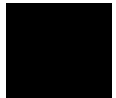

Program Step Over

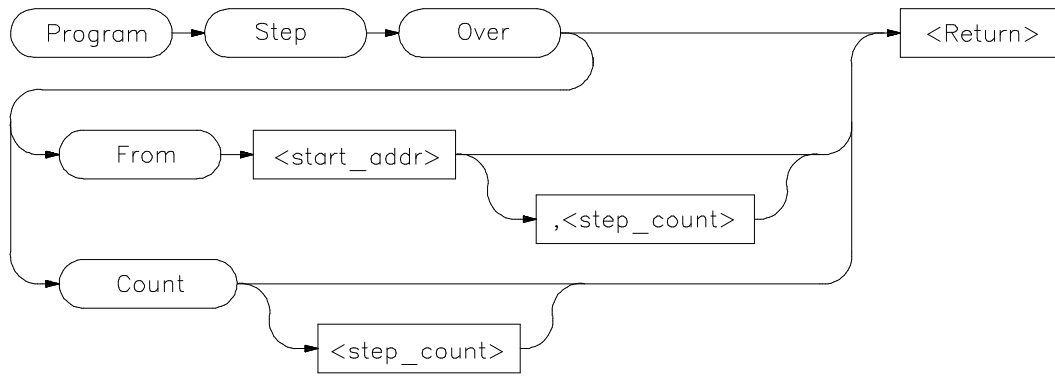

The Program Step Over command executes the number of instructions or lines specified, but executes through function calls, that is, the called function is executed without stepping through it. Execution begins at the specified starting address.

When the debugger encounters a C function or assembly-level JSR instruction, it stops stepping, executes the function or JSR, and then continues stepping when the called subroutine returns.

In high-level mode, the debugger executes one C source line at a time. In assembly-level mode, the debugger executes one microprocessor instruction at a time.

If you do not specify a starting address, single-stepping begins at the address contained in the program counter.

If you do not specify a step count (< step_count >), the debugger will either step one C source line or one machine instruction.

Program Step Over From

The Program Step Over From command executes one instruction or line, beginning with the location specified by < start_addr > . If you do not specify the optional step count (< step_count >), the debugger executes one line or one instruction.

Program Step Over Count

The Program Step Over Count command executes the specified number of either instructions or lines, starting at the location pointed to by the program counter. The debugger updates the screen after each instruction or line is executed. If the debugger encounters a breakpoint, it halts single-stepping.

You can also use function key *F8* to single-step over functions.

See Also

Breakpt Instr
Program Run
Program Step Count
Program Step From
Program Step With_Macro

Examples

To step four source lines, starting at line 39, and execute through any function calls:

```
Program Step Over From #39,4
```

To step ten source lines (high-level mode) or ten processor instructions (assembly-level mode), starting at the program counter address, and execute through any function calls:

```
Program Step Over Count 10
```

To step one source line (high-level mode) or one processor instruction (assembly-level mode), starting at the program counter address, and execute through any function calls:

```
Program Step Over
```

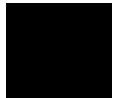

Program Step With_Macro



The Program Step With_Macro command single steps through the program and executes the specified macro (*<macro_call>*) after each instruction or high-level line. Program execution continues if the macro returns a nonzero value.

Single-stepping is done by C source line in high-level mode and by microprocessor instruction in assembly-level mode.

See Also

Program Run
Program Step From
Program Step Over

Example

To step through the program one source line (high-level mode) or one processor instruction (assembly-level mode) at a time, executing the macro `read_var` after each step:

```
Program Step With_Macro read_var()
```

Symbol Add

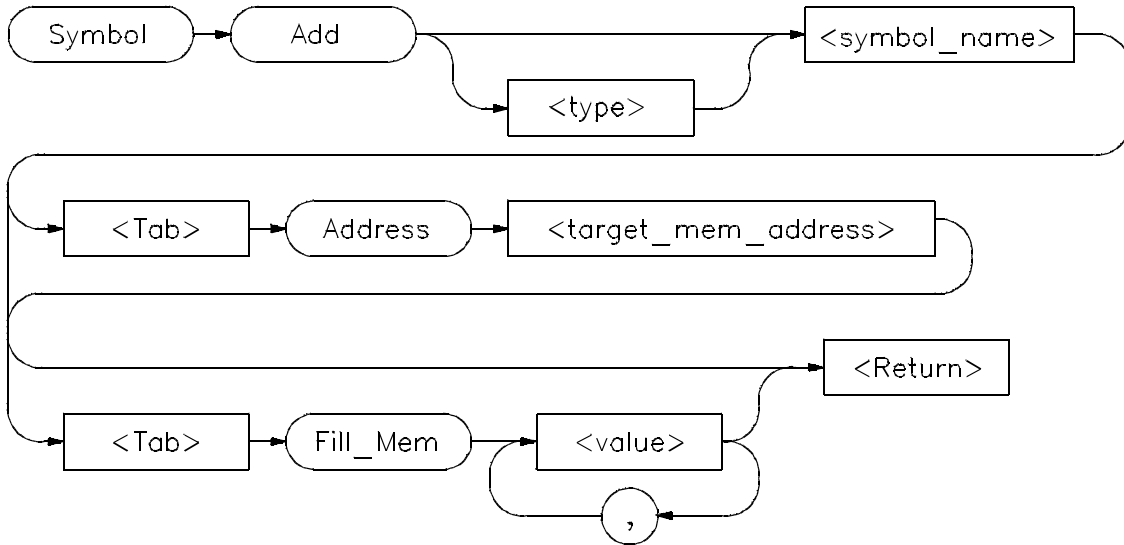

The Symbol Add command creates a symbol and adds it to the debugger symbol table. When defining a symbol, you must declare the symbol's name. It may be any name not previously used.

Type

You can optionally assign any valid C data type `< type >` to the symbol. If you do not assign a data type, the symbol type defaults to type `int`.

If the symbol type is a pointer, the initial value must be a data address. If the type is an array, the initial value must be a string of values separated by commas and/or enclosed in quotation marks. If fewer values are given than will fill the array, the pattern is repeated until the entire array is filled.

When initializing symbols, the symbol type is not used. Only the size is used. If a char array is defined, it is filled with the specified pattern in the same way as with the Memory Block_Operation Fill command. A zero is not appended to char arrays. The size is not determined by the string as in C. Complex values such as floating point representation are not recognized.

Program Symbols

Program symbols are specified with a base address (Address < target_memory_address>). The base address references an address in target memory. Program symbols are identical to variables defined in a C or assembly language program. The value of a program symbol is placed in target memory. If an initial value is specified for the program symbol, the value is loaded in the memory location referenced by the symbol. If an initial value is not specified, the memory location referenced by the symbol is not changed.

Debugger Symbols

Debugger symbols are specified without a base address and are not associated with a target memory address. Debugger symbols may be used to aid and control the flow of the debugger. They are located at a fixed location in debugger memory. Only debugger commands and C expressions in macros can refer to debugger symbols. They cannot be referenced by the program in target memory.

If an initial value is specified for the debugger symbol, the value is loaded in the memory location referenced by the symbol. If an initial value is not specified, the memory location referenced by the symbol is set to zero.

See Also

Debugger Macro Add
Symbol Display
Symbol Remove

Examples

To add a program symbol of type int (default) at target memory address 9ff0h and set the memory location to value -1:

```
Symbol Add EOF Address 9ff0h Fill_Mem -1
```

To add a debugger symbol named str1 of type char referencing an eight-character array and fill the array with string 'abcdefgh':

```
Symbol Add char str1[8] Fill_Mem 'abcdefgh'
```

To add a debugger symbol of type short named s1 and fill the memory location with value 0x10203:

```
Symbol Add short s1 Fill_Mem 0x10203
```

In this example, we assigned a value to the symbol that is too large for the specified type. In this case, the debugger fills the memory location with the lower bytes of the specified value. Executing the command:

```
Expression Printf "%x",s1
```

shows that the value is 203, the lower two bytes of the specified value.

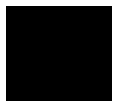

Symbol Browse

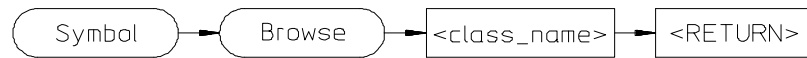

The Symbol Browse command displays the parents and children of a C++ class. The inheritance relationship is displayed in the Journal window.

Example

To display the parents and children of the C++ class *fruit*, type:

```
Symbol Browse fruit
```

Symbol Display

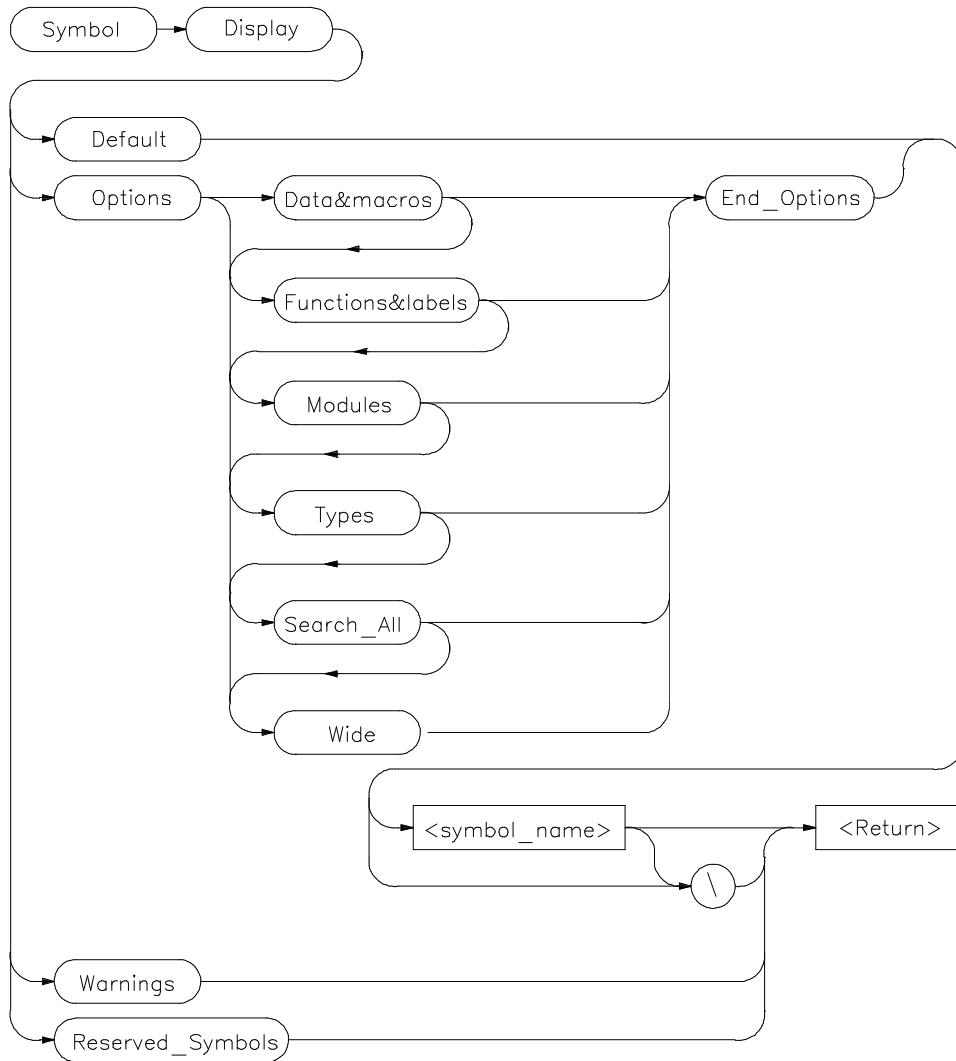

The Symbol Display command displays symbols and associated information in the Journal window.

Chapter 12: Debugger Coommands

Symbol Display

To display symbols in all modules, specify a backslash as the command argument.

```
Symbol Display Default \
```

To displays all symbols in a specified module or function, enter a module name or function name followed by a backslash.

```
Symbol Display Default memset\
```

The wildcard character * may be placed at the end of a symbol name with any option. The * can be used to represent zero or more characters. If used with no symbol name, * is treated the same as \, that is, all symbols are displayed.

If you enter a symbol name without a module specification, the debugger looks for the symbol in the current module. If there is no module qualifier, all symbols with the specified name will be displayed, including global symbols and symbols local to the module. Global symbols are not attached to a module.

```
Symbol Display Default dest
```

If you specify a structure name using the Types option, the debugger shows all members in the structure and their types.

Default

If you specify Default, the debugger displays all types of symbols.

Options

The following options may be specified to display subsets of symbols.

Data¯os	displays symbol name, storage class, data type, and addresses of data and macro symbols.
Functions&labels	displays symbol name, storage class, data type, return type, and addresses of functions and labels.
Modules	displays names, module type (high-level, assembly-level, or non-loaded), and section addresses of modules.
Types	displays all symbol types.

Search_All displays symbols of all types in all roots (contexts).

Wide shows symbol names only in multicolumn (compressed)
 format.

If you do not specify any options, the debugger displays all symbols.

Warnings

When you execute the Symbol Display Warnings command, the debugger displays type mismatches. Mismatches occur when global variables are declared with different types in different modules or global functions are declared with different return types or argument counts in different modules. The command displays all mismatches and the names of the modules in which the symbols are declared.

Reserved_Symbols

If you specify Reserved_Symbols, the debugger displays processor reserved symbols, registers, and internal debugger variables.

See Also

Symbol Add
Symbol Remove

Examples

To display the symbol 'updateSys' in the current module:

```
Symbol Display Default updateSys
```

```
Symbol Display Default updateSys
  @ecs\\updateSys   : Type is High level module.
                   Code section = 00001436 thru 00001C21
```

To display all symbols in module 'updateSys':

```
Symbol Display Default updateSys\
```

```
> Symbol Display Default updateSys\
  Root is: updateSys
      @ecs\\updateSys   : Type is High level module.
                          Code section = 00001436 thru 00001C21
  updateSys\update_state_of_system
                          : Type is Global Function returning void.
                          Address = 00001436 thru 00001513
```

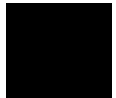

Chapter 12: Debugger Coommands

Symbol Display

```
update_state_of\refresh
      : Type is Local int.
      Address = Frame + 8
update_state_of\interval_complete
      : Type is Local int.
      Address = Frame + 12
:
:
```

To display all modules in the current symbol tree:

```
Symbol Display Options Modules End_Options \
```

```
Symbol Display Options Modules End_Options \
Root is: @ecs
      31 source and 23 assembler modules, 28 source procedures.
      Filename = ecs.x
@ecs\main      : Type is High level module.
                Code section = 00001050 thru 00001121
                Code section = 00000100 thru 0000010B
@ecs\initSystem : Type is NON-LOADED module.
                Code section = 00001122 thru 00001435
:
:
```

To display all function and labels in module 'main':

```
Symbol Display Options Function&labels End_Options main\
```

To display all reserved symbols:

```
Symbol Display Reserved_Symbols
```

To display all symbols in module systemInt in compressed format (symbol names only):

```
Symbol Display Options Wide End_Options systemInt\
```

```
Symbol Display Options Wide End_Options systemInt\
Root is: systemInt
systemInt\      system_interrupt function
struct_system_clock hours      minutes
seconds
tick_clock function argument_1  system_interrupt
tick_clock      time      reg_param1
increment
```

To display all data and macros found within any symbol tree (that is, search \\, @a.out\\, @file1\\, etc.):

Symbol Remove

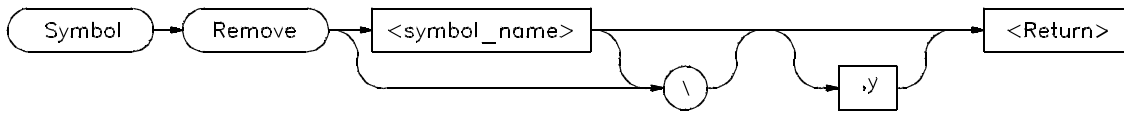

The Symbol Remove command removes the specified symbol from the symbol table. Only program symbols and user-defined debugger symbols can be deleted from the symbol table.

To delete all symbols within a named module or function, append a backslash (\) to the module or function name (< symbol_name>).

```
Symbol Remove updateSys\
```

Entering a backslash without a module or function name deletes all symbols in all modules.

```
Symbol Remove \
```

If you specify a symbol name without a module specification, the debugger looks for the symbol in the current module.

If you specify more than one symbol to be deleted or if the specified symbol has local symbols (for example, when a macro is deleted), the debugger requests confirmation. Entering ,y after the symbol name provides automatic confirmation of the request. This option is useful in command files.

The debugger lets you add a debugger symbol with the same name as a target module's local symbol or a predefined macro's local symbol. If you do add a debugger symbol with same name as a local symbol, you must specify the entire symbol name with the Symbol Remove command in order to remove it. For example, if you added the debugger symbol *alter_settings* when running the demonstration program, you must enter `\\alter_settings` instead of *alter_settings* to delete the symbol because there is a local symbol *alter_settings* in target module *updateSys*. Otherwise the error message *error # 152, Cannot delete: more than one symbol with this name* is displayed.

See Also

Symbol Add
Symbol Display

Examples

To delete symbol 'current_targets' in function 'alter_settings':

```
Symbol Remove alter_settings\current_targets
```

To delete all symbols in module 'updateSys':

```
Symbol Remove updateSys\
```

To delete symbol 'alter_settings' in module 'updateSys':

```
Symbol Remove updateSys\alter_settings
```

In this example, the symbol being removed is a function which contains other symbols. The debugger prompts you with the message 'This symbol has a sub-tree. Delete with sub-tree? (Y/N)'. Enter 'Y' to delete the symbol and its sub-tree. If you respond with 'N', the command is canceled.

To delete all symbols in all modules:

```
Symbol Remove \
```



Trace Again



The Trace Again starts a trace using the last (previous) trace specification. The trace starts on the next program run or step command.

If no trace has been previously specified, this command is equivalent to entering a *Trace Trigger Never* command, and states are collected until you enter a *Trace Halt* command.

Example

To start a new trace using the last trace specification:

`Trace Again`

Trace deMMUer

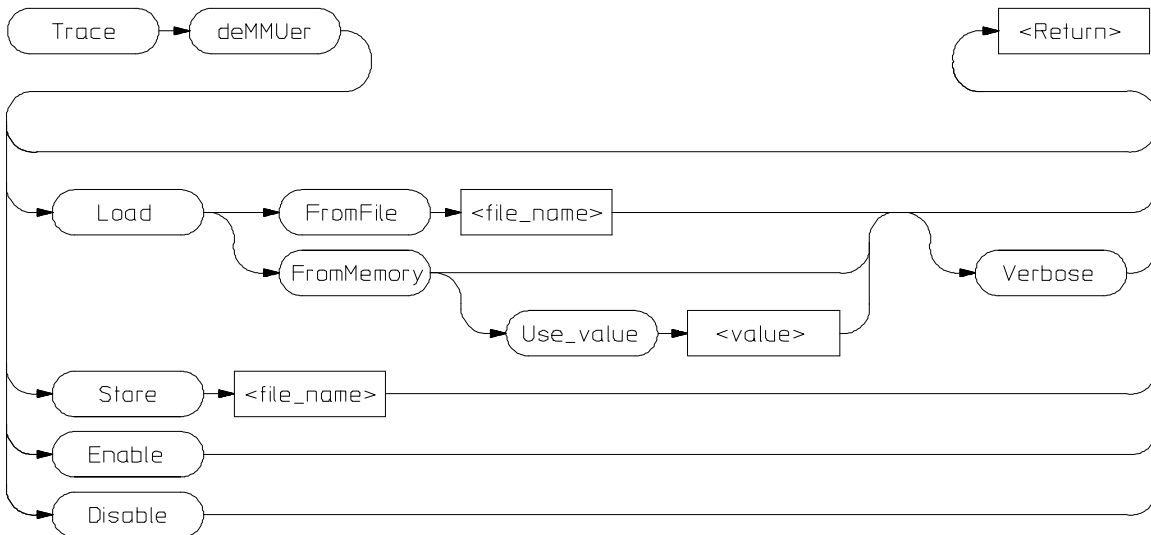

64783S24

The Trace deMMUer command allows you to choose between tracing physical addresses and tracing logical addresses.

You must enable the MMU before tracing MMU activity. The *MC68040/EC040/LC040 Emulator, Graphical User Interface User's Guide* describes how to use the emulator configuration commands and the TC register to enable the MMU.

Load

The Trace deMMUer Load command reads the MMU registers and MMU tables, and loads the deMMUer with the appropriate information to reverse-translate physical addresses to logical addresses.

The MMU hardware information can be read from a previously stored setup (fromFile), from the current information in memory (fromMemory), or from current tables and user-specified MMU register values (Use_value).

The Verbose option shows a list of the physical addresses that can be translated by the deMMUer.

Store

The Trace deMMUer Store command stores the current deMMUer setup to a file. The file will be saved with the ".ED" extension. This file may be edited if you wish to view or change the deMMUer setup.

Enable

The Trace deMMUer Enable command turns on the deMMUer. Physical addresses on the emulation bus will be translated to logical addresses.

Disable

The Trace deMMUer Disable command turns off the deMMUer. Physical addresses on the emulation bus will not be translated.

See Also

The "Using MC68030 Memory Management" chapter in the *MC68040/EC040/LC040 Emulator, Graphical User Interface User's Guide*.

Examples

To translate physical to logical addresses, make sure that the MMU has been set up, then enter:

```
Trace deMMUer Load Verbose  
Trace deMMUer Enable
```

To stop translating physical to logical addresses, enter:

```
Trace deMMUer Disable
```

Trace Display

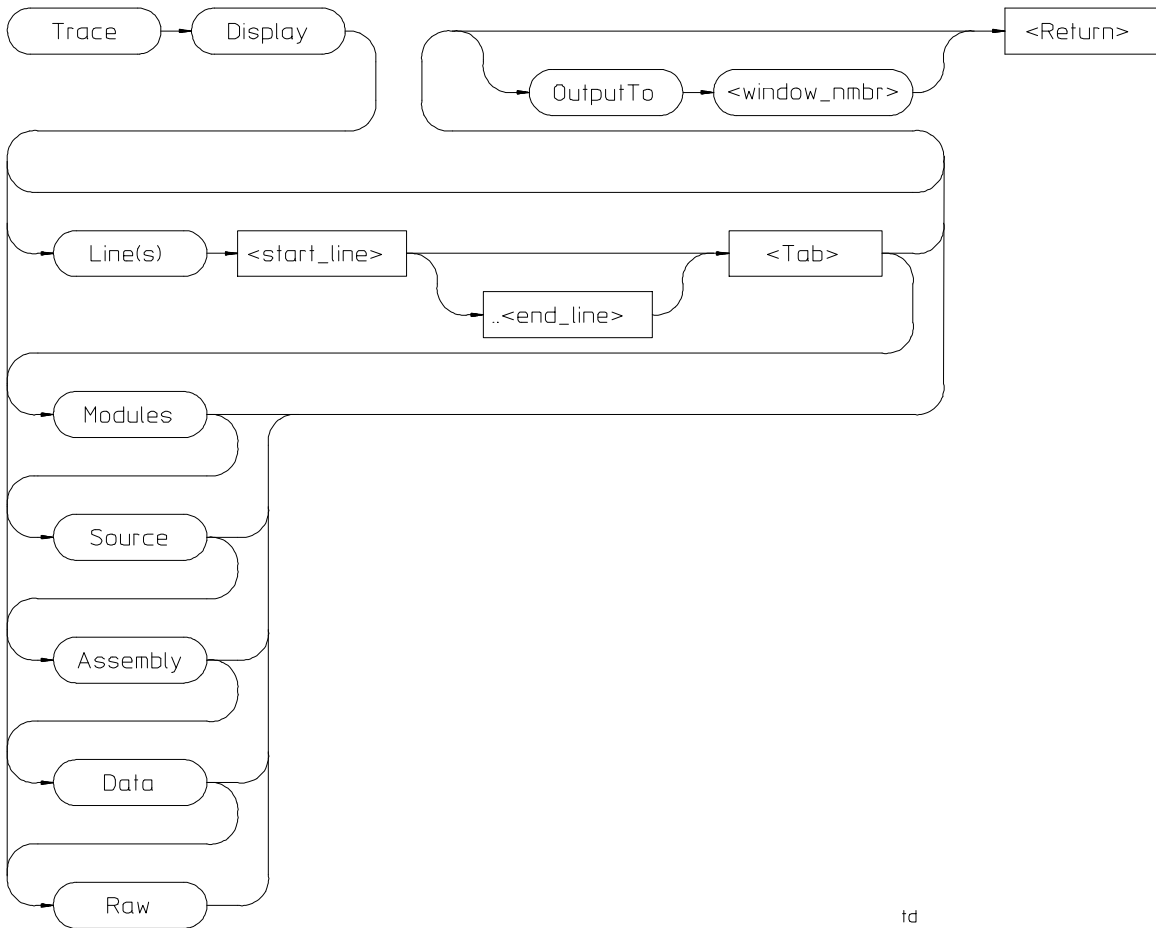

The Trace Display command displays trace information in the specified window. If no window is specified, the trace output will go to the Trace Mode window, and the debugger will enter "trace mode."

Chapter 12: Debugger Coommands

Trace Display

Data may be displayed (interpreted) in several ways: from module and function entry and exit points, to raw bus data. The default display will show modules and source line references only.

Trace mode

In trace mode, the trace information is displayed in the View window. You cannot enter debugger commands from the command line while in trace mode. To return to debugger command mode, press the *ESC* key twice.

In trace mode, you can use the cursor keys to scroll the trace information in the View window. Use the Next and Prev keys to page through the trace output.

Function keys Function keys *F1*, *F3*, *F4* and *F5* do their normal functions when you are in trace mode. However, *F1* (Next Window) activates only the Code or Trace Mode windows. You can use the *F3* function key to switch between the high-level and assembly-level displays in the Code window when tracking trace data.

F2, *F6*, *F7*, and *F8* have special functions when in the trace mode. Function key *F2* lets you enter a new line number to display at the top of the trace list display. The *F6* function key changes the track direction (backward or forward) in the trace window. The *F7* function key scrolls the trace list up or down in the Trace Mode window and updates the Code window so that the highlighted line corresponds to the new first line displayed in the Trace Mode window. The *F8* function key toggles the top line high-level module identification on or off to allow an extra line of trace information to be displayed. The top line high-level module identification must be on to enable tracking.

Tracking source code The debugger gives you the capability to correlate the data in the trace display with source code displayed in the Code window. To view trace information in relationship to the source code, select a line in the trace list with the cursor and then press **F7** or the **Return** key. This updates the Code window so that the highlighted line in the code window corresponds to the first line displayed in the Trace Mode window. Pressing *F7* or the *Return* key again scrolls the trace list in the Trace Mode window and updates the Code window so that the highlighted line corresponds to the new first line displayed in the Trace Mode window.

Press the **F6** function key to change the track direction (backward or forward) in the Trace Mode window. The trace direction is indicated on the bottom

border of the Trace Mode window (^ or v). The symbols show which direction the search will proceed through the trace buffer to find the next high-level or assembly code line (depending on the Code window selected). If the trace window has no lines that correspond to code lines, the search will proceed to the end of the trace buffer.

If you have specified storage qualifiers, the trace data may not track sequentially with the lines in the code display.

Directing output to a specified window or file

Use the OutputTo keyword to redirect trace output to a window or file other than the View window. The following values are valid window numbers for trace output:

1	high-level Journal window
10	assembly-level Journal window
24	View window
28	log file
29	journal file
50 – 256	user-defined windows

Line(s) keyword

Use the Line(s) keyword to specify a range of lines to be copied from the trace buffer to the specified window. For example, to copy lines -110 through -90 from the trace buffer to the journal file, enter the command:

```
Trace Display Line(s) -110..-90 <Tab> OutputTo 29
```

You cannot specify a line range for trace output when entering trace mode. However, you may specify the first line to display in trace mode. For example, to display the trace buffer starting at line -110, enter the command:

```
Trace Display Line(s) -110
```

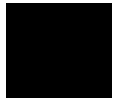

Display qualifiers

The following display qualifiers let you select what information is written to the output window and how the information is formatted.

Line(s)	Specifies the starting line or the range of lines to display or copy. Line 0 is the trigger cycle. You cannot specify a range when entering trace mode.
Modules	Displays names of module the trace lines are in, entering, or re-entering. This is useful for showing general program flow.
Source	Display the source lines and line numbers corresponding to instruction fetches.
Assembly	Displays assembly language instructions. Information is displayed symbolically when possible.
Data	Displays address, value, and read/write status for data accesses. Information is displayed symbolically when possible.
Raw	Display the frame number, address, data and status for a bus cycle with no interpretation of the data.

Displaying status information Status information is displayed mnemonically in the trace list. The following table describes the mnemonics that may be displayed.

Mnemonic	Description
----------	-------------

Function Code Space

Alt FC0	Alternate logical function code 0
Alt FC3	Alternate logical function code 3
Alt FC4	Alternate logical function code 4
Alt FC7	Alternate logical function code 7
Alt Rsrvd	Alternate logical function code reserved
Brkpt Ack	Breakpoint acknowledge
Data Cache Push	Data Cache Push
Level 1	Interrupt acknowledge level 1

Level 2	Interrupt acknowledge level 2
Level 3	Interrupt acknowledge level 3
Level 4	Interrupt acknowledge level 4
Level 5	Interrupt acknowledge level 5
Level 6	Interrupt acknowledge level 6
Level 7	Interrupt acknowledge level 7
MMU Code	MMU Table Search Code
MMU Data	MMU Table Search Data
MOVE16 Supv	MOVE16 supervisor data access
MOVE16 User	MOVE16 user data access
TM 7	Transfer modifier 7 - reserved
Supv Data	Supervisor data
Supv Prog	Supervisor program
User Data	User data
User Prog	User program

Cycle Type

Code Fetch	Cycle was a code fetch
DMA cycle	Cycle was a DMA cycle
Read	Cycle was a read cycle
Write	Cycle was a write cycle
Intr Ack	Cycle was a interrupt acknowledge cycle

Trace status character When trace data is displayed, a trace status character may be displayed in front of the trace line. The following table defines the trace status characters.

Trace List Status Characters

Character	Description
*	The indicated trace line is the trigger condition.
+	The indicated trace line is an assembly language statement within a high-level statement, that is, not the first assembly language statement in the high-level source statement.
!	The data field in the trace buffer line does not match the data in memory.

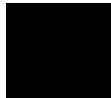

Chapter 12: Debugger Coommands
Trace Display

? The trace line may be a prefetch.

Examples

To display source lines, their corresponding assembly language instructions, and data read and write cycles:

Trace Display Modules Source Assembly Data

To copy the raw data in lines -20 through + 20 of the trace buffer to a log file you have opened:

Trace Display Lines -20..20 <Tab> Raw OutputTo 28

Trace Event Clear_All

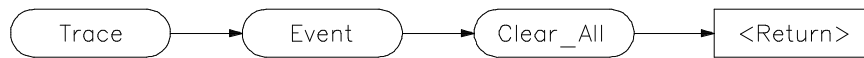

The Trace Event Clear_All command clears (removes) all specified events that are not used by the trigger or store qualifier.

See Also Trace Event Delete

Examples To clear (remove) all defined trace events:

`Trace Event Clear_All`



Trace Event Delete



The Trace Event Delete command deletes (removes) a previously defined event specification. You cannot delete an event that is used by the trigger or store qualifier.

See Also Trace Event Clear_All
 Trace Event Specify

Examples To delete event 2:
 `Trace Event Delete 2`



Trace Event List



The Trace Event List command lists the definition of the event specified by < event_nmbr> in the View window. The definition includes address, data, and status. The command used to define the event is listed, as well as an indication if the event is used by the trigger or qualifier.

See Also Trace Event Specify

Examples To list the definition of event 3 in the View window:

`Trace Event List 3`



Trace Event Specify

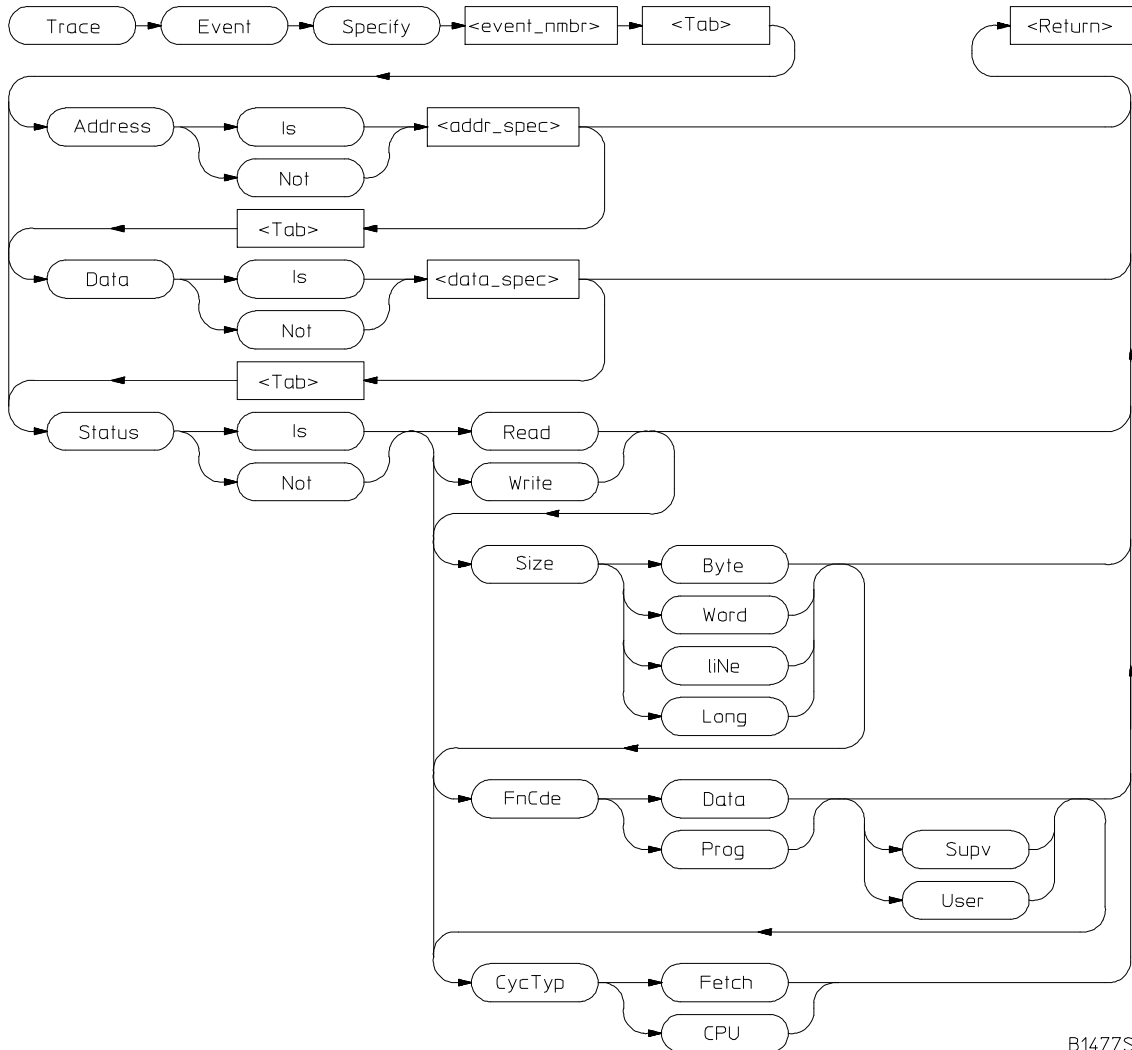

B1477S03

The Trace Event Specify command defines an event (detectable bus condition to be used for trace qualifying or triggering. The event number (< event_nمبر>) must be a number between 1 and 30 inclusive. Bus

conditions may be address values, data values, or status values. The event is true if all of the terms defined in the event are true at the same time.

Event conditions

Three types of conditions can be specified in an event definition. The three condition types are:

Address	The value that appears on the address bus. The address term matches an address, range of addresses, or out-of-range addresses.
Data	The value that appears on the data bus. The data term matches a data value or range of values. The data size is that of the data field as specified by the analyzer. This typically matches the processor bus size.
Status	The type of bus activity, for example: instruction fetch, read, write, CPU, etc.

If you use the keyword **Is**, the event is defined as the specification that follows. If you use the keyword **Not**, the event is defined as the logical NOT of the specification that follows, that is, any condition that does not match the specification. For example, if you enter the specification:

```
Trace Event Specify 1 <Tab> Address Is 0x10b6..0x123d
```

event 1 is defined to be any address in the range 0x10b6 through 0x123d. If you enter the specification:

```
Trace Event Specify 1 <Tab> Address Not 0x10b6..0x123d
```

event 1 is defined to be any address **outside** the range 0x10b6 through 0x123d.

Address and data values

Address values (*<addr_spec>*) and data values (*<data_spec>*) are specified as 32-bit values or a range of 32-bit values denoted by (..). You can specify address values using module names, symbols, and high-level line numbers. See the “Expressions and Symbols in Debugger Commands” chapter for detailed information on how to specify addresses.

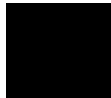

Chapter 12: Debugger Coommands

Trace Event Specify

A mask can be used to specify a range with a 32-bit value that marks valid bits in addresses or data. For example, to specify only addresses in the range *000015xxh* (where *xx* are "don't care" values), you could enter the command:

```
Trace Event Specify 4 <Tab> Address Is
0x1500 &= 0xffffffff00
```

The `&=` is the bit mask operator. This range could also have been specified as `0x1500..0x15ff`.

Status values

Status conditions are the types of bus activities you wish to specify. The following keywords are used to specify the status condition:

Read	specifies read operation
Write	specifies write operation
Size	specifies access size (byte, word, line, or long)
FnCde	specifies function code (data or program, supervisor or user mode)
CycTyp	specifies cycle type (Fetch, DMA, or IntAck)

Addresses specified with a `CycTyp` of `Fetch` will be masked to the size specified by Debugger Option `Trace Fetch_Align`.

See Also

Trace Event `Clear_All`
Trace Event `Delete`
Trace Event `List`
Debugger Option `Trace Fetch_Align`

Examples

To define event 1 to be the address of function `update_state_of_system`:

```
Trace Event Specify 1 <Tab> Address Is
update_state_of_system
```

To define event 2 to be any bus cycle corresponding to an instruction fetch:

```
Trace Event Specify 2 <Tab> Status Is CycTyp Fetch
```

To define event 3 to be a write access of variable current_humid:

```
Trace Event Specify 3 <Tab> Address Is  
&current_humid <Tab> Status Is Write
```

If an 8-bit wide I/O port at 0fxx0010h has a "data valid" bit at bit 3, you can specify a trace event when the "data valid" bit is read by entering:

```
Trace Event Specify 5 <Tab> Address Is  
0f0000010 &= 0xf000ffff <Tab> Data Is 0x8 &= 0xff
```

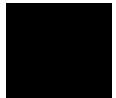

Trace Event Used_List



The Trace Event Used_List command lists the numbers of the events that are currently defined and whether or not the event is being used (specified in a Trace Trigger or Trace StoreQual definition).

See Also

Trace Event Specify
Trace Trigger Event
Trace StoreQual Event

Examples

To list the currently defined events and their status (used or not used):

```
Trace Event Used_List
```

Trace Halt



The Trace Halt command stops (terminates) the trace currently being executed. If a trace is not in progress, this command has no effect. After executing this command, you can display any trace data collected.

See Also Trace Again

Examples To stop the current trace:

`Trace Halt`



Trace StoreQual

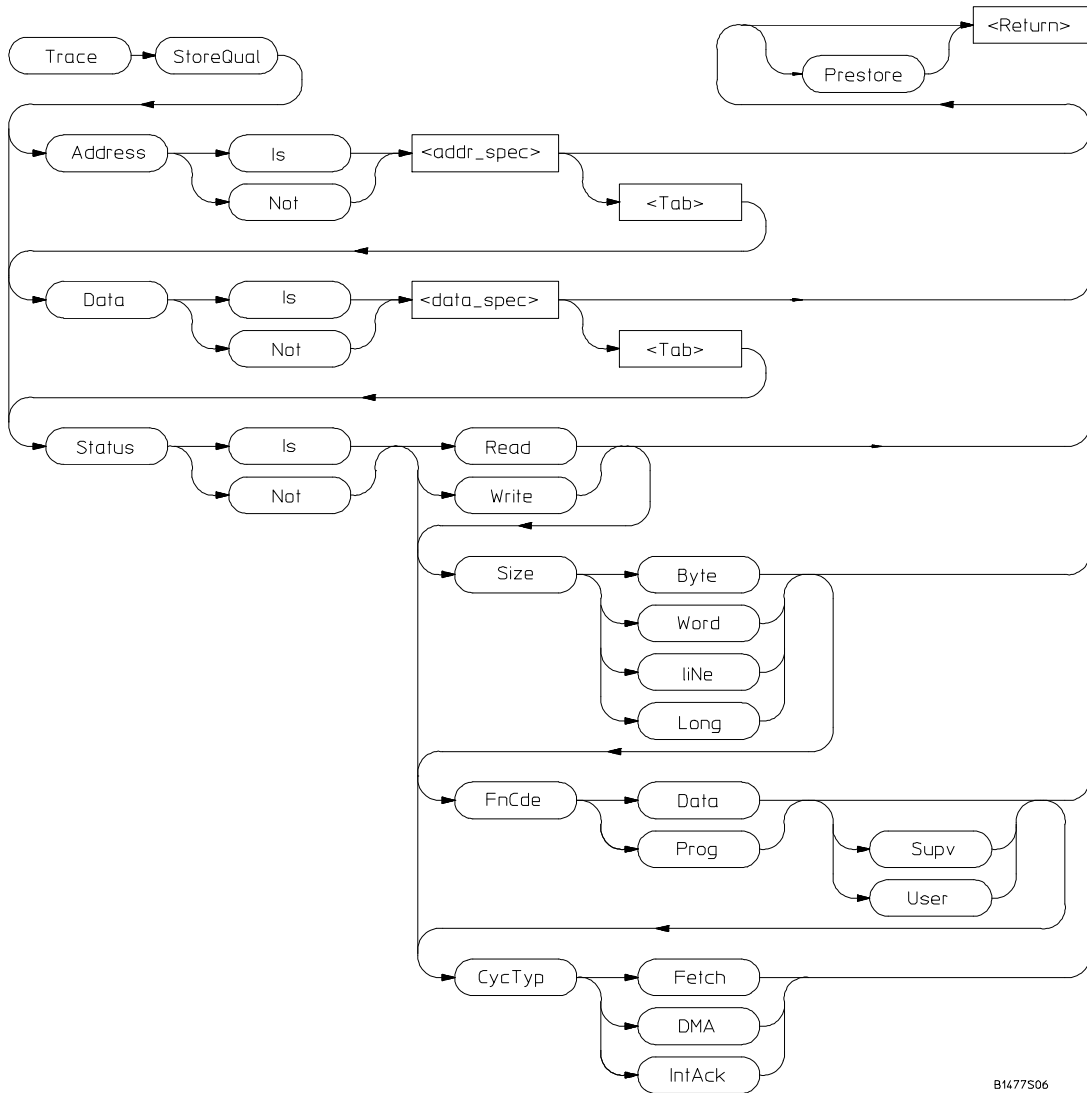

B1477506

The Trace StoreQual command immediately specifies the bus conditions to be stored (captured) in the trace buffer. Bus conditions may be address values, data values, or status values. When you define a storage qualifier, you are

essentially defining an event. You can also use the *Trace Event Specify* command to define an event, and then use the *Trace StoreQual Event* command to use the specified event as a storage qualifier term.

Storage qualifier conditions

Three types of conditions can be specified as storage qualifiers. The three condition types are:

Address	The value that appears on the address bus
Data	The value that appears on the data bus
Status	The type of bus activity, for example, instruction fetch, read, write, CPU, etc.

If you use the keyword **Is**, bus cycles matching the specification that follows are stored in the trace buffer. If you use the keyword **Not**, the storage qualifier is defined as the logical NOT of the specification that follows, that is, any bus cycles that do not match the specification are stored in the trace buffer. For example, if you enter the specification:

```
Trace StoreQual Address Is 0x10b6..0x123d
```

the storage qualifier is defined to be any address in the range 0x10b6 through 0x123d. If you enter the specification:

```
Trace StoreQual Address Not 0x10b6..0x123d
```

the storage qualifier is defined to be any address **outside** the range 0x10b6 through 0x123d.

Address and data values

Address values (<*addr_spec*>) and data values (<*data_spec*>) are specified as 32-bit values or a range of 32-bit values denoted by (..). You can specify address values using module names, symbols, and high-level line numbers. See the “Expressions and Symbols in Debugger Commands” chapter for detailed information on how to specify addresses.

A mask can be used to specify a range with a 32-bit value that marks valid bits in addresses or data. For example, to store only addresses in the range

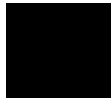

Chapter 12: Debugger Coommands

Trace StoreQual

0x000015xx (where *xx* are "don't care" values), you could enter the command:

```
Trace StoreQual Address Is
0x1500 &= 0xffffffff00
```

where `&=` is the bit mask operator.

This format is used because the C language does not have a way to represent a don't care literal.

Note

Execute the *Debugger Execution Environment Unrestricted* command before specifying an event with an address to ensure that the analyzer interprets the chip selects properly for the address. See the description of the *Debugger Execution Environment Unrestricted* command.

Status values

Status conditions are the types of bus activities you wish to specify. The following keywords are used to specify the status condition:

Read	specifies read operation
Write	specifies write operation
Size	specifies access size (byte, word, or long)
FnCde	specifies function code (data or program, supervisor or user mode)
CycTyp	specifies cycle type (Fetch or CPU)

Addresses specified with a `CycTyp` of `Fetch` will be masked to the size specified by Debugger Option `Trace Fetch_Align`.

Prestore

Specifying *Prestore* in your storage qualifier definition causes the trace function to store up to two instruction fetch cycles preceding the qualified condition being stored. This lets you view the instructions leading up to the qualified state.

See Also

Trace StoreQual Event
Trace StoreQual List
Trace StoreQual None
Debugger Option Trace Fetch_Align

Examples

To store accesses to *update_state_of_system* along with the two bus cycles immediately preceding the accesses.

```
Trace StoreQual Address Is update_state_of_system  
Prestore
```

To store only instruction fetches with an opcode value of *4e5x* where *x* is a don't care value:

```
Trace StoreQual Data Is 0x4e50 &= 0xffff0 <Tab> Status  
Is CycTyp Fetch
```

The don't care condition is specified by specifying a mask in the data specification. *&=* is the mask operator. This value corresponds to the LINK and UNLK instructions.

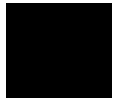

Trace StoreQual Event

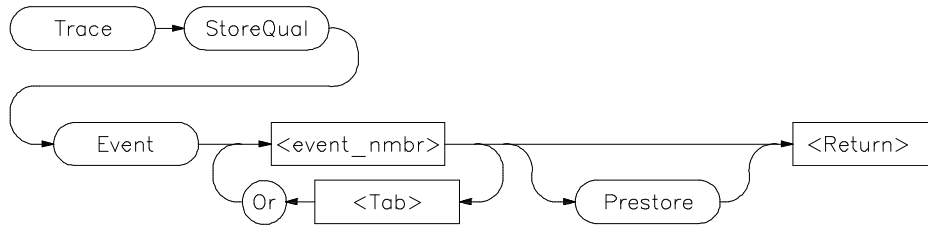

The Trace StoreQual Event command lets you specify an event or combination of events defined with the *Trace Event Specify* command as the storage qualifier.

Events

Each event that you define using the Trace Event Specify command is assigned an event number between 1 and 30. This number (< event_nmbr >) is used to assign an event to be a storage qualification term. The storage qualification term can be a single event or a logically OR'ed combination of events.

Prestore

Specifying *Prestore* in your storage qualifier definition causes the trace function to store up to two instruction fetch cycles preceding the qualified condition being stored. This lets you view the instructions leading up to the qualified state.

See Also

Trace StoreQual
Trace StoreQual List
Trace StoreQual None

Examples

To store only states matching event 1 defined with the Trace Event Specify command and the last two instruction fetches preceding each of these states:

```
Trace StoreQual Event 1 <Tab> Prestore
```

Chapter 12: Debugger Coommands
Trace StoreQual Event

To store only states matching event 1 or event 2 defined with the Trace Event
Specify command:

Trace StoreQual Event 1 <Tab> Or 3



Trace StoreQual List



The Trace StoreQual List command displays the current storage qualification definition in the View window.

See Also Trace StoreQual
 Trace StoreQual event

Examples To list the current storage qualification definition in the View window:
 Trace StoreQual List



Trace StoreQual None

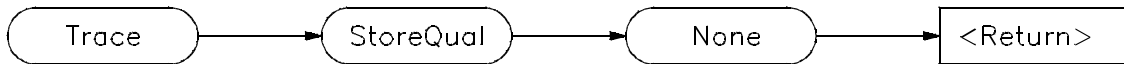

The Trace StoreQual None command causes the trace function to store all bus cycles (no trace qualification).

See Also Trace StoreQual
 Trace StoreQual event

Examples To store all bus cycles (no trace qualification):
 Trace **S**StoreQual **N**None



Trace Trigger

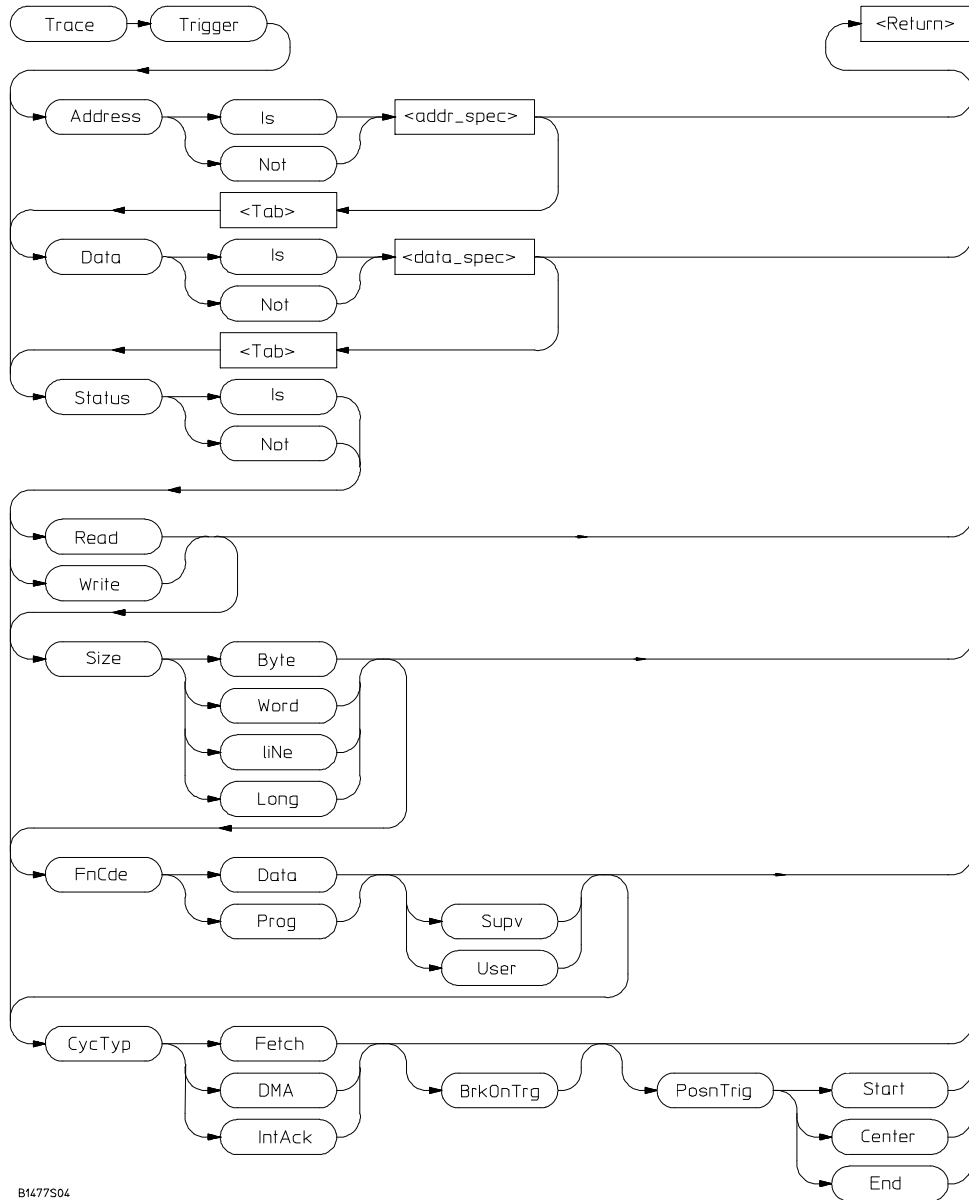

B1477S04

The Trace Trigger command specifies the bus conditions to be used as the trigger condition. Bus conditions may be address values, data values, or status values. When you define a trigger, you are essentially defining an event. You can also use the *Trace Event Specify* command to define an event, and then use the *Trace Trigger Event* command to use the specified event as the trigger event.

Trigger conditions

Three types of conditions can be specified in triggers. The three condition types are:

Address	The value that appears on the address bus
Data	The value that appears on the data bus
Status	The type of bus activity, for example, instruction fetch, read, write, interrupt acknowledge, etc.

If you use the keyword **Is**, bus cycles matching the specification that follows are used as the trigger event. If you use the keyword **Not**, the trigger is defined as the logical NOT of the specification that follows, that is, any bus cycle that does not match the specification is the trace trigger. For example, if you enter the specification:

```
Trace Trigger Address Is 0x10b6..0x123d
```

the trigger is defined to be any address in the range 0x10b6 through 0x123d. If you enter the specification:

```
Trace Trigger Address Not 0x10b6..0x123d
```

the trigger is defined to be any address **outside** the range 0x10b6 through 0x123d.

Address and data values

Address values (*<addr_spec>*) and data values (*<data_spec>*) are specified as 32-bit values or a range of 32-bit values denoted by (..). You can specify address values using module names, symbols, and high-level line numbers. See the “Expressions and Symbols in Debugger Commands” chapter for detailed information on how to specify addresses.

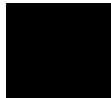

Chapter 12: Debugger Coommands

Trace Trigger

A mask can be used to specify a range with a 32-bit value that marks valid bits in addresses or data. For example, to trigger only on addresses in the range *0x000015xx* (where *xx* are "don't care" values), you could enter the command:

```
Trace Trigger Address Is
0x1500 &= 0xffffffff00
```

where *&=* is the bit mask operator.

Status values

Status conditions are the types of bus activities you wish to specify. The following keywords are used to specify the status condition:

Read	specifies read operation
Write	specifies write operation
Size	specifies access size (byte, word, or long)
FnCde	specifies function code (data or program, supervisor or user mode)
CycTyp	specifies cycle type (Fetch or CPU)

Addresses specified with a *CycTyp* of *Fetch* will be masked to the size specified by Debugger Option *Trace Fetch_Align*.

Breaking on triggers

Enter the *BrkOnTrg* keyword to cause the user program to halt when the trigger term is detected.

Trigger position

Enter the *PosnTrig* keyword to specify the position of the trigger condition in the trace buffer. You can specify the trigger position to be one of the following:

Start The trigger is at the start of the trace buffer.

Center The trigger is centered in the trace buffer.

End The trigger is at the end of the trace buffer.

The trigger state will always be line number 0 in the trace list.

Interaction with trace commands

The Trace Trigger, Breakpt Access, Breakpt Read, and Breakpt Write commands all require use of emulation analyzer resources. If access breakpoints are active (indicated by the message *TRC: BrkRWA* on the status line), then a Trace Trigger command may not be entered. If a trace trigger is active, access breakpoints may not be entered.

The Breakpt commands set up a trace with the trigger at the end of the trace buffer, using the current storage qualification. You can display the trace after the break occurs to see the cycles leading up to the break.

See Also

Breakpt Access
Breakpt Read
Breakpt Write
Trace Trigger Event
Trace Trigger List
Trace Trigger None
Debugger Option Trace Fetch_Align

Examples

To trigger the trace measurement on entry into function *update_state_of_system* and position the trigger state in the center of the trace memory buffer:

```
Trace Trigger Address Is update_state_of_system <Tab>  
Status Is PosnTrig Center
```

To trigger the trace measurement on the occurrence of a write to variable *time_struct.seconds*, and halt (break) program execution on detection of the trigger condition:

```
Trace Event Specify 6 <Tab> Address Is  
&time_struct.seconds <Tab> Data Is 0x3c Status Is Write  
<Tab> BrkOnTrg
```

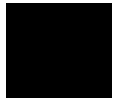

Trace Trigger Event

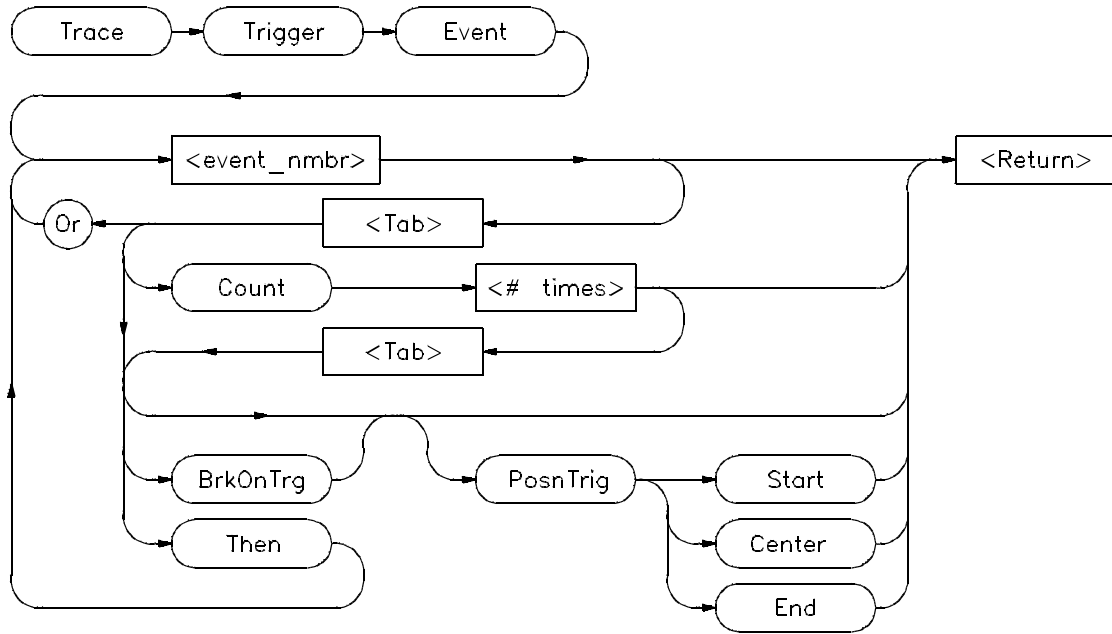

The Trace Trigger Event command lets you specify an event or combination of events defined with the *Trace Event Specify* command as a trigger condition. The trigger condition can be a single event, a logically OR'ed combination of events, a specified number of occurrences of an event or combination of events, or a sequence of the preceding conditions. The complexity of the specification is limited by the analyzer.

Event Number

Each event that you define using the Trace Event Specify command is assigned an event number between 1 and 30. This number (< event_nmbr >) is used to assign an event to be a trigger term.

Keywords

- Or** The *Or* keyword lets you specify a logically OR'ed combination of events as the trigger condition.
- Count** The *Count* keyword specifies the number of times (<*nmbr_times*>) an event or OR'ed combination of events must occur before the debugger proceeds to the next trigger sequence term or before the trigger condition is completed. <*nmbr_times*> must be a value in the range of 1 to 65535.
- Then** The *Then* keyword lets you specify a sequence of terms in the trace specification.
- BrkOnTrg** The *BrkOnTrg* keyword causes the user program to halt when the trigger term is detected.
- PosnTrig** The *PosnTrig* keyword is used with the *Start Center*, and *End* keywords to specify the position of the trigger condition in the trace buffer.
- Start** The *Start* keyword specifies the start of the trace buffer as the trigger position.
- Center** The *Center* keyword specifies the center of the trace buffer as the trigger position.
- End** The *End* keyword specifies the end of the trace buffer as the trigger position.

The trigger state will always be line number 0 in the trace list.

See Also

- Trace Trigger
- Trace Trigger List
- Trace Trigger None

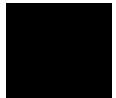

Examples

To trigger on the occurrence of event 1 which has been previously defined with the Trace Event Specify command:

Chapter 12: Debugger Coommands
Trace Trigger Event

```
Trace Trigger Event 1
```

To trigger on the occurrence of either event 1 or event 3 (events 1 and 3 must have been previously defined with the Trace Event Specify command):

```
Trace Trigger Event 1 <Tab> Or 3
```

To trigger on the fifth occurrence of event 3 following an occurrence of event 1 (events 1 and 3 must have been previously defined with the Trace Event Specify command):

```
Trace Trigger Event 1 <Tab> Then 3 <Tab> Count 5
```

Trace Trigger List

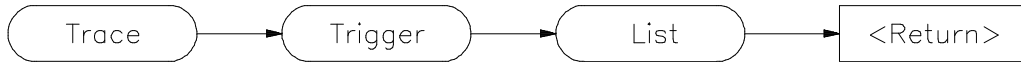

The Trace Trigger List command displays the current trigger definition in the View window.

See Also

Trace Trigger
Trace Trigger List
Trace Trigger None

Examples

To list the current trigger definition in the View window:
`Trace Trigger List`



Trace Trigger Never

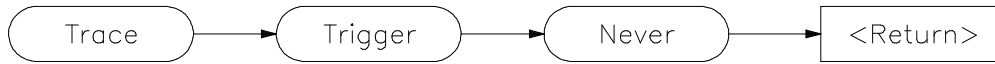

The Trace Trigger Never command sets the trace function up to collect states until you stop the trace using the Trace Halt command. Collection starts on the next program run or step command.

See Also

Trace Halt

Examples

To collect states continuously until the trace is stopped using the Trace Halt command:

Trace Trigger Never

Collection starts on the next program run or step command.

Window Active

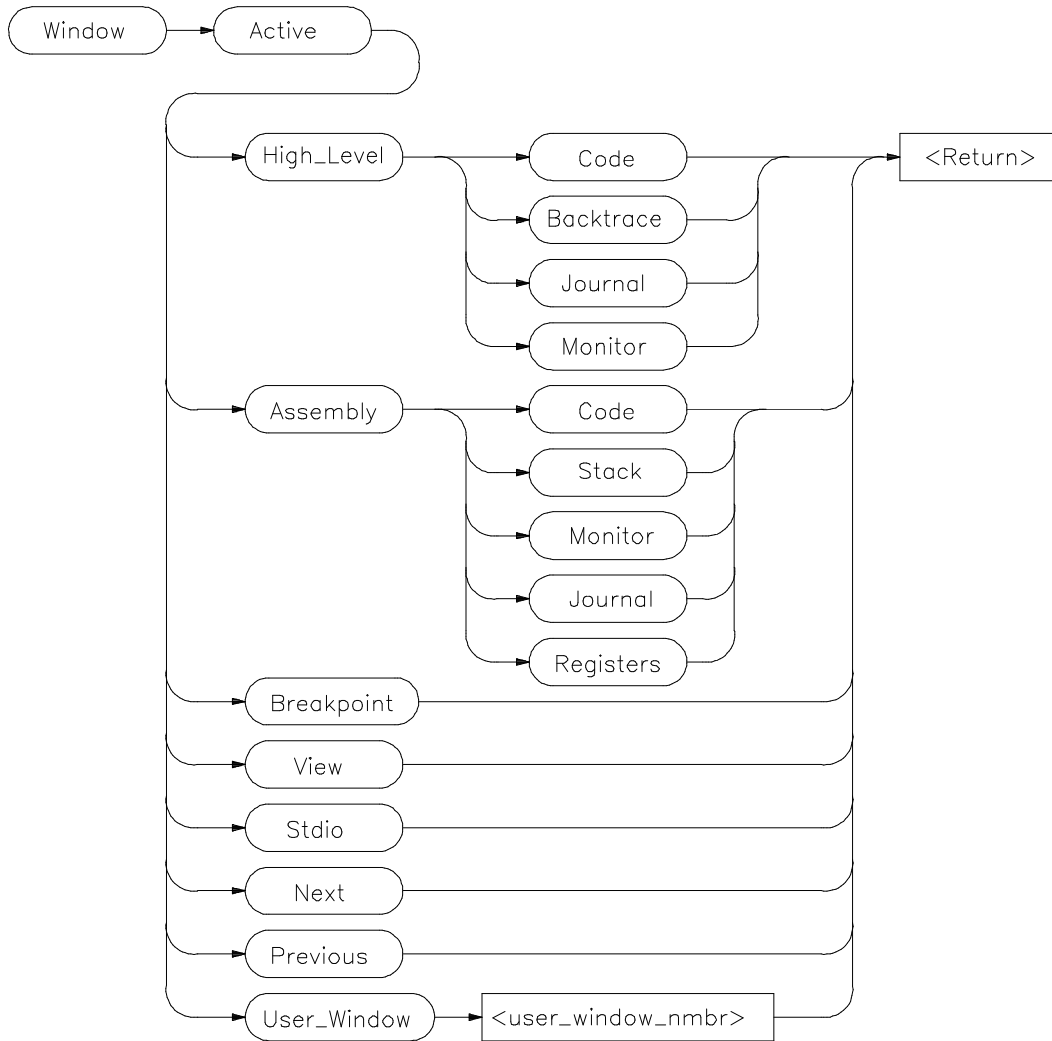

The Window Active command activates the specified window. The border of the active window is highlighted. The Code window is active by default within the high level and low level screens.

Chapter 12: Debugger Coommands

Window Active

The Next and Previous parameters specify the next higher-numbered or lower-numbered window relative to the active window.

The cursor keys and the F4 function key only operate in the active window.

The Error, Help, and Status windows cannot be made active.

See Also

Window Cursor
Window Delete
Window Erase
Window New
Window Resize
Window Screen_On
Window Toggle_View

Examples

To make the high-level Backtrace window active:

```
Window Active High_Level Backtrace
```

To make the assembly Code window active:

```
Window Active Assembly Code
```

To make user window 57 active:

```
Window Active User_Window 57
```

Window Cursor

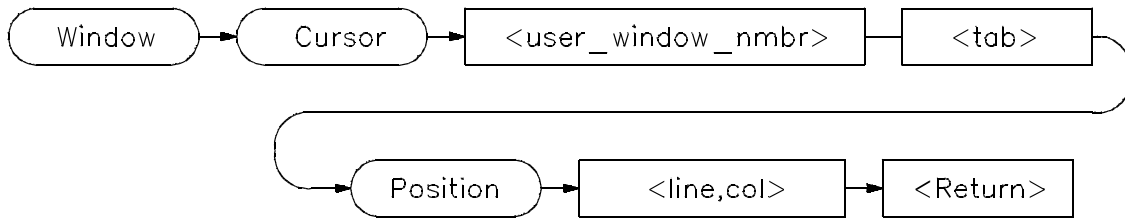

The Window Cursor command sets the cursor position in the window specified by < user_window_nmbr> . The top left corner of the window is represented by coordinates 0,0.

Subsequent output to the window begins at the cursor position.

Only user-defined windows and the standard I/O window (window No. 20) may be specified with this command.

See Also

Window Active
Window Delete
Window Erase
Window New
Window Resize
Window Screen_On
Window Toggle_View

Examples

To move the cursor to line 5, column 22 in the Stdio window:

```
Window Cursor 20 Position 5,22
```

To move the cursor to line 3, column 0 in user window 57:

```
Window Cursor 57 Position 3,0
```

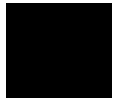

Window Delete

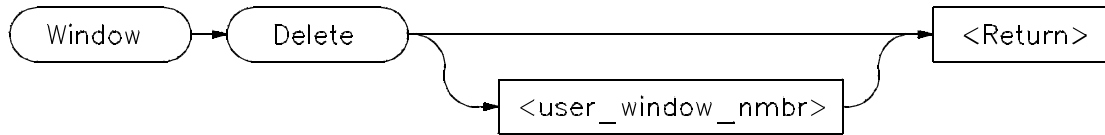

The Window Delete command removes a window (possibly a screen) defined previously with the Window New command. Remove a window by entering the window's associated window number. If you do not specify a window number or if you specify 0, the active window is removed.

Remove screens by removing all windows associated with that screen. For example, if a user-defined screen has three windows and you delete all three windows, the screen will be deleted as well. See the "Displaying Screens" and "Displaying Windows" sections of the "Viewing Code and Data" chapter for more information about window and screen numbers. Predefined debugger windows and screens cannot be removed.

Files opened with the File User_Fopen command may also be closed with this command.

See Also

File User_Fopen
File Window_Close
Window Active
Window Cursor
Window Erase
Window Open
Window Resize
Window Screen_On
Window Toggle_View

Example

To delete user window 57:

```
Window Delete 57
```

Window Erase

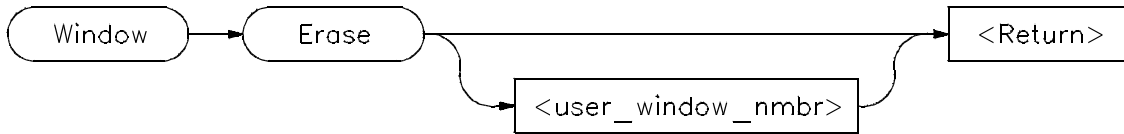

The Window Erase command clears all displayed information in the specified window. It then places the cursor in the specified window to the 0,0 position. If you do not specify a window number or if you specify 0, the active user-defined window is cleared. Only user-defined windows and the standard I/O screen (window No. 20) can be cleared. This command is primarily for use within macros.

See Also

Window Active
Window Cursor
Window Delete
Window New
Window Resize
Window Screen_On
Window Toggle_View

Examples

To clear all displayed information in the Stdio window:

```
Window Erase 20
```

To clear all displayed information in user window 57:

```
Window Erase 57
```



Window New

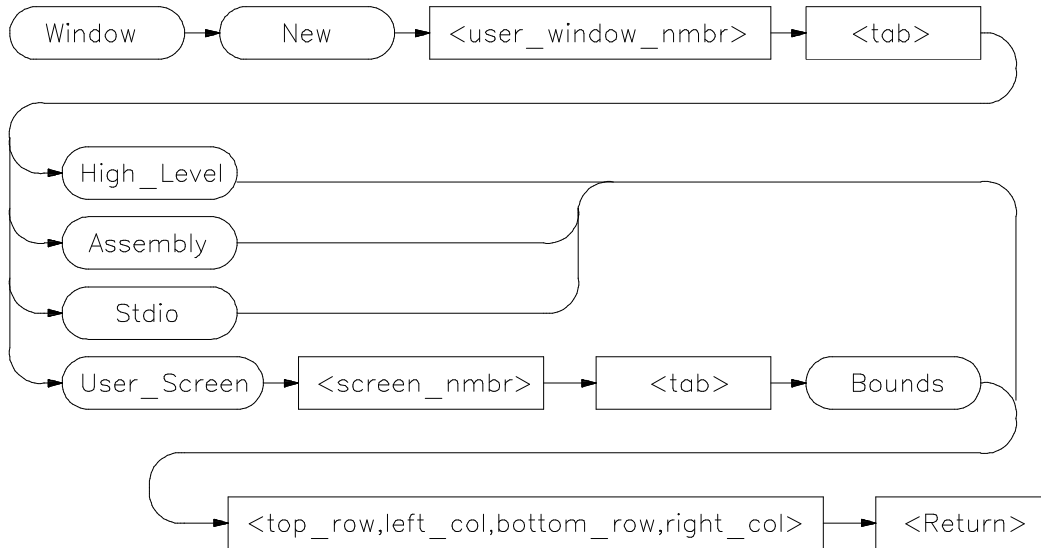

The Window New command makes (creates) new windows and screens. It may also be used to move existing windows to a new location within a screen. Windows must be assigned a number between 50 and 256 inclusive. Numbers 1 through 49 are reserved for predefined debugger windows. The bounds parameter specifies both the window size and location on the screen.

Window coordinates 0,0 correspond with the upper-left corner of the screen.

Note

When making new window, be careful not to enter coordinates that will result in a window that will cover the status line and command line.

On a standard 80-column by 24-row terminal display, a row coordinate may be between 0 and 23. However, creating a window whose bottom row coordinate is greater than 18 will cause part or all of the status line to be covered.

Command Parameters

Definition of the Window New command parameters are as follows:

Parameter	Definition	Range
< user_window_nmbr>	Window number	50 to 256 inclusive
< user_screen_nmbr>	User_Screen	4 to 256 inclusive
< top row>	Upper row coordinate	0 to N-1 inclusive
< left col>	Left column coordinate	0 to N-1 inclusive
< bottom row>	Lower row coordinate	0 to N-1 inclusive
< right col>	Right column coordinate	0 to N-1 inclusive

N is the number of rows or columns on your display. The value of N is dependent on display type.

Note

The Window New command will fail if row or column coordinates are greater than the screen boundary. For example, the command *Window New 15 Assembly 36,1,39,80* will fail if you have an 80 column by 40 row screen. The command *Window New 15 Assembly 36,0,39,79* will work.

Alternate Window Views

To create alternate views of a user-defined window, follow the procedure outlined below.

- 1 Execute the **Window New** command to define a window with specific size parameters.
- 2 Execute the **Window Toggle_View** command, or press function key **F4**.
- 3 Execute the **Window Resize** command to redefine the previously defined window with new size parameters. The new size parameters must be smaller than the previously assigned parameters.

See Also

Expression Fprintf
 File User_Fopen
 Window Active
 Window Cursor
 Window Delete
 Window Erase
 Window Resize

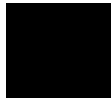

Chapter 12: Debugger Coommands
Window New

Window Screen_On
Window Toggle_View

Examples

To make a new user window, number it 57, and display it in user screen 4 with upper-left corner at coordinates 5,5 and the lower right corner at coordinates 18,78:

```
Window New 57 User_Screen 4 Bounds 5,5,18,78
```

To make a new user window, number it 55, and display it in the high-level screen with upper-left corner at coordinates 5,5 and the lower right corner at coordinates 10,20:

```
Window New 55 High_Level 5,5,10,20
```

To move the high level status line window to the top of the display in the standard interface:

```
Window New 5 High_Level 0,0,3,78
```

For this command to execute, the high-level window must be displayed and the difference between the bottom row coordinate and top row coordinate (3 – 0) must equal three (3). You cannot move the status line if you are using the graphical interface.

Window Resize



The Window Resize command lets you change the size and position of the active window interactively. The cursor keys (left, right, up, and down arrows) move either the top left corner, or the bottom right corner of the window.

To reposition the top left corner, press **T** and position the top left corner of the window using the cursor control keys.

To reposition the lower right corner of the window, press **B** and use the cursor control keys to position the lower right corner.

To move the window without resizing it press **M** and use the cursor control keys to move the window on the screen.

Press the **Return** key to save the new coordinates.

Press **CTRL C** or **Esc Esc** to restore the previous coordinates.

If an alternate window view is selected, the size alterations are made to the alternate view.

Note

The Window Resize command can be used to alter the size of any existing window, including the predefined debugger windows, with the exception of the Status Line or View window. In the standard interface (but not in the graphical interface), the Status Line window can be moved or resized using the Window New command.

See Also

Expression Fprintf
File User_Fopen
other Window commands

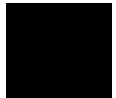

Window Screen_On

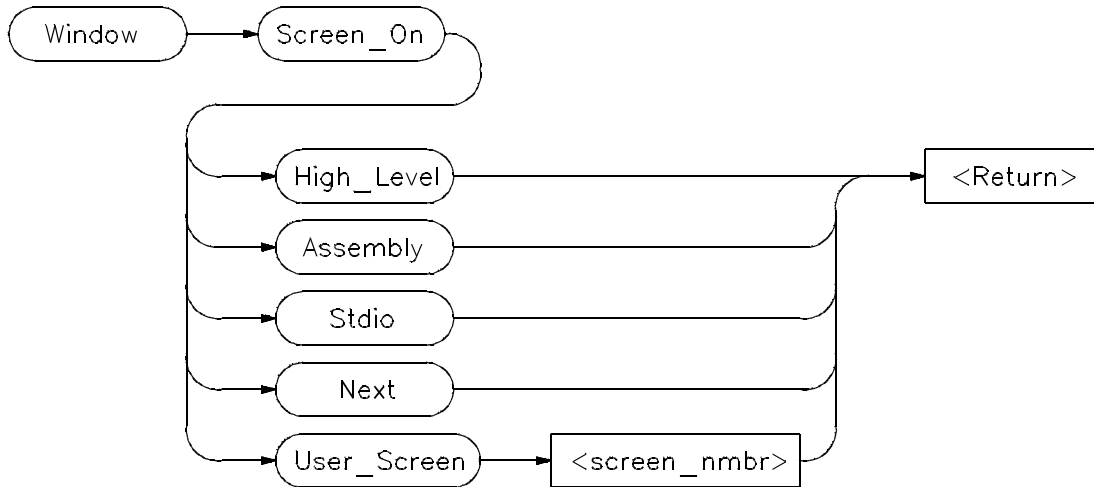

The `Window Screen_On` command displays the selected screen. You can also use function key `F6` to display a screen.

If the high level screen is displayed, the debugger is placed in the high level mode. Likewise, when you display the assembly level screen, the debugger is placed in the low level mode.

See Also

Window Active	Window New
Window Cursor	Window Resize
Window Delete	Window Toggle_View
Window Erase	

Example

To activate the Assembly-level screen and place the debugger in low level mode:

```
Window Screen_On Assembly
```

Window Toggle_View

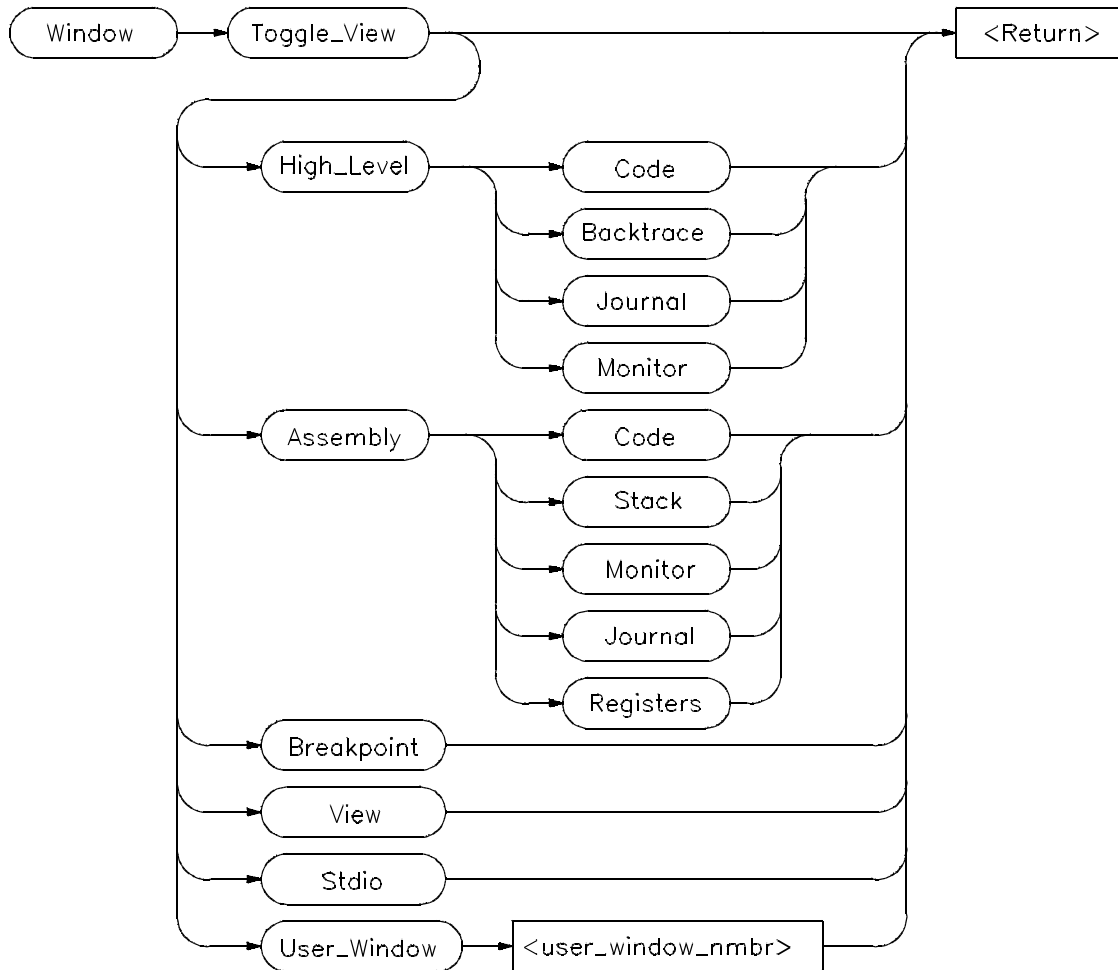

The Window Toggle_View command selects the alternate view of a window. Typically, this is an enlarged view of the window. If you do not specify a window number or if you specify 0, the active window is the default.

When you execute the Window Toggle_View command, the display alternates between the two views of the window.

Chapter 12: Debugger Coommands

Window Toggle_View

You can also use the *F4* function key to alternate views of the active window.

To create alternate views of a user-defined window, follow the procedure outlined in the Window New command description.

See Also

Window Active
Window Cursor
Window Delete
Window Erase
Window New
Window Resize
Window Screen_On

Examples

To display the alternate view of the active window:

```
Window Toggle_View
```

To display the alternate view of the high-level Code window:

```
Window Toggle_View High_Level Code
```

To display the alternate view of user window 57:

```
Window Toggle_View User_Window 57
```

13

Expressions and Symbols in Debugger Commands

A description of the expressions and symbols you can use in debugger commands.

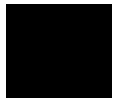

Expressions and Symbols in Debugger Commands

This chapter discusses the following language elements used in debugger commands:

- Expression elements.
- Formatting expressions.
- Symbolic referencing.

Debugger commands use standard C operators and syntax. This chapter describes the elements of C expressions and how expressions are structured. It also discusses memory and variable referencing.

Expression Elements

Most debugger commands require simple C expressions that evaluate to a scalar value. Simple C expressions are the same as standard algebraic expressions. These expressions evaluate to a single scalar value. Expressions consist of the following elements:

- operators
- constants
- program symbols
- debugger symbols
- built-in symbols
- macros
- keywords
- registers
- addresses
- address ranges
- line numbers

Debugger commands allow any legal C expression. The following paragraphs describe elements of C expressions used in debugger commands.

Operators

The debugger supports most standard C language operators and special debugger operators.

C Operators

C operators include arithmetic operators, relational operators, assignment operators, and structure, union, and array operators. The following table lists these operators in order of precedence (first line of the table is the highest precedence).

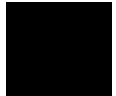

Supported C Operators

Operators	Order of Association
() [] -> .	Left to right
~ ! ++ -- sizeof (type) - * &	Right to left
* / %	Left to right
+ -	Left to right
<< >>	Left to right
< <= > >=	Left to right
== !=	Left to right
&	Left to right
^	Left to right
	Left to right
&&	Left to right
	Left to right
= += -= *= /= %= &= ^= = <<= >>=	Right to left
''	Left to right

C++ Operators

The debugger also supports C++ operators: ::, ., ->, and &.

Debugger Operators

The debugger uses some characters as special debugger operators. These debugger operators and their descriptions are listed in the following table:

Debugger Operators

Operator	Description
[]	References the contents of a memory location. For example: <code>Expression Display_Value [0x20b0]</code>
#	Identifies a line number. For example: <code>Program Run Until #82</code>
@	Identifies a stack level, reserved symbols, or symbol tree root. For example: <code>Program Display_Source @2</code> <i>(stack level)</i> <code>Expression Display_Value @module</code> <i>(reserved symbol)</i> <code>Symbol Display Default @ecs\\</code> <i>(symbol tree root)</i>
' '	Identifies a character constant.
" "	Identifies a character string constant.
\	Qualifies a symbol reference. For example: <code>Program Run Until updateSys\#20</code>
\\	Specifies an executable file as the root of a symbol tree. The specified file must be loaded into the debugger. For example: <code>Program Context Set @ecs\\main</code>

Constants

A constant is a fixed quantity. Constants may be integers, floating point values, or character string constants.

Integer Constants.

An integer constant may be defined as a sequence of numeric characters optionally preceded by a plus or minus sign. If unsigned, the debugger assumes the value is positive.

Positive integer constants may range between 0 and $2^{31}-1$. When a constant is negative, its two's complement representation is generated. Negative integer constants may range to -2^{31} .

Constants can be specified as binary, decimal, or hexadecimal values. This is done by placing a prefix or suffix descriptor before or after the constant. The following table lists the legal prefixes or suffixes that may be specified with integer constants to denote a specific base.

Integer Constant Prefixes and Suffixes				
Constant Type	Prefix Descriptor	Suffix Descriptor	Base	Digit
Binary		b, B	2	0-1
Decimal		t, T	10	0-9
Hexadecimal	0x,0X	h, H	16	0-9, A-F, a-f

Hexadecimal constants starting with the letters A through F (or a through f) must be prefixed with a zero. Otherwise, the debugger attempts to interpret the value as a symbol name.

By default, the debugger interprets integer constants as decimal values. The "Configuring the Debugger" chapter describes how to change the default radix for assembly-level values.

Note

You cannot use binary numbers when the radix is hexadecimal.

The debugger truncates values larger than that which can be contained in an element of an expression or command. The debugger extends values less than that allowed in the element. The truncation and extension are both implemented according to the rules of C.

The examples given in the following table show the use of prefix and suffix descriptors.

Prefix and Suffix Descriptor Examples

Constant	Decimal Mode	Hexadecimal Mode
73T	Decimal	Decimal
0EFF1h	Hexadecimal	Hexadecimal
10b	Binary	Hexadecimal
0x2214	Hexadecimal	Hexadecimal
23C3	Illegal	Hexadecimal
123	Decimal	Hexadecimal

Floating Point Constants

The debugger represents floating point constants internally in standard IEEE binary format. All floating point calculations follow the rules of C. The debugger treats all floating point constants as double precision values internally.

Floating point constants specified on the debugger command line must have the following syntax:

[sign] integer_part.[fractional_part] [exponent]

where *sign* is an optional plus (+) or minus (-) sign.

integer_part consists of one or more decimal digits.

. is a decimal point.

fractional_part may be zero or more decimal digits.

exponent is an optional exponent, which is letter E (or e) followed by an integer part.

When specifying a floating point constant, the debugger uses a more restrictive syntax than the C language. The debugger always requires an integer part and a decimal point.

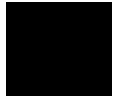

Examples:	76.3e-1	76.3	-0.3e1
	76.3E+0	76.e5	0.3
	76.3E2	76.	0.

Character Strings and Character Constants

Character Strings. A character string is a sequence of one or more ASCII characters enclosed in double quotation marks or two or more characters enclosed in single quotes. If the string has more than one character, subsequent ASCII characters are stored in consecutive bytes.

When a character string is referenced in a C expression, the debugger substitutes an address pointer to the string in the expression.

Character Constants. A character constant is a single character enclosed in single quotation marks.

When a character constant is referenced in a C expression, the debugger substitutes the actual ASCII character value in the expression, not the address of the character.

Non-printable characters. Some non-printable characters may be embedded in both character strings and character constants enclosed in double quotation marks (") by using the escape sequences listed in the table which follows. Escape sequences are indicated by a backslash (\).

The backslash is interpreted as a character in character strings enclosed in single quotation marks (').

Any characters other than those listed in the following table are interpreted literally if preceded by a backslash. For example, to have literal double quotation marks in a string, enclose the string in double quotation marks and use the escape sequence for double quotes shown above. For example:

```
"This is a \"string\" using embedded double quotation marks"
```

To have literal single quotation marks in a character string, enclose the string in double quotation marks. For example:

```
"This is a string that's using a single embedded quotation mark"
```

Non-Printable Character Escape Sequences

Sequence	ASCII Name	Hex Value	Description
<code>\b</code>	BS	08	Back Space
<code>\f</code>	FF	0C	Form Feed
<code>\n</code>	NL	0A	New Line
<code>\r</code>	CR	0D	Carriage Return
<code>\t</code>	HT	09	Horizontal Tab
<code>\"</code>	"	22	Double Quote
<code>\\</code>	\	5C	Backslash
<code>\xnumber</code> *	—	xnumber	Hex Character Value

* `\xnumber` must be entered in the format `\xnn` where `nn` is a two digit hexadecimal value. For example: `\x0f`, not `\xf`

Note

The debugger automatically terminates character strings enclosed in quotation marks with a null character. However, when you use a character string with a Memory Assign or Memory Block_Operation (Fill, Search, or Test) command, the debugger uses only the characters within the quotation marks (null characters are not added).

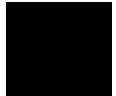

Symbols

A symbol (also called an identifier) is a name that identifies a location in memory. It consists of a sequence of characters that identify program and debugger variables, macros, keywords, registers, memory addresses, and line numbers.

Symbols may be up to 40 characters in length. The first character in a symbol must be alphabetic, an underscore (`_`), or an at sign (`@`). The characters allowed in a symbol include upper and lower case alphabetic characters, numeric characters, dollar signs (`$`), at signs (`@`), or underscores (`_`). No other characters may be used in symbols. The debugger differentiates between upper case and lower case characters in a symbol.

The following sections describe the different categories of symbols used by the debugger.

Program Symbols

Program symbols are identifiers associated with a source program. They consist of symbolic variable data names and function names that the programmer defined when writing the source program. All symbols that were defined in the source program can be passed to the debugger and referenced during a debugging session. Note that preprocessor names are not symbols.

The compiler includes all program symbol information in the resulting output object module file by default. When you load an executable file for debugging, the debugger places all program symbols into the debugger symbol table by default. The debugger preserves symbol types and treats the symbols according to their type.

The debugger may be instructed to load only global symbols at load time, loading local symbols as they are referenced. This behavior is known as *symbols on demand*. Refer to the description of the Debugger Option General Demand_Load command in the “Debugger Commands” chapter for more information on *symbols on demand*.

Normally, the compiler prefixes a leading underscore to all global program symbols. This is done to distinguish program symbols from reserved assembler names. If the debugger has loaded all symbols, two symbols will be available; the high-level symbol (for example, *main*), and its low-level

counterpart(*_main*). However, with symbols on demand, only the high-level symbol is available (*main*).

Debugger Symbols

Debugger symbols can be added during a debugging session using the Symbol Add command. The debugger treats debugger symbols as global symbols. When you create a debugger symbol, you must assign it a name. You may optionally assign it a type. An initial value may also be given to a debugger symbol. If you do not specify an initial value, the initial value defaults to zero.

Debugger symbols are stored in the debugger's memory and are not associated with the processor target memory.

Macro Symbols

You can use macros to:

- Create complex user commands.
- Patch your source code temporarily.
- Display information in user-defined windows.

A macro is similar to a C function. It has a name, return type, optional arguments, optional macro local symbols, and a sequence of statements.

There are two types of macro symbols:

- Macro names.
- Macro local symbols.

Macro Names

Macro names identify a macro. You assign macro names with the Debugger Macro Add command.

Macro Local Symbols

Macro local symbols are local variables and parameters defined within macros. They are declared when you create a debugger macro with the Debugger Macro Add command. A macro local symbol can be accessed only by the macro in which it is defined. It is created when the macro is executed. The macro local symbol has an undefined initial value.

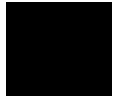

Reserved Symbols

Reserved symbols are reserved words that represent processor registers, status bits, and debugger control variables. These symbols are always recognized by the debugger. You can use reserved symbols any time during a debugging session. Reserved symbols have special meanings within the debugger command language. They cannot be defined and used for other purposes. To avoid conflict with other symbols, the names of all reserved symbols begin with the "@" character.

The debugger can generate a list of all reserved symbols (see page 148). In addition, many of the reserved symbols are listed in the "Registers" chapter.

Line Numbers

Line numbers can be used to refer to lines of code in your original source program. The compiler generates line numbers by default.

Line number references must be preceded by a pound sign (#). For example:

```
Program Run Until #82
```

When you refer to a source line number, the debugger translates it to the address of the first instruction generated by the compiler for that C statement. If a C source line did not generate executable code, a reference to that line number actually refers to the next line that did generate executable code.

To reference a line number that is in a module other than the current one, precede the line number with a module name. For example:

```
Breakpt Instr updateSys\#332
```

If supported by your compiler, you can debug multiple statements on one line. A dot qualifier (.) identifies the sequence of a statement on the source line. A colon qualifier (:) identifies a column number within the source line. Hewlett-Packard cross assemblers do not support multi-statement debugging.

Addresses

An address may be represented by any C expression that evaluates to a single value. The C expression can contain symbols, constants, line numbers, and operators.

Code Addresses

Code addresses refer to the executable portion of a program. In high level mode, expressions that evaluate to a code address cannot contain numeric constants or operators.

Data and Assembly Level Code Addresses

Data addresses refer to the data portion of a program. Data address and assembly level code address expressions may be represented by most legal C expressions. There are no restrictions on constants or operators.

Address Ranges

An address range is a range of memory bounded by two addresses. You specify an address range with a starting address, two periods (..), and an ending address. These addresses can be actual memory locations, line numbers, symbols, or expressions that evaluate to addresses in memory.

You can also specify a byte offset as the ending address parameter. If you specify a byte offset, the debugger adds the specified number of bytes to the starting address and uses the resulting address as the ending address. You must precede a byte offset with a plus sign (+).

You may specify module names before symbols and line numbers to override the default module.

The following examples show how to specify address ranges.

To set instruction breakpoints starting at line number 80 and ending at line number 90:

```
Breakpt Instr #80..#90
```

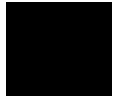

Chapter 13: Expressions and Symbols in Debugger Commands Addresses

To display code as bytes starting at line number 82 and ending at address 10d0 (hex):

```
Memory Display Byte #82..0x10d0
```

To display code as bytes, starting at memory location *tick_clock* and ending at 20 bytes past *tick_clock*:

```
Memory Display Byte tick_clock..+20
```

Keywords

Keywords are macro conditional statements that can be used in a macro definition. These keywords are very similar to the C language conditional statements. You cannot redefine keywords or use them in any other context. The debugger keywords are listed below.

IF
ELSE
FOR
WHILE
DO
BREAK
CONTINUE
RETURN

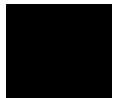

Forming Expressions

The debugger groups expressions into two classes:

- Assembly language expressions used in assembly level mode.
- Source language expressions used in either assembly level mode or high level mode.

When you use a source language expression to express a code address in high level mode, it can consist only of a single symbol or a single line number. Source language expressions cannot contain numeric constants or operators. This restriction reduces confusion when entering high level expressions. There are no restrictions on source language expressions that evaluate to data addresses or on assembly language expressions.

Examples of legal and illegal source language code expressions in high level mode are shown below.

Legal # 80
 main

Illegal # 80+ 3
 main+ 10

With several commands, the size of an expression can be specified by size qualifiers. The size qualifiers are explained in the “Debugger Commands” chapter.

You may use C++ classes in expressions.

Floating point calculations follow the rules of C. Single precision numbers are converted to double precision, the specified operation is done, and the result is translated back to single precision.

Note

Any value can be treated as an address. For example, a character value (byte) can be treated as an address. You should be careful when using values as addresses.

Examples of valid expressions are shown in the following table.

Valid Expressions

Expression	Meaning
# 7	Line number reference (code address)
i	Symbol reference (value or address)
x+ (y*5)	Arithmetic operation (value or address)
default_targets[2]	Array reference (value or address)
assign_vectors	Function name reference (code address)

Expression Strings

An expression string is a list of values separated by commas. The expression string can contain expressions and ASCII character strings enclosed in quotation marks. For several commands, each value in an expression string can be changed to the size specified by the size qualifiers. If you change the size, the debugger pads elements that do not fit evenly. Examples of expression strings are shown in the following table.

Expression String Examples

String	Results
1,2,"abc"	Values 1 and 2, and ASCII values of abc.
3+ 4, time, mac1()	Value 7, value of time, results of calling the macro 'mac1'.
'1xyz123'	ASCII values.

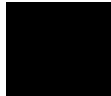

Symbolic Referencing

The debugger references symbols in a different manner than the standard C language definition. Therefore, understanding how variables are allocated and stored in memory is important. The following sections describe symbol storage classes and data types. These sections are followed by a discussion on:

- Referencing symbols with root, module, and function names.
- Making stack references.

In the following paragraphs, the notion of a 'module' is synonymous with a file in C. In fact, the module name is simply the basename of the source file with no suffix.

Storage Classes

All variables and functions in a C source program have a storage class that defines how the variable or function is created and accessed. The storage classes are:

- extern (global)
- static
- automatic
- register

C preprocessor symbols are not available to the debugger. The following paragraphs describe each storage class used in a C source program.

Extern (global)

Global variables in a C program are declared outside of a function and are accessible to all functions. Storage for these variables is allocated only once. Thereafter, references are made to the previously allocated space.

Global functions can be called from any other function.

Static

Static variables in a C program are allocated permanent storage and can be local to a module or local to a function.

In C, static variables local to a module can only be accessed by functions in that module. In the debugger, static variables local to a module can be accessed either when a function is active in that module or when the variable is qualified by the module name in which it is defined. A static variable that is local to a function can only be accessed by the function in which it was declared, unless it is qualified by the module and function in which it is defined.

Static functions can only be accessed when the function is in the current module, unless the function is qualified by the module in which it is defined.

Automatic

Automatic variables are declared inside a function and are accessible only to that function. Storage for these variables is allocated on the stack when the function is called and released when the function returns. Automatic variables do not have an initial value (their values are not retained between function calls).

You can access an automatic (local) variable when it is local to the current function, or when its function is on the stack. Use the stack-level prefix `@ <stack_level>` to access an automatic variable in a function on the stack.

Register

Register variables are also declared inside a function and are accessible only to that function. Storage for these variables is allocated in a specific hardware register when the function is called and released when the function returns. Register variables do not have an initial value (their values are not retained between function calls).

A register variable is accessible when it is local to the current function, or when its function is on the stack.

Note

Breakpoints cannot be set on accesses to register variables. If you need to set breakpoints on a variable, make sure that it is allocated on the stack by declaring its type as automatic.

Data Types

All symbols and expressions have an associated data type. Assembly language modules may contain variables with the types BYTE, WORD, or LONG. The

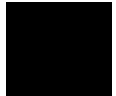

Chapter 13: Expressions and Symbols in Debugger Commands

Symbolic Referencing

debugger treats these types as unsigned char, unsigned short int, and unsigned long, respectively. A segment attribute indicates whether a variable was defined in a code segment or a data segment.

Source language modules may contain any valid C language data type. The data types for each type of module are listed in the following tables. The ranges of values are decimal representations.

Assembly Level Data Types

Type	Size	Range
BYTE (unsigned char)	8 bits, unsigned	0 to 255
WORD (unsigned short int)	16 bits, unsigned	0 to 65535
LONG (unsigned long)	32 bits, unsigned	0 to 4294967295

High Level Scalar Data Types

Type	Size	Range
char	8 bits, signed	-128 to 127
unsigned char	8 bits, unsigned	0 to 255
short int	16 bits, signed	-32768 to 32767
unsigned short int	16 bits, unsigned	0 to 65535
int	32 bits, signed	-2147483648 to 2147483647
unsigned int	32 bits, unsigned	0 to 4294967295
long	32 bits, signed	-2147483648 to 2147483647
unsigned long	32 bits, unsigned	0 to 4294967295
enum	8-32 bits, unsigned	0 to 4294967295
pointer	32 bits, unsigned	0 to 4294967295
float	32 bits	1.18×10^{-38} to $3.4 \times 10^{+38}$
double	64 bits	9.46×10^{-308} to $1.79 \times 10^{+308}$

High Level Complex Data Types

Type	Size
struct	Combined size of members (plus possible padding)
union	Size of largest member
array	Combined size of elements

Type Conversion

The debugger does data type conversions under the following conditions:

- When two or more operands of different types appear in an expression, the debugger does data type conversion according to the rules of C.
- When arguments are passed to a macro function, the debugger converts the types of the macro's arguments to the types defined in the macro.
- When the data type of an operand is forced by type casting, the debugger converts the data type.
- When a specific type is required by a command, the value is converted by the debugger according to the rules of C.

Type Casting

Type casting forces the conversion of a debugger symbol or expression to a specified data type. The debugger converts the resulting value of the expression to the specified data type, as if the expression was assigned to a variable of that type. The debugger does not alter the contents of the variable.

You can cast debugger symbols and expressions into different types using the following syntax:

(typename) expression

For example, the following symbol is cast to type char:

(char) prime

The following example casts the variable expression ptr__char to type int:

(int) ptr__char

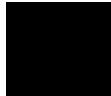

Chapter 13: Expressions and Symbols in Debugger Commands

Symbolic Referencing

Unlike C, the debugger allows casting to an array. The following example casts the address of the symbol `int_value` to an array of four chars:

```
(char[4]) &int_value
```

This type of casting to an array can be used with both the `Expression Display_Value` and `Expression Monitor_Value` commands.

Special Casting

In addition to the standard C type casts, the following assembly level casts are also recognized by the debugger's expression handler.

(Q S)

This type cast coerces an expression into a quoted string. For example, assuming the symbol `int_val` has a value of `0x61626364`,

```
Expression Display_Value (Q S) &int_val
```

causes `int_val` to be displayed as "abcd". Note that the expression evaluates to an address because the (Q S) type cast is semantically synonymous with the C type cast (`char *`).

(I A)

This type cast coerces an expression into an instruction address. For example, assuming the symbol `int_val` has a value of `0x400`,

```
Breakpt Instr (I A) int_val
```

sets an instruction breakpoint at address `0x400`.

(H D)

This type cast coerces an expression into a long word (4 bytes) and displays the value in hexadecimal format. For example, assuming the symbol `char_val` has a value of `0x3F`,

```
Expression Display_Value (H D) char_val
```

will cause `char_val` to be displayed as `0x0000003F`.

(H W)

This type cast coerces an expression into a word (2 bytes). For example, assuming the symbol `int_val` has the value `0x12345678`,

```
Expression Display_Value (H W) int_val
```

will cause `int_val` to be displayed as `0x5678`.

(H B)

This type cast coerces an expression into a byte. For example, assuming the symbol `int_val` has a value of `0x12345678`,

```
Expression Display_Value (H B) int_val
```

will cause `int_val` to be displayed as `0x78`.

Scoping Rules

References to symbols follow the standard scoping rules of C. For example, if the symbol `'x'` is referenced, the debugger searches its symbol table for `'x'` using the following priority:

- A variable local to the current macro (if any).
- A variable local to the current function (if any).
- A variable static to the current module (if any).
- A global variable or debugger symbol.

Referencing Symbols

Symbols are qualified (and therefore referenced) according to their context. Context in the debugger is defined by a symbol tree and, if applicable, by a module and function name.

Root Names

Within the debugger, the symbol table is represented as a hierarchical tree, with each level representing a scoping level. There are two types of symbol trees which exist within the debugger:

- non-program symbol tree
- program symbol tree

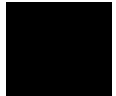

Chapter 13: Expressions and Symbols in Debugger Commands

Symbolic Referencing

Non-program symbol tree. This tree is composed of non-program symbols.

Only one non-program symbol tree exists. This tree is made up of:

- debugger symbols (@pc, @sp, etc.)
- macros
- user-defined debugger symbols

The root name of this tree is \.

Program symbol tree. The second type of symbol tree is the program symbol tree. The debugger allows up to 30 program trees. This tree is made up of symbols which exist in the target program. Since there may be multiple program trees within the debugger, the root of a program tree is specified as @*absfile*\, where *absfile* is the name of the executable file with its suffix stripped. For example, the root name of the program tree associated with the executable file a.out.x would be @a_out\.

Note

Any embedded '.' characters in a file name are converted to underscores. This prevents conflicts with the '.' structure operator. For example, the module name of source file myfile.bar.c would be myfile_bar.

There is no method for generating a list of multiple program trees.

If two or more executable files with the same name are loaded, the debugger appends an underscore and number to one of the files to make the root names unambiguous. For example, loading two a.out.x files would result in the creation of two program trees, with root names a_out and a_out_1.

Whenever the PC is pointing to the code space of a program, the root name of the program's symbol tree is the *current* root. A shorthand notation for specifying the current root is the symbol \. For example, if the debugger is invoked without loading an executable file, the current root would be \, which would be synonymous with \. However, once an executable file (a.out.x) is loaded with the PC set to an address within the executable's code space, the current root becomes @a_out\, which would be synonymous with \.

The reserved symbol "@root" points to a character string representing the name of the current root, and the symbol "@file" points to the name of the file containing the current PC. These may be empty strings ("") if the PC is outside of any defined symbol database.

Module Names

The C language does not contain the concept of a module. Within the context of the debugger, a module is a scoping level which is identical to the scoping level of a file in C. Module names (which are generated by the compiler), are derived from source file names by removing the suffix of the source file. For example, the module name associated with the source file `myfile.c` would be `myfile`. Module names are used to qualify symbol references within the program symbol tree. When used as such, they are separated from any following function name by a `\`.

Note

If files in two directories have the same name, they will have identical module names. Since the debugger cannot distinguish between the two modules, all references will resolve to the last loaded module.

Assembly level modules with multiple code sections. If assembly language modules have more than one code section, the debugger breaks the module down into sub-modules. For example, if the source file `myfile.s` had three code sections, the modules `myfile`, `myfile_2`, and `myfile_3` would appear in the program's symbol tree. This module separation only affects the address ranges of the module, not the scoping, i.e. all symbols scoped under the file `myfile.s` would be scoped under module `myfile`.

Context. Some symbol references are dependent on the current context. See the examples in the following tables. The current context is based on the PC and consists of the current root, current module, and current function. To display the current context, execute the command:

```
Program Context Display Return
```

Symbolic Referencing With Explicit Roots

Example**Comment**

```
Symbol Display Default \\
```

Display symbols scoped under the non-program root.

Symbolic Referencing With Explicit Roots

Example	Comment
Symbol Display Default @a_out\\	Display symbols scoped under the program root <i>a_out</i> .
Symbol Display Default \	Display symbols scoped under the current root.
Symbol Display Default @a_out\\mod1	Display symbol information for module <i>mod1</i> scoped under program root <i>a_out</i> .
Symbol Display Default \mod1	Display symbol information for module <i>mod1</i> scoped under the current root.
Symbol Display Default @a_out\\mod1\	Display symbols scoped under module <i>mod1</i> in program root <i>a_out</i> .
Symbol Display Default \mod1\ Breakpt Instr @a_out\\mod1\func1	Display symbols scoped under module <i>mod1</i> in the current root. Set a breakpoint at the entry point to function <i>func1</i> in module <i>mod1</i> in program root <i>a_out</i> .
Breakpt Instr \mod1\func1	Set a breakpoint at the entry point to function <i>func1</i> in module <i>mod1</i> in the current root.
Symbol Display Default @a_out\\mod1\func1\ Symbol Display Default \mod1\func1\ Breakpt Access @a_out\\mod1\func1\j	Display symbols scoped under function <i>func1</i> in module <i>mod1</i> in program root <i>a_out</i> . Display symbols scoped under function <i>func1</i> in module <i>mod1</i> in the current root. Set a breakpoint on accesses of variable <i>j</i> scoped under function <i>func1</i> in module <i>mod1</i> in program root <i>a_out</i> .
Breakpt Access \mod1\func1\j	Set a breakpoint on accesses of variable <i>j</i> scoped under function <i>func1</i> in module <i>mod1</i> in the current root.

Symbolic Referencing With Explicit Roots

Example	Comment
Notes:	
The variable <i>mod1</i> must be a module name.	
The variable <i>func1</i> must be a function name.	
The example pairs are equivalent if the current root is <i>a_out</i> .	

Symbolic Referencing Without Explicit Roots

Example	Comment
<code>Symbol Display Default x</code>	Display symbol information for all symbols named <i>x</i> at any scoping level in any root.
<code>Breakpt Access x</code>	Set a breakpoint at the <i>x</i> found using the scoping rules described in this chapter.
<code>Symbol Display Default x\</code>	Display symbol information for global symbol <i>x</i> in the current root and all symbols scoped under <i>x</i> . <i>x</i> may be a variable, function, or module name.
<code>Breakpt Instr x\#18</code>	Set a breakpoint at line 18 of module <i>x</i> .
<code>Symbol Display Default x\y</code>	Display symbol information for local variable <i>y</i> in function <i>x</i> (or function <i>y</i> in module <i>x</i>) in the current context.
<code>Symbol Display Default x\y\</code>	Display symbol information for local variable <i>y</i> in function <i>x</i> (or function <i>y</i> in module <i>x</i>) in the current context and for all symbols scoped under <i>x\y</i> .
<code>Breakpt Access x\y\j</code>	Set a breakpoint at local variable <i>j</i> in function <i>y</i> in module <i>x</i> in the current root.

Evaluating Symbols

The debugger evaluates symbols in expressions using the rules of the C language as follows:

Chapter 13: Expressions and Symbols in Debugger Commands

Symbolic Referencing

- Function names and labels evaluate to addresses.
- Variables generally evaluate to the contents of the memory location at the address of the variable (the exception is unsubscripted array names which evaluate to addresses.)

The examples in the following table show the differences in evaluation of these symbol types.

Symbol Evaluation Examples	
Example	Comment
Breakpt Instr foo	The symbol <i>foo</i> is a function name. The breakpoint is set at the address of <i>foo</i> .
Breakpt Access &i	<i>i</i> is a variable. Therefore, the debugger evaluates the symbol as the value of <i>i</i> rather than the address of <i>i</i> . The & operator causes the breakpoint to be set on the address of <i>i</i> .
Breakpt Access a	<i>a</i> is an array. The breakpoint is set at the address of the first element of the array.
Breakpt Access a[3]	A breakpoint is set at the address specified in <i>a[3]</i> , not the address of <i>a[3]</i> .
Breakpt Access &a[3]	A breakpoint is set at the address of <i>a[3]</i> .

Stack References

When a function is invoked in C, space is allocated on the stack for local variables. If one function calls another function, all information is saved on the stack to continue execution when the called function returns. The caller function is now nested.

You can reference variables and functions on the stack implicitly or explicitly.

Implicit Stack References

The default compiler setting allocates storage for all local variables in a C program in registers, if possible. Variables that cannot be stored in registers are allocated storage on the stack. With the debugger, you can implicitly reference variables on the stack as follows:

- To refer to variables on the stack in the current function, specify the name of the variable. For example: *x*.
- To refer to a local variable in a nested function, specify the function name followed by a backslash and then the name of the local variable, for example, *main\i*.

Explicit Stack References

A function is allocated storage on the stack when it is executing, or when it has called another function. To refer to functions and variables on the stack explicitly, you must specify the function's nesting level preceded by a commercial at sign (@). The backtrace window in high-level mode displays nesting level information (for example, if the current function is @0, its calling function is @1, etc.). You may reference functions on the stack as follows:

- To refer to the address that the function will continue to execute from, specify the function nesting level preceded by an at sign (@). For example, the command *Program Run Until @1* executes the program until the current function returns to its caller.
- To refer explicitly to a local variable in a nested function, specify the function nesting level followed by a backslash and then the name of the variable. For example, the command *Expression Display_Value @3\str* references the local variable 'str' of the function at nesting level 3.
- To reference a function itself, enter the command *Program Context Expand* followed by a space and then the function nesting level. For example, the command *Program Context Expand @7* displays all information about the function at the specified level for that particular invocation. This information includes the name of the function, the current line number, and all local variables in the function and their values. See the *Program Context Expand* command syntax description in the "Debugger Commands" chapter for more information.

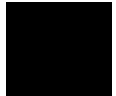

Chapter 13: Expressions and Symbols in Debugger Commands
Symbolic Referencing

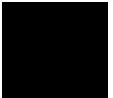

Registers

Detailed information about selected registers.

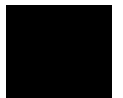

Chapter 14: Registers

The tables in this chapter give specific information about some of the registers supported by the debugger. This chapter does *not* list all of the registers or reserved symbols used by the debugger.

The symbols listed in this chapter are predefined, reserved symbols for the 68040 debugger/emulator. Reserved symbols cannot be deleted by the user.

Register names may be entered in either upper or lower case characters.

Reserved Symbols		
Symbol	Meaning	Maximum Value
@A0-A7	Address Registers	0xFFFFFFFF
@C	Carry Flag	1
@CACR	Cache Control Register	0xFFFFFFFF
@CCR	Condition Codes Register	0x1F
@CHIP	Processor Chip Id. Number	
@D0-D7	Data Registers	0xFFFFFFFF
@DFC	Destination Function Code	7
@DTT0	Data Transparent Translation Register 0	0xFFFFFFFF
@DTT1	Data Transparent Translation Register 0	0xFFFFFFFF
@ENTRY	Address of first executable statement in function	
@FILE	Name of file containing current PC,	
@FP	Frame Pointer (@A6)	0xFFFFFFFF
@FP0-FP7	Floating Point Registers	80 bits
@FPCR	Floating Point Control Register	0xFFFF
@FPIAR	Floating Point Instruction Address Register	0xFFFFFFFF
@FPSR	Floating Point Status Register	0xFFFFFFFF
@FUNCTION	Pointer to current function name	
@HLPC	High-Level Program Counter(line number)	32767
@I	Interrupt Mask	7
@ISP	Interrupt Stack Pointer	0xFFFFFFFF
@ITT0	Instruction Transparent Translation Register 0	0xFFFFFFFF
@ITT1	Instruction Transparent Translation Register 0	0xFFFFFFFF
@LINE_RANGE		
@M	Master/Interrupt Flag	1
@MMUSR	MMU Status Register	0xEE47
@MODULE	Pointer to current module name	
@MSP	Master Stack Pointer	0xFFFFFFFF
@N	Negative Flag	1
@PC	Program Counter	0xFFFFFFFF
@ROOT	Name of root of symbol tree represented by PC	
@S	Supervisor State Flag	1
@SFC	Source Function Code	0xFFFFFFFF
@SP	Stack Pointer	0xFFFFFFFF
@SR	Status Register	0xFFFF

Reserved Symbols		
Symbol	Meaning	Maximum Value
@SRP	Supervisor Root Pointer	0xFFFFFFFF
@SSP	Supervisor Stack Pointer	0xFFFFFFFF
@T0	Trace 0 Flag	1
@T1	Trace 1 Flag	1
@TC	Translation Control Register	
@URP	User Root Pointer	
@USP	User Stack Pointer	0xFFFFFFFF
@V	Overflow Flag	1
@VBR	Vector Base Address	0xFFFFFFFF
@X	Extend Flag	1
@Z	Zero Flag	1



Predefined Macros



Predefined Macros

Predefined macros are provided with the debugger. These predefined macros provide commonly used functions to help in debugging your program. The predefined macros available for your use are listed in the “Predefined Debugger Macros” table and are described on the following pages.

The following predefined debugger macros provide services to the SIMIO system and internal debugger functions. They are not designed for use by the debugger user. These names will be displayed if you check the debugger’s predefined macro list using the Symbol Display command:

- bbaunload
- emul_special
- hpsimio
- hp_redirect
- hpioctl
- hpeofkbd
- hpioreport
- load_config
- quit_debugger
- deMMUer
- MMUmapset
- MMUsegs

Predefined Debugger Macros	
Macro	Description
break_info	Display information about a breakpoint
byte	Return a byte value at the specified address
call	Call target function (not supported in this product)
close	Close a UNIX file
cmd_forward	Send a command to another attached emulator interface
dword	Return a long value at the specified address
error	Display error message
fgetc	Reads character from file
fopen	Open a file and associate it with a user window
key_get	Get (read) a key from the keyboard
key_stat	Check keyboard for availability of key
memchr	Search for character in memory
memset	Clear memory bytes
memcpy	Copy characters from memory
memset	Set the value of characters in memory
open	Open a UNIX file for reading and/or writing
pod_command	Pass a command to the emulator terminal interface
read	Read from a system file
readp	Read from an I/O port (not implemented in this product)
reg_str	Get the register value using the register name in the string
showversion	Show the software version number for the debugger product
strcat	Concatenate two strings
strchr	Locate first occurrence of a character in a string
strcmp	Compare two strings
strcpy	Copy a string
stricmp	Comparison of two strings without case distinction
strlen	String length
strncmp	Limited comparison of two strings
until	Run until expression is true
when	Break when expression is true
word	Return a word value at the specified address
write	Write to a system file
writep	Write to an I/O port (not implemented in this product)

break_info

Function

Return information about a breakpoint

Synopsis

```
int break_info (addr)
unsigned long *addr;
```

Description

The `break_info` macro returns the address and type of a breakpoint if it is called when a breakpoint is encountered. The macro returns the 32-bit representation of the breakpoint address used by the debugger and the following values for breakpoint type:

- | | |
|----|--|
| -1 | The cause of the breakpoint is unknown. |
| 0 | A breakpoint did not cause this macro call. |
| 1 | The breakpoint was caused by a read from the address. |
| 2 | The breakpoint was caused by a write to the address. |
| 3 | The breakpoint was caused by an access (read/write status unknown) of the address. |
| 4 | The breakpoint was caused by an instruction breakpoint. |

Diagnostics

None.

Example

If you have the following code segment:

```
main()
{
    auto i,j,k;
    i = 1;
    j = 3;
    k = i + j;
}
```

and you execute the following command file:

```
Debugger Macro Add int print_info()
{
    unsigned long address;
    int reason;

    reason = break_info(&address);
    $Expression Printf "Breakpoint at %8x. Reason: %d\n",
    address,reason$;
    return(1);
}
.

Program Run Until main
Program Step
Breakpt Read &i;print_info()
Breakpt Write &k;print_info()
Breakpt Access &j;print_info()
Program Run
```

the debugger will display the breakpoint address and type value in the journal window.





byte

Function

Return a byte value at the specified address

Synopsis

```
unsigned char byte (addr)  
void *addr;
```

Description

The `byte` macro returns a byte value of the memory contents at the specified address. The value of the expression `addr` is computed and used as the address.

Diagnostics

The byte value of the memory contents at the specified address is returned.

close

Function

Close a UNIX file

Synopsis

```
int close(fildes)
int    fildes;
```

Description

The close macro closes a UNIX file. This macro is an interface to the UNIX system call *close(2)*. Refer to the *HP-UX Reference Manual* for detailed information.

Diagnostics

If the system call to *close(2)* is successful, 0 is returned. Otherwise, *-1* is returned and a system generated error message is written to the journal window of the debugger.

Example

The following command file segment defines two global debugger symbols and includes the definition of a user-defined macro that uses *close()*.

```
Symbol Add int infile
Symbol Add int outfile

Debugger Macro Add int close_files(infile, outfile)
int    infile;    /* file descriptor to close */
int    outfile;   /* file descriptor to close */
{
    /* close input file */
    infile = close(infile);
    if (infile == -1)
        return 0;    /* close failed */

    /* close output file */
    outfile = close(outfile);
    if (outfile == -1)
        return 0;    /* close failed */

    return 1;    /* both files were closed successfully */
}
```

cmd_forward

Function

Send a comand to another attached emulator interface.

Synopsis

```
int cmd_forward (ui_id, command)
char *ui_id;
char *command;
```

Description

This macro sends the string *command* to the interface *ui_id*. Interface *ui_id* will then interpret *command* as input to its command line.

This macro provides a way for the target program to send commands to an emulator interface, as well as allowing control of all interfaces from a common point.

The interfaces that are currently supported are:

Emul	Emulator/analyzer interface. If several emulator interfaces are sharing the emulator, the command will be forwarded to the most recently started interface.
Perf	Software Performance Analyzer.
BMS	Broadcast Message Server (the Softbench Gateway).
Debug	Debugger. This sends a command back to the debugger you are using.

If an interface of the type specified is currently running, the command will be executed there and any errors will be displayed there.

Diagnostics

A zero is returned if *ui_id* is not attached to the emulator. A one is returned if *ui_id* is attached.

Examples

To start execution of an emulator interface command file at the beginning of sub-program *main5*, enter:

```
Breakpoint Instr main5; cmd_forward ("emul",  
"my_command_file")
```

To provide a target function to send a command to a user interface, compile the following function into your target program:

```
void send_command (ui, cmd)  
    char *ui, *cmd;  
{  
    return;  
}
```

Then set a breakpoint with a macro call:

```
Breakpoint Instr send_command\@ENTRY; cmd_forward  
(ui,cmd)
```

When execution reaches the first statement in *send_command()* the command *cmd* will be sent to user interface *ui*. Execution will halt if *ui* was not attached, and will continue otherwise.



dword

Function

Return a long value at the specified address

Synopsis

```
unsigned long dword (addr)  
void *addr;
```

Description

The `dword` macro returns a LONG (4-byte) value of the memory contents at the specified address. The value of the expression *addr* is computed and used as the address.

Diagnostics

The LONG value of the memory at that address is returned.

error

Function

Display error message

Synopsis

```
void error(level, text, parm)
int level;
char *text;
long parm;
```

Description

The `error()` macro is used to display error messages due to errors generated within macros. *level* must have a value of 1, 2, or 3. *text* is a string which can contain one `%d` format character, where *parm* is the associated integer value.

level can be used to indicate the severity of the error by its value. The following explains the values available for *level*, and the associated action taken by `error()`.

- 1** *text* is displayed in the journal window.
- 2** *text* is displayed in the journal window and the macro halts program execution.
- 3** An error box pops up, *text* is displayed within the box, and the macro halts program execution.



fgetc

Function

Reads character from file

Synopsis

```
int fgetc(vp_num)
int vp_num;
```

Description

The macro `fgetc()` returns the next character in the file associated with the window number `vp_num`. The window number must be a result of the `File User_Fopen` command. The value `-1` is returned on end of file.

fopen

Function

Open a file and associate it with a user window

Synopsis

```
int fopen(vp_num, filename, mode)
int  vp_num;
char *filename;
char *mode;
```

Description

The macro `fopen()` opens a file and associates it with a user-defined window. This macro is equivalent to the File User_Fopen debugger command. *filename* is the name of the file to be opened. *mode* is a string that specifies the mode in which the file is opened. Valid modes are:

"r"	Open file for reading only
"w"	Open file for reading and/or writing (existing file contents are erased)
"a"	Open file for appending

Diagnostics

If successful, a window number is returned. The error code `-27` indicates that the window is already open or that the window number is out of range. The error code `-101` is returned for other errors; for example, if the file to be read does not exist.



key_get

Function

Get a key from the keyboard

Synopsis

```
unsigned short key_get()
```

Description

The macro `key_get()` reads a key from the keyboard. It returns only after a key is available. The return value is the value of the key.

key_stat

Function

Check keyboard for availability of key

Synopsis

```
unsigned short key_stat()
```

Description

The `key_stat()` macro checks the keyboard to see if a key is available to read. It returns 0 if no key is available. The first pending key is returned if any keys are available.

Diagnostics

The value -1 is returned if the macro fails.

memchr

Function

Search for character in memory

Synopsis

```
char *memchr (str1, byte_value, count)
char   *str1;
char   byte_value;
unsigned count;
```

Description

The `memchr` macro locates the character *byte_value* in the first *count* bytes of memory area *str1*.

Diagnostics

The `memchr` macro returns a pointer to the first occurrence of character *byte_value* in the first *count* characters in memory area *str1*. If *byte_value* does not occur, `memchr` returns a NULL pointer. For debugger variables, -1 (0xFFFFFFFF) is returned if *byte_value* does not occur.

memclr

Function

Clear memory bytes

Synopsis

```
char *memclr (dest, count)
char  *dest;
unsigned count;
```

Description

The `memclr` macro sets the first *count* bytes in memory area *dest* to zero.

Diagnostics

The `memclr` macro returns *dest*.

memcpy

Function

Copy characters from memory

Synopsis

```
char *memcpy (dest, src, count)
char  *dest,
char  *src
unsigned count;
```

Description

The memcpy macro copies *count* characters from memory area *src* to *dest*.

Diagnostics

The memcpy macro returns *dest*.

memset

Function

Set the value of characters in memory

Synopsis

```
char *memset (dest, byte_value, count)
char  *dest;
char  byte_value;
unsigned count;
```

Description

The `memset` macro sets the first *count* characters in memory area *dest* to the value of character *byte_value*.

Diagnostics

The `memset` macro returns *dest*.

open

Function

Open a UNIX file for reading and/or writing

Synopsis

```
int open(path, oflag)
char *path;
int oflag;
```

Description

The *open()* macro opens a UNIX file, returning an UNIX file descriptor. *path* is the name of the file to be opened. *oflag* is the mode in which the file will be opened. The possible modes may be found in the header file */usr/include/fcntl.h*. Some useful modes are:

read only	0
write only	1
read/write	2
no delay	4
append	8
create	256 (HP-UX) or 512 (SunOS)
truncate	512 (HP-UX) or 1024 (SunOS)

These modes may be combined by adding the appropriate values together.

This macro is an interface to the UNIX system call *open(2)*. Refer to the *HP-UX Reference Manual* for detailed information.

Diagnostics

If the system call to *open(2)* is successful, the system file descriptor is returned. Otherwise, *-1* is returned and a system generated error message is written to the journal window of the debugger.

Example

The following command file segment defines two global debugger symbols and includes the definition of a user-defined macro that uses open().

```
Symbol Add int infile
Symbol Add int outfile

Debugger Macro Add int open_files(infile, outfile)
char    *infile;    /* file to read from */
char    *outfile;   /* file to write to */
{
    /* open input file in read only mode */
    infile = open(infile, 0);
    if (infile == -1)
        return 0;    /* open failed */

    /* create output file in read/write mode */
    outfile = open(outfile, 258);
    if (outfile == -1)
        return 0;    /* open failed */

    return 1;    /* both files were opened successfully */
}
```



pod_command

Function

Send terminal interface commands to the emulator

Synopsis

```
int pod_command(command, response)
char *command, *response;
```

Description

The `pod_command` macro sends the string in *command* to the emulator, and puts any response text in *response*. If multiple lines of text are returned, the lines are separated in *response* with a new line (`\n`) character. If *response* is a null pointer (`0`), any response is ignored.

Caution

This macro is primarily for diagnostic purposes. Use of this macro to send terminal interface commands that change the state of the emulator or analyzer may produce unexpected and **UNSUPPORTED** behavior.

Diagnostics

If the command produces no error, this macro returns a one (1). Otherwise, the macro returns a zero (0) and the debugger displays the error or errors in the debugger error window.

Make sure that the *response* string is large enough to hold any data returned from the emulator. Responses put into debugger variables will be truncated to the maximum length of the debugger string. The debugger will not give an error indication.

Examples

To get the first 99 characters of emulator version information:

```
Symbol Add char resp[100]  
Debugger Macro Call pod_command("ver",resp)  
Expression Printf "%s",resp
```

To send the emulator "help" command and ignore output:

```
Debugger Macro Call pod_command("help",0)
```

To send an invalid command to the emulator:

```
Debugger Macro Call pod_command("silly",0)
```

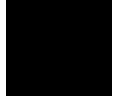

read

Function

Read from a system file

Synopsis

```
int read(fildes, buf, nbyte)
int    fildes;
char   *buf;
unsigned nbyte;
```

Description

The read macro reads from a system file. This macro is an interface to the UNIX system call *read(2)*. Refer to the *HP-UX Reference Manual* for detailed information.

Diagnostics

If the system call to read(2) is successful, the number of bytes read is returned. Otherwise, *-1* is returned and a system generated error message is written to the journal window of the debugger.

Example

The following command file segment defines two global debugger symbols and includes the definition of a user-defined macro that uses read().

```
Symbol Add int infile
Symbol Add int outfile
Debugger Macro Add int foo(infile, outfile)
int    infile;    /* file descriptor to read from */
int    outfile;   /* file descriptor to write to */
{
    char buf[80];

    while (!read(infile, buf, 80))
        write(outfile, buf, 80);
}
```

reg_str

Function

Get register value

Synopsis

```
unsigned long reg_str(str1)
char *str1;
```

Description

The `reg_str` macro gets the contents of a register using a string variable representation of its name. This is not possible using standard debugger commands. The register value is returned by the macro.

Diagnostics

If the string does not contain a valid register name, an unknown value will be returned and the debugger will display an error message in the debugger error window.

Examples

To display the value of register D0:

```
Symbol Add char reg_name[10]
Debugger Macro Call strcpy(reg_name, "@D0")
Expression Display_Value reg_str(reg_name)
```

To display the value of register D1:

```
Expression Display_Value reg_str("@D1")
```

To display the value of register D1:

```
Expression C_Expression reg_str("@D1")
```



showversion

Function

Show the software version number for the debugger product

Synopsis

```
void showversion ()
```

Description

The showversion macro lists the software version number for your debugger product.

strcat

Function

Concatenate two strings

Synopsis

```
char *strcat (dest, src)
char *dest, *src;
```

Description

The `strcat` macro appends a string to the end of another string. The string in `src` is appended to the string in `dest` and a pointer to `dest` is returned.

Diagnostics

No checking is done on the size of `dest`.

strchr

Function

Locate first occurrence of a character in a string

Synopsis

```
char *strchr (str1, byte_value)
char *str1;
char byte_value;
```

Description

The `strchr` macro returns a pointer to the first occurrence of the character *byte_value* in the string *str1*, if *byte_value* occurs in *str1*.

Diagnostics

If the character *byte_value* is not found, `strchr` returns a NULL pointer. For debugger variables, -1 (0xFFFFFFFF) is returned if *byte_value* does not occur.

strcmp

Function

Compare two strings

Synopsis

```
unsigned long strcmp (str1, str2)  
char *str1,  
char *str2;
```

Description

The `strcmp` macro compares strings in lexicographic order. Lexicographic order means that characters are compared based on their internal machine representation. For example, because an ASCII 'A' is 41 hexadecimal and an ASCII 'B' is 42 hexadecimal, 'A' is less than 'B'.

The strings *str1* and *str2* are compared and a result is returned according to the following relations:

relation	result
<code>s1 < s2</code>	negative integer
<code>s1 = s2</code>	zero
<code>s1 > s2</code>	positive integer

Diagnostics

Strings are assumed to be NULL terminated or to be within the array boundaries. The comparison is always signed, regardless of how the string is declared.

strcpy

Function

Copy a string

Synopsis

```
char *strcpy (dest, src)
char *dest,
char *src;
```

Description

The `strcpy` macro copies *src* to *dest* until the NULL character is moved. (Copying from the right parameter to the left resembles an assignment statement.) A pointer to *dest* is returned.

Diagnostics

No checking is done on the size of *dest*.

stricmp

Function

Comparison of two strings without case distinction

Synopsis

```
unsigned long stricmp (str1, str2,)  
char *str1;  
char *str2;
```

Description

The `stricmp` macro compares `str1` with `str2` without case distinction. This means that the strings "ABC" and "abc" are considered to be identical.

The strings `str1` and `str2` are compared and a result is returned according to the following relations:

relation	result
<code>s1 < s2</code>	negative integer
<code>s1 = s2</code>	zero
<code>s1 > s2</code>	positive integer

Diagnostics

Strings are assumed to be NULL terminated or to be within the array boundaries because the comparison is limited to the number of stated characters. The comparison is always signed, regardless of how the string is declared.

strlen

Function

String length

Synopsis

```
unsigned long strlen (str1)  
char *str1;
```

Description

The `strlen` macro returns the length of a string. It returns the length of *str1*, excluding the NULL character.

Diagnostics

If *str1* is not properly terminated by a NULL character, the length returned is invalid.

strncmp

Function

Limited comparison of two strings

Synopsis

```
unsigned long strncmp (str1, str2, count)
char *str1;
char *str2;
unsigned count;
```

Description

The `strncmp` macro compares strings in lexicographic order. Lexicographic order means that characters are compared based on their internal machine representation. For example, because an ASCII 'A' is 41 hexadecimal and an ASCII 'B' is 42 hexadecimal, 'A' is less than 'B'.

The *count* in the synopsis above specifies the maximum number of characters to be compared.

The strings *str1* and *str2* are compared and a result returned according to the following relations:

relation	result
$s1 < s2$	negative integer
$s1 = s2$	zero
$s1 > s2$	positive integer

Diagnostics

Strings are not required to be NULL terminated or to fit within the array boundaries because the comparison is limited to the number of stated characters. Less than *count* characters will be compared if the strings are smaller than *count* characters. The comparison is always signed, regardless of how the string is declared.

until

Function

Run until expression is true

Synopsis

```
char until (boolean)  
int boolean;
```

Description

The `until` macro returns a zero when *boolean* is nonzero. The `Until` macro is used with the `Program Run` and `Program Step With_Macro` commands. It halts execution when the expression passed is true, and continues when the expression passed is false. Any C expression resulting in a value may be used.

Example

```
Program Run Until #3 ,#17 ,printf ;until (i==3 || x < y)
```

The command above sets temporary breakpoints at line numbers 3 and 17 in the current module and at entry to the function *printf*. When any one of these locations is encountered by the executing program, the debugger will stop and check the *until* conditional statements. If the variable *i* is equal to 3, or the variable *x* is less than *y*, a break will occur. Otherwise, program execution continues.

when

Function

Break when expression is true

Synopsis

```
char when (boolean)  
int boolean;
```

Description

The `when` macro returns a zero when *boolean* is nonzero; it returns a one when *boolean* is zero. This macro is used with the `Breakpt Instr` command. When used with this command, program execution will halt when the stated expression is true, and will continue when the stated expression is false. Any C expression resulting in a value may be used.

Example

```
Breakpt Instr strcpy;when(*str==0)
```

This command sets a breakpoint at the entry point of the routine `strcpy`. Each time the breakpoint occurs, the `when` macro is executed. The macro causes program execution to stop when the byte pointed to by *str* is zero.



word

Function

Return a word value at the specified address

Synopsis

```
unsigned short int word (addr)  
void *addr;
```

Description

The `word` macro returns a `WORD` (2-byte) value of the memory at the specified address. The value of the expression `addr` is computed and used as the address.

Diagnostics

The `WORD` value of the memory at that address is returned.

write

Function

Write to a system file

Synopsis

```
int write(fildes, buf, nbyte)
int    fildes;
char   *buf;
unsigned nbyte;
```

Description

The write macro writes to a system file. This macro is an interface to the UNIX system call *write(2)*. Refer to the *HP-UX Reference Manual* for detailed information.

Diagnostics

If the system call to write(2) is successful, the number of bytes written is returned. Otherwise, *-1* is returned and a system generated error message is written to the journal window of the debugger.

Example

The following command file segment defines two global debugger symbols and includes the definition of a user-defined macro that uses write().

```
Symbol Add int infile
Symbol Add int outfile
Debugger Macro Add int foo(infile, outfile)
int    infile;    /* file descriptor to read from */
int    outfile;   /* file descriptor to write to */
{
    char buf[80];

    while (!read(infile, buf, 80))
        write(outfile, buf, 80);
}
```





Debugger Error Messages

A list of the error messages generated by the debugger.

Chapter 16: Debugger Error Messages

The debugger displays the error window whenever it detects a command error. The debugger displays an error message and a pointer to the location where it detected the error.

This chapter lists and describes the error messages and warnings issued by the debugger. These errors are listed numerically with possible error solutions.

- 4 **Invalid characters follow command.**
A command was entered with incorrect characters or with more characters than were expected. Check the command name and re-enter the command.
- 5 **This command is not implemented yet.**
The command specified is currently not supported, but will be implemented in a later release.
- 6 **Unknown switch.**
An attempt was made to specify a switch that does not exist. Check the command syntax for the switches supported.
- 7 **Argument missing.**
A command was entered without an argument that is required to execute the command. Check the syntax description for the command and enter the command again with the correct argument specification.
- 8 **Invalid argument.**
The argument specified is not valid for this command. Check command syntax and re-enter the command with a valid argument.
- 9 **Unexpected separator encountered.**
The argument separator is not valid in this context. Check the syntax and enter the correct separator.
- 10 **Unknown expression character.**
The specified expression character is not recognized by the debugger. Check the syntax and enter the correct expression character.
- 11 **Missing ')', ']', or '}' in expression.**
The matching right parentheses, right bracket, or right curly brace in the specified expression is missing. Check the expression and add the appropriate right delimiter.

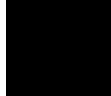

12 **Missing '(', '[', or '{' in expression.**

The matching left parentheses, left bracket, or left curly brace in the specified expression is missing. Check the expression and add the appropriate left delimiter.

13 **Missing end quote.**

The second quotation mark for a character string is missing at the end of the line. Terminate the character string with an ending quotation mark.

14 **Invalid expression element.**

An expression element was specified incorrectly. The error window will display the expression specified and place a pointer at the position where the invalid element is located. Check the syntax description and re-enter the command. Possible errors include: invalid value, missing operand, missing operator, and unknown operand combination.

15 **Invalid filename.**

The filename specified could not be created. Valid filenames are dependent upon your host computer system.

16 **Invalid line number.**

The line number specified is not valid. Line numbers must be preceded with a pound sign (#), and must be in a valid range. This error will occur if you enter a pound sign followed by zero or if you enter a pound sign without a number.

17 **Invalid address value.**

This error indicates that a value was used for an address that cannot be interpreted as an address (for instance, a floating point number).

18 **Invalid structure member.**

A member name was given that is not a member of the specified structure. Member names must be members of the specified structure.

- 19 **Invalid instruction address.**
- This error occurs mainly in high-level mode. In high-level mode, this error will occur if the instruction address is not a function name or line number. Code addresses in high-level mode may not be numeric or expressions. In assembly-level mode, most instruction address values are legal.
- 20 **Invalid port value.**
- The specified port does not exist, or the port value was not specified with the Memory Inport Assign command. Port values must be specified with the Memory Inport Assign command.
- 21 **The values are not correct for this expression.**
- An attempt was made to use an operand type that is not allowed for this operator. Operators must match operands according to the C language specifications.
- 22 **Upper bound less than lower bound.**
- An attempt was made to specify a lower bound that is greater than the upper bound. The upper bound must be greater than the lower bound.
- 23 **Upper bound missing.**
- An attempt was made to specify a lower bound without an upper bound. The upper bound must be specified.
- 24 **Function symbol ranges not allowed.**
- An attempt was made to specify a range from one function to another in high-level mode. Function to line number is allowed.
- 25 **Range not of addresses.**
- A print or trace command was entered, but the specified range contained a value instead of an address. Place an ampersand (&) before the symbol name in the range.

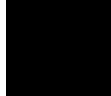

26

Invalid screen specification.

The command entered contains a screen specification that does not correspond to the screen where the specified window is located, or the specified screen does not exist. The screen number should be verified.

27

Invalid window specification.

You tried to create or alter the size of a window, but the screen number, window number, or size coordinates were illegal. See the Window Open command for valid window specifications.

28

Invalid cast. Must use format '(type)'.

This error indicates that type casting was attempted outside of an expression, or without being enclosed in parentheses. Types can only be used in expressions as casts, and must be enclosed in parentheses.

29

Unknown special key.

A key was pressed that the debugger does not recognize.

30

Start line invalid.

The starting line for the Program Find_Source command may be omitted, or may be any valid line optionally within a module.

31

Invalid exception vector.

You tried to specify an exception vector that is invalid. In a Program Interrupt Add command, the optional exception vector must be in the range of 0 to 255.

32

Invalid trace speed.

An attempt was made to specify a step speed with the debugger Option General Step_Speed command that is not in the valid range. Tracing speed ranges from 0 to 100.

33

Must be ON or OFF.

An attempt was made to specify an invalid argument with an option. Options can be switched to ON or OFF.

- 34 **Cannot divide by zero.**
An attempt was made to divide by zero within an expression of Expression Display_Value or Expression C_Expression.
- 35 **This feature not available in this version.**
- 51 **This command cannot be used in this mode.**
A command that is not supported in the current mode was issued. The Program Display_Source command is only supported in high-level mode, and the Memory Display Mnemonic command is only supported in assembly-level mode.
- 52 **Switches cannot be used together.**
Two switches of the same group were given. Only one switch per group may be specified.
- 53 **Invalid switch given for this command.**
The specified qualifier is not associated with the specified command. Check the command syntax and re-enter the command.
- 54 **Value too large.**
A value that is out of range was specified. Values must be in the valid range for the command.
- 55 **Instruction expressions are invalid in this mode.**
An expression was used for a code address in high-level mode. Only a single line number or function symbol may be used in high-level mode.
- 56 **Module not found.**
The specified module name does not exist. Specify a valid module name.

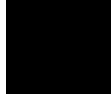

57

Line number not found.

The line number specified does not exist in the current module. If the line number exists in a different module, the module name must be specified.

58

Symbol not found.

The symbol name was entered incorrectly, or the symbol does not exist. The symbol name may have been mistyped.

59

Macro not found.

The specified macro has not been defined, or an invalid macro name was entered. Check the macro name, or define the macro and re-enter the macro name.

60

File not found.

The specified file does not exist in the current directory, or in the search directories. Check the current directory for the filename that was specified. A typing error may have occurred.

61

Structure member not found.

The specified structure member does not exist in the specified structure. Check the structure definition for the member that was specified. A typing error may have occurred.

62

Numeric addresses not allowed in this mode.

An attempt was made to specify an invalid address value.

63

Line numbers from different modules.

Line numbers from different modules were specified. Only one module specification may be given.

65

Port input does not come from file or string.

You cannot rewind an input port that does not get its input from a file or a string.

- 66 **Port output does not go to a file.**
Only port output directed to a file may be rewound with the Memory Port Rewind Output command.
- 67 **This breakpoint is already set.**
An attempt was made to set a breakpoint that already exists. The current breakpoint must be deleted before it can be reset.
- 68 **Port value not found.**
A port was specified that has not been created with the Memory Inport Assign or Memory Outport Assign command.
- 69 **Address in range already specified as Read_Only or Guarded.**
An address that was previously specified with a Memory Map Read_Only or Memory Map Guarded command was specified. Memory Map Read_Only and Memory Map Guarded commands can only act on Write_Read areas.
- 70 **Arguments do not match any Read_Only or Guarded area.**
The arguments specified with a Memory Map Write_Read command do not match the corresponding Memory Map Read_Only or Memory Map Guarded command. The arguments must match exactly. Entering a Memory Map Show command gives a map of Read_Only and Guarded areas.
- 71 **Address range contains unacceptable breakpoints.**
An illegal breakpoint was specified.
- 72 **Bad size specification for window.**
An illegal size specification was given for a window. See the Window New command for the correct size specifications.
- 73 **Cannot repeat a cycle count of zero.**
A Program Interrupt Add command qualifier cannot request that an interrupt occur every zero cycles; this would cause an infinite loop.

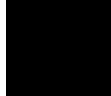

74 **Invalid level number. Must be 1 to 7.**

The Program Interrupt Add command, as well as the 68040 family of microprocessors, permit 7 levels of interrupts.

75 **Attempt to delete nonexistent breakpoint(s).**

You tried to clear a breakpoint that was not previously set. Check that the breakpoint was set, or not already cleared.

76 **Symbol not available from this scope unreferenced.**

You must reference the symbol with a qualified function or module name.

77 **Symbol with this name already exists.**

You tried to define a symbol that was previously defined. Another name should be used.

78 **Cannot create this symbol.**

An error occurred when trying to create the symbol. Check that it is valid as a symbol name.

79 **Symbol is not a module.**

An attempt was made to enter a symbol when a module was expected.

80 **Invalid stack level.**

This error indicates that a stack level was specified that is greater than the current stack nesting.

81 **Not a source function.**

An attempt was made to enter an illegal function with the Program Context Set command. The Program Context Set command requires either a module name or a source procedure name.

82 **Cannot delete this symbol.**

Registers and predefined symbols cannot be deleted.

- 83 **Invalid processor name.**
This error indicates that you specified a processor other than one supported by your debugger. See your user's guide for a list of supported microprocessors.
- 84 **Breakpoint limit exceeded.**
The number of breakpoints allowed has been exceeded. This breakpoint has not been set.
- 91 **Internal command/expression processor error.**
An internal memory error has occurred.
- 92 **Not enough memory for expression.**
The expression specified requires more memory than there is available. Try clearing breakpoints or deleting macros to obtain more memory.
- 93 **Invalid memory/register address.**
An attempt was made to read or write to inaccessible target memory. Target memory that is protected cannot be read from or written to.
- 94 **Source is not available for this module.**
An attempt was made to access source code in an assembly language module. Use the Debugger Level command or the **F3** function key to switch to assembly-level mode to display this module.
- 95 **Cannot build source table.**
There is not sufficient memory available to build the source table for source display.
- 96 **Cannot read absolute file.**
An attempt was made to load a file that is not an absolute object module. The code may need to be compiled, assembled, or linked.

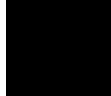

- 97 **Cannot build disassembly table.**
There is not sufficient memory available to build the disassembly table for up-arrow and page-up support in the disassembler.
- 98 **Cannot split monitor lines.**
An attempt was made to monitor different elements on the same line. Only one element per line may be monitored.
- 99 **No empty lines available.**
An attempt was made to specify a line number with the Expression Monitor Value command, but the entire window is already filled. The number of lines in the data window is limited to 17. Use the Expression Monitor Delete command to delete some of the lines.
- 100 **No available windows.**
This error indicates that the numbers allocated for user-defined windows have all been used. Some windows must be deleted before creating another user-defined window.
- 101 **Cannot open file.**
An attempt was made to open a file that does not exist.
- 102 **Local variable not alive.**
A local variable was specified, but the function containing the variable is not active (current or nested).
- 103 **No source level information available.**
The source file for the specified source module cannot be found.
- 104 **A log or journal file is already open.**
An attempt was made to open a new log file when one is already in use. Close the existing log file with the File Log Off command before opening a new log file.

- 106 **Not enough memory.**
This error indicates that not enough memory was available for the specified command.
- 107 **Terminated when processing absolute file.**
This error indicates that an invalid control value was encountered in loading the ".x" file.
- 108 **At start of function, no local variables yet.**
This error indicates that arguments and local variables are not available to the debugger at this time. They are available when the prolog to the function has been executed.
- 109 **Local already defined.**
This error indicates that a local variable has been defined twice in a macro definition. One definition of the variable must be deleted.
- 110 **This argument not defined.**
This error indicates that an argument was declared that was not defined on the command line with the Debugger Macro Add command.
- 111 **This macro is in use already.**
Macros cannot be called recursively.
- 112 **This is not allowed outside of a macro.**
Keywords are allowed in macros only.
- 113 **Cannot begin execution from a macro.**
Program Run, Program Step With_Macro, Program Step, and Program Step Over are not allowed from within macros. The PC may be altered with the Memory Register @PC= command.

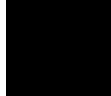

- 114 **This command not allowed from a macro.**
Some commands are not allowed from a macro, such as Debugger Host_Shell and Debugger Macro Add.
- 115 **Invalid float expression, results in NAN.**
A floating point expression resulted in a non-number.
- 116 **Cannot convert float value.**
Float value is too large to convert to an integer.
- 117 **Help file unavailable.**
This error indicates that the help file, "db68k.hlp", was not found.
- 118 **Unsupported float type.**
A floating point type other than 32 or 64 bit has been defined.
- 119 **Cannot get address of register or constant.**
An attempt was made to find the address of a register or constant. One example is: Expression Display_Value &@a1.
- 121 **Cannot open command file for reading.**
This error indicates that the command file specified cannot be found.
- 122 **Include file name too long.**
This error indicates that the filename specified (including its pathname) is too long to be handled by the debugger's internal buffers. Limit the number of characters in the filename specification, or move the file to the default directory.
- 123 **Could not read source line.**
This error indicates that there was an error reading the C source file.

- 124 **Cannot create file for logging.**
This error indicates that there was an error when trying to create the specified log file or that the current directory does not have write permission.
- 125 **Write error occurred while writing to a file.**
This error indicates that the disk is probably full.
- 126 **Cannot open startup file < startupfile> .**
This error indicates that the debugger could not open the specified setup file. The filename may have been misspelled, or the filename does not exist.
- 127 **Invalid number of arguments for macro.**
This error indicates that an incorrect number of arguments was specified in the call or too many parameters were used in the macro definition.
- 128 **Cannot show built-in macros.**
This error indicates that predefined macros cannot be shown with the Debugger Macro Display command. They have no text.
- 129 **Runtime error in macro.**
This error indicates that an error occurred when executing a macro.
- 130 **Command not implemented in simulator version.**
This error indicates that the command entered will not work in this version of the debugger.
- 131 **'option chip' not implemented in this version.**
This error indicates that "option chip" will not work in this version of the debugger.
- 132 **Breakpoint adjusted.**
This error indicates that the breakpoint has been moved to an address at the start of an instruction. See the Debugger Option General Align_Bp command syntax description in the "Debugger Commands" chapter.

- 133 **Error return from child process.**
- This error indicates that an error was returned when interacting with the host system through the Debugger Host_Shell command.
- 134 **This command cannot be executed from batch mode.**
- This error indicates that the command entered will not work in batch mode.
- 135 **No search string available.**
- The command Program Find_Source Next was entered without previously entering the Program Find_Source Occurrence command.
- 136 **Cannot open file for logging; file in use for commands.**
- The file specified for logging is currently open and being used to read commands from. Choose another name for the log file.
- 137 **Cannot open file for logging; file in use for logging.**
- The file specified to read commands from is open and being used as a log file. Turn off logging with the File Log OFF command or choose another name for the command file.
- 141 **Miscellaneous error.**
- All available error information is displayed on the screen. Any one of a number of error messages may be displayed on your screen.
- One possible error message is:
- No valid BBA spec file for <processor> processor**
- You must have the HP Branch Validator product for your processor installed on your system in order to use the Memory Unload_BBA command.
- Another possible message is:
- BREAK active, cannot set up TRACE TRIGGER**
- You must delete all breakpoints before you can set up a trace. Select Breakpoints—**Delete All then try setting the trace again.**

- 142 **Miscellaneous warning.**
All available warning information is displayed on the screen. Any one of a number of warning messages may be displayed on your screen.
- 143 **Miscellaneous note.**
All available information is displayed on the screen. Any one of a number of notice messages may be displayed on your screen.
- 145 **Too many interrupts pending.**
Too many Program Interrupt commands have been given without a sufficient number of interrupts being processed. The current limit on pending interrupts is 16.
- 146 **Void has no value.**
This error message is returned when certain commands are attempted on voids.
- 147 **Invalid suboption.**
This suboption does not work with this command. Refer to the "Debugger Commands" chapter of this manual for valid suboptions for various commands.
- 148 **Invalid option.**
This option does not work with this command. Refer to the "Debugger Commands" chapter of this manual for valid options for various commands.
- 149 **No temporary breakpoints for the macro.**
The command Program Run From < addr> ;< macro> will return this error because a temporary breakpoint has not been specified.
- 150 **Invalid type for this argument, expecting a target address.**
The command was expecting an address. Re-enter the command with a target memory address.
- 151 **Invalid type for this argument, expecting a number.**
The command was expecting a number. Re-enter the command with a number.

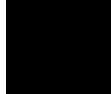

- 152 **Cannot delete: more than one symbol with this name.**
- Multiple symbols with the same name exist. More fully qualify the symbol to make it unique and then retry the command.
- 153 **Cannot save into this address (not 'lvalue').**
- The expression used is not an address. This command can only save at an address which is an 'lvalue'. Check the address and then retry the command.
- 154 **Invalid type for macro argument.**
- This is an invalid type for the macro argument. Refer to the chapter on macros for more information on valid types for macro arguments.
- 155 **Stopped by user.**
- The execution of this command was halted by the user.
- 156 **Not a logical expression (= , != , < , > , <= , >= , !).**
- The expression entered is not a logical expression. Refer to the "Expressions and Symbols in Debugger Commands" chapter for more information on logical expressions and then re-enter the command.
- 157 **Cannot create log file.**
- Unable to open the specified file as a journal file.
- 159 **Interrupted during I/O.**
- Keyboard I/O was in cooked mode and a read from the keyboard was interrupted.
- 161 **Bad command for current context (No root, start, etc.)**
- 162 **Ambiguous member name, must qualify with more local class.**
- The referenced C++ member function may be one of several function which have the same name. Use a class name to be more specific.
- 163 **Cannot currently access via virtual base class.**



Debugger Versions

Information about how this version of the debugger differs from previous versions.

Version C.05.10

Larger Symbol Table

The debugger can load up to 16 million symbols. The previous limit was 64K symbols.

Each symbol uses 128 bytes of memory. If so many symbols are loaded that your host operating system runs out of swap space, the practical limit may be less than 16 million symbols.

More Global Symbols

The maximum number of global symbols that can be read from an HP-MRI IEEE-695 file has been increased from 8000 to 64K symbols.

Radix Option Side Effects

Input and output values are interpreted as hexadecimal only for assembly-level references.

To cast a high-level expression as hexadecimal, use a leading "0x" or a trailing "h".

When the radix option is set to **hex**, the following inputs will *not* be interpreted as hexadecimal:

- line numbers starting with "# "
- variables in high-level expressions, including **C_Expression** and macro expressions.
- debugger variables including:
 - breakpoint numbers
 - viewport numbers
 - data viewport line numbers

New Demand Loading Option

The **-doff** command line option turns off demand loading, overriding the option in the startup file.

Graphical User Interface

The debugger now has a graphical user interface. Some of the many features of the graphical interface include:

- pull-down and pop-up menus
- user-definable action keys
- a mouse-driven command line
- improved on-line help
- powerful macro editing
- interactive emulator configuration

The debugger's old standard interface may still be used.

New Product Number

The old product number of this debugger was The new number is HP B1477B.

New Reserved Symbols

@ENTRY is the address of the first executable statement in a function. For example, `func1\@ENTRY` is the first executable statement of `func1`. If you set a breakpoint at `func1\@ENTRY` rather than at `func1`, the local variables in `func1` will be active.

@ROOT is the name of the root of the symbol tree represented by the program counter.

@FILE is the name of the file containing the current program counter (if any).

New Predefined Macro

The `cmd_forward()` macro allows you to send commands to other interfaces (such as the emulator interface) which are connected to the emulator. You can even use this macro to let your target code control the debugger.



Environment Variable Expansion

Operating system environment variables will now be expanded when they appear in a debugger command.

For example, "Debugger Directory Change_working \$HOME/test" will now work as expected.

Target Program Function Calls

You may now reference target program functions in C expressions.

Target and debugger variables may be passed by value, and target variables may be passed by reference.

C+ + Support

The debugger now supports C+ + name mangling/de-mangling and object/instance breakpoints for the Microtec Research Inc. C+ + compiler.

Simulated Interrupts Removed

The debugger/emulator no longer supports simulated interrupts.

Simulated I/O Changes

The debugger's simulated I/O features are now compatible with the emulation interface's simulated I/O.

Simulated I/O in the debugger/emulator now requires the setting up of simulated I/O polling and addresses in the emulator configuration.

The I/O Report no longer reports on processes used.

The keyboard EOF function is no longer supported since it is not supported by the emulation interface's I/O.

Part 5

Installation Guide



Part 5

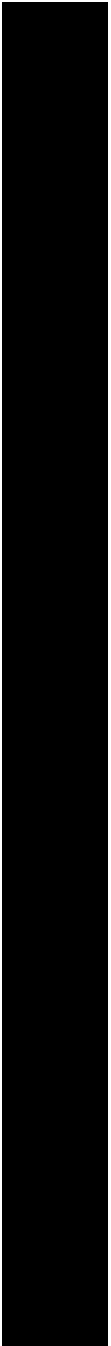

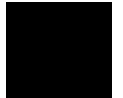

Installation

How to install the debugger software on your computer.

Installation at a Glance

The debugger/emulator is a tool for debugging C programs for 68040 series microprocessors in a emulation execution environment.

Follow these steps to install the debugger/emulator:

- 1 Install the software on your computer.
- 2 Install the emulator hardware.
- 3 Set up your software environment to run the debugger.
- 4 Verify the software installation.

Supplied interfaces

When an X Window System that supports OSF/Motif interfaces is running on the host computer, the debugger/emulator has a *graphical interface* that provides pull-down and pop-up menus, point and click setting of breakpoints, cut and paste, on-line help, customizable action keys and pop-up recall buffers, etc.

The debugger/emulator also has a *standard interface* for several types of terminals, terminal emulators, and bitmapped displays. When using the standard interface, commands are entered from the keyboard.

The installation procedure described in this chapter shows you how to install both debugger/emulator interfaces and verify the installation.

Supplied filesets

As you install the software, you will see a list of the filesets on the tape. The filesets are identified by their HP product number.

The tape may contain several products. Usually, you will want to install all of the products on the tape.

However, to save disk space, or for other reasons, you can choose to install selected filesets. For example, if you plan on using the debugger/emulator's standard interface instead of the graphical interface, you can save about 3.5 megabytes of disk space by not installing the XUI suffixed filesets. (Also, if you choose not to install the graphical interface, you will not have to use the "-t" command line option to start the standard interface.)

Emulator/Analyzer Compatibility

If you are using both the debugger's graphical interface and the emulator/analyzer interface, check that you have an up-to-date version of the emulator/analyzer software. Your emulator/analyzer software should have the same revision number as the debugger software: 5.xx.

If the emulator/analyzer software has a revision number of 4.xx or earlier, the following restrictions apply:

- Do not run the debugger at the same time as the emulator/analyzer window. However, you may use them nonconcurrently.
- Use the debugger interface, not the emulator/analyzer interface, to load and modify the emulation configuration. Thus, be sure to start your session from the debugger.

C Compiler Installation

Some older versions of HP C Cross Compilers will overwrite the file \$HP64000/bin/db68k, making the graphical interface unavailable. If you encounter this problem, install the C compiler *before* you install the debugger software.

To install software on an HP 9000 system

Required Hardware and Software

To install and use the debugger/emulator's graphical interface, you need:

- HP 9000 Series 300/400 computer running HP-UX version 7.03 or later, or HP 9000 Series 700 computer running HP-UX version 8.01 or later.

To check the HP-UX operating system version, enter the **uname -a** command at the HP-UX prompt. If the version number of the HP-UX operating system is less than 7.03, you must update the operating system to version 7.03 or higher before you can use the debugger. (Refer to the "Updating HP-UX" chapter of the *HP-UX System Administration Tasks* manual for detailed information concerning updating your system.

Motif/OSF. For HP 9000 Series 700 workstations, you must also have the Motif 1.1 dynamic link libraries installed. They are installed by default, so you do not have to install them specifically for this product, but you should consult your HP-UX documentation for confirmation and more information.

Hardware and Memory. The debugger/emulator's graphical interface requires workstations to have a minimum of 16 megabytes of memory. Series 300 workstations should have a minimum performance equivalent to that of a HP 9000/350. A color display is also highly recommended.

- Approximately 3 Mbytes of disk space.
- The emulator hardware.
- HP B1477 debugger/emulator software.

Step 1. Install the software

During the install process, you have some choices about how much you load from the product media. As a general rule, you should load everything from the media. However, to save disk space, or for other reasons, you can choose to install selected filesets.

There are several reasons why you might want to install selected filesets:

- You were shipped the HP B1471 64000-UX Operating Environment instead of the HP B1471 64700 Operating Environment, you were shipped files that are not necessary to the operation of the debugger/emulator. Excluding these files will save you about 4.5 megabytes of disk space.
- You will not be using the debugger's graphical interface. In this case, you should exclude the filesets that contain the graphical interface because:
 - You will save about 3.5 megabytes of disk space.
 - If you are using X Windows, the graphical interface is the default interface. If you load the graphical interface, but do not use it, you will have to use a special command line option each time you start the standard interface.

The following sub-steps assume that you may want to exclude partitions or filesets. Perform the following sub-steps to load the software on your system:

- 1 Become the root user on the system you want to update.
- 2 Make sure the tape's write-protect screw points to SAFE.
- 3 Put the product media into the tape drive that will be the *source device* for the update process.
- 4 Confirm that the tape drive BUSY and PROTECT lights are on.

If the PROTECT light is not on, remove the tape and make sure the tape's write-protect screw points to SAFE. If the BUSY light is not on, check that the tape is installed correctly in the drive and that the drive is operating correctly.

To install software on an HP 9000 system

- 5 When the BUSY light goes off and stays off, start the update program by entering

```
/etc/update
```

at the HP-UX prompt.

- 6 When the HP-UX update utility main screen appears, confirm that the source and destination devices are correct for your system. Refer to your HP-UX System Administration documentation if you need to modify these values.

- 7 Select the choice on the update menu that allows you to view the product partitions.

- 8 If you plan to install and use the debugger's graphical interface, do the following:

- Mark the debugger/emulator partition and the 64700 Operating Environment partition with "y" to confirm the installation of these partitions.

- 9 *If you do not want to install the debugger's graphical interface, do the following:*

- View the filesets for the 64700 Operating Environment.
- Mark the **XUI** fileset with "n" to exclude it from installation.
- Mark all other filesets in the partition with "y" to confirm installation.
- Return to the partition screen.
- View the filesets in the emulator-specific partition (named something like 68040 Series debugger/emulator).
- Mark the **XUI** fileset with "n" to exclude it from installation.
- Mark all other filesets in the partition with "y" to confirm installation.
- Return to the partition screen.

- 10 From the partition screen, choose the update utility softkey that starts the installation process.

To install the software on a Sun SPARCsystem™

Required Hardware and Software

To install and use the debugger/emulator's graphical interface, you need:

- Sun SPARCsystem computer running SunOS version 4.1 or 4.1.1 or greater. The tape uses the QIC-24 data format.
To check the SunOS operating system version, enter the **uname -a** command at the UNIX prompt. If the version number of the SunOS operating system is less than 4.1, you must update the operating system to version 4.1 or higher before you can use the debugger. For instructions on updating your system, see the Sun *Installing SunOS* manual.
- System V software. To find out whether the System V environment is already installed on your system, check that the directory `/usr/5bin` exists. For instructions on installing System V, see the Sun *Installing SunOS* manual.
- System V IPC facilities (semaphores). To find out whether the IPC facilities are installed on your system, type **ipcs**. For instructions on installing the IPC facilities, see the Sun *System and Network Administration* manual.
- At least 16 megabytes of memory (for the graphical user interface).
- Color display (optional, but recommended for the graphical user interface).
- Approximately 3 Mbytes of disk space.
- The emulator hardware.
- HP B1477 debugger/emulator software.

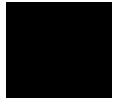

Step 1: Install the software

For instructions on how to install software on your SPARCsystem, refer to the *HP 64000-UX for SPARCsystems—Software Installation Guide*.

Normally you should install all of the filesets on the tape. If you do not wish to install the graphical interface, install everything except the XUI suffixed filesets. This will save about 3.5 megabytes of disk space.

Step 2: Map your function keys

If you are using the character-based Standard Interface, map your function keys by following the steps below:

- 1 Copy the function key definitions by typing:

```
cp $HP64000/etc/ttyswrc ~/.ttyswrc
```

This creates key mappings in the `.ttyswrc` file in your `$HOME` directory.

- 2 Remove or comment out the following line from your `.xinitrc` file:

```
xmodmap -e 'keysym F1 = Help'
```

If any of the other keys F1-F8 are remapped using `xmodmap`, comment out those lines also.

- 3 Add the following to your `.profile` or `.login` file:

```
stty erase ^H  
setenv KEYMAP sun
```

The erase character needs to be set to backspace so that the Delete key can be used for "delete character."

To install the software on a Sun SPARCsystem™

If you want to continue using the F1 key for HELP, you can use use F2-F9 for the Softkey Interface. All you have to do is set the KEYMAP variable. If you use OpenWindows, type:

```
setenv KEYMAP sun.2-9
```

If you use xterm windows (the xterm window program is located in the directory /usr/openwin/demo), type:

```
setenv KEYMAP xterm.2-9
```

Reminder: If you are using OpenWindows, add /usr/openwin/bin to the end of the \$PATH definition, and add the following line to your .profile:

```
setenv OPENWINHOME /usr/openwin
```

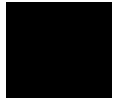

To install the emulator hardware

- 1 If necessary, install the emulator hardware into the HP 64700 Card Cage.

Turn to the *HP 64700 Series Installation/Service Guide* and follow the instructions for installing emulator, memory, or analyzer cards in the HP 64700 Series Cardcage. It may be that you already have installed the cards in the cardcage or your cardcage came with cards already installed.

- 2 Configure the HP 64700 for the communication channel.

Turn to the *HP 64700 Series Installation/Service Guide* and follow the instructions for configuring the emulator to communicate via LAN, RS-422, or RS-232. (RS-422 and RS-232 are only supported on HP 9000 Series 300/400 machines.)

- 3 Connect the HP64700 to your host computer.

Turn to the *HP 64700 Series Installation/Service Guide* and follow the instructions for connecting the emulator to your system. You can connect the emulator via LAN, RS-422, or RS-232.

When you have installed the emulator hardware, continue with Step 3 of these instructions.

To set up your software environment

Follow these steps to prepare your computer to run the debugger:

- 1 Start the X server.
- 2 Set the necessary environment variables.

To start the X server

If you are not already running the X server and a window manager, do so now. The X server is required to use the Graphical User Interface because it is an X Windows application. A window manager is not required to execute the interface, but, as a practical matter, you must use some sort of window manager with the X server.

- If you are using an HP workstation, start the X server and the Motif window manager by entering:

```
x11start
```

- If you are using a Sun workstation, enter:

```
/usr/openwin/bin/openwin
```

Consult the X Window documentation supplied with the operating system documentation if you do not know about using X Windows and the X server. The chapter “Using X Resources” in this book also discusses X Windows and the X server.

To start HP VUE

If you will be using the X server under HP VUE and have not started HP VUE, do so now.

HP VUE differs slightly from other window managers in that it does not read your `.Xdefaults` file to find resources you may want to customize. Instead, it uses resources from the X resource database. In order to customize resources for the Graphical User Interface under HP VUE therefore, you must either merge a file of customized resources with the X resource database, or set an environment variable that causes the X resource manager to read a file of customized resources. For ease of use, choose the `.Xdefaults` file as your merge file.

- To merge the file `.Xdefaults` with the X resource database, enter

```
xrdb -merge .Xdefaults
```

at the HP-UX prompt.

Customized resources will be merged with the X resource database and will be available for retrieval by the Graphical User Interface.

- To enable the graphical interface to find the `.Xdefaults` file directly, enter the following commands:

```
XENVIRONMENT=$HOME/.Xdefaults
```

```
export XENVIRONMENT
```

The graphical interface will be able to find and read the file in order to retrieve customized resources.

To set environment variables

The following instructions show you how to set these variables at the UNIX prompt. Modify your “.profile”, “.login”, or “.vueprofile” file if you wish these environment variables to be set when you log in.

- Set the DISPLAY environment variable.
- Set the HP64000 environment variable.
- Set the PATH environment variable to include the **usr/hp64000/bin** directory.

For the ksh login shell (most HP systems), set a variable by entering

```
export <variable>=<value>
```

For the csh login shell (most Sun systems), set a variable by entering

```
setenv <variable> <value>
```

The DISPLAY environment variable must be set before the debugger’s graphical interface will start. Consult the X Window documentation supplied with the UNIX system documentation for an explanation of the DISPLAY environment variable.

Set the HP64000 environment variable if you installed the software in a directory other than “/usr/hp64000” (that is, if you told the installation script to use a path other than “/”).

Modify the PATH environment variable to include the “\$HP64000/bin” directory and the HP64_DEBUG_PATH environment variable to specify search paths. Including **usr/hp64000/bin** in your PATH relieves you from prefixing HP 64700 executables with the directory path.

See Also

For information on setting the location of C source files, see page 93.

Examples

These examples use ksh syntax. If you are using csh as your login shell, then use the **setenv** style instead.

Chapter 18: Installation

To set up your software environment

If your system is named "myhost," set the display variable by typing:

```
export DISPLAY=myhost:0.0
```

If you installed the HP 64000 software in the root directory, "/", enter:

```
export HP64000=/usr/hp64000
```

```
export PATH=$PATH:$HP64000/bin
```

If you installed the software in the directory /users/team, enter:

```
export HP64000=/users/team/usr/hp64000
```

To find the logical name of your emulator

The *logical name* of an emulator is a label associated with a set of communication parameters in the `/usr/hp64000/etc/64700tab.net` file. The `64700tab.net` file is placed in the directory as part of the installation process.

- 1 Display the `64700tab.net` file by entering **more /usr/hp64700/etc/64700tab.net** at the HP-UX prompt.
- 2 Page through the file until you find the emulator you are going to use.

This step will require some matching of information to an emulator, but it should not be difficult to determine which emulator you want to address.

If you find the emulator listed in the file, note its name. If the emulator is not listed, you must modify the file (see the next page) in order for the debugger to access the emulator.

Examples

A typical entry for a 68040 emulator connected to the LAN would appear as follows:

```
#-----  
# Channel | Logical   | Processor | Remainder of Information for the Channel  
# Type   | Name     | Type     | (IP address for LAN connections)  
#-----  
lan:     em68040   m68040    21.17.9.143
```

A typical entry for an emulator connected to an RS-422 port would appear as follows:

```
#-----  
# Channel | Logical   | Processor | Host   | Physical | Xpar | Parity | Flow | Stop | Char  
# Type   | Name     | Type     | Name  | Device  | Mode |        |      | Bits | Size  
#       |          |          |       |         | OFF  | NONE   | XON | 2    | 8  
#-----  
serial:  em68040   m68040   myhost /dev/emcom23 OFF  NONE   RTS  2    8
```

To add an emulator to the 64700tab.net file

- 1 Make up a logical name for the emulator.

You will use this name to identify the emulator whenever you start the debugger. The name *em68040* is used as an example throughout this manual.

- 2 If the emulator is connected to a LAN, find out the Internet Address (IP address) of the emulator. (You will also need the LAN address to list the emulator in the */etc/hosts* file.)

If the emulator is connected using a serial port, find out the name of the computer to which the emulator is connected, the device file name for the emulator, the baud rate of the serial channel, and the flow control protocol of the serial channel.

- 3 Edit the */usr/hp64000/etc/64700tab.net* file and add a line for the emulator. The new line should look like one of the examples given on the previous page.

See Also

The *HP 64700A Card Cage Installation/Service Guide*.

The 64700tab on-line manual page.

To add an emulator to the */etc/hosts* file

- If the emulator is connected via a LAN, edit the */etc/hosts* file to add a line consisting of the emulator's Internet Address (IP Address) and name.

To verify the software installation

A number of new filesets were installed on your system during the software installation process. This step assumes that you chose to load the filesets for the debugger/emulator's graphical interface.

You can use this step to further verify that the filesets necessary to successfully start the graphical interface have been loaded and that customize scripts have run correctly. Of course, the update process gives you mechanisms for verifying installation, but these checks can help to double-check the install process.

- 1 Verify the existence of the **HP64_Debug** file in the **/usr/lib/X11/app-defaults** subdirectory by entering

```
ls /usr/lib/X11/app-defaults/HP64_Debug
```

at the HP-UX prompt.

Finding this file verifies that you loaded the correct fileset and also verifies that the customize scripts executed because this file is created from other files during the customize process.

- 2 Examine **/usr/lib/X11/app-defaults/HP64_Debug** near the end of the file to confirm that there are resources specific to your microprocessor.

Near the end of the file, there will be resource strings that contain references to specific microprocessors. For example, if you installed the debugger/emulator's graphical interface for the 68040 series microprocessors, resource name strings will have "debug*m68040" embedded in them.

To remove software

- 1 Find the fileset name of the product you wish to remove.

To see a list of the fileset names which you can remove, on an HP-UX system type:

```
ls /etc/filesets
```

Or, on a Sun system, type:

```
ls $HP64000/etc/filesets
```

Each file in this directory contains a list of files which were installed for that fileset.

- 2 Log in as root.
- 3 At the operating system prompt, type:

```
sysrm <product_number>
```

Sometimes you may wish to remove all of the files which were installed for a certain product. For example, maybe you have finished a software development project and you need to make more free space on your hard disk.

To make removing software easier, the installation script creates two files. The first file is a list of all of the files installed for a certain product. The list is stored by product number in the /etc/filesets directory. The second file is the sysrm script, which is stored in the \$HP64000/usr/hp64000/bin directory. The sysrm script removes the files listed in /etc/filesets for the specified product.

Example

If you wish to remove all of the files which were installed for the B1460 product, type:

```
sysrm B1460
```

Configuring Terminals for Use with the Debugger

If you are using the debugger's graphical interface, you do not need to read this section.

This section shows you how to:

- Configure HP terminals or bit-mapped displays.
- Configure DEC VT100 terminals.
- Configure DEC VT220 terminals.
- Set the TERM environment variable.
- Set up control sequences.
- Resize X terminal emulation windows running the standard interface.

Supported Terminals

The following table lists the terminals and bit-mapped display devices supported by the debugger. The environment variable TERM is the variable which most UNIX applications (such as the debugger) use to customize the application for a particular terminal, display or window. In /bin/sh and /bin/ksh, the TERM variables setting may be queried by typing:

```
echo $TERM
```

The term variable is usually set by the login process (usually by /etc/profile). See the *HP-UX System Administration Task Manual* for more information on adding Peripheral Devices (terminals and modems).

The following table shows the supported configurations for:

- RS-232 terminals.
- bit-mapped displays.
- X-Window support.

Chapter 18: Installation
Configuring Terminals for Use with the Debugger

Supported Terminals TERM Settings¹

Terminal/Driver Card	RS-232 Terminal	Bit Mapped Display	X-Windows (using client hpterm)
HP 2392	TERM= 2392		
HP 700/92	TERM= 70092		
HP 700/94	TERM= 70094		
VT100	TERM= vt100a		
VT220	TERM= vt220		
HP 700/22	TERM= vt220		
HP 64020A ⁴	TERM= 2392		
HP 98544[AB] ⁴		TERM= 300h ²	TERM= X-hpterm ³
HP 98547A ⁴		TERM= 300h ²	TERM= X-hpterm ³
HP 98548A ⁴		TERM= 98548	TERM= X-hpterm ³
HP 98550A ⁴		TERM= 98550	TERM= X-hpterm ³

Notes:

¹ TERMINFO= /usr/hp64000/lib/terminfo.

² On Bit Mapped Displays, you may need to set the function keys to *user* mode by holding down the **shift** key and then pressing the **user** key.

³ TERM may be set to X-hpterm, hpterm, hp2622, or 2392 (see note following this table).

⁴ Supported only on HP 9000 Series 300 computers.

RS-232 Terminals. RS-232 terminals interface to HP-UX by means of HP 98626, HP 98642, or HP 98629 RS-232 interface cards.

RS-232 terminals and bit mapped displays should be added to HP-UX according to the instructions in the *HP-UX System Administration Task Manual* for adding Peripheral Devices (terminals and modems).

Note

If TERM is set to 2392, the debugger attempts to draw solid lines using an alternate character set. For HP terminals, the debugger assumes this character set is the HP line drawing character set. The X11 command "hpterm" has the capability to shift in and out of an alternate character set. However, it defaults this character set to a font other than the HP line drawing font unless the line drawing font is explicitly specified as the alternate character set when the window is started. The alternate character set can be specified using an hpterm command line option or an X11 resource specification. See your HP-UX X11 documentation for more information.

Availability of fonts depend on the X11 server, not the X client program (hpterm). Only one HP line drawing font is available with HP-UX X11 servers. This font is "line.8x16". It must be used with the primary font "hp8.8x16" because the primary and alternate fonts must have the same dimensions. Refer to the "hpterm" manual page for more information.

Example: The following command starts an hpterm window with a primary font of hp8.8x16 and an alternate font of line.8x16.

```
hpterm -fn hp8.8x16 -fb line.8x16
```

Bit-Mapped Displays. Bit-mapped displays are listed by the boot up display as ITE (Internal Terminal emulator). They are high resolution display tops running without a window manager such as HP Windows or X Windows. Bit-mapped displays are supported only on HP 9000 computers.

X-Windows. X Windows refers to applications running on a bit-mapped display with X Windows managing the display top. Within X Windows, *hpterm* is a good general purpose HP terminal emulator for applications which are not specially customized for the X environment.

DEC Terminal ANSI Keypad Functions

The following figures show the ANSI keypad functions and the mapping of the top row of function softkeys.

Chapter 18: Installation
Configuring Terminals for Use with the Debugger

PF1 Softkey F1	PF2 Softkey F2	PF3 Softkey F3	PF4 Softkey F4,
7 Softkey F5	8 Softkey F6	9 Softkey F7	- Softkey F8,
4 Roll Up	5 Next Page	6 Insert Char	” Delete Char,
1 Roll Down	2 Prev Page	3 Unused	Enter CR,
0 Command Recall		Clear Line	^ ,

DEC Terminal Top Row Function Keys

F6	F7	F8	F9	F10		F11 (ESC)	F12 (BS)	F13 (LF)	F14
Softkey F1	Softkey F2	Softkey F3	Softkey F4	Softkey F4		Softkey F5	Softkey F6	Softkey F7	Softkey F8

To configure HP terminals or bit-mapped displays

- 1 Press the **System** key. (New function labels appear.)
- 2 Press the **Config Keys** key. (New function labels appear.)
- 3 Press the **Terminal Config** key.
- 4 Use the **Tab** key to select fields.
- 5 Choose the appropriate options for:

LocalEcho	OFF
CapsLock	OFF
SPOW(B)	NO
InhEolWrp(C)	NO
ReturnDef	c r

The screenshot shows a terminal window titled "TERMINAL CONFIGURATION". At the top, there are two empty rectangular input fields. Below these, the screen is divided into several sections. On the left, there are four empty rectangular input fields. In the center, there are four settings: "LocalEcho" with a value of "OFF", "CapsLock" with a value of "OFF", "SPOW (B)" with a value of "NO", and "InhEolWrp (C)" with a value of "NO". To the right of these settings are two empty rectangular input fields. At the bottom, there are several navigation options: "ReturnDef" with a value of "c" and "r" (where "c" is above "r"), and a row of eight buttons labeled [F1] through [F8]. The buttons are: [F1] SAVE CONFIG, [F2] NEXT CHOICE, [F3] PREVIOUS CHOICE, [F4] DEFAULT VALUES, [F5] (empty), [F6] (empty), [F7] DISPLAY FUNCTNS, and [F8] config keys.

Chapter 18: Installation
Configuring Terminals for Use with the Debugger

- 6 Save the configuration by pressing the **SAVE CONFIG** key.

All other terminal configuration options are user-definable.

Note

With bit-mapped displays, you may need to set the function keys to *user* mode by holding down the **shift** key and then pressing the **user** key.

To configure the DEC VT100 terminal

You must configure two menus in order for the VT100 display to work properly: SET-UP A and SET-UP B.

SET-UP A

- 1 Press **SET-UP** to enter the setup menu.
- 2 Press **80/132 COLUMNS** to select 80 columns per line. The columns per line must be set to 80.
- 3 Press **SET-UP** to exit SET-UP A.

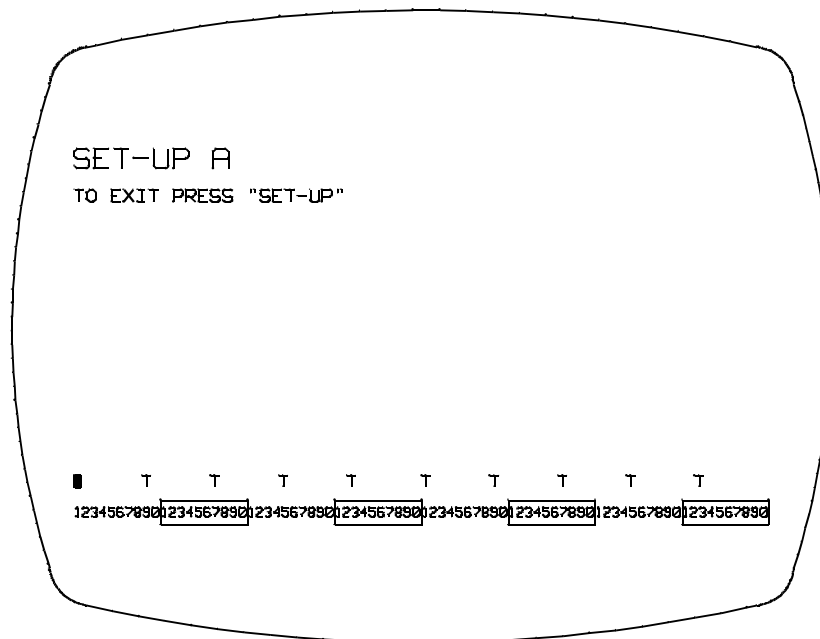

SET-UP B

- 4 Press **SET-UP** to enter the setup menu, then press **SETUP A/B**.

Chapter 18: Installation
Configuring Terminals for Use with the Debugger

- 5 Using the arrow keys, position the cursor at the SET-UP feature to be changed.
- 6 Press **TOGGLE 1/0** to select the feature. Do this for the four features shown below:
- 7 Press **SET-UP** to exit SET-UP B.

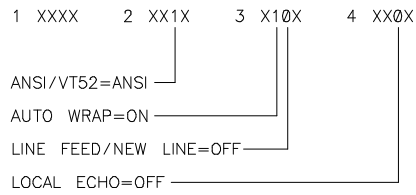

An "X" indicates a user-definable terminal/computer dependency option.

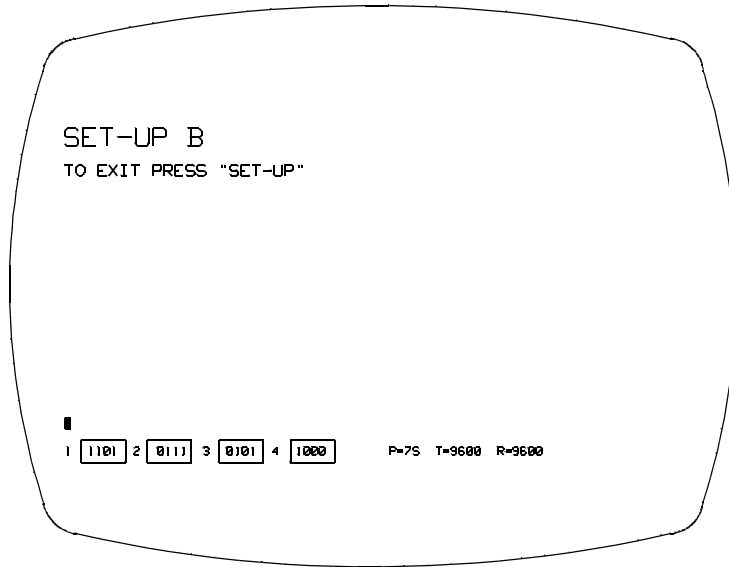

To configure the VT220 terminal

There are three menus that you must set up in order for the VT220 display to work properly:

- Display
- General
- Comm

From the power-on condition, press the **SET-UP** key to move into the initial SET-UP directory.

Note

To change fields within the menus, position the cursor at the desired field and press the **Enter** key.

Follow these steps to set up all three menus:

- 1 Press the **SET-UP** key to enter the setup directories.
- 2 With the cursor at the *Display* field, press the **Enter** key.

Use the arrow keys to move the cursor to the *Columns* field. This must be set for 80 columns. If 80 columns is not the selection displayed, press the **Enter** key.

Position the cursor at the *Auto Wrap* field. This field must be set to *Auto Wrap*.

Position the cursor at the *To Directory* field. Press **Enter**.

- 3 Position the cursor at the *General SET-UP* field. Press **Enter**.

Position the cursor at the *VT200 Mode* field. This field must be set to *VT200 Mode, 7-Bit Controls*.

Position the cursor at the *New Line* field. This field must be set to *No New Line*.

Position the cursor at the *To Directory* field. Press **Enter**.

Chapter 18: Installation
Configuring Terminals for Use with the Debugger

- 4 Position the cursor at the *Comm SET-UP* field. Press **Enter**.

Position the cursor at the *Local Echo* field. This field must be set to *No Local Echo*.

- 5 Position the cursor at the *To Directory* field. Press **Enter**. At this point, if you want to permanently save the selections you have made, position the cursor to the *Save* field and press **Enter**. Otherwise, press **SET-UP** to exit the menus and return to the normal operating mode.

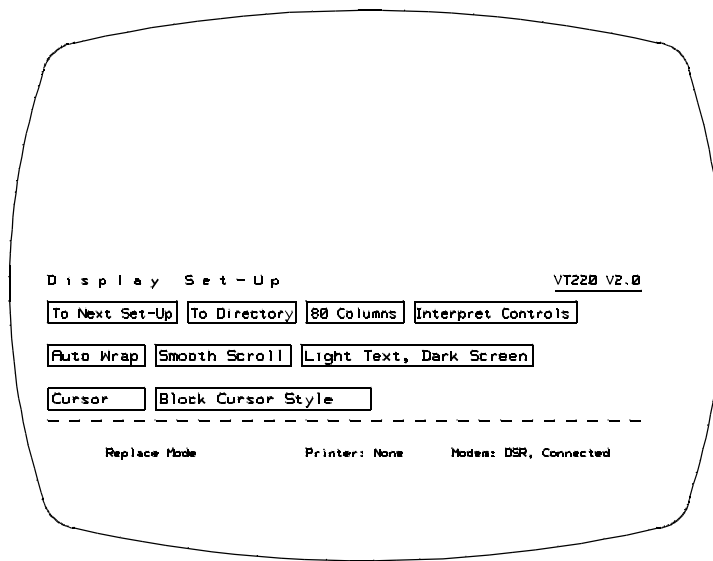

Chapter 18: Installation
Configuring Terminals for Use with the Debugger

General Set-Up VT220 V2.0

Replace Mode Printer: None Modem: ISR, Connected

Communications Set-Up VT220 V2.0

Replace Mode Printer: None

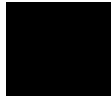

To set the TERM environment variable

- If you are using the *ksh* shell, use the **export** command to set the TERM environment variable.

Or:

- If you are using the *cs* shell, use the **setenv** command to set the TERM environment variable.

Find the appropriate setting for the TERM environment variable in the previous table.

Examples

To set the TERM environment variable for a color bit-mapped display top using the HP 98547A driver card:

```
export TERM=300h
```

To set the TERM environment variable for a HP 2392 terminal:

```
export TERM=2392
```

To define and export the TERM environment variable for the VT220 terminal:

```
export TERM=vt220
export TERMINFO=/usr/hp64000/lib/terminfo
```

To define and export the TERM environment variable for the VT100 terminal:

```
export TERM=vt100a
export TERMINFO=/usr/hp64000/lib/terminfo
```

To set up control sequences

- Configure the stty settings in either /etc/profile or in \$HOME/.profile.

The control characters for most HP applications should be set as follows. If the control characters get changed, you can reset them by typing the commands shown below after you have logged in to the system.

```
stty intr  \^c  (sets intr to CTRL c)
```

```
stty kill  \^u  (sets clear inputline to CTRL u)
```

```
stty quit  \^\\  (sets quit to CTRL \)
```

```
stty eof   \^d   (sets end of file to CTRL d)
```

For the HP terminals and bit-mapped displays:

```
stty erase \^h  (sets erase character to backspace)
```

For the DEC VT100 and VT220 terminals:

```
stty erase \^?  (sets erase character to delete (DEL))
```

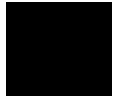

To resize a debugger window in an X-Window larger than 24 lines by 80 columns

The following procedure describes how to resize a debugger window in an X-Window larger than 24 lines by 80 columns.

- 1 Check to see that the *LINES* and *COLUMNS* shell environment variables are correctly set for the window that you are working in so that the debugger knows what the screen limits are. By default, hpterm will set the screen limits correctly when a window is created. However, if you change its size, you should execute the command:

```
eval ` /usr/bin/X11/resize `
```

from your shell. See the man page for `resize(1)` for details about how this works.

To resize a debugger window in a window larger than 24 lines by 80 columns

The following procedure describes how to resize a debugger window in a window larger than 24 lines by 80 columns.

- 1 Check to see that the `stty` settings for *rows* and *columns* are correct for the window that you are working in so that the debugger knows what the screen limits are. Do this by entering the command:

```
stty size
```

The first number given is rows, the second number is columns. By default, the screen limits are set correctly when you change the size of the window. However, if the values for rows and columns are not correct for your window, you can set them by entering the `stty` command from your shell. For example, the command

```
stty rows 40 columns 100
```

will define a window to be 40 rows by 100 columns.

- 2 Start the debugger and load an executable file.

You need an executable in order to move windows in the source-level screen.

- 3 Move the status windows (command line) first. Start with the high-level status window (window number 5). For example, the command:

```
Window New 5 High_Level 46,0,49,79
```

will place the command line at the bottom of a window with 50 rows.

Then move the assembly-level status window (window number 15) to the bottom of the window. For example:

```
Window New 15 Assembly 46,0,49,79
```

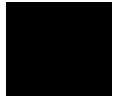

Configuring Terminals for Use with the Debugger

You can edit the previous command to save some typing. Remember the following information when moving the status windows:

- 1 The coordinates start from (0,0) in the upper left.
- 2 The maximum width of the command line is 80.
- 3 The `top_row` and `bottom_row` coordinates must be exactly three apart.
- 4 Move and resize the remainder of the windows by selecting each window and using the `Window Resize` command. Don't forget to resize the alternate view of each window. Use the `Window Toggle_View` command to select the alternate view.
- 5 You may want to set the `View` options of the `Stdio`, `View`, and `Breakpoint` windows to `On` (the windows swap by default). See the command description for the `debugger Option View` command for details.
- 6 Save your changes by executing the `File Startup` command. For example, the command:

```
File Startup YourNameHere
```

will create a startup file named `YourNameHere.rc`. You can then use your custom window configuration by using the `-s YourNameHere` command.

The debugger will also automatically look in `./db68k.rc` for a startup file if you don't want to use the `-s` command line option.

Glossary

absolute file An executable module generated by compiling, assembling, and linking a program. Absolute files must have an extension of .x.

action key User-definable buttons in the graphical interface which allow quick access to often-used commands.

application default file A file containing default X resource specifications for an X Window System application.

background monitor An emulation monitor program that does not execute as part of the user program. See “emulation monitor”.

BBA The Hewlett-Packard Branch Validator. It is a software tool you can use to analyze your testing, create more complete test suites, and measure your level of testing.

breakpoint A location in the program at which execution should stop.

cascade menu A secondary menu that appears when you select an item from a pull-down menu.

click To press and immediately release a mouse button. The term comes from the fact that pressing and releasing the buttons of most mice makes a clicking sound.

command file An ASCII file containing debugger commands.

command line An area at the bottom of the debugger window where commands may be entered using softkeys or pushbuttons. All **standard interface** commands are entered using the command line.

command token The smallest part into which a command may be broken—usually one word. Command tokens appear as pushbuttons on the command line.

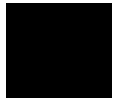

concurrent usage model Describes an interface in which the user can perform most comands at the same time that code is being executed under emulation.

configuration file See “emulator configuration file”.

cooked keyboard I/O mode The I/O mode in which keyboard input is processed. This lets you type and then edit the line to correct errors.

cut buffer A synonym for “entry buffer”.

dialog box Sometimes called a secondary window, the dialog box is called by the user from the application’s main window. A dialog box contains controls or settings, and sometimes prompts for text entry.

display area The part of the debugger window which shows windows containing information such as high-level code and breakpoints.

double-click To press the mouse button twice, quickly.

E/A The Emulator/Analyzer window.

emul700dmn The UNIX background process which coordinates the actions and message traffic of the major emulation interfaces.

emulation memory Memory provided by the emulator to be used in place of target system memory.

emulation monitor A program that is executed by the emulation processor that allows the emulation controller to access target system resources. For example, when you display target system memory locations, the monitor program executes the microprocessor instructions that read the target memory locations and send their contents to the emulation controller. See also “foreground monitor” and “background monitor”.

emulator An instrument that performs just like the microprocessor it replaces, but at the same time, it gives you information about the operation of the processor. An emulator gives you control over target system execution and allows you to view or modify the contents of processor registers, target system memory, and I/O resources.

emulator configuration file A file that contains configuration settings and memory map definitions for the emulator.

entry area A section of the **command line** area where commands are built. When you use menus or softkeys, the actual command which the debugger will execute appears in the entry area.

entry buffer The part of the graphical interface which contains "input" for commands. The symbol for the entry buffer is "()".

foreground monitor An emulation monitor program that executes as part of the user program. See "emulation monitor".

graphical interface The debugger interface program that uses graphics-oriented software such as windows, menus, and icons to make interaction easy.

host shell A UNIX command interpreter.

iconify The act of turning a window into an icon.

journal file A file that contains commands entered during a debug session and any output generated by the debugger. Journal files contain everything that is written to the debugger's journal window.

log file A command file that is created by the debugger when you record commands.

macro A C-like function consisting of debugger commands and C statements and expressions. Macros are most often used to patch C source code, create conditional breakpoints, return values to expressions, or execute a set of commands.

menu bar The row of words at the top of the graphical interface window. Clicking on the menu bar will display a menu of debugger commands.

monitor See "emulation monitor".

patch A small, temporary change to executable code.

PITS cycle Programming In The Small cycle. The repeating process of editing, compiling, and executing code to eliminate bugs.

pointer The symbol on your computer's screen which shows where the mouse is pointing. The pointer may be a hand, an arrow, or another shape.

pop-up menu A menu that pops up when you press and hold the right mouse button. Pop-up menus are available whenever the mouse pointer changes to a "hand-cursor".

predefined macro See also "macro".

pull-down menu A menu that appears to "pull down" from the menu bar at the top of the interface window.

pushbutton A graphic control that simulates a real-life pushbutton. Use the pointer and mouse to push the button and immediately start an action.

raw keyboard I/O mode The I/O mode in which each keystroke produces a character that is sent to the target program that is reading from the keyboard.

recall buffer A text entry field which remembers its previous value.

resource See "X resource".

scheme file A file that contains X resource specifications for a particular group of resources, for example, for a particular type of display, computing environments, or language.

scroll bar A scroll bar is used to move a window so that you can see information beyond the window's edge.

sequential usage model Describes a user interface in which user code execution must be stopped before the interface can perform most commands.

shell See "host shell".

simulated I/O The debugger feature that lets user programs read input from, and write output to, the same keyboard and display (respectively) that are used

to control the debugger. Simulated I/O also lets user programs use the UNIX file system and run UNIX commands.

simulated program interrupt User program interrupts that are simulated by the debugger. Simulated interrupts can be one-time interrupts or periodic interrupts.

simulator A software tool that simulates a microprocessor system for the purpose of debugging user programs.

SPA The HP Software Performance Analyzer.

standard interface The traditional debugger interface designed for use with several types of terminals, terminal emulators, and bitmapped displays. When using the standard interface, commands are entered from the keyboard.

startup file A file that contains information regarding debugger options and screen configurations.

state file A file that contains the CPU state (including register values) and a memory image. This file is saved within a debugger session and can be loaded at a later time to return to a particular state of execution.

status line A line which displays debugger information such as the CPU type, the current module name, and the current debugger operation.

sticky slider A scrollbar slider which is designed for local navigation in a large file. Moving the slider moves the contents of the active window just a few pages at a time.

storage qualifier A bus cycle state description that causes only particular states to be stored in the analyzer trace.

trace A collection of states captured on the emulation bus (in terms of the emulation bus analyzer) or on the analyzer trace signals (in terms of the external analyzer) and stored in trace memory.

trace event A bus state consisting of a combination of address, data, and status values.

Glossary

trigger The captured analyzer state about which other captured states are stored. The trigger state specifies when the trace measurement is taken.

window A window inside the debugger's display area. See also "X window".

working directory The current directory from which the debugger loads and saves files.

X resource A piece of data that controls an element of appearance or behavior in an X application.

X server A program that controls all access to input devices (typically a mouse and a keyboard) and all output devices (typically a display screen). It is an interface between application programs you run on your system and the system input and output devices.

X window A window on your computer's display. The debugger's graphical interface runs inside an X window. See also "window".

Index

() entry buffer, **651**
/dev/simio/display reserved symbol, **170**
/dev/simio/keyboard reserved symbol, **170**
6400tab.net file, **630–631**

- A**
- absolute file, **649**
 - absolute files, **94–95**
 - access breakpoints, using with trace, **181**
 - access size (target memory), **309**
 - action keys, **7, 649**
 - custom, **271**
 - operation, **68**
 - with command files, **271**
 - with entry buffer, **67–68**
 - activating windows, **14**
 - active window
 - changing, **137**
 - description of, **137**
 - displaying the alternate view of, **138**
 - viewing information in, **139–140**
 - add bit-mapped displays to HP-UX, **634**
 - add configured terminals to HP-UX, **634**
 - add symbol, **126**
 - adding an emulator, **630–631**
 - address operator, **29, 47**
 - address registers @A0-A7, **551**
 - addresses, **531–532**
 - assembly level code, **531**
 - code, **531**
 - data, **531**
 - displaying variable, **29, 47**
 - logical, **473–474**
 - physical, **473–474**
 - ranges, **531**
 - trace specification, **485**

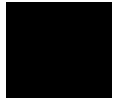

- alignment
 - tracing instructions, **391**
- alternate view of a window, **138**
- analysis breakpoints, **104**
- ANSI keypad functions, **635**
- app-defaults directory
 - HP 9000 computers, **336**
 - Sun SPARCsystem computers, **336**
- append programs, **96**
- application default file, **649**
- application resource
 - See X resource*
- arguments for macros, **215**
- Asleep (debugger status), **86**
- assembly code
 - in source display, **247**
- assembly level code addresses, **531**
- assembly-level screen
 - description of, **131**
 - displaying, **132**
 - moving status window, **256**
- AwtRst (debugger status), **86**
- B**
 - background
 - tracing, **313**
 - background monitor, **649**
 - background process, **42**
 - backtrace window
 - backtrace information, **151**
 - description of, **150–152**
 - display bad stack frames, **243**
 - frame status characters, **150**
 - function name, **151**
 - function nesting level, **150**
 - halting at stack level, **114**
 - module name, **151**
 - batch mode option, **237**
 - BBA
 - See Branch Validator*
 - bindings, mouse, **9–11**
 - bit-mapped displays, **635**

- bit-mapped HP displays
 - configuring, **637**
 - set control sequences for, **645**
- blocks
 - comparing, **208**
 - copying, **207**
 - filling, **208**
- blocks (emulation memory)
 - size of, **292**
- Branch Validator, **123, 649**
- break on access to a variable, **30, 48**
- break_info macro, **556–557**
- breakpoint window
 - address field, **112**
 - command argument, **113**
 - description of, **111**
 - line number field, **112**
 - module/function field, **112**
 - number field (#), **112**
 - type field, **113**
- breakpoints
 - analysis, **104**
 - automatic alignment, **242**
 - breaks on write to ROM, **308**
 - C++ , **108–109**
 - checking definitions of, **111**
 - clearing, **109**
 - commands, summary of, **351**
 - controlling program execution with, **104–114**
 - definition, **649**
 - deleting, **23, 109**
 - hardware, **104**
 - removing, **109–110**
 - setting, **20**
 - software, **107**
 - target ROM, **103**
 - use macros with, **224**
- Breakpt Access command, **356–357**
- Breakpt Clear_All command, **358**
- Breakpt Delete command, **359**
- Breakpt Force_HW command, **360**



- Breakpt Instr command, **361–362**
- Breakpt Read command, **363**
- Breakpt Write command, **364**
- bus width, **391**
- BusGrnt (debugger status), **86**
- button names, **9–11**
- byte macro, **558**
- bytes
 - changing, **206**
- C**
 - C compiler
 - installation, **617**
 - C operators, **521**
 - C source code
 - displaying, **142**
 - C++
 - breakpoints, **108–109, 361**
 - browse command, **161, 464**
 - classes, **464, 534**
 - displaying class members, **158**
 - displaying member values, **158**
 - functions, **108–109, 142**
 - inheritance, **464**
 - object instance, **108**
 - objects, **158**
 - operators, **522**
 - overloaded functions, **108, 361**
 - protection, **158**
 - this pointer, **154**
 - cache control register @CACR, **551**
 - calling a macro, **213**
 - carry flag @C, **551**
 - cascade menu, **649**
 - casting, special, **540**
 - changing
 - active window, **137**
 - directory context in configuration window, **281**
 - characterization of memory, **294**
 - characters
 - constants, **526**
 - non-printable, **526**
 - string constants, **526**

check breakpoint definitions, **111**
check simulated I/O resource usage, **174**
class name
 X applications, **335**
 X resource, **333**
classes (C++)
 displaying members of, **158**
clear breakpoints, **109–110**
click, **651**
client, X, **263, 332**
close macro, **559**
CMBWait (debugger status), **86**
cmd_forward macro, **560–561**
code addresses, **531**
code patching
 deleting C source lines from your program, **204–205**
 inserting lines of C code into your program, **204**
 patching a line, **203**
color scheme, **265, 269, 339**
column numbers, **530**
ComFile (debugger status), **85**
Command (debugger status), **85**
command files
 command-line option, **232, 237**
 comments in, **231**
 definition, **649**
 description of, **229–238**
 echoing commands, **242**
 logging commands to, start, **230**
 logging commands to, stop, **232**
 playback, **232**
 startup, **419**
command language
 address ranges, **531**
 addresses, **531–532**
 assembly level code addresses, **531**
 C operators, **521**
 C++ operators, **522**
 character constants, **526**
 character string constants, **526**
 code addresses, **531**

command language (continued)
 constants, **523**
 data addresses, **531**
 data types, **537**
 debugger operators, **522**
 debugger symbols, **529**
 description, **519–548**
 evaluating symbols, **545**
 explicit stack references, **547**
 expression elements, **521–527**
 expression strings, **535**
 floating point constants, **525**
 forming expressions, **534**
 global (extern) storage classes, **536**
 hexadecimal constants, **524**
 identical module names, **542**
 identifiers, **528**
 implicit stack references, **546**
 integer constants, **524**
 keywords, **533**
 legal characters allowed in symbols, **528**
 line numbers, **530**
 local storage classes, **537**
 macro local symbols, **529**
 macro names, **529**
 macro symbol types, **529**
 macro symbols, **529**
 module names, **543**
 non-printable characters, **526**
 operators, **521**
 program symbols, **528**
 referencing symbols, **541**
 register storage classes, **537**
 reserved symbols, **530**
 root names, **541**
 scoping rules, **541**
 special casting, **540**
 stack references, **546**
 static storage classes, **536**
 storage classes, **536**
 symbol length, **528**

- command language (continued)
 - symbolic referencing, **536–548**
 - symbolic referencing with explicit roots, **543**
 - symbolic referencing without explicit roots, + , **545**
 - symbols, **528–530**
 - type casting, **539**
 - type conversion, **539**
- command line, **7, 649**
 - command line recall operation, **82**
 - Command Recall dialog box, operation, **78**
 - copy-and-paste to from entry buffer, **67**
 - displaying, **31**
 - editing entry area with keyboard, **82**
 - editing entry area with pop-up menu, **78**
 - editing entry area with pushbuttons, **77**
 - entering commands, **76**
 - entry area, **651**
 - executing commands, **76**
 - help, **79**
 - recalling commands with command line recall, **82**
 - recalling commands with dialog box, **78**
 - turning on or off, **75, 266**
 - with keyboard, **80–84**
- Command Recall dialog box operation, **69**
- command select button, **9–10**
- command tokens, description, **649**
- command tokens, description of, **80**
- commands
 - editing in command line entry area, **77–78, 82**
 - entering, **55, 57–88**
 - entering from keyboard, **80**
 - entering in command line, **76**
 - executing in command line, **76**
 - function key, **57**
 - logging to command file, start, **230**
 - logging to command file, stop, **232**
 - playback from command file, **232**
 - recalling with command line recall, **82**
 - recalling with dialog box, **78**
- comments in macros, **214**

communication between interfaces, **560**
compare blocks of memory, **208**
compile programs for the debugger, **90–92**
compiler h option, effects of, **90**
concurrent usage model, **650**
condition codes register @CCR, **551**
configuration (emulator)
 background states, tracing, **313**
 breaks on writes to ROM, **308**
configuration context
 displaying from configuration window, **282**
configuration file, **650**
configuration, debugger, **239–272**
configuration, emulator
 exiting the interface, **283**
 loading from file, **284**
 modifying a section, **278**
 starting the interface, **276**
 storing, **280**
configuration, terminals
 See terminals
configured terminals, adding to HP-UX, **636**
constants, **523**
 character, **526**
 character string, **526**
 floating point, **525**
 hexadecimal, **524**
 integer, **524**
context
 changing directory in configuration window, **281**
 displaying directory from configuration window, **282**
control blocking of reads, **172**
control character functions
 list of, **58**
 using, **58**
control program execution with breakpoints, **104–114**
control sequences for HP terminals, setting up, **645**
cooked mode, **650**
coprocessors
 support of, **145**
copy block of memory, **207**

- copy demonstration files, **41**
- copy macros, **218**
- copy window, **141**
- copy-and-paste
 - addresses, **65**
 - from entry buffer, **67**
 - multi-window, **65, 68**
 - symbol width, **65**
 - to entry buffer, **64**
- CPU root pointer @CRP, **552**
- current working directory, displaying, **148**
- cursor keys
 - descriptions, **139**
 - End (Shift_Home) Key Functions, **140**
 - Home Key Functions, **140**
- cut buffer
 - See* entry buffer
- D**
 - data addresses, **531**
 - data registers @D0-D7, **551**
 - data types, **537**
 - db68k options
 - b batch mode, **237**
 - c command file, **232, 237**
 - d demand loading of symbols, **97–98**
 - I load only symbolic information, **96**
 - j journal file, **234**
 - l log commands, **230**
 - s startup_file, **261**
 - debugger commands, summary of, **351**
 - Debugger Directory command, **365**
 - Debugger Execution Display_Status command, **366**
 - Debugger Execution Environment FwdCmd command, **367**
 - Debugger Execution Environment Load_Config command, **368**
 - Debugger Execution Environment Modify_Config command, **369**
 - Debugger Execution IO_System command, **370–372**
 - Debugger Execution Load_State command, **373**
 - Debugger Execution Reset_Processor command, **374**
 - Debugger Help command, **377**
 - Debugger Host_Shell command, **375–376**
 - Debugger Level command, **378**
 - Debugger Macro Add command, **379–381**

Debugger Macro Call command, **382**
Debugger Macro Display command, **383**
debugger macros
 See macros
debugger operators
 See operators
Debugger Option Command_Echo command, **384**
Debugger Option General command, **385–387**
Debugger Option List command, **388**
Debugger Option Symbolics command, **389–390**
Debugger Option Trace command, **391**
Debugger Option View command, **392–394**
debugger options dialog box, **241**
Debugger Pause command, **395**
Debugger Quit command, **396–397**
debugger symbols
 See symbols
DEC terminals, configuring, **633**
decimal, **244**
default trace specification, **179**
define macros, **218–220**
 interactively, **218–219**
 See macros
define user screens and windows, **256**
delete breakpoints, **110**
delete C source lines from your program, **204–205**
delete macros, **228**
delete symbol, **128–131**
delete trace events, **188**
deleting breakpoints
 See breakpoints, deleting
demand loading symbols, **97–98**
demonstration program description, **11, 40**
destination function code @DFC, **551**
dialog boxes
 Command Recall, operation, **69, 78**
 debugger options, **241**
 definition, **650**
 Directory Selection, operation, **69, 72**
 Entry Buffer Recall, operation, **66, 69**
 File Selection, operation, **69, 71**

- dialog boxes (continued)
 - how to use, **69**
 - macro operations, **217**
- directories
 - displaying current directory, **148**
- directory context
 - changing in configuration window, **281**
 - displaying from configuration window, **282**
- Directory Selection dialog box operation, **69, 72**
- disable simulated I/O, **170**
- disassembly
 - automatic alignment, **242**
- display area, **7, 650**
 - lines, **267**
- display area windows
 - See windows
- displaying
 - See the name of what you want to display in this index
- displays
 - bit-mapped, **635**
 - configuring HP bit-mapped, **637**
 - setting up HP bit-mapped, **645**
- do statement, **216**
- double-click, **650**
- dword macro, **562**
- E**
 - E/A, **650**
 - editing
 - command line entry area with keyboard, **82**
 - command line entry area with pop-up menu, **78**
 - command line entry area with pushbuttons, **77**
 - copying memory, **207**
 - file, **266**
 - file at address, **201, 266**
 - file at program counter, **201**
 - files, **200–201**
 - macros, **220**
 - memory contents, **206**
 - else statement, **216**
 - emul700dmn, **650**
 - emulation memory, **650**
 - block size, **292**

- emulation monitor, **650**
- emulator, **121, 650**
 - adding, **630**
 - configuring the, **274**
 - installing, **625**
 - version requirement, **617**
- emulator configuration
 - break processor on write to ROM, **308**
 - exiting the configuration interface, **283**
 - loading from file, **284**
 - modifying a configuration section, **278**
 - starting the configuration interface, **276**
 - storing, **280**
 - target memory access size, **309**
 - trace background/foreground operation, **313**
- emulator/analyzer interface, **121**
- enable simulated I/O, **170**
- End (Shift_Home) Key Functions, **140**
- end debugging session, **35–36, 51–52**
- entering debugger commands, **55, 57–88**
 - from the keyboard, **80**
- entries (X resource), **272**
- entry area (command line), **651**
- entry buffer, **7, 651**
 - address copy-and-paste to, **65**
 - clearing, **64**
 - copy-and-paste from, **67**
 - copy-and-paste to, **64**
 - editing, **67**
 - Entry Buffer Value Selection dialog box, operation, **66**
 - multi-window copy-and-paste from, **68**
 - multi-window copy-and-paste to, **65**
 - operation, **67**
 - recalling entries, **66**
 - setting initial value, **272**
 - symbol width and copy-and-paste to, **65**
 - text entry, **64**
 - with action keys, **67–68**
 - with pull-down menus, **67**
- Entry Buffer Recall dialog box operation, **69**
- environment dependent files, **90**

- environment variables
 - HP64_DEBUG_PATH, **93**
 - TERM, setting, **644**
 - eram, memory characterization, **294**
 - erase information in window, **258**
 - erom, memory characterization, **294**
 - error macro, **563**
 - error window, description of, **592**
 - evaluating symbols, **545**
 - Execute (debugger status), **85**
 - executing UNIX commands from within the debugger, **120**
 - execution
 - controlling, **99–103**
 - run from current program counter address, **101**
 - run from start address, **101**
 - run until stop address, **102**
 - exiting the debugger, **35–36**
 - explicit stack references, **547**
 - Expression C_Expression command, **398**
 - modifying variables with, **50**
 - using, **50**
 - Expression Display_Value command, **399–401**
 - Expression Fprintf command, **402–406**
 - Expression Monitor Clear_all command, **407**
 - Expression Monitor Delete command, **408**
 - Expression Monitor Value command, **409–411**
 - using, **50**
 - Expression Printf command, **412–413**
 - expressions
 - changing C variables, **202**
 - commands, summary of, **352**
 - elements, **521–527**
 - forming, **534**
 - strings, **535**
 - extend flag @X, **552**
- F**
- fgetc macro, **564**
 - file
 - emulator configuration, **280**
 - emulator configuration load, **284**
 - File Command command, **414**
 - File Error_Command command, **415**

file extensions
 .EA and .EB, configuration files, **281**
File Journal command, **416**
File Log command, **417–418**
File Selection dialog box operation, **69, 71**
File Startup command, **419–420**
File User_Fopen command, **421–422**
File Window_Close command, **423**
files
 6400tab.net, **630–631**
 absolute, **94–95**
 appending, **96**
 command, **229–238**
 See also command file
 commands, summary of, **352**
 copying demonstration, **41**
 editing, **200–201**
 editing at address, **201**
 editing at program counter, **201**
 environment dependent, **90**
 journal, **234**
 log, **230**
 logging commands to, start, **230**
 logging commands to, stop, **232**
 macro, **221**
 playback command file, **232**
 saving window contents, **141**
 source file location, **93**
 startup, **260–262, 419–420**
 state, **117–118**
fill block of memory, **208**
floating point constants, **525**
fopen macro, **565**
foreground monitor, **651**
 limitations to trace, **182**
 mapping it for use with MC68040 MMU, **322–328**
 tracing its execution, **313**
fork a UNIX shell, **119**
forming expressions, **534**
FPU support, **145**
frame status character, **150**

- function codes
 - mapping memory, **300**
- function keys, **57**
 - DEC terminal, **636**
 - list of, **57**
- functions
 - breaking on call, **20**
 - displaying, **17, 44**
 - stepping over, **26, 100**
- G**
 - graphical interface, C compiler installation, **617**
 - guarded memory accesses, **294**
- H**
 - half-bright video, **251**
 - Halted (debugger status), **86**
 - halting program execution
 - on access to a specified memory location, **104**
 - on instruction at a specified memory location, **106**
 - hand pointer, **63**
 - hardware
 - breakpoints, **104**
 - HP 9000 memory needs, **618**
 - HP 9000 minimum performance, **618**
 - HP 9000 system requirements, **618**
 - locking emulator, **396**
 - SPARCsystem memory needs, **622**
 - SPARCsystem minimum performance, **622**
 - SPARCsystem minimums overview, **622**
 - help
 - command line, **79**
 - help index, **73**
 - to use, **34**
 - window, **83**
 - hexadecimal
 - changing default radix, **244**
 - constants, **524**
 - effects of radix, **244, 387, 610**
 - high-level program counter @HLPC, **551**
 - high-level screen
 - description of, **130**
 - displaying, **132**
 - moving status window, **256**

highlighting, setting, **251**
Home Key Functions, **140**
Host_Shell command, **119**
hot keys
 See action keys
HP 9000
 700 series Motif libraries, **618**
 HP-UX minimum version, **618**
 system requirements, **618**
HP-UX
 minimum version, **618**
HP64_DEBUG_PATH file search path, **93**

I iconify, **651**
identifier, **528**
if statement, **216**
implicit stack references, **546**
increase simulated I/O file resources, **174–176**
indicator characters, **87**
initialized variables
 re-initializing, **209**
InMon (debugger status), **86**
input scheme, **265, 339**
insert lines of C code into your program, **204**
installation
 at a glance, **616–617**
 emulator, **625**
 SPARCsystem specific instructions, **622–624**
instance name
 X applications, **335**
 X resource, **333**
instruction alignment, **391**
integer constants, **524**
interface, emulator configuration
 exiting, **283**
 modifying a section, **278**
 starting, **276**
interfaces
 emulator/analyzer, **121**
interrupt mask @I, **551**
interrupt stack pointer @ISP, **551**
inverse video, **251**

- J** J indicator character, **87**
journal files, **234**
 definition, **651**
 for journal window, **162**
 -j option, **234**
 name of current journal file, **148**
journal window, description of, **58**
- K** key_get macro, **566**
key_stat macro, **567**
keyboard
 choosing menu items, **62**
 key names, **10–11**
keyboard I/O
 control blocking, **172**
 cooked mode, **171**
 raw mode, **171**
 setting mode, **171**
 simulated I/O processing, **171**
keywords, **533**
- L** L indicator character, **87**
label scheme, **265, 269, 339**
LANG environment variable, **339**
level, stack, **114**
libraries
 Motif for HP 9000/700, **618**
line numbers, **530**
lines in main display area, **267**
literals
 radix, **244**
load additional programs, **96**
load programs, **94–95**
 using the db68k command, **94**
 using the program load command, **94**
load symbols, **96**
loading and executing programs, **89, 91–124**
locking mechanism, emulation, **396**
log files, **230**
 definition, **651**
 for log file window, **162**
 name of current log file, **148**

logging
-l option, **230**
commands to command file, start, **230**
commands to command file, stop, **232**

M Macro (debugger status), **85**
macros, **211–238**
arguments, **215**
calling, **213**
calling from an expression, **223**
calling from within macros, **223**
calling on execution of a breakpoint, **224**
calling with debugger macro call command, **222**
calling with Program Step With_Macro command, **226**
comments, **214**
control flow statements, **216**
copying, **218**
debugger commands in, **216**
defining, **214, 217–220**
defining interactively, **217–219**
defining outside the debugger, **220**
definition, **651**
deleting, **228**
dialog box, **217**
displaying source code of, **227**
do statement, **216**
editing, **220**
else statement, **216**
example of 'when', **357, 362–364**
if statement, **216**
limits, **214**
loading, **221**
local symbols, **529**
maximum number of lines in a macro, **380**
names, **529**
parameter checking, **247**
patching C source with, **203–205**
predefined, **553, 555–590**
properties of, **213**
renaming, **218**
return statement, **216**
return values, **216**

- macros (continued)
 - saving, **214, 221**
 - simulated I/O, **554**
 - stopping execution, **227**
 - symbol types, **529**
 - symbols, **529**
 - templates, **218**
 - using with breakpoints, **224**
 - variables, **215**
 - while statement, **216**
- main(), displaying, **15**
- make windows active, **137**
- making trace measurements, **177–198**
- mapping memory, **292–301**
- master stack pointer @MSP, **551**
- master/interrupt flag @M, **551**
- memchr macro, **568**
- memclr macro, **569**
- memcpy macro, **570**
- memory
 - changing, **206**
 - characterization of, **294**
 - commands, summary of, **353**
 - comparing, **208**
 - copying, **207**
 - displaying blocks, **49**
 - filling, **208**
 - mapping, **292–301**
 - See also* memory map
 - re-assignment of emulation memory blocks in mapper, **299**
- Memory Assign command, **424–425**
- Memory Block_Operation Copy command, **426**
- Memory Block_Operation Fill command, **427–428**
- Memory Block_Operation Match command, **429–430**
- Memory Block_Operation Search command, **431–432**
- Memory Block_Operation Test command, **433–434**
- Memory Display command, **435–436**
- memory mapping
 - block size, **292**
 - including transfer cache inhibit in a range, **300**
 - resolution, **292**

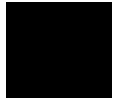

Memory MMU command, **437**
memory recommendations
 HP 9000, **618**
 SPARCsystem, **622**
Memory Register command, **438–439**
Memory Unload_BBA command, **440–442**
memset macro, **571**
menu bar, **651**
menus, **60–73**
 editing command line with pop-up, **78**
 hand pointer means pop-up, **63**
 pull-down operation with keyboard, **62**
 pull-down operation with mouse, **60–61**
middle button, **9**
MMU, **473–474**
 displaying translations, **437**
 mapping 1:1 for use with MC68040, **322–328**
 Status Register @MMUSR, **551**
MMU mapping tables modified for map monitor, **324**
modify registers, **209–210**
modify variables, **50**
module names, **543**
module names, identical, **542**
monitor
 to map 1:1 for use with MC68040 MMU, **322–328**
monitor variables, **50**
monitor window, description of, **159**
more display, **251**
More prompt, **140**
Motif
 HP 9000/700 requirements, **618**
mouse
 button names, **9**
 choosing menu items, **60–61**
mouse button names, **10–11**
move assembly-level status window, **256**
move high-level status window, **256**
move status window, **255**
multi-statement debugging, **530**

- multi-window
 - copy-and-paste from entry buffer, **68**
 - copy-and-paste to entry buffer, **65**
- N**
 - names of modules, identical, **542**
 - negative flag @N, **551**
 - next screen, displaying, **133–136**
 - non-printable characters, **526**
 - notes
 - re-assignment of emulation memory blocks by mapper, **299**
 - NotRdy (debugger status), **86**
- O**
 - objects (C++)
 - displaying member values, **158**
 - open macro, **572–573**
 - operating system
 - HP-UX minimum version, **618**
 - SunOS minimum version, **622**
 - operators
 - C, **521**
 - C++ , **522**
 - debugger, **522**
 - optimizing modes
 - effects of, **91**
 - using, **91**
 - options, **240**
 - radix, **244, 387, 610**
 - saving, **419–420**
 - overflow flag @V, **552**
 - overloaded C++ functions, **108, 142**
- P**
 - paging (screen), **251**
 - parameters
 - checking, **247**
 - patch
 - See also* code patching
 - definition, **651**
 - Paused (debugger status), **85**
 - PC register, **121**
 - PITS cycle, **652**



platform
 differences, **10–11**
 HP 9000 memory needs, **618**
 HP 9000 minimum performance, **618**
 SPARCsystem memory needs, **622**
 SPARCsystem minimum performance, **622**
platform scheme, **265, 340**
playback
 command file, **232**
pod_command macro, **574–575**
pointer, **652**
pointer to current function @FUNCTION, **551**
pointer to current module @MODULE, **551**
pop-up menus
 command line editing with, **78**
 definition, **652**
 hand pointer indicates presence, **63**
 shortcuts, **64**
 using, **63**
predefined macros, **553, 555–590**
 break_info, **556–557**
 byte, **558**
 close, **559**
 cmd_forward, **560–561**
 dword, **562**
 error, **563**
 fgetc, **564**
 fopen, **565**
 key_get, **566**
 key_stat, **567**
 memchr, **568**
 memclr, **569**
 memcpy, **570**
 memset, **571**
 open, **572–573**
 pod_command, **574–575**
 read, **576**
 reg_str, **577**
 showversion, **578**
 strcat, **579**

predefined macros (continued)
 strchr, **580**
 strcmp, **581**
 strcpy, **582**
 stricmp, **583**
 strlen, **584**
 strncmp, **585**
 until, **586**
 when, **587**
 word, **588**
 write, **589–590**

predefined windows, **135**

printf
 using in debugger, **31**

processor
 resetting, **115**

processor chip id. number @CHIP, **551**

product version, displaying, **148**

program commands, summary of, **353**

Program Context Display command, **443**

Program Context Expand command, **444**

Program Context Set command, **445**

program counter
 @PC symbol, **551**
 resetting, **115**
 run from current address, **101**

Program Display_Source command
 description, **446**

program execution
 controlling, **99–103**
 halt on access to a specified memory location, **104**
 halt on an instruction at a specified memory location, **106**

Program Find_Source Next command, **447**

Program Find_Source Occurrence command, **448–449**

Program Load command, **450–451**

Program Pc_Reset command, **452**

Program Run command, **453–455**

Program Step command, **456–457**

Program Step Over command, **46, 458–459**

Program Step With_Macro command, **460**

program stepping, **25, 46**

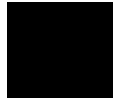

- program symbols
 - See* symbols
 - program variables, resetting, **116**
 - programs
 - loading, **94–95**
 - loading using the db68k command, **94**
 - loading using the program load command, **94**
 - restarting, **115–116**
 - run from a specified address, **101**
 - run from the current program counter address, **101**
 - run until a specified stop address, **102**
 - running, **99–103**
 - step through, **99**
 - pull-down menus
 - choosing with keyboard, **62**
 - choosing with mouse, **60–61**
 - definition, **652**
 - pushbutton, **652**
- Q**
- quick start, **37–52**
 - graphical interface, **3–36**
 - quitting the debugger, **35–36**
- R**
- R indicator character, **87**
 - radix
 - selecting, **244**
 - radix option, **244, 387, 610**
 - RAM, mapping emulation or target, **294**
 - raw mode, **652**
 - re-initialize variables, **209**
 - read macro, **576**
 - Reading (debugger status), **86**
 - recall buffer, **652**
 - initial content, **272**
 - recalling
 - commands with command line recall, **82**
 - commands with dialog box, **78**
 - entry buffer entries, **66**
 - redirect I/O, **172–173**
 - referencing symbols, **541**
 - reformat screens, **254**
 - reg_str macro, **577**

register window, description of, **148**

registers

- changing, **209–210**
- list of, **149**
- modifying, **121**
- monitoring, **160**
- names of, **549–552**
- viewing, **148**

release_system, end command option, **280**

remote control of interfaces, **560**

remove breakpoints, **109–110**

remove user-defined screens and windows, **258**

reserved symbols, **530, 549–552**

- /dev/simio/display, **170**
- /dev/simio/keyboard, **170**
- simulated I/O, **169**
- stderr, **170**
- stdin, **169**
- stdout, **170**

Reset (debugger status), **86**

reset processor, **115**

reset program counter, **115**

reset program variables, **116**

resize

- windows, **254**
- windows larger than 24 by 80, **647**
- X windows larger than 24 by 80, **646**

resolution, memory mapper, **292**

resource

- See* X resources

restart programs, **115–116**

return statement, **216**

return values in macros, **216**

ROM

- mapping emulation or target, **294**
- writes to, **294**

root names, **541**

root symbol, **542**

RS-232 terminals, **634**

run
 from current program counter address, **101**
 from start address, **101**
 programs, **99–103**
 until stop address, **102**

S save file
 See state files
save window and screen settings, **260**
scheme files, **264, 652**
scheme files (for X resources), **337–338**
 color scheme, **265, 269, 339**
 custom, **269, 339**
 input scheme, **265, 339**
 label scheme, **265, 269, 339**
 platform scheme, **265, 340**
 size scheme, **265, 339**
scoping rules, **541**
screens, **130**
 saving settings, **260**
 assembly-level, **131**
 displaying, **130**
 displaying next, **133–136**
 high-level, **130**
 high-level, displaying, **132**
 predefined, **130**
 reformatting, **254**
 standard I/O, **131**
 user-defined, displaying, **257**
 working with, **130**
scroll bar, **7, 16, 652**
scrolling, **16**
 "more" mode, **140**
 setting amount of, **252**
 sticky slider definition, **653**
sequential usage model, **652**
server, X, **263, 332, 654**
session control commands, summary of, **351**
setting
 keyboard I/O mode to raw or cooked, **171**
 setting up control sequences for terminals, **645**

settings, **240**
 See also options
 saving, **419–420**

shell, **651**
 forking, **119**

showversion macro, **578**

simulated I/O, **274, 652**
 check resource usage, **174**
 communication with the debugger, **168**
 connections to host system, **168**
 control address buffers, **167**
 description of, **167**
 disabling, **170**
 display, **168**
 enabling, **170**
 how it works, **167**
 increase file resource, **174–176**
 keyboard, **168**
 keyboard I/O, **171**
 keyboard I/O processing, **171**
 macros, **554**
 processing, **168**
 redirecting I/O, **172–173**
 reserved symbols, **169**
 special symbols, **169**
 stderr, **172–173**
 stdin, **172–173**
 stdout, **172–173**
 UNIX Files, **168**
 UNIX processes, **169**
 user program symbols, **169**
 using, **167**

simulator, **653**
 using with debugger/emulator, **122**

size scheme, **265, 339**

skid, **356**

skipping functions, **26**

slider, sticky, **653**
 See also scrolling

SlowBus (debugger status), **86**

SlowClk (debugger status), **86**

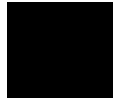

- software
 - installation for SPARCsystems, **622–624**
- software breakpoints, **107**
- source code
 - displaying, **142**
 - in assembly display, **247**
 - location of files, **93**
 - patching, **202**
- source function code @SFC, **551**
- SPA, **653**
- SPARCsystems
 - installing software, **622–624**
 - minimum system requirements overview, **622**
 - SunOS minimum version, **622**
- special casting, **540**
- special symbols, simulated I/O, **169**
- specify source file location, **93**
- specify trace events, **187**
- speed setting (step), **245**
- stack
 - displaying bad frames, **243**
 - explicit references, **547**
 - halting at stack level, **114**
 - implicit references, **546**
 - pointer @SP, **551**
 - window, description of, **136**
- standard I/O screen
 - description of, **131**
 - displaying, **133**
 - erasing information, **258**
- standard interface
 - command summary, **346**
 - definition, **653**
 - installation, **617, 623**
 - introduction, **37–52**
- start address, run from, **101**
- starting
 - debugger, **13, 42, 59**
 - logging commands to command file, **230**
 - trace, **184**

startup files, **260–262**
 definition, **653**
 loading, **261**
 name of, **148**
 -s option, **261**

state files, **117–118, 653**

status
 entry on status line, **85**
 moving status window, **255**
 status line, **7, 85–88, 653**

status register @SR, **551**

stderr reserved symbol, **170**

stdin reserved symbol, **169**

stdio
 See standard I/O
 See also stdin, stdout

stdout reserved symbol, **170**

step over functions, **26, 46, 100**

step speed, setting, **245**

step through a program, **99**

stepping, **25, 46**

sticky slider, **653**
 See also scrolling

stop address, run from, **102**

stopping
 logging commands to command file, **232**
 trace, **185**

stopping
 debugger, **35–36**

storage classes
 automatic, **537**
 global (extern), **536**
 local, **537**
 register, **537**
 static, **536**

storage qualification
 qualifier, definition of, **653**
 specifying qualifiers, **188–189**
 trace measurement, **180**

strcat macro, **579**



- strchr macro, **580**
- strcmp macro, **581**
- strcpy macro, **582**
- stricmp macro, **583**
- strlen macro, **584**
- strncmp macro, **585**
- structures
 - displaying members, **157**
- subroutines
 - See* functions
- subwindows
 - activating, **14**
- SunOS
 - minimum version, **622**
- supervisor stack pointer @SSP, **552**
- supervisor state flag @S, **551**
- supported terminals, **633**
- switching
 - between high-level and assembly-level screens, **132**
 - directory context in configuration window, **281**
- Symbol Add command, **461–463**
- Symbol Browse command, **464**
- Symbol Display command, **465–469**
- Symbol Remove command, **470–471**
- symbolic information only option, **96**
- symbolic referencing, **536–548**
 - with explicit roots, **543**
 - without explicit roots, **545**
- symbols
 - assembly code, **246**
 - commands, summary of, **354**
 - debugger, **126, 529**
 - demand loading, **97–98, 244**
 - displaying, **127**
 - evaluating, **545**
 - evaluation, examples of, **546**
 - keywords, **533**
 - legal characters, **528**
 - line numbers, **530**
 - loading, **96**
 - length, **528**

symbols (continued)
 macro, **529**
 on demand, **528**
 program, **126, 528**
 referencing, **541**
 reserved, **530**
 types of, **126**
system requirements
 HP 9000 overview, **618**
 HP-UX minimum version, **618**
 OSF/Motif HP 9000/700 requirements, **618**
 SPARCsystem overview, **622**
 SunOS minimum version, **622**

T table walk, **437**
target memory
 access size, **309**
target program
 control of emulator interfaces, **560**
target system
 RAM and ROM, **294**
TargRst (debugger status), **87**
template
 macro, **218**
TERM environment variable
 description of, **633**
 setting, **644**
terminals
 adding configured terminals to HP-UX, **634**
 configuring, **633–648**
 DEC, **633**
 HP, **637, 645**
 RS-232, **634**
 settings table, **634**
 supported, **633**
 TERM settings for, **634**
 VT100, **639**
 VT102, **645**
 VT220, **641, 645**
token, **649**



- trace
 - See* trace measurement
 - trace 0 flag @T0, **552**
 - trace 1 flag @T1, **552**
 - Trace deMMUer command, **473–474**
 - Trace Display command, **475–480**
 - Trace Event Clear_All command, **481**
 - Trace Event Delete command, **482**
 - Trace Event List command, **483**
 - Trace Event Specify command, **484–487**
 - Trace Event Used_List command, **488**
 - trace events, **179**
 - address values, **179**
 - data values, **179**
 - definition, **653**
 - delete, **188**
 - specify, **187**
 - status values, **179**
 - Trace Halt command, **489**
 - trace measurement, **177–198, 653**
 - access breakpoints, **181**
 - address and data values, **179**
 - breakpoint interaction, **357**
 - bus width, **391**
 - commands, summary of, **354**
 - complex breakpoint, **196**
 - default, **179**
 - delete trace events, **188**
 - disable storage qualifiers, **192**
 - disable triggers, **192**
 - display a trace, **186**
 - fetch mask, **253**
 - foreground monitor limitations, **182**
 - halt program on occurrence of trigger, **191**
 - limitations, **182**
 - limitations when triggering on C variables, **182**
 - limitations when triggering on instruction fetches, **183**
 - remove storage qualifiers, **192**
 - remove triggers, **192**
 - resources, **180**

- trace measurement (continued)
 - specify storage qualifiers, **188–189**
 - specify trace events, **187**
 - start a trace, **184**
 - status, **87, 180**
 - status values, **179**
 - stop a trace, **185**
 - storage qualification, **180**
 - timing information, **252, 391**
 - trace code execution before and after entry into a function, **192**
 - trace counts, **252**
 - trace data written to variable, **193**
 - trace events, **179**
 - trace modules, **197–198**
 - trace trigger, **179**
 - trace write to a variable, **195**
 - trace writer of data, **194**
 - triggers, **190, 654**
 - what it does, **178**
 - Trace Start command, **472**
 - Trace StoreQual command, **490–493**
 - Trace StoreQual Event command, **494–495**
 - Trace StoreQual List command, **496**
 - Trace StoreQual None command, **497**
 - Trace Trigger command, **498–501**
 - and breakpoints, **357**
 - Trace Trigger Event command, **502–504**
 - Trace Trigger List command, **505**
 - Trace Trigger Never command, **506**
 - tracing background operation, **313**
 - tram, memory characterization, **294**
 - Translation Control Register @ TC, **552**
 - trigger
 - See* trace measurement, triggers
 - trom, memory characterization, **294**
 - type casting, **539**
 - type conversion, **539**
- U**
- Unknown (debugger status), **86**
 - unknown module in backtrace window, **151**
 - until macro, **586**
 - uP Idle (debugger status), **86**

user interfaces, **560**
user program symbols
 simulated I/O, **169**
 systemio_buf, **169**
user stack pointer @USP, **552**
user-defined macros
 See macros
user-defined screens
 defining, **256**
 displaying, **257**
 removing, **258**
user-defined windows
 defining, **256**
 erasing information in, **258**
 removing, **258**

V variables
 breaking on access, **30**
 displaying, **26**
 displaying address of, **29, 47**
 displaying in their declared type, **47**
 initializing, **209**
 macros, **215**
 modifying, **50, 202**
vector base address @VBR, **552**
version
 displaying, **148**
 emulator/analyzer, **617**
view information in the active window, **139–140**
view window, description of, **148**
viewing text, **16**
VT100 terminal
 configuration selections for SET-UP A menu, **639**
 configuration selections for SET-UP B menu, **639**
 configuring, **639**
 set control sequences for, **645**
VT220 terminal
 configuring, **641**
 set control sequences for, **645**

- W** W indicator character, **87**
- when macro, **587**
 - example, **357, 362–364**
- while statement, **216**
- widget resource
 - See* X resource
- Window Active command, **507–508**
- Window Cursor command, **509**
- Window Delete command, **510**
- Window Erase command, **511**
- Window New command, **512–514**
- Window Resize command, **515**
- Window Screen_On command, **516**
- Window Toggle_View command, **517–518**
- windows, **135**
 - active, **137**
 - backtrace, **114, 150–152**
 - breakpoint, **111**
 - commands, summary of, **355**
 - copying to file, **141**
 - definition, **654**
 - description of, **135**
 - displaying alternate view, **138**
 - error, **592**
 - help, **83**
 - journal, **58**
 - journal file, **162**
 - log file, **162**
 - making active, **137**
 - monitor, **159**
 - moving, **254**
 - predefined, **135**
 - register, **148**
 - resizing, **254**
 - resizing large, **647**
 - scrolling, **16**
 - setting behavior of, **249**
 - settings, saving, **260**
 - stack, **136**
 - view, **148**



windows (continued)
 working with, **135**
 X, 654
 See also X windows
word macro, **588**
words
 changing, **206**
Working (debugger status), **86**
working directory, **654**
workstation
 HP 9000 memory needs, **618**
 HP 9000 minimum performance, **618**
 SPARCsystem memory needs, **622**
 SPARCsystem minimum performance, **622**
write macro, **589–590**
write to ROM break, **308**

X X client, **263, 332**
X resource, **263, 331–342**
 \$XAPPLRESDIR directory, **337**
 \$XENVIRONMENT variable, **337**
 .Xdefaults file, **336**
 /usr/hp64000/lib/X11/HP64_schemes, **339**
 app-defaults file, **336**
 application-specific, **332**
 class name for applications defined, **335**
 class name for widgets defined, **333**
 command line options, **337**
 commonly modified graphical interface resources, **265**
 Debug.BW, **339**
 Debug.Color, **339**
 Debug.Input, **339**
 Debug.Label, **339**
 Debug.Large, **339**
 Debug.Small, **339**
 defined, **332**
 definition, **654**
 general form, **333**
 instance name for applications defined, **335**
 instance name for widgets defined, **333**
 loading order, **337**

- X resource (continued)
 - modifying resources, generally, **265, 342**
 - RESOURCE_MANAGER property, **337**
 - scheme file system directory, **339**
 - scheme files, debugger's graphical interface, **338**
 - scheme files, named, **338**
 - schemes, forcing interface to use certain, **340**
 - wildcard character, **334**
 - xrdb, **337**
 - xrm command line option, **337**
- X resources
 - introduction, **263**
- X server, **263, 332, 654**
- X windows
 - definition, **654**
 - resizing large, **646**
 - running on bit-mapped displays, **635**
- Z** zero flag @Z, **552**



Index



Certification and Warranty

Certification

Hewlett-Packard Company certifies that this product met its published specifications at the time of shipment from the factory. Hewlett-Packard further certifies that its calibration measurements are traceable to the United States National Bureau of Standards, to the extent allowed by the Bureau's calibration facility, and to the calibration facilities of other International Standards Organization members.

Warranty

This Hewlett-Packard system product is warranted against defects in materials and workmanship for a period of 90 days from date of installation. During the warranty period, HP will, at its option, either repair or replace products which prove to be defective.

Warranty service of this product will be performed at Buyer's facility at no charge within HP service travel areas. Outside HP service travel areas, warranty service will be performed at Buyer's facility only upon HP's prior agreement and Buyer shall pay HP's round trip travel expenses. In all other cases, products must be returned to a service facility designated by HP.

For products returned to HP for warranty service, Buyer shall prepay shipping charges to HP and HP shall pay shipping charges to return the product to Buyer. However, Buyer shall pay all shipping charges, duties, and taxes for products returned to HP from another country. HP warrants that its software and firmware designated by HP for use with an instrument will execute its programming instructions when properly installed on that instrument. HP does not warrant that the operation of the instrument, or software, or firmware will be uninterrupted or error free.

Limitation of Warranty

The foregoing warranty shall not apply to defects resulting from improper or inadequate maintenance by Buyer, Buyer-supplied software or interfacing, unauthorized modification or misuse, operation outside of the environment specifications for the product, or improper site preparation or maintenance.

No other warranty is expressed or implied. HP specifically disclaims the implied warranties of merchantability and fitness for a particular purpose.

Exclusive Remedies

The remedies provided herein are buyer's sole and exclusive remedies. HP shall not be liable for any direct, indirect, special, incidental, or consequential damages, whether based on contract, tort, or any other legal theory.

Product maintenance agreements and other customer assistance agreements are available for Hewlett-Packard products.

For any assistance, contact your nearest Hewlett-Packard Sales and Service Office.